



This is a digital copy of a book that was preserved for generations on library shelves before it was carefully scanned by Google as part of a project to make the world's books discoverable online.

It has survived long enough for the copyright to expire and the book to enter the public domain. A public domain book is one that was never subject to copyright or whose legal copyright term has expired. Whether a book is in the public domain may vary country to country. Public domain books are our gateways to the past, representing a wealth of history, culture and knowledge that's often difficult to discover.

Marks, notations and other marginalia present in the original volume will appear in this file - a reminder of this book's long journey from the publisher to a library and finally to you.

Usage guidelines

Google is proud to partner with libraries to digitize public domain materials and make them widely accessible. Public domain books belong to the public and we are merely their custodians. Nevertheless, this work is expensive, so in order to keep providing this resource, we have taken steps to prevent abuse by commercial parties, including placing technical restrictions on automated querying.

We also ask that you:

- + *Make non-commercial use of the files* We designed Google Book Search for use by individuals, and we request that you use these files for personal, non-commercial purposes.
- + *Refrain from automated querying* Do not send automated queries of any sort to Google's system: If you are conducting research on machine translation, optical character recognition or other areas where access to a large amount of text is helpful, please contact us. We encourage the use of public domain materials for these purposes and may be able to help.
- + *Maintain attribution* The Google "watermark" you see on each file is essential for informing people about this project and helping them find additional materials through Google Book Search. Please do not remove it.
- + *Keep it legal* Whatever your use, remember that you are responsible for ensuring that what you are doing is legal. Do not assume that just because we believe a book is in the public domain for users in the United States, that the work is also in the public domain for users in other countries. Whether a book is still in copyright varies from country to country, and we can't offer guidance on whether any specific use of any specific book is allowed. Please do not assume that a book's appearance in Google Book Search means it can be used in any manner anywhere in the world. Copyright infringement liability can be quite severe.

About Google Book Search

Google's mission is to organize the world's information and to make it universally accessible and useful. Google Book Search helps readers discover the world's books while helping authors and publishers reach new audiences. You can search through the full text of this book on the web at <http://books.google.com/>

NYPL RESEARCH LIBRARIES



3 3433 06642755 4









ALTERNATING CURRENT MOTORS.

BY

A. S. McALLISTER, PH.D.

NEW YORK
McGRAW PUBLISHING COMPANY

1906 c. 6*

THE NEW YORK
PUBLIC LIBRARY
377584
ASTOR, LENOX AND
TILDEN FOUNDATIONS
R 1907 L

Copyrighted 1906
by the
McGraw Publishing Company
New York

NEW YORK
PUBLIC
LIBRARY

PREFACE.

In the preparation of the explanatory matter contained in the present volume, the writer has had constantly in mind the difficulties which he encountered in endeavoring to ascertain the causes for the various effects which were described in the available electrical literature in connection with the operation of the several types of alternating-current motors. An experience of several years in instructing engineering students in alternating-current phenomena has served to convince the writer that the above mentioned difficulties are due primarily to the methods employed in presenting the facts to minds unfamiliar therewith. It is believed that a large part of the difficulty may be attributed to an inconsistent use of technical terms, such as the word "field," meaning at one time magnetism, at another iron, and yet at another copper. Many writers use the term "power" without discrimination for quantities measurable in watts or in watt-hours. It is surprising how frequently even well-informed writers use the term "current" when "e.m.f." is intended. One often sees the statement "a current is induced," when, as a matter of fact, the circuit in which the current is supposed to flow is entirely open. Much of the difficulty is due to the excessive use of mathematical questions as an end rather than a means. It is believed that mathematics should be employed merely as a short-hand method of stating facts. Beyond any doubt much confusion is created in the mind of an engineering student when an attempt is made to express certain *assumed* relations in the form of mathematical equations, and then to transform the equations to obtain a result which he is asked to believe expresses physical *facts*, merely because the equations, considered mathematically, have been properly transformed.

In view of the facts stated above, and on account of the belief that, for the purpose of imparting information, simplicity is the criterion of worth, an attempt has been made to deal directly with the electromagnetic phenomena of alternating-current motors in the simplest possible manner, in so far as such method is consistent with accuracy. Wherever mathematical

equations are employed, the assumption upon which they are based are definitely stated, and the inaccuracies in the assumptions and limitations in the equations are carefully noted, while the results obtained from the transformed equations are interpreted with due regard to the inaccuracies and the limitations. Moreover, the significance of each transformation is carefully explained, so that the reader may be constantly reminded of the fact that he is dealing directly with electromagnetic phenomena and only indirectly with mathematics.

It has been assumed that the reader is familiar with the fundamental facts of electricity and magnetism, and that he has some knowledge of the lower branches of mathematics. No attempt has been made to explain the manner in which alternating electromotive forces and currents may be represented in value and time-phase position by straight lines, because a knowledge of such representation can be presupposed. Much attention is given to graphical diagrams and to examination of the facts upon which they are based. Where necessary the errors involved in the assumptions are pointed out, and the magnitude of their effect on the final results are discussed. In developing the graphical diagram of the induction motor, the proof that the current locus is (approximately) a circle has been based on the relation between the equivalent electric circuits considered as certain interconnected resistances and reactances, rather than on the resolution of the magnetic flux into certain components. The latter method is the one most commonly employed. It is believed, however, that the former method possesses peculiar advantages in permitting the reader to follow the development step by step without losing sight of the involved electromagnetic relations, and in allowing the inaccuracies in the assumptions to be definitely determined.

The major portion of the volume has appeared as articles in various publications, notably the *Electrical World*, the *American Electrician* and the *Sibley Journal of Engineering*. The writer's thanks are due to the editors of these publications for permission to incorporate the articles in this book. The writer wishes to take this opportunity to express his appreciation of the encouragement continuously received from his friend and former colleague, Dr. Frederick Bedell.

CONTENTS.

CHAPTER I.

SINGLE-PHASE AND POLYPHASE CIRCUITS.....	1
Economy of Conducting Material.....	1
Three-Phase Power Measurements.....	3
Measuring Three-Phase Power with One Wattmeter.....	6
Wattmeters on Unbalanced Loads.....	9
Equivalent Single-Phase Currents.....	13
Equivalent Single-Phase Resistance.....	14

CHAPTER II.

OUTLINE OF INDUCTION MOTOR PHENOMENA.....	16
Methods of Treatment.....	16
Production of Revolving Field.....	17
Simple Analytical Equations.....	19
Starting Devices for Induction Motor.....	22
Concatenation Control.....	23

CHAPTER III.

OBSERVED PERFORMANCE OF INDUCTION MOTOR.....	25
Test with One Voltmeter and One Wattmeter.....	25
Measurement of Slip.....	26
Determination of Torque.....	27
Measurement of Secondary Resistance.....	28
Determination of Secondary Current.....	28
Calculation of Primary Power Factor.....	29
Calculation of Primary Current.....	30

CHAPTER IV.

INDUCTION MOTORS AS FREQUENCY CONVERTERS.....	31
Field of Application.....	31
Characteristic Performance.....	32
Capacity of Frequency Converters.....	33

CONTENTS.

CHAPTER V.

THE HEYLAND INDUCTION MOTOR.	35
Excitation of Induction Motors.....	35
Secondary Exciting Magnetomotive Force.....	37
Direct Current in Secondary Coils.....	38
Alternating Current in Secondary Coils.....	39
Action with Stationary Rotor.....	41
Action with Rotor at Synchronous Speed.....	43
Function of the Connecting Resistances.....	44
Double Three-Phase Secondary Winding.....	46

CHAPTER VI.

THE SINGLE-PHASE INDUCTION MOTOR.	48
Outline of Characteristic Features.....	48
Production of Quadrature Magnetism.....	49
Production of Revolving Field.....	51
Elliptical Revolving Field.....	52
Starting Torque of the Single-Phase Motor.....	53
Use of "Shading Coils".....	54
Use of Commutator on the Rotor.....	56
Polyphase Induction Motors Used as Single-Phase Machines....	58

CHAPTER VII.

GRAPHICAL TREATMENT OF INDUCTION MOTOR PHENOMENA.	63
Advantage of Graphical Methods.....	63
Effect of Inserting Resistance in the Secondary.....	63
Primary and Secondary Current Locus.....	65
Test Results.....	66
Equation of the Current Locus.....	70
Errors in Assuming a Circular Arc.....	71
Effect of Design on Leakage Reactance.....	73

CHAPTER VIII.

INDUCTION MOTORS AS ASYNCHRONOUS GENERATORS.	74
Operation Below Synchronism.....	74
Operation Above Synchronism.....	75
Vector Diagram of Currents.....	75
Performance Characteristics.....	79
Parallel Operation of Asynchronous Generators.....	80
Excitation of Asynchronous Generators.....	81
Condensance as a Source of Exciting Current.....	83
Condensers in Alternating Current Circuits.....	84
Excitation Characteristics of Asynchronous Generators.....	86
Load Characteristics of Asynchronous Generators.....	90
Commutator Excitation of Asynchronous Generators.....	92

CHAPTER IX.

TRANSFORMER FEATURES OF THE INDUCTION MOTOR.....	95
Electric and Magnetic Circuits.....	95
Equivalent Electric Circuits.....	98
Modified Electric Circuits.....	99
Circle Diagram of Currents.....	100
Internal Voltage Diagrams of the Induction Motor.....	105
Corrected Current Locus of the Induction Motor.....	107
Complete Performance Diagram of the Polyphase Induction Motor.....	109
Comparison of Single-Phase and Polyphase Motors.....	112
Electric Circuits of the Single-Phase Induction Motor.....	114
Complete Performance Diagram of the Single-Phase Induction Motor.....	115
Speed and Torque of the Single-Phase Induction Motor.....	117
Capacities of Single-Phase and Polyphase Motors.....	119

CHAPTER X.

MAGNETIC FIELD IN INDUCTION MOTORS	121
Polyphase Motors.....	121
Magnetic Distribution with Open Secondary.....	124
Magnetic Distribution with Closed Secondary.....	127
Determination of Core Flux.....	130
Effect on Core Flux of Using Distributed Winding.....	131
Effect on Capacity of Varying the Grouping of Coils.....	133
Exciting Watts in Induction Motors.....	135
Magnetic Field in the Single-Phase Induction Motor.....	138
Production of Speed-Field Current.....	139
Transformer Features of the Single-Phase Induction Motor....	142
Secondary Currents in the Single-Phase Motor.....	143
Graphical Representation of Secondary Quantities.....	146

CHAPTER XI.

SYNCHRONOUS MOTORS AND CONVERTERS.....	149
Synchronous Commutating Machines.....	149
Synchronous Motors and Generators.....	151
Synchronous Converters, Unity Power-Factor.....	154
Distribution of Heat Loss in Armature Coils.....	159
Synchronous Converters, Fractional Power-Factor.....	160
Double Current Machines.....	161
Relative Capacities of Synchronous Machines of Various Phases.	163
Characteristic Performance of Synchronous Converters.....	165
Excitation of Synchronous Machines.....	166
Hunting of Synchronous Machines.....	167
Starting of Synchronous Converters.....	168

Compounding of Synchronous Converters.....	169
Inverted Converters.....	170
Predetermination of Performance of Synchronous Converters..	171
Six-Phase Converters.....	174
Six-Phase Transformation.....	175
Relative Advantages of Delta and Star-Connected Primaries..	180

CHAPTER XII.

ELECTROMAGNETIC TORQUE.....	181
Commutator Motors.....	181
Equality of Torques for Uniform Reluctance.....	181
Inequality of Torques for Non-Uniform Reluctance.....	183
Determination of Torque by Calculation of the Output.....	184
Measurement of Torque by the Loading-Back Method.....	185
Elimination of Errors.....	187

CHAPTER XIII.

SIMPLIFIED TREATMENT OF SINGLE-PHASE COMMUTATOR MOTORS...	189
The Repulsion Motor.....	184 ¹⁸⁹
Electric and Magnetic Circuits of Ideal Motor.....	190
Production of Rotor Torque.....	192
Graphical Diagram of Repulsion Motor.....	193
Calculated Performance of Ideal Repulsion Motor.....	196

CHAPTER XIV.

MOTORS OF THE REPULSION TYPE TREATED BOTH GRAPHICALLY AND ALGEBRAICALLY.....	199
Electromotive Forces Produced in an Alternating Field.....	199
The Simple Repulsion Motor.....	201
Effect of Speed on the Stator Electromotive Forces.....	203
Fundamental Equations of the Repulsion Motor.....	204
Vector Diagram of Ideal Repulsion Motor.....	206
Corrections for Resistance and Local Leakage Reactance.....	209
Brush Short-Circuiting Effect.....	212
Observed Performance of Repulsion Motor.....	213
Compensated Repulsion Motor.....	214
Apparent Impedance of Motor Circuits.....	217
Fundamental Equations of the Compensated Repulsion Motor..	218
Vector Diagram of Compensated Repulsion Motor.....	221
Calculated Performance of Compensated Repulsion Motor....	223
Observed Performance of Compensated Repulsion Motor.....	225
Corrections for Resistance and Local Leakage Reactance.....	227
Brush Short-Circuiting Effect.....	228

CHAPTER XV.

MOTORS OF THE SERIES TYPE TREATED BOTH GRAPHICALLY AND ALGEBRAICALLY.....	232
The Plain Series Motor.....	232
Fundamental Equations of Series Motor with Uniform Air-Gap Reluctance.....	233
Fundamental Equations for Motor with Non-Uniform Reluctance	237
Inductively Compensated Series Motor.....	241
Conductively Compensated Series Motor.....	242
Complete Performance Equations of Compensated Motors.	243
Vector Diagram of Compensated Series Motor.....	244
Induction Series Motor.....	245
Fundamental Equations of Induction Series Motors.....	247
Corrections for Resistance and Local Leakage Reactance.....	252
Vector Diagram of Induction Series Motor.....	253
Generator Action of Induction Series Motor.....	254
Brush Short-Circuiting Effect.....	255
Hysteretic Angle of Time-Phase Displacement.....	257
Power Factor of Commutator Motors.....	260
Resistance in Shunt with Field Winding.....	260
Loss Due to Use of Shunted Resistance.....	263

CHAPTER XVI.

PREVENTION OF SPARKING IN SINGLE-PHASE COMMUTATOR MOTORS..	266
Transformer Action with Stationary Rotor.....	266
Interlaced Armature Windings.....	267
Use of Series Resistance.....	267
Power Lost in Resistance Leads.....	268
Internal Resistance Leads.....	269
External Resistance Leads with Two Commutators.....	269
External Resistance Leads with One Commutator.....	270



CHAPTER I.

SINGLE-PHASE AND POLYPHASE CIRCUITS.

ECONOMY OF CONDUCTING MATERIAL.

Although of all possible transmission systems the single-phase requires the least number of conductors and, on the basis of equality of maximum e.m.f. to the neutral point, the single-phase is the equal with reference to the cost of conductors of any polyphase system, practically all of the long-distance transmission circuits are of the polyphase type, chiefly because of the facts that polyphase generators are less expensive in construction and more economical in operation than single-phase machines, and, for the purpose of power distribution, polyphase motors and synchronous converters are superior to single-phase machines. Of all polyphase circuits operated with a given maximum measurable e.m.f. between lines, the three-phase system is the most economical with reference to the cost of conducting material; which accounts for the fact that, with very few exceptions, all transmission circuits are of the three-phase type.

That all symmetrical transmission systems show the same economy of conducting material, irrespective of the number of phases, when compared on the basis of equality of maximum e.m.f. to the neutral point, can be proved as follows: Let P = the number of phases (and conducting wires); R = the resistance of the total mass of conducting material, all wires being considered in parallel; E = the e.m.f. to the neutral point, and W = the power transmitted. Then $P R$ = resistance per wire; $\frac{W}{P}$ = power per phase, and $\frac{W}{P E}$ = current per wire. Representing the current per wire by I , the loss in transmission is,

$$P I^2 P R = \left(\frac{W}{P E}\right)^2 P^2 R = \frac{W^2}{E^2} R.$$

which is obviously independent of the number of phases.

For all systems in which the measurable maximum e.m.f. is twice the e.m.f. from a single conductor to the neutral point, the cost of conducting material for transmitting at a given loss is the same. In this class fall the two-wire (single-phase), four-wire (two-phase), six-wire (six-phase), and other systems in which the number of phases is an even one. An inspection of Fig. 1 will show that in the three-phase system the measurable e.m.f. is only

$$2E \cos \frac{1}{2} \left(\frac{180}{P} \right) = \sqrt{3} \times E,$$

or 1.732 times that from one conductor to the neutral point. On the basis of equality of measurable e.m.f., therefore, the three-phase system requires $\left(\frac{\sqrt{3}}{2} \right)^2 = \frac{3}{4}$ as much conducting

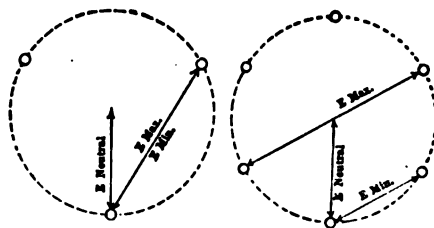

FIG. 1.—E.m.f.'s of Three-phase Circuits. FIG. 2.—E.m.f.'s of Six-phase Circuits.

material as any system in which the number of phases, P , is even, since the conducting material varies inversely as the square of the e.m.f. for any given system. The calculations recorded in Table I show that a higher conductor efficacy is obtained in each case when P is odd than when it is even, and that the smaller the value of P the higher the efficacy will be. Since P , when odd, cannot be less than three, the three-phase is of all systems the most economical.

While as regards the desirability of obtaining economy in cost of conducting material, the problem of determining the proper circuits for the distribution of electrical energy at the end of a transmission line is quite similar to that connected with the transmission circuits, factors other than economy enter into this portion of the problem, which must be carefully considered before any attempt is made at a definite solution.

TABLE I.—Relative conducting material required for different transmission systems

Number of phases (wires)	On basis of minimum e.m.f.		On basis of max- imum measurable e.m.f.		
	E_{min}	Conducting material	E_{max}	E_{max}	Conducting material
P	$2 E_{min} \left(\frac{180}{N}\right)$	$\left(\frac{E_{min}}{2}\right)^2$	$2 E$	$2 E \cos \frac{180}{P}$	$\left(\frac{E_{max}}{2}\right)^2$
2	2.0000	1.000	2.0000	1.000
3	1.7320	.750	1.7320	.750
4	1.4142	.500	2.0000	1.000
5	1.1756	.346	1.9022	.905
6	1.0000	.250	2.0000	1.000
7	.8678	.188	1.9500	.950
8	.7654	.146	2.0000	1.000
9	.6840	.117	1.9696	.969

THREE-PHASE POWER MEASUREMENTS.

In measuring the power in a three-phase circuit the most convenient method is one involving the use of two wattmeters whose current coils are placed in any two of the three-phase leads, and whose pressure coils are connected, respectively, between these two leads and the third lead. A simple semi-graphical proof of the correctness of the two-wattmeter method of measuring the power in a three-phase circuit under any condition of service is given below.

In Fig. 3, let the sides of the triangle ABC represent the relative values and phase positions of the three e.m.fs. of an unsymmetrical three-phase system. Assume the receiver to be delta connected, and let I_{AB} be the current in coil AB , and θ_{AB} be the angle of lag of this current with respect to the e.m.f. of the coil. Similarly, let I_{BC} and I_{AC} represent the value and phase position of the currents in coils BC and AC . No restriction is made as to the values of currents, e.m.fs. or as to the several lag angles.

Let a wattmeter be connected with its current coil in lead at *A*, and its e.m.f. coil across between this lead and lead *C*. Also a wattmeter at *B*, with pressure coil between *B* and *C*. Each

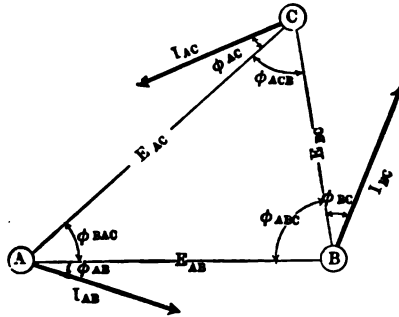

FIG. 3.—Phase Relation of e.m.f.'s and currents.

wattmeter will show a deflection, which may be represented by $W = E I \cos \theta$, where I is the amperes in the current coil, E is the volts across the e.m.f. coil, and θ is the angle between this e.m.f. and the current I .

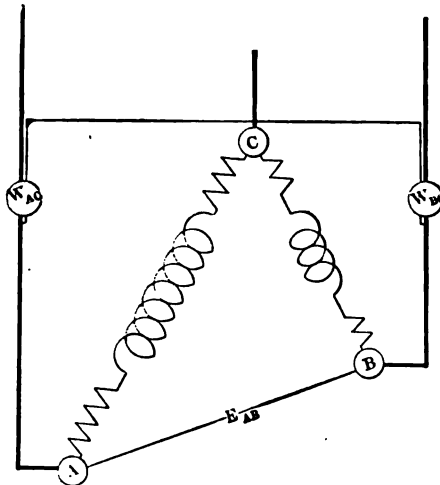

FIG. 4.—Measurement of power in coils *A C* and *C B*.

For sake of simplicity in explanation, assume, in the first place, the current flowing in coil *A B* to be absent while measurements are made upon the watts supplied to the other coils, as indicated by Fig. 4. Evidently the sum of the readings of the

meters as connected gives the watts in the two remaining coils, since each meter is connected as though measuring power in a single-phase circuit. Now assume, in the second place, the current to flow in coil $A B$ alone while the currents in the other two coils are absent, as shown by Fig. 5. According to proof given below, the wattmeters as connected now register as their sum the true watts supplied to coil $A B$. When all three currents flow simultaneously, each wattmeter will show a deflection equal to the sum of its two previous readings, since its e.m.f. coil has undergone no change in connection and the two currents causing the former deflections are now superposed, and the true power transferred will be properly recorded by the two meters.

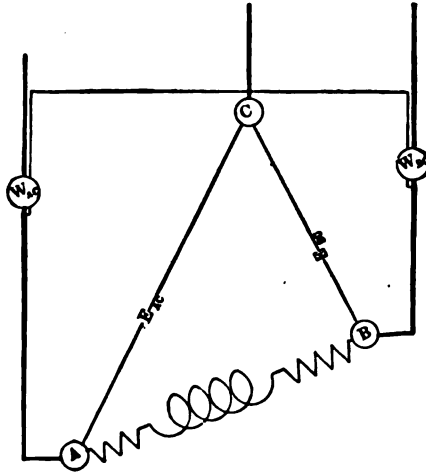

FIG. 5.—Measuring power in coil $A B$.

Two wattmeters having their current coils in series with a given single-phase load, and one terminal of the e.m.f. coil of each meter connected to the opposite leads of the circuit supplying power to the load and the other two free terminals connected together and placed at any point of any relative potential compared with that of the load, as depicted in Fig. 5, will give the true value of power transmitted.

In Fig. 6, let E_{AB} be the e.m.f. across the load, I_{AB} be the load current and θ_{AB} be the angle between I_{AB} and E_{AB} . Evidently the watts transmitted are

$$W_{AB} = E_{AB} I_{AB} \cos \theta_{AB}.$$

Now assume a wattmeter connected at A to C . Its reading will be

$$W_{AC} = E_{AC} I_{AB} \cos \theta_{AC}.$$

A wattmeter at B to C will read

$$W_{BC} = E_{BC} I_{AB} \cos \theta_{BC}.$$

From Fig. 6,

$$E_{AB} \cos \theta_{AB} = A F.$$

$$E_{AC} \cos \theta_{AC} = A E.$$

$$E_{BC} \cos \theta_{BC} = B D = E F.$$

and since $A F = A E + E F$,

$$I_{AB} (E_{AC} \cos \theta_{AC} + E_{BC} \cos \theta_{BC}) = I_{AB} E_{AB} \cos \theta_{AB}$$

or $W_{AC} + W_{BC} = W_{AB}$

and this value is independent of the position of the point C .

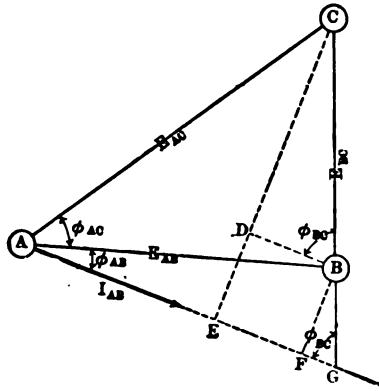

FIG. 6.—Graphical proof of Fig. 5.

In consequence of this fact, $P - 1$ wattmeters may be used to determine the true power in any P -phase system, however unsymmetrical may be the phase relations, provided the free terminals of the e.m.f. coil of each meter be connected to that lead in which no wattmeter is placed.

MEASURING THREE-PHASE POWER WITH ONE WATTMETER.

A single wattmeter method which may be used for determining the angle of lag in balanced three-phase circuits is outlined below. It is believed that this method is not as generally well known as its simplicity and comparative freedom from errors justify.

If a wattmeter, connected as indicated by the diagram of

Fig. 7, with its current coil in one lead of a three-phase circuit, be read with its e.m.f. coil across between this lead and first one and then the other of the remaining two leads, the two values thus obtained may be used to determine the angle of lag of the current by means of the following relation:

$$\tan \phi = \sqrt{3} \frac{W_1 - W_2}{W_1 + W_2}$$

where ϕ is the angle of lag, and W_1, W_2 are two readings of the wattmeter, as indicated above.

When ϕ is greater than 60 degs. one reading will be negative so that the difference of readings will be greater than their sum.

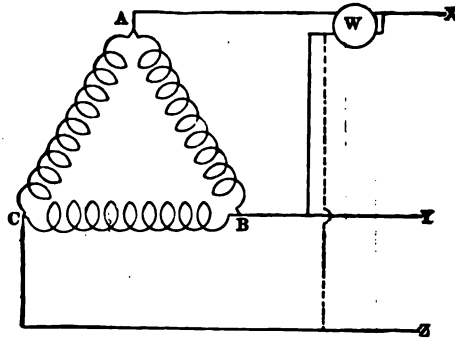

FIG. 7.—Measuring three-phase power with one wattmeter.

The proof of this relation is as follows:

Let I = current in lead $A X$,
 E = e.m.f. of $A B$ and of $A C$,

then

$$W_1 = I E \cos (\phi - 30)$$

$$W_2 = I E \cos (\phi + 30)$$

and since

$$\begin{aligned} \cos (a \pm \beta) &= \cos a \cos \beta \mp \sin a \sin \beta \\ W_1 - W_2 &= I E [\cos (\phi - 30) - \cos (\phi + 30)] \\ &= 2 I E \sin 30 \sin \phi = I E \sin \phi \end{aligned}$$

and

$$\begin{aligned} W_1 + W_2 &= I E [\cos (\phi - 30) + \cos (\phi + 30)] \\ &= 2 I E \cos 30 \cos \phi = \sqrt{3} I E \cos \phi \end{aligned}$$

hence

$$\frac{W_1 - W_2}{W_1 + W_2} = \frac{1}{\sqrt{3}} \tan \phi, \text{ as above.}$$

If the e.m.f. of AB be not equal to the e.m.f. of AC , the reading of the wattmeter in either position may be corrected to such a value as would have been obtained had the two voltages been equal, in which case the above relation will hold true.

Since any proportional error in the calibration scale of the wattmeter affects equally both the sum and the difference of the readings, and hence does not alter the ratio of the two, it follows that a wattmeter having a proportional scale error of

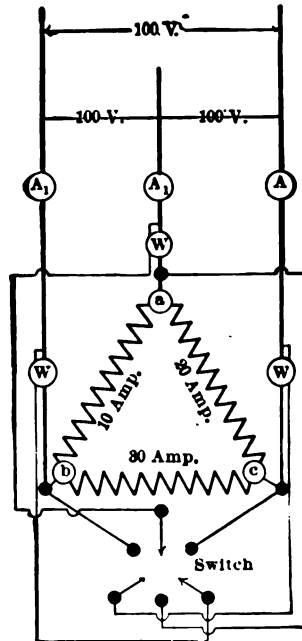

FIG. 8.—Testing Circuits.

any value whatever may be used to obtain the correct value of lag angle, and that any instrument of the dynamometer type, whether calibrated or not, may be used in place of the wattmeter.

The lag angle thus obtained is the true angle between the current in lead $A X$ and the mean voltage between $A B$ and $A C$.

If the circuits are symmetrically loaded the sum of two correct wattmeter readings will equal the real power, while from the difference of the two readings may be obtained the "quadrature" watts.

WATTMETERS ON UNBALANCED LOADS.

It is to be noted especially that the above method must be used with care, because an unbalance of load may lead to incorrect interpretation of the results. An exaggerated case of unbalance, selected so as to emphasize the facts just stated, is shown below. In order that all disturbing influences, other than the unbalance of the load alone, may be eliminated from the problem, there has been assumed a non-inductive load supplied from a three-phase circuit having equal e.m.fs. between the leads.

Fig. 8 represents the circuits and load, and shows the con-

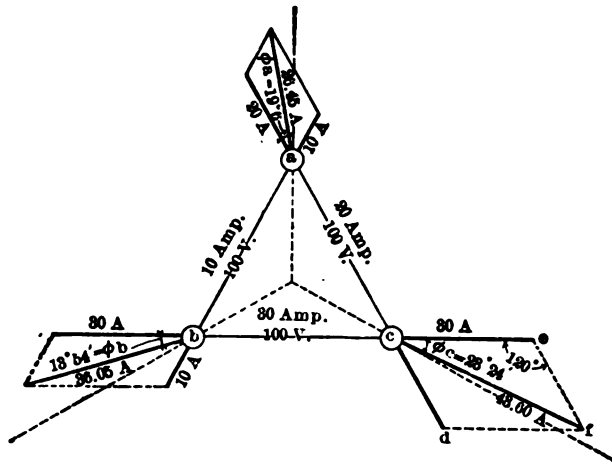

FIG. 9.—Vector Diagram of Currents and Electromotive Forces.

nection of instruments for determining the power factor. As seen, an e.m.f. of 100 volts between leads and a delta-connected non-inductive load of 10, 20 and 30 amperes, respectively, per phase have been chosen. The true power is evidently 6,000 watts, while the power factor per phase is unity.

Referring to Fig. 9, which represents the value and position of the current per phase of the load indicated by Fig. 8, the value of current registered upon an ammeter at *C* and its relative phase position may be ascertained by making use of the geometrical figure *c d f e*. From the construction it is seen that the current at *c* is represented in value and phase by the line *c f*.

In the triangle $c e f$, the side $c f$ is equal to

$$(\overline{c e^2 + e f^2 + 2 \overline{c e} \cdot \overline{e f} \cos 120^\circ})^{\frac{1}{2}}$$

or is equal to

$$(\overline{c e^2 + c e \overline{e f} + e f^2})^{\frac{1}{2}} = \sqrt{1900} = 43.60 \text{ and}$$

$$\sin \phi_c = \sin 120^\circ \frac{\overline{e b}}{c f} = .866 \frac{20.00}{43.60} = .3971$$

$$\phi_c = 23^\circ 24'.$$

Similarly the current at a is

$$(10^2 + 10 \times 20 + \overline{20^2})^{\frac{1}{2}} = \sqrt{700} = 26.45, \text{ and}$$

$$\sin \phi_a = .866 \frac{10.00}{26.45} = .3272$$

$$\phi_b = 19^\circ 6'.$$

Current at b is

$$(10^2 + 10 \times 30 + \overline{30^2})^{\frac{1}{2}} = \sqrt{1300} = 36.05 \text{ and}$$

$$\sin \phi_b = .866 \frac{10.00}{36.05} = .2402$$

$$\phi_b = 13^\circ 54'.$$

It is convenient to adopt some method of designating at once each wattmeter and its connection in the circuit. Place, therefore, as subscript to the letter W , which is to represent the reading of each meter, the letters showing the points between which the voltage coil is connected, and place first that letter corresponding to the lead in which is the current coil of the wattmeter. Thus, $W a b$ refers to wattmeter having its current coil in lead a and its voltage coil connected across between this lead and lead b .

Wattmeter $W a c$ will record $I a E a c \cos \phi a c$, or

$$W a c = 26.45 \times 100 \times \cos 19^\circ 6' = 2,500.$$

$$W a b = 26.45 \times 100 \times \cos 40^\circ 54' = 2,000.$$

$$W b e = 36.05 \times 100 \times \cos 13^\circ 54' = 3,500.$$

$$W b a = 36.05 \times 100 \times \cos 46^\circ 06' = 2,500.$$

$$W c b = 43.60 \times 100 \times \cos 33^\circ 24' = 4,000.$$

$$W c a = 43.60 \times 100 \times \cos 36^\circ 36' = 3,500.$$

It is seen at once that the true value of watts is recorded in each case by the sum of the readings of any two wattmeters

with their current coils in separate leads and their free pressure terminals connected to the third lead, thus $(W_{ac} + W_{bc}) = (W_{ab} + W_{cb}) = (W_{ba} + W_{ca}) = 6,000$, but that the true watts may not be indicated by one wattmeter which has its pressure coil free terminal transferred from first one and then the other remaining lead, thus $(W_{ac} + W_{ab}) = 4,500$, $(W_{bc} + W_{ba}) = 6,000$, $(W_{cb} + W_{ca}) = 7,500$.

It was shown above that the angle of lag and the power factor may be determined by the ratio of the readings of two wattmeters. That such a method does not give accurate results with unbalanced loads was mentioned also. For purpose of comparison, however, results determined by this method are here recorded. Letting θ represent the general angle of lag,

$$\tan \theta = \sqrt{3} \frac{W_{bc} - W_{ac}}{W_{bc} + W_{ac}} = \sqrt{3} \frac{1000}{6000} = .2886$$

$$\theta = 16^\circ 6'$$

$$\cos \theta = .961$$

$$\tan \theta = \sqrt{3} \frac{W_{cb} - W_{ab}}{W_{cb} + W_{ab}} = \sqrt{3} \frac{2000}{6000} = .5772$$

$$\theta = 30^\circ 0'$$

$$\cos \theta = .866$$

$$\tan \theta = \sqrt{3} \frac{W_{ca} - W_{ba}}{W_{ca} + W_{ba}} = \sqrt{3} \frac{1000}{6000} = .2886$$

$$\theta = 16^\circ 6'$$

$$\cos \theta = .961$$

Since the load has been so selected as to be strictly non-inductive, it is evident that the lag angle indicated does not exist, and that the power factor obtained by this method is in error.

It is to be noted in this connection, however, that the angle of lag obtained by the same formula used above, but substituting the ratio of readings of one wattmeter when its pressure coil is transferred between the two leads, as mentioned above, has, in fact, a physical significance, as here shown:

$$\tan \theta_a = \sqrt{3} \frac{W_{ac} - W_{ab}}{W_{ac} + W_{ab}} = \sqrt{3} \frac{500}{4500} = .1925$$

$$\theta_a = 10^\circ 45'$$

As inspection of Fig. 2 will reveal the fact that this is the angle between the current i_1 and the mean voltage between c_1 and c_2 since $10^\circ - 30^\circ = 10^\circ - 40^\circ$. Similarly

$$\cos \theta = \cos \left(\frac{V_1 r_1 - V_2 r_2}{V_1 r_1 + V_2 r_2} \right) = \cos \left(\frac{1000}{6000} \right) = \frac{5000}{6000}$$

$$\theta = 10^\circ - 40^\circ = 30^\circ - 10^\circ = 20^\circ$$

and again

$$\cos \theta = \cos \left(\frac{V_1 r_1 - V_2 r_2}{V_1 r_1 + V_2 r_2} \right) = \cos \left(\frac{5000}{7500} \right) = \frac{5000}{7500}$$

$$\theta = (10^\circ - 30^\circ) = 30^\circ - 20^\circ = 10^\circ$$

A popular formula for determining the power factor of a three-phase motor is

$$P.F. = \frac{W}{\sqrt{3}EI}$$

where I is the current per lead wire. Substituting the values found above for I the power factor is

$$P.F. = \frac{6000}{173 \frac{2}{3} \times 35 \times 60} = .795$$

$$P.F. = \frac{6000}{173 \frac{2}{3} \times 35 \times 65} = .959$$

$$P.F. = \frac{6000}{173 \frac{2}{3} \times 35 \times 45} = 1.399$$

$$P.F. = \frac{795 + 959 + 1.399}{3} = 1.021$$

Using i_1 and i_2 for I the mean current per lead wire,

$$P.F. = \frac{6000}{173 \frac{2}{3} \times 35 \times 37} = .980$$

Several of the methods used above are obviously in **great error** and their use would never be sanctioned in a careful test. For objection *alone* or could be raised against the last two methods of a capacitor though neither gives the true result.

In the determination of the power factor as the ratio of true to apparent power the question arises as to what constitutes the apparent power and the discrepancies in results are **due** to the various answers which may be given to this question.

While doubt must ever exist as to the value to be assigned to the apparent power in a three-phase system operating on an unbalanced load, the method in common use for determining the true power is correct for any condition of load, proportion of e.m.fs. or relation of power factor of currents, though the methods of proof of this fact, which are based on assumptions of equal currents, equal power factors, or equal e.m.fs. per phase, are evidently open to many objections.

EQUIVALENT SINGLE-PHASE CURRENTS.

Though some advantages may be claimed for the method of dividing the amount of power supplied to a polyphase motor by the number of phases and then treating the machine as that number of single-phase motors, greater simplicity is introduced into the calculation if equivalent single-phase qualities be determined for the polyphase circuit. In accordance with this plan the total number of watts supplied to the circuit is used in computations without alteration, the measured e.m.f. of the polyphase circuit is considered the equivalent single-phase e.m.f., while the equivalent effective current is understood to mean that value of current which must flow at the same power-factor in a single-phase circuit at the same voltage to transmit the same power.

It is evident that in a two-phase circuit the sum of the currents of the separate phases is the equivalent single-phase current. This quantity will hereafter be referred to as the "total current," or as simply the "current" of the two-phase circuit. Since the total power transmitted in a three-phase system is expressed by

$$W = \sqrt{3} I E \cos \theta,$$

$\sqrt{3} I$ is the equivalent effective current. In the equation above, I is the current per wire. For a delta-connected receiver the current per phase is equal to $I \div \sqrt{3}$ or the sum for the three phases is $3 I \div \sqrt{3} = \sqrt{3} I$. The quantity $\sqrt{3} I$ has, therefore, a physical significance as the total current in a delta-connected receiver, though in a star-connected machine such quantity exists only mathematically. However, for the sake of combined generality of treatment and brevity of discussion, $\sqrt{3} I$ will hereafter be spoken of as the "total current," or the "current" or the "equivalent single-phase current" of the three-phase circuit.

EQUIVALENT SINGLE-PHASE RESISTANCE.

In determining the copper loss of a given piece of polyphase apparatus, it is convenient to know what value of resistance must be taken so that the square of the total current may, by its multiplication therewith, give the actual copper loss when the corresponding current flows in the circuit. The following very simple ratio is found to exist between the resistance of a

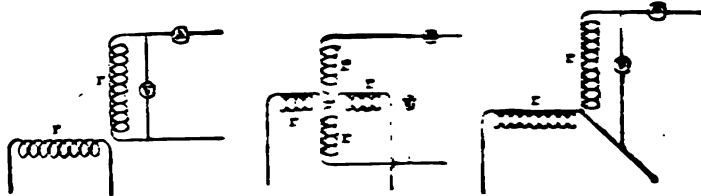

FIGS. 10, 11 and 12.—Determination of Equivalent Single-phase Resistance.

given circuit as measured by direct-current instruments and the equivalent resistance for the total current:

For any two-phase receiver with independent, star, three-wire, or mesh-connected coils, or for any three-phase receiver with delta, star or combination-connected coils, the equivalent resistance for the total current is equal to *one-half* of the value measured between phase lines by direct-current instruments.

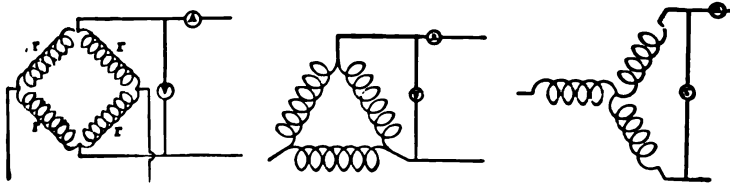

FIGS. 13, 14 and 15.—Determination of Equivalent Single-phase Resistance.

The proof of the above fact for circuits connected as shown by Figs. 10, 11 and 12, is self-evident and no explanation need be given.

Referring to Fig. 13 let r = resistance per quarter; then $2r + 2r = R$ resistance measured by direct-current instruments. Let i = current per coil; then $\sqrt{2} \times i$ = current per lead and $2\sqrt{2} \times i$ = total current. Evidently the copper loss

is $4 i^2 r$. Using the total current as above and $R \div 2$ as the equivalent resistance the copper loss is $(2 \sqrt{2} \times i)^2 \times r \div 2 = 4 i^2 r$.

In the delta-connected circuit of Fig. 14, let r = resistance per coil; then $2 r \div 3 = R$ = resistance measured. Let i = current per coil; then $3 i$ = total current, and the copper loss is $3 i^2 r$.

For equivalent single-phase quantities, the loss is $\frac{(3 i)^2 2 r}{2 \times 3} = 3 i^2 r$.

In Fig. 15 let r = resistance per coil; then $2 r = R$ = resistance measured, and if i = current per coil, then $\sqrt{3} i$ = "total" current. The copper loss is $3 i^2 r$. Using "total" current and equivalent resistance, the loss is $(\sqrt{3} \times i)^2 r = 3 i^2 r$.

Since the ratio of effective resistance for the total current to the measured resistance is the same for star and delta-connected, three-phase circuits, the same ratio must evidently hold for a combination of the two connections.

CHAPTER II.

OUTLINE OF INDUCTION MOTOR PHENOMENA.

METHODS OF TREATMENT.

For dealing with the phenomena of induction motors, there are numerous points from which the problem may be viewed, each view point involving a certain method of treatment, but it may be stated that in general all methods lead to practically the same results. Thus the machine may be treated as a transformer, or it may be considered a special form of alternating-current generator delivering current to a fictitious resistance as a load. It may be assumed that its torque is due to the current produced in the secondary of the transformer of one phase acting upon the magnetism due to the primary of another phase, or it is possible to consider that the magnetisms due to the separate phases combine to produce a revolving field in which the secondary circuits are placed. In what follows, the induction motor will be looked at from several points so that the reader will be able to obtain a clear view of the actions of the machine, a systematic attempt being made to present the motor in such a light as to avoid all unnecessary complexities which might tend to blur the vision.

Before dealing with the complex inter-relation of the component parts of the motor which so combine in their actions as to produce the performance obtained from the structure, it is well first to take a glance at the machine in its simplest form so as to see just what may be expected from it. It is believed that this method, without introducing inaccuracies inconsistent with the object sought, possesses the advantage of allowing the reader to become quickly acquainted with the machine, and permits him to ascertain the involved electromagnetic phenomena and to study them singly, and then conjointly, in the simplest possible manner.

The machine that will be discussed here is the ordinary poly-phase induction motor, having a stationary primary wound

with overlapping coils in slots, and a revolving secondary which moves in the rotating field set up by the primary windings. It may be well at this point to call attention to the fact that the primary coils can occupy either the moving or the stationary member, provided that the stationary or the moving member, respectively, is wound with the secondary coils. Due to this fact the terms "armature" and "field" members, when applied to an induction motor, are apt to lead to confusion. It should be noted that the machine has two windings, the "primary" and the "secondary," either of which may be placed on the "rotor" or the "stator."

PRODUCTION OF REVOLVING FIELD.

As usually built, the primary coils form a distributed winding similar to that of a direct current armature. These coils are connected into groups according to the number of phases and poles for which the machine is designed, there being one group per phase per pole.

The current for each phase is run through the corresponding group of each pole, tending to make alternate north and south magnetic poles around the machine. These north and south poles of each phase combine with those of the other phases to make resultant north and south poles. These resultant poles shift positions with the alternations of the currents and occupy places on the primary core determined by the relative strengths of the currents in the different groups of coils. Each magnetic pole, therefore, advances by the arc occupied by one group of windings for each phase during each alternation of the current. It is thus seen that the resultant magnetic field revolves at a speed depending directly upon the alternations and inversely upon the number of poles.

In the revolving field is situated the secondary, in the windings of which is generated an e.m.f. determined by the rate at which its conductors are cut by the magnetic lines from the primary. If the circuits of the secondary be closed there will flow therein a current which, being in a magnetic field, will exert a torque tending to cause the secondary member to turn in the direction of the revolving field. The final result is that the speed of the rotor increases to a value such that the relative motion of the secondary conductors and the revolving field generates

an e.m.f. sufficient to cause to flow through the impedance of the conductors a current, the product of which into the strength of the field will equal the torque demanded.

As can be seen, the speed of the rotor can never equal the speed of the rotating magnetic field, because the conductors of the secondary must cut the lines of force of the field in order to cause current to flow in the secondary winding, and pull the rotor around; if the speeds were identical there would be no cutting. The difference between these two speeds is commonly known as the "slip." For the purpose of this discussion the slip will be considered in terms of the synchronous speed, that is to say, if the synchronous speed were 1200 r.p.m. and the actual speed of the rotor or secondary member were 1176 r.p.m., the slip would be $24 \div 1200 = 0.02$.

Since the conductors of the secondary cut an alternating field, first of one polarity and then of the other, the current produced in them will be alternating. The frequency of this current is normally much lower than the frequency of the supply current; the secondary frequency is equal to $s f$, s being the slip and f the frequency. The current in the secondary being alternating, the impedance of the secondary winding has a reactive component in addition to its resistance. The reactance at standstill is, of course, equal to

$$2 \pi f L_2 = X_2.$$

f being the frequency of the supply current and L_2 the coefficient of self-induction of the secondary winding. The secondary reactance when the machine is in operation is equal to

$$2 \pi f L_2 s = s X_2,$$

s being the slip, as previously explained.

It is evident that the reactance of the secondary increases directly with the slip, so that with a constant value of secondary resistance the impedance increases as the slip increases; not in direct proportion, however. The effect of the reactive component of the secondary impedance is to cause the secondary current to lag behind the secondary e.m.f. by an "angle," the cosine of which is equal to the resistance of the circuit divided by its impedance. If θ represents this angle, $\cos \theta$ represents the power factor of the secondary current.

Looking further into the effect of increasing the load on the

motor, it will be plain that when the rotor is running near synchronism the reactance is of negligible effect, so that the secondary current increases directly with the slip and has a power factor of practically unity. As the load increases, the torque must be greater; the motor slip therefore increases, with a consequent increase of secondary e.m.f. As the reactance begins now to increase, the impedance also increases, and the secondary current is no longer proportional directly to the secondary e.m.f., and the current which does flow has a power factor less than unity, that is to say, it is out of phase with the secondary e.m.f. Thus it is out of time phase with the revolving magnetism, thereby requiring a proportionately larger current to produce a corresponding torque.

The increased draft of current demanded for the primary circuit entails a drop of e.m.f. in the primary windings, and, since there must be mechanical clearance between the primary and secondary cores, the lines of force which pass from the primary to the secondary are diminished by the increase of the secondary current, which always flows so as to oppose the magnetism causing it. Therefore the magnetic field, which produces the secondary e.m.f., decreases with increase of load. Since only the qualitative behavior of induction motors is necessary for the purpose of this discussion, and no regard need be had at present for the quantitative performance, this effect will be momentarily neglected.

SIMPLE ANALYTICAL EQUATIONS.

- Let E_2 = secondary e.m.f. at standstill;
- $s E_2$ = secondary e.m.f. at a slip s ;
- X_2 = secondary reactance at standstill;
- $s X_2$ = secondary reactance at a slip s ;
- R_2 = secondary resistance.

then $\sqrt{R_2^2 + s^2 X_2^2}$ = secondary impedance,

$$I = \frac{s E_2}{\sqrt{R_2^2 + s^2 X_2^2}} = \text{secondary current, and } \cos \theta = \frac{R_2}{\sqrt{R_2^2 + s^2 X_2^2}}$$

= secondary power factor; all three at the slip, s .

$$D = \frac{s E_2}{\sqrt{R_2^2 + s^2 X_2^2}} \times \frac{R_2}{\sqrt{R_2^2 + s^2 X_2^2}} \times K = \text{secondary torque, at the slip, } s; \text{ where } K \text{ is a constant depending upon the terms in}$$

which torque is expressed, and upon the magnetic field,—the latter being here assumed constant.

$$\text{Hence } D = \frac{R_2 s E_2 K_2}{R_2^2 + s^2 X_2^2} = \text{rotor torque at the slip } s.$$

An examination of these formulas reveals many of the characteristics of the induction motor, which it is well to discuss at this point.

(1) The torque becomes maximum when $R_2 = s X_2$.

(2) If R_2 be made equal to X_2 , maximum torque will occur at standstill.

(3) Since at maximum torque $R_2 = s X_2$ the torque is equal to

$$\frac{s^2 X_2 E_2 K}{2 s^2 X_2^2} = \frac{E_2 K}{2 X_2},$$

and the value of maximum torque is independent of the resistance.

(4) When X_2 is negligible the torque = $K \frac{s E_2}{R_2}$, or the torque is directly proportional to the slip near synchronism, and inversely to the resistance.

(5) At standstill the torque = $\frac{K R_2 E_2}{R_2^2 + X_2^2}$ which, when R_2 is less than X_2 can be increased by the insertion of resistance up to the point where the two are equal; further increase of resistance will then decrease the torque.

(6) The starting torque is proportional to the resistance and inversely proportional to the square of the impedance.

(7) Since power is proportional to the product of speed and torque, the output is equal to

$$P = A (1 - s) \frac{K R_2 s E_2}{R_2^2 + s^2 X_2^2} = A (1 - s) D, \text{ and is a maximum}$$

at a slip less than that giving maximum torque.

$$(8) \quad I = \frac{s E_2}{\sqrt{R_2^2 + s^2 X_2^2}}$$

and at maximum torque $R_2^2 = s^2 X_2^2$. Therefore, I at maximum

torque = $\frac{s E_2}{\sqrt{2} s X_2} = \frac{E_2}{\sqrt{2} X_2}$; whence it is plain that the secondary

current giving maximum torque is independent of the secondary resistance.

(9) At maximum torque the secondary power factor = $\frac{1}{\sqrt{2}}$
 = 0.707.

$$(10) I^2 R_2 = \frac{s^2 E_2^2 R_2}{R_2^2 + s^2 X_2^2} = \frac{s E_2 D}{K} \text{ and since } E_2 \text{ is constant}$$

for constant impressed pressure, the copper loss of the secondary is proportional to the product of the slip and torque.

(11) For a given torque the slip is proportional to the copper loss of the secondary and independent of the secondary reactance or coefficient of self-induction.

$$(12) \text{ Output is equal to } P = I E_2 (1 - s) \cos \theta$$

$$P = \frac{s E_2}{\sqrt{R_2^2 + s^2 X_2^2}} \cdot E_2 (1 - s) \cdot \frac{R_2}{\sqrt{R_2^2 + s^2 X_2^2}} =$$

$$\frac{R_2 s E_2^2 (1 - s)}{R_2^2 + s^2 X_2^2} = \frac{D}{K} E_2 (1 - s)$$

(13) If all losses except that of the secondary copper be neglected, the input will be

$$P + I^2 R_2 = \frac{D}{K} E_2 (1 - s) + \frac{D E_2 s}{K}$$

and the efficiency will be

$$\frac{\frac{D}{K} E_2 (1 - s)}{\frac{D}{K} E_2 (1 - s) + \frac{D E_2 s}{K}} = 1 - s.$$

which means that the efficiency is equal to the absolute speed in per cent. of synchronism. Since there must be losses in addition to that of the secondary copper, the *efficiency is always less than the speed in per cent. of synchronism.*

(14) At a given slip the torque varies as the square of the primary pressure. This is seen from the fact that the secondary current at a given slip will vary directly as the strength of field, the power factor will remain constant, and therefore the torque which is obtained from the product of secondary current, power factor and field will vary as the square of the field. Since the strength of the field varies directly with the primary pressure at a given slip, the torque will vary as the square of the primary pressure.

STARTING DEVICES FOR INDUCTION MOTORS.

Having thus determined the behavior of the induction motor under various changes of condition, the next step is to ascertain the methods by which it can be adapted to services of different requirements.

If the impedance of the secondary be sufficiently great to prevent a destructive flow of current when full pressure is applied to the primary with the rotor at standstill, the motor may be started by being connected directly to the supply circuit. This is a method adopted quite extensively for motors of small size. If the impedance consists for the most part of reactance, the current drawn will have a low power factor, which, in general, affects materially the regulation of the system; the starting torque will be small.

It was proved above that by so proportioning the secondary resistance that $R_2 = X_2$ the maximum torque would be exerted at standstill. With resistance of such a value permanently connected in the secondary circuit, at full load the slip would be enormous and the efficiency correspondingly low, as shown above. As a compromise in this respect, motors are usually constructed with only comparatively large resistance in the secondary windings.

In order to reduce the current at starting, large motors are often arranged to be supplied with a lower primary e.m.f. and the full line e.m.f. applied only after they have attained a fair speed. This is also especially desirable when otherwise the excessive starting torque would produce mechanical injury to the shafting, etc., driven by the motor. For elevators and cranes this method has found extensive application. Crane motors are built with a secondary resistance which gives maximum torque at standstill. The reduced primary pressure is secured either from lowering transformers or from compensators (auto-transformers). In either case, loops are taken to a suitable controller, by which the pressure supplied to the primary of the motor is governed. Pressures of a number of different values are thus obtained. The very intermittent character of the work performed by crane motors renders their low efficiency a necessary evil, since in any case the efficiency must be less than the speed in per cent. of synchronism.

In order to combine large starting torque with good running

speed and efficiency, it is customary to provide resistance external to the secondary windings and arrange to suitably reduce this resistance as the speed increases, allowing the motor to run without external resistance for the highest speed. For continuous service this method has proved highly satisfactory and gives the best running efficiency. Ordinarily, this necessitates the use of collector rings for the revolving member, whether such be the primary or the secondary. When the secondary revolves it is universally given a three-phase winding, independent of the number of phases of the primary, and therefore three collector rings are used. The external resistance is connected either "delta" or "star," and regulated by a suitable controller.

A very ingenious device for automatically adjusting the external resistance was exhibited at the Paris Exposition. It was shown above that the frequency of the secondary e.m.f. depends directly upon the slip and is a maximum at standstill. If an induction coil of low resistance and high inductance be subjected to an e.m.f. of varying frequency, the admittance will vary inversely with the frequency. In the Fischer-Hinnen device, just referred to, there is connected external to the secondary windings a non-inductive resistance of a value to give practically maximum torque at standstill. In parallel with this is connected a highly inductive coil of extremely small resistance. At zero speed the admittance of the external impedance consists practically of only that of the non-inductive resistance. As the speed increases the admittance increases, due to the decreased reactance, and at synchronism the external impedance is somewhat less than the resistance of the inductive coil. The action is, therefore, in effect the same as though the external resistance had been decreased directly as the speed increased. It is claimed that the starting device occupies so small a space that it can be placed in the rotating armature, so that no collector rings are required.

CONCATENATION CONTROL.

A common defect in all methods of speed regulation thus far described is the low efficiency at speeds far below synchronism. Attention has been frequently directed to the fact that the efficiency is in any case less than the speed in per cent. of syn-

chronism. In order, therefore, to run at high efficiency at reduced speed, it is necessary to adopt some method of decreasing the synchronous speed.

The synchronous speed of a motor is equal to the alternations of the system divided by the number of poles of the motor. If, therefore, a motor is arranged for two different numbers of poles it will have two different synchronous speeds. While offering many advantages over other more complicated systems of speed control, and introducing no unsurmountable difficulties in practical application to existing types of motors, this method has as yet passed little beyond the stage of experimental investigation.

With mechanical connection between two motors, "concatenation" or "tandem" control also offers a means of reducing the synchronous speed. In practice, the secondary of one motor is connected to the primary of the other, the primary of the first being connected to the line. The frequency of the current in the secondary of any motor depends upon its slip, as noted above. At standstill, therefore, the frequency impressed upon the primary of the second motor will be that of the line. As the motor increases in speed the frequency of the secondary of the first motor decreases, and at half speed the frequency impressed upon the primary of the second motor will be equal to the speed of its secondary; that is, it will have reached its synchronous speed. If now, the primary of the second motor be connected to the supply circuit and the secondary of the first motor be connected to a resistance, the motors will tend to increase in speed up to the full synchronism of the supply.

By the use of suitably selected resistances for the secondary circuits of the two motors, this method gives the same results as the series-parallel control of direct-current series motors, with one important distinction, however. The series-wound motors tend to increase indefinitely in speed as the torque is diminished, while the induction motors tend to reach a certain definite speed, above which they act as generators. In this respect they resemble quite closely two shunt motors with constant field excitation, having armatures connected successively in series and in parallel, with and without resistance, and, like the shunt motors, when driven above the normal speed they feed power back to the supply.

CHAPTER III.

OBSERVED PERFORMANCE OF INDUCTION MOTOR.

TEST WITH ONE VOLTMETER AND ONE WATTMETER.

In the preceding chapter, a hasty glance was taken at the characteristics of an induction motor under certain assumed ideal conditions. It is well to show from actual tests just how closely the observed results compare with the ideal calculated results. Below there is given, therefore, the complete test of

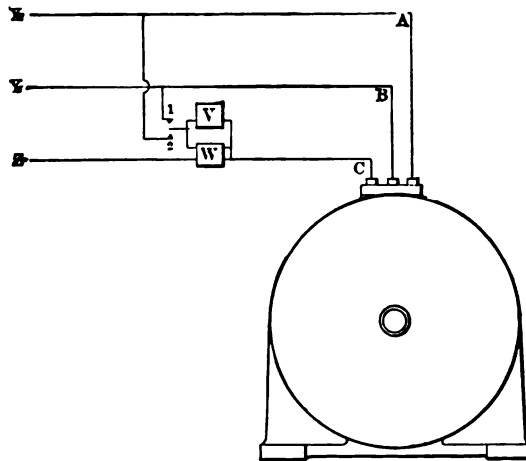

FIG. 16.—Test of Three-phase Motor with One Voltmeter and one Ammeter.

an induction motor under actual operating conditions, and incidentally mention is made of a convenient method for testing a motor when the supply of instruments is limited.

The method of testing a transformer or a generator by separation of the losses is well known. It is such a method, which by a few slight modifications can be applied to induction motors, that is given below. Most of what is stated in this connection is true for any induction motor under any condition of service,

though the greatest simplicity in testing and the requisite use of the least number of instruments will be obtained only with polyphase motors operating on well balanced and regulated circuits. Each element of a test is treated separately.

MEASUREMENT OF SLIP.

The determination of the slip of induction motor rotors by counting the r.p.m. of both generator and motor is open to many objections. If the two readings of speed be not taken simultaneously though the true value of each be correctly observed, when the speed of either is fluctuating the value of slips will be greatly in error. A slight proportional error in either speed introduces an enormous error in the slip. Where the generator is not at hand the above method obviously cannot be directly applied, and is applicable only when a synchronous motor is available for operation from the same supply system as the induction motor.

When the secondary current can be measured and the secondary resistance is known, the most accurate and convenient method for determining the slip is from the ratio of copper loss of secondary to total secondary input.

If we let I_2 be any observed value of secondary current, R_2 the secondary resistance and W_0 the output of the motor, then

$$\text{Slip} = s = \frac{I_2^2 R_2}{W_0 + I_2^2 R_2} = \frac{\text{Copper loss of secondary}}{\text{total secondary input}}$$

As a proof of this fact, consider the magnetism cut by the secondary windings to be of a strength which would cause to be generated E_2 volts in the windings at 100 per cent. slip.

Let s be any given slip, W_s the total secondary watts, θ the angle of lag of secondary current, and X_2 the secondary reactance at 100 per cent. slip, then

$$\frac{I_2^2 R_2}{W_0 + I_2^2 R_2} = \frac{I_2^2 R_2}{W_s} = \frac{I_2^2 R_2}{I_2 E_2 \cos \theta}$$

$$I_2 = \frac{s E_2}{\sqrt{R_2^2 + X_2^2 S^2}} = \frac{s E_2}{R_2 \sec \theta}$$

$$\text{and } \frac{I_2^2 R_2}{I_2 E_2 \cos \theta} = \frac{s I_2 E_2 R_2}{I_2 E_2 R_2 \cos \theta \sec \theta} = s$$

Since neither E_2 nor X_2 appears in the above equation, the relation is independent of the strength of field magnetism cut by the secondary windings and of the secondary reactance.

DETERMINATION OF TORQUE.

The torque of the rotor can be ascertained with the highest degree of accuracy and facility from the ratio of secondary input to the synchronous speed, that is, the torque is expressed in pounds at one-foot radius by the following equation:

$$\text{Torque} = D = 7.04 \frac{W_p - L_p}{\text{syn. speed}}$$

where W_p is the total primary input; L_p the total primary losses, and the synchronous speed is in r.p.m.

If L_p includes the friction, D will equal the external rotor torque, while if L_p includes only the true primary iron and copper losses, D will be the total rotor torque.

To prove the above expressed relation, let W_s be total secondary input, W_o the motor output, and s the rotor slip. Then

$$D = \frac{33\,000\ W_o}{2\ \pi\ \text{r.p.m.}\ 746}$$

but $W_o = W_s (1 - s)$ and r. p. m. = synchronous speed $(1 - s)$.

Therefore,

$$D = 7.04 \frac{W_s}{\text{syn. speed}}$$

Therefore, for a given primary input and primary losses the rotor torque is independent of secondary speed or output, and any error in the determination of either of the latter quantities need not affect in the least the value obtained for the torque.

If the total power received by the secondary is used up in the secondary resistance the equation for the torque will be

$$D_o = 7.04 \frac{I_2^2 R_2}{\text{syn. speed}}$$

or starting torque, which, as has been stated previously, may be increased by any method which will increase the stationary secondary copper losses.

MEASUREMENT OF SECONDARY RESISTANCE.

Due to the inability to insert measuring instruments in the secondary of squirrel-cage induction motors, the ordinary direct-current method of determining the resistance cannot be used.

If the rotor be clamped to prevent motion a wattmeter placed in the primary circuit will read the copper loss of both primary and secondary when the e.m.f. across the leads is reduced to give a fair operating value of primary current. If from the reading of watts thus obtained there be subtracted the known copper loss of the primary for the current flowing, the value of the secondary copper loss will be secured. The resistance of the secondary (reduced to primary) will be obtained by dividing this loss by the square of the primary current. It is to be noted that certain minor effects are here neglected. These effects are of small moment and do not seriously modify the final results. However, they will be treated at length in a later chapter.

DETERMINATION OF SECONDARY CURRENT.

When the motor is provided with a squirrel cage secondary winding, measurement of the secondary current cannot be made directly, but the determination of its value must be by calculation. The variation in value and phase of the primary current may serve as an indication of the current flowing in the secondary windings, though the actual increase in primary current does not represent the increase in secondary current.

The difference between the power components of the primary current at no load and under a chosen load may be taken as the equivalent increase in the power component of the secondary current under the same conditions, while the difference between the quadrature components of the primary current at the same time is a measure of the equivalent increase in the quadrature component of the secondary current.

When the no-load value of secondary current is negligible the vector sum of the above-found components represents the secondary current for the chosen load in terms of the primary current. These facts will be discussed more fully hereafter.

CALCULATION OF PRIMARY POWER FACTOR.

For a single-phase motor the determination of the primary power factor will usually involve the measurement of primary watts, volts and amperes.

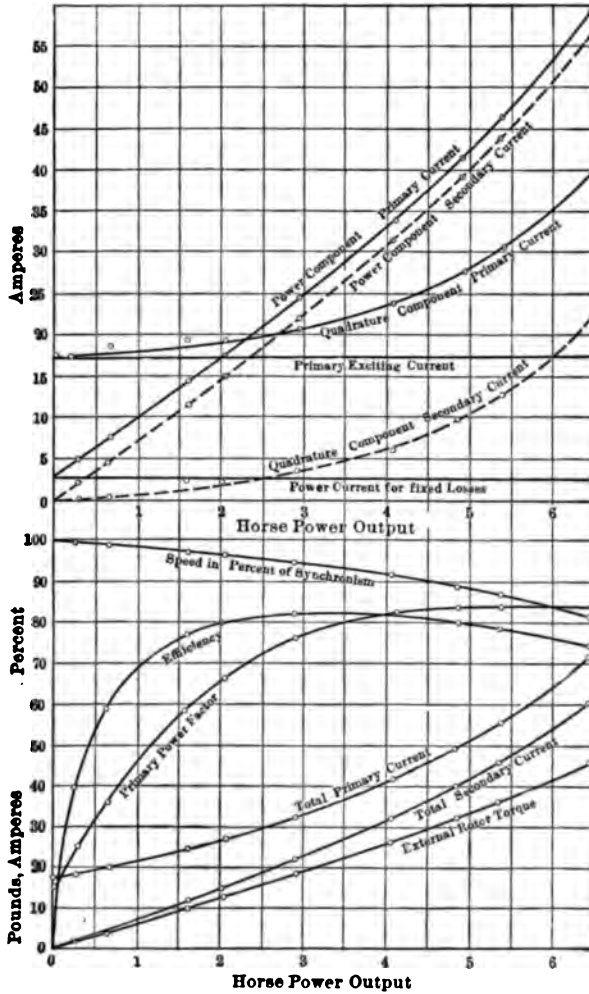

FIG. 17.—Test Characteristics of Induction Motor.

For two-phase motors with equal e.m.f.s. across the separate phases, one wattmeter alone may be used to obtain the power factor by simply transferring the pressure coil from one phase

to the other, leaving the current coil always in one lead. The reading of the wattmeter in one case will be $W_1 = I E \cos \theta$, and in the second case, $W_2 = I E \sin \theta$; whence $\tan \theta = \frac{W_2}{W_1}$

from which may be obtained the power factor.

For three-phase motors one wattmeter can similarly serve to indicate the power factor. The wattmeter readings will be $W_1 = I E \cos (\theta - 30)$; $W_2 = I E \cos (\theta + 30)$,

$$\text{whence } \tan \theta = \sqrt{3} \frac{W_1 - W_2}{W_1 + W_2}.$$

CALCULATION OF PRIMARY CURRENT.

If the primary electromotive force watts, and power factor be known, the primary current can readily be calculated and, therefore, need not be measured.

It is evident from the above discussed facts that with two and three-phase induction motors operated from circuits having constant and equal e.m.fs. across the separate phases, one wattmeter and one voltmeter can be used to determine primary watts, amperes and volts, and secondary amperes, and that when the primary resistance is known or can be measured the complete performance efficiency, etc., of the motors can at once be calculated.

In the above table and in Fig. 17 there are given the calculations and the curves of such a test made upon a 5-h.p., eight-pole, 60-cycle, three-phase induction motor. The primary resistance between leads at running temperature was .156 ohm, and the equivalent secondary resistance (found as above) was .56 ohm.

Since the copper loss of a three-phase receiver is expressed by the equation, $\sqrt{\frac{3}{2}} R I^2$, where R is the resistance between lines and I is the current flowing in each lead, for either star or delta-connected receiver no attention need be paid to the method by which the primary coils are interconnected within the motor or, in fact, whether the secondary be wound delta, star or squirrel cage.

Tests made upon this same motor by the output-input methods agree throughout the whole range of the test with the herewith recorded test within the limits of the inevitable errors of observation of the various instruments used in the tests.

CHAPTER IV.

INDUCTION MOTORS AS FREQUENCY CONVERTERS.

FIELD OF APPLICATION.

For the satisfactory operation of arc lamps a frequency higher than 40 p.p.s. is required, while when the frequency is much below this value incandescent lamps may show a fluctuation in brilliancy. The output of transformers may be shown to vary as the three-eighth power of the frequency. These are among the causes for the fact that in the older lighting stations a frequency as high as 133 p.p.s. was quite common.

With later increase of magnitude and range of service, it was found that a lower frequency improved the operation of alternators in parallel, while the line regulation was also benefitted by the change from the higher frequency. This led to the adoption of a periodicity of about 50 to 60 p.p.s. With the advent of the long-distance power transmission circuits, the advisability of the adoption of a still lower frequency became apparent, while the successful use of rotary converters for railway work practically necessitates a frequency as low as 25 cycles. This is the present standard frequency for such service.

When lighting is to be done from power supplied at 25 cycles, some means must be provided for altering the nature of the current before it can be applied to the lamps. A most satisfactory method of accomplishing this result is by means of alternating-current motors, of either the induction or synchronous type, driving lighting generators. Where only high-voltage alternating currents are available this method requires the use of step-down transformers, a motor and a generator, each carrying the full load. When the pressure at hand is sufficiently low, step-down transformers may be dispensed with, but a double equipment and double transformation of power is still necessary, with consequent low efficiency and high cost of installation.

A convenient method for changing the lower frequency to a

value suitable for lighting purposes is by the use of "frequency converters," which constitute a special adaptation of induction motors as secondary circuit generators.

CHARACTERISTIC PERFORMANCE.

In the ordinary induction motor the frequency of the secondary current is not that of the supply, but it has a value represented by the product of the slip of the rotor from synchronous speed and the frequency of the primary current. It is only when the slip is unity, or at standstill that the primary and secondary frequencies are equal. Under this condition the windings are in a true static transformer relation, and, with the rotor clamped to prevent relative motion, current at the primary frequency can be drawn from the secondary windings. Obviously, the air-gap renders the induction motor for such purposes much inferior to a static transformer, on account of magnetic leakage between the coils.

If, now, the secondary be given a motion relative to the primary, there may continue to be drawn from the secondary, current at a frequency determined by the slip from synchronous speed. If this slip be greater than unity—that is, if the motor be driven backwards—the frequency of the secondary current will be greater than that of the primary. By properly proportioning the rate of backward driving, the secondary current can be given a frequency of any desired value.

In order that the secondary frequency may bear a constant ratio to the primary, it is necessary that the relative slip from synchronism be constant, which condition can conveniently be obtained by driving the rotor with a synchronous motor operated from the same supply system as the primary.

Evidently the synchronous motor will demand power from the supply in addition to that demanded by the primary circuit of the frequency converter. The amount of this power is determined by the speed of the synchronous motor and the torque exerted by the frequency converter. When the slip of the converter is unity, the power demanded by the synchronous motor is zero; when, however, the slip is two—that is, when the frequency of the secondary is twice that of the primary—the power demanded by the synchronous motor is equal to that demanded by the primary of the converter. A further

analysis will show that the power supplied by the frequency converter bears to the total output the ratio of the primary frequency to that of the secondary, the remaining power being supplied by the synchronous motor.

CAPACITY OF FREQUENCY CONVERTERS.

Since the total output appears at the secondary of the converter it behoves us to ascertain in what manner the power supplied by the synchronous motor enters the converter windings.

Let the ratio of primary to secondary turns be unity, and let us consider the secondary current in phase with the secondary e.m.f., and let it be counter-balanced by an equal current in the primary in phase with its e.m.f., then

I = primary current in phase with the primary e.m.f. and in phase opposition to the secondary current.

I = secondary current.

E = primary impressed e.m.f.

SE = secondary generated e.m.f., where S = slip with synchronism as unity.

IE = primary power.

ISE = secondary electrical power.

In the ordinary induction motor, where S is less than unity, the secondary generated power (SE) is dissipated in the copper of the secondary windings, while the remaining power received from the primary ($IE - SE$) is available for mechanical work. When S is equal to unity the secondary generated power (SE) is totally available as electrical power, which may be lost in the resistance of the secondary windings or usefully applied to external work, while the mechanical power of the secondary is zero. When S is greater than unity the total secondary generated power (SE) is available at the secondary terminals. Of this power (IE) is supplied by the primary, while the remainder is supplied by the synchronous motor.

It is seen, therefore, that the effect of driving the secondary backwards is to increase the secondary pressure above that of the primary, and that the power for such increase is derived from the synchronous motor.

A moment's reflection will show that there is only partial double transformation of power with a frequency converter,

and that the sum of the capacities of the synchronous motor and the converter must just equal the output plus the inevitable losses in each machine. A numerical example will show this quite plainly. If we assume a lighting load of 60 kilowatts to be changed in frequency from 25 to 60 cycles, then the capacity of the frequency converter proper must be 25 kilowatts, and that of the synchronous motor 35 kilowatts, as shown above. It should be noted, however, that while the iron loss of the converter primary is the same as that of a 25-kw. induction motor on 25 cycles, the iron loss of the secondary of the converter is that of a 60-cycle, 60-kw. generator, and thus very materially greater than that of a 25-kw. induction motor, which latter, in fact, is usually quite negligible.

By over-excitation, the leading component of the current demanded by the synchronous motor may be adjusted to equal the lagging component due to the exciting current of the frequency converter, so that the external apparent power factor of the equipment may be kept quite high.

CHAPTER V.

THE HEYLAND INDUCTION MOTOR.

EXCITATION OF INDUCTION MOTORS.

When there is impressed upon the primary of an induction motor an e.m.f. of full normal value, the secondary being on open circuit and the rotor stationary, there is caused to flow within the windings a current the magnitude and phase of which can best be determined by ascertaining the value of its two components. Its power component is of a value such that its product with the circuit e.m.f. is just sufficient to supply to the motor the no-load power, consisting of primary copper loss and both primary and secondary iron loss. Its wattless or quadrature component has a value such that its product with the number of turns of the primary windings produces the requisite magnetomotive force to cause to flow, through the reluctance of its paths, a magnetic flux of which the rate of change at each instant is proportional to the otherwise unbalanced primary e.m.f. The unbalanced primary e.m.f. referred to is that portion of the impressed e.m.f. which remains after subtracting (in proper phase position) the e.m.f. consumed by the local impedance of the primary windings due to the passage of the current therein. The observed primary current is the vector sum of the above named components, while the phase relation of the current with respect to the e.m.f. is given by that angle the cosine of which is equal to the power component divided by the observed current.

It is evident that in order to decrease the phase displacement between the current and e.m.f., it is necessary to render the power component and the observed current more nearly equal in value. This may be accomplished by one, or both, of two methods; *i.e.*, increasing the power component, or decreasing the wattless component of the current. The former method is that to which is due the increased power factor, or decreased phase displacement, with increase of load on the ordinary in-

duction motor, the maximum power factor appearing when that condition is reached when the ratio of the power component to the wattless component is a maximum. If the wattless component remained constant in value an increase in load would always be accompanied by an increase in power factor. But owing to the existence, upon increase of primary and secondary currents, of local magnetic lines of force which flow in closed paths around the primary coil without enclosing any secondary conductors and around the secondary without enclosing any primary conductors, producing field distortion and a reduction of the flux common to both windings, the wattless component is increased with each increment of load and the rate of increase is much augmented as full load is approached and passed. Obviously, therefore, the result of loading an induction motor is not to decrease the lagging current below that value which the motor demands at no-load, though the increased power factor is frequently credited with reducing the undesirable effects which are caused by and proportional to the lagging wattless component of the primary current.

The most logical method of improving the power factor of operation of an induction motor is that which has for its object the reduction of the wattless component of the primary current. The employment of details of construction which lessen the tendency of the flux to close around one winding without encircling the other, tends to the reduction of the wattless current component with increase of load and thus improves the operating power factor and the mechanical performance of the motor, since the maximum torque which the rotor can exert and the overload which the motor can carry are determined almost wholly by the local reactance of the windings.

The amount of magnetic flux which the no-load wattless component of the current must produce is determined by the primary e.m.f. and frequency, and the value of the wattless component depends upon the reluctance of the paths which these lines must take. The major portion of this reluctance is found in the air-gap which forms the separating space between the rotor and stator. A reduction in the air-gap is followed by an almost proportional decrease in the inductive or wattless component of the current, which accounts for the fact that all modern induction motors are constructed with

air-gaps as small as permitted by the requisite mechanical clearance between the stationary and revolving members of the machine. It is evident that much further improvement along this line can scarcely be expected.

Although it is for the purpose of producing counter e.m.f. in the primary that the core magnetism is required, it is not essential that the exciting current should flow in the primary windings; the magnetomotive force for excitation may with equal effect be supplied by current in the secondary, although the ampere-turns in the one case must equal those in the other.

SECONDARY EXCITING MAGNETOMOTIVE FORCE.

Consider an induction motor with a stationary primary and a revolving secondary, the latter being coil wound, and, for simplicity of discussion, assume the secondary turns equal in number to the primary. Let the rotor be at rest and the secondary on open circuit. On applying normal e.m.f. to the primary windings there will flow a current having power and wattless components, as discussed previously. If the secondary be now interchanged for the primary winding in its connection to the external circuit, an exactly similar and equal current will be found to flow in the secondary winding. If both the primary and secondary windings be connected simultaneously to the external supply circuits, care being taken that the separate revolving fields due to the wattless current components in the two windings travel around the air-gap in the same direction. It will be found that at a certain position of the rotor relative to the stator the two windings combined take a current equal in value and character to that taken by each winding when connected up alone. By increasing slightly the e.m.f. impressed upon the secondary, the primary e.m.f. remaining as before, the wattless component flowing in the primary windings may be reduced to zero, or even given a negative value. Under this condition the quadrature component of the ampere-turns in the secondary windings has a value just sufficient to give the magnetomotive force to produce the requisite core magnetism to induce the desired primary counter e.m.f. The rotor is, however, stationary, and even resists any attempt at motion in either direction so that with connections arranged as just described no mechanical power can be obtained from the motor.

It is possible to supply the exciting magnetomotive force to the motor through the secondary windings while the rotor travels at full speed without any constructive change in the windings of the motor, as here assumed. Consider normal e.m.f. impressed upon the primary with the secondary on closed circuit and the rotor traveling at full speed. The wattless component of the primary current will have practically the same value as with the secondary on open circuit and the rotor stationary. If now there be introduced into the secondary windings direct current adjusted in value to equal the mean effective value of the wattless component of the primary current, as previously observed, it will be found that the lagging component of the primary current has been reduced to zero, so that the power factor has increased to unity. The motor may now be given its full load and its performance will be found to be satisfactory in all respects.

DIRECT CURRENT IN SECONDARY COILS.

It is well at this point to investigate the advantages and disadvantages of this latter arrangement. The core magnetism is not decreased in value, so that the exciting current is as large as ever, but the latter has been transferred from the primary to the secondary winding, and not only is its value the same as before, but because of the fact that when existing in the primary windings it was the wattless component of the working current, its heating effect upon the secondary windings is just equal to the reduction in heat loss in the primary windings; therefore no gain has been made through a reduction in heat loss.

Let E = primary e.m.f.

R = primary or secondary resistance.

I_p = power component of primary current.

I_q = exciting current, whether in the primary or sec-

ondary windings.

Under normal no-load conditions, the primary copper loss is

$$(\sqrt{I_p^2 + I_q^2})^2 R = I_p^2 R + I_q^2 R,$$

while the secondary copper loss at no-load is of practically zero value.

With direct current in the secondary winding, the copper loss there is

$$I_q^2 R,$$

and the primary copper loss is

$$I_p^2 R,$$

so that the total copper loss, $I_p^2 R + I_q^2 R$, in the two windings is the same as before.

Although the actual excitation loss in the primary under normal no-load conditions was $I_q^2 R$, the apparent exciting power was $I_q E$ in addition to the loss. This "wattless" current, I_q , is required to travel over the circuits and transforming devices between the generator and motor, and tends to decrease the field magnetism of the generator and to reduce further the e.m.f. at the receiving end of the transmission line. An elimination of this wattless component removes the greatest objection to the otherwise admirable induction motor.

With direct current supplied to its secondary windings an induction motor travels at synchronous speed, and, in fact, becomes transformed to a synchronous motor and therefore possesses all of the qualities inherent in the performance of this type of machine. Mr. Heyland has devised a method, however, by which approximately unidirectional current may be supplied to the secondary windings while the motor yet retains the characteristics of the asynchronous type of machine.

ALTERNATING CURRENT IN SECONDARY COILS.

The method of obtaining this most desirable result consists in applying to the secondary windings a commutator to which current from the source of supply for the primary is led by way of properly disposed brushes. The commutator necessary for the operation of the motor is small in size, and, on account of the fact that adjacent segments are connected together by non-inductive resistance external to the windings, there is no possibility of sparking at the brushes, and its performance is quite similar to that of slip rings.

Fig. 18 represents diagrammatically a direct-current armature complete with commutator, to be used as the secondary of an induction motor. Since no current whatever will flow in the conductors of a direct current armature when on open circuit,

the armature alone will possess no tendency to be drawn into rotation by the revolving magnetism of the primary. In order that the armature winding may serve as the secondary of the induction motor, it is necessary that points on the armature possessing difference of potential be joined together. The resistance, shown in Fig. 18 as being connected between adjacent segments, serves to complete the secondary circuit, and with the brushes removed from the commutator the motor thus equipped will operate in all respects similarly to one with a pure "squirrel-cage" secondary winding. The three brushes shown in the figure are for the purpose of allowing the intro-

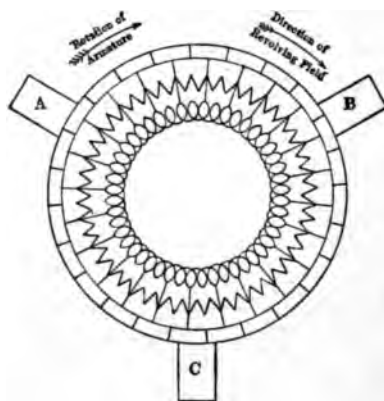

FIG. 18.—Direct-current Armature of Heyland Motor for Three-phase Secondary Excitation, Showing Segment-connecting Resistances.

duction of three-phase current into the secondary for supplying sufficient magnetomotive force for field excitation, in order that no wattless current need flow in the primary windings.

According to the foregoing discussions it is plain that with the rotor traveling at synchronous speed, current of zero frequency may be utilized to supply the magnetomotive force for excitation, while with the rotor stationary, current at a frequency equal to that of the primary may thus be employed. A little further consideration will convince one that at speeds between synchronism and standstill current at intermediate frequencies may be so used, and that the requisite frequency in each case is equal to the product of the percentage of slip

and the primary frequency. By attaching to the secondary windings a commutator, to the brushes upon which current is led at the primary frequency, the current in the secondary will, at any speed, possess the frequency required for excitation.

ACTION WITH STATIONARY ROTOR.

For the sake of simplicity in explanation, consider, in the first place, that upon the rotor there is placed a symmetrical direct-current armature winding with a corresponding commutator. By introducing into the windings an alternating current at the

TABLE I.—Instantaneous values of currents in each coil of direct-current winding; three-phase excitation; rotor stationary. (Fig. 18).

Number of coil.	A	B	C	D	E	F
1	+10.00	+8.66	+ 5.00	0.00	— 5.00	—8.66
2	+10.00	+8.66	+ 5.00	0.00	— 5.00	—8.66
3	+10.00	+8.66	+ 5.00	0.00	— 5.00	—8.66
4	+10.00	+8.66	+ 5.00	0.00	— 5.00	—8.66
5	— 5.00	—8.66	—10.00	—8.66	— 5.00	0.00
6	— 5.00	—8.66	—10.00	—8.66	— 5.00	0.00
7	— 5.00	—8.66	—10.00	—8.66	— 5.00	0.00
8	— 5.00	—8.66	—10.00	—8.66	— 5.00	0.00
9	— 5.00	0.00	+ 5.00	+8.66	+10.00	+8.66
10	— 5.00	0.00	+ 5.00	+8.66	+10.00	+8.66
11	— 5.00	0.00	+ 5.00	+8.66	+10.00	+8.66
12	— 5.00	0.00	+ 5.00	+8.66	+10.00	+8.66

primary frequency, when the rotor is stationary, the effect will be exactly the same as was previously found when the current at the same frequency was supplied to the secondary of the ordinary induction motor with stationary rotor; that is, by adjustment of secondary current, the wattless component of the primary current may be made to disappear. If, however, the rotor be given a certain speed, the same current in the secondary will continue to produce the same magnetizing effect as at standstill, for at each instant the commutator will cause the current to traverse conductors occupying the same position

in space, and the effect of the secondary current upon the primary core magnetism will not be altered.

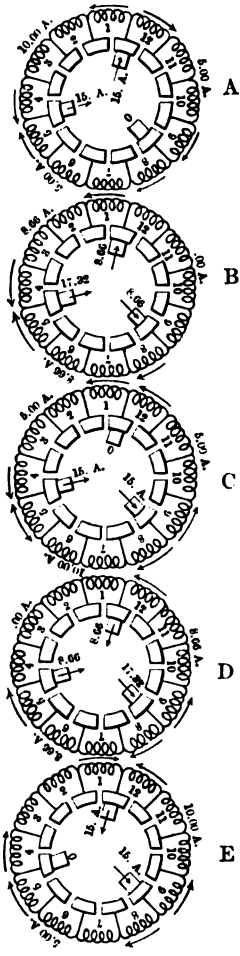

FIG. 19.—Currents for Stationary Armature.

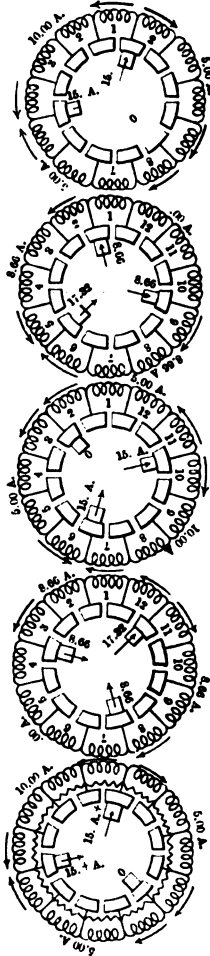

FIG. 20.—Currents for Armature at Synchronous Speed.

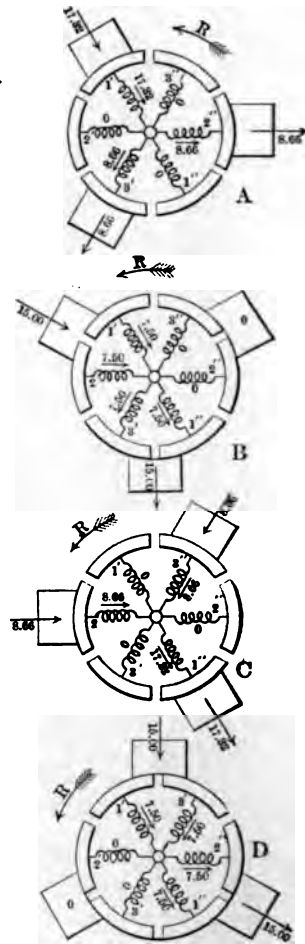

FIG. 21.—Currents in Double-wound Armature.

Fig. 19 represents such symmetrical armature winding upon the commutator of which are placed three brushes for the introduction of three-phase current for excitation. The in-

stantaneous values of the current in the individual coils as the current in the three-phase leads changes value are indicated for each 30 degrees increment of time in the several diagrams of Fig. 19, and collectively recorded in Table I. The rotor is here assumed to be stationary. It will be observed that throughout each cycle the current in each coil undergoes a double reversal and reaches full normal value in both positive and negative directions. The reactive e.m.f. induced in the windings, which is proportional to the rate of change of the local flux surrounding the conductor due to the current flowing therein, is therefore

TABLE II.—Instantaneous values of currents in each coil of direct-current winding; three-phase excitation; synchronous speed. (Fig. 19.)

Number of coil.	A	B	C	D	E	F
1	+10.00	0.00	+5.00	+8.66	+10.00	0.00
2	+10.00	+8.66	+5.00	+8.66	+10.00	+8.66
3	+10.00	+8.66	+5.00	+8.66	+10.00	+8.66
4	+10.00	+8.66	+5.00	0.00	+10.00	+8.66
5	-5.00	+8.66	+5.00	0.00	-5.00	+8.66
6	-5.00	-8.66	+5.00	0.00	-5.00	-8.66
7	-5.00	-8.66	-10.00	0.00	-5.00	-8.66
8	-5.00	-8.66	-10.00	-8.66	-5.00	-8.66
9	-5.00	-8.66	-10.00	-8.66	-5.00	-8.66
10	-5.00	0.00	-10.00	-8.66	-5.00	0.00
11	-5.00	0.00	+5.00	-8.66	-5.00	0.00
12	-5.00	0.00	+5.00	+8.66	-5.00	0.00

of a value corresponding to the primary frequency, and there is required for the excitation a wattless component of e.m.f. equal to that which would have been required had the exciting current been allowed to flow in the primary windings.

ACTION WITH ROTOR AT SYNCHRONOUS SPEED.

When the rotor is traveling at a speed approximately synchronism the exciting current required in the secondary windings is of the same value as before, but the requisite wattless component is much reduced because of the decrease in the reactive

e.m.f. of the secondary windings. With an infinite number of commutator segments and of phases for the exciting current in the secondary, the reactive e.m.f. would entirely disappear at synchronous speed, and it would increase directly with the rotor slip. Fig. 20 indicates the changes in the value of the secondary current in the individual coils with three-phase excitation, when the rotor is traveling at synchronous speed. For the sake of clearness the windings are considered stationary and the brushes are supposed to revolve at synchronous speed, the effect being the same as with stationary brushes and revolving windings, of course.

A glance at Table II will show that the fluctuations in the current in the individual coils are much reduced at synchronous speed, and consequently the flux around the conductors, to the rate of change of which is due the reactive e.m.f., has a much more nearly constant value than when the secondary is stationary, and thus the necessary wattless component for secondary excitation is correspondingly diminished.

The value of the e.m.f. for excitation will depend upon the number of and resistance of the secondary conductors and upon the reactive e.m.f., and will in general be much below that required for the primary windings. It can conveniently be obtained by transformation from the supply circuit. An increase in the excitation e.m.f. above normal value will cause the primary to draw leading currents, the value of which may be adjusted to equal the lagging current demanded by the primary of the excitation transformers, so that the motor and transformers considered as a unit may be operated at unity power factor.

FUNCTION OF THE CONNECTING RESISTANCES.

In order that the rotor shall be drawn into rotation by the revolving field, it is necessary that the secondary circuit be closed. This is accomplished by connecting resistance between the adjacent commutator segments, as indicated at position *E* of Fig. 20. Since the current induced in the secondary, due to the slip of the conductors relative to the revolving field, must pass through these resistance coils, which are, in fact, in series with the secondary windings of the machine considered as an induction motor, it is desirable to make the resistance as low

as possible, for the slip due to any given torque and the secondary loss due to a given current depend directly on the total resistance of the secondary circuit. But on account of the fact that these resistances form a parallel path for the exciting current from the lowering transformers, it is desirable, in order to decrease the shunt loss, that the resistance be large. The resistance is, therefore, given a value large in comparison with

TABLE III.—Instantaneous values of currents in each slot; three-phase winding; three-phase excitation; synchronous speed. (Fig. 20.)

Sections of coils in slots 1, 2 and 3.	A	B	C	D	E	F	
	1'	17.32	7.50	0.00	7.50	17.32	7.50
1"	0.00	7.50	17.32	7.50	0.00	7.50	
2'	0.00	7.50	8.66	0.00	0.00	7.50	
2"	8.66	0.00	0.00	7.50	8.66	0.00	
3'	8.66	7.50	0.00	0.00	8.66	7.50	
3"	0.00	0.00	8.66	7.50	0.00	0.00	
Coils in slots 1, 2 and 3.							
	1	17.32	15.00	17.32	15.00	17.32	15.00
	2	8.66	7.50	8.66	7.50	8.66	7.50
	3	8.66	7.50	8.66	7.50	8.66	7.50

that of the armature winding, but small enough not to increase unduly the total secondary resistance.

The resistance forms a non-inductive shunt to the inductive windings of the armature, and thus serves the very advantageous purpose of suppressing any sparking at the excitation brushes; which fact allows the use of copper brushes of cross-section much less than that required for carbon brushes and the commutator is given a correspondingly smaller size. So effective is the elimination of sparking that no observable result is produced by shifting the brushes into any position.

DOUBLE THREE-PHASE SECONDARY WINDING.

In order to reduce the reactive e.m.f. of the secondary below that value which it is possible to obtain with the direct-current winding, there has been developed a double, semi-parallel connected three-phase winding which possesses many advantages. This winding is diagrammatically represented in Fig. 21, which indicates also the changes in value of the secondary current when the rotor (brush) is traveling at synchronous speed. The winding is connected double star fashion. Coils 1' and 1" lie in the same slots; coils 2' and 2" lie in the same slots, and the same is true of coils 3' and 3". The object of this arrangement is to maintain as nearly constant as possible the local flux surrounding each individual conductor, and thereby reduce as far as possible the reactive e.m.f. The flux encircling a slot depends upon the current flowing through the slot, but it is not altered by a change of the current from one conductor to another in the same slot. By the present arrangement, when the current in one conductor occupying a certain slot has its zero value the other conductor carries its maximum current, and, as Table III shows, the actual current which causes local flux around the separate coils undergoes but slight variation in value. The reactive e.m.f. is, therefore, quite small, and the secondary wattless component is much reduced, so that the exciting transformers may be of small capacity and operated at high-power factor; moreover, a relatively slight increase in e.m.f. at the excitation brushes causes the leading current in the primary windings of the motor to compensate for the lagging current in the transformers, giving to the machine, as a whole, a power factor of unity. By adjusting the degree of over-excitation at no-load and shifting the secondary brushes the requisite amount in the proper direction, the compensation may be made such as to hold the power factor at practically unity at all loads within the operating range of the motor.

The three-phase winding allows of the introduction of resistance in the secondary windings by means of slip rings connected at the center of the "star," and the starting torque or operating speed can thus conveniently be varied at will.

On account of the reduction in the effective secondary reactance and the elimination of the wattless current component in

the primary windings, the compensated induction motor may be given a much greater load than the corresponding motor without compensation, while the ability to supply even an enormously increased magnetomotive force for excitation allows the compensated motor to be given a larger ratio of current-conductor material to magnetic material, especially upon the secondary, in which the iron loss in any case is relatively small. Consequently, by the use of the specially-wound secondary with commutator and transformers, the capacity of a given induction motor may be much increased, or, and for the same reasons, an induction motor of a given capacity may thus be constructed at a proportionately less cost.

It is scarcely probable that the mere elimination of the wattless current component from the circuit wires would prove sufficient inducement to a consumer to justify the extra expense of adding a commutator and the accompanying complications to the one piece of reliable machinery, the simplicity of which has previously been the characteristic that led most rapidly to its adoption in preference to commutator motors. The ability of manufacturers to produce at a reduced cost motors giving satisfactory service to the purchaser can alone cause the compensated motor to compete successfully with its highly efficient and, above all, simple rival.

CHAPTER VI.

THE SINGLE-PHASE INDUCTION MOTOR.

OUTLINE OF CHARACTERISTIC FEATURES.

While under no condition is the single-phase motor more satisfactory or economical than the polyphase machine, yet, by a little care in the selection of a motor for the service required, the performance of the single-phase machine may compare quite favorably with that of the polyphase type. The most prominent difference between the single-phase and the polyphase motor is the inability of the former to exert a torque at standstill. Numerous devices have been applied to render single-phase motors self-starting, which have met with varying success. A difficulty which the designer has had to encounter lies in the fact that, with few exceptions, such devices are applicable only to motors of small sizes, or where efficiency is of small moment. Little trouble is experienced in designing self-starting single-phase motors for meter or fan work, but the problem assumes a different aspect when motors for power purposes are desired.

In what follows, an attempt will be made to outline the characteristic features of the single-phase induction motor, to ascertain the similarities and the differences between the performance of a single-phase and that of a polyphase machine, and to investigate the methods by which the single-phase motor may be operated under various conditions. The graphical representation of the phenomena of the single-phase motor is reserved for a subsequent chapter.

Although supplied with current, which, if acting alone, could produce only a simple alternating magnetism, in contradistinction to a rotating field, it is found that a single-phase motor under operating conditions develops a rotating field essentially the same as would be obtained were the machine operated on a polyphase circuit. The effect of the mechanical

motion of the secondary in producing the rotating field may be determined as follows:

PRODUCTION OF QUADRATURE MAGNETISM.

Assume for the purpose of illustration a motor with four mechanical poles having the two opposite poles excited by a single-phase alternating current, and consider the moment when one of these poles is at a maximum north and the other a maximum south, as shown in Fig. 22. If the rotor be moving across this field in the direction indicated, there will be generated in each of the conductors under the poles an e.m.f. proportional to the product of the field magnetism and speed of

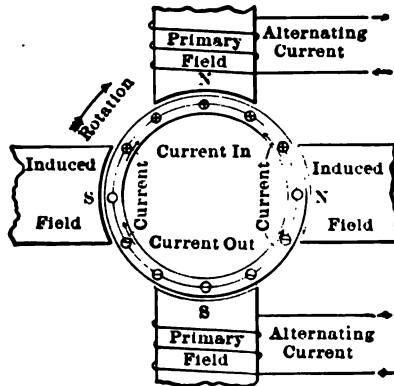

FIG. 22.—Production of Quadrature Magnetism.

rotor. Evidently if the speed be constant, of whatsoever value, this e.m.f. will vary directly with the strength of magnetism; that is, it will be maximum when the magnetism is maximum, and zero at zero magnetism. Other conditions remaining the same, the maximum value of the secondary e.m.f. will vary directly with the speed of the rotor.

If the circuits of the rotor conductors be closed, there will tend to flow therein currents of strengths depending directly upon the e.m.fs. generated in the conductors at that instant and inversely upon the impedance of the rotor conductors. The somewhat unique condition of e.m.fs. in a combined series and parallel circuit, which exists in the rotor as here described, is depicted by analogy in Fig. 23, where the e.m.f. in each conductor

across the rotor core is represented by a battery. The absolute value of each e.m.f. depends upon the strength of the primary field and the position of the conductor in that field, and hence changes from instant to instant. The current which flows through the end rings changes its direction of flow with reference to the field poles once for each reversal of the primary magnetism.

The current which flows through the rotor circuits at once produces a magnetic flux which, by its rate of change in value generates in the rotor conductors a counter e.m.f., opposing the e.m.f. that causes the current to flow, and of such a value that the difference between it and this e.m.f. is just sufficient to cause to flow through the impedance of the conductors a current whose magnetomotive force equals that necessary to drive the

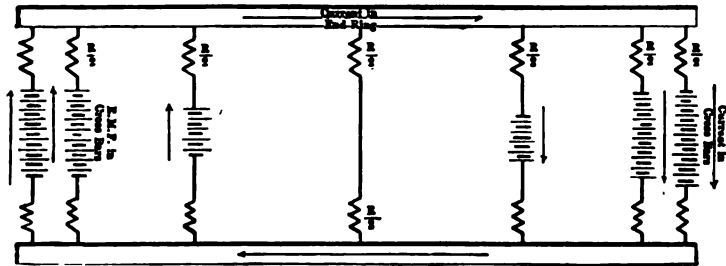

FIG. 23.—Current and e.m.f. in Squirrel-cage Secondary.

required lines of magnetism through the reluctance of their paths. Since this latter magnetism must have a rate of change equal (approximately) to the e.m.f. generated in the rotor conductors by their motion across the primary field, and since this e.m.f. is in time-phase with the primary field, it follows that this magnetism must have a value proportional to the rate of change of the primary magnetism, and, if the primary magnetism follows a sine curve of values, this magnetism must follow the corresponding cosine curve; that is, it must be in quadrature to the primary magnetism as to time phase.

Consider the "N" pole due to primary magnetism at its maximum strength, and decreasing in value. The e.m.f. generated in the rotor will tend to send lines of force at right angles to the primary field, inducing a secondary N pole at the right (see Fig. 22). The lines of secondary magnetism (induced field)

continue to increase in number so long as the primary magnetism does not change *direction* of flow. They, therefore, reach their maximum value when the primary magnetism dies down to zero, at which instant the induced or secondary magnetism will have its maximum strength with the north pole to the right, as drawn.

As the primary magnetism now shifts its north pole to the bottom, the secondary lines begin to decrease in number, and they will reach their zero value when the primary magnetism reaches its maximum strength. The induced magnetism will then begin to increase its lines in the reverse direction, producing a north pole to the left, and it will reach its maximum strength when the primary magnetism dies down to zero again. When the primary magnetism shifts its north pole back to the top, the secondary magnetism will begin to decrease, then finally build up with its north pole to the right again, and so on.

The north magnetic poles produced on the motor thus reach their maximum in the following order: top, right, bottom, left, etc., or in the direction of rotation. Further consideration will show that, had the rotation been taken in the opposite direction, the poles would have traveled in the opposite direction also.

It must be remembered that the simultaneous existence of magnetic fluxes at right angles in the same material is entirely imaginary. The effect of each is, however, real and the existence of the resultant is real.

PRODUCTION OF REVOLVING FIELD.

When the rotor is traveling at synchronous speed, the e.m.f. generated in the secondary conductors by their motion across the primary magnetism is of such a value as to require the induced field (quadrature magnetism) to be equal in effective value to the primary field. If the maximum value of the primary field be taken as unity and time be denoted in angular degrees, then the instantaneous value of the primary magnetism may be represented by $\cos. a$, where a measures the angle of time from the instant of maximum primary magnetism. In a similar manner $\sin. a$ may represent the instantaneous value of the quadrature magnetism.

These two fields are located mechanically 90 degrees from

each other. Fig. 24 indicates the manner in which the fluxes of the two fields vary from instant to instant, and the position of the resultant core magnetism at each instant, a two-pole motor, with a ring-shaped core without projecting poles, being assumed.

$\overline{OB} = \overline{OC} \cos. \alpha$ = value and position of primary magnetism after the time lapse α .

$\overline{OA} = \overline{OC} \sin. \alpha$ = value and position of induced magnetism at same instant.

$\overline{OC} = \sqrt{\overline{OB}^2 + \overline{OA}^2}$ represents the resultant field, both in value and position. The point P describes a circle. Without further proof it is evident that, neglecting the effect of local

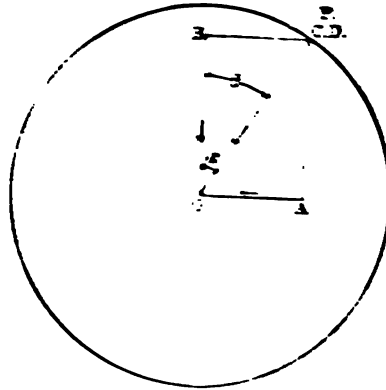

FIG. 24.—Circular Revolving Field.

impedance in the secondary circuit, there is produced a revolving field of constant intensity when the rotor revolves at synchronous speed.

ELLIPTICAL REVOLVING FIELD.

When the rotor speed is not truly synchronous, the extremity of the vector OP , which represents the value and position of the resultant field, describes an ellipse. For any given effective value of primary field magnetism, the effective value of the induced field magnetism depends directly upon the speed as mentioned above. Let S represent the speed with synchronism as unity, then, if $\cos. a$ represents the instantaneous value of the primary magnetism, $S \times \sin. a$ equals the instantaneous value of the induced magnetism.

Referring now to Fig. 25, after any time lapse, α .

$\overline{OB} = \overline{OC} \cos. \alpha$ represents the instantaneous value of the primary magnetism.

$\overline{OA} = S \times \overline{OC} \sin. \alpha$ represents the value of the secondary magnetism, while

$\overline{OP} = \sqrt{\overline{OB}^2 + \overline{OA}^2}$ represents the value and position of the resultant magnetism.

Since, from the figure, the distance BP bears a constant ratio of S to distance BC , the locus of the curve described by the point P is an ellipse.

The vertical axis of this ellipse is determined by the primary field, while the horizontal depends upon the speed. Above

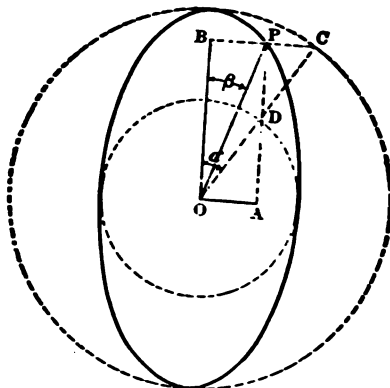

Fig. 25.—Elliptical Revolving Field.

synchronism the figure remains an ellipse, having its major axis along the induced field line. At synchronism the ellipse becomes a circle, as noted above. At zero speed the ellipse is a straight line, which means that at standstill there is no quadrature flux and hence no revolving field. Below zero speed, that is, with reversed rotation, the curve is yet an ellipse, the side which was previously to the right being transferred to the left and *vice versa*.

STARTING TORQUE OF THE SINGLE-PHASE MOTOR.

For the above reasons, the single-phase induction motor has inherently no starting torque whatever, but will accelerate almost to synchronism if given an initial speed in either direc-

tion, and, when the torque is not too great, will operate in a manner quite similar to that of a polyphase induction motor.

Due to the existence of the quadrature flux, to produce which magnetomotive force must be supplied by current in the primary windings, at synchronism the magnetizing current for a single-phase motor is twice as great per phase as is the case when the same machine is properly wound and operated on a two-phase circuit of the same e.m.f.; but the total number of exciting ampere-turns is the same in the one case as in the other. A difference in the performance of a single-phase from that of a polyphase motor is found in the existence at no load of considerable current in the secondary with the former, while the rotor current is practically negligible with the latter. These facts will be discussed more fully in a subsequent chapter.

USE OF "SHADING COILS."

The most serious defect in the behavior of single-phase motors is in connection with their lack of starting torque, to remedy which many ingenious devices have been developed. A simple method of producing the requisite quadrature magnetic flux for the purpose of giving a single-phase induction motor a starting torque is found in the use of "shading coils," which are extensively employed in alternating-current fan motors. Each coil consists of a low resistance conductor surrounding a portion of a field pole. As ordinarily applied, there is cut in each pole a slot parallel to the shaft of the rotor. In this slot is placed the conductor, which is connected by a closed path of high conductivity around a portion of the pole included between the slot and the side of the pole, as shown in Fig. 26. The coil of each pole is placed similarly to that of the other poles, and, as explained below, the secondary revolves in the direction from that portion of a pole not surrounded by a coil towards the "shaded" side of the pole.

The action of the shading coils is as follows, reference being had to Fig. 26: Consider the field poles to be energized by single-phase current, and assume the current to be flowing in a direction to make a north pole at the top. Consider the poles to be just at the point of forming. Lines of force will tend to pass downward through the shading coil and the remainder of the pole. Any change of lines within the shading coil gen-

erates an e.m.f., which causes to flow through the coil a current of a value depending on the e.m.f. and always in a direction to oppose the change of lines. The field flux is, therefore, partly shifted to the free portion of the pole, while the accumulation of lines through the shading coil is retarded. However, so long as the magnetomotive force of the field current is of sufficient strength and in the proper direction, the lines through the shading coil increase in number, although the increase is retarded, which is to say, that, even after the lines in the other part of the pole begin to decrease in number, the

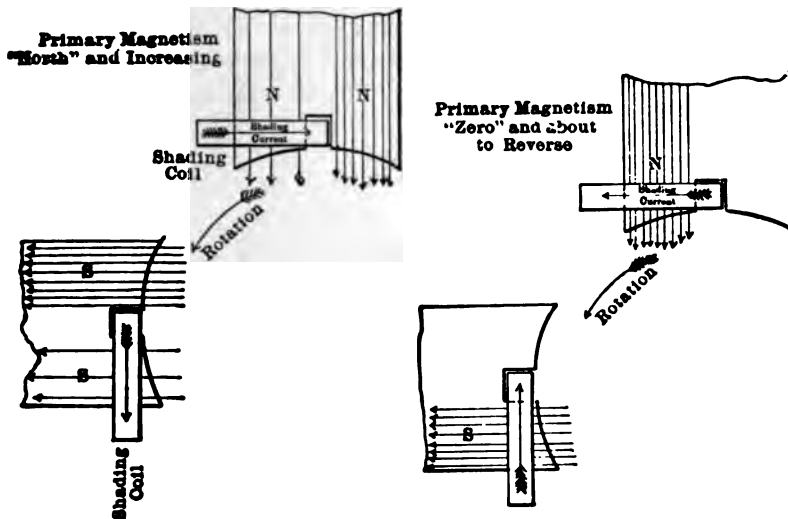

FIGS. 26 and 27.—Action of Shading Coils.

flux within the shading coil is increasing and continues to increase till the exciting current drops to a strength just sufficient to maintain that density of flux which is within the coil. At this instant the flux in the shading coil has its maximum value as a north magnetic pole.

As the flux on the other portion of the pole continues to decrease, the lines within the shading coil tend to decrease also, but the e.m.f. generated by their rate of change causes to flow a current which tends to prevent any change of lines, so that when the other portion of the pole contains no lines whatever there is yet within the shading coil an appreciable amount of

from forming a south magnetic pole as indicated by Fig. 27, the result being a shifting of the field from the unshaded to the shaded side of each pole. This is repeated when the magnetic reverses. The time when the shading coil decrease, with an increasing rate of change and a condition of zero time when the coil is soon reached. At this instant, there is a south magnetic pole at the "unshaded" end of the top field pole and a north magnetic pole at the "unshaded" end of the bottom field pole, and south and north magnetic poles being immediately formed within the corresponding shading coils.

Looking back over the process of formation of the magnetic poles, it is seen that north poles have occupied successively the following positions: top "unshaded," top total, top "shaded," side "unshaded," side total, etc. In more simple, the north pole through which a strength has travelled in a counter clockwise direction. This process is continuous, and results in a truly rotating field. A motor placed in this field is drawn into rotation as though the primary had been properly wound and connected to an instantaneous polyphase circuit. This method cannot be satisfactorily and economically applied to motors of large sizes.

USE OF COMMUTATOR IN THE MOTOR.

A simple method of applying a commutator to induction motors for starting purposes is to utilize current produced in the armature by the alternating flux from the field. In the application of this method the motor is provided with a winding similar to that of a direct-current armature, connected to a commutator in a manner very similar to that commonly employed with direct-current machinery. Due to facts discussed below, current which flows through the armature, by way of suitably connected brushes, gives to the rotor sufficient torque to bring it under full load to a pre-determined speed at which a mechanism operated by centrifugal force causes a short-circuiting device to inter-connect all the segments of the commutator, and thus to convert the armature into virtually a squirrel-cage rotor.

The function of the commutator in the production of the starting torque may be determined by reference to Fig. 28. Consider a closed coil armature supplied with a commutator to be situated at rest between two poles of a motor, which poles

are excited with alternating current, as indicated in the drawing. There will be generated in each coil of the armature an alternating e.m.f. of a value depending upon the rate at which that coil is cut by the alternating field flux. The coils which lie in a horizontal plane will be cut by the maximum flux, while those in the vertical plane will be cut by the minimum flux, which minimum will be zero when the plane becomes truly vertical. Though all the coils are connected in a continuous circuit, no current will flow in the armature, since the e.m.f. on one side

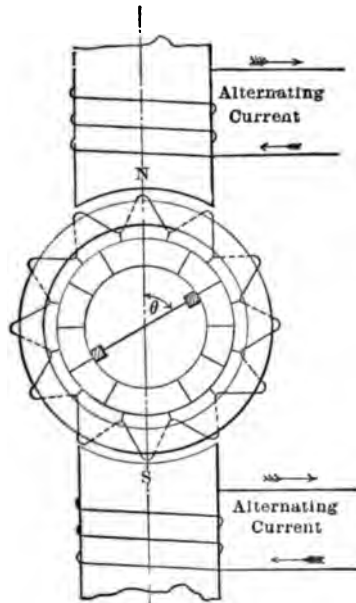

FIG. 28.—Production of Starting Torque.

is equal to that on the other, and the two sides are in series. The maximum e.m.f. will exist between a top and a bottom armature coil, or between opposite commutator segments, which lie in the vertical plane.

Let E represent the effective value of this maximum e.m.f., then $E \cos. \theta$ will represent the value of the e.m.f. between opposite commutator segments occupying a plane forming an angle of θ degrees with the vertical.

Consider two opposite commutator segments to be connected together externally by a conductor and appropriate brushes,

and represent the impedance of the armature and the external circuit by Z . Then a current will flow through this circuit, which current may be represented in value at any given position of the brushes by

$$I = \frac{E \cos. \theta}{Z}.$$

This current will be a maximum when the brushes occupy the vertical plane, and a minimum when they are in the horizontal plane.

Referring again to Fig. 28, and remembering that a conductor carrying a current in a magnetic field experiences a torque which is proportional to the product of the current, the field and the cosine of the angle between them, it will be seen that, for a given current in the armature, the maximum torque would be exerted when the brushes are in the horizontal plane, and that the armature will experience no torque whatever when the brushes are in the vertical plane. It is to be noted, however, that when the brushes are in the horizontal plane no current will be produced in the brush circuit, and, therefore, the torque is zero. In any intermediate position the current in the brush circuit gives a certain torque.

Obviously, when the current and flux reverse together the torque continues to be exerted in one direction and the rotor is given the desired initial speed previous to being converted to a squirrel cage rotor, as stated above.

Single-phase motors equipped with starting devices of this nature give satisfactory results as to simplicity of operating circuits, efficiency of performance and reliability of service quite comparable to those obtained with polyphase motors. This type of machine in its starting condition is frequently referred to as a "repulsion" motor. The repulsion motor is treated at great length both graphically and algebraically in subsequent chapters.

POLYPHASE INDUCTION MOTORS USED AS SINGLE-PHASE MACHINES.

Induction motors are frequently started up from rest on single-phase circuits by operating them as so-called "split-phase" machines. Commercially considered, a split-phase motor is a polyphase machine, the current in the separate phases being

obtained at different lag angles from a single-phase circuit, so that a starting torque is produced at the rotor.

A two-phase induction motor may be brought up to speed on a single-phase circuit by connecting the windings of both phases to the circuit, one directly and the other through a suitably chosen resistance or condensance, as shown in Fig. 29. The current through the circuit containing the resistance will

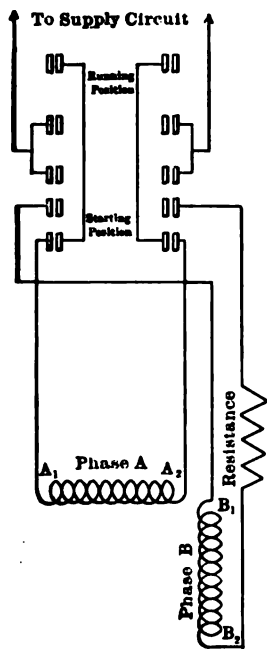

FIG. 29.—Circuits of (Two-phase) Single-phase Motor.

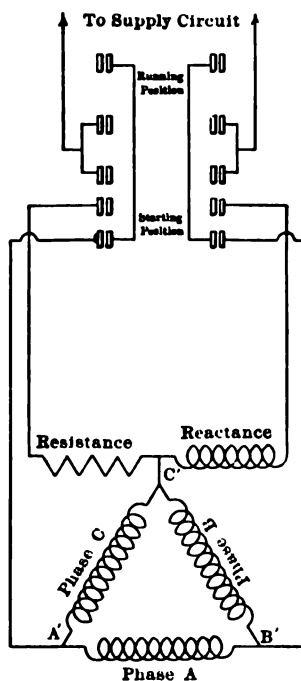

FIG. 30.—Circuits of (Three-phase) Single-phase Motor.

alternate more nearly in unison with the impressed e.m.f. than that in the other, and it will possess a component in quadrature to the current in the other circuit, which component will produce the desired quadrature flux. The elliptical revolving field thus produced will give a torque which will start the motor up from rest, if the load be not too great. When about half speed has been attained the circuit through the resistance is cut out and the motor operates as a single-phase machine.

Under the conditions of operations, it will be found that there

is generated in the inactive phase winding an e.m.f. equal (for negligible secondary impedance) to the counter e.m.f. of mechanical motion in the active phase winding, and that this e.m.f. is almost in quadrature in time-position with the supply e.m.f. The lack of exact quadrature is due to the lag of the counter e.m.f. of rotation in the active coil behind the impressed e.m.f. and to some extent to the further lag of the secondary exciting current behind this e.m.f., and the sign of the angle of dis-

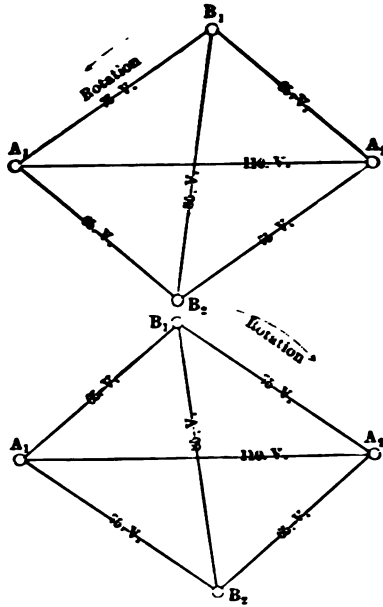

FIG. 31.—Diagram of Two-phase e.m.f.'s.

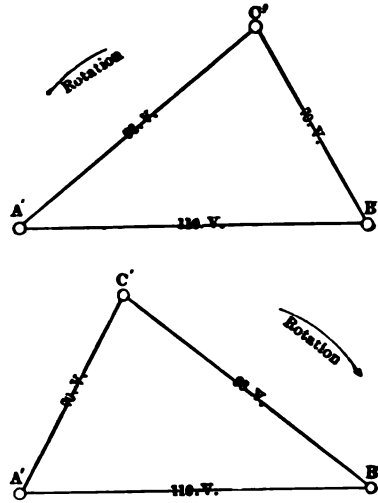

FIG. 32.—Diagram of Three-phase e.m.f.'s.

placement from 90° depends upon the direction of rotation of the motor secondary. Fig. 31 shows the relative value and position of this tertiary e.m.f. for a two-phase motor running single-phase, while Fig. 32 indicates equivalent results for a three-phase motor on a single-phase circuit.

By combining the e.m.f. of the inactive winding of a two-phase motor with that of the supply circuit, there is available an almost symmetrical two-phase circuit, from which may be started at once, without auxiliary apparatus, any similar two-phase, or, by a few slight changes, any three-phase induction

motor. The draught of current from the inactive phase winding will have very little effect upon the operation of the first motor. By this method it is possible to dispense with auxiliary starting apparatus for all motors of any given installation, with the exception of one, and, with properly arranged circuits, two-phase motors may in this manner be started up with a fair operating torque.

A three-phase induction motor may be operated from a single-phase circuit by connecting two leads from the motor directly to the supply circuit and joining the third to an auxiliary starting circuit, formed by placing a resistance and a reactance in series across the supply circuit, as indicated by Fig. 30.

The effect of placing the resistance and reactance in series

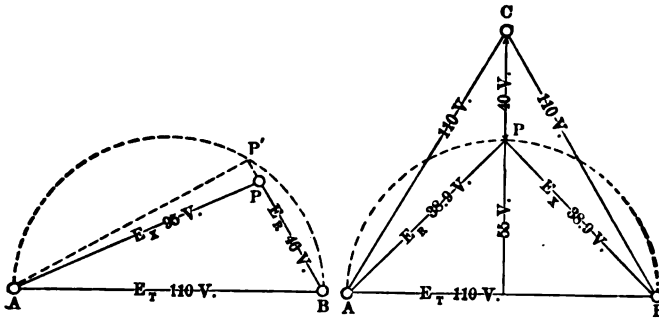

Figs. 33 and 34.—Vector Diagram of Electromotive Forces.

is to displace the relative potential of the point where the two join, from a line connecting the extremities of the two, as shown in Fig. 33. For a true reactance the locus of this point, with varying resistance, is the arc of a circle, as indicated by Fig. 34, and the maximum displacement occurs when the resistance and reactance are equal. Under this condition the displacement (when no current is being taken off at P) will be $.5 E_T$, or one-half the line voltage. For a true three-phase circuit, the displacement should be

$$\frac{\sqrt{3}}{2} E_T = .866 E_T.$$

It is clear, therefore, that this method cannot possibly give e.m.fs. in true three-phase relation. It is found, however, that the

displacement obtained is adequate for starting motors of moderate sizes.

The use of condensance, instead of inductance, offers some advantages, since by properly proportioning the condensance, the leading current demanded may be adjusted to equality with the lagging exciting current during operation and, theoretically, a power factor of unity may be obtained. The disturbing influence of change of frequency, the compensating disadvantages due to presence of higher harmonics from the distortion of the e.m.f. wave from a true sine curve of time-value, and the practical necessity of operating condensers at high voltage, coupled with the lack of satisfactory commercial condensers in convenient form, have limited the application of this method.

CHAPTER VII.

GRAPHICAL TREATMENT OF INDUCTION MOTOR PHENOMENA.

ADVANTAGE OF GRAPHICAL METHODS.

With almost no exception, the graphical method of treatment of electrical phenomena does not produce results as accurate as the analytical; yet, for many purposes where a fine degree of accuracy is not required, the ease of manipulating has led to the extensive use of the graphical method, approximate results being first rapidly determined, after which if greater accuracy is desired, the analytical method may be used. In cases where only qualitative results are desired, but where some knowledge of the effect of change in the different variables connected with the phenomena is important, the graphical method, because of its simplicity, readily lends itself to the quick determination of results sufficiently accurate for the needs of the case.

Before discussing the graphical diagram for the representation of the value and phase of primary and secondary currents of an induction motor, it is well to establish the similarity between an induction motor and a static transformer.

EFFECT OF INSERTING RESISTANCE IN THE SECONDARY.

At any value of field magnetism, the effect of inserting resistance in the secondary of an induction motor, for a given value of secondary current, is to vary the slip directly with the total secondary resistance without affecting either the torque or the power-factor.

As proof of this fact, let E_2 = the c.m.f. which would be generated in the secondary at 100 per cent. slip, at the given field magnetism.

s = slip, with synchronism as unity,

R_2 = secondary resistance,

X_2 = secondary reactance at 100 per cent. slip (standstill; $s = 1$)

I_2 = secondary current.

Then

$$I_2 = \frac{s E_2}{\sqrt{R_2^2 + s^2 X_2^2}} \text{ or } I_2^2 = \frac{s^2 E_2^2}{R_2^2 + s^2 X_2^2}$$

or, since I_2 and E_2 are constant for the chosen condition of service,

$$K^2 = \frac{s^2}{R_2^2 + s^2 X_2^2}$$

$$s^2 = \left(\frac{K^2}{1 - K^2 X_2^2} \right) R_2^2 = a^2 R_2^2$$

or the slip is directly proportional to the secondary resistance. The secondary power-factor, $\cos. \theta =$

$$\frac{R_2}{\sqrt{R_2^2 + s^2 X_2^2}} =$$

$$\frac{R_2}{\sqrt{R_2^2 \sqrt{1 + a^2 X_2^2}}} = \frac{1}{\sqrt{1 + a^2 X_2^2}}$$

or the secondary power-factor is independent of the secondary resistance.

The total secondary power is $I_2 E_2 \cos. \theta$, and is independent of the secondary resistance, while the torque, which is $7.04 \frac{I_2 E_2 p_2}{\text{syn. speed}}$, is also independent of the secondary resistance.

Since the effect of inserting resistance in the secondary circuit is merely to increase the slip without altering the other qualities, it follows that by using suitable selected resistances, the slip can be made unity for any value of secondary current at the corresponding power-factor. In consequence of this fact, the performance of the secondary will be faithfully represented if all the power received from the primary be considered as dissipated in resistance in the secondary circuit, the slip at all times being taken as unity and the total secondary resistance (conductance) being assumed to be varied according to the secondary load, or briefly, the induction motor may be treated in all respects like a stationary transformer. The determination of the slip, torque, etc., of the motor under operating conditions will be discussed later.

PRIMARY AND SECONDARY CURRENT LOCUS.

Perhaps, of all the graphical diagrams which have been suggested at various times to represent the performance of an induction motor, the simplest, and at the same time the most complete, is that showing the value and phase of the primary and secondary currents. The quantities intended to be represented by this diagram can best be ascertained by investigating the method of determining the points on the current locus, such as is shown in Fig. 35, which is plotted according to the following instructions:

Use the vertical scale (at a certain number of amperes per

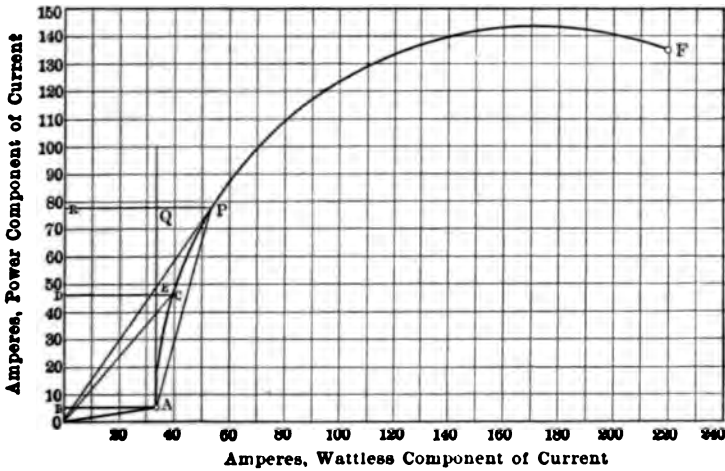

FIG. 35.—Primary and Secondary Current Locus.

inch) to plot values of the power component of the currents ($I \cos. \theta$), and the horizontal scale (at the same number of amperes per inch) to plot the wattless component of the currents ($I \sin \theta$).

From the origin O , lay off a distance OB equal to the power component of the primary current at no load, and from the point B draw the horizontal line BA with a value equal to that of the wattless component of the primary current at no load. The line OA represents the no load primary current, while the angle AOB is the primary angle of lag at no load. In a similar manner, selecting any load current, as OC , lay off

the power and wattless components OD and DC . The angle of lag at this load is represented by the angle COR . Following out the same method, locate a number of points corresponding to the points A and C , and draw a smooth curve through them. At any point on this curve, as P ,

OP	represents the	primary current,
PR	"	" wattless component of the primary current.
OR	"	" power component of the primary current,
POR	"	" primary angle of lag,
PQ	"	" wattless component of the secondary current.
AQ	"	" power component of the secondary current
AP	"	" secondary current,
PAG	"	" secondary angle of lag.

The proof of the representation of the secondary quantities is as follows: When running under load, BR equals the increase in the power component of the primary current over its no load value. As in a transformer, this increase is due to the flow of current in the secondary, and being in phase (opposition) to the power component of the secondary current, is a direct measure of its value. A similar course of reasoning holds for the wattless component PQ . Hence AP represents the secondary current both in value and phase position.

An inspection of the diagram will show that the maximum secondary power factor occurs at no load, while the maximum primary power factor occurs at that load which causes the line OP to become tangent to the curve $ACPF$. Since the no load losses are equal to the product of OB by the primary e.m.f., and the secondary current, primary current and power factor can be obtained directly from the curve for any value of primary load, it follows that if the primary and secondary resistances be known, the input losses, output, efficiency, slip, speed, power-factor, apparent efficiency, and torque can easily be determined when the curve $ACPF$ is located.

TEST RESULTS.

The accompanying table records results of calculations made for a 10-h.p., two-phase, 220-volt induction motor, use being made of Fig. 35, which has been constructed in part from data obtained with this machine. Results found in the table have been plotted

PRIMARY RESISTANCE PER PHASE = .48 OHMS.				SEC. RES. PER PHASE = .5 OHMS.						SEC. RES. PER PHASE = 3.0 OHMS.							
(1)	(2)	(3)	(4)	(5)	(6)	(7)	(8)	(9)	(10)	(11)	(12)	(13)	(14)	(15)	(16)	(17)	(18)
FROM CURVE, Fig. 35.			(1)	(2)	(1)	(2) ²	(6) + 856	(5)-(7)	(8)	(10)	(11)	(12)	(13)	(14)	(15)	(16)	(17)
Power component of primary current.	Total primary current.	Total secondary current.	Power-factor.	Watts.	Watts.	Watts.	Watts.	Pounds.	Watts.	Watts.	Per cent. synchro.	Watts.	Per cent.	Motor output.	Motor efficiency.	Per cent.	Motor output.
(1)	(2)	(3)	(4)	(5)	(6)	(7)	(8)	(9)	(10)	(11)	(12)	(13)	(14)	(15)	(16)	(17)	(18)
5.1	33.3	00	1.53	1122	266	1122	00000	00	00	0000	100	0000	0000	0000	00	0000	0000
10	35	00	1.9	2300	294	1150	10500	6.16	6	406	99.4	3105	3105	1014	46.2	333	36
20	40	14.9	5.00	4400	384	1240	31600	18.52	55	1017	98.3	6058	6058	2827	46.2	833	36
30	47	25	6.38	6600	530	1386	72100	30.9	156	1530	97.8	8913	8913	4277	64.3	1836	87
40	55	35	7.78	8800	725	1581	91440	42.3	306	2042	95.8	12229	12229	5383	64.3	3170	183
50	64	46	9.17	11000	1000	1856	110120	53.8	528	2858	92.9	16611	16611	5974	64.3	4700	3170
60	74	56	10.56	13200	1332	2188	127840	64.9	783	3971	92.9	22963	22963	6044	82.8	6740	4700
70	85	67	11.95	15400	1760	2616	144840	74.9	1123	5488	91.2	31963	31963	6312	82.8	9126	6740
80	97	78	13.34	17600	2260	3116	160640	84.8	1521	8088	89.5	44064	44064	6588	82.8	12400	9126
90	109	90	14.73	19800	2880	3736	175000	94.2	2022	12687	87.4	60524	60524	6844	82.8	15630	12400
100	123	102	16.12	22000	3635	4491	188290	110.4	2605	17687	85.1	81904	81904	7198	82.8	19830	15630
110	137	115	17.51	24200	4515	5371	199240	121.4	3305	24212	82.4	10824	10824	7552	82.8	24924	19830
120	153	130	18.90	26400	5620	6476	207240	131.4	4220	31782	79.8	14404	14404	7906	82.8	30924	24924
130	171	147	20.29	28600	7020	7876	208840	141.4	5408	40261	77.3	19116	19116	8260	82.8	37924	30924
135	182	158	21.11	29700	7960	8816	211760	142.5	6230	44999	75.9	21464	21464	8514	82.8	44924	37924
140	197	171	22.50	30800	9320	10176	206240	151.1	7310	55444	73.9	23314	23314	8768	82.8	51924	44924
144	204	186	23.22	31680	10200	12876	188040	153.1	8590	61110	72.4	25114	25114	9022	82.8	58924	51924
140	248	218	24.8	30800	14780	15636	141640	183.1	11850	837	65.3	3314	3314	9214	82.8	65924	58924
135	259	220	25.22	29700	16040	16896	128040	175.1	12800	837	65.3	3314	3314	9214	82.8	65924	58924

in the form of the curves shown in Figs. 36 and 37, from which can be ascertained the complete performance of the motor from no load to full load and beyond. This motor is supplied with a variable resistance external to the secondary windings

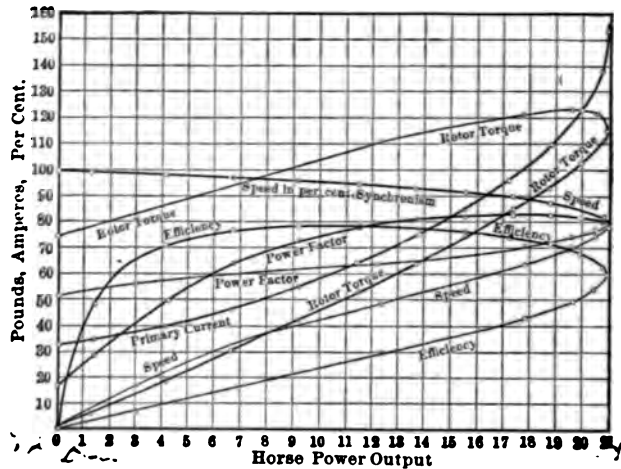
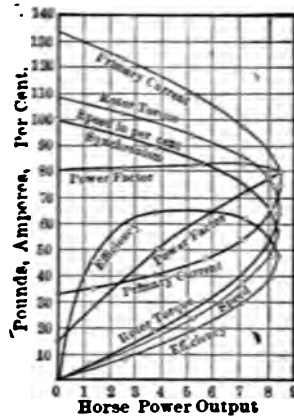

FIGS. 36 and 37.—Performance of Two-phase Induction Motor.

for the purpose of decreasing the primary current and increasing the rotor torque during the starting period. The effect of using this resistance is seen at a glance when Fig. 36 is compared with Fig. 37.

From column 9 of the table it is seen that the maximum torque of the rotor occurs at that value of the primary current which allows the greatest amount of power to be delivered to the secondary and that the value of this torque and the primary current and power-factor at which it occurs are entirely independent of the secondary resistance. Columns 10 and 11 of the same table, however, show that the slip at which occurs the maximum torque is directly proportional to the secondary resistance, though the secondary current which gives this torque has a definite fixed value independent of both the slip and the secondary resistance. It is evident, therefore, that by the use of variable resistance in the secondary circuit, the maximum torque can be made to occur at any speed from standstill to a few per cent. below synchronism, but that the primary current will depend upon the torque and not upon the speed.

While the method of calculation used in arriving at the results given in each column of the table is explained at the heads of the separate columns, perhaps a few words should be added concerning the formulas for determining the slip and the torque. The rotor slip may be expressed as the ratio of the copper loss of the secondary to the total power received from the primary. That is,

$$s = \frac{I_2^2 R_2}{W_s}$$

where W_s is the total secondary power. This relation was discussed at length in a previous chapter, and it need not be dwelt upon at this place. Likewise it has been shown that the rotor torque may be expressed in pounds at one foot radius by the formula,

$$D = \frac{7.04 W_s}{\text{syn. speed}}$$

It will be observed from column 7, that there has been added to the primary copper loss a quantity, 856 watts, to obtain the total primary loss. The 856 watts is the so-called "constant loss," and includes all iron and friction losses of the motor. It should be carefully noted in this connection that this loss is not constant, but it varies with increase of load. There are three causes which affect the constancy of the value of the iron loss. The drop in e.m.f. due to the current through the

primary resistance lessens the e.m.f. to be balanced by the rate of change of the core flux and thus decreases the density of magnetism and tends, thereby, to reduce the iron loss. When the rotor travels at synchronous speed the secondary core experiences no reversal in magnetism and there is, therefore, no secondary iron loss. As load is placed upon the motor, the rotor speed decreases and the magnetism of the secondary core reverses at a rate proportional to the slip and there is produced a corresponding core loss, tending to increase the total iron loss of the motor. Another cause tending to increase the iron loss of both the primary and secondary cores is the loss in the iron immediately around each conductor due to the superposed local flux when current traverses the conductor. The flux causing this local loss is that to which is due the reactance of the primary and secondary coils. The value of this flux depends directly upon the current in the conductors and inversely upon the total reluctance of the magnetic path surrounding them. The loss due to a given flux in a certain mass of iron depends not only upon the value of the flux and the frequency of its reversal but to a large extent also upon the density of magnetism upon which this flux is superposed. In any commercial motor the density of magnetism in the core teeth is normally quite high on account of the field magnetism proper alone, so that the loss due to the local flux surrounding each slot in both the primary and secondary cores under load currents depends greatly upon other factors than its own value and periodicity of reversal. The increase of iron loss due to the second and third causes, as enumerated above, is ordinarily somewhat greater than the decrease due to the first cause, resulting in the so-called load losses. In comparison with the total losses the increase in iron loss is usually quite small throughout the operating range of the motor. When the character of the work necessitates such procedure, this increase can be approximately determined and corresponding corrections made, though other errors in computations or assumptions will frequently more than equal that due to the neglect of this increase.

EQUATION OF THE CURRENT LOCUS.

Referring now to Fig. 35, it will be seen that the curve *ACPF*, the current locus, has been drawn as the arc of a circle. This

is the construction usually adopted for the purposes of preliminary design, in which case the point F is located as the extremity of the vector representing the value and phase of the primary current, which would be obtained with full e.m.f. impressed upon the motor with the rotor stationary. This construction is partly justified by the following fact:

If the primary resistance and the exciting current be neglected, or the secondary current be considered equal to the primary, the current locus is a true circle.

Let E = impressed e.m.f.,

I = current to the motor,

X_1 = primary reactance,

X_2 = secondary reactance,

R_2 = secondary resistance.

Treating the induction motor as a transformer, the value of the current as R_2 is varied is

$$I = \frac{E}{\sqrt{(X_1 + X_2)^2 + R_2^2}}$$

but $R_2 = (X_1 + X_2) \cotan \theta$; hence $I =$

$$\frac{E}{(X_1 + X_2) \sqrt{1 + \cotan^2 \theta}} = \frac{E}{X_1 + X_2} \sin \theta$$

which, when E is constant, is the polar equation of a circle having a diameter of $E \div (X_1 + X_2)$.

ERRORS IN ASSUMING A CIRCULAR ARC.

If the primary coils carried at all times an exciting current of constant value in addition to a current equal and opposite to the secondary current, the curve would yet be a true circle. In this case, however, the primary current would need to be measured from a point external to the circle at a distance from the circumference equal to the exciting current, that is, the primary current would be measured from B while the secondary current would, as formerly, be measured from A .

If in addition to the exciting current the primary coils carried a power component of current for the no-load iron losses, etc., over and above the counter current to oppose the current in the secondary, the locus would remain a circle, as before, but the primary current would be measured from a point O so located that OB equals the power component of the no-load

current, Fig. 35. The last assumption is true for any induction motor in which the drop in e.m.f. due to the passage of the current through the local impedance of the primary coils is negligible. The local primary impedance is, however, not negligible in a commercial motor. It is found, however, that the error in determining the primary and secondary currents due to the slight deviation of the curve from a true circle between the points *A* and *S* produces an almost inappreciable effect upon the results.

The effect of the primary impedance is the same in all respects as though the primary coils were without impedance and the power supplied to the motor were transmitted over a circuit having an impedance equal to that of the primary, which means that in the equation, *E* decreases with an increase of *I*, and the equation is, therefore, not that of a true circle. In a subsequent chapter these facts will be discussed more fully.

Having drawn attention to these errors in the assumptions concerning the current locus, it is sufficient here to state that while the method used does not give the absolutely true location of the primary current curve throughout its whole length, and the absolutely true secondary current curve does not coincide with that of the primary, the errors introduced into the calculations are relatively small and for most practical purposes may well be neglected.

The product of the power component of the primary current by the circuit e.m.f. gives the input to the motor. It will be seen from Fig. 35 that the maximum power which it is possible for the motor to receive is determined by the radius of the circle *APF*, that is, it is represented by the quantity $\frac{E^2}{2(X_1 + X_2)}$,

(neglecting the no-load losses), or the maximum power which the motor can receive is determined wholly by the reactance of the primary and secondary coils.

A further inspection of Fig. 35 will show that the maximum power factor occurs at that value of primary current which causes the line *OP* to become tangent to the curve *APF*. The value of this power factor depends upon the radius,

$$\frac{E}{2(X_1 + X_2)}$$

of the arc APF and upon the exciting current AB , being increased as the former is increased or as the latter is decreased.

EFFECT OF DESIGN ON LEAKAGE REACTANCE.

It is evident from the foregoing that in the construction of induction motors every effort should be made to render the reactance of the coils as small as possible. The reactance flux can be decreased by increasing the reluctance of the path which it must travel, that is by using open slots and operating the core teeth at high magnetic density. A method of decreasing the effectiveness of the local flux without, however, lessening appreciably the number of lines is found in the use of many rather than few slots. Thus when the conductors are bunched in a single slot each conductor is cut by the lines due both to its own current and to that of its neighbors in the same slot, so that the reactive e.m.f. per conductor depends directly upon the number of conductors in each slot, or the reactive e.m.f. per slot varies with the square of the conductors therein, and the total reactance of a certain winding is inversely proportional to the number of slots in which the conductors are placed.

The value of the exciting watts depends almost entirely upon the radial depth of the air-gap (more properly, upon the volume of the air-gap) and the employment of a small air-gap is desirable for large operating power factor. An inspection of Fig 35 will, however, reveal the interesting fact that since the radius of the arc APF is independent of the distance AB , the maximum power of the motor is unaffected by the value of the air-gap except as a change in the latter may affect the reactance of the coils. Since a reduction in the air-gap is accompanied with an increase in the local reactance flux around the coils, one is led to the highly interesting conclusion that reducing the air-gap of a given motor actually decreases the maximum power of the machine.

CHAPTER VIII.

INDUCTION MOTORS AS ASYNCHRONOUS GENERATORS.

OPERATION BELOW SYNCHRONISM.

The current demanded from the supply system by an induction motor when operating without load near synchronism is found to consist of two components, one in phase, and the other in quadrature with the impressed electromotive force. The inphase, power component is found as that value of amperes which multiplied by the impressed volts will give the watts necessary to supply the internal losses of the machine, while the quadrature component is found as that value of amperes which multiplied by the number of turns of the primary winding will give the magnetomotive force necessary to cause to flow through the reluctance of their paths the lines required to produce by their rate of change an internal counter e.m.f. less than the impressed by an amount such as to allow the primary current to flow through the impedance of the coil.

When the speed is less than synchronism, the secondary windings cut the revolving field at a rate proportioned to the slip and the e.m.f. thus generated causes to flow through the secondary conductors a current, which being practically in time-phase with the magnetism and in mechanically the same position in space, will give to the rotor a torque in a direction to lessen the secondary current, that is, a torque tending to accelerate the rotor. This current in its effect upon the primary acts as though it flowed in the secondary circuit of a stationary transformer and thus requires in the primary coil a current equal and opposite to it in magnetomotive force, so that the core magnetism is but slightly altered by its presence. The counter current appears as an addition to the power component of the primary current and represents the increase in electrical power supplied to the motor.

OPERATION ABOVE SYNCHRONISM.

When the rotor is driven above synchronism, the windings of the secondary cut the synchronously moving magnetism in a direction to generate an e.m.f. causing a current to flow in the secondary conductors in a direction opposite to that described above, so that the additional component of current required in the primary coil is reversed from its former time-phase position with respect to the field magnetism and to the impressed primary e.m.f., and thus tends to represent power flowing from the motor and, as will be discussed in detail later, at a speed sufficiently far above synchronism, an induction motor acts as a generator, the power delivered by it depending upon the relative motion of the secondary windings and the field magnetism, that is to say, upon the slip above synchronism. This characteristic of the machine has been frequently availed of upon mountain roads, where, in descending, the primary circuit of the motor is connected directly to the trolley line and the speed of the rotor held practically constant at a few per cent. above synchronism, or increased to any desired value by the insertion of resistance in the secondary circuit. Where the system of tandem speed control of two similar motors is used, a braking and energy-restoring effect may be produced, even upon level roads, by placing the motors in tandem connection while they are yet traveling at a speed between one-half and full synchronism, and the rate of retardation may be rendered quite uniform by judicious use of the starting resistance. The same remarks obviously apply when the speed control is obtained by change in the number of magnetic poles of a single motor.

VECTOR DIAGRAM OF CURRENTS.

The relative values and phase positions of the primary and secondary currents of an induction motor at all speeds both below and above synchronism may be graphically represented by a simple diagram which lends itself to a ready interpretation of the interdependence of the various characteristics of such a machine. Fig. 38 gives a vector diagram of the primary current of a certain three-phase, asynchronous machine operating under a constant impressed e.m.f. of 220 volts, and from this diagram may be determined the secondary current and all of

the performance characteristics of the machine and thus may its behavior as an asynchronous generator conveniently be investigated. In Fig. 38 the distance OB represents the power component of the primary current at no-load, the distance \overline{AB} is the wattless component of the no-load current, while \overline{OA} represents both in value and phase position the total current

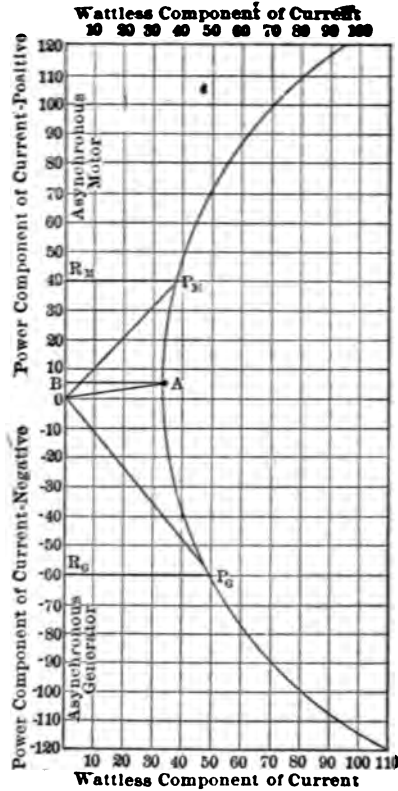

FIG. 38.—Current Locus of Asynchronous Machine.

taken by the motor at no-load. The product of \overline{OB} with the impressed e.m.f. gives the no-load losses of the motor, while the ratio of OB to OA , the cosine of the angle AOB , is the primary power-factor under no-load conditions. At a certain slip, the primary current will increase to some value and phase such as is represented by \overline{OP} , of which \overline{OR} is the power, and \overline{P} , the reactive component, respectively.

Now, the increase in the two components of the primary current under load is due to the corresponding components of the secondary current, so that such increase serves as a measure of the secondary current. An inspection of Fig. 38 will show that the line \overline{AP} is the vector sum of the changes in the two components of the primary current over the no-load values and hence represents both the value and phase (opposition) position of the secondary current when reduced to primary terms by the inverse ratio of turns of the respective windings. A further inspection and study of Fig. 38 will show that a series of points, such as P could be located for corresponding values of the primary current and that the locus of such point would form a continuous curve representing the value and time-phase position of the primary and secondary currents throughout the operating range of the motor.

On account of the fact that, independent of the method by which the e.m.f. may be produced in the secondary circuit of the motor, the primary circuit is that of a static transformer, the locus of the primary current as here designated approximates closely a circle, the center of which is located on the line \overline{BA} prolonged and the diameter of which is equal to the ratio of the impressed e.m.f. to the combined local leakage reactance of the two coils, as is true with any stationary transformer. The position of the complete circle is determined and it may readily be drawn both to the right and to the left of the origin of vectors, O when the initial point, A , and any load point, P , are located, as was discussed in the preceding chapter.

From the current locus of Fig. 38, the components of any chosen value of primary current and the corresponding secondary current may be ascertained at once and when the resistances of the primary and secondary coils are known, the complete performance of the machine may be determined by simple calculations. Such calculations are recorded in the table, and the results thereof are represented graphically in Fig. 39. The methods employed in obtaining the results sought will be appreciated from a study of the head-lines of the several columns of the table.

In all cases, the current referred to is the "equivalent single-phase current" or the corresponding component thereof. This term is used to express that value of current which multiplied

CALCULATION OF PERFORMANCE OF THREE PHASE ARRANGEMENT MAINS
 240 Volts, 3 Phase, 400 Cycles

	(2)	(3)	(4)	(5)	(6)	(7)	(8)	(9)	(10)	(11)	(12)	(13)	(14)	(15)
	Power Comp- nent Primary Current	Wattless Comp- nent Primary Current	Total Primary Current	Total Secondary Current	Power Factor	Efficiency, %	Watts, "Per %"	Watts Secondary	Watts, "Per %"	Watts, "Per %"	Watts, "Per %"	Watts, "Per %"	Watts, "Per %"	Watts, "Per %"
120	120	0	120	120	784	94.60	9476	10000	9476	10000	10000	10000	10000	10000
110	110	0	110	110	803	93.71	9371	10000	9371	10000	10000	10000	10000	10000
100	100	1	137	102	813	93.06	9306	10000	9306	10000	10000	10000	10000	10000
90	70	1	123	102	813	93.06	9306	10000	9306	10000	10000	10000	10000	10000
80	53	0	109	90	823	96.60	9660	10000	9660	10000	10000	10000	10000	10000
70	34	8	97	78	825	99.00	9900	10000	9900	10000	10000	10000	10000	10000
60	49	0	95	97	817	99.00	9900	10000	9900	10000	10000	10000	10000	10000
50	60	0	94	96	804	99.00	9900	10000	9900	10000	10000	10000	10000	10000
40	60	0	94	96	775	99.00	9900	10000	9900	10000	10000	10000	10000	10000
30	97	0	97	97	738	96.60	9660	10000	9660	10000	10000	10000	10000	10000
20	93	0	97	97	696	93.06	9306	10000	9306	10000	10000	10000	10000	10000
10	93	0	97	97	640	93.06	9306	10000	9306	10000	10000	10000	10000	10000
0	93	0	97	97	584	93.06	9306	10000	9306	10000	10000	10000	10000	10000
+10	93	0	97	97	528	93.06	9306	10000	9306	10000	10000	10000	10000	10000
+20	93	0	97	97	472	93.06	9306	10000	9306	10000	10000	10000	10000	10000
+30	93	0	97	97	416	93.06	9306	10000	9306	10000	10000	10000	10000	10000
+40	93	0	97	97	360	93.06	9306	10000	9306	10000	10000	10000	10000	10000
+50	93	0	97	97	304	93.06	9306	10000	9306	10000	10000	10000	10000	10000
+60	93	0	97	97	248	93.06	9306	10000	9306	10000	10000	10000	10000	10000
+70	93	0	97	97	192	93.06	9306	10000	9306	10000	10000	10000	10000	10000
+80	93	0	97	97	136	93.06	9306	10000	9306	10000	10000	10000	10000	10000
+90	93	0	97	97	80	93.06	9306	10000	9306	10000	10000	10000	10000	10000
+100	93	0	97	97	24	93.06	9306	10000	9306	10000	10000	10000	10000	10000
+110	93	0	97	97	-32	93.06	9306	10000	9306	10000	10000	10000	10000	10000
+120	93	0	97	97	-88	93.06	9306	10000	9306	10000	10000	10000	10000	10000

PERFORMANCE TABLE

by the circuit e.m.f. and power-factor will give the true watts; and the use of such term greatly facilitates any calculations with polyphase quantities, since all quantities may then be treated as though of single-phase significance.

Similarly, the resistance used is the equivalent single-phase quantity, having that value which multiplied by the square of the equivalent single-phase current will give the true copper loss of the circuit considered. It is an interesting fact, previously verified, that, for any given two- or three-phase circuit, howsoever inter-connected, the equivalent single-phase resistance is

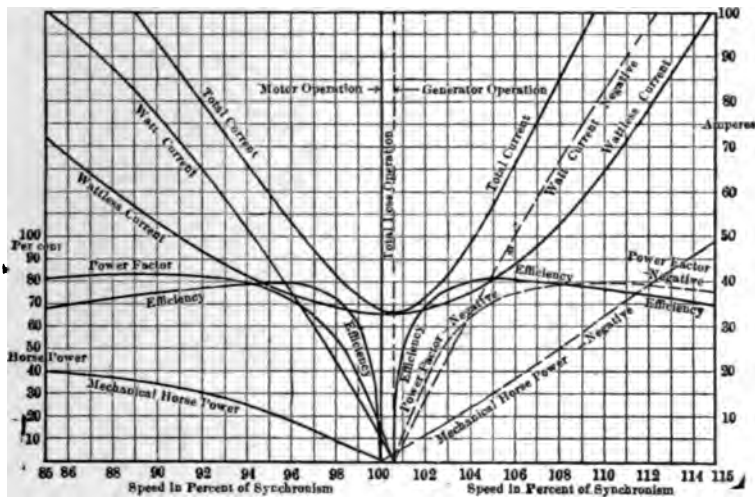

FIG. 39.—Test of Asynchronous Machine as Motor and as Generator.

just one-half of the value found between leads by means of direct current measuring instruments.

PERFORMANCE CHARACTERISTICS.

The curves of Fig. 39 show the performance of the asynchronous machine when its speed is varied from 85 per cent. continuously to 115 per cent. of synchronism and are the characteristic curves which would be experimentally obtained by belting the asynchronous induction machine to a shunt-wound, direct-current machine which being supplied with constant e.m.f. could be driven throughout this range of speed by varia-

tion of its field strength, thereby converting it from a generator to a motor gradually, as desired.

As seen from Fig. 39, at synchronous speed the induction motor receives all of its power electrically from the supply system and delivers no mechanical power. At 106 per cent. of synchronism this particular machine receives all of its power mechanically and delivers no electrical power whatever. Between these two speeds, all power received by the machine is dissipated in internal losses and the demand for power by the machine is gradually, with the negative slip, transferred from the electrical to the mechanical source of supply. Below synchronism, the machine gives out mechanical power, while above 106 per cent. of synchronism the power given out is electrical; that is, the machine operated as a generator and returns power to the electrical supply system.

Such an asynchronous generator can be connected directly to the supply network without the necessity of first bringing the machine to the exact speed corresponding to the circuit frequency, and the portion of the load which it will assume can be adjusted quite accurately by variation of the speed of its prime mover.

PARALLEL OPERATION OF ASYNCHRONOUS GENERATORS.

An asynchronous generator, as here assumed, will operate satisfactorily in parallel with generators of the synchronous type—the ordinary alternators; the frequency of the current delivered by it, however, is in any case less than that corresponding to the speed of its rotor, the difference being due to the requisite motion of the secondary conductors with reference to the primary field. The division of the load between synchronous generators working in parallel is determined by the relative phase position of the machines; the generator which maintains a phase position in advance of others carrying the greatest load, while one which lags behind in phase position is more lightly loaded. The actual speed of all the generators thus connected, however, must be the same; it is merely the tendency to different speeds, as fixed by the governing mechanism of the prime movers, which determines the load division. As far as concerns the prime movers, the condition of parallel operation of asynchronous generators is quite similar to the above, but

in the latter case the load division is determined by the actual operating speed of each individual machine; that is, the load carried by each is determined wholly by the variation of the speed of its rotor from that corresponding to the circuit frequency. When its speed is below the circuit frequency, an asynchronous generator is driven as an induction motor; which fact allows an asynchronous generator to be connected to the operating circuit without being brought to exact synchronous speed.

EXCITATION OF ASYNCHRONOUS GENERATORS.

As is true with the synchronous alternator, the asynchronous generator is not inherently self-exciting but current for excitation must be supplied from some source external to itself. Similarly, if the delivered (or supplied) e.m.f. is to be kept constant, the exciting current must be increased as the load increases. When the asynchronous generator is delivering power to constant potential mains, the exciting current automatically adjusts itself to correspond to the demands of the load. This characteristic of the machine will be appreciated from a study of the curve of Fig. 39, marked "wattless current." Such curve, when plotted to the proper coördinates, resembles closely the curve representing the relation between external load amperes and internal field current of the synchronous alternator.

A further analysis of the various components of the currents reveals the fact that, when operating as either a motor or a generator, the asynchronous machine possesses definite load-speed characteristics which are unalterable by any condition external to the machine. Thus, at any certain speed, the machine demands from the network a definite value of wattless current and delivers a certain amount of power either electrical or mechanical independent of the requirements of other machines connected to the system. As a generator, the machine can deliver no wattless current whatsoever and its own supply of such current must be derived from some other source.

When an asynchronous generator and a synchronous motor or converter are connected simultaneously to the supply system, the field excitation of the synchronous machine may be so adjusted as to cause this machine to supply the amount of wattless current demanded by the asynchronous generator,

while the speed of the asynchronous generator may be so regulated that it supplies just that amount of power current required for the synchronous machine. Under these conditions, the machines so interchange currents that they, considered as a unit, may be disconnected from the network without affecting the operation of either machine. The e.m.f. of the set may be adjusted as desired by variation of the field strength of the synchronous machine. The inherent regulation of the e.m.f. of the set, as the load thereon is varied, depends upon the magnetic circuits of the two machines and, in general, the performance is stable only when at least one of the machines is operated under conditions approximating magnetic saturation.

With circuits arranged as in Fig. 40, it may be shown experimentally that, under any given condition of operation, all

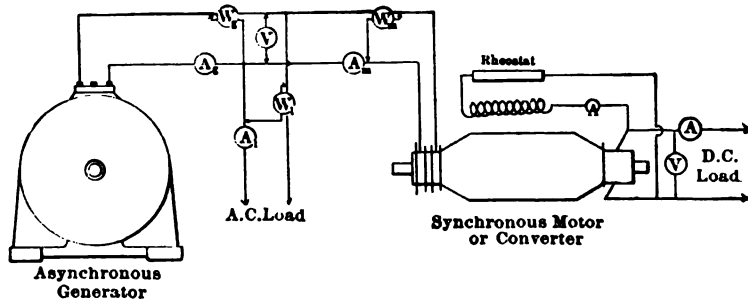

FIG. 40.—Arrangement of Load and Exciter Circuits; Synchronous Converter Excitation.

wattless current comes from the synchronous machine while all power current comes from the asynchronous generator. The synchronous converter may supply power electrically from its commutator, mechanically from its shaft, or power may be derived directly from the mains at the generator. The slip of the rotor from the speed corresponding to the circuit frequency will depend upon the amount of power thus demanded, so that with constant rotor speed, the circuit frequency will vary with the load on the set. The speed of the synchronous machine will vary with the circuit frequency, so that, independent of the effect of any wattless current which may be demanded, operation at constant circuit e.m.f. can be obtained only when the field strength of the synchronous machine is varied with the load.

Any demand for lagging current from the set necessitates an increase in the lagging component of current from the synchronous motor and weakens the field strength of this machine and thereby lowers the circuit e.m.f. A demand for leading current produces the opposite effect, and, if the leading current be properly adjusted in value, no wattless current whatever will flow from the synchronous machine and it may be disconnected from the circuit without affecting the performance of the asynchronous generator. An additional synchronous motor with its field cores over-excited may be used as a source of leading current, or static condensation with proper means for adjustment may be employed for this purpose.

CONDENSERS AS A SOURCE OF EXCITING CURRENT.

If the source of excitation be a synchronous alternator, the effect of the presence of the exciting current for the asynchronous

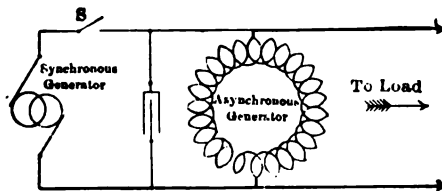

FIG. 41.—Asynchronous Generator; Condenser Excitation.

machine may be eliminated by placing across the generator circuit condensers adjusted in capacity so as to take an amount of leading current equal to the lagging current of the asynchronous generator. (See Fig. 41.) If this adjustment be exact, and there be no fluctuations in the load, no current will pass from the synchronous to the asynchronous machine, and the circuit between them may be opened without producing any effect whatever upon the operation of either machine. Under the conditions here assumed the asynchronous generator will receive its exciting current from the condensers, and, so long as the load remains constant and no changes occur in the speed of the prime mover, it will automatically maintain its e.m.f. at a constant value. If additional load be now placed upon the generator, the e.m.f. will decrease, while, if the load be decreased or removed entirely, the e.m.f. will at once increase

the performance being similar in many respects to that of a direct-current shunt-wound generator.

It is believed that the condenser excitation of asynchronous generators offers sufficiently varied application of the characteristics of the apparatus involved to justify an extended discussion of its use.

Before passing to a discussion of the performance of an asynchronous generator when excited by static condensance it may be well to recall a few of the fundamental facts connected with the operation of condensers in alternating current circuits.

CONDENSERS IN ALTERNATING-CURRENT CIRCUITS.

When two conducting bodies in close proximity are connected to opposite terminals from a source of electrical energy, it is found that there accumulates upon the adjacent surfaces or within the intervening insulating material, *i.e.*, the dielectric, a condition of sub-atomic activity termed "electricity." Other conditions remaining the same, the amount of electricity, or the charge which the bodies will store under a certain potential difference varies inversely as the distance separating the plates, and is greatly affected by the character of the dielectric. An assembly of numerous conducting plates separated by sheets of dielectric material as thin as practicable and yet of sufficient thickness to give the requisite insulating strength to withstand the maximum e.m.f. to be impressed at the terminals, forms the essential features of the commercial condenser.

In order now to investigate the action of a given condenser, assume one connected to a source of electrical energy, of which the e.m.f. may be changed at will. Assume further that at the moment of connecting the condenser in circuit, the e.m.f. is of zero value but increasing in a positive direction; charge will pass into the condenser, tending to produce, by strain in the dielectric, a counter e.m.f. equal to the impressed. Evidently so long as the e.m.f. continues to increase, charge will continue to pass into the condenser at a rate proportional to the instantaneous increase in e.m.f. When the e.m.f. reaches its maximum value, the condenser will have received its full charge and no additional amount of electricity will flow thereto. As the e.m.f. decreases, charge will flow from the condenser tending

at each instant to make the amount remaining therein correspond to the instantaneous value of e.m.f. From the above facts it will be seen that the rate of transfer of charge, *i.e.*, the current in the circuit, will have a value represented by the rate of change of the e.m.f. and if the e.m.f. follows a sine curve of time-value the current will follow the corresponding cosine curve, and, as seen above, will be 90 times degrees *ahead* of the e.m.f.

For purpose of comparison of the performance of different condensers, it is convenient to specify the amount of charge which a given condenser will assume under a certain e.m.f. relative to some charge taken as a unit. If a certain condenser, when subjected to a continuous pressure of one volt, accumulates electricity to the amount of one coulomb, that is the amount of electricity represented by one ampere for one second, it is said to possess a capacity of one farad. A condenser of capacity C is one which under a continuous electromotive force of one volt assumes a charge of C coulombs or when the e.m.f. is E volts the charge will be EC coulombs.

When the e.m.f. changes there is a flow of current to or from the condenser so that at each instant the charge in the condenser tends to adjust itself to correspond with the instantaneous value of the e.m.f. If the e.m.f. changes at a constant rate of one volt per second, then the charge must vary C coulombs per second, or the current must have a steady value of C amperes, or, in general, the current must be C times the rate of change of the e.m.f., that is

$$i = C \frac{de}{dt}$$

$$\text{now } e = E_m \sin \omega t$$

where E_m is maximum e.m.f. and ω , electrical angular velocity,

$$\text{hence } \frac{de}{dt} = \omega E_m \text{Cos. } \omega t \text{ so that}$$

$i = C \omega E_m \text{Cos. } \omega t$ or the maximum current, $I_m = C \omega E_m$, and, virtual values being used throughout,

$$I = C \omega E$$

which means that if a condenser of capacity C be connected to

a source of alternating e.m.f. E when the frequency is f there will flow therein an alternating current of value I such that

$$I = C E \omega = C E 2 \pi f.$$

In alternating current circuits, the ratio E to I gives the impedance which for a condenser as above is

$$\frac{E}{I} = \frac{E}{C \omega E} = \frac{1}{C \omega} = X_c$$

to which specific quantity there is given the name condensance, or negative reactance.

In the statement above concerning the angle of lead of the current taken by a condenser, a fact of minor importance has been neglected. It is found that the value of energy which a condenser returns upon discharge is less than that received during charge, the difference being dissipated in heat loss within the condenser through dielectric hysteresis and to a small extent to the heating effect of the current upon the conducting material. This loss requires a component of current in phase with the e.m.f. across the condenser terminals, so that in any practical condenser the current leads the applied e.m.f. by a time-angle less than 90° . The energy component of the condenser current is relatively quite small and for most practical purposes may be neglected.

Having taken this glance at the inherent characteristics of condensers, we are prepared to investigate the effect of connecting such condensers to the operating circuits of an asynchronous generator.

EXCITATION CHARACTERISTICS OF ASYNCHRONOUS GENERATORS.

Lines \overline{OL} , \overline{OM} and \overline{ON} of Fig. 42 show the relation existing between the e.m.f. impressed upon certain condensers L , M and N and the current taken by them at constant frequency. As will be noted from the equations developed above, the effect of each condenser circuit can be represented by a right line passing through the origin and the slope of the line depends directly upon the amount of effective condensance in the circuit considered. The line \overline{OPRTV} is the excitation characteristic of an asynchronous generator when driven at constant speed without load and is found as the relation of the impressed e.m.f.

to the wattless, lagging, component of the current in the primary coil.

If condensation of some value, such as M , be connected to the supply system in parallel with the asynchronous generator, then, at any impressed e.m.f., the condensation will require a definite amount of leading current while the lagging current of the

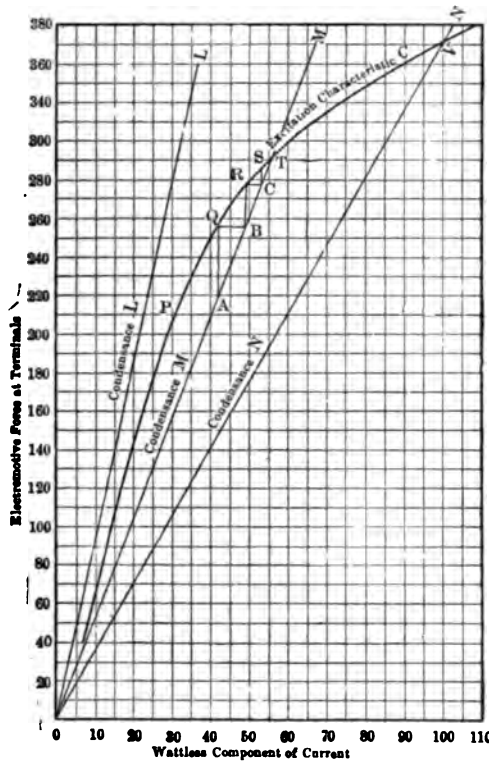

FIG. 42.—Characteristics of Condensers and Synchronous Excitation Characteristics of Three-phase Machine.

asynchronous generator will likewise be of a definite amount. With the impressed e.m.f. properly adjusted, the leading current taken by the condensation will equal the lagging current of the generator and no wattless current will be supplied from any other source. Such value of impressed e.m.f. is found in Fig. 42 at the intersection of the condenser line OM with the generator excitation characteristics at T , the value here being

approximately 292 volts. With conditions existing as here assumed, the asynchronous generator and condenser exciter may be isolated from the supply system and the set will automatically maintain its e.m.f. at 292 volts.

If at the moment of disconnecting the asynchronous generator and the condensation M , as a unit, from the supply system, the impressed e.m.f. be 220 volts,—the normal value for the asynchronous machine,—the e.m.f. of the set will at once increase to 292 volts, due to the following causes: Under 220 volts the condensation takes 42 amperes leading current, which, when supplied from the asynchronous machine would raise its e.m.f. to 256 volts, at which e.m.f. the condensation would take 49 amperes, raising the e.m.f. of the generator to 276 volts, and so on, until the e.m.f. became stable at 292 volts, as shown at T in Fig. 42. If, now, the condensation in circuit be changed to some value such as is represented by the line ON , the e.m.f. will at once rise to the value shown at the intersecting point, V , on the excitation characteristics. With a value of condensation such as OL in circuit, the generator will be unable to maintain its excitation at any e.m.f. whatsoever, since there is no point of intersection with the excitation characteristic.

Due to the extremely weak magnetic condition in which a ring core without projecting poles is left when the exciting force is removed, and also to a large extent to the lower initial inverted knee of the excitation characteristic which requires a relatively large exciting force in comparison with the e.m.f. produced at this point, the generator possesses but slight tendency to build up from its remnant magnetism when condensation of normal operating value is connected in circuit. It will be recalled that such behavior is characteristic also of shunt-wound, direct-current generators. In fact, for a given resistance in the shunt coil circuit, the relation between the current flowing therein and the e.m.f. is a right line similar to the condensation lines in Fig. 42 and the slope of such line determine the e.m.f. up to which the machine will build. That the shunt circuit resistance must ordinarily be decreased below the operating value before the direct-current generator will build up from its residual magnetism is familiar to all. This is due to the fact that the slope of the shunt circuit current line is such as to cause it to intersect with the excitation characteristic

at the lower inverted knee of the initial line of the hysteresis loop.

With the asynchronous generator, current of any frequency and of almost any value, or a static charge in the condensers may be used to cause the machine to build up. If the condensance, when connected in the circuit, is above a certain value depending upon the magnetic circuit of the machine, the generator will build up instantly from its remnant magnetism without initial external excitation.

Fig. 43 shows the connecting circuits for condenser excitation of an asynchronous generator and indicates a convenient method for varying the amount of effective condensance in circuit. For sake of simplicity, the diagram is made to represent single-

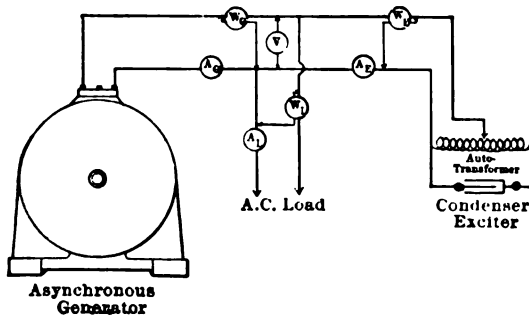

FIG. 43.—Arrangement of Load and Exciter Circuits; Condenser Excitation.

phase circuits, although polyphase equipment throughout could similarly be employed.

By the use of a transformer or auto transformer, the effective condensance in circuit can be adjusted within range, to any value desired by variation of the ratio of turns of the transformer coils, without in any manner changing the actual condensance connected thereto; the effective condensance varying as the square of the ratio of turns. This relation will be appreciated when it is considered that if, when the ratio is 1 to 1, the condensance takes current I , when the ratio is increased to 1 to \bar{M} , the primary e.m.f. remaining the same as before, the secondary condensance current will be $\bar{M}I$ and the primary opposing current will be \bar{M} times as great or $\bar{M}^2 I$. It is thus seen that, although the source of excitation of the generator is the con-

condensers, an increase in the *step down* ratio of transformation of the e.m.f. from the condensers will result in an increase in the generated e.m.f.

LOAD CHARACTERISTICS OF ASYNCHRONOUS GENERATORS.

The load characteristics of an asynchronous generator, when excited by static condensers, are quite similar to those of the familiar shunt-wound, direct current machine; an increase in load producing a decrease in e.m.f., due both to the direct effect of the load on the armature of the machine and to the added effect of the decrease in exciting current from the lessened e.m.f. at the field circuit. With the asynchronous machine a further effect is produced by the change in circuit frequency with the load, when the rotor is driven at constant speed. Since the effective condensance for any given adjustment varies directly with the frequency, and the exciting current to produce a certain e.m.f. for the asynchronous machine varies inversely therewith, all other conditions remaining the same, a mere change in frequency will alter the e.m.f. at which the set will operate. Since even a non-inductive resistance drop of e.m.f. in the generator windings under load current causes a slight decrease of the current in the exciter circuit under the lessened terminal e.m.f., the best regulation is obtained when the condenser is connected across one set of windings and the load placed across an independent set, as shown in Fig. 44.

With the familiar synchronous alternator a lagging load current tends to decrease the terminal e.m.f. while a leading current has the opposite effect. An exactly similar state of affairs exists with a self-excited asynchronous generator. In this case, however, the effect is cumulative, since any change in the terminal e.m.f. causes a variation of the current in the condenser exciter and the field magnetism must adjust itself to a correspondingly altered value.

If it were possible always to operate the set at constant frequency, then, by use of Figs. 39 and 42, one could determine at once the amount of condensance necessary to maintain the e.m.f. constant for any load, and conversely the inherent regulation of the set could be ascertained. Take, for example, the condition of operation represented in Fig. 39, at 105.5 per cent. speed. The machine is delivering 16.5 horse-

power at an efficiency of 80 per cent., and requires 42 amperes when the e.m.f. is 220 volts. The condensance necessary to give 42 amperes leading current at 220 volts is shown in Fig. 42 by the line \overline{OM} . If the load be removed from the set and the circuit frequency remain constant, that is, if the rotor speed be decreased to 100 per cent., the c.m.f. will increase to 292 volts as indicated by point T in Fig. 42. If, however, the rotor speed remained at 105.5 per cent. or increased when the load was removed, the e.m.f. would reach a much higher value. It is thus seen that close regulation necessitates that the machine be operated above the knee of the excitation character-

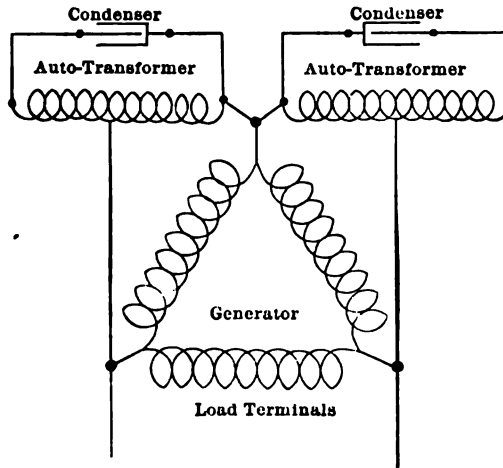

FIG. 44.—Exciter Circuits for Asynchronous Generator.

istic (Fig. 42) and that the slip under load be small, that is, that the secondary resistance be small, as has been mentioned previously.

Since magnetic saturation of material subjected to flux alternating at high frequency means excessive iron loss, efficiency of performance dictates that the core of an asynchronous generator be so designed that the secondary member, which is subjected to the low frequency of reversal corresponding to the slip reaches the saturation point while the primary member is yet much below such condition.

When it is remembered that the amount of current taken by a condenser in an alternating-current circuit under a certain

e.m.f., varies directly with the frequency, and that the number of magnetic lines of force to produce a given e.m.f. in the generator coils varies inversely with the frequency, it will be appreciated that the e.m.f. which a certain condenser will give to an asynchronous generator will depend largely upon the frequency. The frequency is determined primarily by the speed of the rotor, but it decreases, even for a constant rotor speed, when the generator load increases; a fact which shows the importance of good speed regulation at the prime-mover. Any leading current taken by the load acts as additional condenser capacity to increase the generated e.m.f., while lagging current produces the opposite effect; in fact, a condenser-excited generator of this type which operates satisfactorily under a non-inductive load, may be caused to lose its e.m.f. entirely by the addition of a relatively small proportion of inductive load.

COMMUTATOR EXCITATION OF ASYNCHRONOUS GENERATORS.

Mr. Heyland has devised a method for causing the asynchronous generator to supply its own current for excitation. In the application of his method, current is taken from the main circuit of the generator and passed to the secondary conductors through a suitable commutator on the rotor. The action of the commutator in supplying the exciting current will be appreciated by first considering two extreme conditions of operation. If direct current be introduced by way of slip rings into the secondary windings of an asynchronous generator while the rotor is driven at normal synchronous speed, it will be found that alternating current at normal frequency may be obtained from the primary windings and that the e.m.f. generated may be adjusted in value by a corresponding change in the direct current supplied. In fact, one readily appreciates that operating under the conditions here assumed the asynchronous machine is converted into a simple alternating-current generator and possesses all of the characteristics of this type of machine.

If with the rotor stationary alternating current of normal frequency be supplied to the secondary windings, current at the same frequency may be derived from the primary windings. Under these conditions, the generator is again a source of alternating current, but it now possesses the inherent characteristics

of a stationary transformer. If now a commutator be connected to the secondary windings, any motion of the rotor in either direction will not alter the effect of any certain value of current in the secondary in producing e.m.f. in the primary winding, since the space-phase position of the current with reference to the primary coils will be the same as would be the case were the rotor stationary. Hence, independent of the speed of the rotor, the current thus introduced into the secondary reacts upon the primary with the primary frequency. The value of the current in the secondary can be varied by changing the e.m.f. impressed upon the commutator, and it may be given any phase position with reference to its reaction upon the

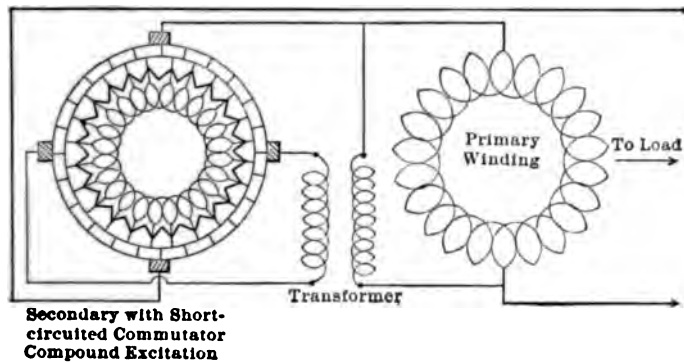

FIG. 45.—Asynchronous Generator; Commutator Excitation.

primary by changing the position of the rotor brushes relative to the field coils. (See Fig. 45.)

When the rotor is driven at synchronous speed in the direction of the revolving field, the e.m.f. required to be impressed upon the secondary windings in order to cause a given current to flow there through is greatly reduced below the value necessary when the rotor is stationary, due to the practical elimination of the reactive e.m.f. at the low frequency of the current in the individual slots containing the secondary conductors.

The operation of an asynchronous generator with commutator excitation is quite similar to that of one excited by means of condensers, and the statements made above as to the effect of speed variations and of the character of the load current

upon the delivered e.m.f., and as to the necessity of working the magnetic core at high density apply equally to the Heyland shunt-excited asynchronous generator. With a commutator generator, however, it is possible to use compound excitation, which consists in passing the load current, by means of an auxiliary set of brushes on the commutator, through the secondary conductors, and thus to increase the field strength with the load and to counteract the effect of any lagging current upon the field magnetism and the circuit e.m.f. This latter action is very similar to that produced in direct-current generators equipped with the Ryan balancing coils. Since a load current which lags in the primary coils will lag equally in the auxiliary exciting circuit of the secondary, it is possible by means of the compound excitation to compensate for the field demagnetizing effect of an inductive load upon the generator.

CHAPTER IX.

TRANSFORMER FEATURES OF THE INDUCTION MOTOR.

ELECTRIC AND MAGNETIC CIRCUITS.

Fig. 46 represents the electric and magnetic circuits of an ideal transformer. When an alternating e.m.f. is impressed upon the primary terminals, the secondary being on open circuit, a certain value of current flows in the coil. The magnetomotive force due to the ampere-turns of this current causes lines of force to be produced in the core, and the change in the value of these lines with the alternation of the current generates in the primary coil an e.m.f. in a time-phase position to tend to decrease the current in the coil; the final result being that there flows in the coil,

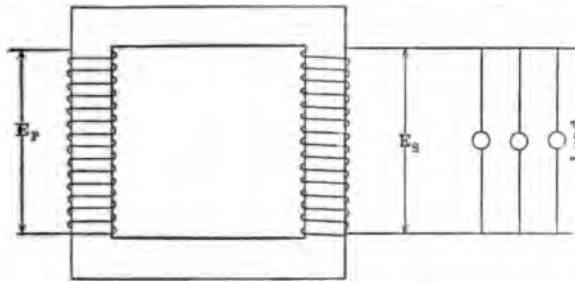

FIG. 46.—Electric and Magnetic Circuits of an Ideal Transformer.

just that value of current whose product with the number of primary turns gives the magnetomotive force necessary to send through the reluctance of their path that number of lines the change in the value of which generates in the primary coil an e.m.f. less than the impressed by an amount just sufficient to allow this value of current to flow through the local impedance of the primary coil. If the local impedance of the primary coil—which is composed of the resistance and the local reactance due to the leakage lines surrounding only this coil—be of small value, the e.m.f. counter generated in the

coil by the alternating flux in the core will be practically equal to the impressed e.m.f.

The effect of varying the reluctance of the magnetic path in the core is to vary accordingly the exciting magnetomotive force, but no appreciable effect is produced upon the value of the flux. A negligible effect may be attributed to the changed value of exciting current through the slightly varied local reactance and the resistance of the primary coil, which may alter the diminutive loss of e.m.f. through this impedance. This effect, which throughout the operating range of well designed transformers is augmented to a negligible extent by the load current, will be treated more in detail later.

The secondary coil is placed mechanically in a position to be cut by the greatest proportion of the flux due to the primary exciting magnetomotive force. With this coil on open circuit, there will be generated in each of its turns by the change in the value of core flux, an e.m.f. equal to the counter e.m.f. per turn in the primary. If the secondary circuit be closed through an impedance, current will flow, due to the secondary e.m.f., and this current will tend to decrease the core flux. The e.m.f. counter generated in the primary being somewhat lessened, more current will flow therein tending to restore the flux to its former value, and stable conditions will be reached when the additional primary current has a value and phase position such as to give the magnetomotive force necessary to counterbalance the effect of the secondary ampere turns, thus keeping the flux in the core quite closely constant at the value demanded by the primary e.m.f.

The exact relation between the flux in the core, the frequency of the supply current, the primary counter e.m.f. and number of turns can be derived quite simply from that law of physics which states that one c.g.s. unit of e.m.f. is generated when flux cuts a conductor at the rate of one line per second. In general

$$e = \frac{d\phi}{dt}$$

Assuming the flux (and the e.m.f.) to vary with time in a manner to be represented by the familiar sine law, its value can be stated as

$$\phi = A B_m \sin \omega t$$

where $A B_m$ is the maximum value of the total flux over the area of the core A .

Thus there is obtained

$$e = \frac{d (A B_m \sin \omega t)}{d t}$$

$$e = A B_m \omega \cos \omega t$$

which becomes maximum when $\cos \omega t = 1$ or

$$E_m = A B_m \omega$$

so that the virtual value of the e.m.f. per turn expressed in c.g.s. units is

$$E_v = \frac{A B_m \omega}{\sqrt{2}}$$

which for N turns when expressed in volts becomes,

$$E = \frac{A B_m 2 \pi f N}{\sqrt{2} 10^8} = 4.45 \frac{A B_m f \cdot N}{10^8}$$

from which the total magnetic flux, $A B_m$, or the flux density, B_m , may be determined.

Due to the internal friction in turning the molecular magnets in first one and then the other direction with the alternation of the core flux, there is dissipated a certain amount of energy with each reversal of flux, such energy appearing as heat in the core material and requiring in the primary coil a certain component of current in phase with the impressed e.m.f. to supply this loss. The watts thus required vary with the 1.6 power of the flux density and with the quality of the magnetic material, and can be expressed thus,

$$W_h = \frac{z f V B_m^{1.6}}{10^7}$$

where B_m = maximum flux in lines per sq. c.m.

V = volume of core in cubic c.m.

f = frequency in cycles per second.

z = coefficient of hysteresis.

z varies from .001 to .006 according to the quality of the magnetic material, a fair value for transformer sheets being .0022.

The alternation of the flux in the thin sheets (14 mils) comprising the transformer causes the generation within each sheet of a minute value of e.m.f. which tends to send current through the conducting material of the sheet. This current in its passage through the sheets follows the laws common to all electric circuits and produces heat proportional to the square of its value and the resistance through which it passes. The watts thus dissipated may be expressed as

$$W_e = \frac{e (d f B_m)^2 V}{10^{11}}$$

where d = thickness of sheets in centimeters,

e = coefficient of eddy loss.

e varies with the specific conductivity of the core material, a fair value being 1.65.

The eddy current and hysteresis losses being similar in effect are frequently treated as one quantity under the term core losses, requiring in the primary coil a current in phase with the impressed e.m.f., and of a value such that its product with the e.m.f. gives the core loss watts.

While the value of the flux in the core is determined almost exclusively by the primary e.m.f. the number of turns and the frequency, quite independent of the permeability of the magnetic path, the value of the magnetomotive force to produce such flux is directly dependent upon the permeability and varies inversely therewith. A convenient method for obtaining the value of the magnetomotive force expressed in ampere turns is found from

the fact that one ampere turn produces $\frac{4\pi}{10}$ lines per centimeter

cube of air. From this fact it follows that one ampere turn produces $\frac{1.25 \mu A}{l}$ lines in a material of permeability μ , whose length

of magnetic path is l centimeters and cross sectional area A sq. centimeters. A convenient method for determining the exciting watts from the volume of the core will be discussed later.

EQUIVALENT ELECTRIC CIRCUITS.

For the magnetic and electric circuits of a transformer as represented in Fig. 46 may be substituted the equivalent electric circuits shown in Fig. 47, where R_p and X_p are the primary re-

sistance, and local leakage reactance, while R_s and X_s are the secondary resistance and local leakage reactance, the shunted inductive and non-inductive circuits carrying the exciting current and core loss current respectively. These are the true equivalent circuits of a transformer based upon a ratio of primary to secondary turns of 1 to 1. If the primary has n times as many turns as the secondary, then the same equivalent circuits may be used to represent the transformer, if the actual secondary resistance and local leakage reactance be multiplied by n^2 to obtain the values to be used in the equivalent circuits and the real secondary load current be divided by n .

In the non-inductive shunt circuit flows the current to supply the core losses. If these losses varied as the square of the internal counter e.m.f., that is, as the square of the magnetic flux, the circuit could be considered as composed of true re-

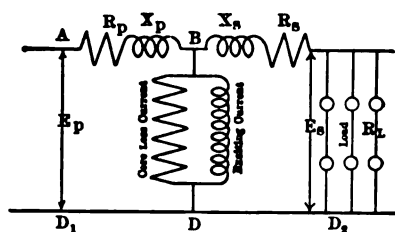

FIG. 47.—Equivalent Electric Circuits of an Ideal Transformer.

sistance. Such, however, is true only with reference to the eddy current loss and is not directly applicable to the hysteresis loss, but the assumption of the existence in this circuit at all times of a current whose product with the voltage supplies the core losses eliminates any error due to treating the circuit as being of pure resistance.

MODIFIED ELECTRIC CIRCUITS.

It is obviously possible to derive readily complete equations representing the performance of the transformer under various conditions of load by the use of the circuits shown in Fig. 47, when proper values are assigned to the several constants there indicated. There may, however, be introduced in the arrangement of the circuits a slight modification which involves no measurable error and yet which allows the performance

of the transformer to be represented graphically by a diagram whose most prominent feature is its simplicity. In Fig. 48, the two shunted circuits are shown as connected in the supply line so as always to receive the full value of the impressed e.m.f. The magnitude of the error thus produced will be appreciated when it is recalled that the current for supplying the core losses and the exciting current taken by a transformer are in any case quite small and the assumption that the combined value of such small currents remain constant when in reality it varies inappreciably (seldom over two per cent.) with the load leads to a truly negligible discrepancy in the results thus obtained.

With connections made as indicated in Fig. 48, the current taken by each of the three circuits will flow independently of

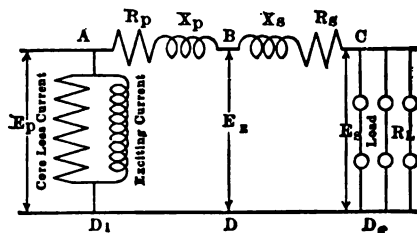

FIG. 48.—Practically Exact Representation of Circuits of a Transformer or Induction Motor.

the currents in the other two circuits while the total measurable primary current will be the vector sum of the three components. Methods for determining the value of the current for supplying the core losses and the exciting current have been given.

CIRCLE DIAGRAM OF CURRENTS.

The current taken by the load flows through the local impedance of both the primary and secondary coils and is unaffected by the presence of the currents in the other shunted circuits. If the external load circuit be strictly non-inductive, the locus of the load current with change in the resistance will be the arc of a circle, whose diameter is the ratio of the primary e.m.f. to the sum of the local reactances of the primary and secondary coils. (1 to 1 ratio.)

Let R_L be any chosen value of load resistance, then the load current will be

$$I_L = \frac{E_p}{\sqrt{(R_L + R_p + R_s)^2 + (X_p + X_s)^2}}$$

and its phase position with reference to the primary e.m.f. E_p will be such that

$$\sin \theta = \frac{X_p + X_s}{\sqrt{(R_L + R_p + R_s)^2 + (X_p + X_s)^2}}$$

hence

$$I_L = \frac{E_p}{X_p + X_s} \sin \theta$$

which when E_p , X_p and X_s are constants is the polar equation of a circle having diameter

$$\frac{E_p}{X_p + X_s}$$

Knowing the values of the three component currents in the branch circuits of Fig. 48, the resultant primary current may be found in value and phase position as their vector sum. Since the exciting current and the core loss current do not change with variation in the load, their vector sum may be permanently recorded as the no-load primary current as shown at MO in Fig. 49. It is convenient also to plot at once the vector of the load current OP in position to give at once the resultant primary current, by beginning the current locus OPC at the point O in Fig. 49.

A study of the construction of the current locus of Fig. 49 will show that at any chosen load current, as OP , MP is the resultant primary current, GMP is the angle of lag of the primary current behind the e.m.f. ME , and the ratio of MG to MP is the power factor. The product of MG and the impressed primary e.m.f. is the input to the transformer, from which if the core losses and the primary and secondary copper losses be subtracted the output may be obtained and the efficiency determined. The output divided by the secondary current gives the secondary e.m.f. from which the regulation of the transformer may be ascertained.

In a well constructed static transformer, the primary and secondary coils are so interspaced that magnetic leakage is reduced to a minimum, so that X_p and X_s are small in value and the diameter of the current locus as shown in Fig. 49 is correspondingly enormous, and throughout the operating range of the transformer the arc of the circle deviates but slightly from a straight line parallel to ME . Numerous theoretical equations are available for determining the values of X_p and X_s . Only those which are formed upon an experimental basis in-

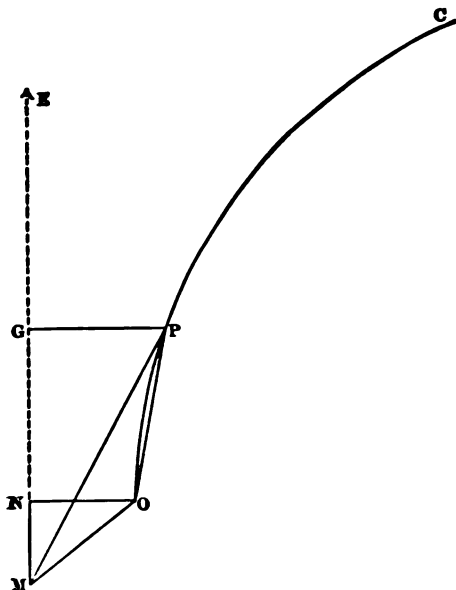

FIG. 49.—Circular Diagram of Currents.

volving the use of the exact type of transformer under consideration are found to give results in conformity to observations under test.

On account of the fact that the path of the magnetic lines in the core of a static transformer pass through material of high permeability a relatively small value of exciting magnetomotive force is required and due also to the low value of the core losses the no load current of such a transformer is correspondingly small in comparison with the full load current. A type of

transformer in which the proportions of no load current to full load current is quite large is found in the induction motor. In its electrical characteristics an induction motor is essentially a transformer possessing high magnetic leakage due to the separation of the primary and secondary windings and the more or less complete surrounding of each group of coils with material of high permeability. This transformer shows also a high value of exciting current due to the double air gap in the magnetic circuit. For studying the characteristics of such a transformer the circle diagram is especially valuable.

Although in the secondary circuit the frequency varies directly with the slip, and, therefore, for constant coefficient of self-induction, the secondary reactance varies in direct proportion with the slip, and in general the secondary resistance is more or less constant, it is convenient and helpful to treat the machine as a stationary transformer in which the secondary reactance is constant and the resistance varies with the load. That is to say, the performance of the secondary of the motor will be faithfully represented if all the power received from the primary be considered as dissipated in resistance in the secondary circuit, the slip at all times being taken as unity, and the total secondary resistance (conductance) being assumed to be varied according to the secondary load, or, briefly, the induction motor may be treated in all respects like a stationary transformer. The effect upon the transformer quantities of increasing the speed from zero to synchronism is the same in all respects as increasing the external resistance in the secondary circuit from zero to infinite value, the output from the motor being represented in any case as the power lost in the fictitious external resistance. These facts have been discussed in a preceding chapter and they need not be further discussed here.

The diagram of Fig. 47, which shows the conventional method of representing the electric circuits of a transformer which has an equal number of turns in the primary and secondary windings, is based on the assumptions that the reluctance of the core is constant for all densities of magnetisms and that the iron losses vary with the square of the magnetic density in the core. It is obvious that neither of these assumptions is absolutely correct with reference to any commercial stationary transformer, but it is true that the errors involved in any

calculations depending upon these assumptions are practically negligible. It is evident that in an induction motor the reluctance of the total magnetic path is much more nearly constant than that in a transformer, and that if the frictional and windage losses be included with the iron losses, the circuits shown in Fig. 47 will serve admirably for all calculations connected with this machine.

In the diagram of Fig. 47, R_p and X_p are the primary resistance and local leakage reactance, while R_s and X_s are the secondary resistance and local leakage reactance, the shunted inductive and non-inductive circuits carrying the exciting current and the core loss current, respectively, as stated previously. An examination of Fig. 47 will show that the primary current is made up of three components; the quadrature exciting current, the core loss current and the load current, of which it is the vector sum. Under operating conditions the current which flows through the primary coil causes a drop in voltage across the local primary impedance and hence the internal counter e.m.f. decreases with increase of load, and there is a decrease in both the exciting current and the core loss current. If it be assumed initially that the variation in the values of these currents is negligible in comparison to the load current of the machine, the treatment becomes much simplified and yet the true conditions are fairly well represented.

Fig. 48 shows the circuits as they could be represented on the basis of the latter assumptions. The current taken by each of the three circuits will flow independently of the currents in the other two circuits, while the total measurable primary current will be the vector sum of the three components. Only one of the component currents varies with the change in load, and its value can easily be determined when the resistance of the load circuit is known. It will be noted that the load circuit contains a constant reactance ($X_p + X_s$) in series with a variable resistance ($R_p + R_s + R_L$), where R_L is the fictitious resistance of the load. It will be seen, therefore, that the current which flows through this circuit under a constant impressed e.m.f., E , can be represented by a vector whose extremity describes the arc of a circle having a diameter equal to

$$\frac{E}{X_p + X_s}$$

The arc OPC of Fig. 49 indicates a section of such a secondary current locus. At any point, P , on this arc, OP represents the secondary current both in value and phase position. The quadrature exciting current is represented by ON , while NM shows the core loss current (to supply all of the no-load losses). The vector sum of these three currents, MP , in Fig. 49, is the primary current, while the angle of lag of the current behind the circuit e.m.f. is shown by NMP , the cosine of which is the power factor. The power component of the primary current is indicated by the line PQ , and the product of this with the circuit e.m.f. gives the input to the motor.

By means of this simple circle diagram, the construction of which is based on somewhat erroneous assumptions, the complete performance of the motor may be determined with a degree of accuracy which seldom need be exceeded for any purpose of designing or testing, since the errors introduced are of small moment, and are not misleading; moreover, they tend to disappear in the final composite results. Thus the input to the secondary at any chosen current may be found as the difference between the primary input and the sum of the primary losses, which latter include the easily calculated copper loss and the approximated "constant" losses. The secondary input is at once the torque in "synchronous watts"; the ratio of the secondary copper loss to the secondary input is the slip, while the output is the secondary input minus the secondary copper loss. As will be shown later, the various quantities may be represented graphically by simple circular arcs and straight lines.

INTERNAL VOLTAGE DIAGRAM OF THE INDUCTION MOTOR.

In comparing Fig. 48 on which the simple circle diagram of Fig. 49 is based, with Fig. 47 on which a true diagram should be based, it will be observed that the errors involved relate merely to the quadrature exciting current circuit and the core loss current circuit; the voltage across these circuits is not constant, but it varies with the load current. Since that portion of the drop of voltage across the primary impedance, which is due solely to the core loss current and the exciting current, is quite negligible in comparison to that due to the local current, it is permissible to assume that the voltage at BD in Fig. 47

depends entirely upon the load current. This assumption is equivalent to neglecting terms of higher order. These may be taken into consideration graphically without difficulty, but the gain by so doing is not sufficient to justify the added complication.

The internal voltage diagram of an induction motor is represented in Fig. 50, where AD is the impressed primary e.m.f., AF is the drop through the primary reactance, BF is the drop through the primary resistance, and, hence, AB is the primary impedance drop. The secondary reactance drop is BH , CH

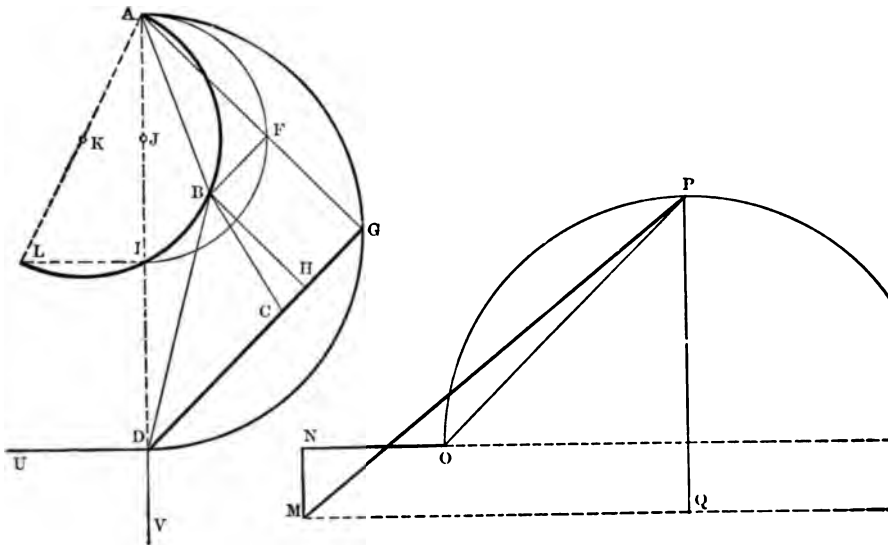

FIGS. 50 and 51.—Modified e.m.f. and Current Loci of Poly-phase Induction Motor.

is the secondary resistance drop, and BC is the secondary impedance drop. CD is the voltage consumed in the fictitious external load resistance, and, hence, it the secondary e.m.f.; E_s in Fig. 48 or Fig. 47. The line BD in Fig. 50 is the e.m.f., E_i in Fig. 48 or the voltage across BD in Fig. 47.

The current in the secondary is in phase with GD , and in quadrature with AG . The angle, AGD , is a right angle, so that the point, G , describes a circle with its center on the line, AD . The point, F , describes a circle, AFI , with its center at point, J , on line, AI . The distance, AI , bears to the

distance, AD , the ratio of the primary leakage reactance to the total leakage reactance of the machine. The point, B , describes a circle, $ABIL$. The angle, LAI , has a tangent equal to the ratio of the primary resistance to the primary leakage reactance.

It will be noted from Fig. 47 that the three component currents may be determined at once when the secondary load current is known and the voltage across BD has been found. Referring now to Fig. 52 and remembering that the core loss current is in phase with BD and proportional to it, it will be seen that this current can be represented by the line, DT , where T describes a circle having its center on the line, VX , the angle, DVX , being equal to the angle IAL . Similarly, the exciting current, which is in quadrature with BD , can be represented by the line, DS , where S describes a circle having its center on the line, UW , the angle, DUW , being equal to the angle, IAL . DU and DV , of Fig. 52, are respectively equal to DU and DV of Fig. 50 or to ON and NM of Fig. 51.

CORRECTED CURRENT LOCUS OF THE INDUCTION MOTOR.

The corrected current locus of the induction motor is shown in Fig. 53, where the arc, OPR , is in all respects the same as the semicircle, OPR , in Fig. 51. The line OP in Fig. 53 is parallel to the line, DG , in Fig. 52, but it varies in length directly with the line, AG , of Fig. 52. NM of Fig. 53 is equal to DT , and is parallel and proportional to BD of Fig. 52. ON is equal to DS , is in quadrature to and proportional to BD of Fig. 52. The primary current is represented by the line, MP , as the vector sum of OP , ON and NM , that is, as the resultant of the load current, the quadrature exciting current and the core loss current.

In Fig. 53, the line PQ is the power component of the primary current, the product of which with the impressed e.m.f. gives the input to the motor. The complete performance of the machine can be determined in a manner exactly similar to that outlined for the simple circular locus of Fig. 51 or 49.

The current locus in Fig. 53 is based primarily on the transformer features of the induction motor, and it is inexact only to the extent to which the motor differs from a transformer in its electrical behavior. The frictional loss is treated as a core

loss, and hence it is tacitly assumed that this loss necessitates a power component of current in only the primary winding. This treatment involves no error with reference to the primary current, but it neglects a certain component of secondary current, which, however, is too small to need consideration.

It will be noted from Fig. 50 that the secondary resistance has no effect whatsoever on either the current locus shown in Fig. 51, or that shown in Fig. 53. The primary resistance has no effect on the secondary current, although the primary

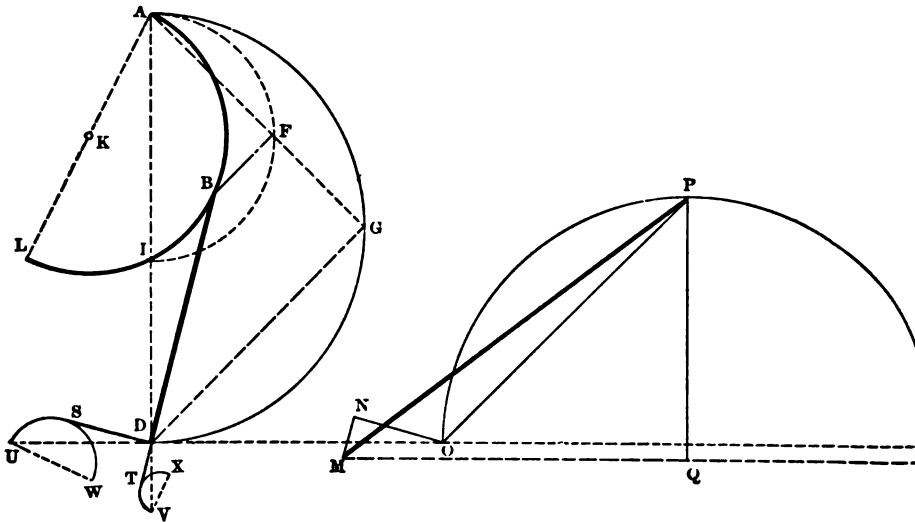

FIGS. 52 and 53.—Corrected e.m.f. and Current Loci of Poly-phase Induction Motor.

current depends somewhat on this resistance. If the primary resistance were negligible, the point *B* in Fig. 52 would follow the circular arc, *A F I*, and both the angle, *D U W*, and the angle, *D V X*, would reduce to zero; the general form of the locus of Fig. 53 would be changed only slightly.

From the facts stated above, it is evident that the primary current cannot be represented by any circle howsoever located, but that in any event the secondary current locus is a true circle. For many purposes where extreme accuracy is not desired, but where some information is wished concerning the changes in

the variables connected with the phenomena of an induction motor during operation an approximate graphical diagram without serious errors is extremely convenient. It is believed that the simple circular locus with its well defined but practically negligible errors possesses peculiar merit in this respect.

COMPLETE PERFORMANCE DIAGRAM OF THE POLYPHASE INDUCTION MOTOR.

A simple circular locus from which the complete performance of a polyphase induction motor may be ascertained at once is shown in Fig. 54. At any point P on this locus, the line MP represents the primary current, while the angle, EMP is the angle of lag of the current behind the primary e.m.f., EM . The line OP shows the secondary current, both in value and

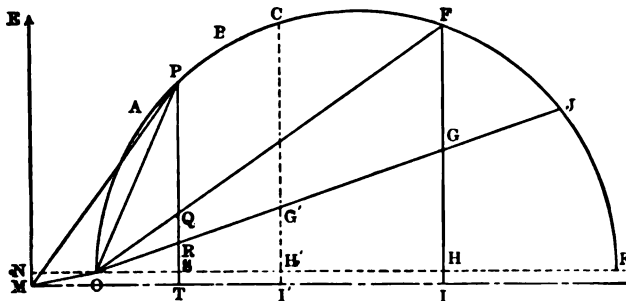

FIG. 54.—Simple Circular Current Locus of a Polyphase Induction Motor.

phase position. When the secondary current has zero value, that is, at synchronous speed, the primary current becomes equal to MO , ON being its "wattless" component and NM its power component to supply all of the no-load losses. When the rotor is stationary, the secondary current assumes some value such as OF , and the primary current is the vector sum of OF and OM (not drawn). The curve, OPF , is the arc of a circle having its center on the line ON prolonged.

Under starting conditions, all of the power received by the motor is used in supplying the copper and core losses of the machine. The line FI is the power component of the primary current at starting, and hence, by the use of the proper scale, it may represent the total losses of the machine when the rotor

is stationary. If it be assumed that the circuits of the machine are faithfully represented by Fig. 48, then the line $HF = (FI - MN)$ of Fig. 54, shows the secondary copper loss and the increase of the primary copper loss over its (synchronous) no-load value. The line HF being properly divided at G , GH represents the increase of the primary copper loss, and GF the secondary copper loss for the current OF . By drawing from the point O a straight line, OGJ , passing through the point G , the complete performance of the machine may be determined directly from inspection.

If from any point P on the circular locus a line be drawn perpendicular to the diameter, OK , the following quantities may be observed at once:

- MP is the primary current,
- EMP is the primary angle of lag,
- $\cos EMP$ is the power factor,
- OP is the secondary current,
- PT is the total primary input,
- TS is the "constant" losses of the machine,
- RS is the added primary copper loss,
- RT is the total primary losses,
- PR is the total secondary input, in watts,
- PR is the torque in synchronous watts,
- QR is the secondary copper loss,
- $QR \div PR$ is the slip, with synchronism as unity,
- $QP \div PR$ is the speed,
- QP is the output,
- $QP \div PE$ is the efficiency.

The maximum power factor occurs when the point P is at A , where the line MP becomes tangent to the circle.

The maximum output occurs when P is at B , the point of tangency of a line drawn parallel to OF .

The maximum torque occurs when P is at C , the point of tangency of a line drawn parallel to OG . The current which is required to give maximum torque varies somewhat with the primary resistance, but it is independent of the secondary resistance, although the speed at which the maximum torque is obtained depends largely on the value of the secondary resistance. The secondary resistance required to give maximum torque at starting bears to the assumed constant primary resistance the ratio of $G'C$ to $G'H'$ of Fig. 54.

The proof of the accuracy of the diagram in representing the value and phase positions of the primary and secondary currents for the circuits as shown in Fig. 48 was given above, and it need not here be repeated. That the various other quantities are accurately represented as indicated may be shown as follows:

Denoting as a the angle POK of Fig. 54, it will be seen that $OS = OP \cos a$, and that $OP = OK \cos a$. Hence, $OS = OK \cos^2 a$, or $OS = \overline{OP^2} \div OK$. The interpretation of the last equation is that, as the point P moves around the circle, the line OS is at all times proportional to the square of the line OP . That is to say, the line OS is proportional to the secondary copper loss or to the increase in the primary copper loss over its no-load value. Under starting conditions, the secondary and the added primary copper losses are represented by FG and GH ; and at any point P , the corresponding losses must bear to FG and to GH the ratio of OS to OH . Therefore, the secondary and the added primary copper losses are accurately shown by the lines QR and RS , respectively.

That the ratio of the secondary copper loss to the total secondary input is equal to the slip has already frequently been mentioned. It seems desirable, however, in this connection to call attention to the fact that this ratio is a true measure of the slip whether the magnetism of the machine remains constant or not, and that the accuracy of the determination of the slip by this method is in no wise affected by the substitution of the modified circuits of Fig. 48 for the exact circuits of Fig. 47. Thus, if the secondary copper loss is determined without error, and the secondary input is known, both the speed and the torque may be ascertained with precision. It is seen, therefore, that any errors introduced must relate to either the currents or the losses.

If the points O and F of Fig. 54 are obtained from an actual test on a machine, it is evident that the circle diagram as constructed must be at least approximately correct for the primary current locus. Under starting conditions the power received by the machine is accurately represented by the line FI . If the distance FG be drawn equal to the easily determined "added" primary copper loss, the distance GH must represent the secondary copper loss with a fair degree of accuracy.

It is especially worthy of note that under starting conditions and at synchronous speed the errors are eliminated, and through-

out the operating range of the motor the various errors tend to cancel each other. Even in extreme cases, where the (synchronous) no-load triangle, OMN , is large in comparison with the circle diagram, the errors are relatively small and for most practical purposes may well be neglected.

It is not possible to obtain absolute accuracy in a simple diagram of an induction motor. Moreover, it is unnecessary to construct a diagram with a degree of accuracy greater than that which can be employed with it in scaling off the various values. The principal advantage to be found in the graphical method of treating induction motor phenomena resides in the fact that by the use of a simple diagram one is able to follow optically, and thus mentally, the changes which take place throughout the operation of the machine, while in the manipulation of algebraic formulas, which can be used for absolute accuracy, one is apt to find himself more or less in the dark concerning these changes.

The above description refers to the locus of the primary and secondary currents of a polyphase induction motor. It is desirable to describe also the method by which a similar diagram may be used with a single-phase induction motor.

COMPARISON OF SINGLE-PHASE AND POLYPHASE MOTORS.

The chief difference between a single-phase and a polyphase induction motor resides in the character of the magnetic fields of the two machines. At synchronous speed each machine possesses a true revolving field. At standstill, however, while the magnetic field of the polyphase motor revolves synchronously and is of more or less constant strength, the field of the single-phase machine is unidirectional in space and alternating in value.

If when the rotor of a polyphase motor is stationary a circuit be opened so that current flows through only two leads of the machine, it will be found that the total volt-amperes taken by the machine decrease to about one-half of the former value, the power factor being practically unchanged. That the magnetomotive force of the current in each phase winding of a two-phase motor when the rotor is stationary produces a flux which (for constant reluctance of the core) acts as though the flux due to the other current in the winding were not present may be seen at once without proof. It will be appreciated, also,

that the currents produced in the secondary by two alternating fluxes which are in electrical space quadrature do not interfere one with the other, so that the current in each primary winding flows just as though the other primary current did not exist. Thus the "equivalent single-phase" starting current of a two-phase motor is just twice that of the same motor when only one phase winding is used; the power factor is the same in the two cases. Both experimental and theoretical investigations show that the "equivalent single-phase" starting current of a three-phase motor is also equal to twice the current which flows through two leads when the third lead is interrupted.

If, when the rotor of a polyphase induction motor is revolving synchronously a primary circuit of the machine be opened, it will be found that the current flowing through the remaining leads increases somewhat but that the total volt-amperes taken by the machine remain practically constant, and the power-factor is practically unaltered (the power component of the equivalent single-phase current increases to a small extent while the wattless component decreases slightly). The action of the machine at synchronous speed is attributable to the continued existence of a revolving magnetic field or practically constant strength which requires a definite component of current in phase with the voltage to supply the losses and another component in quadrature with the voltage to supply the "quadrature watts" for excitation. A subsequent chapter will explain the distribution of current in the secondary conductor, and will show in what manner the "quadrature watts" for the "speed-field" are supplied by the primary exciting magnetomotive force.

When the rotor of a polyphase motor is revolving synchronously, the secondary current has a negligible value. In the single-phase motor, however, the secondary current at synchronous speed has a value such that its magnetomotive force produces in electrical space quadrature with the main alternating field through the primary coil, a field which is equal in value and in time quadrature with the main field. The value of the main field is determined by the primary e.m.f. just as is true in any transformer, while the field which is in quadrature both in time and in space therewith depends for its value both upon the "transformer field" and upon the speed of the rotor; the two

fields are equal in effective value at synchronous speed and at other speeds, the "speed field" is equal to the "transformer" field multiplied by the speed. Thus the "speed-field" component of the secondary current varies with the speed and is zero at standstill.

ELECTRIC CIRCUITS OF THE SINGLE-PHASE INDUCTION MOTOR.

The circuits of a single-phase induction motor can be represented with a fair degree of accuracy if the primary and secondary resistances and the leakage reactances be arranged as shown in Fig. 55a, the "transformer field" and "speed field" exciting circuits being connected as indicated. The current taken by the load and that used to produce the "speed field" pass through both the primary and the secondary coils, while the current required for the "transformer field" flows through

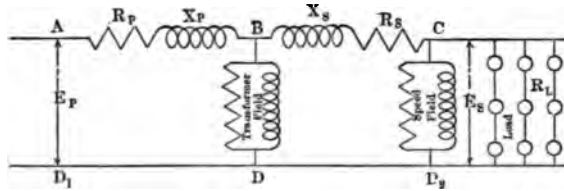

FIG. 55A.—Practically Exact Representation of Circuits of a Single-phase Induction Motor.

only the primary coil. When the load circuit is opened, that is, at synchronous speed, the "speed field" current and the "transformer field" current are practically equal in value. When the resistance of the load circuit is zero, that is at standstill, the "speed field" current is zero, and the current which flows through the coils of the machine acts as though the "speed field" circuit were not present.

It is to be noted especially that the decrease in the "speed field" current below the value of the "transformer field" current is attributable to the variation of the rotor speed from synchronism and not to the drop in voltage across the secondary winding, which is caused by the load current. The "secondary load" current flows in electrical space quadrature to the "speed field" current, and the two currents in no way interfere with each other. The statements just made relate exclusively to the current whose magnetomotive force produces the "speed

field," which current, on account of its electrical space position, does not react in any way upon the "transformer field." The secondary carries also another component of current in addition to the load current. The time-phase position and the electrical space positions of this component are such that its magnetomotive force tends directly to decrease the "transformer field"; thus, it acts like a "wattless" secondary current. It is this latter component of secondary current which is represented in the circuit diagram of Fig. 55a. This component bears to the actual "speed field" current (approximately) the ratio of the actual rotor speed to the synchronous speed. Thus the voltage impressed upon the "speed field" circuit of Fig. 55a is (approximately) equal to that impressed upon the "transformer field" circuit multiplied by the square of the speed, synchronism being

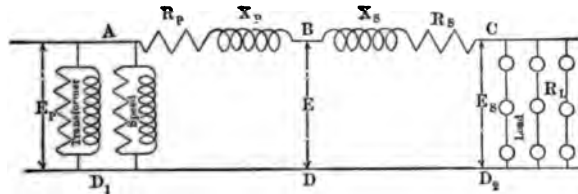

FIG. 55b.—Modified Representation of Circuits of a Single-phase Induction Motor.

taken as unity. These facts will be discussed more fully in a subsequent chapter.

Although it is possible to construct primary and secondary current loci based on the circuits shown in Fig. 55a, the problem of dealing with the value and phase positions of the currents is greatly simplified without involving a detrimental loss of accuracy by using the modified arrangement of circuits indicated in Fig. 55b.

COMPLETE PERFORMANCE DIAGRAM OF THE SINGLE-PHASE INDUCTION MOTOR.

The current diagram for the circuits shown in Fig. 55b is given in Fig. 56, where MN is the power and ON the wattless component of the primary current at synchronous no load, while FI is the power and IM the wattless component of the primary current at standstill. The curve $OPFK$ is an arc of a

circle having its center on the line ON prolonged. OL is the "speed field" current (assumed constant in the diagram, but properly accounted for in the computations). LM is the "transformer field" current, while OM is the total primary current at synchronism.

The line FI drawn perpendicular to MTI represents the total loss of the machine at standstill—the proper scale being used. HI indicates the so-called "constant" losses, while FH shows the sum of the "added" primary and secondary copper losses. If the distance GH be laid off to represent accurately the easily determinable "added" primary copper loss, then FG shows the "added" secondary copper loss. Straight lines being drawn to join the point F and the point G with O of Fig. 56, if from any point P on the circular arc $OPFK$

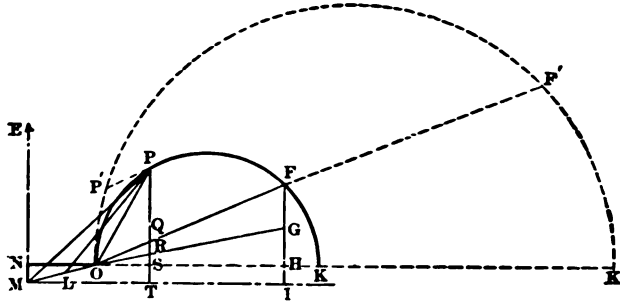

FIG. 56.—Current Locus of Single-phase Induction Motor.

a perpendicular be dropped to the line MI the following values may be taken at once from the diagram:

OP is the "added" component of the primary current,
 OP is also the "added" component of the secondary

current,—

PL is the total secondary current,

PM is the total primary current,

$\cos \angle EMP$ is the power factor,

$PT \div PM$ is the power factor,

ST is the "constant" losses of the machine,

RS is the "added" primary copper loss,

RT is the total primary losses (including "speed" field excitation current loss in secondary),

QR is the "added" secondary copper loss,

QT is the total losses of the machine,

PT is the input to the machine,

QP is the output,

$QP \div PT$ is the efficiency,

PR is the total input to the secondary (excluding the "speed field" excitation current loss).

$(PQ \div PR)^{\frac{1}{2}}$ is the speed with synchronism as unity,

$(PQ \times PR)^{\frac{1}{2}}$ is the torque in synchronous watts.

The representation of each of the quantities listed above, with the exception of the speed and the torque, will be appreciated at once from a comparison of Fig. 55b with Fig. 56, combined with a review of the preceding chapter.

SPEED AND TORQUE OF THE SINGLE-PHASE INDUCTION MOTOR.

The speed and the torque can be ascertained in an extremely simple manner as follows: The "speed" field is under any chosen condition equal to the "transformer" field multiplied by the speed. Now the torque is proportional to the product of the "speed" field and that component of the secondary current which is in time phase with it and which crosses the core at the same mechanical position along the air gap as that occupied by the "speed" field. This component of the secondary current is in time quadrature with the "transformer" field, and it has a value such that its product with the primary e.m.f. (for a unity ratio machine) represents the total power received by the secondary—exclusive of the loss due to the secondary excitation current. A little study will show, therefore, that if the "speed field" were equal to the "transformer field," the torque in "synchronous watts" would be equal to the secondary input (excluding the excitation loss). Since the "speed field" varies directly with the speed, it is seen at once that the torque, D , is equal to the secondary input, W_s , multiplied by the speed, S . Thus,

$$D = S W_s. \tag{1}$$

The torque is also equal to the output W_o , divided by the speed, therefore

$$D = W_o \div S \tag{2}$$

hence

$$S = (W_o \div W_s)^{\frac{1}{2}} \tag{3}$$

That is to say, in a *single-phase induction motor the speed is equal to the square root of the secondary efficiency*. When the speed varies only a few per cent. from synchronism the slip is equal to one-half of the secondary loss expressed in per cent., as was pointed out by Mr. B. A. Behrend on page 884 of the issue of the *Electrical World and Engineer* for Dec. 8, 1900. Thus at a speed of .98 the secondary efficiency is .9604; the slip is .02; the loss is .0396. It is interesting to observe in this connection that in a polyphase induction motor the speed is equal directly to the secondary efficiency.

Combining equations (1) and (3) above, it is found that the torque has the following value:

$$D = (W_0 \times W_s)^{\frac{1}{2}} \quad (4)$$

That is to say, the torque is equal to $(PQ \times PR)^{\frac{1}{2}}$ from Fig. 56, as used above.

It is especially worthy of note that the speed and torque as here determined are not affected by the substitution of the modified circuits of Fig. 55b for the more nearly exact circuits of Fig. 55a. The method here outlined gives correct results both at synchronism and at standstill, and at other intermediate speeds the slight errors introduced are of both positive and negative values, and they tend to cancel in the final results.

On account of the fact that at speeds below synchronism there is a slight decrease in the "transformer-field" current and a large decrease in the "speed-field" current (as it reacts upon the primary), while Fig. 56 assumes both of these currents to be constant, the operating power factor of a single-phase motor is somewhat greater than that shown in Fig. 57. The discrepancy is appreciable only in those cases where the "synchronous no load" current is large in comparison with the starting current. Thus Fig. 57 gives the power factor accurately for large motors, but small motors will show better power factors than there indicated.

It is instructive to compare the performance of a certain polyphase motor, when operated normally, with that of the same machine when used as a single-phase motor. Using "equivalent single-phase" quantities throughout, the polyphase starting current of the motor, whose single-phase circle diagram is shown by the arc $OPFK$ in Fig. 56, would be repre-

sented by the line $MF F'$ (not completely drawn) having a length equal to twice that of the line MF (not drawn). The polyphase current locus is a circle passing through F' and O , its center being on the line ON prolonged. If the machine is operated as a single-phase motor at a certain primary current, such as shown by MP in Fig. 56, the output is PQ , as noted above. If the same output is to be obtained when the machine is operated polyphase, then the equivalent single-phase value of the polyphase current will be MP' (not drawn), the line PP' being (practically) parallel with the line OF . Thus the volt-amperes input as a single-phase machine is greater than as a polyphase machine in the ratio of MP to MP' and the power factor is less in the ratio of $\cos EMP$ to $\cos EMP'$; the losses are also greater.

CAPACITIES OF SINGLE-PHASE AND POLYPHASE MOTORS.

Although the circular diagram as developed above is applicable to all types of single-phase induction motors, the comparison just made refers exclusively to polyphase motors and the same motors used on single-phase circuits. The comparison between single-phase and polyphase machines is not quite so unfavorable to the former when each machine is designed primarily for its particular work. When a polyphase motor is operated as a single-phase machine, only a portion of the primary copper is fully employed; evidently a greater output can be obtained by altering the inter-connections of the coils so as to use all of the copper.

With an induction motor having uniformly distributed coils, when the iron is subjected to the same magnetic density and frequency, and the same current density is used in the copper, the output varies largely with the groupings of the coils. Thus it may be shown that with such a motor the volt-ampere input can be represented, relatively, by the periphery of a polygon having sides equal in number to the number of groups per pair of poles, of which polygon the circumscribing circle represents the volt-ampere input for infinite groups, and double the diameter represents the input to the single-phase motor. Giving to the diameter of the circumscribing circle an arbitrary value of unity, the inputs to the machine for various groupings of coils are as follows:

Number of Groups.	Type of Machine.	Volt-Ampere Input
2	Single-phase	2.000
3	Three-phase	2.598
4	Four-phase	2.828
	(Two-phase)	
6	Six-phase	3.000
	(Three-phase)	

Since the coils of commercial two-phase induction motors are grouped similarly to those of a four-phase machine and the coils of a three-phase motor are arranged similarly to those of a six-phase machine, a three-phase motor has a volt-ampere input 1.061 times that of a two-phase motor (on the basis of equality losses), while the volt-ampere input of a single-phase motor is .707 times that of an equivalent two-phase machine. The facts upon which these statements are based are discussed more fully in the next chapter.

CHAPTER X.

MAGNETIC FIELD IN INDUCTION MOTORS.

POLYPHASE MOTORS.

In construction an induction motor possesses as primary windings, coils placed mechanically around a core and separated as to polarization effects by the same number of angular degrees as the currents, which flow in the individual coils, differ in electrical time degrees, a two-pole model being assumed. Thus in a two-phase (or quarter-phase) machine the coils would be located 90 degrees one from the other, and in a three-phase motor the angular spacing would be 60 degrees (120 degrees).

Consider a two-polar quarter-phase machine upon the separate windings of which there are impressed e.m.fs. in time quadrature. The e.m.f. at each coil demands that at each instant the resultant magnetism threading that coil have a certain definite value such that its rate of change generates in the coil the proper value of counter e.m.f., just as is true in any stationary transformer. No action which takes place within the machine can rob the primary coils of this transformer feature. Assume that the flux (and e.m.f.) follows a sine law of change of value with reference to time and let ϕ be the maximum value of flux demanded by the e.m.f. of each coil. Then at a given instant the e.m.f. in coils 1 and 2 expressed in c.g.s. units will be, for N effective turns.

$$e_1 = N \frac{d\phi}{dt} \sin \omega t \quad \text{and}$$

$$e_2 = N \frac{d\phi}{dt} \sin \left(\omega t - \frac{\pi}{2} \right) \quad \text{hence}$$

$$e_1 = N \omega \phi \cos \omega t$$

$$e_2 = N \omega \phi \sin \omega t \quad \text{or at}$$

any certain time t , the flux demanded by the e.m.fs. must have

a value of $\phi \cos \omega t$ threading coil 1, and $\phi \sin \omega t$ threading coil 2.

In commercial induction motors the coils of one phase winding overlap those of the other, each winding being distributed over an area inversely proportional to the number of primary phases. The distributed character of the windings is such that the flux which threads one winding simultaneously threads the other, the distribution of the flux alone determining the actual effective value threading each coil at each instant. This feature of the winding combined with a slight value of modifying current in the closed conductors of the secondary winding is such that at any time t the fluxes in the two phase motor core have values $\phi \cos \omega t$ and $\phi \sin \omega t$ so distributed as to give a resultant of

$$\sqrt{\phi^2 \cos^2 \omega t + \phi^2 \sin^2 \omega t} = \phi.$$

That is to say, the resultant core flux is constant in value, but varies in position, producing the so-called revolving field. This field travels at a speed termed "synchronous," as found by the ratio of alternations per unit time to the number of poles of the machine.

Within this revolving field is placed the secondary winding which in most cases is closed upon itself either directly or through certain variable resistance. When the rotor is traveling at synchronous speed, the secondary conductors are not subjected to change in flux except to the slight extent due to the irregularities of the magnetic field, so that at this speed only the modifying current previously referred to flows in the secondary, and this current tends to cause the revolving field to have a truly constant value.

In studying the internal actions of the induction motor, it is helpful to consider that there exists a revolving field of a certain value traveling at synchronous speed; that this field cuts the primary conductors at synchronous speed and at a rate to generate therein the proper counter e.m.f. and that the secondary conductors cut across this field at a rate depending upon the difference in the speeds of the rotor and of the revolving field, that is upon the "slip" from synchronism. According to this conception the effective value of the e.m.f. counter generated in each conductor on the face of the primary core will be the same irrespective of its mechanical position,

but the time-phase position of this e.m.f. will vary directly with the location on the core. When a number of conductors are connected in series to form a primary coil, the effective value of the resultant e.m.f. counter generated therein will be the vector sum of the e.m.f. of the individual conductors. From this fact may be determined the core flux necessary to give a certain counter e.m.f. with a certain distribution of the primary conductors.

It is the purpose of the present chapter to discuss the facts upon which these statements are based, to show that the space distribution of the revolving magnetic flux follows a sine law, and to outline the method by which the implied considerations can be utilized in the treatment of induction motor phenomena.

In explanation of several of the terms used below it should be stated that, in dealing with the magnetic field in induction motors of the multipolar type, it is necessary to distinguish between "electrical-time" degrees, "electrical-space" degrees and "mechanical-space" degrees. Thus, in a four-pole machine, 90 electrical-space degrees correspond to 45 mechanical-space degrees. Two fluxes may be said to be in electrical-time quadrature when one reaches its maximum 90 time degree ($\frac{1}{4}$ cycle) before or after the other. Independent entirely of their time-phase position, they would be in electrical space quadrature if their mechanical positions in the air-gap of a four-pole machine were displaced 45 mechanical-space degrees one from the other.

Numerous writers when discussing the flux in the air-gap of induction motors have stated in substance or have implied by their method of treatment that the space distribution of the magnetism depends largely upon the number of slots per pole per phase, and that the approximate sine wave found for the space-value of the flux is to be attributed to the subdivision of the coils of each pole winding. In order to lay emphasis on the fact that the space distribution of the magnetism is largely independent of the distribution of the primary coils, and to lend simplicity to the explanations, the initial treatment below will be based on the assumption of coils of each phase being placed in a single slot per pole, giving the maximum of concentration. The modifications which the distribution of the coils may introduce in the value of the flux, will later be treated in the simplest possible manner. It is well at this point to make

note of the fact that the effective value of the flux threading each primary coil is determined solely by the primary e.m.f., but that the space distribution of the flux depends upon the demands of the secondary circuits.

MAGNETIC DISTRIBUTION WITH OPEN SECONDARY.

Figs. 57 to 77 indicate the behavior of the magnetism in the separate phase windings, and throughout the air-gap of a two-phase induction motor both when the secondary is on open circuit and when it is on closed circuit with the rotor running at synchronous speed. It is well to investigate first the action which takes place in a single pole winding of one phase. The effective number of magnetic lines threading this winding is determined by the voltage impressed upon the coil and upon the number of alternations of the e.m.f. At each instant the resultant magnetism must have a value such that its rate of change generates in the coil the proper counter e.m.f., and for constant frequency this value is quite independent of any condition other than the pressure alone. A variation in the reluctance of the path of the lines alters only the magnetomotive force necessary to produce the lines. This magnetomotive force is supplied by current through the windings, having a value such that the ampere turns produce the required magnetomotive force.

If the individual coils of the second phase of the two-phase primary winding, which are located on the core 90 electrical space degrees from those of the other phase, be subjected to the same conditions as assumed for the first phase, obviously the same results will be obtained. If the coils of both phases be subjected simultaneously to equal effective pressures at an electrical time displacement of 90 degrees from each other, operating conditions for a two-phase motor will be obtained.

At each instant the rate of change of interlinking lines and turns per pole for the windings of each phase will be quite independent of any condition other than the instantaneous value of the pressure of that phase, so that the presence of the windings of the second phase can in no manner alter the effective value of interlinkages of the first phase winding, though a change in distribution of actual lines may occur.

When the windings of one phase alone are energized, the core

magnetism evidently reaches its zero value once for each alternation of the pressure. With the pressure simultaneously active on the second phase winding, when the effective magnetism

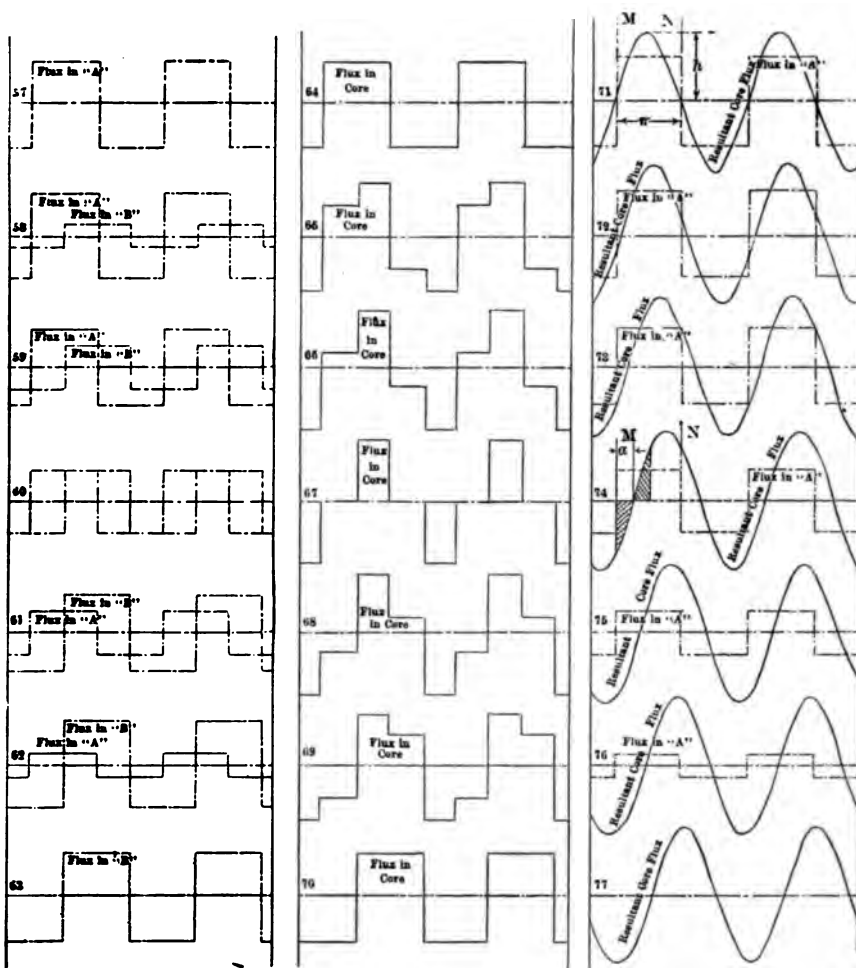

FIGS. 57-63.—Flux Demanded by each Phase; Secondary open.

FIGS. 64-70.—Resultant Core Flux; Secondary Open.

FIGS. 71-77.—Resultant Core Flux; Secondary Closed.

which threads the coils of the first phase is at its zero value, the magnetism threading the other phase is at a maximum. Now, since the coils of both phases occupy the same core and, in fact,

the windings of each phase in effect surround the whole polar area of the core, the condition of zero effective magnetism for one phase winding can be accounted for only by the fact that each pole winding of that phase surrounds an equal number of north and of south lines. See Figs. 57 and 63.

In intermediate conditions of the magnetism, the number of effective lines surrounded by the windings of each phase depends upon the slope of the e.m.f. curve of each phase considered separately. If the electromotive force of each phase follows a sine curve of time-value, the relative number of effective lines surrounded by one phase will vary as the product of the maximum lines into the cosine of the angle of time, while those of the other phase at the same instant will vary as the sine of the same angle.

The relative changes in the values of the magnetism threading each coil of a two-phase motor at 0, 15, 30, 45, 60, 75, and 90 time degrees (during one-quarter cycle) are shown graphically in Figs. 57, 58, 59, 60, 61, 62, and 63, respectively. The values indicated are those which would be found for each primary phase winding operating singly, the secondary being on open circuit. Figs. 64, 65, 66, 67, 68, 69, and 70, respectively, show the resultant value and distribution of the core flux when the two-phase windings are subjected simultaneously to electromotive forces in time quadrature. By comparing, say Fig. 59 with Fig. 66, it will be seen that the effective value of the flux threading each coil of one phase is in no way altered by the presence of the flux demanded by the e.m.f. impressed on the other phase winding. It is to be noted particularly that the flux produced by a current of any value whatsoever in one-phase winding has absolutely no effect upon the interlinkage of flux with the coils of the other phase. It is noteworthy also in this connection that the magnetomotive force necessary to produce a certain effective flux in one-phase winding is neither increased nor decreased by the presence of the flux due to the magnetomotive force of the other phase winding. That is to say, with the secondary on open circuit, each phase winding operates as though the other were not present, and as though it alone occupied the core.

A comparison of Fig. 67 with Figs. 64 and 70 and the intermediate Figs. 65, 66, 68, and 69, will reveal the fact that,

when the secondary is on open circuit, the resultant core flux changes in mechanical position along the core, it varies in space distribution, and alters both in magnetic density and in total existing magnetic lines. Thus in Fig. 67, the flux is distributed over only one-half of the core area, where the magnetic density is $\sqrt{2}$ times that indicated in Figs. 64 and 70, and the total number of magnetic lines is only $\sqrt{.5}$ times that shown in either Fig. 64 or Fig. 70. It is seen, therefore, that under the condition here assumed, giving separately to the density and to the total flux in Fig. 67 or Fig. 70, the arbitrary value 100, the density of the core flux varies from 100 to 141.4 and the total number of lines existing on the core varies from 100 to 70.7 four times during each cycle.

By noting the electrical space positions of the resultant core flux in Figs. 64, 67, and 70, it will be seen that the flux moves along the air-gap 45 electrical space degrees during 45 electrical time degrees, and that it advances a total of 90 electrical space degrees during 90 electrical time degrees. Thus, even when the secondary is on open circuit it travels around the air-gap at a certain definite speed termed "synchronous," although it varies in value and in space distribution.

MAGNETIC DISTRIBUTION WITH CLOSED SECONDARY.

Assume, now, that the rotor is driven by some external means so that it travels at exactly synchronous speed. If the secondary conductors are on open circuit, electromotive forces will be generated in them locally by the rate of change of the synchronously moving core flux. If now the secondary circuits be closed the electromotive forces generated by the changing core flux will produce currents in the secondary, which tend to prevent the variation in the magnetism which links with the secondary conductors.

If the secondary circuits are thoroughly distributed over the secondary core, and are of perfect conductivity, then the most minute change in the value or space distribution of the synchronously moving magnetism will produce an enormous secondary current tending to maintain both the distribution and the value of the flux. As stated previously, the e.m.f. across each primary coil demands that a certain effective value of core flux at each instant threads through that coil, but the requirements of the

e.m.f. are met as fully with one space distribution of the flux as with another, so long as the effective value remains the same.

The exacting requirements of the secondary conductors and of the electromotive forces impressed upon the phase windings of the primary coils are completely fulfilled when the core flux assumes a sine curve of electrical space distribution, as shown in Figs. 71 to 77, inclusive. The proof of this statement is given below.

A comparison of the sine curve of Fig. 71 with the rectangular curve of Fig. 64 will serve to determine the value of the maximum ordinate of the sine curve. Since the area included between each curve and its base line must be the same in the two cases, the maximum ordinate of the sine curve must be

$\frac{\pi}{2}$ times the maximum ordinate in the curve of Fig. 64, as will be verified incidentally below.

A comparison of Fig. 67 with Fig. 64 will show at a glance that the area enclosed by the former curve is much smaller than that enclosed by the latter, and the question naturally arises as to the possibility of any curve which surrounds a constant area serving to meet the demands for effective areas which differ so widely as do those indicated by the curves of Figs. 64 and 67.

It will be observed that in connection with the sine curves of constant value but variable position shown in Figs. 71 to 77, inclusive, there are given also rectangular curves of constant position but variable value, which, as will be seen from Figs. 57 to 63, inclusive, indicate the demand for effective area (magnetism) made by the e.m.f. of phase *A*. It remains now to be demonstrated that between the two points *M* and *N* which are constant in position, there is intercepted from the area represented by the sine curve as it moves along synchronously, an effective area equal in magnitude at all times to the area represented by the rectangular curve.

Referring now to Fig. 71 let

$$h = \text{maximum ordinate of sine curve,}$$

then

$$y = h \sin x \text{ is the equation of the sine curve.}$$

The average ordinate of the whole curve from *M* to *N* (π radians) is

$$\frac{h}{\pi} \int_0^{\pi} \sin x \, dx = \frac{h}{\pi} \left[-\cos x \right]_0^{\pi} = \frac{2h}{\pi} \quad (1)$$

Since the area of the sine curve is equal to that of the rectangular curve in Fig. 71, the maximum ordinate of the sine curve is equal to $\frac{\pi}{2}$ times that of the rectangular curve, as mentioned previously.

In Fig. 74, let the distance that the zero ordinates of the curve have traveled from M and from N be represented by a . Then the area below the base line will have the numerical value of

$$h \int_0^a \sin x \, dx = h \left[-\cos x \right]_0^a$$

$$h [-\cos a - (-\cos 0)] = h (1 - \cos a) \quad (2)$$

This area will in effect neutralize an equal positive area, so that the remaining effective area will be

$$h \int_0^\pi \sin x \, dx - 2h \int_0^a \sin x \, dx =$$

$$2h - 2h (1 - \cos a) = 2h \cos a \quad (3)$$

This equation shows that the effective area bounded between the ordinates at M and N and the sine curve is proportional directly to the cosine of the angle of displacement of the curve from the position giving the maximum area, as was assumed above.

The interpretation of the above equation is that the effective area bounded by the sine curve and the ordinates M and N in Figs. 71 to 77 inclusive is in each case equal to the area represented by the indicated rectangular curve. That is to say, magnetism of constant magnitude and distributed according to a sine curve of electrical space value will, when traveling synchronously around the air-gap, generate within each coil an electromotive force having a sine wave of electrical-time value. The relative electrical-time-phase position of the electromotive forces of coils distributed around the air-gap will depend solely upon the electrical-space positions of the coils. If independent sets of coils are located at intervals of 90 electrical-space degrees, the electromotive forces generated therein will vary from each other by $\frac{1}{4}$ period, and the coils may be interconnected to form

a four-phase motor, or the opposite phase windings of this four-phase machine may be joined so as to form the familiar two-phase induction motor. Similarly, if independent sets of coils are located at intervals of 60 electrical-space degrees, the electromotive forces generated therein will vary from each other by $\frac{1}{3}$ period and the coils may be interconnected to form a six-phase motor, or the opposite phase windings of this six-phase machine may be joined so as to form the familiar three-phase induction motor.

DETERMINATION OF CORE FLUX.

The determination of the value of the core flux can be based either upon the fundamental transformer equation or upon the equation used with alternating-current generators. Let

n = number of turns in series per primary coil.

E = effective value of primary e.m.f. per coil.

f = frequency in cycles per second.

From transformer relations

$$E = \frac{\sqrt{2} \pi}{10^8} f n \cdot \phi_m \quad (4)$$

where ϕ_m is the maximum value of the total flux threading the coil.

Let A = the total air-gap area covered by the coil.

When the secondary is on open circuit, and only one phase winding is active,

$$B_m = \frac{\phi_m}{A} = \frac{10^8 E}{\sqrt{2} \pi f n A} \quad (5)$$

where B_m is the maximum magnetic density at any point along the air-gap. (See Fig. 57.)

When the secondary is on open circuit and both phase windings are active. (See Fig. 67.)

$$B_m = \frac{\sqrt{2} \phi_m}{A} = \frac{10^8 E}{\pi f n A} \quad (6)$$

When the secondary circuit is completely closed and the rotor is running at synchronous speed. (See Figs. 71 to 77.)

$$B_m = \frac{\pi \phi_m}{2 A} = \frac{10^8 E}{2 \sqrt{2} f n A} \quad (7)$$

Treating the machine now as an alternator having n turns in series on the armature, with a flux of ϕ_m total lines per pole,

$$E = \frac{\sqrt{2}\pi}{10^8} f n \phi_m \quad (8)$$

and the maximum magnetic density is, as found above,

$$B_m = \frac{\pi \phi_m}{2 A} = \frac{10^8 E}{2 \sqrt{2} f n A} \quad (9)$$

The proof of the identity of the equations derived from transformer and from alternator relations as given above, has been based upon the assumption of sine curves of electromotive forces. It is evident that, since the effective magnetism threading each coil must vary at each instant according to the instantaneous value of the e.m.f., when the e.m.f. wave is distorted the core flux must likewise vary from a sine curve of electrical space distribution. It is an interesting conclusion, which permits of easy verification that *the mechanical distribution of the core flux follows a wave of electrical-space value similar in all respects to the electrical-time value of the primary electromotive force*. This fact will be appreciated immediately if one considers that the instantaneous value of the e.m.f. generated in each armature conductor depends directly on the local magnetic density of the field through which it is moving at that instant.

EFFECT ON CORE FLUX OF USING DISTRIBUTED WINDING.

The problem of determining the effect of distributing the windings of each phase over a certain portion of the air-gap instead of concentrating them in one slot per pole, as assumed above, is rendered extremely simple by treating the machine as an alternator, as was intimated in the opening paragraphs of this chapter. If the conductors which cross the face of the core and are joined in series to form a primary coil of one phase, are distributed over β electrical-space degrees, then the resultant e.m.f. for a certain core magnetism is less than the arithmetical sum of the individual e.m.f. of the several conductors in the ratio of the cord of angle β to the arc of the same angle. This result follows directly from the fact that the individual e.m.f.s. are not in phase one with the other and it is necessary to take the vector sum of them.

In a two-phase motor (the equivalent of a four-phase machine) the angle β is

$$\text{angle } \beta = 90 \text{ degrees}$$

$$\text{arc of } \beta = \frac{\pi}{2}$$

$$\text{cord of } \beta = \sqrt{2}$$

Therefore, in a two-phase motor, the maximum magnetic density may be expressed as

$$B_m = \frac{\pi}{2\sqrt{2}} \cdot \frac{10^8 E}{2\sqrt{2} j n A} = \frac{\pi}{8} \cdot \frac{10^8 E}{j n A} \quad (10)$$

In a three-phase motor (the equivalent of a six-phase machine) the angle β is

$$\text{angle } \beta = 60 \text{ degrees}$$

$$\text{arc of } \beta = \frac{\pi}{3}$$

$$\text{cord of } \beta = 1$$

Therefore, in a three-phase motor the maximum magnetic density may be expressed as

$$B_m = \frac{\pi}{3} \cdot \frac{10^8 E}{2\sqrt{2} j n A} = \frac{\pi}{6\sqrt{2}} \cdot \frac{10^8 E}{j n A} \quad (11)$$

Both equation (10) and equation (11) have been derived on the basis of the initial assumption that each turn of each coil spans an arc of 180 electrical space degrees. It is evident that if each turn covers an area less than that indicated by an arc of 180 degrees, the magnetic density must have a value greater than that given by these equations. In commercial induction motors one side of each coil is placed in the bottom of a certain slot and the return side of the same coil is placed in the top of another slot, with an arc of less than 180 electrical space degrees between the slots.

Let the span of each coil be γ electrical-space degrees, then the e.m.f. generated in the one side of each coil will be γ electrical-time degrees out of phase with the e.m.f. in the other side of the same coil. If e is the e.m.f. in one side of a coil, the resultant e.m.f. of the coil will be

$$E_c = \sqrt{2} e \sqrt{1 + \cos (180 - \gamma)} \quad (12)$$

When $\gamma = 180$ equation (12) reduces to

$$E_c = 2e \quad (13)$$

Hence, in general, for a two-phase motor

$$B_m = \frac{\pi}{8} \cdot \frac{10^9 E}{f n A} \cdot \frac{\sqrt{1 + \cos(180 - \gamma)}}{\sqrt{2}} \quad (14)$$

and for a three-phase motor,

$$B_m = \frac{\pi}{12} \cdot \frac{10^9 E}{f n A} \cdot \sqrt{1 + \cos(180 - \gamma)} \quad (15)$$

The last two equations refer to the magnetic density immediately at the bottom of the teeth of the primary core. The local magnetic density in the air-gap will depend upon the relative size of the slots and the teeth, and will be greater than that shown by these equations.

EFFECT ON CAPACITY OF VARYING THE GROUPING OF COILS.

An examination of the formation of equation (10), (11), (14), and (15) will reveal the fact that if in a certain induction motor the maximum value of the magnetic density is to remain constant while the coils are interconnected in different ways, the e.m.f. of each group of coils may be represented relatively as the cord of the arc in electrical space degrees which is covered by the coils in the group. It follows therefore that if one-half of the coils are connected continuously in series the total e.m.f. of the group of n coils in each of which there is an e.m.f. of e volts will be $\frac{2n}{\pi} e$ volts. If this value of volts be taken as unity, for the sake of comparison, then when one-third of the coils are joined in continuous series the total voltage of the group will be .866 volts. Likewise a group containing one-fourth of the coils would have a voltage of .707, and a group containing one-sixth of the coils would have a voltage of .500.

If now it be assumed that each coil is to carry the same current as the other coils, then the volt-amperes per group will vary directly with the voltage. In consequence of this fact the total volt-amperes of an induction motor when operated at constant maximum magnetic density in the core and

constant current density in the coils will be as follows for various groupings of the coils, assuming unit current:

Number of Groups.	Voltage per Group.	Total Volt-amperes.	Type of Machine.
2	1.000	2.000	Single-phase
3	.866	2.598	Three-phase
4	.707	2.828	Quarter-phase
6	.500	3.000	Six-phase (Three-phase)

The relations shown in the above table were commented on in the preceding chapter. It will be noted that the volt-amperes rating of a single-phase motor are .707 times that of a quarter-phase machine. A little study will show that a few of the primary coils of each group may be removed without seriously decreasing the volt-amperes of the single-phase machine. Thus it is possible to materially decrease the primary copper without a proportionate decrease in the volt-amperes, as shown by the following table:

Percentage of Coils.	Percentage of Volt-amperes	Saving in Copper	Decrease in Input
100.00	100.000	.00	.00
88.89	98.48	11.11	1.52
77.78	93.97	22.22	6.03
66.67	86.60	33.33	13.40
55.56	76.60	44.44	23.40
50.00	70.70	50.00	29.30

It is seen from the above that a portion of the primary copper could be removed and yet the performance of the machine would be only slightly affected. It might seem that this fact would permit of a considerable saving in material, but a motor thus constructed would not in general be capable of being rendered self-starting from its primary circuits. It is the usual practice therefore to wind the primary completely and to use only a portion of the coils during normal operation, all of the coils being employed during the starting period. Commercial single-phase induction motors are frequently constructed as uniformly-wound three-phase machines, or as unsymmetrically wound two-phase machines. In the latter case the "main" winding contains

about twice as much copper as the "starting" winding, and it occupies two-thirds of the core slots.

EXCITING WATTS IN INDUCTION MOTORS.

In the treatment above, the part played by the primary current in producing the revolving field has been practically neglected. It is well in this connection to show how the value of the exciting current may be determined directly from the volume of the air-gap and the volume of the core material, without reference to the required magnetomotive force, the number or the distribution of the primary coils.

In Fig. 78A, let

A = area of magnetic path, in sq. cm.

l = length of path in iron, in cm.

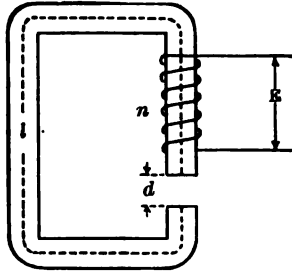

FIG. 78A.—Simple Magnetic Circuit.

μ = permeability of iron.

d = length of path in air.

n = number of turns of coil.

E = effective value of impressed e.m.f., in volts.

ϕ = any chosen value of flux.

i = any chosen value of exciting current, in amperes.

I_q = effective value of exciting current.

ϕ_m = maximum value of flux.

From fundamental magnetic relations

$$\text{Flux} = \frac{\text{m.m.f.}}{\text{reluctance}}$$

$$\phi = \frac{4 \pi n i}{10} \cdot \frac{A}{\left(d + \frac{l}{\mu}\right)} \quad (16)$$

As is well known, the reluctance of commercial magnetic material is not constant for all densities, and hence it is not proper to assume that the exciting current is sinusoidal when the flux is sinusoidal. When iron is included in the magnetic path, the exciting current wave will be peaked. When the major portion of the reluctance of the path is in air, the effect of the distortion produced by the presence of the variable reluctance of the iron will not in general be very marked, and for all practical purposes it may well be neglected.

Thus, if the maximum value of the exciting current is i_m , the effective value will be slightly different from $\sqrt{.5} i_m$, but since, in any event, the actual value of i_m cannot be predetermined with a high degree of accuracy, due to the fact that the true value of μ is not known, it is safe to assume that for induction motors no measurable error is introduced by representing the effective value of the exciting current by the equation.

$$I_q = \sqrt{.5} i_m \quad (17)$$

$$\phi_m = \frac{4 \pi}{10} \sqrt{2} I_q n \left(d + \frac{l}{\mu} \right) \quad (18)$$

$$I_q = \frac{10 \phi_m \left(d + \frac{l}{\mu} \right)}{4 \pi \sqrt{2} n A} \quad (19)$$

But

$$E = \frac{\sqrt{2} \pi n f \phi_m}{10^8} \quad (20)$$

Hence the (quadrature) exciting watts may be expressed as

$$W_q = E I_q = \frac{2.5 f \phi_m^2}{10^8 A} \left(d + \frac{l}{\mu} \right) \quad (21)$$

Let $V_i = A l =$ volume of iron.

$V_a = A d =$ volume of air.

Then

$$\frac{\phi_m^2}{A} \left(d + \frac{l}{\mu} \right) = \frac{\phi_m^2}{A^2} \left(d A + \frac{l A}{\mu} \right) = B_m^2 \left(V_a + \frac{V_i}{\mu} \right) \quad (22)$$

and

$$W_q = \frac{2.5 f}{10^8} B_m^2 \left(V_a + \frac{V_i}{\mu} \right) \quad (23)$$

where B_m is the maximum magnetic density, in lines per square centimeter.

The interpretation of equation (23) is, that in order to ascertain the (quadrature) exciting watts it is necessary to know only the maximum magnetic density, the volume and the permeability of the iron, and the volume of the air-gap. That is to say, *the very quantities which are necessary in order to determine the core losses, will serve simultaneously for the determination of the (quadrature) exciting watts, when the permeability of the core is known.*

Although the erratic behavior of iron with reference to the change in its permeability cannot be reduced to a mathematical expression, it is found that for most practical purposes the permeability of the iron used in transformers and induction motors

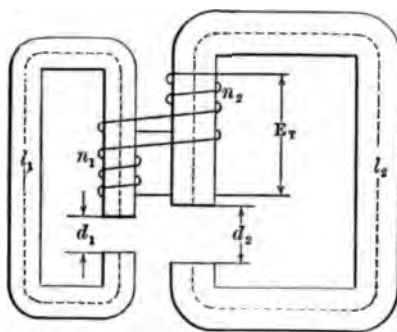

FIG. 78b.—Composite Magnetic Circuit.

may be expressed with a fair degree of accuracy, throughout the range of density from $B_m = 0$ to $B_m = 15,000$, by the equation

$$\mu = 2,800 - 3.2 \frac{(7,500 - B_m)^2}{10^5} \quad (24)$$

Although the proof given above for equation (23) refers primarily to the magnetic circuits represented in Fig. 78a, it can be shown that the facts stated in connection with equation (23) apply equally as well to the circuits indicated in Fig. 78b and to the more complex circuits existing in both single-phase and polyphase motors.

Thus, making use of proper subscripts, in Fig. 78b,

$$W_q = \frac{2.5 f}{10^8} \left[B_{1m}^2 \left(V_{1a} + \frac{V_{1i}}{\mu_1} \right) + B_{2m}^2 \left(V_{2a} + \frac{V_{2i}}{\mu_2} \right) \right] \quad (25)$$

It may be shown theoretically and verified experimentally, that the (quadrature) exciting watts of a certain polyphase motor are the same in value when all phase windings are used or when only one winding is subjected to the primary pressure. Thus, when one phase winding of a two-phase motor is open-circuited, the other winding immediately takes double its former value of (quadrature) exciting current, the (quadrature) exciting watts remaining the same. These facts are discussed more fully in the next chapter.

It seems, therefore, that the most logical way to determine the exciting current of an induction motor is to ascertain the density of the magnetism in the core and in the air-gap, and then calculate the quadrature watts, just as one ordinarily calculates the core loss watts.

MAGNETIC FIELD IN THE SINGLE-PHASE INDUCTION MOTOR.

As was mentioned in a previous chapter, when the circuits of a polyphase induction motor operating near synchronism are so arranged as to convert the machine into a single-phase motor, the revolving field, which was previously due to the combined actions of certain components of the displaced polyphase currents, continues to exist, and the action of the machine in developing mechanical power is subjected to almost no change. It is equally well known that the quadrature "speed" component of the magnetic field is produced by current in the secondary, and that the magnetomotive force represented by this secondary current must be supplied by a component of primary current. On account of the fact that the secondary current which produces the quadrature "speed field" occupies a position in space such that it cannot possibly react directly on the field produced by the primary current, it is not immediately apparent in what manner the "quadrature watts" for the "speed field" are supplied by the primary exciting magnetomotive force.

A popular method of treating the internal behavior of a single phase induction motor is the one due to Ferraris, who showed that the simple alternating field can, in all of its effects, be replaced by two revolving fields moving in opposite directions, the maximum value of each being equal to one-half of the maximum value of the alternating field. By means of this method

it is possible to ascertain the distribution of current in the secondary, and the reaction of certain components of the secondary current upon the primary, but the present writer believes that the actual significance of the results obtained, as viewed by the average reader, are greatly obscured by the difficulty in distinguishing the imaginary from the real when the two are so closely interwoven.

A prominent writer of the present day states that "the cause of the cross magnetization in the single-phase induction motor near synchronism, is that the induced armature currents lag 90° behind the inducing magnetism and are carried by the synchronous rotation 90° in space before reaching their maximum"; and that "below synchronism the induced armature currents are carried less than 90° , and thus the cross magnetization due to them is correspondingly reduced and becomes zero at standstill." It is greatly to be doubted if these statements convey any physical idea whatever to a mind not already thoroughly familiar with the facts.

Although the method outlined below will not serve to present any facts which cannot be ascertained by other methods which have frequently been employed, yet it is believed that much good can be accomplished by drawing attention to the fact that all of the phenomena connected with the production of the magnetic field in the single-phase induction motor can be investigated with the utmost simplicity by dealing directly with well-known electro-magnetic relation without resorting to imaginary physical or mathematical representations. This method has been touched upon in a preceding chapter. It is believed that a more extended discussion thereof is desirable at this point.

PRODUCTION OF SPEED-FIELD CURRENT.

Fig. 79 shows a two-pole model of a single-phase induction motor which is represented as possessing four mechanical poles, two of which (1 and 3) are excited by single-phase alternating current. Merely for sake of simplicity in explanation, mechanical poles 2 and 4 are indicated as subjected exclusively to the flux of the "speed field." Under any condition of operation the flux in poles 1 and 3 is determined directly by the primary e.m.f., modified by the volts consumed in the local impedance

of the primary coil by the current which flows therethrough. That is to say, the flux in these poles follows the laws which relate to stationary transformers; no action which takes place in the secondary can rob the primary of this transformer feature. In dealing with the secondary, however, it is necessary to recognize the fact that each rotor conductor is subjected to four distinct electromotive forces—the e.m.f.'s produced by the rate of change of the transformer and of the speed fields, and the e.m.f.'s generated by the motion of the rotor through the transformer and speed fields. Each of these e.m.f.'s will

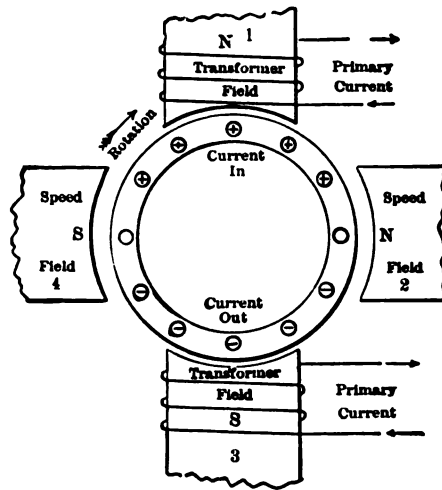

FIG. 79.—Production of "Speed-field" Current.

be treated separately and the combined effects will then be investigated.

When the rotor is moving across the transformer field in the direction indicated, there will be generated in each of the conductors under the poles an e.m.f. proportional to the product of the field magnetism and the speed of the rotor. Evidently if the speed be constant, of whatsoever value, this e.m.f. will vary directly with the strength of magnetism; that is, will be maximum when the magnetism is maximum, and zero at zero magnetism. Other conditions remaining the same the maximum value of this secondary e.m.f. will vary directly with the speed of the rotor.

If the circuits of the rotor conductors be closed, there will tend to flow therein currents of strengths depending directly upon the e.m.f.'s generated in the conductors at that instant and inversely upon the impedance of the rotor conductors. The current which flows through the rotor circuits at once produces a magnetic flux which by its rate of change in value generates in the rotor conductors a counter e.m.f. opposing the e.m.f. that causes the current to flow, and of such a value that the difference between it and this e.m.f. is just sufficient to cause to flow through the local impedance of the conductors a current whose magnetomotive force equals that necessary to drive the required lines of magnetism through the reluctance of their paths. Since this latter magnetism must have a rate of change equal (approximately) to the e.m.f. generated in the rotor conductors by their motion across the primary field, and since this e.m.f. is in time phase with the primary field, it follows that this magnetism must have a value proportional to the rate of change of the primary magnetism; that is, it is (approximately) in time quadrature to the primary magnetism.

A study of the direction of the currents in the rotor under the conditions assumed will show that when a north pole at 1 (in Fig. 79) has reached its maximum value and is decreasing towards zero, the speed field is building up with a north pole at 2, and that this pole continues to increase in strength until the magnetism at 1 reverses its direction. Thus, it may be stated that the north pole of the resultant magnetism travels in the direction of motion of the rotor. Since the rapidity of reversal in sign of the "transformer field" poles and of the "speed field" poles depends solely upon the frequency, it may be stated that the resultant field revolves at synchronous speed. The "speed field" is equal (approximately) to the product of the "transformer field" and the speed, with synchronism as unity. Thus the resultant field is at any speed elliptical as to electrical space representation; one axis of the ellipse is determined by the "transformer field," while the other depends upon the speed. At synchronism the ellipse becomes a circle; above synchronism the ellipse has its major axis along the "speed field"; at zero speed the ellipse is a straight line, which means that at standstill there is no "space" quadrature flux and hence no revolving field.

Reviewing the electromagnetic processes just discussed, it will be noted that the e.m.f. which produces the "speed field" current is caused by the motion of the rotor through the "transformer field" and is opposed by the rate of change of the "speed field" through the rotor circuits. The mechanical position of the "speed field" current with reference to the primary coil prevents it from reacting directly on the "transformer field." It remains to investigate the effect of the e.m.f.'s generated in the secondary by the rate of change of the "transformer field" through the rotor conductors and by the motion of the rotor conductors through the "speed field." It will be noted at once

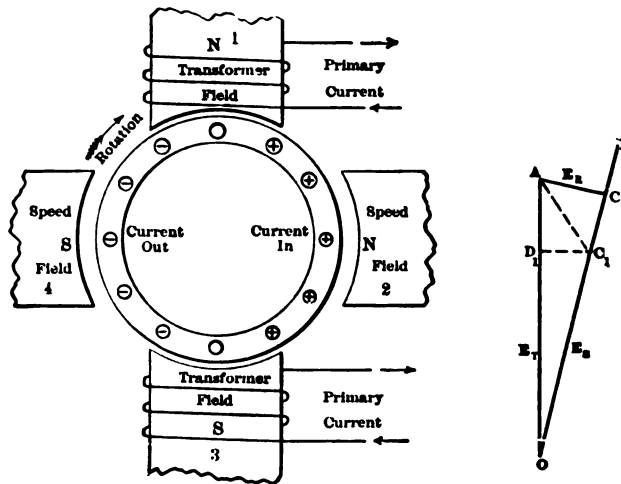

FIGS. 80A and 80B.—Production of Transformer Secondary Currents and Electromotive Forces.

that a current due to either of these e.m.f.'s would be in position to tend to affect the "transformer field."

TRANSFORMER FEATURES OF THE SINGLE-PHASE INDUCTION MOTOR.

Referring now to Fig. 80a assume initially for sake of simplicity that the rotor revolves at absolutely synchronous speed (being driven by some external means). As noted above, the transformer e.m.f. of the "speed field" in the rotor is *slightly less* than the speed e.m.f. of the "transformer field," and is out of time phase therewith, by an amount equal to the e.m.f. necessary

to cause the "speed field" current to flow through the "local" impedance of the rotor conductors. It is seen at once, therefore, that the speed e.m.f. of the "speed field" in the rotor differs from the transformer e.m.f. of the "transformer field" by an *exactly* equal amount, so that a current *exactly equal* to the "speed field" current is produced in the rotor in an electrical space position such that its magnetomotive force tends directly to affect the "transformer field." Since the "transformer field" must have the value demanded by the primary c.m.f., a current equal in magnetomotive force and opposite in direction to this component of the secondary current must flow in the primary coil. As indicated in Fig. 80a, and as may be verified by a study of the fluxes and currents, this component of the secondary current has a time phase position to tend to *decrease* the "transformer field," so that the opposing current in the primary appears as an added component of the primary exciting current. Thus the "speed field" current is accurately represented in the exciting magnetomotive force supplied by the primary current.

It is interesting to note that the "added" component of the primary exciting current depends upon the reluctance of the path taken by the flux of the "speed field"; when the air gap traversed by the "speed field" is much greater than that through which the "transformer field" passes (as shown in Figs. 79 and 80a,) the "added" component is likewise much greater than the true primary "transformer" exciting current. Thus the total quadrature exciting watts are equal to the *sum* of the watts which would be required for producing the same magnetic field by means of two-phase currents in coils wound symmetrically on poles 1, 2, 3 and 4, and not necessarily equal to twice the value initially taken by the windings on poles 1 and 3.

SECONDARY CURRENTS IN THE SINGLE-PHASE MOTOR.

It is instructive to investigate the conditions which would exist if the two components of secondary current at synchronous speed could be caused to continue to flow unaltered with the primary on open circuit. As noted above, the "speed field" current and that component of the secondary current which tends to oppose the transformer field flow in "electrical time quadrature" and occupy positions in "electrical space quad-

ature"; thus, if acting without opposition, they would produce a rotating magnetic field. It is a curious fact, easily appreciated from a study of Figs. 79 and 80a, that this magnetic field would travel around the air-gap in a direction opposite to the motion of the rotor. Since the two exciting components of the secondary current in reality combine in the rotor structure to produce a resultant single current distributed throughout the several conductors, it may be stated that a band of secondary exciting current revolves synchronously in a negative direction. If one considers the time value of the current in a single rotor conductor, he will discover that at synchronous speed this current is of double frequency. As will be shown below, at other speeds the "secondary exciting current" has a value proportional (approximately) to the speed, and it continues to revolve synchronously in a negative direction; thus the frequency of this current in an individual rotor conductor is equal to the primary frequency, f_p , multiplied by one plus the speed, S , with synchronism as unity. That is, $f_s = f_p (1 + S)$.

Consider now the effect of operating the rotor at a speed somewhat below synchronism. Since there is no opposing magnetomotive force in line with the "speed field" the "speed field" component of the rotor current acts as though it alone occupied the secondary conductors, and its value is in no way affected by the presence of any other component of secondary current. Thus, the e.m.f. necessary to force the "speed field" current through the secondary conductors depends solely on the value of the "speed field" component of the rotor current. Since the e.m.f. generated in the secondary by the motion of the conductors through the "transformer field" depends directly upon the product of this field and the speed, it follows that a definite percentage of this speed-generated e.m.f. is consumed in the "local" secondary impedance at all speeds, and that the time phase displacement between the speed-generated e.m.f. and the transformer e.m.f. of the "speed field" is constant at all times. Thus, the "speed field" at speed, S , bears to the "transformer field" a ratio equal to the product of S and a certain constant which denotes the difference in value and phase position of the "speed field" and the "transformer field" at exact synchronism. The significance of this statement is that the "speed field" component of the secondary current has a value proportional

accurately to the product of the speed, S , the "speed field" current at synchronism and the ratio of the "transformer field" at speed, S , to that at synchronous speed.

Since the transformer e.m.f. of the "transformer" field in the rotor depends upon the strength of this field, but is independent of the rotor speed, while the opposing speed e.m.f. of the "speed field" varies with the product of the speed and the "speed field" it follows that the resultant e.m.f. which tends to produce "power" current in the secondary at speed, S , is equal (approximately) to the product of the quantity $(1-S^2)$ and the transformer e.m.f. (See Fig. 80b.) This component of secondary current occupies at all times a space position magnetically in line with the "transformer field," and it reacts upon the primary just as though it flowed through the secondary of a stationary transformer into a non-inductive (fictitious) load resistance; it is superposed in space, but not in time, upon that component of the "revolving secondary exciting current" which directly opposes the "transformer field."

In Fig. 80b let the line OA represent the value of the transformer e.m.f., E_t , of the "transformer field" in the rotor; E_t varies directly with the "transformer field," and hence decreases as the primary current increases. Let the angle AOB represent the time phase difference between E_t and E_s , the speed e.m.f. of the "speed field" in the rotor; the angle AOB is constant at all speeds. At synchronous speed, E_s has a value OC such that the resultant of E_t and E_s gives the electromotive force, E_r , which produces that component of rotor current which reacts upon the primary. At some lower speed, S , E_s has a value OC_1 , such that $OC_1 = S^2(OC)$, neglecting the relative decrease in the value of E_t , and the resultant electromotive force which produces current to react upon the primary is shown by AC_1 . Of this latter e.m.f. the component, C_1D_1 , in time quadrature with the transformer e.m.f., varies with S^2 , the square of the speed; (that is, it decreases when S decreases), while the component, AD_1 , in time phase with the transformer e.m.f., varies with $(1-S^2)$; that is, it increases with decrease of speed. To the latter of these components may be attributed the secondary "load" current, while to the former may be attributed that component of the "negatively revolving exciting current" which directly opposes the "transformer field."

When the rotor is stationary the "load" component of the secondary current in the individual conductors is of the primary frequency, at nearly synchronous speed it pulsates in value in each separate rotor conductor, being unidirectional in certain conductors and alternating at double frequency in certain other conductors situated 90 electrical space degrees from the former.

It is seen, therefore, that there exist in the rotor three components of secondary current, each of the primary frequency with reference to space representation: the "speed field" current, the current having a value closely equal to the product of the "speed field" current, and the speed, but displaced therefrom both in space and in time by 90 electrical degrees, and the load current. Each of these varies in value with the "transformer field." The first varies directly with the speed S . The electromotive force which produces the second varies with S^2 , while the electromotive force which produces the third varies with $(1 - S^2)$. At synchronous speed the first two components are equal in value, while the third is practically zero. At zero speed the first two components are zero and only the third flows in the rotor. Under all conditions the second and third components combine to form the secondary current of the machine considered as a transformer; the second component acts as a continually decreasing (with decrease of speed) wattless current, while the third acts in all respects as though it flowed through the secondary into a non-inductive load resistance.

GRAPHICAL REPRESENTATION OF SECONDARY QUANTITIES.

The relations which exist between the several components of the fluxes, the currents and the electromotive forces in the rotor at various speeds are shown graphically in Figs. 81a and 81b. In Fig. 81a, let the distance, AD , be given an arbitrary value of unity, and let the curve, AED , be a semi-circle. Then if DE is made equal to the speed, S , BD is equal to S^2 . Consider the condition when the speed, S , has the value represented by FD ; the ratio of the "speed field" to the "transformer field" is shown directly by the line, FD ; this line also shows the ratio of the true "speed field" current to the true "transformer field" current, and likewise the ratio of the

component of the secondary current which directly opposes the "transformer field" to the true "speed field" current. Thus, if at the speed shown by FD , AD is assumed equal to the "transformer field" current, DF is equal to the true "speed field" current and CD is equal to the "opposing" component of the secondary current. Furthermore if at the speed, FD , AD be made equal to the e.m.f. which would be produced in the secondary by the "transformer field" with the rotor stationary, CD is the actual speed e.m.f. due to the motion through the "speed field," and AC is the e.m.f. which causes "load" current to flow through the secondary impedance.

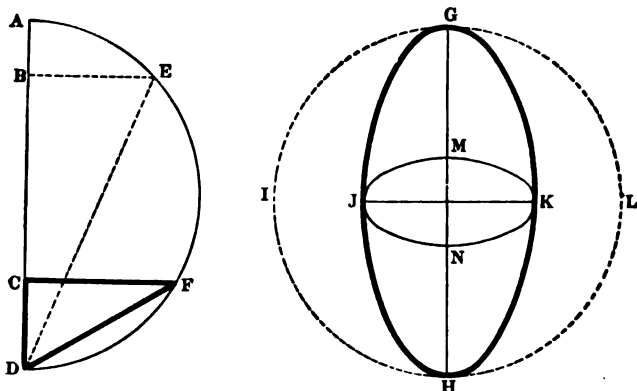

FIG. 81A.—Numerical value of Currents and Electromotive Forces. FIG. 81B.—Time and Space Values of Fluxes and Currents.

It is to be noted especially that the diagram of Fig. 81a gives only the relative numerical values of the various components and does not indicate their time-phase or electrical space positions. The electrical space and time values of the electromotive forces are shown in Fig. 80b, while the equivalent values for the fluxes and currents are represented in Fig. 81b. In this diagram GH is equal to AD of Fig. 81a, while the curve, $GLHI$, is a circle; JK is made equal to FD and the curve, $GKHJ$, is an ellipse; MN is equal to CD and curve, $MKNJ$, is an ellipse. The electrical space value of the flux at synchronous speed is shown by circle, $GLHI$ while at speed, DF , it has the value indicated by ellipse, $GKHJ$. If the line, GH ,

shows the value and phase position of the true "transformer field" current, the line, JK , simultaneously shows the value and phase position of the true "speed-field" current; these currents are in separate electrical structures, and they do not combine directly, but their magnetomotive forces combine to produce the elliptical revolving magnetic field. The value and phase position of the "opposing" component of the secondary current is shown by the line, NM ; this current is in the same electrical structure with the current, JK , and the two combine to produce the "negatively revolving secondary exciting current," shown by curve, KMN , which is elliptical as to space representation.

It is interesting to observe that the actual "speed field" current in the secondary varies directly with the speed, but that the component of the secondary current which reacts directly upon the transformer field varies with the square of the speed, or, more correctly, with the square of the transformer field. It will be noted that on account of this fact the total "quadrature exciting watts" of the single-phase induction motor vary directly with the square of the "transformer field" plus the square of the "speed field." Thus the true exciting watts of the machine at any speed are directly proportional to the sum of the squares of the densities of the fluxes traversing the several magnetic paths, as was mentioned in the last chapter.

CHAPTER XI.

SYNCHRONOUS MOTORS AND CONVERTERS.

SYNCHRONOUS COMMUTATING MACHINES.

The term "synchronous commutating machines" refers to all motors or generators which receive or deliver both alternating and direct current. The machines discussed below are rotary converters and double-current generators, and comparisons are made with the capacities of alternating-current generators or motors of different number of phases.

For simplicity in treatment, the rotary converters are assumed to deliver at the direct-current commutator all of the power received at the alternating end; that is, the output is assumed equal to the input in determining the relative currents on each side, though, as will be seen later, the armature copper loss is properly accounted for. The double-current generators are assumed to deliver equal amounts of power at the commutator and at the collector rings. The assumption is further made that the alternating-current wave in each case follows a true sine curve of time-value.

In a rotary converter the mean flow of alternating current is in a direction opposed to the flow of the direct current, but the absolute value of the alternating current varies from time to time and the direct current reverses direction of flow through the individual coils as each passes under one of the brushes, so that the resultant current in the coils varies both in value and direction of flow from instant to instant and, in general, it has not the same heating effect in different armature coils.

When the alternating current has unity power factor, the maximum value of the current, evidently, occurs when the group of coils of the phase under consideration are developing their maximum e.m.f. The mechanical position of the coils at this instant of maximum e.m.f. is that in which the center of the group of coils is passing at right angles to the lines of force from a field pole—with a non-distorted field this position

would be opposite the center of the field pole. When the coils are passing parallel to the lines of force the e.m.f. is of course zero. At intermediate positions, the value of the e.m.f. may be represented by $E_m \cos \theta$, where E_m represents the maximum e.m.f. and θ the angle between the instantaneous position of the coils and a line from the pole center to the center of the armature shaft.

The absolute value of the maximum e.m.f. depends upon the number of coils in the group considered. While the effective value of the e.m.f. developed in each coil is the same as that in the others, and adjacent coils are connected in series, the effective value of the e.m.f. of a group of coils is not proportional

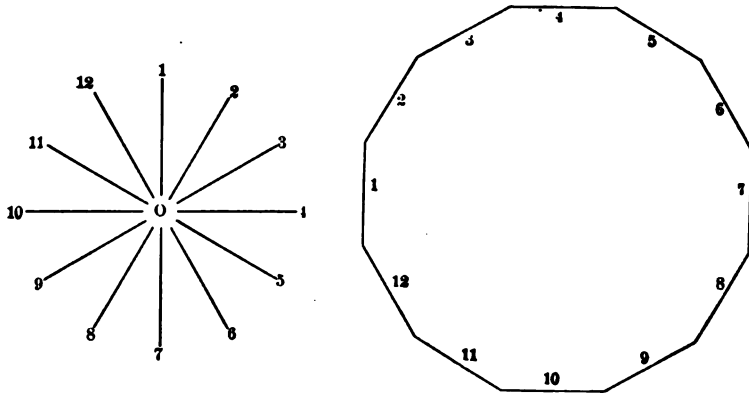

FIGS. 82A and 82B.—Phase Relations of Voltages.

directly to the number of coils composing a group, since the e.m.f. of one coil is not directly in phase with that of the adjacent coils; that is, the e.m.f. of each coil reaches its maximum value at a different instant from that corresponding to the maximum e.m.f. of each of the other coils.

If time be represented as angular degrees passed over by the armature of a bipolar machine, and the value of the e.m.f. of each individual coil be denoted by a line of any chosen length, and the line for each coil be placed in the angular-time position which the armature would occupy when that coil has its maximum e.m.f., a diagram similar to that represented by Fig. 82a will be produced. Here 01 represents the effective value and time position of the e.m.f. in coil No. 1, and 02 represents

corresponding quantities for coil No. 2, etc. As stated above, these coils are connected in series, so that the actual effective value of the e.m.f. of the coils as interconnected may be represented as in Fig. 82b. It will be observed that as the number of coils is increased the figure approaches a circle and that in any case the extremities of the sides lie on a circle.

By the use of the figure below or equivalent circle it is a simple matter to determine the effective value of the e.m.f. of a group of coils on an armature. This e.m.f. is seen to be represented in value by the chord of the arc subtended by the group of coils. If the total number of coils on the armature be divided into P equal parts, then the angle covered by each part is $360^\circ \div P$; and, since the chord is equal to twice the sine of half the angle, the e.m.f. of each group is

$$E_p = 2 \frac{E}{2} \sin \frac{180^\circ}{P} = E \sin \frac{180^\circ}{P}$$

where E is the value of the e.m.f. measured across a diameter. Now, E is the effective value of the e.m.f. at the diameter, while for a rotary converter the direct-current commutated e.m.f. is equal to the maximum value of this e.m.f., or is $\sqrt{2} E = E_m$. Therefore, the effective maximum value of the e.m.f. of a group of coils which cover $\frac{1}{P}$ part of the armature is equal

to

$$\frac{E_m}{\sqrt{2}} \sin \frac{180^\circ}{P} = E_p.$$

When the alternating current is in phase with the e.m.f., the product of the current flowing in the coils selected, by the e.m.f. across the group gives the power in watts in that section of the armature and when the armature is symmetrically loaded, the total power is

$$W = P I_p \frac{E_m}{\sqrt{2}} \sin \frac{180^\circ}{P}.$$

SYNCHRONOUS MOTORS AND GENERATORS.

For the purpose of subsequently comparing the capacities of alternating-current machines of various types and phases, it is convenient at this point to ascertain, by means of the above formula, the relative capacities of a closed-coil armature used

in a direct-current generator and the same armature used in alternating-current generators of different number of phases. Consider the armature to revolve in a field of constant intensity at a constant speed. There will be generated the same e.m.f. per conductor irrespective of the connections of the external circuits. Assume that the capacity is in each case wholly determined by the heating of the armature conductors and, as a method of direct comparison, assume that the external load is so adjusted in each case that there flows the same current through each conductor on the armature whether used in a direct or an alternating-current generator and independent of the number of phases. Obviously, the loss from heating of the armature conductors will always remain the same, while the capacity will vary as the external load.

TABLE I.
Capacities of Alternator Compared to Direct-Current Generator as 100.

Number of Phases. (Rings.)	Volts Between Leads	Amperes Per Phase.	Total Output.	Amperes Per Lead.
	$\frac{100}{\sqrt{2}} \sin \frac{180}{P}$		$P E_p I_p$	$\frac{2 W_t}{70.71 P}$
P	E_p	I_p	W_t	I_L
2	70.71	5	707.1	10.00
3	61.24	5	918.6	8.66
4	50.00	5	1000.0	7.07
6	35.35	5	1060.6	5.00
Infinite	0. +	5	1110.7	0. +

For simplicity in comparison assume that there flows always 5 amperes in each armature conductor, and also that the e.m.f. measured between the direct-current brushes is 100. The capacity as a direct-current generator is evidently 1000 watts, while the outputs as alternating-current generators of various numbers of phases will be as in Table I. (See also Fig. 83a.)

When $P = \text{infinity}$, $E_p = 0$, but $P E_p = 100 \times \sqrt{\frac{1}{2}} \times \pi$, as will be shown later.

It is interesting to note that the capacity of an alternating-current generator can be represented as the perimeter of a polygon having sides equal in number to the number of phases, of which polygon the circumscribing circle represents the capacity for infinite phases, double the diameter of this circle representing

the capacity of the so-called single-phase generator, while the capacity of the machine as a direct-current generator is represented in value by the perimeter of a square inscribed within the circle. These facts will be brought out by an inspection of Fig. 83a.

It is to be observed that the output given above is the volt-ampere capacity of each machine. With an alternating-current generator, the power delivered will, of course, vary with the power factor. At any power factor less than unity the ratio of the alternating to the direct-current capacities would vary

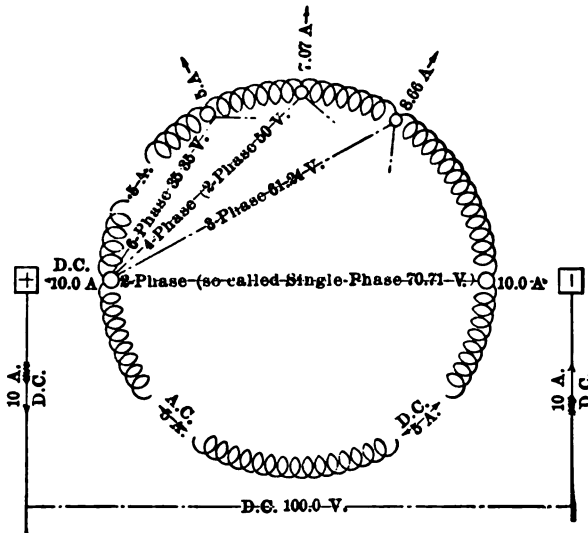

FIG. 83A.—Relative Currents for Same Heat Loss Enclosed Coil Generator Armature.

directly therewith, but the ratio of the alternating-current capacities for different numbers of phases would remain the same independent of the power factor.

In the equations given, P corresponds to the number of collector rings. Thus, a closed-coil single-phase generator, so-called, is considered a two-phase generator, the phases being 180° apart. A so-called two-phase generator having a closed-coil armature with four collector rings is, in fact, a four-phase generator with phases 90° apart, though its capacity is neither increased nor decreased by loading as two separate two-phase (so-called single-phase) generators.

SYNCHRONOUS CONVERTERS. UNITY POWER-FACTOR.

The problem of determining the relative capacities of rotary converters and other synchronous commutating machines can be attacked by use of the same fundamental equation developed above as applied to the alternating-current generators, though the method of application must be slightly modified to suit the various types of machines. Perhaps the simplest method of ascertaining the effect of the presence of both the direct and the alternating current upon the relative copper loss of the armature is to compare the losses of different machines for

TABLE II.
Volts and Amperes for Same Power with Different Numbers of Phases.

Number of Phases.	Volts Between Leads. $\frac{100}{\sqrt{2}} \sin \frac{180}{P}$ = E_P	Amp. per Phase; Effective. $\frac{W}{P \cdot E_P}$ = I_P	Amp. per Phase; Max. $\sqrt{2} I_P$ = I_M	Amp. per Lead; Effective. $\frac{\sqrt{2}W}{P \cdot E}$ = I_L
2 (single-phase)	70.71	7.071	10.000	14.142
3	61.24	5.443	7.698	9.428
4 (two-phase)	50.00	5.000	7.071	7.071
6	35.35	4.714	6.665	4.714
Infinite	0. +	4.501	6.365	0. +
D. C. App. 2	$E = 100$	$\frac{I}{2} = 5.0$	$\frac{I}{2} = 5.0$	$I = 10$

assumed equal outputs, and then to determine the relative outputs for the same loss.

The formula referred to above enables one to determine at once the effective value of current which is necessary to give a certain amount of power when P , the number of phase, and E_m , the direct e.m.f. are known. Table II gives the value of current for various number of phases for an assumed power of 1000 watts and direct e.m.f. of 100 volts.

It is to be noted that as the number of phases increases the current per group of coils decreases, but that, even with an infinite number of phases, the current has yet a finite value.

An inspection of Fig. 83a will show that the total e.m.f. of the infinity groups of infinity phases is represented by the circumference of the circumscribing circle. The value of current to produce the assumed power is found by dividing the 1000 watts by this total e.m.f.

The maximum value of current for sine waves is $\sqrt{2}$ times the effective value and, when the power factor is unity, this maximum current flows when the coils are developing their maximum e.m.f. With an armature in a bipolar field, as shown in Fig. 83b, the maximum value of e.m.f. in a group of coils occurs

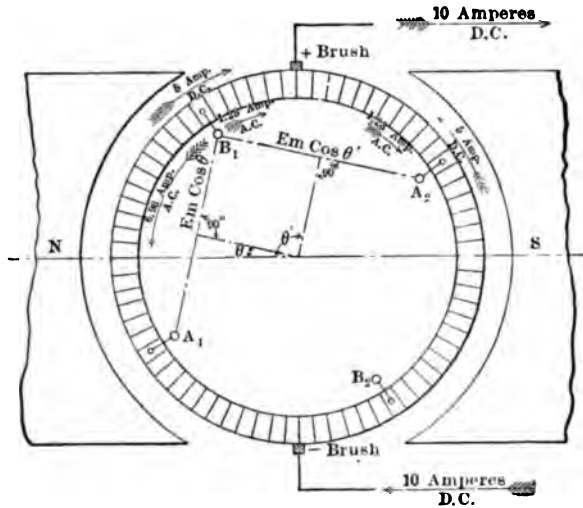

FIG. 83B.—Current in Armature Conductors of Four-phase Synchronous Converter.

at that position of the revolution of the armature where the line joining the extremities of the group is in a vertical plane, and the e.m.f. in other positions varies as the cosine of the angle of deviation from the vertical position.

Having determined the value of the maximum alternating current and the position of the group of coils when this maximum flows it now remains to investigate the effect of the presence of the direct current in the armature coils.

For purpose of combined generality of treatment and simplicity of discussion, the so-called single-phase rotary will be omitted for the present and there will be discussed first the so-

called two-phase machine which is in reality a four-phase rotary converter. Since there are four phases, the group of coils for each phase covers 90 degrees. Assume that there are 72 coils on the armature. There will then be 18 coils per phase, and each coil covers 5°. (The treatment here given is general and results will be in no way affected if the 5° contain any number of coils, or in fact, less than one coil.)

Consider the instant when the group of coils is in the position at which the maximum e.m.f. is generated, as indicated in Fig. 83b. The alternating current is equal to $\sqrt{2} I = 7.071$, while the direct current is $500 \div 100 = 5$, so that the actual current flowing through the coils is $7.071 - 5$, causing a relative loss of $(2.07)^2 \times 18 = 77$, where the resistance of each coil is taken as unity.

As the armature moves forward 5° the alternating current drops to $7.071 \cos 5^\circ = 7.05$, while the direct current remains at 5, causing a relative loss of $(2.05)^2 \times 18 = 76$. In this manner the relative loss for each position of the armature may be determined up to that number of degrees rotation which brings the beginning of the group of coils under the + brush. When the armature has rotated 50° one coil of the group considered will be on the right of the brush, and, though this coil has the same value of alternating current in it as has each of the others of the group, the direct current through it is reversed and the resultant current is, therefore, greater than in the other coils or is equal to $4.55 + 5 = 9.55$, causing a relative loss of $(9.55)^2 \times 1 = 91.2$. The other coils have at this instant a resultant current of $4.55 - 5$ and a relative loss of $(-.45)^2 \times 17 = 3.4$, hence the total relative loss for the group is $91.2 + 3.4 = 94.6$.

As the armature continues to rotate, more coils pass into the right-hand section and less remain in the left-hand section, till, when the armature has rotated 90° from its initial position, the coils are equally divided between the two sections—one-half on each side of the brush. At this instant the alternating current will have decreased to zero and the total relative loss will be 450, which is the loss due to the direct current alone.

Continuing this investigation till the armature has rotated 180°, it will be plain that the conditions obtained at the beginning are being repeated, so that a mean of the total relative losses throughout the 180° is the same as occurs continuously

throughout the operation of the rotary. As shown by Table III, this mean relative loss is 170, for the conditions herein assumed. The relative loss for the group of coils if the machine were operating as a direct-current generator would be 450, as found above. The relation between these, 1 to 2.647, indicates the relative loss of the four-phase rotary converter compared with the corresponding direct-current generator, at the same output, as unity. Since the loss in any circuit varies as the square of the current, the relative currents to give the same loss should vary as the square root of the above ratio, or the relative ca-

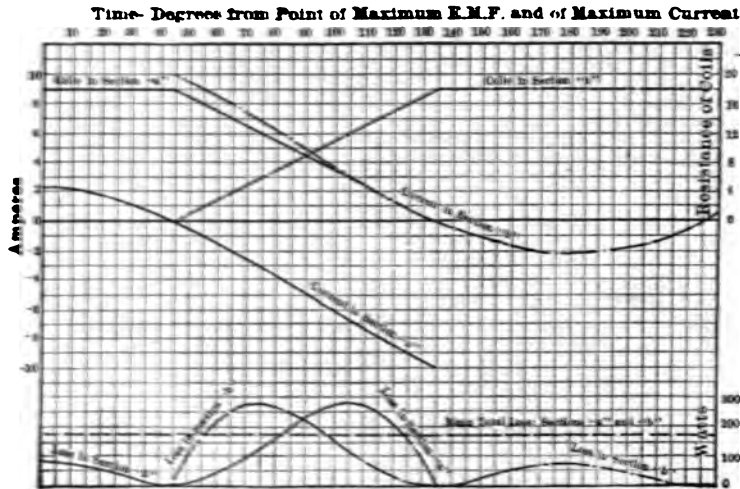

FIG. 84.—Distribution of Loss in Armature of Four-phase Synchronous Converter, the Angle of Lag Being Zero.

pacities of the machine as a rotary and as a direct-current generator will be $\sqrt{2.647} = 1.627$.

An inspection of columns 4 and 5 of Table III or of equivalent curves of Fig. 84 reveals the manner in which the instantaneous value of current in the coils varies. It will be seen that, though the mean effective value of current for the group of coils is less as a rotary than as a direct-current generator, there are certain coils which at certain times carry more current than others and that one coil will carry a maximum of twice the current when operating as a four-phase rotary as a direct-current generator.

DISTRIBUTION OF HEAT LOSS IN ARMATURE COILS.

As a result of the variation in strength of the alternating current at the instant when each separate armature coil of a rotary converter or a double-current generator passes under a commutating brush, at which time the direct current within the coil is reversed, the maximum value of current to which a coil is subjected varies with the individual coils according to the location of each within the group constituting the windings of one phase—the windings between two adjacent collector-ring taps in a bipolar armature. The two end-coils, that is, the coils which connect the alternating-current leads to the adjacent groups on either side, carry greater values of current than the contiguous coils within the group, but these two coils do not have

TABLE IV.

Type of Machine. Number of Phases.	Rotary Converter.		Double-Current Generator.	
	100% Power Factor.	90 .63% Power Factor.	100% Power Factor.	90 .63% Power Factor.
2	3.00	3.21	1.50	1.60
3	2.33	2.70	1.27	1.35
4	2.00	2.47	1.21	1.28
6	1.67	2.21	1.17	1.24
Infinite	1.00	1.60	1.14	1.20

equal current values when the power factor of the alternating current is less than unity.

A knowledge of the relative increase in instantaneous value of maximum current is important and a study of its effect and location as to coils is instructive as indicating the existence of local heating within the armature windings. The value of this maximum current which flows within a single coil depends upon the number of phases and the power factor of the current. Table IV gives the relative values of this maximum current for different machines considering as unity the current in a direct-current generator at the same load.

Although the alternating current follows a sine wave, the current in individual coils does not follow a sine curve of time-value, and compared to its effective heating value, the maximum value is much greater than that obtained with a true

sine curve. The maximum current flows for only a small fraction of the total time and is confined to a relatively small portion of the armature, so that the excess heating effect cannot at once be judged from Table IV, but must be determined by calculation similar to those recorded in columns 11 and 12 of Table III.

Table V indicates the relative values of the maximum and the minimum losses in individual coils on the armature of synchronous commutating machines of various phases at power factors of 100 per cent. and of 90.63 per cent., compared to the mean armature loss per coil under the same condition of service. The results here recorded, therefore, indicate the relative lack of uniformity of distribution of heat loss in the armature windings.

TABLE V.
Maximum and Minimum Losses in Individual Coils.

Type of Machine. Number of Phases.	Rotary Converter.				Double-Current Generator.			
	100% Power Factor.		90.63% Power Factor.		100% Power Factor.		90.63% Power Factor.	
	Max.	Min.	Max.	Min.	Max.	Min.	Max.	Min.
2	2.270	.331	2.462	.334	1.201	.650	1.462	.443
3	2.161	.405	2.748	.343	1.084	.828	1.132	.647
4	1.926	.531	2.600	.391	1.048	.903	1.094	.753
6	1.590	.725	2.217	.461	1.018	.955	1.065	.852
Infinite	1.000	1.000	1.000	1.000	1.000	1.000	1.000	1.000

SYNCHRONOUS CONVERTERS, FRACTIONAL POWER FACTOR.

When a rotary converter is operated at a power factor less than unity two effects are observed: There is required a proportionately larger current to produce a given power, and the maximum current does not flow in a given group of coils when the coils are generating their maximum e.m.f. Though the relative loss for a given machine does not vary regularly with decrease in power factor, it is sufficient for present purposes to determine the effect of operating the machines at a single fairly low value of power factor.

Assume that the current lags 25° behind the rotary e.m.f. The power factor is, therefore, $\cos 25^\circ = .9063$ and the maximum value of current instead of being 7.071, as before for the

four-phase rotary converter is now $7.071 \div .9063 = 7.81$ amperes, and this maximum occurs when the armature has moved forward 25° from the position giving maximum e.m.f., or, what is the same thing, the armature must now rotate forward only 20° before the group of coils begins to pass under the brush instead of 45° , as when the current and e.m.f. are in phase.

Bearing these facts in mind and making proper substitution in Table III, there is obtained by a method similar to the one used previously a mean relative copper heat loss in the group of coils of 266 (Table VI) which, compared to the loss of 450

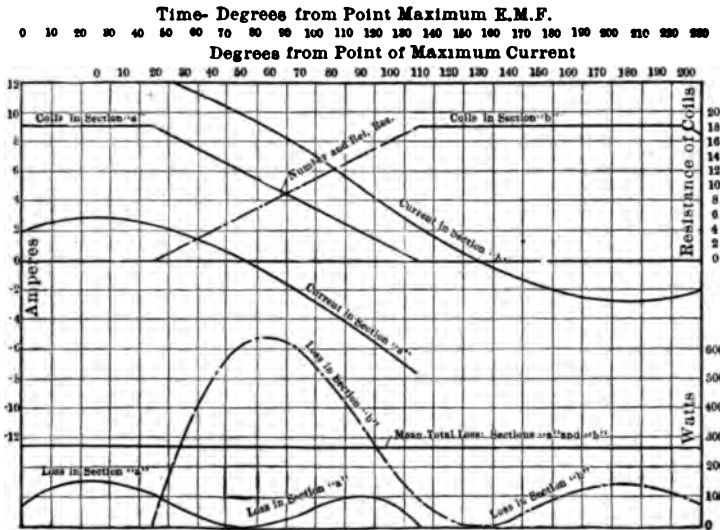

FIG. 85.—Distribution of Loss in Armature of Four-phase Synchronous Converter at 25° Lag.

for the direct-current generator, indicates a relative output of $\sqrt{\frac{450}{266}} = 1.300$ as compared with that of the direct-current generator.

DOUBLE CURRENT MACHINES.

The method of determining the output from the double-current generator is quite similar to that used above. In this case, however, the direction of flow of the alternating current at the time of maximum value is the same as that of the direct

current, so that the sum, and not the difference, must be taken in determining the resultant current. Columns 13 and 14 of Table III will show the manner in which the instantaneous value of resultant current varies. The relative loss of 1631.6 is for equal direct and alternating-current outputs so that the relative total output for the same loss as in a direct-current generator will be

$$2 \times \sqrt{\frac{450}{1631.6}} = 1.050.$$

Table VI records the calculation for determining the effect of a lag of 25° in the alternating current for the double-current generator, and, as the method is quite the same as used for the rotary converter, it need not be further discussed.

TABLE VII.
Relative Capacities of Alternating-Current Machines; Direct-Current Capacity = 1.

Type of Machine.	Rotary Converter.		Double-Current Gen.		Alt.-Cur. Generator.	
Number of Phases.	100% Power Factor.	90.63% Power Factor.	100% Power Factor.	90.63% Power Factor.	100% Power Factor.	90.63% Power Factor.
2	.848	.731	.951	.890	.7071	.6418
3	1.338	1.103	1.023	.992	.9186	.8325
4	1.627	1.300	1.050	1.020	1.0000	.9063
6	1.937	1.482	1.066	1.038	1.0610	.9612
Infinite	2.291	1.648	1.082	1.052	1.1105	1.0066

RELATIVE CAPACITIES OF SYNCHRONOUS MACHINES OF VARIOUS PHASES.

The relative capacities of alternating-current machines compared with a direct-current generator as unity are given in Table VII. The results recorded in Table VII are plotted in the form of curves in Fig. 86, so as to show to the eye the effect of varying the number of phases of a given machine. It will be seen at a glance that increasing the number of phases in each case increases the capacity of the machine, but that the relative increase for alternating-current and double-current generators is small compared to the increase for rotary converters. A change from three to six phases with an alternating-current generator results in an increased capacity of 15.5 per cent.,

while an equivalent change with a rotary converter produces from 35 per cent. to 45 per cent. greater output, depending upon the power factor of operation. These latter figures may be increased or decreased if the current wave departs materially from the assumed sine curve of time-value, though the figures as given represent results obtained in practice.

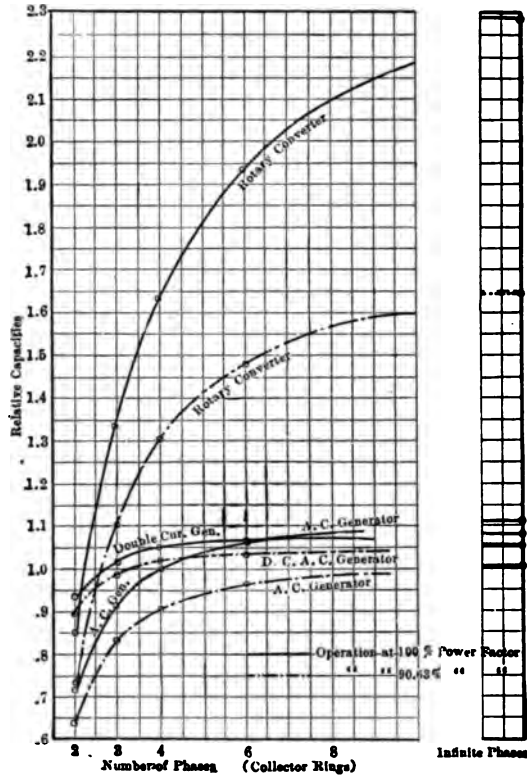

FIG. 86.—Capacities of Alternating Current Machines Compared to Direct-current Generator.

The increase in capacity of a rotary converter resulting from a change from the so-called single-phase to three-phase is from 51 per cent. to 57 per cent. Therefore, changing a given rotary from three-phase to six results in from 70 per cent. to 80 per cent. as great increase in capacity as changing from single to three-phase. Reference to Table V will show that

with a three-phase rotary converter one section of the armature windings is subjected to from 5.3 to 8 times as great current heating effect as certain others, while, with a six-phase machine, the corresponding results are 2.2 and 4.8. This means that the heat loss is much better distributed in a six-phase converter armature than in a three-phase one.

Since the transformers necessary to convert the three-phase current from the high potential transmission circuits to six-phase for rotaries are in no way more expensive or complicated than those for three-phase rotaries, economy in cost of equipment and efficiency of operation dictates the use of six-phase machines, and where the size of the rotaries operated justified the additional connecting circuits between the transformers and the machines, six-phase rotary converters should be used.

CHARACTERISTIC PERFORMANCE OF SYNCHRONOUS CONVERTERS.

In external appearance a polyphase rotary converter resembles a direct-current generator with a conspicuously large commutator and an auxiliary set of collector rings. Its design in certain respects is a compromise between alternating-current and direct-current practice. This is most noticeable with reference to the speed and number of poles; that is, the frequency. A careful review of constructive data for modern direct-current railway generators reveals the fact that the frequency of such machines is between 8 and 12 cycles while the frequency of the older belted type was about 20 cycles. Alternating-current generators, on the contrary, when not limited in frequency, are seldom built for less than 60 cycles.

Since the rotary converter is in fact a synchronous motor, it must run at a speed determined by the alternations of the supply and the number of its poles. A limit to the possible increase in speed of the converter is set by the peripheral speed of the commutator. Experience has demonstrated that 3000 ft. per minute is as high as the commutator should run to give reliable service. The peripheral speed of a rotary converter is equal to the product of the number of alternations by the distance between two adjacent neutral points. For a given direct-current e.m.f., a limiting potential difference of from 8 to 10 volts between segments, and the minimum size of bars, allowing for insulation, it is evident that, with a limiting peripheral

speed, there is soon reached a limit to the number of alternations. While, under the limits noted, it is possible to construct 500-volt rotary converters for 60 cycles, good design has determined that 25 cycles is the proper frequency for converter work at such pressure.

Since the direct and alternating currents flow in the same windings, revolving in the same field, it will be appreciated that the direct-current voltage bears a constant ratio to the alternating voltage; the maximum value of the internal alternating e.m.f. being equal to the direct e.m.f. The effective value of the alternating e.m.f. observed will depend upon the form of the e.m.f. wave and upon the points on the windings between which the voltage is taken. Assuming a sine wave and denoting the direct e.m.f. by 1, the effective alternating e.m.f. is about 0.71 for two-phase machines and star-connected six phasers, and about 0.61 for three-phase and delta-connected six-phase machines. The wave form, and hence this ratio, can be materially changed by altering the slope of the pole-faces.

EXCITATION OF SYNCHRONOUS MACHINES.

The counter e.m.f. of the converter, both as to wave form and magnitude, must be equal to that of the supply system. If the converter does not tend of itself to produce a wave similar and equal to that of the system, corrective currents will flow in the armature windings, which currents so react upon the field that the generated e.m.f. will have a wave form exactly the same as that of the supply. As far as converter output is concerned, these corrective currents are wattless. They, however, affect the regulation of the system and waste energy in the resistance of the connecting circuits and should therefore be eliminated when possible.

If the converter is excited to give an e.m.f. less than that of the system when it is running at the speed at which the alternations of the supply designate that it must run, a lagging current will be drawn from the system, which current tends to strengthen the motor field so that the generated e.m.f. is made equal to that of the system. Similarly, if the converter field is overexcited, the current drawn from the supply mains will be leading and will thus demagnetize the field sufficiently to

make the e.m.f. equal to that of the system. It is thus plain that the current demanded depends upon the field excitation and will be least for that excitation which would cause the machine to generate an e.m.f., when running at normal speed, equal to that of the system.

HUNTING OF SYNCHRONOUS MACHINES.

The mean speed of the converter must equal the mean speed of the generator, but the instantaneous speeds of the two may be quite different, as will be seen later. The synchronizing current, which holds the converter in step with the system, tends to cause the converter to follow any irregularity in the frequency of the supply-current.

The tendency to irregular angular velocity in each revolution is inherent in the construction of reciprocating engines and is augmented by the periodic hunting of the governors of engines operating alternators in parallel. The inertia of the converter armature causes it to tend to run at a constant speed, and if the alternations of the supply are irregular, during a portion of the time the converter will be ahead of the system, and at other times it will be lagging behind. During the time of relative phase displacement between the converter armature and the system, the synchronizing current acts to draw the armature into perfect step. If additional forces are brought to bear upon the converter during the period of phase shifting, the relative oscillations may be either increased or decreased according to the time-direction of such forces.

This action is very similar to the swinging of a pendulum. If, when the swing is in one direction there is given it an impulse in the same direction, the amplitude of the swing is increased, and if the impulse is given in the opposite direction, the amplitude is diminished. The periodic hunting of the engine governor, the steam admissions, the momentum of the reciprocating parts, the inertia of the generator armature and that of the converter armature, are elements which tend to increase or diminish this oscillation.

Much theoretical and experimental work was undergone before a complete cure for the tendency to this periodic phase shifting was found. Among the methods at present used may be mentioned the heavy flywheel effect for the converter, and

a magnetically weak armature compared with the field. In either of these cases, the converter armature tends to revolve at a mean speed independent of the relative irregularity of the frequency of the supply.

The method which has been found most satisfactory for the prevention of hunting of rotary converters is the use of damping devices. These are usually of the form of copper shields between or surrounding the poles, often covering a portion of the pole-tip or even imbedded in the pole proper. As the armature oscillates back and forth across its normal position, the shifting armature magnetism, produced by the unconverted portion of the motor current, induces current in the low-resistance copper shields, which current always opposes the shifting magnetism producing it. The damping action thus brought into play when the field is suddenly distorted has the effect of suppressing the oscillations. When the alternations of the supply are irregular, the damping devices act to cause the converter to tend to follow the irregularities, but prevent an exaggeration of the momentary phase displacement of the armature and thus have a steadying effect upon the whole system.

STARTING OF SYNCHRONOUS CONVERTERS.

Before a rotary can be placed into active service, it must be brought up to synchronous speed and into step with the supply system. Methods in use for accomplishing this result are as follows:

(1) Since polyphase currents are universally used as supply, the application of the alternating currents directly to the stationary armature without field excitation will result in a rotating magnetic field about the armature core. The eddy currents thereby induced in the pole-faces will exert a torque on the armature and cause it to tend to speed up to synchronism. Under the condition of starting, the step-up transformer relation between the field and armature windings causes a relatively large e.m.f. to be generated in each field coil. To lessen danger from this source, the windings on the separate poles may be isolated from each other so that the e.m.f. generated in the coils will not be in the normal series relations, and thus the total e.m.f. across any two points may be limited to that generated in one pole winding alone. When a shunt to the

series coils is used, it must be opened at starting, otherwise the heavy alternating current sent through it and the series coils may cause excessive heating.

(2) Where the station equipment will permit, the converter may be started up as a direct-current motor. The direct current may be obtained from a storage battery, from another converter or a motor-generator set may be installed for this purpose. A device for automatically tripping the direct-current circuit-breaker upon closing the alternating-current switch has proved a valuable addition to the equipment for converters started by this method

(3) A method extensively employed by one of the leading manufacturing companies is the use of separate motors for starting one or more of the converters of the sub-station equipment. The motors may conveniently be of the induction type and therefore started by standard methods for this purpose. A common location for the induction motor secondary is upon an extension of the converter shaft. Since the induction motor must experience a slip of some value, it is necessary, in order to bring the converter to full synchronism, for the motor to have a less number of magnet poles than the converter.

COMPOUNDING OF SYNCHRONOUS CONVERTERS.

In street railway and similar work it is always desirable to increase the station pressure as the load comes on, in order that the line voltage shall remain more nearly constant. The dependence of the direct-current voltage of the converter upon that of the alternating supply has been commented upon. In order, therefore, to increase the pressure of the output it is necessary to increase the pressure of the supply also. This increase may be obtained by the use of variable-ratio step-down transformers, or by the insertion of reactance in the supply circuit and running the load current through a few turns around the field poles.

We have found previously that if the converter is over-excited, leading currents will be drawn from the supply, while if the excitation is below normal, lagging currents will be drawn. If a lagging current be drawn through a reactance, the collector ring voltage will be lowered. If, however, leading current be drawn through the reactance the voltage will be raised. The

change in the phase of the current to the converter is governed, by the excitation, which is in turn regulated by the load current, so that, with series reactance, the effect of the series coils on the field of the converter is quite similar to that of the compounding on the ordinary direct-current railway generator. In operation it is sometimes found that the transmission line and converter circuits possess sufficient self induction so that additional reactance is unnecessary.

INVERTED CONVERTERS.

The rotary converter is an entirely reversible piece of apparatus. If fed with alternating current of a certain voltage, it will supply direct current of a corresponding (not equal) voltage, and similarly, if fed with direct current it will deliver alternating current of corresponding voltage. When operated to convert from direct to alternating current, the rotary is called by the somewhat ill-chosen term "inverted converter."

When driven by alternating currents its speed is governed by the alternations of the supply quite independent of all other conditions. When run from the direct-current side, however, its speed is determined by the relation of its field strength and impressed e.m.f. at the brushes. It operates in this respect exactly like a direct-current motor. If the field from any cause becomes weakened, the converter will speed up until its armature conductors cut the field magnetism at a rate to generate an e.m.f. equal to the internal impressed e.m.f. If the field be strengthened the speed will be correspondingly decreased. Obviously, therefore, the frequency of the alternating-current output may be quite irregular, though the e.m.f. be constant, if the field fluctuates in strength.

As far as the alternating-current output is concerned, the inverted converter operates as a generator. In an alternating-current generator, lagging currents weaken the field, while leading currents have the opposite effect. With constant external field excitation, the running strength of the field will, therefore, depend upon the character of the alternating-current load. When used to supply power for induction motors and similar apparatus, the current drawn will have a lagging component which weakens the field and tends to increased speed. Safety to the converter and motors necessitates that the increase

in speed be limited, while satisfactory service requires that this tendency be counter-balanced.

The following methods are in use for overcoming the tendency to irregular speed:

(1) Magnetically weak armature compared with the field. It is possible by this method to operate a converter on full zero power factor current without very materially weakening the field.

(2) Separate field excitation supplied from a direct-current generator driven synchronously with the converter. Any increase in converter speed causes the exciter generator to supply more field current and thus counteracts the influence of the lagging armature current. This latter arrangement can be made to regulate for very small variations in speed by operating the exciter field below saturation and the converter field at a high magnetic density and having the converter armature relatively magnetically weak. A very slight increase in speed causes a large increase in field current, while at the same time the armature current has a small demagnetizing effect upon the field.

The operation of a rotary converter is in general much more satisfactory than that of a corresponding direct-current generator. This is due to several causes: (1) Absence of field distortion; the rotary is both a generator and a motor. As a generator the armature current tends to distort the field in a direction opposite to the distortion as a motor. The effects of the armature reactions, therefore, neutralize each other, and since there is no shifting of the field, the point of commutation does not vary with the load, and sparkless commutation results. (2) Lessened friction loss. (3) Greater output from same armature. Since the load current at portions of each revolution feeds directly from the alternating-current side without traversing the whole winding, as must be the case with a generator, the effective armature resistance is less than it is for the same armature used in a generator.

PREDETERMINATION OF PERFORMANCE OF SYNCHRONOUS CONVERTERS.

Due to the simultaneous operation of a rotary converter, both as a motor and as a generator, the field distortion from the motor action is to some extent counteracted by that from the generator action, as has just been stated, so that under proper

field excitation, the field strength remains quite approximately constant throughout a great range of load. Hence, the armature iron loss varies but slightly with the load and, with a degree of accuracy fairly equivalent to that obtaining with constant potential-transformers, the iron loss may be considered to be independent of the load current. The variable loss is due almost exclusively to the copper loss in the armature winding.

The rotary converter with constant impressed alternating e.m.f. considered as a direct-current generator, tends always to produce the same direct external e.m.f. The apparent measurable pressure, however, drops off as the load is applied, due to

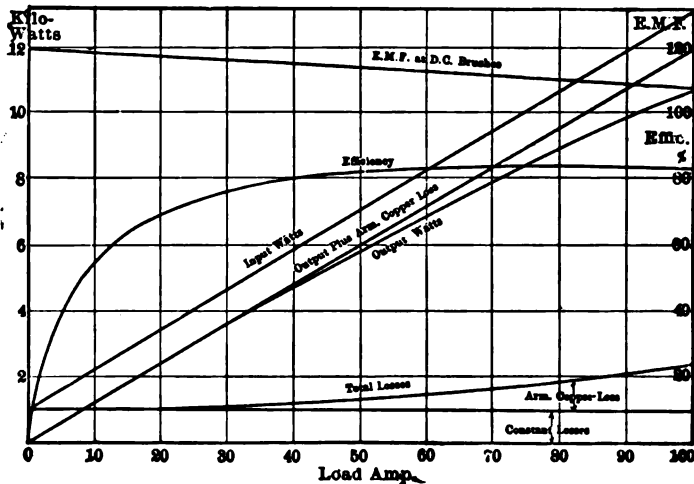

FIG. 87.—Characteristics of Rotary Converter.

the copper loss of the armature, and such drop is a direct measure of the loss within the armature.

At any chosen value of load current the sum of this loss in watts added to the output watts of the converter gives a value which would be directly determined by the product of the direct e.m.f. at its no-load value and the load current at its chosen value. It thus appears that with load amperes plotted as abscissas and watts as ordinates the curve of armature output plus copper loss due to load current is a right line and may be drawn at once for any value of output current (Fig. 87). The ratio of the watts loss in the armature copper, due to any load

current, to the value of the load current gives the effective value of the armature resistance.

Knowing the no-load losses of the converter and the effective armature resistance the complete performance may be calculated as follows:

Let W = no-load watts input,

R = effective armature resistance,

E = no-load direct e.m.f.,

I = any chosen value of load current;

then I^2R = copper loss of armature due to load,

$E - IR$ = apparent external direct e.m.f.,

$W + EI$ = input,

$EI - I^2R$ = output,

$$\frac{EI - I^2R}{EI + W} = \text{efficiency,}$$

which becomes a maximum when $I^2R = W$, as a close approximation.

It should be noted that the losses are $W + I^2R$, and that while the ratio of EI to $W + I^2R$ is a maximum when $I^2R = W$, at any armature load current, I , the input is $EI + W$ and not simply EI .

The above equations are based on the assumption of constant iron, friction and windage loss, which assumption is closely exact as stated above. In addition to these losses, the value, W includes the armature copper loss for the no-load current, and the field copper loss for exciting current. Since for efficient service the exciting current should have a constant value, it follows that the loss from this source decreases as the machine is loaded due to the fact that the direct voltage decreases, requiring less loss in the regulating rheostat. The no-load armature current is of totally an alternating nature and traverses the whole armature winding, and during a portion of its route through the armature is superposed upon that part of the alternating supply current which is about to be converted to direct current. While its effect alone upon the armature resistance would give a constant value of loss, when the two currents intermingle their combined loss is greater than the sum of the losses of the two considered separately, since in any case $(x + y)^2$ is greater than $x^2 + y^2$. It is thus seen that, among

the losses which have a practically constant value, one increases with the load while another decreases, tending somewhat to keep the total at a constant value.

From the above facts and equations it appears that the curves of *constant losses, variable losses, output, input and efficiency* may be constructed from the two value, *no-load input and effective armature resistance*.

Fig. 87 gives graphically the results of calculations of the characteristics of a certain rotary converter of which the no-load losses are 1000 watts and effective armature resistance .125 ohm.

SIX-PHASE CONVERTERS.

Due to the fact that the alternating current of the motor portion of the converter flows in general in a direction opposed to that of the direct-current generator portion, the effective armature resistance for polyphase converters is less than that of the same machine used as a direct-current generator. The ratio of effective armature resistance to its true generator value is as follows:

2 rings converter,	1.39
3 " "	.56
4 " "	.37
6 " "	.26
8 " "	.21

The ratio of effective to true armature resistance depends upon the number of phases. If $R a$ represents the true armature resistance, and R the effective armature resistance, and we assume the full-load rating of the machine to be governed wholly by the heating of the armature conductors, then the output current will be greater as a rotary converter than as a generator by the ratio,

$$1 \text{ to } \sqrt{\frac{R a}{R}}$$

The values of $\frac{R a}{R}$ and $\sqrt{\frac{R a}{R}}$ are as follows:

	$\frac{R a}{R}$	$\sqrt{\frac{R a}{R}}$
Three-phase rotaries.....	1.80	1.34
Quarter-phase rotaries.....	2.66	1.63
Six-phase rotaries.....	3.76	1.94

The above facts bring forward another of equal importance. It is evident from the figures just given that an armature of a converter connected up six-phase will give a much larger output than when used three-phase. The theoretical ratio is about 1 to 1.45. In practice this would be slightly modified by wattless currents, if such be present.

The first thought of the use of six-phase converters suggests numerous complications of connections, which, upon further investigation, are found not to exist. With reference to the converter proper, the only change necessary is the addition of three more collector rings at a very small expense.

An examination of the connections of a six-phase armature will reveal the fact that, if only alternate rings be considered, neglecting for the moment the additional three rings, we have a true three-phase armature. Now considering only the other three rings alone, we have again a true three-phase armature. Further examination will show that at any given instant the e.m.f. between two rings of one set chosen as above, is in direct phase opposition to the e.m.f. between the corresponding two rings of the other set; this is true of each pair of rings of each set. We therefore find that the three-phase e.m.f. in one set is displaced just 180 degrees from the three-phase e.m.f. in the other set. The connections to obtain six-phase currents from the two independent three-phase circuits are obvious from this explanation.

SIX-PHASE TRANSFORMATION.

The flexibility of polyphase circuits in general is well exemplified by the numerous interconnections of transformer coils which may be employed to produce six phases from two or three phases. The transformation from three to six phases may be accomplished by the use of three transformers, each having one secondary connected "star" fashion, or by three transformers, each having two secondaries, connected in "star," "delta," or "ring"; or by the use of two transformers, each with two secondaries, connected in "delta" or "tee"; or two transformers each with one secondary may be used as combined autotransformers and transformers to obtain the desired conversion. A few of the methods of transformation just mentioned are of interest only from an academic point of view, and such will not be further discussed; only those which possess

points of special interest or are of practical value will be considered in detail.

In many respects a six-phase system may be represented as

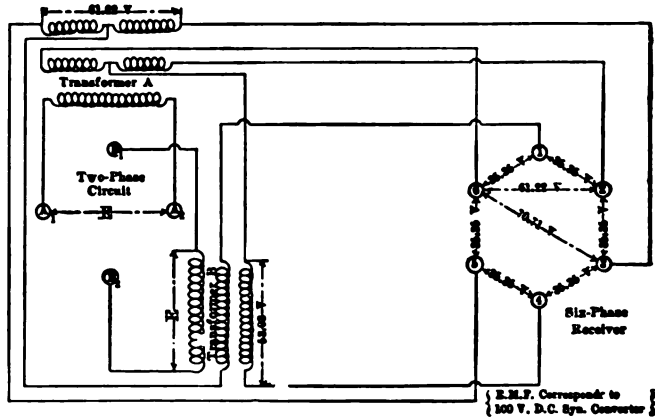

FIG. 88.—Two-phase to Six-phase Transformation; Two Transformers, Tee Secondary.

two superposed three-phase systems, and a certain degree of simplicity in tracing the transformation circuits may be obtained by keeping this fact in mind. This fact is somewhat

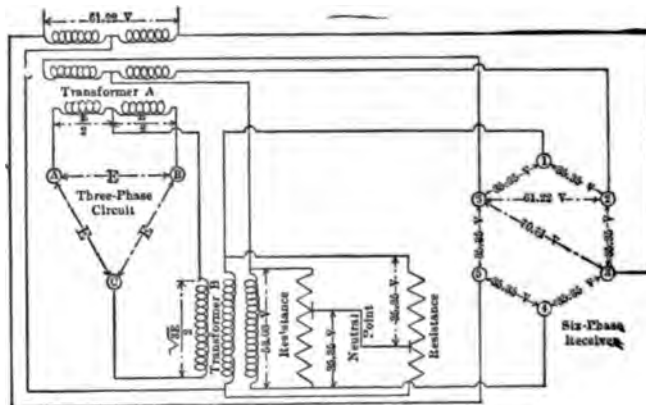
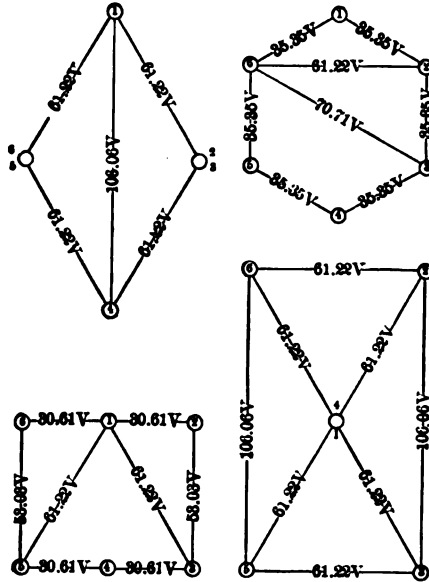

FIG. 89.—Three-phase to Six-phase Transformation; Two Transformers, Tee Secondary.

emphasized by the method of transforming from two to six phases that is shown by Fig. 88. As will be observed, the two transformers are wound quite similarly to those used in the

Scott method of transforming from two to three phases; the difference being in the division of each secondary winding into two parts. The six secondary coils are connected so as to form two three-phase systems. These two systems are twice reversed with reference to each other; electrically at the transformers, and mechanically at the six-phase receiver, so that the separate tendencies to motion would be in the same direction of rotation. Since there exists no interconnection between the two three-phase circuits the cross e.m.fs. shown in Fig. 88 can



FIGS. 90-93.—Symmetrical Voltage Diagrams.

be observed only when the six-phase receiver of itself tends to produce such e.m.fs.

As a comparison between Fig. 88 and Fig. 89 will show, a relatively slight change in the primary coil of one transformer renders the two-phase to six-phase connections of circuits applicable to transformation from three to six phases. The resistances shown in Fig. 89 are not essential to the operation of a six-phase rotary converter or similar apparatus, though when such apparatus is absent the existence of e.m.fs. in six-phase relation can best be proved by the use of a voltmeter when re-

sistance is thus used. By varying the points on the separate resistances which are joined together a variety of superposed three-phase e.m.fs. may be obtained, the existence of which may be proved by a voltmeter. Figs. 90 to 93 indicate a few

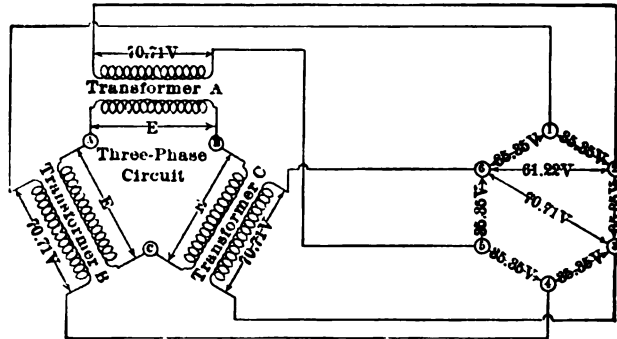

FIG. 94.—Three-phase to Six-phase Transformation; Delta Primary, Star Secondary.

of the symmetrical figures thus produced. Under operating conditions the generator action of a six-phase rotary converter causes the e.m.fs. to assume the relation shown by Fig. 91, and the use of resistance for such purpose is entirely superfluous.

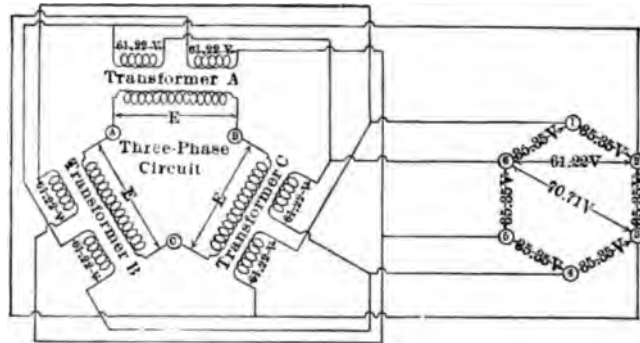

FIG. 95.—Three-phase to Six-phase Transformation; Delta Primary, Delta Secondary.

Perhaps of the many methods for transforming from three to six phases, the one possessing the greatest simplicity in transformer circuits is that in which the secondaries are star connected, and the primaries either star or delta connected. Fig.

94 shows such interconnection of circuits with the primaries connected in delta. With the six-phase receiver absent, a voltmeter would register only three separate single-phase e.m.fs., and would indicate no cross e.m.fs. between the phases. By tapping each secondary coil at its middle point, and joining these three points to form a common neutral, all the e.m.fs. of the symmetrical six-phase receiver will be properly indicated on a voltmeter. As stated previously, however, the operation of a six-phase receiver does not depend upon the production of the symmetrical figure external to the receiver and the performance will be quite satisfactory without joining the three neutral points of the separate single-phase circuits.

Fig. 95 indicates connecting circuits for three-phase to six-

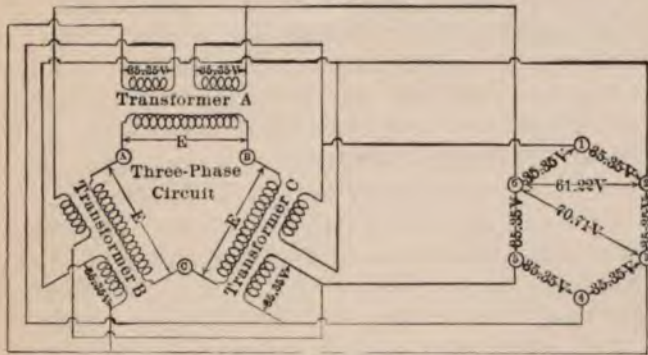

FIG. 96.—Three-phase to Six-phase Transformation; Delta Primary, Ring Secondary.

phase transformation, both primary and secondary coils being connected in delta. No change whatever need be made in the connections of the secondary circuits in order to operate the primary coils in star, though the e.m.f. per primary coil would thereby need to be decreased in the ratio of $\sqrt{3}$ to 1, of course.

A comparison of Fig. 95 and Fig. 96 will reveal the fact that the same transformers may be used for either delta or ring connected secondaries, though a change in the ratio of primary to secondary turns per coil would be necessary in order to operate the receiver at the same e.m.f. for the two methods of transformation; the change being as the ratio of the side of an equilateral triangle to that of a regular hexagon inscribed within the same circle.

RELATIVE ADVANTAGES OF DELTA AND STAR-CONNECTED PRIMARIES.

Since, when three transformers are connected in delta, one may be removed without interrupting the performance of the circuit—the other two transformers in a manner acting in series to carry the load of the missing transformers—the desire to obtain immunity from a shut-down due to the disabling of one transformer has led to the extensive use of the delta connection of transformers especially on the low potential six-phase side. It is to be noted in this connection that in case one transformer is crippled the other two will be subjected to greatly increased losses. If three delta-connected transformers be equally loaded until each carries 100 amperes, there will be 173 amperes in each external circuit wire. If one transformer be now removed and 173 amperes continues to be supplied to each external circuit wire, each of the remaining transformers must carry 173 amperes, since it is now in series with an external circuit. Therefore, each transformer must now show three times as much copper loss as when all three transformers were active, or the total copper loss is now increased to a value of six relative to its former value of three.

A change from delta to star in the primary circuit alters the ratio of the transmission e.m.f. to the receiver e.m.f. from 1 to $\sqrt{3}$. On account of this fact, when the e.m.f. of the transmission circuit is so high that the successful insulation of transformer coils becomes of constructive and pecuniary importance, the three-phase line side of the transformers is frequently connected in star.

When rotary converters are employed for supplying power to lighting circuits, it is frequently desirable that a lead at neutral potential be run on the direct-current side of the system. Since the input side of the converter is electrically connected to the output side, it follows that the neutral point on the alternating-current end of the converter is simultaneously the neutral point on the direct-current end. For this reason, it is sometimes advantageous to join the low-potential windings of the transformers in such a manner as to allow an electrical connection to be made to the neutral point from the neutral conductor of the three-wire direct-current system. Thus for a three-ring converter the coils could be joined in "tee" or in "star," for a four-ring converter the coils could be interconnected at the central points, while for a six-ring converter the coils could be arranged in double interconnected "tee" or "star."

CHAPTER XII.

ELECTROMAGNETIC TORQUE.

COMMUTATOR MOTORS.

Before investigating the characteristics of single-phase commutator motors, it is well to review a few facts relating to the production of torque by electromagnetic action, and to ascertain some method by which rotative torque can be measured most conveniently.

If a bipolar, direct-current armature be placed within core material having uniform magnetic reluctance around the air-gap, as for example within an induction motor stator, and brushes placed upon the commutator in mechanical quadrature, as shown in Fig. 97, be caused to carry direct current from two isolated sources of supply, it will be found that the armature has no tendency to motion in either direction, whatsoever may be the values of the two currents. Upon superficial examination one is inclined to attribute the lack of torque to the fact that such flux as may be in mechanical position to give force by its product with any current existing in the armature is caused by currents in the same armature, and the two currents, being in the same mechanical structure, could not cause motion with reference to any external body. It will be evident that each current is in position to produce force in a certain direction due to the presence of the flux caused by the other current. It is not immediately apparent, however, that each component force thus produced tends to give motion to the armature with reference to the stator, and that the cause for the lack of resultant torque is the opposition in direction, with equality in value, of the component forces.

EQUALITY OF TORQUES FOR UNIFORM RELUCTANCE.

From the fundamental law of physics that a force of one dyne is exerted upon each centimeter of length of a conductor per unit current per line of force flux density in the area through

which the conductor passes, is obtained the torque equation for the current through brushes *A A* (Fig. 97), due to the presence of the flux caused by the current through the brushes *B B*,

$$T_a = K I_a \phi_b$$

where *K* is a proportionality constant depending for its value upon the number and arrangement of the armature conductors.

Similarly, the torque for the current through the brushes *B B* will be

$$T_b = K I_b \phi_a,$$

the constant, *K*, having the same value as above.

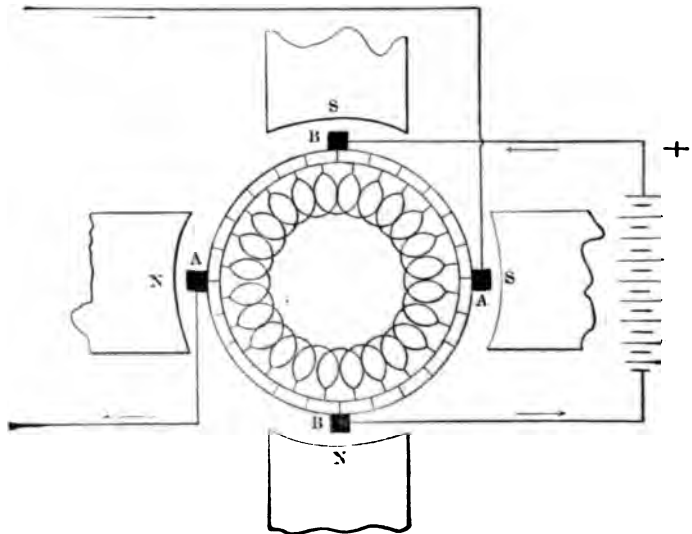

FIG. 97.—Superposed Direct-currents in Armature; Two Fields in Mechanical Quadrature; No Resultant Torque.

A study of the circuits and magnets of Fig. 97 will show that these two torques are opposite in direction, so that the resultant torque is

$$T = T_a - T_b = K (I_a \phi_b - I_b \phi_a).$$

With uniform reluctance in all directions across the air-gap and through the core material, the flux per unit current will be the same in both axial brush lines, so that

$$\frac{\phi_a}{I_a} = \frac{\phi_b}{I_b} \text{ or } I_a \phi_b = I_b \phi_a,$$

from which is obtained $T = 0$.

Hence, under the conditions assumed, the resultant torque has zero value, though each component torque may have a certain definite value tending to give motion to the armature.

INEQUALITY OF TORQUES FOR NON-UNIFORM RELUCTANCE.

If the reluctance be greater in the axial line of one set of brushes than in that of the other, then the proportionality between the current and the flux produced thereby becomes altered, so that $I_a \phi_b$ no longer equals $I_b \phi_a$, and the resultant torque assumes a value proportional to their difference. A

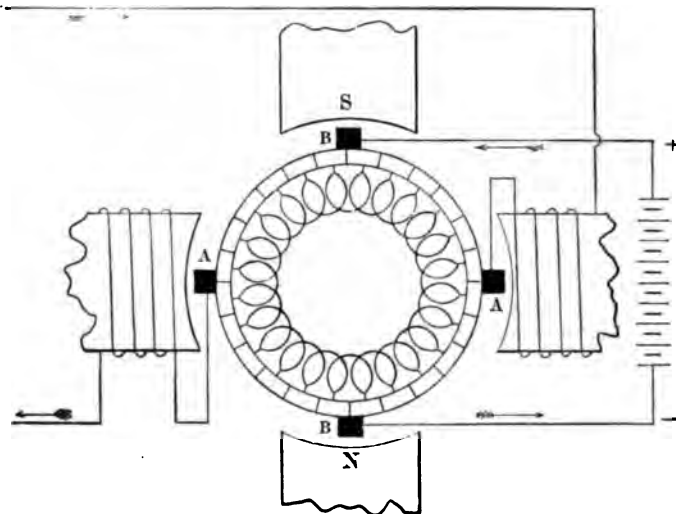

FIG. 98.—Superposed Direct-currents in Armature; One Quadrature Field Neutralized; Good Operating Torque.

change in the relative reluctance in the two directions may be obtained by removing a portion of the core material in one axial brush line, thereby retaining the projecting poles common in direct-current practice.

Fig. 98 shows a method by which the flux, which current through the brushes *A A* would tend to produce, may be rendered of zero value for any amount of current in the circuit, thus giving the effect of infinite reluctance in this axial brush line. When the effective turns on the stator core are equal in number to those on the armature, with circuits connected as here indi-

cated, the machine will operate as a separately excited direct-current motor. The torque will be of a value determined wholly by the product of the current through AA and the flux along BB , and will be in no wise influenced by the fact that the flux is produced by current in the armature. The statement here made easily admits of experimental verification.

While the facts presented above are more of theoretical interest than of practical importance with reference to direct-current machinery, they form the essential groundwork upon which are based the fundamental equations for determining the characteristics of numerous types of alternating-current commutator motors, now being developed.

DETERMINATION OF TORQUE BY CALCULATION OF THE OUTPUT.

A little experience with the well-known mechanical and electrical methods for determining torque convinces one that the latter method is far preferable to the former with reference to ease of adjustment, flexibility of operation and reliability of results. For ascertaining the output from either mechanical or electrical motors, perhaps, the most familiar method is one which involves the use of a direct-current generator, of which the sum of the input and transmission losses is taken as the value of the output desired. The input to the direct-current generator is found as the sum of its output and its internal losses. In order to determine the internal losses of the generator, it is necessary to find the value of the individual iron, friction and copper losses. When the resistances of the separate circuits of the generator and the currents flowing there through are known, the copper losses may readily be calculated. The armature iron loss varies both with the speed and the density of magnetism. That the effect of any change in the latter may be eliminated, it is usual to operate the generator as a shunt-wound machine with constant field excitation and with the armature brushes at the mechanical neutral point, under which conditions the iron loss will vary at a rate but slightly greater than the first power of the speed, and, where the nature of the test so dictates, the value may accurately be determined throughout any desired range of speed.

In cases where the load generator and the driving motor are constructed for the same e.m.f. and capacity, the output from

the generator may be fed back into the supply line, the test thereby using only that amount of power necessary to overcome the losses of the two machines. In these latter cases the individual losses of each machine are calculated as formerly and each is subject to the same errors as before, but the sum of the losses, being directly measured, is accurately determined and may be used as a check on the separate losses.

The method given below combines the convenience and economy of the "loading back" method, is subject to a less number of sources of errors and is applicable to all types of motors, either direct or alternating current, which may possess either the series or shunt motor characteristics, and in many cases

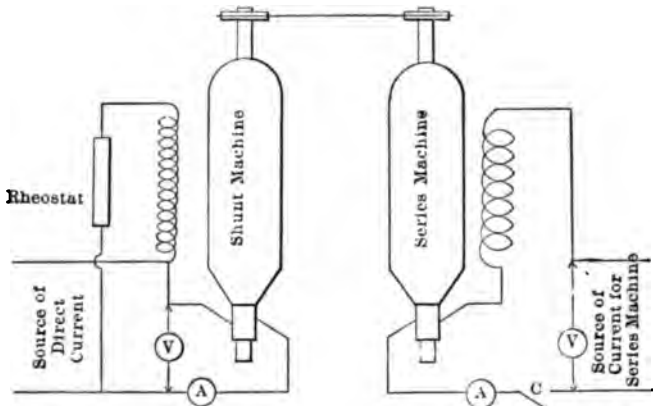

FIG. 99.—Determination of Torque.

it may with equally desirable results be applied to the testing of either mechanical or electrical motors.

MEASUREMENT OF TORQUE BY THE LOADING BACK METHOD.

The circuit diagram of Fig. 99 will serve to make clear the method of connecting the apparatus for the test and may be used to explain the theory upon which the test depends. In Fig. 99 the load generator is shown as a constant-potential, shunt-wound, direct-current machine, while the driving motor, as shown, is a series-wound machine, and may be of either the direct or alternating-current type. It is desired to find the torque of the series machine at various speeds. If the shunt machine be operated as a motor—being belted to the series

machine which is run, with circuit switch C open, at a speed somewhat below that at which the value of the torque is desired to be obtained—it will require a certain armature current, I_0 , at a certain impressed e.m.f., E . If now the switch, C , in the circuit to the series machine, be closed, the shunt machine will be driven at an increased speed and will require an armature current smaller than before—perhaps of negative value—due to the accelerating torque transmitted to the belt, and, if the e.m.f., E , and the field current of the shunt machine, remain constant, the value of the torque, exerted by the series machine, expressed in equivalent watts per revolution per minute, will be:

$$D = \frac{(I_0 - I_L) E}{S},$$

where I_0 is amp. taken by armature of shunt machine with switch, C , open;

I_L is amp. taken by armature of shunt machine with switch, C , closed;

and S is the "synchronous" speed of the set, as determined by the relation of the e.m.f. and field strength of the shunt machine.

The equation above expresses the value of the torque by which the series machine assists the shunt-wound machine, and gives the true value of the torque which the series machine delivers to its own shaft.

The convenience of this method in comparison with one which uses the shunt machine as a generator will be appreciated when it is considered that no account need be taken of the internal losses or of the output of the machine and that the field current of the shunt machine and therewith the speed of the set may be adjusted to any desired value for each determination of torque without affecting the results. The economy of the method is due to the fact that the set dissipates only that amount of power represented by the losses of the two machines, all excess of power being returned through the constant potential supply circuit by means of the current produced by the generator action of the shunt machine.

The accuracy of the method depends upon the following facts: A direct-current motor runs at a speed such as to generate an e.m.f. less than the impressed by an amount sufficient to force through the resistance of its armature a current of a value

such that its product with the field magnetism gives the torque demanded at its shaft. With constant field magnetism the electrical torque of a direct-current machine, operated as either a motor or a generator, is given by the expression:

$$D = \frac{I E}{S}$$

where I is the armature current,

E is the impressed e.m.f.,

and S is that speed at which the counter e.m.f. of rotation of the armature windings in the field magnetism equals the impressed e.m.f.; that is, the "synchronous" speed as used above.

If W_o = watts output (electrical),

R = resistance of armature,

$r.p.m.$ = actual speed of armature,

$$\text{then } D = \frac{W_o}{r.p.m.} = \frac{I E - I^2 R}{r.p.m.} = \frac{I (E - I R)}{r.p.m.} = \frac{I E c}{r.p.m.}, \text{ where}$$

$E c$ is the counter e.m.f. of rotation. But $\frac{E c}{r.p.m.} = \frac{E}{S}$, for con-

stant field strength; hence, $D = \frac{I E}{S}$, as given above.

Since for a certain impressed e.m.f. S has a definite fixed value for each adjustment of field strength, with constant field magnetism, the internal electrical torque of the shunt machine varies directly with the armature current, and any change in the value of this current serves at once as a measure of the change in torque exerted by the shunt machine, quite independent of all other conditions.

ELIMINATION OF ERRORS.

It remains now to show why the change in torque of the shunt machine may be used to determine the torque exerted by the driving motor. The torque delivered to the shaft of the series motor is less than the internal electrical torque of the shunt machine by that necessary to overcome the iron and friction losses of the shunt machine and the transmission losses in the belt. Since the belt and friction losses vary directly

with the speed, it will be evident that the counter torque due thereto will be constant. For constant field magnetism, the armature hysteresis loss varies as the first power, and the eddy current loss as the square, of the speed. Since in comparison with the other loss, that due to the eddy currents is relatively small, the sum of the iron, friction and transmission losses varies at a rate inappreciably greater than the first power of the speed and the torque necessary to overcome these losses may, for practical purposes, be taken as being independent of the slight change in speed. The change in the internal electrical torque of the shunt machine, when switch *C*, of Fig. 99, is closed, gives at once the value of the torque delivered to its shaft by the series motor.

The method outlined above may be used to determine the torque exerted by a machine when such torque is much less than that necessary to drive a generator of any capacity whatsoever and is, therefore, especially advantageous for tests where it is desired to find the torque, at high speeds of machines possessing series motor characteristics.

In Fig. 99 is shown a series-wound driving motor, but it will be evident that the change in torque, as given by the variation of the current taken by the shunt machine, may be produced by any type of motor. A little consideration will show that since at any given speed, the torque exerted by the shunt machine of Fig. 99 may be adjusted throughout any desired range by use of the field rheostat, the method may conveniently be applied to motors possessing practically constant load speed characteristics, such as those of the direct-current, shunt-wound type or of the alternating-current induction type, and that alternating-current synchronous motors may be similarly tested, if after adjustment of the load on the synchronous motor by means of the rheostat in the field circuit of the shunt machine the supply of electric power be cut off from the synchronous machine in order to obtain the change in torque exerted by the shunt machine.

CHAPTER XIII.

SIMPLIFIED TREATMENT OF SINGLE-PHASE COMMUTATOR MOTORS.

THE REPULSION MOTOR.

Mention has already been made of the use of a commutator on the revolving secondary of a single-phase motor for the purpose of giving to the rotor a starting torque. It seems desirable to treat this so-called repulsion motor more in detail and to explain its operation more fully. The verbal descriptive matter presented below will serve to give to the reader a fair idea of the operating characteristics of the machine, after which the more complete analytical study of the motor may be undertaken. Since the mathematical treatment of the other types of commutator motors is quite the same as that used with the repulsion motor, it is believed that a little familiarity in the performance of the repulsion motor will be of great assistance in becoming acquainted with the characteristics of the other machines.

The repulsion motor is a transformer, the secondary core of which is movable with respect to the primary, and the secondary coil of which remains at all times short-circuited in a line inclined at a certain angle with the primary coil. Such a machine is represented diagrammatically in Fig. 100. Superficially considered, current which flows in the secondary (the armature) by way of the brushes acts upon the field produced by the primary current to give the armature a torque which retains its direction with the simultaneous reversal of the two currents. If the brushes were placed in line with the field poles, maximum current would be produced in the secondary, but it would have no tendency to move because such torques as are produced on one side of the armature would be opposed by those produced on the other. Similarly, if the brushes were placed at right angles to the field axis no torque would be obtained, for no current would flow in the secondary. A further analysis will

show that the torque depends directly upon the product of the secondary (armature) current and that part of the field magnetism which is in mechanical quadrature with the radial line joining the secondary brushes and which is in time-phase with the armature current. In fact, the torque follows a law similar in all respects to that which holds for direct-current machines.

ELECTRIC AND MAGNETIC CIRCUITS OF IDEAL MOTOR.

For the purpose of analysis, it is convenient to divide the primary magnetism into two components, one in mechanical

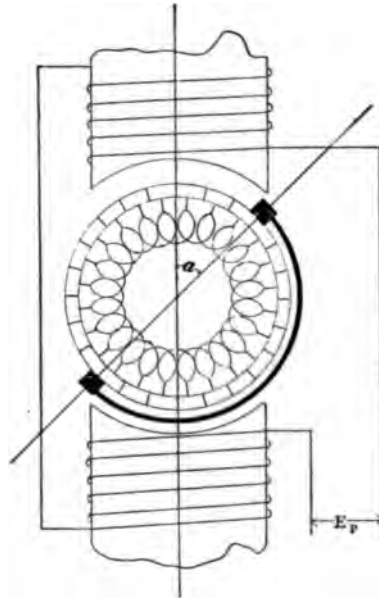

FIG. 100.—Circuits of Repulsion Motor.

quadrature with the line of the brushes, to give the torque, and one directly in line with the brushes, which produces current in the secondary by transformer action. In commercial repulsion motors the primary winding is distributed over an approximately uniformly slotted core without the projecting poles shown in Fig. 100, and the assumption is made that at any given angle, α , to which the brushes are shifted from the field line, the flux component in line with the brushes is $\phi \cos \alpha$, and that in quadrature is $\phi \sin \alpha$, where ϕ is the total primary flux.

This assumption is more or less justified by the fact that when no current flows in the secondary, such component values of fluxes give a resultant equal to the primary flux and having the proper mechanical position on the core. As will appear later, however, this assumption leads to error in assigning values to the two flux components. In order to eliminate all trouble from this source and to allow the conditions to be clearly presented, it is well to divide the primary winding up into two parts placed upon two projecting cores in mechanical quadrature one with the other, and to locate the brushes in line with one core, as shown in Fig. 101. As the simplest possible case, it

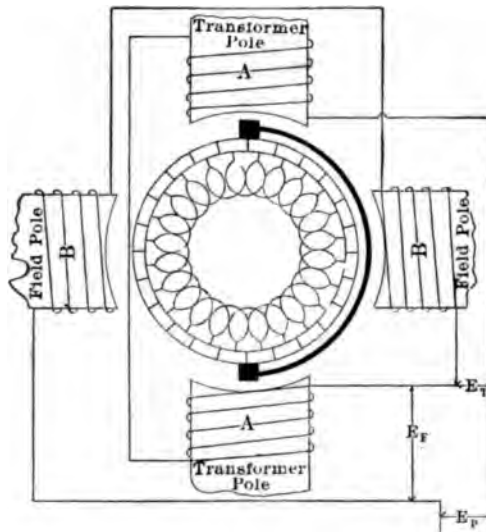

FIG. 101.—Circuits of Ideal Repulsion Motor.

will be assumed that the number of turns on one core is the same as on the other and equal to the effective turns on the armature. Under the conditions assumed, when no current flows in the secondary, the primary field would have a resultant located 45° from the line joining the two brushes.

If the secondary brushes be connected together while the rotor is stationary, the transformer action of the flux in *A* will cause a current to flow in the secondary, which current tends to reduce the flux in *A* and allow more current to flow in the primary coil and to increase the flux in *B*. If the transformer

action were perfect, no flux would remain in A , while the flux in B would assume double value and the current in the secondary would equal that in the primary (the primary and secondary turns at A being equal). Such a condition would exist if the primary and secondary coils were devoid of resistance and local reactance (magnetic leakage).

If the resistance and local reactance at A be considered negligible, when the rotor is stationary the e.m.f. across the coil on the core A will be zero, while that on B will be equal to the total impressed e.m.f. Assume that the core material at B and through the armature is such that the flux produced is in time phase with the current in the coil and proportional at all times to such current; that is to say, that the reluctance of the magnetic path of B is constant. Let it be further assumed that the reluctance of the magnetic circuit of A is equal to that of B . It should be noted that these assumptions are equivalent in all respects to those which are invariably implied in a mathematical or graphical treatment where the coefficient of self-induction, L , is taken as constant.

PRODUCTION OF ROTOR TORQUE.

The production of torque at the rotor can now be investigated. The flux in B is in time phase with the primary current, while the current in the armature is in phase opposition to that in the coil on A . Therefore, the armature current is in time phase with the field magnetism, and the torque (the product of the two) retains its sign as the two reverse together. If the armature be allowed to move, a certain e.m.f. will be generated at the brushes due to the fact that the armature conductors cut the field magnetism of B . This generated e.m.f. will at each instant be proportional to the product of the field magnetism and the speed, and will, therefore, be in time phase with the magnetism of B . Since the resistance and local reactance of the armature circuit are negligible, any unbalanced e.m.f. at the brushes would cause an enormous current to flow through the armature. Such current, however, would produce a flux in time phase with itself and the rate of change of the flux would generate an e.m.f. opposing the effective e.m.f. which causes current to flow, the final result being that there flows just that amount of current, the magnetomotive force of which produces

a value of flux the rate of change of which through the armature generates an e.m.f. equal and opposite to that due to the speed. Now, the flux thus produced alternates through the winding on *A* and generates therein an e.m.f. equal to that similarly generated at the brushes and in time phase with the brush e.m.f. Since the flux at *B* is in time phase with the e.m.f. across the winding on *B*, and the e.m.f. counter-generated in the winding on *A* is in time phase with the flux in *B*, the e.m.f. across the winding *B* is in time quadrature to that across the *A* winding. The vector sum of the e.m.fs. at *A* and at *B* must be equal to the constant line e.m.f., *E*.

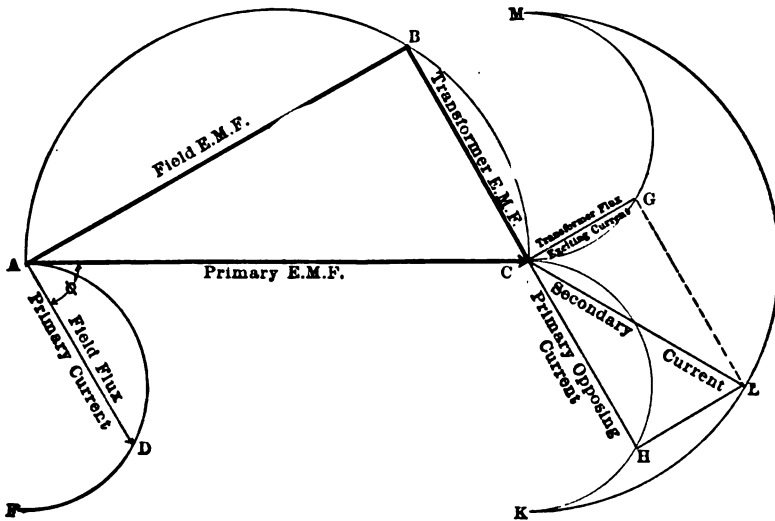

FIG. 102.—Vector Diagram of Ideal Repulsion Motor.

GRAPHICAL DIAGRAM OF REPULSION MOTOR.

The facts just stated lead to the very simple graphical representation of the phenomena of an ideal repulsion motor shown in Fig. 102, where *AC* represents in value and phase the impressed e.m.f., *E*; the line *AB* equals the e.m.f. across the winding, *A*, at a certain armature speed, while *BC* is the corresponding e.m.f. across *B* at the same speed. It will be noted that since at any speed the e.m.fs. *AB* and *BC* must be at right angles and have a vector sum equal to *E*, the locus of the point *B* is a true circle and can at once be drawn when *AC*

is located. Since the e.m.f. of the A winding is proportional to the value and rate of change of the flux in the core A , and such flux is proportional to the current in the coil, the current in the winding, A , is proportional to the e.m.f., AB (Fig. 102) and in time quadrature to it, as shown at AD . A little consideration will show that the locus of D is a true circle having a diameter AF equal to the primary current at standstill.

It has been stated that at starting the primary and secondary currents were equal in value, but that under speed conditions another current was produced in the secondary. The value of this additional component of the secondary current, which must be such as to give the magnetism in A (Fig. 101), may be found as follows: The magnetism in A is proportional to the e.m.f. across the winding of those poles. Hence, the current to produce such magnetism must be proportional to the e.m.f. and in time quadrature to it; or, if in Fig. 102, BC is the e.m.f. just referred to, CG is the component of secondary current to produce the corresponding flux. The locus of G is a true circle with a diameter equal to AF of the primary current, as will be apparent from what has been stated previously. The vector sum of the components, CG , of the secondary current and CH , equal and opposite to the primary current, gives the true secondary current both in value and phase position.

It is evident that at a certain speed the e.m.fs. represented by the lines AB and BC in Fig. 102 will be equal in value. It is interesting to note what occurs at this speed. Since the e.m.fs. generated are equal and in time quadrature, the magnetic fluxes must similarly have equal values and be in time quadrature. It will be recalled that the magnetic condition at this speed is similar in all respects to that found in two-phase induction motors; that is, there is produced a true uniform rotating field (if a continuous core be used) moving at "synchronous speed." At other armature speeds there is produced similarly a revolving field traveling at synchronous speed, but the field varies in intensity from instant to instant, giving what is termed an "elliptically revolving" field, one axis of the ellipse remaining in line with the brushes and having a value proportional to, but in time quadrature with, the e.m.f. of the winding of B , Fig. 101, or length AB in Fig. 102, the other axis being in line with the field poles, A , and proportional to the e.m.f. across the winding on them, BC , in Fig. 102. It is noteworthy

that such an elliptical field is characteristic of the magnetic condition found with single-phase induction motors. It should be noted, however, that the term "synchronous speed" refers to the change in position on the core of the maximum magnetic flux existing at each instant and has no direct bearing upon the maximum speed which the rotor may attain, which maximum speed, in fact, is limited by conditions other than those here assumed to exist.

CALCULATED PERFORMANCE OF IDEAL REPULSION MOTOR.

By the use of Fig. 102 the complete performance of an ideal repulsion motor may be determined if values be assigned to the scales chosen for the current and e.m.f. Table I records such calculations of the performance of a certain repulsion motor, of which the field reactance is 10 ohms when operated at a constant impressed e.m.f. of 100 volts; that is, in Fig. 102, $AC = 100 V.$, $AF = 10 A.$ The method of making computations is indicated at the head of each column of the table. It will be observed that there have been chosen certain values of the e.m.fs. across the field coils on the poles B (Fig. 101) and the corresponding values of the e.m.fs. across the transformer coils on the poles A have been calculated. As will be seen, the work of determination has been much simplified by assuming e.m.f. values corresponding to the product of the impressed e.m.f. and the sine and cosine values of angles at five-degree intervals, so that almost all values recorded in Table I have been taken directly from trigonometric tables.

The speed is found as follows: With an equal number of turns in the windings on A and B of Fig. 101, when the e.m.fs. across these windings are equal, the speed is synchronous, and this speed is given the value 1. Now, at other speeds, the e.m.f. across the A winding will be proportional to the product of the speed and the flux in B ; that is, the e.m.f. in the winding, B , as shown previously. It will be apparent, therefore, that the speed is the ratio of the e.m.f. across the coils on A to that across the coils on B of Fig. 101, or to the ratio of the lengths BC to AB in Fig. 103. It will be noted that this ratio is the cotangent of the angle ACB arbitrarily chosen at five-degree intervals, so that the speed may be taken at once from trigonometric tables. The torque is expressed in synchronous watts, as the ratio of output to speed.

TABLE I—Calculation of Performance of Ideal Repulsion Motor. $E, M, F, = E = 100$ volts; Inductance of Field Coil $= X / = 10$ ohms

For all positions of brushes.										Brushes at tan 1 = 1.					Brushes at tan 1 = .25.										
1	2	3	4	5	6	7	8	9	10	11	12	13	14	15	16	17	18	19	20	21	22	23	24	25	
$E \sin \theta$	$E \cos \theta$	$\frac{1}{X}$	$\cos \theta$	$E \sin \theta$	Speed, S	Torque, T	Torque efficiency, T/Ip	Components of secondary cur., I_p	Components of Sec. cur., I_s	Speed, S	Torque, T	Torque efficiency, T/Ip	Components of secondary cur., I_p	Components of Sec. cur., I_s	Speed, S	Torque, T	Torque efficiency, T/Ip	Components of secondary cur., I_p	Components of Sec. cur., I_s	Speed, S	Torque, T	Torque efficiency, T/Ip	Components of secondary cur., I_p	Components of Sec. cur., I_s	
$\frac{E_j}{E_i}$	$\frac{E_m}{E_i}$	$\frac{E_f}{E_i}$	$\frac{E_r}{E_i}$	$\frac{E_s}{E_i}$	$\frac{1}{X}$	$\frac{1}{6}$	$\frac{7}{E3}$	-3	$\frac{2}{X}$	$\frac{2}{\sqrt{10^2+10^2}}$	$\frac{2}{4}$	$\frac{7}{E3}$	-3	$\frac{2}{4X}$	$\frac{2}{4}$	$\frac{5}{4}$	$\frac{7}{E3}$	-3	$\frac{2}{4X}$	$\frac{2}{4}$	$\frac{5}{4}$	$\frac{7}{E3}$	-3	$\frac{2}{4X}$	
100.00	0.00	10.000	.0000	00.0	0.0000	1000.0	100.0	10.000	0.000	10.00	0.0000	4000	400.0	10.000	0.0000	4000	400.0	10.000	0.0000	4000	400.0	10.000	0.0000	4000	400.0
99.62	8.716	9.962	.0872	87.0	0.0875	902.0	97.0	9.962	0.872	10.00	0.0210	3008	308.5	9.902	0.218	3008	308.5	9.902	0.218	3008	308.5	9.902	0.218	3008	308.5
98.48	17.36	9.848	.1736	170.5	0.1763	805.0	98.5	9.848	1.732	10.00	0.0441	2800	293.0	9.848	0.434	2800	293.0	9.848	0.434	2800	293.0	9.848	0.434	2800	293.0
96.59	25.88	9.659	.2588	250.0	0.2679	632.0	96.5	9.650	2.588	10.00	0.0671	2328	246.4	9.650	0.647	2328	246.4	9.650	0.647	2328	246.4	9.650	0.647	2328	246.4
93.97	34.20	9.397	.3420	321.0	0.3640	482.0	94.0	9.397	3.420	10.00	0.0910	1648	169.0	9.397	0.855	1648	169.0	9.397	0.855	1648	169.0	9.397	0.855	1648	169.0
90.63	42.26	9.063	.4226	383.0	0.4663	320.0	90.0	9.063	4.226	10.00	0.1106	928	92.8	9.063	1.057	928	92.8	9.063	1.057	928	92.8	9.063	1.057	928	92.8
86.60	50.00	8.660	.5000	433.0	0.5774	160.0	86.6	8.660	5.000	10.00	0.1444	300	30.0	8.660	1.250	300	30.0	8.660	1.250	300	30.0	8.660	1.250	300	30.0
81.92	57.36	8.192	.5736	470.0	0.7002	67.0	81.9	8.192	5.736	10.00	0.1751	280	27.7	8.192	1.434	280	27.7	8.192	1.434	280	27.7	8.192	1.434	280	27.7
76.60	64.28	7.660	.6428	491.5	0.8391	28.0	76.6	7.660	6.428	10.00	0.2068	2340	236.4	7.660	1.607	2340	236.4	7.660	1.607	2340	236.4	7.660	1.607	2340	236.4
70.71	70.71	7.071	.7071	500.0	1.0000	500.0	70.7	7.071	7.071	10.00	0.2500	2000	200.0	7.071	1.768	2000	200.0	7.071	1.768	2000	200.0	7.071	1.768	2000	200.0
64.28	76.60	6.428	.7660	491.5	1.192	412.0	64.3	6.428	7.071	10.00	0.2980	1648	164.8	6.428	1.915	1648	164.8	6.428	1.915	1648	164.8	6.428	1.915	1648	164.8
57.36	81.92	5.736	.8192	470.0	1.428	328.0	57.4	5.736	8.192	10.00	0.357	1312	129.4	5.736	2.048	1312	129.4	5.736	2.048	1312	129.4	5.736	2.048	1312	129.4
50.00	86.60	5.000	.8660	433.0	1.732	250.0	50.0	5.000	8.660	10.00	0.433	1000	100.0	5.000	2.165	1000	100.0	5.000	2.165	1000	100.0	5.000	2.165	1000	100.0
42.26	90.63	4.226	.9063	383.0	2.145	178.0	42.3	4.226	9.063	10.00	0.536	712	71.2	4.226	2.266	712	71.2	4.226	2.266	712	71.2	4.226	2.266	712	71.2
34.20	93.97	3.420	.9397	321.0	2.747	117.0	34.2	3.420	9.370	10.00	0.687	468	46.8	3.420	2.349	468	46.8	3.420	2.349	468	46.8	3.420	2.349	468	46.8
25.88	96.59	2.588	.9659	250.0	3.732	67.0	25.9	2.588	9.650	10.00	0.933	268	26.8	2.588	2.415	268	26.8	2.588	2.415	268	26.8	2.588	2.415	268	26.8
17.36	98.48	1.736	.9848	170.5	5.671	30.2	17.4	1.736	9.848	10.00	1.418	121	12.1	1.736	2.462	121	12.1	1.736	2.462	121	12.1	1.736	2.462	121	12.1
8.72	99.62	0.872	.9962	87.0	11.43	7.6	8.7	0.872	9.962	10.00	2.86	30	3.0	0.872	2.491	30	3.0	0.872	2.491	30	3.0	0.872	2.491	30	3.0

Columns 6 to 11 of Table I have been calculated on the assumption that the brush angle α of Fig. 100 was 45° , or what is the same, that the number of turns on field poles B was equal to that on the transformer poles, A , Fig. 101, and these calculations are graphically represented in Fig. 103. In Fig. 104 are given the characteristics of an ideal repulsion motor with the brush angle α of Fig. 100 having a value such that its tangent is 0.25, and the calculations recorded in columns 6' to 11' are based on this assumption. The conditions here assumed are equivalent to what would be obtained if the number of turns on the field poles, B , were 0.25 of the turns on the transformer poles, A , Fig. 101. It is further assumed that the coils on poles B

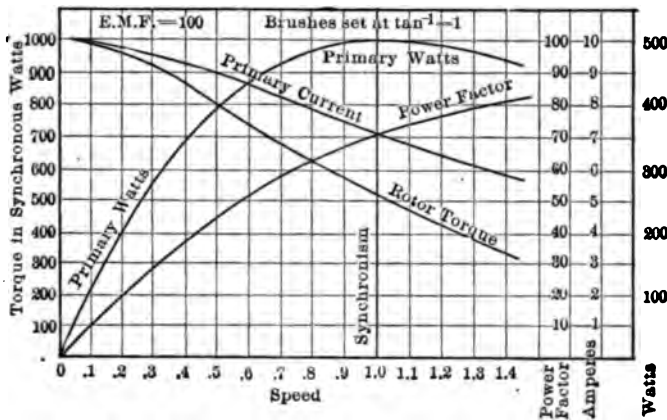

FIG. 103.—Characteristics of Ideal Repulsion Motor.

are the same in number as previously; that is, that the field reactance is 10 ohms as before, and that the turns on both the armature and transformer poles have been increased to four times their first value.

The method of calculation is quite the same as before, but perhaps a word is needed as to the calculation of the speed and secondary current. At synchronous speed, the magnetism in the field poles, B , is equal to that in the transformer poles, A , as noted above. Due to the increased number of turns on the transformer poles, at synchronous speed, the e.m.f. across the coils on A will be four times that across the coils on B , Fig. 101. A consideration of this fact leads to the conclusion that the speed is all times equal to one-fourth of the ratio of BC to AB in

Fig. 102; that is, the speed is equal to one-fourth of the co-tangent of the angle θ , arbitrarily assumed, and hence may quite readily be computed.

The component of secondary current to counterbalance the primary current is equal and opposite to the primary current, since the armature turns are equal in number to the transformer turns on A ; but the current to produce the magnetism in the transformer poles under speed conditions will at all times be one-fourth the value required to produce the same magnetism in the field poles, as will be seen from column 10' of the table.

A comparison of the curves of Fig. 103 with those of Fig. 104

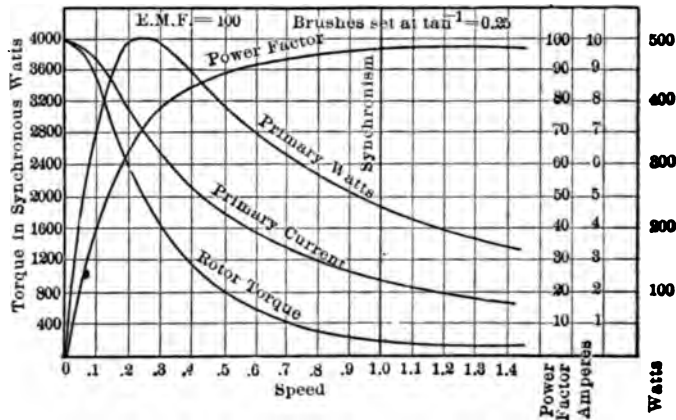

FIG. 104.—Characteristics of Ideal Repulsion Motor.

will reveal the effect of shifting the brushes from the 45° position farther toward the axial line of the transformer poles. It is essential for good performance that the angle of brush shift from the transformer position be quite small, usually from 12° to 16° , depending upon the constructive constants of the machine.

It must be very carefully noted that the curves here given are for an ideal repulsion motor, all resistance, local inductance and short-circuiting effects having been neglected, and that such curves cannot be realized in practice. It is worthy of note, however, that upon the characteristics here shown are based the discussions of the properties of the repulsion motor which have occupied so much space in the technical papers.

CHAPTER XIV.

MOTORS OF THE REPULSION TYPE TREATED BOTH GRAPHICALLY AND ALGEBRAICALLY.

ELECTROMOTIVE FORCES PRODUCED IN AN ALTERNATING FIELD.

In dealing with the phenomena connected with the operation of alternating current motors of the commutator type, it must be constantly borne in mind that the machine possesses simultaneously the electrical characteristics of both a direct current motor and a stationary alternating current transformer. The statement just made must not be confused with a somewhat similar one which is applicable to polyphase induction motors, since only with regard to its mechanical characteristics does an induction motor resemble a shunt-wound direct current machine, its electrical characteristics being equivalent in all respects to those of a stationary transformer.

Before discussing the performance of repulsion motors, it is well to investigate a few of the properties common to all commutator type, alternating current machines. It will be recalled that when the current flows through the armature of a direct current machine, magnetism is produced by the ampere turns of the armature current, such magnetism tending to distort the flux from the field poles. In the familiar representation of the magnetic circuit of machines,—the two pole model,—the armature magnetism is at right angles to the field magnetism, the armature current producing magnetic poles in line with the brushes. The amount of this magnetism depends directly on the value of the armature current and the permeability of the magnetic path. When alternating current is used, the change of the magnetism with the periodic change in the current produces an alternating e.m.f. which being proportional to the rate of change of the magnetism will be in time-quadrature to the current. The armature winding thus acts in all respects similarly to an induction coil.

It is not essential that the current to produce the alternating

flux flow through the armature coils in order that the alternating e.m.f. be developed at the commutator. Under whatsoever conditions the armature conductors be subject to changing flux a corresponding e.m.f. will be generated, in mechanical line with the flux and in time-quadrature to it. Referring to Fig. 105 which represents a direct current armature situated in an alternating field, having two pair of brushes, one in mechanical line with the alternating flux and one in mechanical quadrature thereto. When the armature is stationary an e.m.f. will be generated at the brushes *A* and *A* due to the transformer action

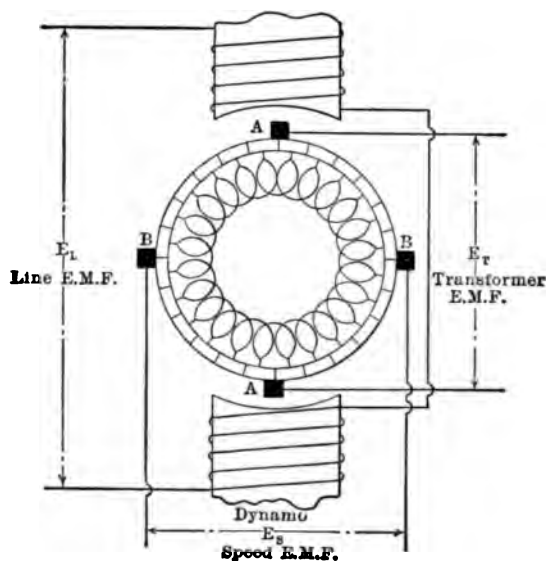

FIG. 105.—Electromotive Forces Produced in an Alternating Field.

of the flux, but no measurable e.m.f. will exist between *B* and *B*. As seen above, this e.m.f. is in time-quadrature with the field (transformer) flux and as will be seen later, its value is unaltered by any motion of the armature. At any speed of the armature, there will be generated at the brushes *B* and *B* an e.m.f. proportional to the speed and to the field magnetism and in time-phase with the magnetism. At a certain speed this "dynamo" e.m.f. will be equal in effective value to the "transformer" e.m.f. at *A* and *A*, though it will be in time-quadrature to it. This critical speed will hereafter be referred to as the

"synchronous" speed, and with the two-pole model shown in Fig. 105 it is characterized by the fact that in whatsoever position on the armature a pair of brushes be placed across a diameter, the e.m.f. between the two brushes will be the same and will have a relative time-phase position corresponding to the mechanical position of the brushes on the commutator.

A little consideration will show that the individual coils in which the maximum e.m.f. is generated by transformer action are situated upon the armature core under brush B or B , although the difference of potential between the brushes B and B is at all times of zero value as concerns the transformer action. A similar study leads to the conclusion that the e.m.f. generated by dynamo speed action appears as a maximum for a single coil when the coil is under brush A or A . Assuming as zero position, the place under brush A and that at synchronous speed the e.m.f. generated in a coil at this position is e . Then the e.m.f. in a coil at b will equal e also. A coil a degrees from this position will have generated in it a speed e.m.f. of $e \cos a$ and a transformer e.m.f. of $e \cos (a \pm 90) = \pm e \sin a$. Since these two component e.m.f.s. are in time quadrature the resultant will be $V = \sqrt{(e \cos a)^2 + (\pm e \sin a)^2} = e$ and is the same for all values of a . The time-phase position of the resultant, however, will vary directly with a or with the mechanical position of the coil. From these facts it is seen that at synchronous speed the effective value of the e.m.f. generated per coil at all positions is the same and that there is no neutral e.m.f. position on the commutator.

THE SIMPLE REPULSION MOTOR.

In a repulsion motor as commercially constructed, the secondary consists of a direct current armature upon the commutator of which brushes are placed in positions 180 electrical degrees apart and directly short circuited upon themselves, as shown in the two-pole model of Fig. 106. The stationary primary member consists of a ring core containing slots more or less uniformly spaced around the air-gap. In these slots are placed coils so connected that when current flows in them definite magnetic poles will be produced upon the field core. The brushes on the commutator are given a location some 15 degrees from the line of polarization of the primary magnetism, or

more properly expressed, the brushes are placed about 15 degrees from the true transformer position. That component of the magnetism which is in line with the brushes produces current in the secondary by transformer action, and this current gives a torque to the rotor due to the presence of the other component of magnetism in mechanical quadrature to the secondary current.

It is possible to make certain assumptions as to the relative values of the magnetism in mechanical line with, and in mechanical quadrature to the brush line and thus to derive the

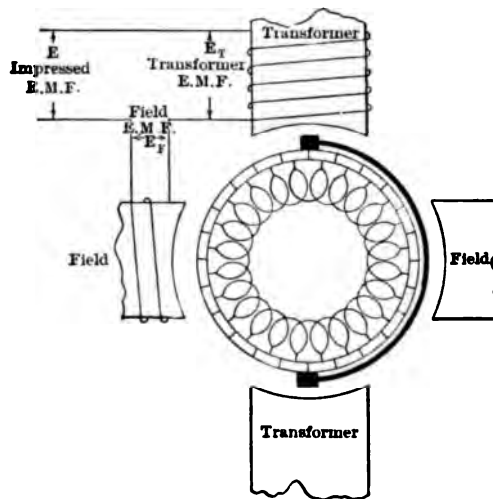

FIG. 106.—Two-pole Model of Ideal Repulsion Motor.

fundamental equations of the machine. It is believed, however, that the facts can be more clearly presented and the treatment simplified without sacrifice of accuracy if the assumption be made that the primary coil is wound in two parts, one in mechanical line and the other in mechanical quadrature with the axial brush position as shown in Fig. 106. It will be noted that the two fields produced by the sections of the primary coil, if there were no disturbing influence present, would have a resultant position relative to the brush line depending upon the ratio of the strengths of the two magnetisms. The angle which the resultant field would assume can be represented by β having a

value such that $\cotan \beta = \frac{\phi_t}{\phi_f}$ where ϕ_t is the flux through transformer coil and ϕ_f is flux through field coil. If n be the ratio of turns on the transformer poles to those on the field poles, then for any value of current in these coils (no secondary current)

$$\frac{\phi_t}{\phi_f} = n \text{ or } n = \cotan \beta \quad (1)$$

It is understood that in Fig. 106, the core material is considered to be continuous and that in the two-pole model represented both field poles and both transformer poles are supposed to be properly wound.

In Fig. 106, let it be assumed that the machine is stationary and that a certain e.m.f., E , is impressed upon the primary circuits, the secondary being on short circuit. The flux which the primary current tends to produce in the transformer pole produces by its rate of change an e.m.f. in the secondary, and this e.m.f. causes opposing current to flow in the closed secondary circuit. If the transformer action is perfect and the transformer coil and armature circuits are without resistance and local leakage reactance, then the magnetomotive force of the armature current equals that of the current in the transformer coil, and the resultant impedance effect of the two circuits is of zero value, so that the full primary e.m.f., E , is impressed upon the field coil; that is to say, with armature stationary $E_t = 0$, and $E_f = E$.

EFFECT OF SPEED ON THE STATOR ELECTROMOTIVE FORCES.

It remains now to investigate the effect of speed on the electromotive forces of the transformer and field coils. Assume a certain flux ϕ in the field coil. At speed S the armature conductors will cut this flux and at each instant there will be generated an e.m.f. therein proportional to $S\phi_f$, and therefore, in time-phase with the flux. This e.m.f. would tend to cause current to flow in the closed armature circuit, which current would produce magnetism in line with the brushes, and, since the armature circuit has zero impedance, (assumed) the flux so produced will be of a value such that its rate of change through the armature coils just equals the e.m.f. generated therein by speed action. At synchronous speed, the secondary being closed, the

flux in line with the brushes must equal that in line with the field poles, since the e.m.f. generated by the rate of change of the flux in the direction of the brushes must equal that generated at the brushes due to cutting the field magnetism, and at a speed which has been termed synchronous these two fluxes are equal, as previously discussed. At this speed the two fluxes are equal but they are in time-quadrature one to the other. At other speeds the two fluxes retain the quadrature time-phase position, but the ratio of the effective values of the two fluxes varies directly with the speed.

FUNDAMENTAL EQUATIONS OF THE REPULSION MOTOR.

Giving to synchronous speed a value of unity, at any speed, S , the transformer flux may be expressed by the equation

$$\phi_t = S \phi_f \quad (2)$$

effective values being used throughout. Letting ϕ be the maximum values of the field flux and reckoning time in electrical degrees from the instant when the field flux is maximum, at any time γ , the instantaneous field flux is

$$\phi_f = \phi \cos \gamma \quad (3)$$

and the transformer flux is

$$\phi_t = S \phi \sin \gamma \quad (4)$$

These are the fundamental magnetic equations of the ideal repulsion motor.

If at a certain speed S , the effective value of e.m.f. across the field coil be F , requiring an effective flux of ϕ_f , then across the transformer coil there will be an effective e.m.f. of

$$T = n S F \quad (5)$$

due to the flux $S \phi_f$. Since the fluxes are in time-quadrature, the e.m.fs. are likewise in time quadrature, so that the impressed e.m.f. E must have a value such that

$$E = \sqrt{F^2 + T^2} \quad (6)$$

This is the fundamental electromotive force equation of the repulsion motor.

The current which flows through the field coil is

$$I = \frac{F}{X} \quad (7)$$

where X is the inductive reactance of the field coil. Equation (7) gives the value of the primary circuit current and is the fundamental primary current equation.

The secondary armature current in general consists of two components, that equal in magnetomotive force and opposite in phase to the primary transformer current, and that necessary to produce the flux in line with the brushes. With a ratio of effective armature turns to field turns of a , the opposing transformer current is

$$I_t = \frac{nI}{a} \quad (8)$$

and the current which produces the transformer poles is

$$I_i = \frac{S I}{a} \quad (9)$$

These component currents are in time-quadrature, so that the resultant secondary current is

$$I_a = \sqrt{I_t^2 + I_i^2} \quad (10)$$

This is the fundamental equation for the secondary current. Combining (8), (9) and (10)

$$I_a = \frac{I}{a} \sqrt{n^2 + S^2} \quad (11)$$

It has been seen that the e.m.f. T is in time-quadrature to the field circuit e.m.f., F . Now the current is in time-quadrature with F , and hence, is in time-phase with T . Therefore, of the total primary e.m.f. E , the part T is in phase with the current, from which fact it is seen that the power factor is

$$\cos \theta = \frac{T}{E} \quad (12)$$

Power,

$$P = E I \cos \theta = \frac{E F T}{X E} = I T \quad (13)$$

Torque,

$$D = \frac{P}{S} = \frac{I T}{S} = \frac{I S n F}{S} = I n F$$

$$D = I n F = I n X I = P n X \quad (14)$$

$$E^2 = F^2 + T^2 = F^2 (1 + S^2 n^2) \quad (15)$$

$$F = \frac{E}{\sqrt{1 + S^2 n^2}} \quad (16)$$

$$I = \frac{E}{X \sqrt{1 + S^2 n^2}} \quad (17)$$

$$I_a = \frac{E \sqrt{n^2 + S^2}}{a X \sqrt{1 + S^2 n^2}} \quad (18)$$

when $n = 1$, that is at $\beta = 45^\circ$ see (1)

$$I_a = \frac{E}{a X} \text{ and is constant at all speeds.}$$

when $S = 1$, that is at synchronism for any value of n .

$$I_a = \frac{E}{a X} \text{ which is seen to be equal to the primary}$$

current at starting (when $a = 1$)

when $S = 1$ the secondary current

$$I_a = \frac{I}{a} \sqrt{n^2 + 1}$$

and leads the primary current by angle $\cotan^{-1} n = \beta$ or angle of brush shift. See equation (1).

VECTOR DIAGRAM OF IDEAL REPULSION MOTOR.

The above equations can be expressed graphically by a simple diagram as shown in Fig. 107. The diagram is constructed as follows: OE is the constant line e.m.f. OA at rt. angles to OE is the line current at starting, $OB A$ is a semicircle, OF in phase opposition to OA is the secondary current at starting. $OD F$ is a semicircle. OG , in phase with OA , is the secondary current at infinite speed. $OH G$ is a semicircle. It will be noted that the ratio OA to OG is $n a:1$ and ratio of OA to OF is $a:n$.

Distances measured from P in the direction of T represent speed.

The characteristics of the machine may be found at once from

Fig. 107. Assuming any speed as PS , draw OS intersecting the circle OBA at B . From point G draw line GK parallel to OS . Join O and K .

- OK is secondary current;
- OB is primary current;
- EOS is primary angle of lag;
- BC is power component of primary current;

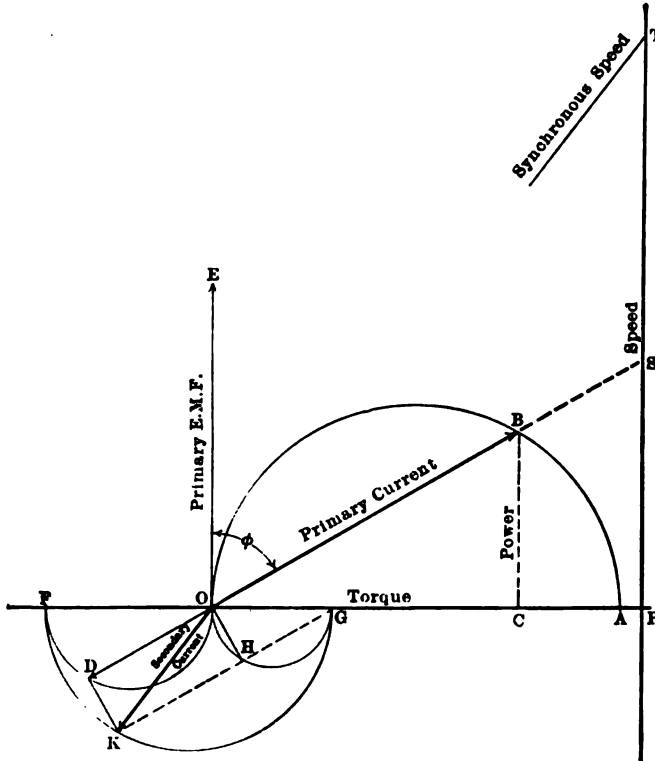

FIG. 107.—Vector Diagram of Ideal Repulsion Motor.

- BC is power (to proper scale);
 - OC is torque (to proper scale);
 - DOK is angle of lead of secondary current.
- At synchronous speed ($S = 1$) $\cotan \theta = n$, hence scale of speed can readily be located.
- $OD = I_s$, see equation (8)
 - $OH = I_r$, see equation (9).

The proof of the construction of diagram of Fig. 107 is as follows:

$$\cos \theta = \frac{T}{E} \quad \text{Eq. (11)}$$

$$E^2 = T^2 + F^2 \quad \text{Eq. (6)}$$

$$T = S n F \quad \text{Eq. (5)}$$

$$E^2 = T^2 \left(1 + \frac{1}{S^2 n^2} \right) \quad (19)$$

$$E = \frac{T}{S n} \sqrt{1 + S^2 n^2} \quad (20)$$

$$\cos \theta = \frac{T}{E} = \frac{S n}{\sqrt{1 + S^2 n^2}} \quad (21)$$

Power component of primary current

$$I_p = I \cos \theta = \frac{E}{X} \frac{S n}{(1 + S^2 n^2)} \quad (22)$$

$$\sin \theta = \sqrt{1 - \frac{S^2 n^2}{1 + S^2 n^2}} = \frac{1}{\sqrt{1 + S^2 n^2}} \quad (23)$$

Quadrature component of primary current

$$I_q = I \sin \theta = \frac{E}{X \sqrt{1 + S^2 n^2}} \frac{1}{\sqrt{1 + S^2 n^2}}$$

$$I_q = \frac{E}{X (1 + S^2 n^2)} \quad (24)$$

$$\frac{I_p}{I_q} = \cotan \theta = \frac{E}{X} \frac{S n}{1 + S^2 n^2} \frac{X (1 + S^2 n^2)}{E}$$

$$\cotan \theta = S n \quad (25)$$

The cotangent of the angle of lag is directly proportional to the speed, the proportionality constant being the ratio of transformer to field turns.

$$D = \frac{I E \cos \theta}{S} = \frac{E^2 n}{X (1 + S^2 n^2)} = n E I_q \quad (26)$$

Torque is proportional to quadrature component of the primary current (for given e.m.f.) the proportionality constant being the ratio of transformer to field turns.

$$D = \frac{E^2 n}{X (1 + S^2 n^2)} = I^2 n X \quad (27)$$

Torque varies as the square of the primary current and in this respect is independent of the speed or the e.m.f.

A comparison of equations (26) and (27) reveals an interesting property of a circle. In Fig. 107, assuming the diameter AO to be unity, OC at all values of angle θ equals the square of OB .

From equation (27) it is seen that the torque is at all times positive, even when S is negative. Hence the machine acts as generator at negative speed. For the determination of the generator characteristics it is necessary to construct the semi-circle omitted in each case in Fig. 107.

It is interesting to observe that the construction of the diagram of Fig. 107 can be completed at once when points F, O, G and A and E are located. Thus the complete performance of the ideal repulsion motor can be determined when E, X, n and a are known. In the construction for ascertaining the value of the secondary current, it will be seen that OK is equal to the vector sum of OD and OH , giving the vector OK . From the properties of vector co-ordinates it will be noted that the point K is located on the semicircle FKG whose center lies in the line FOG . Therefore if G and F be located, the inner circles FDO and OHG need not be drawn, since the point K can be found as the intersection of the line drawn parallel to OB from G with the circular arc FKG .

CORRECTIONS FOR RESISTANCE AND LOCAL LEAKAGE REACTANCE.

It is to be carefully noted that the above discussion refers to ideal conditions which can never be realized. The circuits have been considered free from resistance and leakage reactance while all iron losses, friction, and brush short circuiting effects have been neglected. The resistance and leakage reactance effects can quite easily be taken into account, but the remaining disturbing influences are subject to considerable error in approximating their values, due primarily to the difficulty in assigning

to iron any constant in connection with its magnetic phenomena. It is to be regretted that the so-called complete equations for expressing the characteristics of this type of machinery with almost no exception neglect these disturbing influences, and yet these same equations are given forth by the various writers as though they represented the true conditions of operation.

In the ideal motor the apparent impedance is

$$Z = \frac{E}{I} = X \sqrt{1 + S^2 n^2} \quad (28)$$

apparent resistance is

$$R = Z \cos \theta = X S n \quad (29)$$

since

$$\cos \theta = \frac{T}{E}; \quad T = S n F; \quad \text{and } E = \sqrt{T^2 + F^2}$$

hence

$$E = \frac{T}{S n} \sqrt{1 + S^2 n^2}; \quad \cos \theta = \frac{S n}{\sqrt{1 + S^2 n^2}}$$

apparent reactance is

$$X = Z \sin \theta = X \quad (30)$$

since

$$\sin \theta = \sqrt{1 - \frac{S^2 n^2}{1 + S^2 n^2}} = \frac{1}{\sqrt{1 + S^2 n^2}}$$

Let R_f = resistance of field coil

R_t = resistance of transformer coil

R_a = resistance of armature coil

X_a = reactance of armature coil

X_t = reactance of transformer coil

X_f = reactance of field coil

then copper loss of motor circuits will be

$$I^2 (R_f + R_t) + I_a^2 R_a \quad (31)$$

$$I_a = \frac{E \sqrt{n^2 + S^2}}{a X \sqrt{1 + S^2 n^2}} \quad (18)$$

$$I = \frac{E}{X \sqrt{1 + S^2 n^2}} \quad (17)$$

hence

$$I_a = \frac{I \sqrt{n^2 + S^2}}{a} \quad (32)$$

and copper loss will be

$$I^2 \left[(R_f + R_t) + \left(\frac{n^2 + S^2}{a} \right) R_a \right] = I^2 R_m \quad (33)$$

where R_m is the effective equivalent value of the motor circuit resistance, that is

$$R_m = R_f + R_t + \left(\frac{n^2 + S^2}{a} \right) R_a \quad (34)$$

Similarly it may be shown that the effective equivalent value of the leakage reactance of the motor circuits is

$$X_m = X_f + X_t + \left(\frac{n^2 + S^2}{a} \right) X_a \quad (35)$$

If these values be added to the apparent resistance and reactance of the ideal motor the corresponding effects will be represented in the resultant equations thus

$$\underline{R} = X S n + R_f + R_t + \left(\frac{n^2 + S^2}{a} \right) R_a \quad (36)$$

and

$$\underline{X} = X + X_f + X_t + \left(\frac{n^2 + S^2}{a} \right) X_a \quad (37)$$

$$Z = \sqrt{\underline{R}^2 + \underline{X}^2} \text{ from (36) and (37)} \quad (38)$$

$$\cos \theta = \frac{R}{Z}; \quad I = \frac{E}{\underline{Z}} \quad (39)$$

$$\text{Input} = E I \cos \theta \quad (40)$$

$$\text{output} = E I \cos \theta - I^2 R_m = P \quad (41)$$

$$\text{torque} = \frac{P}{S} = D, \text{ etc.} \quad (42)$$

BRUSH SHORT-CIRCUITING EFFECT.

It will be noted that the short circuiting by the brush of a coil in which an active e.m.f. is generated has thus far not been considered. Referring to Fig. 106, it will be seen that at any speed S there will be generated in the coil under the brush by dynamo speed action an e.m.f.

$$E_s = K \phi_i S \quad (43)$$

where K is constant. This e.m.f. is in time-phase with the flux ϕ_i . In this coil there will also be generated an e.m.f. by the transformer action of the field flux, such that,

$$E_j = K \phi_j \quad (44)$$

This e.m.f. is in time-quadrature to ϕ_j . Since ϕ_j and ϕ_i are in time quadrature the component e.m.f.s. acting in the coil under the brush are in time-phase (opposition) so that the resultant e.m.f. is

$$E_b = E_j - E_s = K (\phi_j - S \phi_i) \quad (45)$$

$$E_b = K \phi_j (1 - S^2) \quad \text{Eq. (2)} \quad (46)$$

Since for constant frequency of supply current, F is proportional to ϕ_j we may write $\phi_j = C F$, C being a constant depending on the number of field turns.

$$\phi_j = C F = \frac{C E}{\sqrt{1 + S^2 n^2}} \quad \text{Eq. (16)} \quad (47)$$

hence

$$E_b = \frac{K C E (1 - S^2)}{\sqrt{1 + S^2 n^2}} \quad (48)$$

which becomes zero at $\pm S = 1$, that is at synchronizing when operated as either a motor or a generator. Above synchronism E_b increases rapidly with increase of speed.

The friction loss can best be taken into account by considering the friction torque as constant ($= d$) and subtracting this value from the delivered electrical torque so that the active mechanical torque becomes,

$$\text{Torque} = D - d \quad (49)$$

While the effect of the iron loss is relatively small as concerns the electrical characteristics of the machine it is obviously in-

correct to neglect it when determining the efficiency. For purpose of analysis it is convenient to divide the core material into three parts, the armature the field and the transformer portions. Since the frequency of the reversal of the flux in both the transformer and the field portions is constant the losses therein will depend only upon the flux. Thus considering hysteresis only, the transformer iron loss is

$$H_t = L \phi_t^{1.6} \tag{50}$$

where L is a constant depending upon the mass of the core material. Similarly the field iron loss is

$$H_f = M \phi_f^{1.6} \tag{51}$$

M being a constant

$$H_t + H_f = \phi_i^{1.6} (M + S L) \quad \text{Eq. (2)} \tag{52}$$

Since both the field and the transformer fluxes pass through the armature core and these two fluxes are of the same frequency but displaced in quadrature both in mechanical position and in time-phase relation, the resultant is an elliptical field revolving always at synchronous speed, having one axis in line with the transformer and the other in line with the field, the values being $\sqrt{2} \phi_t$ and $\sqrt{2} \phi_f$ respectively. The value of the two axes may be written thus

$$\sqrt{2} S \phi_f \text{ and } \sqrt{2} \phi_f$$

At synchronous speed of the armature the two become equal and since no portion of the iron is then subjected to reversal of magnetism the iron loss of the armature core is of zero value. At other speeds, while the revolving elliptical field yet travels synchronously, the armature does not travel at the same speed, so that certain sections of the armature core are subjected to fluctuations of magnetism while others are subjected to complete reversals, the sections continually being interchanged. It is due to this fact that no correct equation can be formed to represent the core loss of the armature at all speeds, since the behavior of iron when subjected to fluctuating magnetism cannot be reduced to a mathematical expression.

OBSERVED PERFORMANCE OF REPULSION MOTOR.

Fig. 108 shows the observed characteristics of a certain four-pole repulsion motor when operated at $22\frac{1}{2}$ cycles, the synchronous speed being 675 r.p.m. It will be noted that up to

either positive or negative synchronism the apparent reactance is practically constant and the resistance varies directly with the speed, but that beyond synchronism the reactance tends to increase and the resistance is no longer proportional to the speed, the power factor tending to decrease. The detrimental effects above synchronism may be attributed largely to the e.m.f. generated in the coil short circuited by the brush, as indicated in equation (48).

COMPENSATED REPULSION MOTOR.

A type of motor closely related to the repulsion machine in the performance of its magnetic circuits is the compensated

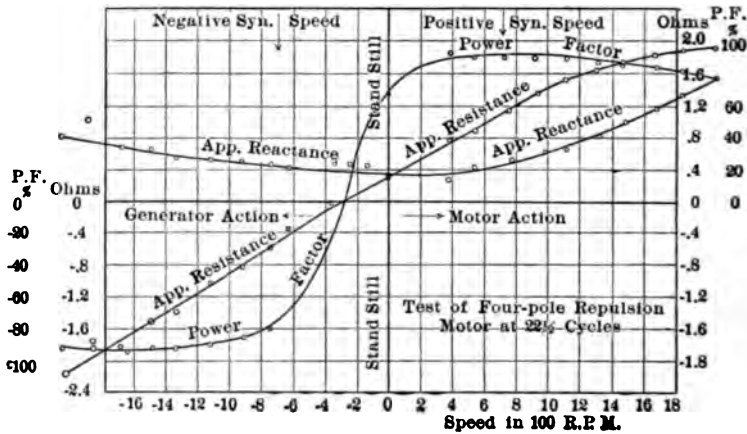

FIG. 108.—Test of Repulsion Motor.

repulsion motor shown in Fig. 109. Its electrical circuits seem to be those of a series machine with the addition of a second set of brushes, *A A*, placed in mechanical line with the field coil and short-circuited upon themselves. The transformer action of this closed circuit is such that the real power which the motor receives is transmitted to the armature through this set of brushes, while the remaining set, *B B*, which in the plain series motor receives the full electrical power of the machine, here serves to supply only the wattless component of the apparent power. This complete change in the inherent characteristics of the series machine by the mere addition of two brushes renders the study of this type of motor especially interesting.

For purpose of analysis, assume an ideal motor without resistance or local leakage reactance and consider first the conditions when the armature is at rest. When a certain e.m.f., E , is impressed upon the motor terminals, the counter magnetizing effect of the current in the brush circuits, $A A$, is such that the e.m.f. across the transformer coil is of zero value, while that across the armature is E . Thus when $S = 0$, letting $E_t =$ transformer e.m.f. and $E_a =$ armature e.m.f.,

$$E_t = 0, \text{ and } E_a = E \tag{53}$$

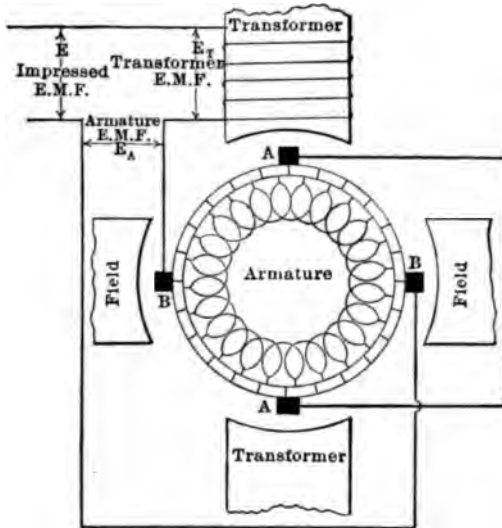

FIG. 109.—Two-pole Model of Compensated Repulsion Motor.

It is evident also that when $S = 0$ the flux through the armature in line with the brushes $A A$ will be of zero value, so that

$$\phi_t = 0 \tag{54}$$

Let ϕ_f be the flux through the armature in line with the brushes $B B$. This flux, neglecting hysteretic effects, is in time-phase with the line current and produces by its rate of change through the armature turns a counter e.m.f. of value $E_f = E$, giving to the armature circuit a reactance when stationary, of X .

The relation which exists between the flux, the frequency, and the number of armature turns can be expressed thus,

$$E_f = \frac{2 \pi j N \phi_m}{\sqrt{2} 10^8} \quad (55)$$

where

$$\begin{aligned} j &= \text{frequency in cycles per second} \\ N &= \text{effective number of armature turns} \\ \phi_m &= \text{maximum value of flux.} \end{aligned}$$

If C be the actual number of conductors on the armature, the actual number of turns will be $\frac{C}{2}$. These turns are evenly distributed over the surface of the armature, so that any flux which passes through the armature core will generate in each individual turn an e.m.f. proportional to the product of the cosine of the angle of displacement from the position giving maximum e.m.f. and the value of the maximum e.m.f. generated by transformer action in the position perpendicular to the flux, or the average e.m.f. per turn will be $\frac{2}{\pi}$ times the maximum. The $\frac{C}{2}$ turns are connected in continuous series, the e.m.f. in each half adding in parallel to that in the other half, so that the effective series turns equal $\frac{C}{4}$. Thus, finally

$$N = \frac{2 C}{\pi 4} = \frac{C}{2 \pi} \quad (56)$$

$$\text{and } E_f = \frac{C \phi_m f}{\sqrt{2} 10^8} \quad (57)$$

The value of the reactance will depend inversely upon the reluctance of the paths through which the armature current must force the flux. The major portion of the reluctance is found in the air-gap, and with continuous core material and uniform air-gap around the core, the reluctance will be practically constant in all directions and will be but slightly affected by the change in specific reluctance of the core material, provided magnetic saturation is not reached. In the following discussion it will be assumed that the reluctance is constant in the direction of both

sets of brushes, and that the core material on both the stator and rotor is continuous.

APPARENT IMPEDANCE OF MOTOR CIRCUITS.

When dealing with shunt circuits it is convenient to analyze the various components of the current at constant e.m.f., or assuming an e.m.f. of unity, to analyze the admittance and its components. When series circuits are being considered, however, the most logical method is to deal with the e.m.fs. for constant current, or to assume unit value of current and analyze the impedance and its various components. In accordance with the latter plan, it will be assumed initially that one ampere flows through the main motor circuits at all times and the various e.m.fs. (impedances) will thus be investigated.

An inspection of Fig. 109 will show that one ampere through the armature circuit by way of the brushes *B B* will produce a definite value of flux independent of any changes in speed of the rotor, since there is no opposing magnetomotive force in any inductively related circuit. From this fact it follows that on the basis of unit line current ϕ_a has a constant effective value, although varying from instant to instant according to an assumed sine law. As will appear later, while both the current through the armature and the flux produced thereby have unvarying, effective values and phase positions, the apparent reactance of the armature is not constant, but follows a parabolic curve of value with reference to change in speed.

When the armature travels at any certain speed the conductors cut the flux which is in line with the brushes *B B* and there is generated at the brushes *A A* an electromotive force proportional at each instant to the flux ϕ_f and hence in time-phase with ϕ_f , or with the armature current through *B B*.

Let ϕ_m = maximum value of ϕ_f , then the maximum value of the e.m.f. generated at *A A* due to dynamo speed action will be,

$$E_m = \frac{C \phi_m V}{10^8} \tag{58}$$

where *V* is revolutions per second. The virtual value of this electromotive force will be

$$E_v = \frac{C \phi_m V}{\sqrt{2} 10^8} \tag{59}$$

A comparison of (54) and (55) will show that at a speed V revolutions per second such that $V = \bar{f}$ in cycles per second, $E_r = E$ for any value of ϕ_m . Consequently, the speed e.m.f. due to any flux threading the armature turns, at synchronism becomes equal to the transformer e.m.f. due to the same flux through the same turns. E_r is in time-quadrature and E_t in time-phase with the flux at any speed, hence, E_r is in time-quadrature with E_t or in time-phase with the line current.

The brushes AA remain at all times connected directly together by conductors of negligible resistance so that the resultant e.m.f. between the brushes must remain of zero value. On this account when an e.m.f. E_r is generated between the brushes by dynamo speed action, a current flows through the local circuit giving a magnetomotive force such that the flux produced thereby generates in the armature conductors by its rate of change, an e.m.f. equal and opposite to E_r . This flux, ϕ_r , is proportional to E_r and being in time-quadrature thereto, is in time-phase with E_t or in time-quadrature with ϕ .

FUNDAMENTAL EQUATIONS OF THE COMPENSATED REPULSION MOTOR.

From the transformer relations it is seen that

$$E_r = \frac{C \sqrt{2} \phi_t \dot{i}}{\sqrt{2} 10^8} \quad (60)$$

where $\sqrt{2} \phi_t$ is maximum value of flux due to current through brushes AA . See (57).

$$E_r = G \phi_t \quad (61)$$

where G is a proportionality constant.

Let S be the speed, with synchronism as unity, then

$$E_r = S E_t \quad (62)$$

and

$$\phi_r = S \phi_t, \quad (63)$$

effective values being used. This is the fundamental magnetic equation of the compensated repulsion motor.

Flux ϕ_t passes through the transformer turns on the stator in line with the brushes AA as shown in Fig. 109 and generates therein by its rate of change an e.m.f. E_t such that

$$E_t = n E_v \quad (64)$$

where n is the ratio of effective transformer to armature turns. This e.m.f. is in phase with E_v , in quadrature with E_f and hence is in phase opposition with the line current and produces the effect of apparent resistance in the main motor circuits.

Combining (62) and (64)

$$E_t = S n E_f \quad (65)$$

Since E_f is the transformer e.m.f. in the armature circuits due to constant effective value of flux from one ampere, we may write

$$E_f = X \quad (66)$$

where X is the stationary reactance of the armature circuit, so that the apparent resistance of the transformer circuit is

$$\underline{R} = S n X \quad (67)$$

Under speed conditions the armature conductors cut the flux in line with the brushes $A A$, and there is generated thereby an e.m.f. which appears as a maximum at the brushes $B B$. This e.m.f. is in phase with ϕ_t , in quadrature with ϕ_f and in phase opposition to E_f . If E_s be the value of this e.m.f. we may write

$$E_s = \frac{C \sqrt{2} \phi_t S}{\sqrt{2} 10^8} \quad (68)$$

from dynamo speed relations. Comparing (60) and (68) and remembering that f is unity in terms of speed, there is obtained

$$E_s = S E_v \quad (69)$$

from (62) and (66)

$$E_s = S^2 E_f = S^2 X \quad (70)$$

Therefore the e.m.f. across the armature at $B B$ will be

$$E_a = E_f - E_s = X (1 - S^2) \quad (71)$$

This e.m.f. is in quadrature with the line current and is in effect an apparent reactance, so that the apparent reactance of the motor circuits which is confined to the armature winding is

$$\underline{X} = X (1 - S^2) \quad (72)$$

The apparent impedance of the motor circuits at speed S is

$$\underline{Z} = \sqrt{\underline{R}^2 + \underline{X}^2} = \sqrt{(S n X)^2 + X^2 (1 - S^2)^2} \quad (73)$$

This is the fundamental impedance equation of the ideal repulsion-series motor.

The power factor is

$$\cos \theta = \frac{R}{Z} = \frac{S n X}{\sqrt{(S n X)^2 + X^2 (1 - S^2)^2}} \quad (74)$$

The line current is

$$I = \frac{E}{Z} = \frac{E}{\sqrt{S^2 n^2 X^2 + X^2 (1 - S^2)^2}} \quad (75)$$

The power is,

$$P = E I \cos \theta = \frac{E^2 S X n}{X^2 S^2 n^2 + X^2 (1 - S^2)^2} \quad (76)$$

It will be noted that both the power and the power factor reverse when S is negative. Thus the machine becomes a generator when driven against its torque.

The wattless factor is,

$$\sin \theta = \frac{X}{Z} = \frac{X (1 - S^2)}{\sqrt{S^2 n^2 X^2 + X^2 (1 - S^2)^2}} \quad (77)$$

and becomes negative when S is greater than 1, so that above synchronism when operated as either a generator or motor the machine draws leading wattless current from the supply system. At $S = 1$, $\sin \theta = 0$, which means that the power factor is unity at synchronous speed, as may be seen also from eq. (74).

At $S = 0$,

$$I = \frac{E}{X}$$

At $S = 1$, $I = \frac{E}{nX}$ That is, at

synchronism the line current is equal to the current at start divided by the ratio of transformer to armature turns. If $n = 1$, the current at synchronism is of the same value as at start but the power factor which at start was 0 has a value of 1 at synchronism. This interesting feature will be touched upon later.

The torque is

$$D = \frac{P}{S} = \frac{E^2 n X}{\sqrt{X^2 S^2 n^2 + X^2 (1 - S^2)^2}} = P^2 n X \quad (78)$$

and is maximum at maximum current and retains its sign when S is reversed.

When $S = 0$ the secondary current, I_s , is $n I$, and is in phase opposition with the transformer current I . See Fig. 109. When $S = 1$

$$I_s = \sqrt{n^2 I^2 + I^2} \quad \text{and at any speed } S,$$

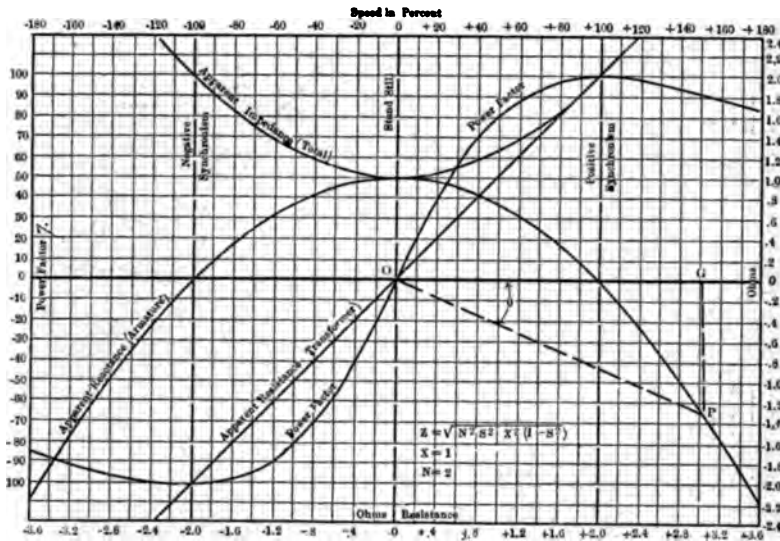

FIG. 110.—Characteristics of Ideal Compensated Repulsion Motor.

$$I_s = \sqrt{n^2 I^2 + S^2 I^2} = I \sqrt{n^2 + S^2} \quad (79)$$

$$I_s = \frac{E \sqrt{n^2 + S^2}}{\sqrt{S^2 n^2 X^2 + X^2 (1 - S^2)^2}} \quad (80)$$

VECTOR DIAGRAM OF COMPENSATED REPULSION MOTOR.

In Fig. 110 are shown the results of calculations for a certain ideal compensated repulsion motor of which $X = 1$ and $n = 2$. It is seen that with speed as abscissa, the curve representing the apparent resistance of the motor circuits is a right line

while that for the apparent reactance is a parabola. At any chosen speed the quadrature sum of these two components gives the apparent impedance of the motor. Since the scale for representing the speed is in all respects independent of that used for the apparent resistance, it is possible always so to select values for the one scale such that a given distance from the origin may simultaneously represent both the resistance and the speed. This method of plotting the values leads to a very simple vector diagram for representing both the value and phase position of the apparent impedance at any speed, and for determining the

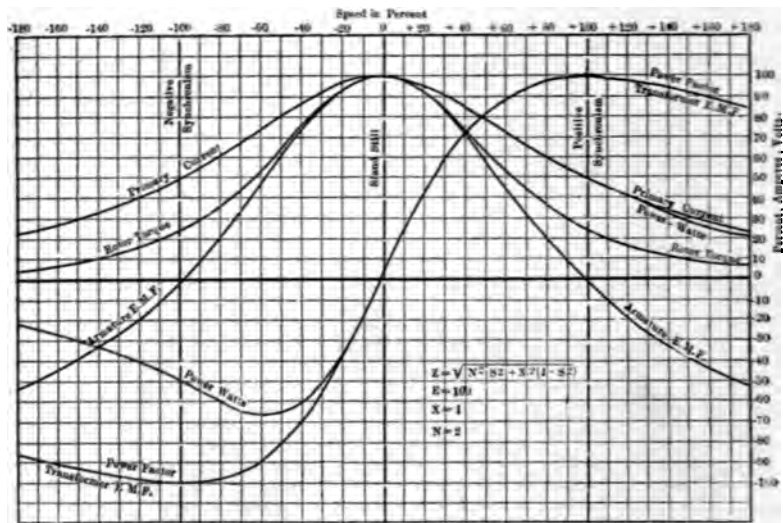

FIG. 111.—Characteristics of Ideal Compensated Repulsion Motor.

power-factor from inspection. Thus at any speed such as is shown at G the distance OG is the apparent resistance, the distance GP is the apparent reactance, OP is the apparent impedance while the angle POG is the angle of lead of the primary current and its cosine is the power-factor.

Fig. 111 gives the complete performance characteristics of the above ideal compensated repulsion motor at various positive and negative speeds when operated at an impressed e.m.f. of 100 volts.

It will be noted that the armature e.m.f., which has a certain value at standstill, decreases with increase of speed, becomes

zero at synchronism and then increases at higher speeds. The transformer e.m.f. is zero at starting, increases to a maximum at synchronism and then continually decreases with increase of speed.

CALCULATED PERFORMANCE OF COMPENSATED REPULSION MOTOR.

The inductive portion of the impedance is contained wholly by the armature circuit, while the non-inductive is confined to the transformer coil; thus the power-factor is zero at standstill, reaches unity at synchronism and then decreases due to the lagging component of the motor impedance (leading wattless current). In comparison with the ordinary compensated series motor whose armature e.m.f. is, for the most part, non-inductive and continually increases with increase of speed, and whose inductive field e.m.f. decreases continually with increase of speed and whose power-factor never reaches unity, the compensated-repulsion motor furnishes a most striking contrast. The machine resembles the repulsion motor in regard to its magnetic behavior, but the performance of its electric circuits differs from that of the repulsion motor due to the fact that the speed e.m.f. introduced into the armature circuit BB (Fig. 109) which has been substituted for the field coil of the repulsion motor (see Fig. 106) is in a direction continually to decrease the apparent reactance of the field circuit and thus to decrease the inductive component of the impedance of the circuits and to improve the power factor and the operating characteristics. It is an interesting fact that under all conditions of operation the e.m.f. in the coils short circuited by the brushes BB is of zero value, so that no objectional features are introduced by substituting the armature circuit for the field coil of the repulsion motor, while the performance is materially improved. Experiments show that even with currents of many times normal value and at the highest commercial frequency no indication of sparking is found at the brushes BB . This feature will be treated in detail later.

An inspection of Fig. 110 and of equation (73) will reveal the fact that at synchronism the apparent impedance is n times its value at standstill. If n be made unity, the apparent impedance at synchronism will be equal to that at standstill, while between these speeds it varies inappreciably. This means that from zero

speed to synchronism the primary current varies but slightly, and that the torque, which is proportional to the square of the primary current is practically constant throughout this range of speed. These facts show that a unity ratio compensated-repulsion motor is a constant torque machine at speeds from negative to positive synchronism, the relative phase position of the current and the e.m.f. changing so as always to cause them to give by their vector product the power represented by the torque at the various speeds. Above synchronism the torque decreases continually, tending to disappear at infinite speed.

Any desired torque-speed characteristic within limits can be obtained by giving to n a corresponding value, the torque at synchronism being equal to the starting torque divided by the square of the ratio of transformer to armature turns.

In connection with the discussion of the expression for determining the value of the torque it is well to mention the fact that the commonly accepted explanations as to the physical phenomena involved in the production of torque must be somewhat modified if actual conditions of operation known to exist are to be represented. Referring to Fig. 109, it will be noted that when the armature is stationary there exists no magnetism in line with the brushes $A A$, so that the current which enters the armature by way of the brushes $B B$ could not be said to produce torque by its product with magnetism in mechanical quadrature with it. Similarly, the flux in line with the brushes $B B$ could not be said to be attracted or repelled by magnetism which does not exist. That the current through $A A$ produces torque by its product with the magnetism due to current through $B B$ would be contrary to accepted methods of reasoning, since both currents flow in the same structure, yet, as concerns the torque, the effect is quite the same as though the flux in line with the brushes $B B$ were due to current in a coil located on the field core. (As shown in Fig. 106 for the ordinary repulsion motor.) These fundamental facts were discussed in the chapter on electromagnetic torque. See Fig. 98.

OBSERVED PERFORMANCE OF COMPENSATED REPULSION MOTOR.

The calculated impedance characteristics shown in Fig. 110 are based on arbitrarily assumed constants of a repulsion-series motor under ideal conditions. It is obviously impossible to ob-

tain such characteristics from an actual motor, since all losses and minor disturbing influences have been neglected in determining the various values. As a check upon the theory given above, the curves of Figs. 112 and 113 as obtained from tests of a compensated-repulsion motor, are presented herewith. It will be observed that the apparent resistance of the transformer coil varies directly with the speed and becomes negative at negative speed, while the apparent reactance of the armature decreases with increase of speed in either direction and, following approx-

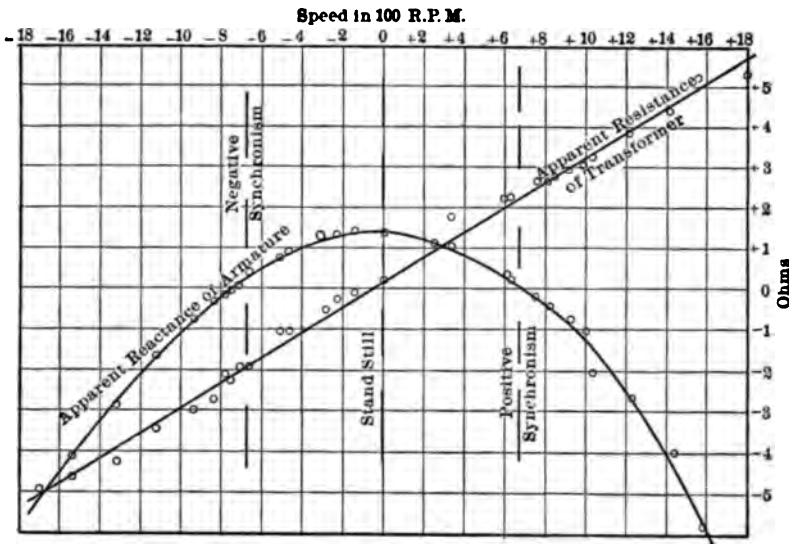

FIG. 112.—Test of Compensated Repulsion Motor—Active Factors of Operation.

imately a parabolic law, reverses and becomes negative at speeds slightly in excess of synchronism. A comparison of the general shape of the curves of Fig. 112 and Fig. 110 will show to what extent the assumed ideal conditions can be realized in practice, and it would indicate that, as concerns the active factors of operation, the equations given represent the facts involved. The neglect of the local resistance of the transformer circuit leads to the discrepancy between the theoretical and observed curves as found at zero speed, the latter curve indicating a certain apparent resistance when the armature is stationary. Similarly at syn-

chronous speed the observed apparent reactance of the armature is not of zero value due to the local leakage reactance of the circuit.

In the determination of the theoretical curves only active factors have been considered, and it has been shown that the apparent reactance of the motor circuits is confined to the armature, while the e.m.f. counter generated in the transformer coil gives the effect of apparent resistance located exclusively within this coil. The neglected disturbing factors, the apparent resistance of the armature and the apparent reactance of the transformer, are of relatively small and practically constant

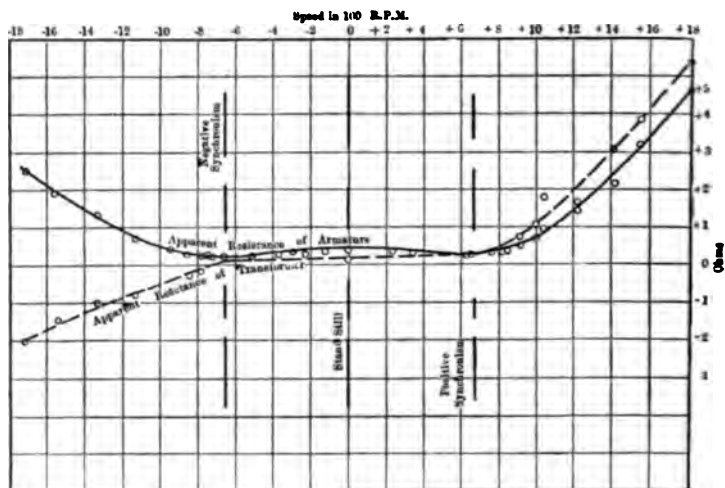

FIG. 113.—Test of Compensated Repulsion Motor—Disturbing Factors of Operation.

value throughout the operating range of speed from negative to positive synchronism, but they become of prime importance when the speed exceeds this value in either direction, as shown by the curves of Fig. 113 obtained from the test of a compensated repulsion motor giving the curves of Fig. 112. The predominating influence of the disturbing factors above synchronism is attributable largely to the effect of the short circuit by the brushes *A.A* (Fig. 109) of coils in which there is produced an active e.m.f. by combined transformer and speed action. This short circuiting effect will be treated in detail later.

CORRECTIONS FOR RESISTANCE AND LOCAL LEAKAGE REACTANCE.

The resistance and local leakage reactance of the coils may be included in the theoretical equations as follows:

- Let R_t = resistance of transformer coil
- R_a = resistance of armature circuit
- R_s = resistance of secondary circuit
- X_t = leakage reactance of transformer
- X_a = leakage reactance of armature
- X_s = leakage reactance of secondary circuit

then copper loss of motor circuits will be

$$I^2 (R_t + R_a) + I_s^2 R_s \tag{81}$$

$$I_s = I \sqrt{n^2 + S^2} \tag{82}$$

$$I^2 [R_t + R_a + (n^2 + S^2) R_s] = I^2 R_m \tag{83}$$

where R_m is the effective equivalent value of the motor circuit resistance, that is,

$$R_m = R_t + R_a + (n^2 + S^2) R_s \tag{84}$$

Similarly it may be shown that the effective equivalent value of the leakage reactance of the motor circuits is

$$X_m = X_t + X_a + (n^2 + S^2) X_s \tag{85}$$

combining equations (84) and (85) with (73) the expression for the apparent impedance of the motor circuits becomes

$$\bar{Z} = \sqrt{(\underline{R} + R_m)^2 + (\underline{X} + X_m)^2} = \tag{86}$$

$$I = \frac{E}{\sqrt{[S n X + R_t + R_a + (n^2 + S^2) R_s]^2 + [X (1 - S^2) + X_t + X_a + (n^2 + S^2) X_s]^2}} \tag{87}$$

$$\cos \theta = \frac{S n X + R_m}{\sqrt{[X (1 - S^2) + X_m]^2 + (S n X + R_m)^2}} \tag{88}$$

$$\text{Input} = E I \cos \theta \tag{89}$$

$$\text{Output} = E I \cos \theta - I^2 R_m = P \tag{90}$$

$$P = \frac{E^2 (S n X + R_m)}{(S n X + R_m)^2 + [X (1 - S^2) + X_m]^2} -$$

$$\frac{E^2 R_m}{(S n X + R_m)^2 + [X(1 - S^2) + X_m]^2} \quad (91)$$

$$P = \frac{E^2 S n X}{(S n X + R_m)^2 + [X(1 - S^2) + X_m]^2} = I^2 S n X \quad (92)$$

$$\text{torque} = D = \frac{P}{S} = I^2 n X \quad (93)$$

The above equations, though incomplete on account of neglecting the brush shortening effect and the magnetic losses in the cores, represent quite closely the electrical characteristics of the compensated repulsion motor when operated between negative and positive synchronism, throughout which range of speed the disturbing factors are of secondary importance.

BRUSH SHORT-CIRCUITING EFFECT.

The e.m.f. in the coils short circuited by the brushes can be treated by a method similar to that used with the repulsion motor. Referring to Fig. 109, the coil under the brush *A* is subjected to the transformer effect of the flux, ϕ_f , in line with the brushes, *B B*, and the dynamo speed effect of the flux, ϕ_t , in line with the brushes *A A*.

Effective values being used throughout, the transformer e.m.f. will be, assuming *C* actual conductors on the armature,

$$e_t = \frac{\frac{C}{2} \pi j \sqrt{2} \phi_f}{\sqrt{2} \frac{C}{4} 10^8} = \frac{\pi j \phi_f}{2 \cdot 10^8} \quad (94)$$

in volts for one coil. See equation (57). This e.m.f. is in time-quadrature with ϕ_f .

The dynamo speed e.m.f. in volts for one coil will be,

$$e_s = \frac{\frac{C}{2} \pi V \sqrt{2} \phi_t}{\sqrt{2} \frac{C}{4} 10^8} = \frac{\pi V \phi_t}{2 \cdot 10^8} \quad (95)$$

See equation (59). This e.m.f. is in time-phase with ϕ_t and hence is time-quadrature with ϕ_f . Thus the electromotive force in the coil under the brush *A* is

$$E_a = e_t - e_s = \frac{\pi}{2.10^8} (f \phi_f - V \phi_t) \quad (96)$$

$$\text{But } V = f S \text{ and } \phi_t = S \phi_f \quad (97)$$

See equation (63), hence

$$V \phi_t = S^2 f \phi_f, \quad (98)$$

so that

$$E_a = \frac{\pi f \phi_f}{2.10^8} (1 - S^2) \quad (99)$$

This resultant electromotive force has a value at standstill when S is zero, of

$$\frac{\frac{\pi}{2} E_f}{\frac{C}{4}} = \frac{I \pi X}{2 C} \quad (100)$$

See equation (66). Thus

$$\text{finally, } E_a = \frac{I \pi X}{2 C} (1 - S^2) \quad (101)$$

When the armature is stationary the electromotive force in the coil short circuited by the brush A has the value given by equation (100), which, with any practical motor, is of sufficient value to cause considerable heating if the armature remains at rest, or to produce a fair amount of sparking as the armature starts in motion. At synchronous speed, however, this electromotive force disappears entirely, and the performance of the machine as to commutation is perfect. As the speed exceeds this critical value in either the positive or negative direction, the electromotive force in the short-circuited coil increases rapidly, resulting in a return in an augmented form of the sparking found at lower speeds and producing the disturbing factors shown by the curves of Fig. 113.

Since the e.m.f. in the coil under the brush A reduces to zero at both positive and negative synchronism and reverses with reference to the time-phase position of the line current at speeds exceeding synchronism in either direction, it possesses at high speeds the same time-phase position when the machine is operated as a generator as when it is used as a motor. The time-phase of its reactive effect upon the current which flows in the

armature through the brushes BB is of the same sign at high positive and negative speeds, but reversed from the phase position of the effect at speeds below synchronism. A study of the test curves of Fig. 113 will show the magnitude of these effects, and the reversal of their time-phase positions in accordance with the theoretical considerations.

With reversal of direction of rotation the time-phase position of the flux threading the transformer coil (Fig. 109) reverses with reference to the line current, and hence in its reactive effect upon the transformer flux the current in the coil short circuited by the brush A becomes negative at speeds above negative synchronism, though positive above synchronism in the positive direction. At speeds below synchronism, when the flux is large the e.m.f. is small, and *vice versa*, so that the reactive effect is in any case relatively small and of more or less constant value. See Fig. 113.

It will be noted that in analyzing the disturbing factors no account has been taken of the short-circuiting effect at the brushes BB , Fig. 109. This treatment is in accord with the statement previously made that the component e.m.fs. generated in the coils under these brushes are at all times of values such as to render the resultant zero. The proof of this fact is as follows:

The transformer e.m.f. in the coil under B due to flux, ϕ_t , in lines with brushes AA is

$$e_f = \frac{\pi f \phi_t}{2.10^8} \quad (102)$$

See equation (94). This e.m.f. is in time-quadrature with ϕ_t .

The dynamo speed e.m.f. is

$$e_v = \frac{\pi V \phi_f}{2.10^8} \quad (103)$$

This e.m.f. is in time-phase with ϕ_f , in time quadrature with ϕ_t , and is in phase opposition to e_f . Thus the resultant e.m.f. is

$$E_b = e_f - e_v = \frac{\pi}{2.10^8} (f \phi_t - V \phi_f) \quad (104)$$

Since $V = f S$ and $\phi_t = S \phi_f$ from equations (97) and (63),

$$f \phi_t = V \phi_f \quad (105)$$

and

$$E_b = 0 \quad (106)$$

This theoretical deduction is substantially corroborated by experimental evidence, as has been noted above. Even upon superficial examination such a result is to be expected, since the vector sum of all e.m.fs. in the armature in mechanical line with the short-circuited brushes $A A$ must be zero, while the e.m.f. in the coil at brush B must equal its proper share of this e.m.f. or

$$E_b = \frac{0 \cdot \pi}{C \cdot 2} = 0 \quad (107)$$

A similar course of reasoning allows of the determination of the electromotive force under the brush A . See equation (71).

$$E_a = \frac{E_a \pi}{C \cdot 2} = \frac{\pi X (1 - S^2)}{2 \cdot C} \quad (108)$$

for unit current. For I amperes this becomes

$$E_a = \frac{I \pi X}{2 \cdot C} (1 - S^2) \quad (109)$$

See equation (101).

From the facts just indicated it would seem that perfect commutation dictates that the electromotive force across a diameter ninety electrical degrees from the brushes upon the armature be at all times of zero value.

It has been stated that the magnetic circuits of the compensated repulsion-series motor are quite the same as those of the repulsion motor. The fluxes in line with the two brush circuits under all conditions are in time-quadrature and have relative values varying with the speed such that at all times

$$\phi_t = S \phi_f \quad (110)$$

There exists, therefore, at all speeds a revolving magnetic field elliptical in form as to space representation. At standstill the ellipse becomes a straight line in the direction of the brushes $B B$ (Fig. 109), at infinite speed in either direction the ellipse would again be a straight line in the direction of the brushes $A A$, while at either positive or negative synchronism the ellipse is a true circle, the instantaneous maximum value of the revolving magnetism traveling in the direction of motion of the armature. At synchronous speed, therefore, the magnetic losses in the armature core disappear, while the losses in the stator core are evenly distributed around its circumference.

CHAPTER XV.

MOTORS OF THE SERIES TYPE TREATED BOTH GRAPHICALLY AND ALGEBRAICALLY.

THE PLAIN SERIES MOTOR.

The combined transformer and motor features of commutator type of alternating current machinery are well exemplified in the plain series motor as illustrated in Fig. 114. When the rotor is stationary, the field and armature circuits of the motor form two impedances in series. Assuming initially an ideal motor without resistance and local leakage reactance, each impedance consists of pure reactance, the current in the circuit having a value such that its magnetomotive force when flowing through the armature and field turns causes to flow through the reluctance of the magnetic path that value of flux the rate of change of which generates in the windings an electromotive force equal to the impressed.

If E be the impressed e.m.f., E_f the counter transformer e.m.f. across the field coil and E_a the counter transformer e.m.f. across the armature coil, when the armature is stationary

$$E = E_f + E_a \quad (111)$$

From fundamental transformer relations there is obtained the equation

$$E_f = \frac{2 \pi f N_f \phi_f}{\sqrt{2} 10^8}, \text{ see eq. (55)} \quad (112)$$

where f = frequency in cycles per second

N_f = effective number of field turns

ϕ_f = maximum value of field flux.

Similarly

$$E_a = \frac{2 \pi f N_a \phi_a}{\sqrt{2} 10^8} \quad (113)$$

where N_a = effective number of armature turns

ϕ_a = maximum value of armature flux.

FUNDAMENTAL EQUATIONS OF SERIES MOTOR WITH UNIFORM AIR-GAP RELUCTANCE.

Since the field and armature circuits are electrically series con-

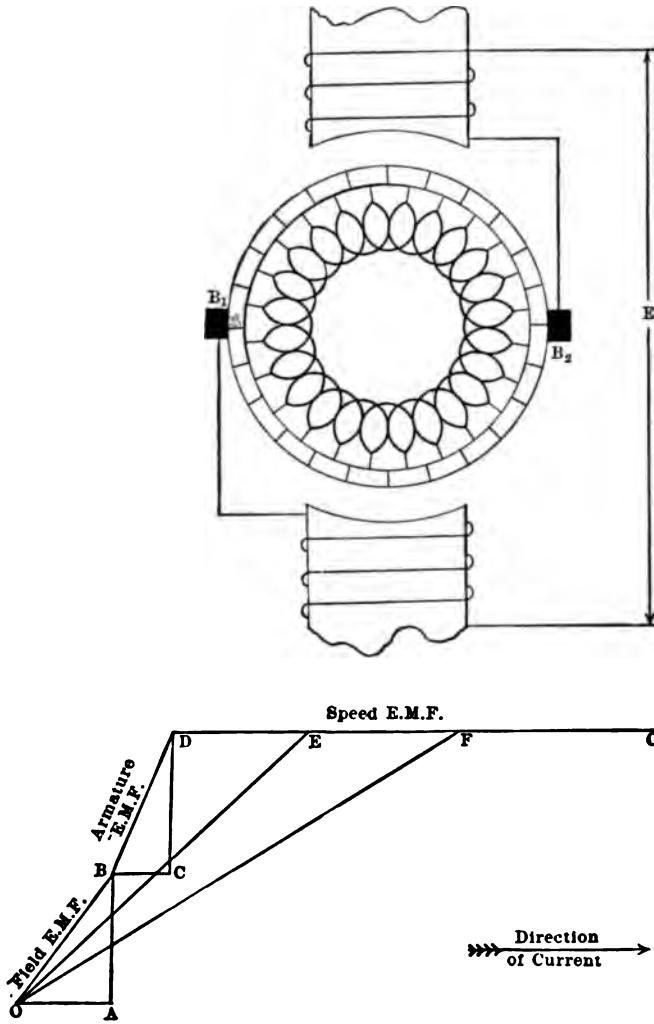

FIG. 114.—Circuit and Vector Diagrams of Plain Series Motor.

nected and are mechanically so placed as not to be inductively related, with uniform reluctance around the air gap the fluxes in mechanical line with the two circuits being due to the magneto-

motive force of the same current will be proportional to the effective number of turns on the two circuits.

Therefore

$$\frac{\phi_f}{N_f} = \frac{\phi_a}{N_a} \quad (114)$$

If n be the ratio of effective field to armature turns

$$N_f = n N_a \quad (115)$$

and

$$\phi_f = n \phi_a$$

Let C be the actual number of conductors on the armature, then

$$N_a = \frac{C}{2\pi} \quad (\text{see eq. 56}) \quad (117)$$

Under speed conditions the armature conductors cut the field magnetism and there is generated by dynamo action a counter e.m.f. proportional to the product of the field flux and the speed in time-phase with the flux, in leading time quadrature with the field e.m.f., E_f and the armature e.m.f. E_a and in phase opposition with the current.

Thus

$$E_r = \frac{C \phi_f V}{\sqrt{2} \cdot 10^8} \quad (\text{see eq. 59}) \quad (118)$$

where V is revolutions per second of bipolar model.

Combining (117) and (118)

$$E_r = \frac{2\pi V N_a \phi_f}{\sqrt{2} \cdot 10^8} \quad (119)$$

If S be the speed with synchronism as unity, then

$$V = S f \quad (120)$$

and

$$E_r = \frac{2\pi S f N_a \phi_f}{\sqrt{2} \cdot 10^8} \quad (121)$$

combining (113), (116) and (121)

$$E_r = \frac{E_a S \phi_f}{\phi_a} = E_a S n \quad (122)$$

combining (112), (115) and (121)

$$E_r = \frac{E_f S N_a}{N_f} = \frac{E_f S}{n} \quad (123)$$

comparing (122) and (123)

$$E_f = n^2 E_a$$

Under speed conditions the impressed e.m.f. is balanced by three components, E_v in time phase opposition with the line current and E_f and E_a , both in leading time quadrature with the line current.

Thus

$$E = \sqrt{E_v^2 + (E_a + E_f)^2} \quad (125)$$

$$E = \sqrt{E_a^2 S^2 n^2 + (E_a + n^2 E_a)^2} = E_a \sqrt{S^2 n^2 + (1 + n^2)^2} \quad (126)$$

This is the fundamental electromotive force equation of the plain series motor having uniform reluctance around the air-gap.

On the basis of unit line current the electromotive forces may be treated as impedances, as was done with the repulsion-series motor, so that the impedance equation becomes

$$Z = X_a \sqrt{S^2 n^2 + (1 + n^2)^2} \quad (127)$$

where $S n X_a = R$ and $(1 + n^2) X_a = X$

The power factor is

$$\frac{R}{Z} = \cos \theta = \frac{S n}{\sqrt{S^2 n^2 + (1 + n^2)^2}} \quad (128)$$

which reverses when S becomes negative and continually approaches unity with increase of S in either direction.

When $S = 1$, or at synchronism

$$\cos \theta = \frac{n}{\sqrt{n^2 + (1 + n^2)^2}} \quad (129)$$

which when $n = 1$ or for unity ratio of field to armature turns becomes

$$\cos \theta = \frac{1}{\sqrt{1 + (1 + 1^2)}} = .447, \quad (130)$$

and decreases with either an increase or decrease of n . It is

apparent therefore that the power factor of such a machine is inherently very low and cannot be improved by a mere change in the ratio of field to armature turns.

The line current is

$$I = \frac{E}{Z} = \frac{E}{X_a} \cdot \frac{1}{\sqrt{S^2 n^2 + (1+n^2)^2}} \quad (131)$$

The power is

$$P = E I \cos \theta = \frac{E^2}{X_a} \cdot \frac{S n}{S^2 n^2 + (1+n^2)^2} \quad (132)$$

which becomes negative when S reverses, or the machine operates as a generator when driven against its natural tendency to rotation.

The torque is

$$D = \frac{P}{S} = \frac{E^2}{X_a} \cdot \frac{n}{S^2 n^2 + (1+n^2)^2} = I^2 n X_a. \quad (133)$$

which is maximum at maximum current and retains its sign when S is reversed.

At starting the torque is

$$D_0 = \frac{E^2}{X_a} \cdot \frac{n}{(1+n^2)^2} \quad (134)$$

At synchronous speed, the torque is

$$D_s = \frac{E^2}{X_a} \cdot \frac{n}{n^2 + (1+n^2)^2} \quad (135)$$

and

$$\frac{D_s}{D_0} = \frac{(1+n^2)^2}{n^2 + (1+n^2)^2} \quad (136)$$

which when n is negligibly small approaches a value of unity and when n is infinitely large also tends to reach a value of unity. When $n = 1$ equation (136) reduces to

$$\frac{D_s}{D_0} = \frac{(2)^2}{1+(2)^2} = .8 \quad (137)$$

the interpretation of which is that the torque of the unity-ratio single-phase, plain series motor with uniform reluctance around

the air-gap varies only 20 per cent. from standstill to synchronism, and therefore, that such a machine is unsuited for traction. This statement applies to the ideal single-phase motor without internal losses, and must be somewhat modified to include true operating conditions. The method of treating the various losses has previously been discussed and will further be enlarged upon in connection with the compensated types of series machines. A little consideration will show that such modifications as must be introduced have a detrimental effect upon the characteristics of the machine, and tend to lay greater stress upon the statement just made. These facts are graphically represented in the performance (impedance) diagram of Fig. 114. OA is the power and AB the reactive components of the apparent field impedance at starting while BC and CD are the corresponding power and reactive components of the apparent armature impedance. The power component of apparent armature impedance due to dynamo speed action is shown as DE or DF , giving the resultant impedance under speed conditions of OE or OF and indicating an angle of lag of the circuit current behind the impressed e.m.f. of EOA or FOA . The variation in torque due to increase of speed from synchronism to double synchronism with a unity ratio constant reluctance machine, as represented in Fig. 114, would be as the square of the ratio of OF to OE .

FUNDAMENTAL EQUATIONS FOR MOTOR WITH NON-UNIFORM RELUCTANCE.

An inspection of equation (136) will reveal the fact that a change in the value of n does not improve the torque characteristics of the machine unless such change be accompanied with an increase in reluctance of the magnetic structure in line with the brushes $B_1 B_2$ (Fig. 114). That is to say, if the mechanical construction is such that equation (114) may be written

$$\frac{\phi_f}{N_f} = m \frac{\phi_a}{N_a} \tag{138}$$

where m is a constant of a value many times unity, the operating characteristics of the machine become much improved.

Thus equation (116) becomes

$$\phi_f = m n \phi_a \tag{139}$$

and equation (122) is changed to

$$E_v = \frac{E_a S \phi_f}{\phi_a} = E_a S m n = \frac{E_f S}{n} \quad (140)$$

$$E_a = \frac{E_f}{m n} \quad (141)$$

$$E = \sqrt{E_v^2 + (E_a + E_f)^2} = \sqrt{\left(\frac{E_f S}{n}\right)^2 + \left(\frac{E_f}{m n^2} + E_f\right)^2} \quad (142)$$

$$E = E_f \sqrt{\left(\frac{S}{n}\right)^2 + \left(1 + \frac{1}{m n^2}\right)^2} \quad (143)$$

$$\underline{R} = \frac{S}{n} X_f, \quad \underline{X} = X_f \left(1 + \frac{1}{m n^2}\right) \quad (144)$$

$$\cos \theta = \frac{R}{Z} = \frac{\frac{S}{n}}{\sqrt{\left(\frac{S}{n}\right)^2 + \left(1 + \frac{1}{m n^2}\right)^2}} = \frac{S}{\sqrt{S^2 + \left(\frac{m n^2 + 1}{m n}\right)^2}} \quad (145)$$

when $S = 1$ or at synchronism

$$\cos \theta = \frac{\frac{1}{n}}{\sqrt{\left(\frac{1}{n}\right)^2 + \left(\frac{m n^2 + 1}{m n}\right)^2}} = \frac{1}{\sqrt{1 + \left(\frac{m n^2 + 1}{m n^2}\right)^2}} \quad (146)$$

With an excessively large reluctance of the magnetic structure in line with the brushes $B_1 B_2$ (Fig. 114), that is, with an enormous value of m , the power factor at synchronous speed approaches

$$\cos \theta = \frac{1}{\sqrt{1 + n^2}} \quad (147)$$

the interpretation of which equation is that the operating power factor of such a machine is largely dependent upon the ratio of field to armature turns. A little study will show that at any chosen speed, whether synchronous or not, the cotangent of the angle of lag is directly proportional to the ratio of armature to field turns, and that the power-factor, the corresponding cosine,

can be given any desired value by a proper proportioning of the windings. This feature will be treated more in detail when dealing with compensated motors.

The current of the high brush-line-reluctance machine is

$$I = \frac{E}{Z} = \frac{E n}{X_f} \cdot \frac{1}{\sqrt{S^2 + \left(\frac{m n^2 + 1}{m n}\right)^2}} \quad (148)$$

The power is

$$P = E I \cos \theta = \frac{E^2 n S}{X_f} \cdot \frac{1}{S^2 + \left(\frac{m n^2 + 1}{m n}\right)^2} \quad (149)$$

The torque is

$$D = \frac{P}{S} = \frac{E^2 n}{X_f} \cdot \frac{1}{S^2 + \left(\frac{m n^2 + 1}{m n}\right)^2} = \frac{P^2 X_f}{n} \quad (150)$$

At starting the torque is

$$D_0 = \frac{E^2 n}{X_f \left(\frac{m n^2 + 1}{m n}\right)^2} \quad (150)$$

At synchronous speed the torque is

$$D_s = \frac{E^2 n}{X_f \left[1 + \left(\frac{m n^2 + 1}{m n}\right)^2\right]} \quad (151)$$

$$\frac{D_s}{D_0} = \frac{\left(\frac{m n^2 + 1}{m n}\right)^2}{1 + \left(\frac{m n^2 + 1}{m n}\right)^2} \quad (152)$$

which ratio, with an enormous value of m , approaches

$$\frac{D_s}{D_0} = \frac{n^2}{1 + n^2} \quad (153)$$

the significance of which is that the change of torque from stand-still to synchronism can be altered at will by change in the ratio of field to armature turn and that a relatively low value of n would produce a machine suitable for traction.

By using projecting field poles thus leaving large air-gaps in the axial brush line and thereby increasing the reluctance of the structure in line with the magnetomotive force of the armature current, the flux produced by the armature current may be materially reduced, thus giving to m a relatively large value, and

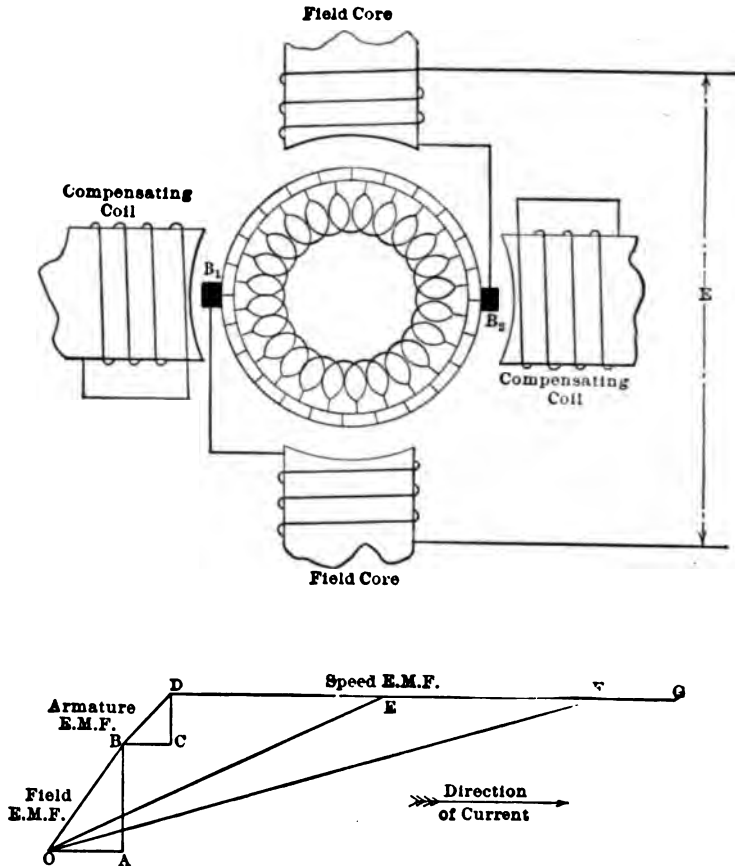

FIG. 115.—Circuit and Vector Diagrams of Inductively-Compensated Series Motor.

the power factor will be thereby correspondingly increased with a resultant improvement in the torque characteristics of the machine. Even under the most favorable conditions, however, it is impossible to reduce the reactance of the armature circuit to an inappreciable value, that is, to give to m an enormous

value, due to the inevitable presence of the magnetic material of the projecting poles.

INDUCTIVELY COMPENSATED SERIES MOTOR.

The most satisfactory method of reducing the inductive effect of the armature current is to surround the revolving armature

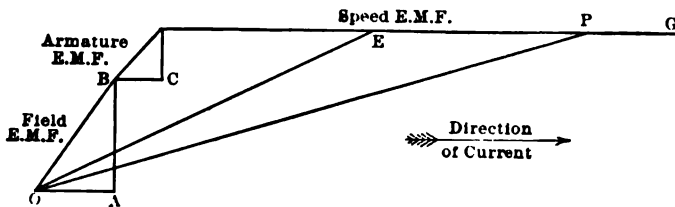
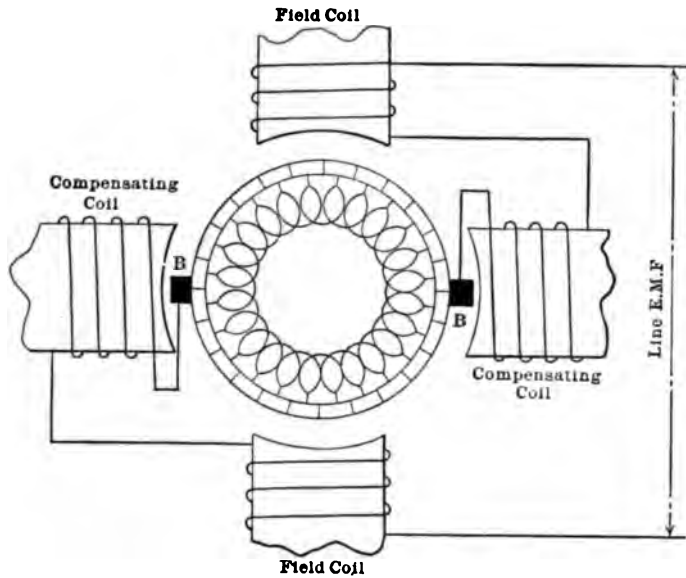

FIG. 116.—Circuit and Vector Diagrams of Conductively Compensated Series Motor.

winding with properly disposed stationary conductors through which current flows equal in magnetomotive force and opposite in phase to the current in the armature. This compensating current may be produced inductively by using the stationary

winding as the short circuited secondary of a transformer of which the armature is the primary, as illustrated diagrammatically in Fig. 115, or the main line current may be sent directly through the compensating coil as shown in Fig. 116. In the former case the transformer action is such that the compensation is practically complete, giving minimum combined reactance of the two circuits while in the latter case, the proportion of compensation can be varied at will. It is found that in any case the best general effects are produced when the compensation is complete, and experiments seem to indicate that under such conditions the two methods of compensation differ inappreciably for strictly alternating current work, but that for direct current operation where the forced compensation can be used to prevent field distortion and to improve the commutation, the latter method is preferable.

CONDUCTIVELY COMPENSATED SERIES MOTOR.

Referring to Figs. 115 and 116, assume an ideal series motor with complete compensation, letting n be the ratio of effective field to armature turns; at any speed S with synchronism as unity, the apparent impedance of the motor circuits will be

$$Z = X_f \sqrt{\frac{S^2}{n^2} + 1} \quad (154)$$

of which

$$X = X_f \quad (155)$$

represents the reactance of the motor circuits which is confined to the field coil, and of which

$$R = \frac{S X_f}{n} \quad (156)$$

represents the apparent resistance effect of the dynamo speed e.m.f. counter generated at the brushes B_1, B_2 , due to the cutting of the field flux by the armature conductors (see eq. 123).

The power factor is

$$\cos \theta = \frac{R}{Z} = \frac{\frac{S}{n}}{\sqrt{\frac{S^2}{n^2} + 1}} \quad (157)$$

which continually approaches positive or negative unity with increase of speed in the corresponding direction.

At synchronism when $S = 1$, the power factor is

$$\cos \theta = \frac{1}{\sqrt{1+n^2}} \quad (\text{see eq. 147}) \quad (158)$$

The line current is

$$I = \frac{E}{Z} = \frac{E}{X_f} \cdot \frac{1}{\sqrt{\frac{S^2}{n^2} + 1}} \quad (159)$$

The power is

$$P = E I \cos \theta = \frac{E^2}{X_f} \cdot \frac{S}{\frac{S^2}{n^2} + 1} \quad (160)$$

The torque is

$$D = \frac{P}{S} = \frac{E^2}{n X_f} \cdot \frac{1}{\left(\frac{S^2}{n^2} + 1\right)} = \frac{P_s X_f}{n} \quad (\text{see eq. 150}) \quad (161)$$

The ratio of the torque at synchronous speed to that at standstill is

$$\frac{D_s}{D_0} = \frac{1}{\frac{1}{n^2} + 1} = \frac{n^2}{1+n^2} \quad (\text{see eq. 153}) \quad (162)$$

which in a practical machine can be made as much smaller than unity as desired by a proper proportioning of the field and armature windings. It is evident, therefore, that such a machine can be made suitable for traction when a proper value of n is chosen.

COMPLETE PERFORMANCE EQUATIONS OF COMPENSATED MOTORS.

The above equations refer to ideal motors without resistance and local leakage reactance and devoid of all minor disturbing influences. A close approximation for the effect of the resistance and leakage reactance may be obtained as follows:

- Let r_f = resistance of field coil
- r_c = resistance of compensating coil (reduced to a 1 to 1, armature ratio)
- r_a = resistance of armature
- x_f = local reactance of field coil
- x_a = combined leakage reactance effect of armature and compensating coils

Then the apparent impedance is

$$Z = \sqrt{\left(\frac{S X_f}{n} + r_f + r_c + r_a\right)^2 + (X_j + x_f + x_a)^2} \quad (163)$$

Power factor is

$$\cos \theta = \frac{R}{Z} = \frac{\frac{S X_f}{n} + r_f + r_c + r_a}{\sqrt{\left(\frac{S X_f}{n} + r_f + r_c + r_a\right)^2 + (X_j + x_f + x_a)^2}} \quad (164)$$

Power input is

$$P = E I \cos \theta = \frac{E^2 \left(\frac{S X_f}{n} + r_f + r_c + r_a\right)}{\left(\frac{S X_f}{n} + r_f + r_c + r_a\right)^2 + (X_j + x_f + x_a)^2} \quad (165)$$

The copper loss and equivalent effective resistance loss will be

$$I^2 R = \frac{E^2 (r_f + r_c + r_a)}{\left(\frac{S X_f}{n} + r_f + r_c + r_a\right)^2 + (X_j + x_f + x_a)^2} \quad (166)$$

Electrical output is

$$P - I^2 R = \frac{\frac{E^2 S X_f}{n}}{\left(\frac{S X_f}{n} + r_f + r_c + r_a\right)^2 + (X_j + x_f + x_a)^2} \quad (167)$$

The torque is

$$D = \frac{P - I^2 R}{S} = \frac{I^2 X_f}{n} \quad (\text{see eq. 161}) \quad (168)$$

VECTOR DIAGRAM OF COMPENSATED SERIES MOTORS.

The equations here given are represented graphically in the diagrams of Figs. 115 and 116, which show the impedance (e.m.f. for unit current) characteristics of the machines.

$$O A = r_f$$

$$B C = r_a + r_c$$

$$A B = X_j + x_f$$

$$D C = X_a$$

$$D E = \frac{S X_f}{n} \text{ at speed } S$$

$$O E = Z \text{ at speed } S$$

$$\cos \angle E O A = \cos \theta = \text{power factor at speed } S$$

These characteristics together with the brush short circuiting effect and other minor modifying influences will be discussed later. It is sufficient here to state that the effect of the short circuit by the brush of a coil in which an active e.m.f. is generated, both by transformer and speed action, tending to increase the apparent impedance effects at high speeds is to some extent balanced by the fact that the flux which causes the generation of a counter e.m.f. by dynamo speed action is out of phase and lagging with respect to the line current and that the counter e.m.f. therefore, tends to lag behind the current or to cause the current to become leading with respect to the counter e.m.f., so that the neglected disturbing influences tend to render the final effect quite small, the result being that the incomplete equations and corresponding graphical diagrams as given above, represent quite closely the observed performance characteristics of the compensated series motors.

INDUCTION SERIES MOTOR.

Excellent performance of the compensated alternating-current motor may be obtained by using the field coil as the load circuit from the compensating coil employed as the secondary of a transformer, the armature being used as the primary, as diagrammatically represented in Fig. 117. The current which enters the armature winding through the brushes $B_1 B_2$ causes the formation on the armature core of magnetic poles having the mechanical direction of the axial line joining the brushes, and the rate of change of the magnetism generates an electromotive force in the compensating coil. Due to this electromotive force, current flows through the locally-closed circuits around the compensating and field coils, and produces magnetic poles in the stationary field-cores.

Consider now the load-circuit surrounding the quadrature field-cores. Since to this winding there is no opposing secondary circuit, the magnetism in the core will be practically in time-phase with the current producing it. This current is the secondary load-current of the transformer. As is true in any transformer, there will flow in the primary coil a current in phase opposition to the secondary current in addition to and superposed upon the primary no-load exciting-current. It is thus seen that the load-current in the primary (or armature) coil will

be in time-phase opposition with the magnetism in the quadrature core. And, since this current and the magnetism reverse signs together, the torque, due to their product and relative mechanical position, will remain always of the same sign—though fluctuating in value. Hence the machine operates similarly to a direct-current series motor.

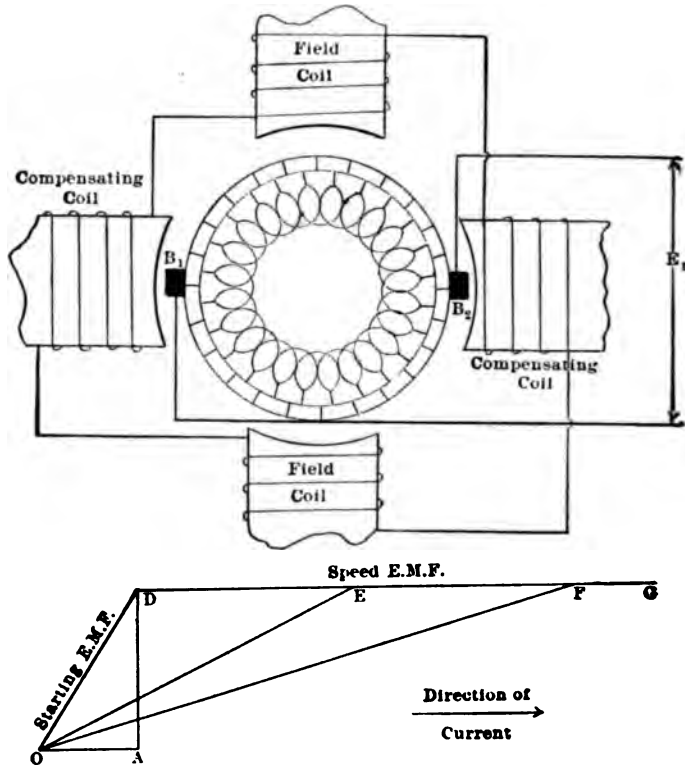

FIG. 117.—Circuit and Vector Diagrams of Induction Series Motor.

When the armature revolves at a certain speed, the motion of its conductors through the quadrature magnetic field, generates in the armature winding an electromotive force which appears at the brushes $B_1 B_2$ as a counter e.m.f. This weakens the effective electromotive force and therewith the armature-current, the armature-core magnetism, the field-current and the field-core magnetism. Thus there results from increased speed of the arma-

ture a reduced torque, just as occurs in direct-current series motors. By increasing the applied electromotive force, an increase of torque can be obtained even at excessively high speeds, and the motor tends to increase indefinitely the speed of its armature as the applied electromotive force is increased, or as the counter torque is decreased. There is no tendency to attain a definite limiting speed as is found to be true with revolving field induction-motors and repulsion motors.

FUNDAMENTAL EQUATIONS OF INDUCTION SERIES MOTOR.

Let E_a be the counter transformer e.m.f. across the armature coil, the armature being stationary.

Then

$$E_a = \frac{2 \pi f N_a \phi_a}{\sqrt{2} 10^8} \text{ see eq. (55)} \quad (169)$$

where f = frequency in cycles per second

N_a = effective number of armature turns

ϕ_a = maximum value of armature flux cutting the compensating coil

$$N_a = \frac{C}{2 \pi} \text{ see eq. (56)} \quad (170)$$

where C is the actual number of conductors on the armature, a bipolar model being assumed.

$$E_a = \frac{f C \phi_a}{\sqrt{2} 10^8} \quad (171)$$

Let N_c = effective number of turns on the compensating coil, then

$$E_c = \frac{2 \pi f N_c \phi_a}{\sqrt{2} 10^8} = \frac{E_a N_c}{N_a} \quad (172)$$

where E_c = transformer e.m.f. of the compensating coil.

Let N_f = effective number of turns on the field coil

then

$$E = \frac{2 \pi f N_f \phi_f}{\sqrt{2} 10^8} \quad (173)$$

where E = impressed e.m.f. of the field coil

ϕ = maximum value of field flux

$$E = E_s, \text{ hence } N_s \phi_s = N_f \phi \quad (174)$$

and

$$\frac{\phi}{\phi_s} = \frac{N_s}{N_f} \quad (175)$$

Let E_r be the e.m.f. counter generated at the brushes B_1, B_2 , Fig. 117 by speed action due to the cutting of the flux ϕ by the armature conductors C at speed V revolutions per second, then

$$E_r = \frac{C \phi V}{\sqrt{2} 10^8} \quad \text{see eq. (59)} \quad (176)$$

$$V = S f \quad (177)$$

where S is the speed with synchronism as unity.

Combining (171), (176), and (177),

$$E_r = \frac{S E_s \phi}{\phi_s} = \frac{S E_s N_f}{N_f} \quad (178)$$

Let n be the ratio of effective field to compensating coil turns.

$$E_r = \frac{S E_a}{n} \quad \text{see eq. (123)} \quad (179)$$

This electromotive force is in time-phase with the field flux ϕ , is in phase opposition with the line current and hence is in time quadrature (leading) with respect to the e.m.f. E_a . The impressed electromotive force E is balanced by the two components, E_r and E_a so that

$$E = \sqrt{E_r^2 + E_a^2} \quad (180)$$

$$E = E_a \sqrt{\frac{S^2}{n^2} + 1} \quad (181)$$

On the basis of unit line current, the electromotive forces may be treated as impedances, as was done with the repulsion-series and compensated-series motors.

$$Z = X_f \sqrt{\frac{S^2}{n^2} + 1} \quad (182)$$

where

$$\frac{X_t S}{n} = R \text{ and } X_t = X$$

X_t being the combined reactance effect of the field, compensating coil and armature circuits.

The power factor is,

$$\cos \theta = \frac{R}{Z} = \frac{\frac{S}{n}}{\sqrt{\frac{S^2}{n^2} + 1}} = \frac{S}{\sqrt{S^2 + n^2}} \quad (183)$$

which when $S = 1$ or at synchronism, reduces to

$$\cos \theta = \frac{1}{\sqrt{1 + n^2}} \quad (184)$$

the interpretation of which is that the power factor at synchronism can be caused to approach unity quite closely by the use of a small value of n , that is, by employing a small ratio of field to compensating coil turns. With increase of speed the power factor continually increases for any value of n .

The line current is

$$I = \frac{E}{Z} = \frac{E}{X_t} \frac{1}{\sqrt{\frac{S^2}{n^2} + 1}} = \frac{E n}{X_t \sqrt{S^2 + n^2}} \quad (185)$$

The power is

$$P = E I \cos \theta = \frac{E^2}{X_t} \cdot \frac{\frac{S}{n}}{\frac{S^2}{n^2} + 1} = \frac{E^2 S n}{X_t (S^2 + n^2)} \quad (186)$$

which becomes negative when S reverses, or the machine operates as a generator when driven against its natural tendency to rotation.

The torque is

$$D = \frac{P}{S} = \frac{E^2 n}{X_t (S^2 + n^2)} = \frac{I^2 X_t}{n} \quad (187)$$

which is maximum at maximum current and retains its sign when S is reversed.

At starting, the torque is

$$D_0 = \frac{E}{X_t} \cdot \frac{n}{n^2} \quad (188)$$

at synchronous speed; the torque is

$$D_s = \frac{E}{X_t} \cdot \frac{n}{(1+n^2)} \quad (189)$$

and

$$\frac{D_s}{D_0} = \frac{n^2}{1+n^2} \quad (190)$$

which when $n = 1$ reduces to

$$\frac{D_s}{D_0} = \frac{1}{1+1} = .5 \quad (191)$$

and can be given any desired value by a proper selection of n , see eq. (153). A relatively low value of n would produce a machine having the torque characteristics of the direct current series motor and hence one suitable for traction. See eq. (162).

It remains to investigate the relation of the currents in the compensating coil and in the armature circuit (the secondary and primary of the assumed transformer).

Let i_a be the current which would flow in the armature when the field coil circuit is open. Then i_a is the exciting current of the assumed transformer and it has a value such that its product with the effective number of armature turns, forces the flux, ϕ_a , demanded by the impressed e.m.f., through the reluctance of their paths in the magnetic structure, in line with the brushes $B_1 B_2$ (Fig. 117). When the field circuit is closed there flows through the field and compensating coil a current i_f , of a value such that its magnetomotive force when flowing through the field turns N_f , produces the flux ϕ_f demanded by the e.m.f. E_f or E_c . The current i_f is in time-phase with the flux ϕ_f and hence is in time quadrature with the e.m.f. E_c . The current i_a is in phase with the flux ϕ_a and in time quadrature with E_a or E_c . When the field circuit is closed a current equal in magnetomotive force and opposite in phase to i_f is superposed upon i_a in the primary (armature) circuit. These two currents are directly in phase so that the resultant current becomes

$$I = i_a + p i_f \quad (192)$$

where p is a proportionality constant the value of which will be discussed later.

Since both i_a and i_f reach their maximum values simultaneously with ϕ_f , one is led to the highly interesting conclusion that even the exciting current i_a is effective in producing torque by its direct product with the field magnetism, and that under speed conditions both i_a and $p i_f$ are equally effective (per ampere) in producing power.

The relative values of i_a and i_f and of p may be approximated as follows:

Assuming similar conditions for the three coils, the field, the compensating and the armature circuits,—equal reluctance—

$$\frac{i_a N_a}{\phi_a} = \frac{i_f N_f}{\phi_f} \quad (193)$$

$$N_f = n N_c \quad (194)$$

$$N_c \phi_a = N_f \phi_f \quad \text{see eq. (174)} \quad (195)$$

$$\phi_f = \frac{N_c \phi_a}{N_f} \quad (196)$$

$$i_f = \frac{N_a \phi_f}{N_f \phi_a} i_a = \frac{N_a N_c}{N_f^2} i_a = \frac{N_a i_a}{N_c n^2} \quad (197)$$

From transformer relations there is obtained the equation

$$\frac{N_c}{N_a} = p \quad \text{see eq. (192)} \quad (198)$$

Combining (197) and (198)

$$i_f = \frac{i_a}{p n^2} \quad (199)$$

Combining (199) and (192)

$$I = i_a \left(1 + \frac{1}{n^2} \right) \quad (200)$$

Comparing (199) and (200),

$$i_f = \frac{I \cdot \frac{1}{p n^2}}{1 + \frac{1}{n^2}} = \frac{I}{p n^2 + p} \quad (201)$$

CORRECTIONS FOR RESISTANCE AND LOCAL LEAKAGE REACTANCE.

The relations above expressed depend upon certain assumptions as to the reluctance in line with the armature circuit and the field coil, and will be modified if the assumptions made are not applicable to the motor as constructed. As a method of reviewing the problem, in a general way, however, the assumption made and the conclusions drawn therefrom are sufficiently exact. In the determination of the equations used above, an ideal motor has been considered, the resistance and local leakage reactance effects being neglected. Actual operating conditions may be more closely represented as follows:

Let

r_f = resistance of field coil.

r_c = resistance of compensating coil.

r_a = resistance of armature.

x_f = local leakage reactance of field coil.

x_c = local leakage reactance of compensating coil.

x_a = local leakage reactance of armature circuit.

Then the copper loss of the motor circuits will be

$$I^2 R_m = I^2 r_a + I^2 (r_f + r_c) = I^2 \left[r_a + \frac{r_f + r_c}{(pn^2 + p)^2} \right] \quad (202)$$

where R_m is the effective equivalent value of the motor-circuit resistance, that is,

$$R_m = r_a + \frac{r_f + r_c}{(pn^2 + p)^2} \quad (203)$$

Similarly it may be shown that the equivalent effective value of the local leakage reactance of the motor-circuit is

$$X_m = x_a + \frac{x_f + x_c}{(pn^2 + p)^2} \quad (204)$$

Combining equations (182), (203) and (204), the apparent impedance of the motor-circuits becomes

$$Z = \sqrt{\left[\frac{S \dot{X}_t}{n} + r_a + \frac{r_f + r_c}{(pn^2 + p)^2} \right]^2 + \left[X_t + x_a + \frac{x_f + x_c}{(pn^2 + p)^2} \right]^2} \quad (205)$$

The power factor is

$$\cos \theta = \frac{R}{Z} = \frac{\frac{S X_t}{n} + r_a + \frac{r_j + r_c}{(pn^2 + p)^2}}{\sqrt{\left[\frac{S X_t}{n} + r_a + \frac{r_j + r_c}{(pn^2 + p)^2}\right]^2 + \left[X_t + x_a + \frac{x_j + x_c}{(pn^2 + p)^2}\right]^2}} \quad (206)$$

The current is $\frac{E}{Z} = I.$ (207)

The input = $E I \cos \theta.$ (208)

The output is $P = E I \cos \theta - I^2 R_m.$ (209)

$$P = \frac{E^2 \left[\frac{S X_t}{n} + r_a + \frac{r_j + r_c}{(pn^2 + p)^2} \right]}{\left[\frac{S X_t}{n} + r_a + \frac{r_j + r_c}{(pn^2 + p)^2} \right]^2 + \left[X_t + x_a + \frac{x_j + x_c}{(pn^2 + p)^2} \right]^2} - \frac{E^2 \left[r_a + \frac{r_j + r}{(pn^2 + p)^2} \right]}{\left[\frac{S X_t}{n} + r_a + \frac{r_j + r_c}{(pn^2 + p)^2} \right]^2 + \left[X_t + x_a + \frac{x_j + x_c}{(pn^2 + p)^2} \right]^2} \quad (210)$$

$$P = \frac{E^2 S X_t}{Z^2 M} = \frac{I^2 S X_t}{n} \quad (211)$$

The torque is

$$D = \frac{P}{S} + \frac{I^2 X_t}{n} \text{ see eq. (187) and eq. (168)} \quad (212)$$

VECTOR DIAGRAM OF INDUCTION SERIES MOTOR.

The graphical diagram of Fig. 117 represents the above impedance equations (e.m.f. for unit current), where

$$O A = r_a + \frac{r_j + r_c}{(pn^2 + p)^2} \quad (213)$$

$$A D = X_t + x_a + \frac{x_j + x_c}{(pn^2 + p)^2} \quad (214)$$

$$D F = \frac{S X_t}{n} \text{ at speed } S \quad (215)$$

$$O F = Z \text{ at speed } S \quad (216)$$

$$\cos F O A = \cos \theta = \text{power factor at speed } S \quad (217)$$

Although neglecting certain modifying effects, the graphical diagram represents quite closely the observed performance characteristics of the induction-series motor. An inspection of equation (205) will show that certain values there given may be represented by others of much simplified nature since various terms there contained are constant in any chosen motor.

Let, therefore,

$$R = r_a + \frac{r_f + r_c}{(p n^2 + p)^2} \quad (218)$$

$$X = X_t + x_a + \frac{x_f + x_c}{(p n^2 + p)^2} \quad (219)$$

$$P = \frac{X_t}{n} \quad (220)$$

then the apparent impedance becomes,

$$Z = \sqrt{(R + P S)^2 + X^2} \quad (221)$$

the power factor is,

$$\cos \theta = \frac{B + P S}{\sqrt{(R + P S)^2 + X^2}} \quad (222)$$

which continually approaches unity with increase of speed.

GENERATOR ACTION OF INDUCTION SERIES MOTOR.

Let rotation of the armature in the direction produced by the electrical (its own) torque be considered positive. The reverse rotation in the contrary direction (against its own torque) be considered negative. Since the power component of the motor impedance has a certain value at zero speed, and increases with increase of speed, it should follow that by driving the rotor in a negative direction the apparent power component will reduce to zero and disappear. The power factor then reduces to zero and the current supplied to the motor will represent no energy flowing either to or from the motor.

This will be apparent from the relations above set forth, as well as by the relations algebraically expressed by the equation

$$\text{power} = E I \cos \theta = \frac{E^2 (R - P S)}{X^2 + (R - P S)} \quad (223)$$

the negative sign being due to the direction of rotation and the expression reducing to zero for zero value of the apparent power

component, $R - P S$. A further increase of speed in the negative direction will cause the expression for the power-factor and for the power, to become negative, the interpretation of which is that the machine is now being operated as a generator and hence is supplying energy to the line, that is, energy is flowing from the machine. Fig. 118 which gives the observed performance characteristics of a certain induction-series motor, will serve to show to what extent these theoretical deductions may be realized in an actual machine. If, then, during operation as

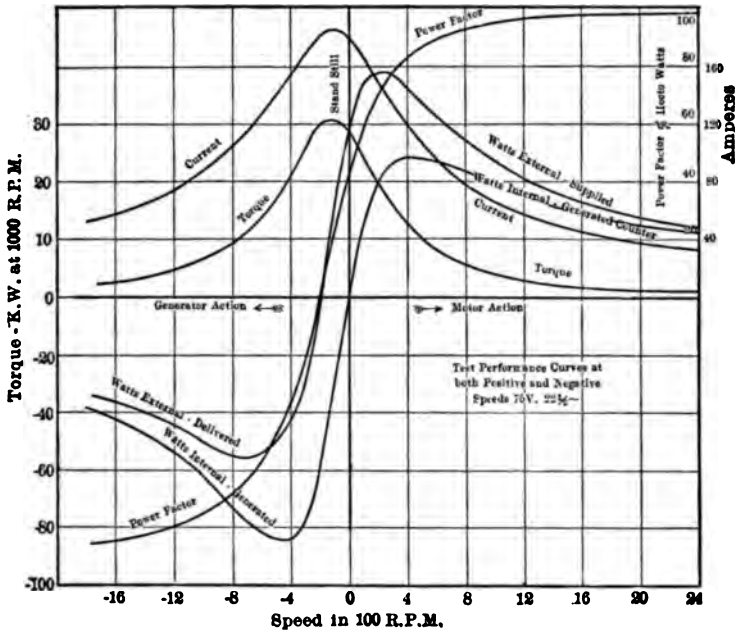

FIG. 118.—Test Characteristics of Induction-Series Motor.

a motor at a certain speed, the quadrature field flux be relatively reversed with reference to the brush axial-line field flux, so as to tend to drive the armature in the opposite direction, not only will a braking effect be produced by such change but energy will be transmitted from the machine to the line.

BRUSH SHORT-CIRCUITING EFFECT.

The effect of the short circuit by the brush of a coil in which an active e.m.f. is generated, which has been omitted in the

above equations, though completely included in the test curves, may be treated as follows. Referring to Fig. 117, it will be seen that at any speed S there will be generated in the coil under the brush by dynamo speed action an e.m.f.

$$e_s = K \phi_a S \quad \text{see eq. (43)} \quad (224)$$

where K is constant. This e.m.f. is in time-phase with the flux ϕ_a . In this coil there will also be generated an e.m.f., e_j , by the transformer action of the field flux, such that

$$e_j = K \phi_j \quad \text{see eq. (44)} \quad (225)$$

This e.m.f. is in time quadrature to ϕ_j . Since ϕ_j and ϕ_a are in time phase, the component e.m.f.'s acting in the coil under the brush are in time quadrature, so that the resultant e.m.f. is

$$E_b = \sqrt{e_s^2 + e_j^2} = K \sqrt{\phi_a^2 S^2 + \phi_j^2} \quad (226)$$

$$\frac{\phi_a}{\phi_j} = n \quad \text{see eq. (175)} \quad (227)$$

$$E_b = K \phi_a \sqrt{S^2 + \frac{1}{n^2}} \quad (228)$$

combining equations (169) and (181)

$$E = \frac{2 \pi f N_a \phi_a}{\sqrt{2} \cdot 10^8} \sqrt{\frac{S^2}{n^2} + 1} \quad (229)$$

$$\phi_a = \frac{\sqrt{2} \cdot 10^8 \cdot E}{2 \pi f N_a \sqrt{\frac{S^2}{n^2} + 1}} \quad (230)$$

combining (230) and (228)

$$E_b = \frac{K \sqrt{2} \cdot 10^8 E}{2 \pi f N_a} \cdot \frac{\sqrt{S^2 + \frac{1}{n^2}}}{\sqrt{\frac{S^2}{n^2} + 1}} \quad (231)$$

$$E_b = A \sqrt{\frac{S^2 n^2 + 1}{S^2 + n^2}} \quad (232)$$

where A is a constant as found above.

When $n = 1$, E_b is constant, independent of the speed, while when n is very small E_b is large at zero speed and continually

decreases with increase of speed. When $S = 1$ or at synchronous speed

$$E_b = \frac{K \sqrt{2} 10^8 E}{2 \pi f N_a} \quad (233)$$

quite independent of the value of n .

The relative impedance effect on E_b can be determined by combining equations (232) and (185) thus

$$\frac{E_b}{I} = \frac{A x_t}{E n} \frac{\sqrt{S^2 n^2 + 1}}{(S^2 + n^2)} \cdot \sqrt{S^2 + n^2} \quad (234)$$

$$\frac{E_b}{I} = B \sqrt{S^2 n^2 + 1} \quad (235)$$

B being a constant. The interpretation of equation (235) is that the apparent impedance effect of the short circuit by the brush consists of two components in quadrature, one component being of constant value and the other varying directly with the speed. Experimental observations fully confirm these theoretical conclusions, and show that the increase in apparent reactive effect with increase of speed for motor operation is approximately counterbalanced by the lagging counter e.m.f. (leading current) effect of the time-phase displacement between exciting current and field magnetism as has been mentioned previously and as will be dwelt upon subsequently. During generator operation, that is, with negative value of S , the apparent reactive effect of the short circuit at the brush adds directly to the lagging field flux, counter e.m.f. effect and therefore, the apparent reactance of the motor circuits increases rapidly with increase of speed in the negative direction, though remaining practically constant for all values of positive speed. These facts will be appreciated from a study of the test characteristics of the induction series machine throughout both its generator and motor operating range as shown in Fig. 118.

HYSTERETIC ANGLE OF TIME-PHASE DISPLACEMENT.

Mention has frequently been made of the fact that in the development of the equations for expressing the performance of the various types of series motors the effect of the hysteretic angle of time-phase displacement, between the magnetizing force

and the magnetism produced thereby has been neglected. In a closed magnet path operated at a density below saturation the tangent of the angle of time-phase displacement will be approximately unity—depending for its exact value upon the quality of the magnetic material. Consider the magnetic and electric circuits of the machine treated as a stationary transformer. The hysteresis loss will be, in watts,

$$W_h = \frac{.0021 f A l B_m^{1.6}}{10^7} \quad (236)$$

where A = cross sectional area of magnetic path

l = length of magnetic path (in centimeters)

B_m = maximum magnetic density (c.g.s.)

The electromotive force counter generated in the transformer coil having N turns will be, in effective volts,

$$E = \frac{2 \pi f A B_m N}{\sqrt{2} 10^8} \quad (237)$$

The current to supply the hysteresis loss will be

$$I_h = \frac{W_h}{E} = \frac{.0021 f A l B_m^{1.6}}{2 \pi f A B_m N} \cdot \frac{\sqrt{2} 10^8}{10^7} = .000462 l B_m^{.6} \quad (238)$$

With a permeability of μ the magnetizing component of the no-load current will be

$$I_\mu = \frac{A B_m l}{\frac{4 \pi}{10} \mu A \sqrt{2} N} = \frac{10}{4 \sqrt{2} \pi} \cdot \frac{B_m l}{\mu N} \quad (239)$$

For a certain value of permeability, depending upon the magnetic density, the hysteresis current and the magnetizing current become equal in value. Thus when the two components of the no-load exciting current become equal $I_\mu = I_h$,

$$\sqrt{2} 10 \frac{.0021 l B_m^{.6}}{2 \pi N} = \frac{B_m l 10}{4 \pi \sqrt{2} \mu N} \quad (240)$$

from which is obtained,

$$\mu = 119 B_m^{.4} \quad (250)$$

The meaning of equation (250) is that with a permeability of the value there designated, the hysteresis current and the no-load

exciting current are equal in value and that the resultant current $\sqrt{I_h^2 + I_\mu^2}$ is displaced from the flux by a time-phase angle whose tangent (equal at all times to the ratio of I_μ to I_h) is unity, as stated previously. For commercial laminated steel operated at densities below saturation, the permeability differs but slightly from the value given by the equation (250), though with increase of magnetic density above 7,000 lines per square centimeter the permeability falls off rapidly and the tangent of the angle of displacement between flux and current becomes correspondingly increased.

In an open magnetic circuit the permeability of a portion of the path reduces from the value approximately represented by the equation (250) to a value of unity, producing a very marked effect upon the hysteretic angle of displacement between flux and current.

Let l = length of path in magnetic material of permeability μ ,
 d = length of path in air,

then, assuming that permeability is as represented by equation (250), the tangent of the angle of time-phase displacement between flux and magnetizing force is such that

$$\tan \delta = \frac{\frac{l}{\mu}}{\frac{l}{\mu} + d} = \frac{l}{l + \mu d} \quad (251)$$

the significance of which equation is that the flux lags behind the current producing it, by an angle which depends for its value largely upon the ratio of the air-gap to the length of the magnetic path. Assigning values to μ , l and d , it will be seen that in any practical case the angle δ must be quite small,—seldom more than 2 degrees.

It should be carefully noted that a slight error is introduced on account of the fact that the permeability of commercial magnetic material undergoes a cyclic change with each alternation of the current, and that, independent of the angle of time-phase displacement between flux and current, the shape of the waves representing the time-values of the two can not both be sinusoidal, and that in assigning a value to the angle of time-phase displacement between the flux and current, the lack of similarity of the two waves has been neglected.

POWER FACTOR OF COMMUTATOR MOTORS.

Under speed conditions the e.m.f. counter generated by the cutting of the armature conductors across the field magnetism, varies in value with the magnetism, and hence it must have a wave shape of time-value similar in all respects to that of the field flux, and must have a time-phase position with reference to the field current quite the same as that of the magnetism. The counter generated speed e.m.f. must, therefore, lag behind the current by an angle whose tangent is as given by equation (251). Now since the counter e.m.f. lags behind the current, the current must lead the counter e.m.f. by the same angle—a fact which has been mentioned previously.

With motors having air gaps of sizes demanded by mechanical clearance, the inherent angle of lead is quite small, and its effect upon the power factor is neutralized by the effect of the short circuit by the brush of a coil in which is generated an e.m.f. by both transformer and speed action when the machine is operated as a motor. When the machine is operated as a generator, however, the hysteretic angle and the angle due to the short circuiting effect are in a direction such as to be additive to the stationary reactive effect of the motor circuits and, therefore, during generator operation the power factor is lower than during motor operation, as shown in Fig. 118.

While the angle of lead due to the hysteretic effect, even when the machine is running as a motor, is in any case quite small and its good effects cannot be availed of, it is possible by means of certain auxiliary circuits to give to the angle of time-phase displacement between the line current and the flux any value desired, and thus to cause the operating power factor to become unity or to decrease with leading wattless current, as is shown below.

RESISTANCE IN SHUNT WITH FIELD WINDING.

Fig. 119 represents diagrammatically the circuits of a conductively compensated-series motor in parallel with the field coil of which is placed a non-inductive resistance. Consider first, ideal conditions in which the armature and compensating coils are without resistance and the compensation is complete so that these two circuits, treated as one, are without inductance. The field coil is without resistance but constitutes the reactive portion of the motor circuits.

When the armature is stationary the circuit through the resistance being open, the current taken by the machine has a value determined by the ratio of the impressed e.m.f. and the reactance of the field coil. This current lags 90 time degrees

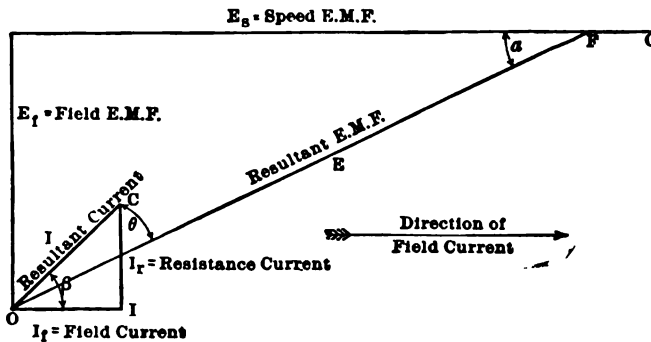
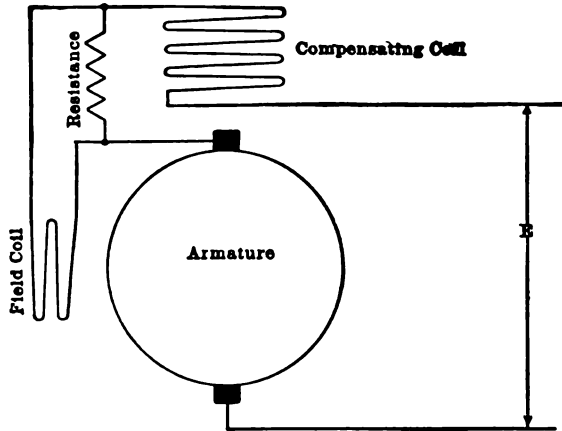

FIG. 119.—Circuit and Vector Diagrams of Compensated Series Motor with Shunted Field Coil.

behind the e.m.f. across the field coils. When a resistance is placed in shunt to the field coil, current flows therethrough, quite independently of the field current. The current taken by the resistance is in time-phase with the e.m.f. impressed upon the field coil.

In Fig. 119 let $O I = I_f$ represent the field current, assumed always of unit value. $O D = E_f$ is the e.m.f. impressed across the field coil and the shunted resistance. I_r is the current taken by the resistance. $O C = I$, the current which flows through the armature and compensating coil or the resultant current taken by the motor has a value represented by the equation

$$I = \sqrt{I_f^2 + I_r^2} \quad (252)$$

and has a phase displacement β with reference to the field current such that

$$\tan \beta = \frac{I_r}{I_f} \quad (253)$$

With unit value of field current, under speed conditions, the e.m.f., E_s , ($D F$ of Fig. 119) counter generated at the brushes, due to the presence of the field flux, will be proportional directly to the speed and in time-phase with the field current. Thus this component of the counter e.m.f. of the motor is in no wise affected by the presence of the current through the shunted resistance. At a certain speed, the counter generated armature e.m.f. will have a value represented by the line $D F$ Fig. 119 the resultant e.m.f. $E = O F$ being the vector (quadrature) sum of the speed e.m.f. and the stationary e.m.f. E_s , that is

$$E = \sqrt{E_f^2 + E_s^2} \quad (254)$$

and has a time-phase α position with reference to the speed e.m.f. E_s , such that

$$\tan \alpha = \frac{E_f}{E_s} \quad (255)$$

An inspection of Fig. 119 will show that under operating conditions, the angle of time-phase displacement between the current and the electromotive force, θ , has a value represented by the equation

$$\theta = \beta - \alpha \quad (256)$$

or the current *leads* the e.m.f. by the angle θ . At a certain critical speed for each value of shunted resistance, or at a certain value of resistance for any given speed, the angle θ reduces to zero, and the power factor of the motor becomes unity.

It is interesting to observe the effect of removing the resistance from in shunt with the field circuit. Since the current

taken by the resistance is 90 time-degrees from the field flux, the resultant torque due to the product of this component of the current and the flux is of zero value, the instantaneous torque alternating at double the circuit frequency. The current through the resistance, therefore, contributes in no way to the power of the machine or to the counter-generated, armature-speed e.m.f., and when the circuit through the resistance is opened no effect whatsoever is produced upon the value of the current taken by the field coil, the counter e.m.f. or the torque of the machine. It is apparent, therefore, that the use of the shunted resistance increases the circuit current in a certain definite proportion, the added component being a leading "wattless" current under speed conditions. If a reactance be placed in parallel with the field coil, the current which flows therethrough will be in time-phase with the field flux, and the torque produced thereby will add to the torque due to the field current and it will affect directly the whole performance of the machine. The current taken by a condensance in shunt with the field coil will be in time-phase opposition to the field current and will tend to decrease directly both the circuit current and the armature torque. An excess of condensance will cause the torque to reverse and the machine to act as a generator even when the speed is in a positive direction. When the condensance and the field reactance are just equal, the circuit current reduces to zero and the torque disappears. Under the conditions here assumed, the counter generated e.m.f. at the armature remains proportional to the product of the field flux and the speed, and there appears the remarkable combination of zero current being transmitted over a certain counter e.m.f. (that is, through infinite impedance) to divide into definite active currents at the end of the transmission circuits.

LOSS DUE TO USE OF SHUNTED RESISTANCE.

From what has been demonstrated above, it is seen that shunted condensance acts to take current in phase opposition and to decrease the torque; reactance takes current directly in phase, and increases the torque, while resistance takes current in leading quadratures with the field current and has no effect upon the torque. It is evident that the improvement in power factor due to the use of the resistance is advantageous provided

the losses caused by the resistance are not excessive. Referring to Fig. 119, when the resistance is not used the power taken by the machine under speed conditions is

$$P = O I . O F . \cos F O I = I_f E \cos \alpha = I_f E_s \quad (257)$$

When the machine is stationary, the power absorbed by the resistance is

$$P_r = C I . O D = I_r E_f \quad (258)$$

When the motor is running with shunted field coil, the power delivered to the machine is

$$P_t = O C . O F . \cos C O F = I E \cos \theta \quad (259)$$

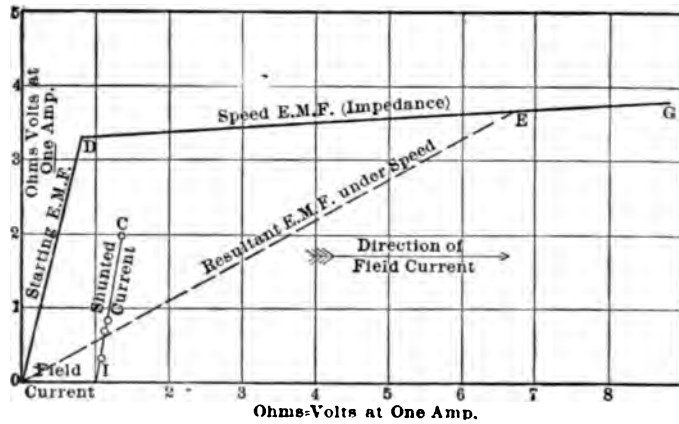

FIG. 120.—Observed e.m.f.—Current Characteristics of Plain Series Motor with Shunted Field Coils.

$$\theta = \beta - \alpha \quad (260)$$

$$\cos \theta = \cos \beta \cos \alpha + \sin \beta \sin \alpha \quad (261)$$

$$P_t = I \cos \beta . E \cos \alpha + I \sin \beta . E \sin \alpha \quad (262)$$

$$P_t = I_f E_s + I_r E_f = P + P_r \quad (263)$$

The significance of equation (263) is that the power absorbed is that incident to the use of the resistance, and that for a given current it is unaffected by the speed e.m.f. Thus the current taken by the resistance multiplies into the stationary transformer e.m.f. to give the actual watts absorbed while the same

current multiplies into the speed e.m.f. to give apparent leading wattless power.

In the derivation of the above equations ideal conditions have been assumed, which cannot be obtained in a practical motor. Fig. 120 represents the observed e.m.f.-current characteristics of a certain plain, uniform reluctance motor (see Fig. 114) with shunted field coils, and serves to show that even such an unfavorable machine may be caused to operate at unity power factor at any speed greater than about one-half synchronism.

CHAPTER XVI.

PREVENTION OF SPARKING IN SINGLE-PHASE COMMUTATOR MOTORS.

TRANSFORMER ACTION WITH STATIONARY ROTOR.

The greatest difficulty which has been encountered in the design of alternating-current motors of the commutator type has resided in the unavoidable e.m.f. produced at the coil under the brush due to the variation in the field magnetism. When the armature is stationary, there exists an appreciable electromotive force between the terminals of each coil, the field coils acting as the primary and the armature coils in the neighborhood of the brushes as the secondary of a transformer, as indicated diagrammatically in Figs. 121 and 122.

In motors of the repulsion type or by special magnetizing coils placed on any of the other types of motors, it is possible to neutralize the transformer e.m.f. in the coil under the brush by a speed generated e.m.f. when the rotor is in motion. See equations (48) and (101). The neutralization of the transformer e.m.f. under starting conditions is not wholly impossible, but it may be stated that such neutralization involves certain complications which are not desirable in a commercial motor.

When the rotor is at rest the full effect of the transformer e.m.f. is felt at the brushes, quite independent of the type of motor employed and it may fairly be said that all simple forms of alternating-current commutator motors are equally disadvantageous with regard to the sparking at starting. The current which flows through the short-circuit coil by way of the brush is ordinarily of large value, and it produces an excessive heating of the brush, the commutator segments and the coil. Moreover, the rupture of this current when the brush passes from one commutator segment to the next produces destructive arcing at the brushes, and its presence is in general detrimental to the perfect performance of the machine. To the evil effects of this local current in the short-circuited coils

may be attributed the slow progress which had been made in the development of the commutator type of alternating current machines previous to the last few years.

INTERLACED ARMATURE WINDINGS.

The short circuiting effect may be largely eliminated by using two or more interlaced armature windings, so arranged that the brush cannot span the commutation sufficiently to connect two bars of the same winding. As usually applied, this method is not satisfactory on account of the fact that the current in each winding must be completely interrupted whenever the corresponding bar passes from contact with the brush. The interruptions occur at a frequency depending upon the speed of the rotor and the number of commutator segments, and they result in serious sparking and pitting at the commutator equally as disadvantageous as that caused by the short-circuiting. That is to say, the starting conditions have been slightly improved but the running conditions have become much worse.

It has also been proposed to divide the armature circuits into three distinct interlaced windings, the current being led into the armature by way of two separately insulated brushes at each neutral point. By connecting the brushes in pairs to the terminals of two distinct secondaries of a single transformer, the current for the different armature windings shifts from one secondary coil to the other; but at no time is any armature or transformer circuit broken. The method here outlined renders the short-circuiting effect a minimum, and it possesses considerable merit in this respect. However the method has not been applied extensively in commercial practice, probably, on account of the involved electrical and mechanical complications.

USE OF SERIES RESISTANCE.

Of the many methods which have been proposed for minimizing the effect of the short-circuited e.m.f. in the coil under commutation, those which involve the use of resistances in series with the coil have proven to be the most successful. Fig. 121 shows the method by which the resistances are inserted in circuit with the coil under the brush; the armature winding is closed on itself and is connected to the commutator through resistance leads. These leads serve the same function as the

preventive coils used in alternating-current work when passing from one tap to another of a transformer. In fact this armature, in one sense, may be considered as a transformer with a lead brought out from each coil through a resistance to a contact piece, the various contact pieces being assembled together to form a commutator, as shown diagrammatically in Fig. 121.

The function of the "preventive" resistance leads is to reduce the short-circuit current, when passing from one bar to the next to a desirable low value. As far as concerns commutation it is desirable that these resistances be as large as possible, while the loss of power due to the passage of the main motor current through them dictates that their value be kept

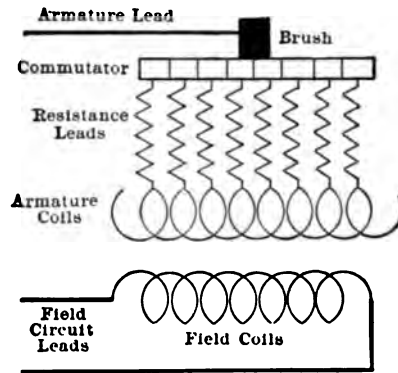

FIG. 121.—Internal Preventive Resistance for Commutator Motor.

quite small. It is evident, therefore that there is some intermediate condition which gives the most efficient results, both as regards the economy of power and the commutation of the current.

POWER LOST IN RESISTANCE LEADS.

It is worthy of note that although the prime object of the resistance leads is to diminish the short-circuit current and thus to minimize the sparking at the brushes, the losses are actually less when the resistance leads are used than when they are omitted. This fact will be appreciated when it is remembered that when the resistance leads are not used the loss due to the short-circuit current is enormous, although that due to the main

line current may be small. When resistance is inserted in the coil under the brush the former loss is decreased and the latter is increased. In practice the inserted resistance is given a value such that the sum of the two losses is a minimum, which condition exists when the two losses are equal.

INTERNAL RESISTANCE LEADS.

The mechanical arrangement of the preventive resistances have not caused any very great difficulty in the construction of motors. Each lead is so placed that it forms a non-inductive path for both the short-circuit current and the main line current, which condition is conducive to sparkless commutation. According to one method of construction, special slots are cut in the core for the reception of the leads. According to another method, the leads are placed in the same slots with the main armature winding. The resistance leads, after being insulated, are laid in the bottom of the slots, one terminal of each lead passing to a commutator segment and the other to a tapping point on the active armature winding which occupies the top portions of the slots.

Objections which have been urged against the use of resistance leads relate to the power absorbed by the leads, and to the fact that, as ordinarily arranged on the armature, the resistance cannot conveniently be varied during the operation of the machine. Furthermore, although the leads are placed in positions where it is difficult to repair or replace them in case they are damaged, practical requirements demand that the leads be of limited cross-section, entailing the constant danger that they will burn out. Several schemes have been proposed for overcoming these objections.

EXTERNAL RESISTANCE LEADS WITH TWO COMMUTATORS.

According to one of these schemes the motor is provided with two commutators connected to opposite ends of the armature conductors, each commutator having alternate live and dead segments. The brushes bearing on each commutator have a width not greater than that of a commutator segment. Several brushes of each polarity are distributed around each commutator, the brushes being so arranged that when one brush is on a dead segment other brushes of the same polarity

are on live segments. The motor is arranged to be started with sufficient resistance between the parallel connected brushes to limit the short-circuit current to the desired amount, and this resistance is decreased as the motor comes up to speed.

EXTERNAL RESISTANCE LEADS WITH ONE COMMUTATOR.

Another scheme which accomplishes the same results with the use of only one commutator is indicated diagrammatically in Fig. 122. Instead of the usual single brush or set of brushes at each point of commutation there are employed three independently insulated brushes, each brush having a width some-

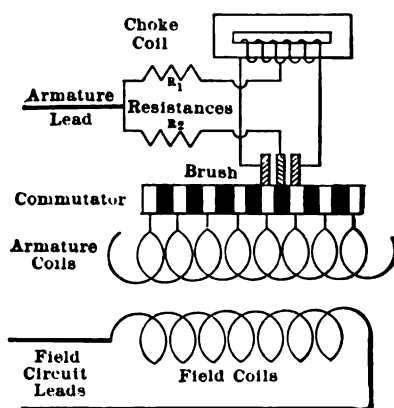

FIG. 122.—External Preventive Resistance for Commutator Motor.

what less than the width of a dead segment. The outer brushes are connected to the terminals of a reactance coil, while the middle brush is connected through resistances to the middle point of the reactance coil and to a terminal of the machine.

It will be noted that when the outer brushes are on live segments, the only current which can flow in the local circuit of the armature coil under the brushes and the reactance coil is the negligible exciting current of the coil. The main power current flowing through the armature passes differentially through the halves of the reactance coil and hence causes no opposing reactance. That is to say, for the line current the coil acts like a non-inductive resistance, but for the local short-

circuit current it acts like a true reactance coil to decrease the current to a negligible value.

When the commutator moves to a position where the middle brush is immediately over a live segment, no current whatsoever passes through the reactance coil, while the middle brush conveys the entire line current. In each of these two positions the machine is devoid of any short-circuiting effect and no abnormal heating is produced at any point.

When the commutator is in an intermediate position, however, where the middle and one outer brush are simultaneously on the same live segment a disadvantageous short-circuit does exist. In the position here assumed an electromotive force having a value equal to one half of that of one armature coil tends to circulate a current locally through one-half of the reactance coil and the two brushes which bear on a single commutator segment. The adjustable resistances inserted in the circuit of the middle brush serve to keep the short-circuit current within proper limits.

It will be noted that if the two outer brushes be placed on a single commutator segment, the reactance coil can be omitted and yet the resistances R_1 and R_2 may be employed to limit the value of the short-circuit current. In this latter event there are in effect only two brushes at each commutation point and there occur only one-half as many short-circuits per revolution as occur with the arrangement shown in Fig. 122. Simplicity would seem to dictate the use of two brushes without the reactance coil rather than three brushes with the coil. A little consideration will show that by inserting the reactance coil in circuit and dividing one brush into two parts the effect as far as commutation is concerned is exactly the same as though each segment of the commutator were live and the voltage between segments were reduced to one-half of the value actually produced in each armature coil; that is, the reactance coil serves to obtain a middle e.m.f. point on each armature coil, and an armature provided with a one-turn-per-coil winding commutates as though there were only one-half turn per coil.

In the arrangement shown in Fig. 122 the resistances are made of ample current carrying capacity for the maximum load on the machine, and they are, therefore, not subject to burn-outs. Moreover, they are external to the armature, and can

easily be adjusted or repaired. The reactance coils may be located at any convenient distance from the brushes of the machine and the connecting leads will serve as resistance to limit the value of the short-circuit current. Additional resistance can be inserted as found necessary, this latter resistance being varied at will during the operation of the machine. Thus the normal "starting" resistance may be employed simultaneously to limit the short-circuit current at starting.

INDEX.

- Air Gap**, effect of volume on-exciting current of induction motors, 135.
- Alternators** (see Generators).
- Angle of lag**, determination of, 11.
determination of with one watt-meter, 6.
- Arc lamps**, frequency required by, 31.
- Armature turns effective**, 216.
windings interlaced, 267.
- Auto starter for induction motors**, 22.
- Circle diagram**, 65, 100.
accuracy of, 105.
errors in, 71.
- Circuits**, electric and magnetic, 95.
equivalent electric, 98.
magnetic reluctance, effect of varying, 96.
single-phase and polyphase, 1.
- Coils**, effect of grouping on capacity of induction motors, 133.
in series, effective value of e.m.f. in, 150.
- Commutating motors** (see Motors).
- Commutator on rotor of single-phase induction motor**, 56.
used to excite asynchronous generators, 92.
- Concatenation control**, 23.
- Condensance**, adjustment of, 89.
used as source of exciting current, 83.
used in split-phase motor, 62.
- Condensers**, operation of, 84.
- Conducting material**, economy of, 1
required for different transmission systems, 3.
- Control of induction motor by concatenation**, 23.
- Converters**, frequency, 31.
capacity of, 33.
field of application, 31.
performance of, 32.
power supplied by, 33.
inverted, 170.
six-phase, 174.
synchronous, 149.
capacity, relative 154.
for various phases, 163.
characteristics of, 172.
compounding of, 169.
current (a.c.) maximum, value of, 155.
equations of, 173.
excitation of, 166.
frequency of, 31.
heat loss in armature coils, distribution of, 159.
hunting of, 167.
operation at fractional power factor, 160.
operation at unity power factor, 154.
performance, characteristic, 165.
performance, predetermination of, 171.
starting of, 168.
two-phase, currents in, 156.

- Core, effect of volume on exciting current of induction motors, 135.
flux in induction motors, determination of, 130.
- Currents, equivalent single-phase, 13.
- Delta** vs. star-connected primaries, 180.
- Diagram of compensated repulsion motor, 221.
of compensated series motor, with shunted field coil, 261.
of induction series motors, 246.
of inductively compensated series motors, 240, 241.
of performance of polyphase induction motors, 109.
of performance of single-phase induction motors, 115.
of plain series motor, 233.
of repulsion motor, 193-206.
- Double current generators (see generators).
- Eddy** current losses, 98.
- Effective, armature turns, 216.
- Electrical-space degrees, 123.
- Electrical-time degrees, 123.
- E.m.f.s, generated by an alternating field, 199.
in group of coils in series, effective value of, 150.
in six-phase circuit, 2.
in three-phase circuit, 2.
- Electromagnetic torque, 181.
- Equivalent circuits, 98.
single-phase currents, 13.
single-phase resistance, 14.
- Excitation of induction motors, 35.
of synchronous machines, 166.
- Exciting watts in induction motors, 73.
- Ferraris'** method of treating single-phase induction motors, 138.
- Fisher-Hinnen device for starting induction motors, 23.
- Four-phase, 156.
- Frequency converters (see Converters).
effect upon alternators in parallel, 31.
required by arc lamps, 31.
used in rotary converters, 31.
- Generators**, asynchronous, 74.
characteristic performance, 79.
core, design of, 91.
commutator, excitation of, 92.
compensation for inductive load, 94.
connections for condenser excitation, 80.
current diagram, 75.
excitation, characteristics of, 86.
excitation of, 81.
excited by condensance, 83.
lagging current load, effect of, 90.
leading current load, 90.
load characteristics of, 90.
operation of, 75.
operation with commutator excitation, 93.
parallel operation of, 80.
performance, calculation of, 77
shunt excited, 94.
- d. c., capacity compared with various a. c. machines, 164.
- double current, 149, 161.
capacity for various phases, 163.
heat loss in armature coils, distribution of, 159.
- synchronous, 151.
capacity compared with d. c. machines, 152.
capacity for various phases, 163.
parallel operation of, 80.
- Heyland** asynchronous generator, 94.
induction motor (see Motors).
motor, winding, double three-phase secondary, 46.

- Hunting, 167.
Hysteresis losses, 98.
- Induction** motor (see Motor, Induction).
- Induction series motors (see Motors, Series Induction).
- Inverted converters (see Converters)
- Leakage** reactance in compensated repulsion motors, 229.
in induction motors, 73.
in induction series motors, 252.
in repulsion motors, 209.
- Loading back method of measuring torque, 185.
- Loads balanced, 6.
unbalanced, 9.
- Magnetic** distribution in polyphase motors, 125.
- Measurements of power, 3.
- Mechanical-space degrees, 123.
- Methods, graphical, advantage of, 63.
- Motors**, commutator, e.m.fs., generated by alternating field, 199.
power factor, 260.
power lost in resistance leads, 268.
sparking, prevention of, 266.
torque, production of, 181.
treatment of, simplified, 189.
- induction, alternating current in secondary coils, 39.
capacity, method of increasing, 47.
concatenation control, 23.
core flux as affected by distributed winding, 131.
core flux, determination of, 136
current diagram at all speeds, 75.
locus, 65.
locus, effect of resistance on, 108.
equation, 70.
exact, 107.
- Motors**, induction, *continued*.
design, effect of leakage reactance on, 73.
direct current in secondary coils, 38.
efficiency, 21.
equations, analytic, 19.
excitation of, 35.
exciting watts, value of, 73.
Fisher-Hinnen device, 23.
general outline, 16.
Heyland, 35.
action with rotor at synchronous speed, 43.
action with stationary rotor, 41.
connecting resistance, function of, 44.
direct current armature of, 40.
internal voltage diagram, 105.
iron losses, 98.
magnetic field in, 121.
method of treatment, 16.
operation above synchronism, 75.
below synchronism, 74.
outline of characteristic features, 48.
output, 21.
performance observed, 25.
performance diagram, proof of, 111.
polyphase, capacity of, 119.
capacity as affected by grouping of coils, 133.
compared with single-phase motors, 112.
exciting current, 135.
exciting watts, 135.
magnetic distribution with closed secondary, 127.
magnetic distribution with open secondary, 124.
magnetic field in, 121.
output, maximum, 110.
operated as single-phase machines, 58.

Motors, induction, polyphase, *continued.*

- performance, complete diagram of, 109.
- power factor, maximum, 110
- torque, maximum, 110.
- power factor, 21.
 - calculation of, 29.
 - maximum, 36.
 - method of improving, 36.
- primary current, calculation of, 30.
- reactance at standstill, 18.
- resistance external to secondary windings, 23.
 - in secondary windings, 22.
- revolving field. production of, 17.
- secondary current, determination of, 28.
 - effective resistance in, 63.
 - exciting m.m.f., 37.
 - frequency, 18.
 - resistance measurement of, 28.
- series, commutator, 245.
- single-phase, 48.
 - capacity of, 119.
 - commutator for starting purposes, 56.
 - compared with polyphase, 48, 112.
 - currents in secondary, 49, 143.
 - electric circuits of, 114.
 - equivalent circuit (exact), 114.
 - equivalent circuit (modified) 115.
 - magnetic field in, 138.
 - magnetizing current, 54.
 - performance, diagram, 115.
 - polyphase motor, used as, 58
 - quadrature magnetism, production of, 49.
 - revolving field, elliptical, 53.
 - circular, 52.
 - production of, 51.
 - secondary currents in, 143.

Motors, induction, single-phase, *continued.*

- secondary quantities, graphical representation of, 146.
- shading coils, 54.
- speed equation, 117.
- speed field, 117.
 - as affected by speed, 148.
 - current production of, 139
- torque, 117.
 - action of commutator in producing, 56.
 - starting, 53.
- transformer features of, 142.
- transformer field, as affected by speed, 148.
- slip measurement of, 26.
- starting devices for, 22.
- synchronous speed, determination of, 24.
 - method of decreasing, 24.
- tandem control, 24.
- test with one voltmeter and one wattmeter, 25.
- three-phase, equivalent starting current, 113.
 - starting current (equivalent single-phase), 113.
 - operated on single-phase circuit, 61.
- torque, determination of, 27.
 - maximum, 20.
- transformer features of, 95.
- treatment of, graphical, 63.
- two-phase, equivalent starting current, 113.
 - operated on single-phase circuit, 59.
 - starting current (equivalent single-phase), 113.
 - test results, 66.
- used as frequency converters, 31.
 - generators, 74.
 - synchronous motor, 39.
- voltage, internal, 105.
- winding distributed, 131.
 - effect of, on core-flux, 131.

Motors, continued.

- repulsion, 189.
 - brush, short-circuiting effect, 212.
 - characteristics of, 197-198.
 - compensated, 214.
 - brush, short-circuiting effect 228.
 - characteristics of, 222.
 - fundamental equations of, 218.
 - leakage reactance, 227.
 - performance, calculation of, 223.
 - observed, 224.
 - resistance, 227.
 - test, 225-226.
 - vector diagram of, 221.
 - construction of, 201.
 - diagram proof of, 208.
 - electrical circuits (ideal), 190.
 - equations of, 210.
 - fundamental equations of, 204.
 - graphical diagram of, 193.
 - graphically treated, 199.
 - impedance apparent, 217.
 - leakage reactance, 209.
 - magnetic circuits (ideal), 190.
 - operation of, 202.
 - performance, calculation of, 195.
 - observed, 213.
 - resistance of, 209.
 - test of, 214.
 - torque, 209.
 - production of, 192.
 - treatment, algebraic, 199.
 - vector diagram of, 206.
- series, 232.
 - compensated conductively, 242
 - equations, 243.
 - impedance, 242.
 - inductively, 241.
 - line current, 243.
 - performance, calculation of, 243.
 - power, 243.
 - power factor, 242.
 - torque, 243.

Motors, series, compensated, continued.

- vector diagram, 244.
- field winding shunted with resistance, 260.
- fundamental equations with non-uniform reluctance, 237.
 - with uniform air-gap reluctance, 233.
- hysteresis loss in, 258.
- induction, 245.
 - brush, short-circuiting effect 255.
 - equations, fundamental, 247
 - generator action in, 254.
 - leakage reactance, 252.
 - resistance, 252.
 - starting torque, 250.
 - test of, 255.
 - vector diagram, 253.
- hysteretic angle of time-phase displacement, 257.
- loss in shunted resistance, 263.
- performance with shunted field coils, 264.
- power, 236.
- power factor, 235.
- resistance in shunt with field winding, 260.
- torque, 236.
- treatment, algebraic, 232.
 - graphical, 232.
- synchronous, 149, 151.
 - capacities relative, 154.
 - excitation of, 166.
 - hunting of, 167.
- Performance** diagram for polyphase induction motors, 109.
 - of single-phase induction motors, 115.
- Phase**, relation of voltages in synchronous machines, 150.
- Polyphase** circuits, 1.
 - induction motors (see Motors, Induction).
- Power**, apparent in three-phase circuit, 13.

Power, continued.

- factor, adjusted by resistance in shunt with field winding, 260.
- determination of, 11.
- maximum of induction motors, 36.
- method of improving, 36.
- measurements, three-phase, 3.
- unbalanced three-phase circuits, 3.
- three-phase, one wattmeter method, 6.
- two wattmeter method, proof of, 3.

Quadrature watts, 8.**Reactance, leakage, 73.**

- in compensated repulsion motors, 229.
- in induction series motors, 252.
- in repulsion motors, 209.
- of induction motors running, 18.
- of induction motors at standstill, 18.

Resistance in secondary winding of induction motor, 22.

- equivalent, single-phase, 14.
- in shunt with field winding, 260.
- used to prevent sparking, 267.

Rotary converters (see Converters).**Revolving field, production of, 17.****Shading coils, 54.**

- action of, 54.

Single-phase circuits, 1.

- induction motors (see Motors, Induction).

Six-phase transformation, 175.**Slip, 18.**

- measurement of, 26.

Sparking in commutator motors, 266.

- power lost in resistance leads, 268
- prevention of, by external resistance leads with one commutator, 270.
- by external resistance leads with two commutators, 269.

Sparking, prevention of, continued.

- by internal resistance leads, 269.
- by interlaced windings, 267.
- by series resistance, 267.
- transformer action with stationary rotor, 266.

Split phase motor, 58.

- use of condensance with, 62.

Star vs. delta-connected primaries, 180.**Starting devices for induction motors, 22.****Steinmetz method of treating single phase induction motors, 139.****Synchronous commutating machines, definition of, 149.**

- converters (see Converters).

- motors (see Motors).

- speed, determination of, 24.

Tandem control of induction motors, 24.**Three-phase to six-phase transformation, 175.****Torque, determination of, 27, 184.**

- electromagnetic, 181.

- for non-uniform reluctance, 183.

- for uniform reluctance, 181.

- measurement of, 185.

- electrical, errors in, 187.

- production of in commutating motors, 181.

Transformer action with stationary rotor, 266.

- circle diagram for, 100.

- connections, 175.

- equivalent circuits of, 99.

- equivalent circuits of (approximate), 99.

- hysteresis loss in, 258.

- iron losses, 98.

- principle of, 95.

- six-phase, 175.

- used to adjust condensance, 89.

Two-phase to six-phase transformation, 175.**Windings, armature, interlaced, 267**

- distributed, 131.

7/4

JW

