



This is a digital copy of a book that was preserved for generations on library shelves before it was carefully scanned by Google as part of a project to make the world's books discoverable online.

It has survived long enough for the copyright to expire and the book to enter the public domain. A public domain book is one that was never subject to copyright or whose legal copyright term has expired. Whether a book is in the public domain may vary country to country. Public domain books are our gateways to the past, representing a wealth of history, culture and knowledge that's often difficult to discover.

Marks, notations and other marginalia present in the original volume will appear in this file - a reminder of this book's long journey from the publisher to a library and finally to you.

Usage guidelines

Google is proud to partner with libraries to digitize public domain materials and make them widely accessible. Public domain books belong to the public and we are merely their custodians. Nevertheless, this work is expensive, so in order to keep providing this resource, we have taken steps to prevent abuse by commercial parties, including placing technical restrictions on automated querying.

We also ask that you:

- + *Make non-commercial use of the files* We designed Google Book Search for use by individuals, and we request that you use these files for personal, non-commercial purposes.
- + *Refrain from automated querying* Do not send automated queries of any sort to Google's system: If you are conducting research on machine translation, optical character recognition or other areas where access to a large amount of text is helpful, please contact us. We encourage the use of public domain materials for these purposes and may be able to help.
- + *Maintain attribution* The Google "watermark" you see on each file is essential for informing people about this project and helping them find additional materials through Google Book Search. Please do not remove it.
- + *Keep it legal* Whatever your use, remember that you are responsible for ensuring that what you are doing is legal. Do not assume that just because we believe a book is in the public domain for users in the United States, that the work is also in the public domain for users in other countries. Whether a book is still in copyright varies from country to country, and we can't offer guidance on whether any specific use of any specific book is allowed. Please do not assume that a book's appearance in Google Book Search means it can be used in any manner anywhere in the world. Copyright infringement liability can be quite severe.

About Google Book Search

Google's mission is to organize the world's information and to make it universally accessible and useful. Google Book Search helps readers discover the world's books while helping authors and publishers reach new audiences. You can search through the full text of this book on the web at <http://books.google.com/>

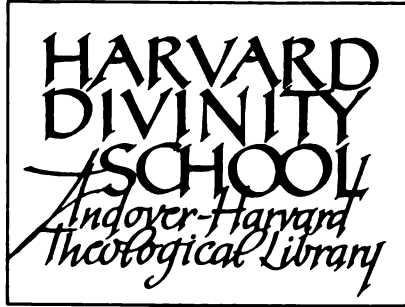



THE
ENCYCLOPÆDIA BRITANNICA
 ELEVENTH EDITION

FIRST	edition, published in three	volumes,	1768—1771.
SECOND	“ “ ten	“	1777—1784.
THIRD	“ “ eighteen	“	1788—1797.
FOURTH	“ “ twenty	“	1801—1810.
FIFTH	“ “ twenty	“	1815—1817.
SIXTH	“ “ twenty	“	1823—1824.
SEVENTH	“ “ twenty-one	“	1830—1842.
EIGHTH	“ “ twenty-two	“	1853—1860.
NINTH	“ “ twenty-five	“	1875—1889.
TENTH	“ ninth edition and eleven supplementary volumes,		1902—1903.
ELEVENTH	“ published in twenty-nine volumes,		1910—1911.

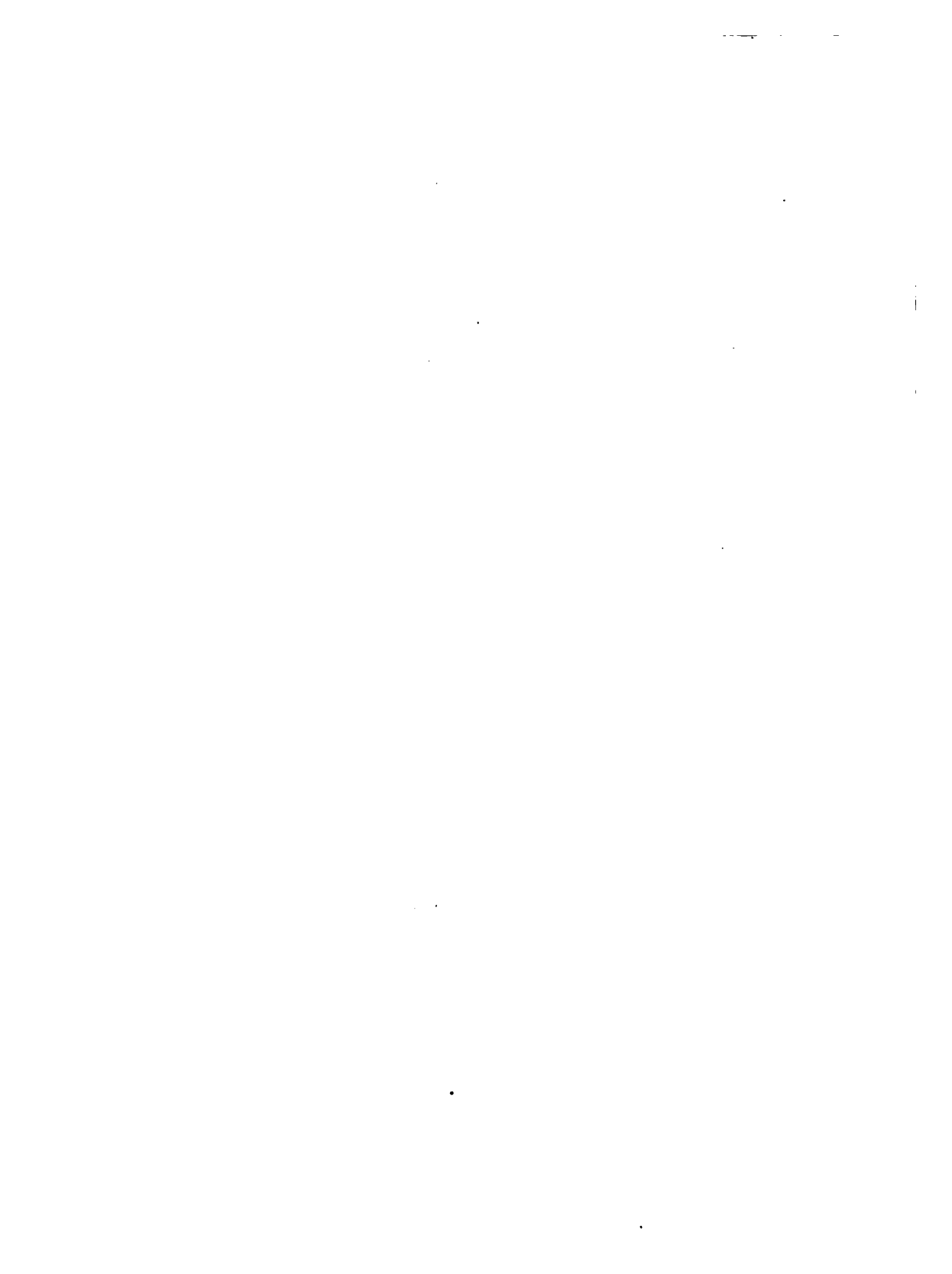

THE
ENCYCLOPÆDIA BRITANNICA

A
DICTIONARY
OF
ARTS, SCIENCES, LITERATURE AND GENERAL
INFORMATION

ELEVENTH EDITION

VOLUME IV
BISHĀRĪN to CALGARY

NEW YORK
THE ENCYCLOPÆDIA BRITANNICA COMPANY
1910

Ref
AE
5
.E36
1910a
v.1

Copyright, in the United States of America, 1910,
by
The Encyclopædia Britannica Company

INITIALS USED IN VOLUME IV. TO IDENTIFY INDIVIDUAL
CONTRIBUTORS,¹ WITH THE HEADINGS OF THE
ARTICLES IN THIS VOLUME SO SIGNED.

A. B. R.	ALFRED BARTON RENDLE, F.R.S., F.L.S., M.A., D.Sc. Keeper of the Department of Botany, British Museum.	{ Botany.
A. E. H.	A. E. HOUGHTON. Formerly Correspondent of the <i>Standard</i> in Spain. Author of <i>Restoration of the Bourbons in Spain</i> .	{ Cabrera.
A. E. S.	ARTHUR EVERETT SHIPLEY, F.R.S., M.A., D.Sc. Fellow and Tutor of Christ's College, Cambridge. Reader in Zoology, Cambridge University. Joint-editor of the <i>Cambridge Natural History</i> .	{ Brachiopoda.
A. F. P.	ALBERT FREDERICK POLLARD, M.A., F.R.HIST.SOC. Professor of English History in the University of London. Fellow of all Souls' College, Oxford. Assistant Editor of the <i>Dictionary of National Biography</i> , 1893-1901. Lothian Prizeman (Oxford), 1892. Arnold Prizeman, 1898. Author of <i>England under the Protector Somerset; Henry VIII.; Thomas Crommer; &c.</i>	{ Bonner; Burghey, Baron.
A. G.®	REV. ALEXANDER GORDON, M.A. Lecturer on Church History in the University of Manchester.	{ Blandrata; Breus; Buckholdt.
A. H. B.	ARTHUR HENRY BULLEN. Founder of the Shakespeare Head Press, Stratford-on-Avon. Editor of <i>Collection of Old English Plays; Lyrics from the Song Books of the Elizabethan Age; &c.</i>	{ Burton, Robert.
A. H.-S.	SIR A. HOUTUM-SCHINDLER, C.I.E. General in the Persian Army. Author of <i>Eastern Persian Irak</i> .	{ Bushire.
A. H. Sm.	ARTHUR HAMILTON SMITH, M.A., F.S.A. Keeper of the Department of Greek and Roman Antiquities in the British Museum. Member of the Imperial German Archaeological Institute. Author of <i>Catalogue of Greek Sculpture in the British Museum; &c.</i>	{ Brooch.
A. J. G.	REV. ALEXANDER J. GRIEVE, M.A., B.D. Professor of New Testament and Church History, Yorkshire United Independent College, Bradford. Sometime Registrar of Madras University, and Member of Mysore Educational Service.	{ Butler, Bishop (<i>in part</i>).
A. J. L.	ANDREW JACKSON LAMOUREUX. Librarian, College of Agriculture, Cornell University. Editor of the <i>Rio News</i> (Rio de Janeiro), 1879-1901.	{ Bogotá; Bolivia: <i>Geography and Statistics</i> ; Brazil: <i>Geography and Statistics</i> ; Buenos Aires.
A. La.	AUGUSTE LONGNON. Professor at the Collège de France. Director of the École des Hautes Études. Chevalier of the Legion of Honour. Member of the Institute. Author of <i>Géographie de la Gaule au VI. siècle; Documents relatifs au comté de Champagne et de Bris; &c.</i>	{ Blois: <i>Countship of</i> .
A. Ma.	MRS ALICE MEYNELL. Author of <i>Poems; Later Poems; The Rhythm of Life and other Essays; &c.</i>	{ Browning, Elizabeth Barrett.
A. M. C.	MISS AGNES MARY CLERKE. See the biographical article: CLERKE, A. M.	{ Brabe, Tycho.
A. N.	ALFRED NEWTON, F.R.S. See the biographical article: NEWTON, ALFRED.	{ Bunting; Bustard; Buzzard.
A. S. C.	ALAN SUMMERLY COLE, C.B. Formerly Assistant Secretary, Board of Education, South Kensington. Author of <i>Ornament in European Silks; Catalogue of Tapestry, Embroidery, Lace and Egyptian Textiles in Victoria and Albert Museum; &c.</i>	{ Brocade.
A. T. Q.-C.	SIR ARTHUR T. QUILLER-COUCH. See the biographical article: QUILLER-COUCH, Sir A. T.	{ Brown, Thomas Edward.
A. W. H.®	ARTHUR WILLIAM HOLLAND. Formerly Scholar of St John's College, Oxford. Bacon Scholar of Gray's Inn, 1900.	{ Brandenburg: <i>Margravate</i> ; Burdett, Sir Francis.

¹ A complete list, showing all individual contributors, appears in the final volume.

INITIALS AND HEADINGS OF ARTICLES

- A. W. Po.** ALFRED WILLIAM POLLARD, M.A.
Assistant Keeper of Printed Books, British Museum. Fellow of King's College, London. Hon. Secretary, Bibliographical Society. Editor of *Books about Books* and *Bibliographica*. Joint-editor of *The Library*. Chief Editor of the "Globe" *Chaucer*. } **Book;**
 } **Book Collecting.**
- A. W. R.** ALEXANDER WOOD RENTON, M.A., LL.B.
Puisne Judge of the Supreme Court of Ceylon. Editor of *Encyclopaedia of the Law of England*. } **Boarding-House.**
- B. R.** SIR BOVERTON REDWOOD, D.Sc., F.R.S. (Edin.), F.I.C., Assoc.Inst.C.E., M.Inst.M.E.
Adviser on Petroleum to the Admiralty, Home Office, India Office, Corporation of London, and Port of London Authority. President of the Society of Chemical Industry. Member of the Council of the Chemical Society. Member of Council of Institute of Chemistry. Author of *Cantor Lectures on Petroleum; Petroleum and its Products; Chemical Technology; &c.* } **Bitumen.**
- C. B.*** CHARLES BÉMONT, D. ÈS. L., Litt.D. (Oxon.).
See the biographical article: BÉMONT, C. } **Bréquigny**
- C. D.** CYRIL J. H. DAVENPORT, F.S.A.
Assistant to the Keeper of Printed Books, British Museum. Cantor Lecturer on Decorative Bookbindings, Society of Arts. Author of *Royal English Bookbindings; English Embroidered Bookbindings; History of the Book; &c.* } **Bookbinding.**
- C. D. W.** HON. CARROLL DAVIDSON WRIGHT.
See the biographical article: WRIGHT, C. D. } **Building Societies: United States.**
- C. E.*** CHARLES EVERITT, M.A., F.C.S., F.G.S., F.R.A.S.
Formerly Scholar of Magdalen College, Oxford. } **Bone: Industrial.**
- C. E. A.** C. E. AKERS.
Formerly *The Times* Correspondent in Buenos Aires. Author of *A History of South America, 1854-1904*. } **Brazil: History (in part).**
- C. EL** SIR CHARLES NORTON EDDCUMBE ELIOT, K.C.M.G., C.B., M.A., LL.D., D.C.L.
Vice-Chancellor of Sheffield University. Formerly Fellow of Trinity College, Oxford. H.M.'s Commissioner and Commander-in-Chief for the British East Africa Protectorate; Agent and Consul-General at Zanzibar; and Consul-General for German East Africa, 1900-1904. Author of *Turkey in Europe; Letters from the Far East; &c.* } **Bokhara (in part).**
- C. E. S.** HON. CHARLES EMORY SMITH.
See the biographical article: SMITH, CHARLES EMORY. } **Blaine.**
- C. H.** CHARLES HOSE, D.Sc.
Formerly Divisional Resident and Member of the Supreme Council of Sarawak. Author of *A Descriptive Account of the Mammals of Borneo*, and numerous papers in scientific journals. } **Brunel.**
- C. K. S.** CLEMENT KING SHORTER.
Editor of the *Sphere*. Author of *Charlotte Brontë and her Circle; The Brontës: Life and Letters; &c.* } **Brontë, C., E. and A.**
- C. L. K.** CHARLES LETHBRIDGE KINGSFORD, M.A., F.R.HIST.S., F.S.A.
Assistant Secretary to the Board of Education. Author of *Life of Henry V*. Editor of *Chronicles of London* and *Stow's Survey of London*. } **Buckingham, 2nd Duke of.**
- C. PL** CHRISTIAN PRISTER, D. ÈS. L.
Professor at the Sorbonne, Paris. Chevalier of the Legion of Honour. Author of *Étude sur le règne de Robert le Pieux; Le Duché mérovingien d'Alsace et la légende de Saint-Odile*. } **Brunhilda.**
- C. S. S.** CHARLES SCOTT SHERRINGTON, D.Sc., M.D., M.A., LL.D., F.R.S.
Professor of Physiology, University of Liverpool. Foreign Member of Academies of Rome, Vienna, Brussels, Göttingen, &c. Author of *The Integrative Action of the Nervous System*. } **Brain: Physiology.**
- C. W. W.** MAJOR-GENERAL SIR CHARLES WILLIAM WILSON, K.C.B., K.C.M.G., F.R.S., R.E. (1836-1897).
Secretary to the North American Boundary Commission, 1858-1862. British Commissioner on the Servian Boundary Commission. Director-General of the Ordnance Survey, 1886-1894. Director-General of Military Education, 1895-1898. Author of *From Korti to Khartum; Life of Lord Clive; &c.* } **Casarea Nazaca (in part).**
- D. B. Ma.** DUNCAN BLACK MACDONALD, M.A., D.D.
Professor of Semitic Languages, Hartford Theological Seminary, U.S.A. Author of *Development of Muslim Theology, Jurisprudence and Constitutional Theory; Selections from Ibn Khaldun; Religious Attitude and Life in Islam; &c.* } **Bukhârî;**
 } **Cadi.**
- D. C. B.** DEMETRIUS CHARLES BOULGEE.
Author of *History of Belgium; England and Russia in Central Asia; History of China; Life of Gordon; India in the 19th Century; &c.* } **Bruges;**
 } **Brussels.**
- D. C. T.** DAVID CROAL THOMSON.
Formerly Editor of the *Art Journal*. Author of *The Brothers Maris; The Barbizon School of Painters; Life of "Pais"; Life of Bewick; &c.* } **Browne, Hablôt Knight.**
- D. F. T.** DONALD FRANCIS TOVEY.
Balliol College, Oxford. Author of *Essays in Musical Analysis: comprising The Classical Concerts, The Goldberg Variations, and analyses of many other classical works*. } **Boocherini;**
 } **Bruckner.**
- D. EL** DAVID HANNAY.
Formerly British Vice-Consul at Barcelona. Author of *Short History of Royal Navy, 1217-1688; Life of Emilio Castelar; &c.* } **Bouvet; Brenton;**
 } **Brigandage; Euocaneers;**
 } **Byng; Calderon, Rodrigo.**

INITIALS AND HEADINGS OF ARTICLES

vii

D. L. T.	<p>DANIEL LLEUFER THOMAS. Stipendiary Magistrate for Pontypridd and Rhondda. Formerly Assistant Commissioner to the Labour Commission and Secretary to the Welsh Land Commission.</p>	}	<p>Brecon; Caerphilly.</p>
D. Ma.	<p>REV. DUGALD MACFADYEN, M.A. Minister of South Grove Congregational Church, Highgate. Director of the London Missionary Society. Author of <i>Constructive Congregational Ideals</i>.</p>	}	<p>Blakie; Boston, Thomas; Bruce, Alexander Balmain; Cairns, John.</p>
E. Br.	<p>ERNEST BARKER, M.A. Fellow of, and Lecturer in Modern History at, St John's College, Oxford. Formerly Fellow and Tutor of Merton College. Craven Scholar, 1895.</p>	}	<p>Bohamund.</p>
E. Ca.	<p>EGERTON CASTLE, M.A., F.S.A. Trinity College, Cambridge. Author of <i>English Book Plates; Bibliotheca Dimicateria; &c.</i></p>	}	<p>Book Plates.</p>
E. C. B.	<p>RIGHT REV. EDWARD CUTHBERT BUTLER, O.S.B., D.LITT. Abbot of Downside Abbey, Bath.</p>	}	<p>Bridgittines; Brothers of Common Life; Bruno, Saint.</p>
E. Es.	<p>EDMOND ESMONIN.</p>	}	<p>Bombelles, Marc Marie, Marquis de.</p>
E. G.	<p>EDMUND GOSSE, LL.D. See the biographical article: GOSSE, EDMUND</p>	}	<p>Bjornson; Blank Verse; Bouts-Rimés; Bucolies; Busken-Huet.</p>
E. H. C.	<p>ERNEST HARTLEY COLERIDGE, M.A. Balliol College, Oxford. Editor of <i>Byron's Poems; Letters of Samuel Taylor Coleridge; &c.</i></p>	}	<p>Byron.</p>
E. H. B.	<p>SIR EDWARD H. BUNBURY, BART., M.A., F.R.G.S. (d. 1895). M.P. for Bury St Edmunds, 1847-1852. Author of <i>A History of Ancient Geography; &c.</i></p>	}	<p>Bithynia (in part).</p>
E. H. M.	<p>ELLIS HOVELL MINNS, M.A. Lecturer and Assistant Librarian, and formerly Fellow of Pembroke College, Cambridge. University Lecturer in Palaeography.</p>	}	<p>Bosporus Cimmerius; Budini.</p>
E. K.	<p>EDMUND KNECHT, PH.D., F.I.C. Professor of Technological Chemistry, Manchester University. Head of Chemical Department, Municipal School of Technology, Manchester. Examiner in Dyeing, City and Guilds of London Institute. Author of <i>A Manual of Dyeing; &c.</i> Editor of <i>Journal of the Society of Dyers and Colourists</i>.</p>	}	<p>Bleaching.</p>
E. L. B.	<p>EDWARD LIVERMORE BURLINGAME, A.M., PH.D. Editor of <i>Scribner's Magazine</i>. Formerly on Staff of <i>New York Tribune</i>.</p>	}	<p>Brook Farm.</p>
E. Ma.	<p>EDWARD MANSON. Barrister-at-Law, Middle Temple. Joint-editor with Sir John Macdonell, C.B., of the <i>Journal of Comparative Legislation</i>. Author of <i>Law of Trading Companies; &c.</i></p>	}	<p>Bond.</p>
E. O.*	<p>EDMUND OWEN, M.B., F.R.C.S., LL.D., D.Sc. Consulting Surgeon to St Mary's Hospital, London, and to the Children's Hospital, Great Ormond Street. Late Examiner in Surgery at the Universities of Cambridge, Durham and London. Author of <i>A Manual of Anatomy for Senior Students</i>.</p>	}	<p>Bladder and Prostate Diseases; Bone: Medical.</p>
E. Pr.	<p>EDGAR PRESTAGE. Special Lecturer in Portuguese Literature in the University of Manchester. Comendador, Portuguese Order of S. Thiago. Corresponding Member of Lisbon Royal Academy of Sciences, Lisbon Geographical Society, &c. Examiner in Portuguese in the University of London, Manchester, &c.</p>	}	<p>Bocage.</p>
E. Wa.	<p>REV. EDMOND WARRE, M.A., D.D., D.C.L., C.B., C.V.O. Provost of Eton. Hon. Fellow of Balliol College, Oxford. Head Master of Eton College, 1884-1905. Author of <i>Grammar of Rowing; &c.</i></p>	}	<p>Boat.</p>
E. W. B.	<p>SIR EDWARD WILLIAM BRABROOK, C.B. Barrister-at-Law, Lincoln's Inn. Chief Registrar of Friendly Societies, 1891-1904. Author of <i>Building Societies; Provident Societies and Industrial Welfare; Institutions for Thrift; &c.</i></p>	}	<p>Building Societies: United Kingdom.</p>
F. By.	<p>FRANK BRINKLEY. Captain R.N. Foreign Adviser to Nippon Yusen Kaisha, Tokyo. Correspondent of <i>The Times</i> in Japan. Editor of the <i>Japan Mail</i>. Formerly Professor of Mathematics at Imperial Engineering College, Tokyo. Author of <i>Japan; &c.</i></p>	}	<p>Bonin Islands.</p>
F. D. A.	<p>FRANK DAWSON ADAMS, D.Sc., PH.D., F.R.S., F.G.S. Dean of the Faculty of Applied Science, and Logan Professor of Geology, McGill University, Montreal. President of Canadian Mining Institute.</p>	}	<p>British Columbia (in part).</p>
F. G. P.	<p>FREDERICK GYMER PARSONS, F.R.C.S., F.Z.S., F.R.ANTHROP.INST. Vice-President, Anatomical Society of Great Britain and Ireland. Lecturer on Anatomy at St Thomas's Hospital and the London School of Medicine for Women. Formerly Examiner in the Universities of Cambridge, Aberdeen, London and Birmingham; and Hunterian Professor at the Royal College of Surgeons.</p>	}	<p>Brain: Anatomy.</p>
F. H.	<p>FRANCIS HUEFFER, PH.D. (1845-1890). Formerly Musical Critic of <i>The Times</i>. Author of <i>The Troubadours: a History of Provençal Life and Literature in the Middle Ages; Richard Wagner and the Music of the Future</i>. Editor of <i>Great Musicians</i>.</p>	}	<p>Boccaccio.</p>
F. J. C.	<p>SIR FRANCIS J. CAMPBELL, LL.D., F.R.G.S., F.S.A. Principal, Royal Normal College for the Blind, Norwood, London. Author of <i>Papers on the Education of the Blind</i>.</p>	}	<p>Blindness.</p>

INITIALS AND HEADINGS OF ARTICLES

- F. J. H.** FRANCIS JOHN HAVERFIELD, M.A., LL.D., F.S.A.
Camden Professor of Ancient History in the University of Oxford. Fellow of Brasenose College. Fellow of the British Academy. Formerly Censor, Student, Tutor and Librarian of Christ Church, Oxford. Ford's Lecturer, 1906-1907. Author of Monographs on Roman History, especially Roman Britain; &c.
- F. L. G.** FRANCIS LLEWELYN GRIFFITH, M.A., PH.D., F.S.A.
Reader in Egyptology, Oxford University. Editor of the *Archaeological Survey and Archaeological Reports of the Egypt Exploration Fund*. Hon. Member of Imperial German Archaeological Institute, the Société Asiatique, and the Institut Egyptien, Cairo. Author of *Stones of the High Priests of Memphis*; *Catalogue of the Demotic Papyri in the Rylands Collection, Manchester*; &c.
- F. L. L.** LADY LUGARD.
See the biographical article: LUGARD, SIR F. J. D.
- F. R. C.** FRANK R. CANA.
Author of *South Africa from the Great Trek to the Union*.
- F. R. M.** FRANCIS RICHARD MAUNSELL, C.M.G.
Lieut.-Col. R.A. Military Vice-Consul, Sivas, Trebizond, Van (Kurdistan), 1897-1898. Military Attaché, British Embassy, Constantinople, 1901-1905. Author of *Central Kurdistan*; &c.
- F. We.** FREDERICK WEDMORE.
See the biographical article: WEDMORE, F.
- F. W. Ha.** FREDERICK WILLIAM HASLUCK, M.A.
Assistant Director, British School of Archaeology, Athens. Fellow of King's College, Cambridge. Browne's Medallist, 1901.
- F. W. M.** FREDERICK WILLIAM MAITLAND, LL.D.
See the biographical article: MAITLAND, F. W.
- G. A. B.** GEORGE A. BOULENGER, D.Sc., PH.D., F.R.S.
In charge of the Collections of Reptiles and Fishes, Department of Zoology, British Museum. Vice-President of the Zoological Society of London.
- G. E.** REV. GEORGE EDMUNDSON, M.A., F.R.HIST.S.
Formerly Fellow and Tutor of Brasenose College, Oxford. Ford's Lecturer, 1900-1910. Employed by British Government in preparation of the British Case in the British Guiana-Venezuelan and British Guiana-Brazilian boundary arbitrations.
- G. F. Z.** G. F. ZIMMER, A.M.INST.C.E., F.Z.S.
Author of *Mechanical Handling of Material*.
- G. G. P.*** GEORGE GRENVILLE PHILLIMORE, M.A., B.C.L.
Christ Church, Oxford. Barrister-at-Law, Middle Temple.
- G. L. G.** GEORGE LOVELL GULLAND, M.A., M.D., F.R.C.P. (Edin.).
Assistant Physician to the Royal Infirmary, Edinburgh. Lecturer on Medicine at Surgeons' Hall, Edinburgh.
- G. M. D.** GEORGE MERCER DAWSON, LL.D., F.R.S.
Formerly Director of the Geological Survey of Canada. Geologist and Naturalist to H.M. North American Boundary Commission, 1873-1875; one of H.M. Bering Sea Commissioners, 1891. Author of numerous scientific and technical reports printed by the Canadian Government.
- G. T. G.** SIR GEORGE D. TAUBMAN GOLDIE.
See the biographical article: GOLDIE, SIR G. D. T.
- G. W. Ca.** GEORGE WASHINGTON CABLE.
See the biographical article: CABLE, G. W.
- G. W. T.** REV. GRIFFITHS WHEELER THATCHER, M.A., B.D.
Warden of Camden College, Sydney, N.S.W. Formerly Tutor in Hebrew and Old Testament History at Mansfield College, Oxford.
- H. Br.** HENRY BRADLEY, M.A., PH.D.
Joint-editor of the *New English Dictionary (Oxford)*. Fellow of the British Academy. Author of *The Story of the Goths*; *The Making of English*; &c.
- H. Ch.** HUGH CHISHOLM, M.A.
Formerly Scholar of Corpus Christi College, Oxford. Editor of the 11th Edition of the *Encyclopaedia Britannica*. Co-editor of the 10th edition.
- H. Cl.** SIR HUGH CHARLES CLIFFORD, K.C.M.G.
Colonial Secretary, Ceylon. Fellow of the Royal Colonial Institute. Formerly Resident, Pahang. Colonial Secretary, Trinidad and Tobago, 1903-1907. Author of *Studies in Brown Humanity*; *Further India*; &c. Joint-author of *A Dictionary of the Malay Language*.
- H. De.** REV. HIPPOLYTE DELEHAYE, S.J.
Bollandist. Joint-editor of the *Acta Sanctorum*.
- H. Fr.** HENRI FRANTZ.
Art Critic, *Gazette des Beaux Arts (Paris)*.
- H. H. J.** SIR HENRY HAMILTON JOHNSTON, K.C.B., G.C.M.G.
See the biographical article: JOHNSTON, SIR H. H.
- H. M. C.** HECTOR MUNRO CHADWICK, M.A.
Fellow and Librarian of Clare College, Cambridge. Author of *Studies on Anglo-Saxon Institutions*.
- Bondicea;**
Britain: Pre-Roman and Roman;
Roman;
Caerleon; Caedonia.
- Bubastis;**
Busris;
Buto.
- Bornu;**
British Empire.
- British East Africa.**
- Bitlis.**
- Boudin.**
- Bithynia (in part).**
- Braeton.**
- Caecilia.**
- Bolivia: History (in part);**
Brabant: Ducky;
Brazil: History (in part).
- Bread.**
- Burial and Burial Acts.**
- Blood: Pathology of the.**
- British Columbia (in part).**
- Brazza, Count de.**
- Bryant, William Cullen.**
- Buhuri;**
Bisairl.
- Caedmon.**
- Boulanger;**
Bridgman, Laura D.
- Borneo.**
- Bollandists.**
- Böcklin;**
Bonheur, Rosa.
- British Central Africa.**
- Britain: Anglo-Saxon.**

H. P. B.	HENRY PERCIVAL BIGGAR Author of <i>The Voyages of the Cabots to Greenland</i> .	{ Cabot, John.
H. S. J.	HENRY STUART JONES, M.A. Formerly Fellow and Tutor of Trinity College, Oxford, and Director of the British School at Rome. Member of the German Imperial Archaeological Institute. Author of <i>The Roman Empire</i> , &c.	{ Caesar, Julius.
H. W. C. D.	HENRY WILLIAM CARLESS DAVIS, M.A. Fellow and Tutor of Balliol College, Oxford. Fellow of All Souls' College, Oxford, 1895-1902. Author of <i>Charlemagne, England under the Normans and Angevins</i> ; &c.	{ Bohun; Brautó, Falkes de; Burgh, Hubert de.
H. W. S.	H. WICKHAM STEED. Correspondent of <i>The Times</i> at Rome (1897-1902) and Vienna.	{ Bonghi, Ruggero.
J. A. F. M.	JOHN ALEXANDER FULLER MAITLAND, M.A., F.S.A. Musical Critic of <i>The Times</i> . Author of <i>Life of Schumann; The Musician's Pilgrimage; Masters of German Music; English Music in the Nineteenth Century; The Age of Bach and Handel</i> . Editor of the new edition of Grove's <i>Dictionary of Music and Musicians</i> ; &c.	{ Brahms.
J. A. H.	JOHN ALLEN HOWE, B.Sc. Curator and Librarian, Museum of Practical Geology, London.	{ Bunter; Cainozoic.
J. A. M.	JAMES ALEXANDER MANSON. Formerly Literary Editor of the <i>Daily Chronicle</i> . Author of <i>The Bowler's Handbook</i> ; &c.	{ Bowls.
J. B.*	JOSEPH BURTON. Partner in Pilkington's Tile and Pottery Co., Clifton Junction, Manchester.	{ Brick (in part).
J. B.	JAMES BARTLETT. Lecturer on Construction, Architecture, Sanitation, Quantities, &c., King's College, London. Member of Society of Architects, Institute of Junior Engineers, Quantity Surveyors' Association. Author of <i>Quantities</i> .	{ Brickwork; Building.
J. C. C.	J. W. COMYNS-CARR. Author of <i>Essays on Art</i> ; &c.	{ Blake, William.
J. D. B.	JAMES DAVID BOURCHIER, M.A., F.R.G.S. Correspondent of <i>The Times</i> in South-Eastern Europe. Commander of the Orders of Prince Danilo of Montenegro and of the Saviour of Greece, and Officer of the Order of St Alexander of Bulgaria.	{ Bulgaria.
J. E.	H. JULIUS EGGELENG, PH.D. Professor of Sanskrit and Comparative Philology, Edinburgh University. Formerly Secretary and Librarian to Royal Asiatic Society.	{ Brahman; Brāhman; Brahmanism.
J. F.-K.	JAMES FITZMAURICE-KELLY, LITT.D., F.R.HIST.S. Gilmour Professor of Spanish Language and Literature, Liverpool University. Norman MacColl Lecturer, Cambridge University. Fellow of the British Academy. Knight Commander of the Order of Alphonso XII. Author of <i>A History of Spanish Literature</i> ; &c.	{ Breton de los Herreros; Caballero; Calderon de la Barca.
J. G. C. A.	JOHN GEORGE CLARK ANDERSON, M.A. Censor and Tutor of Christ Church, Oxford. Formerly Fellow of Lincoln College. Craven Fellow (Oxford), 1896. Conington Prizeman, 1893.	{ Caesarea Mazaca (in part).
J. G. H.	JOSEPH G. HORNER, A.M.I.MECH.E. Author of <i>Plating and Boiler Making; Practical Metal Turning</i> ; &c.	{ Boiler; Boiler-making; Brasing and Soldering.
J. G. Sc.	SIR JAMES GEORGE SCOTT, K.C.I.E. Superintendent and Political Officer, Southern Shan States. Author of <i>Burma; The Upper Burma Gazetteer</i> .	{ Burma.
J. H. R.	JOHN HORACE ROUND, M.A., LL.D. (Edin.). Author of <i>Feudal England; Studies in Peerage and Family History; Peerage and Pedigree</i> ; &c.	{ Burgh.
J. H. R.	JOHN HOLLAND ROSE, M.A., LITT.D. Christ's College, Cambridge. Lecturer on Modern History to the Cambridge University Local Lectures Syndicate. Author of <i>Life of Napoleon I.; Napoleonic Studies; The Development of the European Nations; The Life of Pitt</i> ; &c.	{ Bonaparte: Family (in part). Bourrienne.
J. J.*	JOSEPH JEFFERSON. See the biographical article: JEFFERSON, J.	{ Booth, Edwin.
J. M. M.	JOHN MALCOLM MITCHELL. Sometime Scholar of Queen's College, Oxford. Lecturer in Classics, East London College (University of London). Joint-editor of Grote's <i>History of Greece</i> .	{ Bouff; Bruno, Giordano (in part).
J. Mo.	VISCOUNT MORLEY OF BLACKBURN. See the biographical article: MORLEY, VISCOUNT.	{ Burke, Edmund.
J. N.	JOHN NICHOL. See the biographical article: NICHOL, JOHN.	{ Burns, Robert.
J. P.-B.	JAMES GEORGE JOSEPH PENDEREL-BRODHURST. Editor of the <i>Guardian</i> (London).	{ Bookcase; Boule; Cabinet: Furniture.
J. P. Pa.	REV. JOHN PUNNETT PETERS, PH.D., D.D. Canon Residentiary, Cathedral of New York. Formerly Professor of Hebrew in the University of Pennsylvania. Director of the University Expedition to Babylonia, 1888-1895. Author of <i>Nippur, or Explorations and Adventures on the Euphrates; Scriptures, Hebrew and Christian</i> .	{ Bamyas; Borsippa; Calah.

INITIALS AND HEADINGS OF ARTICLES

- J. S. F.** JOHN SMITH FLETT, D.Sc., F.G.S.
Petrographer to the Geological Survey Formerly Lecturer on Petrology in Edinburgh University. Neil Medallist of the Royal Society of Edinburgh. Bigsby Medallist of the Geological Society of London.
- J. T. M.** JAMES TAYLER MILTON, M.I.C.E.
Chief Engineer Surveyor to Lloyd's Registry of Shipping. Vice-President, Institute of Naval Architects. Member of Council, Institute of Marine Engineers. Author of many papers on Marine Engineering subjects.
- J. T. S.*** JAMES THOMSON SHOTWELL, PH D
Professor of History in Columbia University, New York City.
- J. W. D.** CAPTAIN J. WHITLY DIXON, R.N.
Nautical Assessor to Court of Appeal since 1906. Formerly Staff Commander, Medway Fleet Reserve.
- J. W. Ho.** JAMES WYCLIFFE HEADLAM, M.A.
Staff Inspector of Secondary Schools under the Board of Education. Formerly Fellow of King's College, Cambridge. Professor of Greek and Ancient History at Queen's College, London. Author of *Bismarck and the Foundation of the German Empire*, &c.
- K. G. J.** KINGSLEY GARLAND JAYNE.
Sometime Scholar of Wadham College, Oxford. Matthew Arnold Prizeman, 1903. Author of *Vasco da Gama and his Successors*.
- K. J.** A. KEITH JOHNSTON
See the biographical article: JOHNSTON, A. K.
- K. S.** KATHLEEN SCHLESINGER.
Author of *The Instruments of the Orchestra*, &c.
- L.** COUNT LÜTZOW, LITT.D. (Oxon.), Ph.D. (Prague), F.R.G.S.
Chamberlain of H.M. the Emperor of Austria, King of Bohemia. Hon. Member of the Royal Society of Literature. Member of the Bohemian Academy, &c. Author of *Bohemia: A Historical Sketch*; *The Historians of Bohemia* (Ilchester Lecture, Oxford, 1904); *The Life and Times of John Hus*; &c.
- L. B.** LAURENCE BINYON.
See the biographical article: BINYON, L.
- L. D.*** LOUIS DUCHESNE.
See the biographical article: DUCHESNE, L. M. O.
- L. F. S.** LESLIE FREDERIC SCOTT, K.C., M.A.
New College, Oxford. Joint Hon. Secretary of International Maritime Committee.
- L. F. V.-H.** LEVESON FRANCIS VERNON-HARCOURT, M.A., M.INST.C.E. (1839-1907).
Professor of Civil Engineering at University College, London, 1882-1905. British Member of Jury for Civil Engineering, Paris Exhibition, 1900. Author of *Rivers and Canals*; *Harbours and Docks*; *Civil Engineering as Applied in Construction*; &c.
- L. G.** LAURENCE GINNELL, M.P.
Barrister, Middle Temple and Irish Bar. Author of *Brehon Laws*; *Land and Liberty*; &c. M.P. for North Westmeath since 1906.
- L. J. S.** LEONARD JAMES SPENCER, M.A.
Assistant in Department of Mineralogy, Natural History Museum, South Kensington. Formerly Scholar of Sidney Sussex College, Cambridge, and Harkness Scholar. Editor of the *Mineralogical Magazine*. Author of English translations of M. Bauer's *Precious Stones* and R. Brauns's *Mineral Kingdom*.
- L. R. D.** LAWRENCE ROBERT DICKSEE, M.Com. (Birmingham), F.C.A.
Lecturer, London School of Economics and Political Science. Formerly Professor of Accounting at Birmingham University. Author of *Auditing*; *Advanced Accounting*; *Book-keeping*; &c.
- L. S.** SIR LESLIE STEPHEN, K.C.B.
See the biographical article: STEPHEN, SIR L.
- L. V.*** LUIGI VILLARI.
Italian Foreign Office (Emigration Department). Formerly Newspaper Correspondent in East of Europe. Italian Vice-Consul in New Orleans, 1906; Philadelphia, 1907; and Boston, U.S.A., 1907-1910. Author of *Italian Life in Town and Country*; *Giovanni Segantini*; *Russia under the Great Shadow*; *Fire and Sword in the Caucasus*; &c.
- M.** LORD MACAULAY.
See the biographical article: MACAULAY, T. B. M., BARON.
- M. Bat.** MISS MARY BATESON (1865-1906).
Formerly Fellow of Newnham College, Cambridge. Author of *Medieval England*; *Borough Customs*; &c.
- M. Br.** MISS MARGARET BEYANT.
- M. G.** MOSES GASTEE, Ph.D. (Leipzig).
Chief Rabbi of the Sephardic Communities of England. Vice-President, Zionist Congress, 1898, 1899, 1900. Ilchester Lecturer at Oxford on Slavonic and Byzantine Literature, 1886 and 1891. President, Folklore Society of England. Vice-President, Anglo-Jewish Association. Author of *History of Rumanian Popular Literature*; *A New Hebrew Fragment of Ben-Sira*; *The Hebrew Version of the Secretum Secretorum of Aristotle*.
- Borohante; Brooca.**
- Boller.**
- Boniface, Saint.**
- Buoy; Cable.**
- Bismarck; Bucher, Lothar.**
- Bosnia and Herzegovina; British Honduras.**
- Brazil: History (in part).**
- Bombardon; Bow; Buccina; Bugle; Bumbulum.**
- Bohemia: History and Literature.**
- Burne-Jones, Sir E. B.**
- Boniface (Popes L-VII).**
- Broker.**
- Breakwater; Caisson.**
- Brehon Laws.**
- Bismuthite; Blende; Borsacite; Bournonite; Brochantite; Brookite; Bronzite; Brookite; Brucite; Bytownite; Calamine; Calcite.**
- Book-keeping.**
- Browning, Robert.**
- Borgia, Cesare; Borgia, Lucrezia; Cagliostro.**
- Bryan, John.**
- Borough: English.**
- Caesar: Medieval Legends.**
- Bogomils; Brancovan.**

- M. P.*** LEON JACQUES MAXIME PRINET.
Formerly Archivist to the French National Archives. Auxiliary of the Institute of France (Academy of Moral and Political Sciences). Author of *L'Industrie du sel en Franche-Comté*; *Les Armoiries écartelées des conjoints*; *François I et le comté de Bourgogne*.
- M. S. J.** MOLYNEUX ST JOHN.
- L. W. T.** NORTHCOTE WHITEBRIDGE THOMAS, M.A.
Government Anthropologist to Southern Nigeria. Corresponding Member of the Société d'Anthropologie de Paris. Author of *Thought Transference*; *Kinship and Marriage in Australia*; &c.
- O. Ba.** OSWALD BARRON, F.S.A.
Hon. Genealogist to Standing Council of the Honourable Society of the Baronetage. Editor of the *Ancestor*, 1902-1903.
- O. Br.** OSCAR BRILLIANT.
- O. H.** OLAVS MAGNUS FRIEDRICH HENRICI, PH.D., LL.D., F.R.S.
Professor of Mechanics and Mathematics in the Central Technical College of the City and Guilds of London Institute. Author of *Vectors and Rotors*; *Congruent Figures*; &c.
- P. A. K.** PRINCE PETER ALEXEIVITCH KROPOTKIN.
See the biographical article: KROPOTKIN, P. A.
- P. C. M.** PETER CHALMERS MITCHELL, M.A., D.Sc., LL.D., F.R.S.
Secretary to the Zoological Society of London. University Demonstrator in Comparative Anatomy and Assistant to Linacre Professor at Oxford, 1888-1891. Lecturer on Biology at Charing Cross Hospital, 1892-1894; at London Hospital, 1894. Examiner in Biology to the Royal College of Physicians, 1892-1896, 1901-1903. Examiner in Zoology to the University of London, 1903.
- P. C. Y.** PHILIP CHESNEY YORKE, M.A.
Magdalen College, Oxford.
- P. GL.** PETER GILES, M.A., LL.D., LITT.D.
Fellow and Classical Lecturer of Emmanuel College, Cambridge, and University Reader in Comparative Philology. Late Secretary of the Cambridge Philological Society. Author of *Manual of Comparative Philology*; &c.
- P. G. K.** PAUL G. KONODY.
Art Critic of the *Observer* and the *Daily Mail*. Formerly Editor of the *Artist*. Author of *The Art of Walter Crane*; *Velasquez, Life and Work*; &c.
- P. S.** PHILIP SCHIDROWITZ, PH.D., F.C.S.
Member of Council, Institute of Brewing. Member of Committee of Society of Chemical Industry. Author of numerous articles on the Chemistry and Technology of Brewing, Distilling, &c.
- P. W. G.** PETER WILLIAM CLAYDEN (d. 1902).
Formerly President, Institute of Journalists, London. Literary Editor of the *Daily News*. Author of *Scientific Men and Religious Teachers*; *England under Lord Beaconsfield*; *Early Life of Samuel Rogers*; *Rogers and his Contemporaries*; *England under the Coalition*; &c.
- R. A.*** ROBERT ANCHEL.
Archivist to the Department de l'Eure.
- R. Ad.** ROBERT ADAMSON, LL.D.
See the biographical article: ADAMSON, R.
- R. A. S. M.** ROBERT ALEXANDER STEWART MACALISTER, M.A., F.S.A.
St John's College, Cambridge. Director of Excavations for the Palestine Exploration Fund.
- R. G.** RICHARD GARNETT, LL.D.
See the biographical article: GARNETT, R.
- R. I. P.** R. I. POCOCK, F.Z.S.
Superintendent of the Zoological Gardens, London.
- R. J. M.** RONALD JOHN McNHILL, M.A.
Christ Church, Oxford. Barrister-at-Law. Formerly Editor of *St James's Gazette*, London.
- R. L.*** RICHARD LYNDEKKE, F.R.S., F.L.S.
Member of Staff of Geological Survey of India, 1874-1882. Author of *Catalogues of Fossil Mammals, Reptiles and Birds in British Museum*; &c.
- R. M. B.** ROBERT NISSET BAIN (d. 1909).
Assistant Librarian, British Museum, 1883-1909. Author of *Scandinavia: the Political History of Denmark, Norway and Sweden, 1513-1900*; *The First Romanovs, 1613 to 1725*; *Slavonic Europe: the Political History of Poland and Russia from 1490 to 1796*; &c.
- Brianne-le-Château;
Brienne, Duke of.
- British Columbia: (*in part*).
- Boomerang.
- Butler: *Family*.
- Bohemia: *Geography and Statistics*; Budapest.
- Calculating Machines.
- Bokhara: (*in part*);
Bulgaria: *Eastern*.
- Breeds and Breeding.
- Boleyn, Anne; Bollingbroke;
Bothwell;
Bristol, 1st and 2nd Maris of;
Buckingham, 1st Duke of
(*in part*);
Buckingham, 2nd Duke of.
- C.
- Bordone.
- Brandy;
Brewing.
- Bright, John.
- Boissy D'Anglais, François
Antoine de.
- Bonaventura, Saint;
Bruno, Giordano (*in part*);
Butler, Bishop (*in part*).
- Bozrah;
Caesarea Palaestina;
Caesarea Philippi.
- Burton, John HILL.
- Book-Scorpion;
Caddis-Fly and Caddis-Worm.
- Bunker HILL.
- Blson;
Bovidae;
Buffalo.
- Bockay, Stephen;
Boris Fedorovich Godunov;
Boyar; Brahe, Per;
Busiaev, Fedor Ivanovich.

- R. P.*** ROBERT PEELE.
Professor of Mining in Columbia University, New York. { **Blasting;**
Boring.
- R. Po.** RENÉ POUPARDIN, D. ÈS L.
Secretary to the École des Chartes. Honorary Librarian to the Bibliothèque Nationale. Author of *Le Royaume de Bourgogne; Le Royaume de Provence sous les Carolingiens; &c.* { **Burgundy.**
- S. A. G.** STANLEY ARTHUR COOK, M.A.
Lecturer in Hebrew and Syriac, and formerly Fellow, Gonville and Caius College, Cambridge. Editor for Palestine Exploration Fund. Examiner in Hebrew and Aramaic. London University, 1904-1908. Council of Royal Asiatic Society, 1904-1905. Author of *Glossary of Aramaic Inscriptions; The Laws of Moses and the Code of Hammurabi; Critical Notes on Old Testament History; Religion of Ancient Palestine; &c.* { **Cain;**
Caleb.
- S. G.** SIDNEY COLVIN, M.A., LITT.D.
See the biographical article: COLVIN, SIDNEY. { **Botticelli.**
- St G.** VISCOUNT ST CYRES.
See the biographical article: IDDESLEIGH: 1ST EARL OF. { **Bossuet.**
- S. H. V.*** SYDNEY HOWARD VINES, M.A., D.Sc., F.R.S., F.L.S.
Sherardian Professor of Botany, Oxford University. Fellow of Magdalen College. Author of *Lectures on the Physiology of Plants; Text-Book of Botany; &c.* { **Brongniart, Adolphe**
Theodore.
- S. L.-P.** STANLEY LANE-POOLE, M.A., LITT.D.
Formerly Professor of Arabic, Dublin University, and Examiner in the University of Wales. Corresponding Member of the Imperial Russian Archaeological Society. Member of the Khedivial Commission for the Preservation of the Monuments of Arab Art, &c. Author of *Life of Lord Strafford de Redcliffe; Life of Sir Harry Parkes; Cairo; Turkey; &c.* Editor of *The Koran; The Thousand and One Nights; &c.* { **Burton, Sir Richard Francis.**
- S. R. G.** SAMUEL RAWSON GARDINER, LL.D., D.C.L.
See the biographical article: GARDINER, S. R. { **Buckingham, 1st Duke of (in part).**
Bologna; Bolsena; Bononia;
Borgo San Donnino;
Bovianum; Bovillae;
Bracciano; Brescia;
Brindisi; Brundisium;
Bruttii; Caere; Cagli;
Cagliari; Calatae Portus;
Calabria.
- T. AS.** THOMAS ASHEY, M.A., D.LITT. (OXON).
Director of British School of Archaeology at Rome. Member of the Imperial German Archaeological Institute. Formerly Scholar of Christ Church, Oxford. Craven Fellow, 1897. Conington Prize-man, 1906. Author of *The Classical Topography of the Roman Campagna.*
- T. Ba.** SIR THOMAS BARCLAY, M.P.
Member of the Institute of International Law. Member of the Supreme Council of the Congo Free State. Officer of the Legion of Honour. Author of *Problems of International Practice and Diplomacy; &c.* M.P. for Blackburn, 1910. { **Blockade.**
- T. G. Br.** THOMAS GREGOR BRODIE, M.D., F.R.S.
Professor of Physiology in the University of Toronto. Author of *Essentials of Experimental Physiology.* { **Blood: Anatomy and Physiology.**
- T. H. H.*** SIR THOMAS HUNGERFORD HOLDICH, K.C.M.G., K.C.I.E., D.Sc.
Superintendent, Frontier Surveys, India, 1892-1898. Gold Medallist, R.G.S., London, 1887. Author of *The Indian Borderland; The Countries of the King's Award; India; Tibet; &c.* { **Bolan Pass;**
Brahmaputra.
- T. So.** THOMAS SECCOMBE, M.A.
Lecturer in History, East London and Birkbeck Colleges, University of London. Stanhope Prize-man, Oxford, 1887. Assistant Editor of *Dictionary of National Biography*, 1891-1901. Author of *The Age of Johnson; &c.* { **Boswell.**
- T. W.-D.** THEODORE WATTS-DUNTON.
See the biographical article: WATTS-DUNTON, T. { **Borrow.**
- T. W. H. D.** T. W. REYS DAVIDS, LL.D., PH.D.
Professor of Comparative Religion, Manchester University. President of the Pali Text Society. Fellow of the British Academy. Secretary and Librarian of Royal Asiatic Society, 1885-1902. Author of *Buddhism; Sacred Books of the Buddhists; Early Buddhism; Buddhist India; Dialogues of the Buddha; &c.* { **Buddha;**
Buddhaghosa;
Buddhism.
- W. A. B. G.** REV. WILLIAM AUGUSTUS BREVOORT COOLIDGE, M.A., F.R.G.S., Ph.D. (Bern).
Fellow of Magdalen College, Oxford. Professor of English History, St David's College, Lampeter, 1880-1881. Author of *Guide du Haut Dauphiné, The Range of the Tâdi; Guide to Grindelwald; Guide to Switzerland; The Alps in Nature and in History; &c.* Editor of the *Alpine Journal*, 1880-1889, &c. { **Bitzins; Blanc, Mont;**
Bonstetten; Bolzen;
Bourrit; Bregenz;
Brenner Pass; Briançon;
Brieg; Brienz, Lake of;
Brignoles; Brixen;
Burekhardt, Jakob; Burgdorf
- W. A. P.** WALTER ALISON PHILLIPS, M.A.
Formerly Exhibitioner of Merton College and Senior Scholar of St John's College, Oxford. Author of *Modern Europe; &c.* { **Bishop;**
Brunhild.
- W. B.*** WILLIAM BURTON, M.A., F.C.S.
Chairman, Joint Committee of Pottery Manufacturers of Great Britain. Author of *English Stoneware and Earthenware; &c.* { **Brick (in part).**
- W. B. S.*** WILLIAM BARCLAY SQUIRE, M.A., F.S.A., F.R.G.S.
Assistant in charge of Printed Music, British Museum. Hon. Secretary of the Purcell Society. Formerly Musical Critic of *Westminster Gazette, Saturday Review* and *Globe.* Editor of *Byrd's Masses.* { **Byrd.**

W. C. S.	WILLIAM CHARLES SMITH, K.C., M.A., LL.D. Formerly Sheriff of Ross, Cromarty and Sutherland. Editor of <i>Judicial Review</i> , 1889-1900.	{ Borough: Irish and Scottish.
W. G. U.	WILLIAM CAWTHORNE UNWIN, LL.D., F.R.S., M.INST.C.E., M.INST.M.E., A.R.I.B.A. Emeritus Professor of Engineering, Central Technical College, City and Guilds of London Institute. Author of <i>Wrought Iron Bridges and Roofs; Treatise on Hydraulics</i> .	{ Bridges.
W. Hd.	WILFRANC HUBBARD. Correspondent of <i>The Times</i> in Rome.	{ Bolivia: History (in part).
W. H. L.	WILLIAM H. LANG, D.Sc. Barker Professor of Cryptogamic Botany, University of Manchester. Author of Papers on Botanical Subjects, including Morphology and life history of Bryophyta, Pteridophyta and Gymnosperms, in scientific journals.	{ Bryophyta.
W. H. W.	WILLIAM HENRY WHITFIELD, M.A. Trinity College, Cambridge. Card Editor of the <i>Field</i> .	{ Bridge: Goss.
W. J. H.*	W. J. HUGHAN. Past Senior Grand Deacon of Freemasons of England, 1874. Hon. Senior Warden of Grand Lodges of Egypt, Quebec and Iona, &c.	{ Builders' Rites.
W. L.	RIGHT REV. WILLIAM LAWRENCE, D.D., LL.D. Bishop of Massachusetts. Author of <i>Study of Phillips Brooks; Life of Roger Wolcott; &c.</i>	{ Brooks, Phillips.
W. L. G.	WILLIAM LAWSON GRANT, M.A. Professor of Colonial History, Queen's University, Kingston, Canada. Formerly Beit Lecturer in Colonial History, Oxford University. Editor of <i>Acts of the Privy Council</i> (Canadian Series).	{ Brook, Sir Isaac; Brown, George.
W. L. R. C.	WILLIAM LIEST READWIN CATES (1821-1895). Editor of <i>Dictionary of General Biography</i> . Author of <i>A History of England from the Death of Edward the Confessor to the Death of King John</i> . Part author of <i>Encyclopaedia of Chronology</i> .	{ Boscovich.
W. M. E.	WILLIAM MICHAEL ROSSETTI. See the biographical article: ROSSETTI, DANTE GABRIEL.	{ Brown, Ford Madox.
W. R. L.	W. R. LETHABY, F.S.A. Principal of the Central School of Arts and Crafts under the London County Council. Author of <i>Architecture, Mysticism and Myth; &c.</i>	{ Byzantine Art.
W. S. J.	WILLIAM STANLEY JEVONS, LL.D. See the biographical article: JEVONS, WILLIAM STANLEY.	{ Books.
W. Wt.	WILLISTON WALKER, Ph.D., D.D. Professor of Church History, Yale University. Author of <i>History of the Congregational Churches in the United States; The Reformation; John Calvin; &c.</i>	{ Bushnell, Horace.
W. W. F.*	WILLIAM WARDE FOWLER, M.A. Fellow of Lincoln College, Oxford. Sub-Rector, 1881-1904. Gifford Lecturer, Edinburgh University, 1908. Author of <i>The City-States of the Greeks and Romans; The Roman Festivals of the Republican Period; &c.</i>	{ Bona Dea.
W. W. R.*	WILLIAM WALKER ROCKWELL, LIC. THEOL. Assistant Professor of Church History, Union Theological Seminary, New York.	{ Boniface (Pope VIII-IX.).

PRINCIPAL UNSIGNED ARTICLES

Elizabeth.	Boric Acid.	Breconshire.	Bryan, William J.	Burnet, Gilbert.
Eizec, Georges.	Boron.	Bremen.	Buchanan, George.	Burney, Charles.
Black Sea.	Bortomeo.	Breslau.	Buchanan, James.	Burr, Aaron.
Blackstone.	Boston.	Brest.	Bucharest.	Bushman.
Baba, Robert.	Botevidas.	Bretschneider.	Buckingham, Earls.	Bute.
Banc, Louis.	Bottomry.	Breviary.	Marquesses and	Butler, Benjamin
Barophany.	Bougareva.	Brewster, Sir David.	Dukes of.	Franklin.
Banheim.	Bourbon.	Bribery.	Buckinghamshire.	Butler, Samuel.
Baroque.	Bourges.	Brisbane.	Buckle.	Button.
Bäcker.	Bourget.	Bristol.	Budget.	Buxton.
Bäckerhäll.	Bow-Log.	Brittany.	Buffalo, U.S.A.	Buxton, Johannes.
Beck.	Bowling.	Broglio, de.	Buffon, G. L. K., Comte	Byzantium.
Beckma.	Bowring, Sir John.	Bromine.	de.	Cabbage.
Beccia.	Boxing.	Bronchitis.	Bull-Fighting.	Cabinet (Political).
Beccia.	Boyle, Robert.	Bronze.	Bull Run.	Cactus.
Beccia-Despraux.	Bracelet.	Brooks, Fuks Greville.	Edlow, Prince von.	Cairnes, Prof. Elliot.
Belvar.	Brackley.	Brooks, Sir James.	Bunsen, C. C. J., Baron	Cairo.
Bombay.	Bradford.	Brooklyn.	von.	Cairns Disease.
Bona.	Bradlaugh, Charles.	Brougham.	Bunsen, Robert Wilhelm	Calfness.
Bonnet, Charles.	Brahma Samaj.	Brown, John.	von.	Calabar Bean.
Bookbinding.	Braka.	Browne, Sir Thomas.	Burdett-Goutts,	Calcutta.
Bopp.	Brandes.	Brunel.	Baroness.	Calcutta.
Boraginaceae.	Brassy.	Brunswick.	Burgary.	
Bordeaux.	Breadalbane.	Brush.	Burgos.	
Borders, Tho.	Bread-Fruit.	Brutus.	Burmeso Wars.	

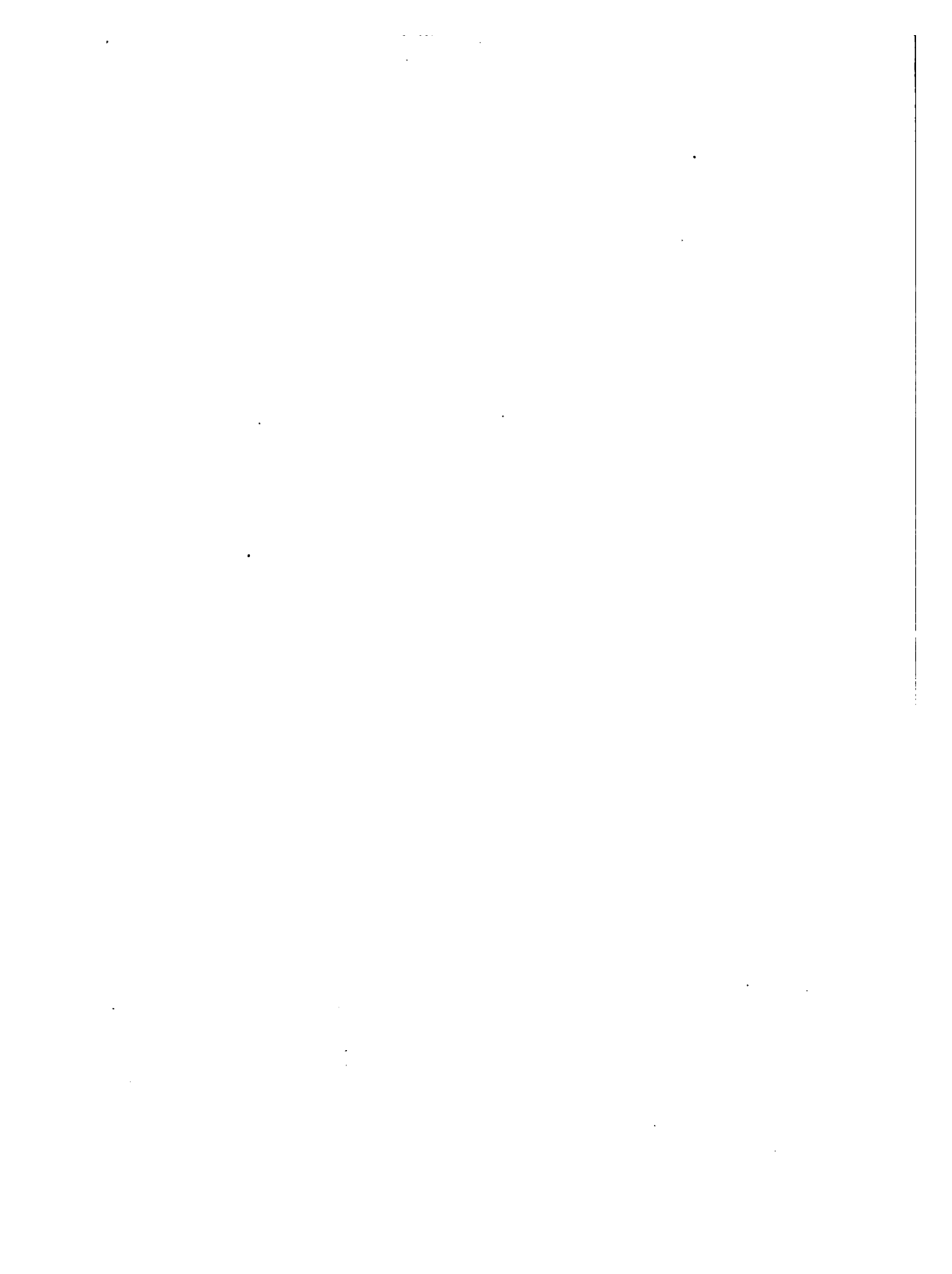

ENCYCLOPÆDIA BRITANNICA

ELEVENTH EDITION

VOLUME IV

BEKHARIN (the anc. *Ichthyophagi*), a nomad tribe of African "Arabs," of Hamitic origin, dwelling in the eastern part of the Nubian desert. In the middle ages they were known as Beja (g.n.), and they are the most characteristic of the Nubian "Arabs." With the Ababda and Hadendoa they represent the Elemmys of classical writers. Linguistically and geographically the Bekharin form a connecting link between the Hamitic populations and the Egyptians. Nominally they are Mahomedans. They, however, preserve some non-Islamic religious practices, and exhibit traces of animal-worship in their rule of never killing the serpent or the partridge, which are regarded as sacred.

BISHOP, SIR HENRY ROWLEY (1786-1855), English musical composer, was born in London on the 18th of November 1786. He received his artistic training from Francisco Bianchi, and in 1804 wrote the music to a piece called *Angelina*, which was performed at Margate. His next composition was the music to the ballet of *Tamerlan et Bajazet*, produced in 1806 at the King's theatre. This proved successful, and was followed within two years by several others, of which *Caractacus*, a pantomimic ballet, written for Drury Lane, may be named. In 1809 his first opera, *The Circassian's Bride*, was produced at Drury Lane; but unfortunately the theatre was burned down after one performance, and the score of the work perished in the flames. His next work of importance, the opera of *The Maniac*, written for the Lyceum in 1810, established his reputation, and probably secured for him an appointment for three years as composer for Covent Garden theatre. The numerous works—operas, burlettas, cantatas, incidental music to Shakespeare's plays, &c.—which he composed while in this position, are in great part forgotten. The most successful were—*The Virgin of the Sun* (1812), *The Miller and his Men* (1813), *Guy Mannering* and *The Slave* (1816), *Maid Marian* and *Clari*, introducing the well-known air of "Home, Sweet Home" (1822). In 1825 Bishop was induced by Elliston to transfer his services from Covent Garden to the rival house in Drury Lane, for which he wrote with unusual care the opera of *Aladdin*, intended to compete with Weber's *Oberon*, commissioned by the other house. The result was a failure, and with *Aladdin* Bishop's career as an operatic composer may be said to close. On the formation of the Philharmonic Society (1813) Bishop was appointed one of the directors, and he took his turn as conductor of its concerts during the period when that office was held by different musicians in rotation. In 1830 he was appointed musical director at Vauxhall; and it was in the course of this engagement that he wrote the popular song "My Pretty Jane." His sacred cantata, *The Seventh Day*, was written for the Philharmonic Society and performed in 1833. In 1839 he was made bachelor in music at Oxford. In 1841 he was appointed to the Reid chair of music in the university of Edinburgh, but

he resigned the office in 1843. He was knighted in 1842, being the first musician who ever received that honour. In 1848 he succeeded Dr Crotch in the chair of music at Oxford. The music for the ode on the occasion of the installation of Lord Derby as chancellor of the university (1853) proved to be his last work. He died on the 30th of April 1855 in impoverished circumstances, though few composers ever made more by their labours. Bishop was twice married: to Miss Lyon and Miss Anne Rivière. Both he and his wives were singers. His name lives in connexion with his numerous glees, songs and smaller compositions. His melodies are clear, flowing, appropriate and often charming; and his harmony is always pure, simple and sweet.

BISHOP, ISABELLA (1832-1904), English traveller and author, daughter of the Rev. Edward Bird, rector of Tattenhall, Cheshire, was born in Yorkshire on the 15th of October 1832. Isabella Bird began to travel when she was twenty-two. Her first book, *The Englishwoman in America* (1856), consisted of her correspondence during a visit to Canada undertaken for her health. She visited the Rocky Mountains, the South Pacific, Australia and New Zealand, producing some brightly written books of travel. But her reputation was made by the records of her extensive travels in Asia: *Unbeaten Tracks in Japan* (2 vols., 1880), *Journeys in Persia and Kurdistan* (2 vols., 1891), *Among the Tibetans* (1894), *Korea and her Neighbours* (2 vols., 1898), *The Yangtze Valley and Beyond* (1899), *Chinese Pictures* (1900). She married in 1881 Dr John Bishop, an Edinburgh physician, and was left a widow in 1886. In 1892 she became the first lady fellow of the Royal Geographical Society, and in 1901 she rode a thousand miles in Morocco and the Atlas Mountains. She died in Edinburgh on the 7th of October 1904.

See Anna M. Stoddart, *The Life of Isabella Bird* (1906).

BISHOP (A.S. *biscep*, from Lat. *episcopos*, Gr. *ἐπίσκοπος*, "overlooker" or "overser"), in certain branches of the Christian Church, an ecclesiastic consecrated or set apart to perform certain spiritual functions, and to exercise oversight over the lower clergy (priests or presbyters, deacons, &c.). In the Catholic Church bishops take rank at the head of the sacerdotal hierarchy, and have certain spiritual powers peculiar to their office, but opinion has long been divided as to whether they constitute a separate order or form merely a higher degree of the order of priests (*ordo sacerdotium*).

In the Roman Catholic Church the bishop belongs to the highest order of the hierarchy, and in this respect is the peer even of the pope, who addresses him as "venerable brother." By the decree of the council of Trent he must be thirty years of age, of legitimate birth, and of approved learning and virtue. The method of his selection varies in different countries. In France, under the Concordat, the sovereign—and under the republic the president—had the right

Roman
Catholic.

of nomination. The same is true of Austria (except four sees), Bavaria, Spain and Portugal. In some countries the bishop is elected by the cathedral chapter (as in Württemberg), or by the bishops of the provinces (as in Ireland). In others, as in Great Britain, the United States of America and Belgium, the pope selects one out of a list submitted by the chapter. In all cases the nomination or election is subject to confirmation by the Holy See. Before this is granted the candidate is submitted to a double examination as to his fitness, first by a papal delegate at his place of residence (*processus informativus in partibus electi*), and afterwards by the Roman Congregation of Cardinals assigned for this purpose (*processus electionis definitivus in curia*). In the event of both processes proving satisfactory, the bishop-elect is confirmed, preconized, and so far promoted that he is allowed to exercise the rights of jurisdiction in his see. He cannot, however, exercise the functions proper to the episcopal order (*potestas ordinis*) until his consecration, which ordinarily takes place within three months of his confirmation. The bishop is consecrated, after taking the oath of fidelity to the Holy See, and subscribing the profession of faith, by a bishop appointed by the pope for the purpose, assisted by at least two other bishops or prelates, the main features of the act being the laying on of hands, the anointing with oil, and the delivery of the pastoral staff and other symbols of the office. After consecration the new bishop is solemnly enthroned and blesses the assembled congregation.

The *potestas ordinis* of the bishop is not peculiar to the Roman Church, and, in general, is claimed by all bishops, whether Oriental or Anglican, belonging to churches which have retained the Catholic tradition in this respect. Besides the full functions of the presbyterate, or priesthood, bishops have the sole right (1) to confer holy orders, (2) to administer confirmation, (3) to prepare the holy oil, or chrism, (4) to consecrate sacred places or utensils (churches, churchyards, altars, &c.), (5) to give the benediction to abbots and abbesses, (6) to anoint kings. In the matter of their rights of jurisdiction, however, Roman Catholic bishops differ from others in their peculiar responsibility to the Holy See. Some of their powers of legislation and administration they possess *motu proprio* in virtue of their position as diocesan bishops, others they enjoy under special faculties granted by the Holy See; but all bishops are bound, by an oath taken at the time of their consecration, to go to Rome at fixed intervals (*visitare sacra limina apostolorum*) to report in person, and in writing, on the state of their dioceses.

The Roman bishop ranks immediately after the cardinals; he is styled *reverendissimus, sanctissimus* or *beatissimus*. In English the style is "Right Reverend"; the bishop being addressed as "my lord bishop."

The insignia (*pontificalia* or pontificals) of the Roman Catholic bishop are (1) a ring with a jewel, symbolizing fidelity to the church, (2) the pastoral staff, (3) the pectoral cross, (4) the vestments, consisting of the caligae, stockings and sandals, the tunic, and purple gloves, (5) the mitre, symbol of the royal priesthood, (6) the throne (*cathedra*), surmounted by a baldachin or canopy, on the gospel side of the choir in the cathedral church.

The spiritual function and character of the Anglican bishops, allowing for the doctrinal changes effected at the Reformation, are similar to those of the Roman. They alone can administer the rite of confirmation, ordain priests and deacons, and exercise a certain dispensing power. In the established Church of England the appointment of bishops is vested effectively in the crown, though the old form of election by the cathedral chapter is retained. They must be learned presbyters at least thirty years of age, born in lawful wedlock, and of good life and behaviour. The mode of appointment is regulated by 25 Henry VIII. c. 20, re-enacted in 1 Elizabeth c. 1 (Act of Supremacy 1558). On a vacancy occurring, the dean and chapter notify the king thereof in chancery, and pray leave to make election. A licence under the Great Seal to proceed to the election of a bishop, known as the *congé d'estire*, together with a letter missive containing the name of the king's nominee, is thereupon sent to the dean and chapter, who are bound under the penalties of *Praemunire* to proceed within twelve days to

the election of the person named in it. In the event of their refusing obedience or neglecting to elect, the bishop may be appointed by letters patent under the Great Seal without the form of election. Upon the election being reported to the crown, a mandate issues from the crown to the archbishop and metropolitan, requesting him and commanding him to confirm the election, and to invest and consecrate the bishop-elect. Thereupon the archbishop issues a commission to his vicar-general to examine formally the process of the election of the bishop, and to supply by his authority all defects in matters of form, and to administer to the bishop-elect the oaths of allegiance, of supremacy and of canonical obedience (see CONFIRMATION OF BISHOPS). In the disestablished and daughter Churches the election is by the synod of the Church, as in Ireland, or by a diocesan convention, as in the United States of America.

In the Church of England the *potestas ordinis* is conferred by consecration. This is usually carried out by an archbishop, who is assisted by two or more bishops. The essential "form" of the consecration is in the simultaneous "laying on of hands" by the consecrating prelates. After this the new bishop, who has so far been vested only in a rochet, retires and puts on the rest of the episcopal habit, viz. the chimere. After consecration the bishop is competent to exercise all the spiritual functions of his office; but a bishopric in the Established Church, being a barony, is under the guardianship of the crown during a vacancy, and has to be conferred afresh on each new holder. A bishop, then, cannot enter into the enjoyment of the temporalities of his see, including his rights of presentation to benefices, before doing homage to the king. This is done in the ancient feudal form, surviving elsewhere only in the conferring of the M.A. degree at Cambridge. The bishop kneels before the king, places his hands between his, and recites an oath of temporal allegiance; he then kisses hands.

Besides the functions exercised in virtue of their order, bishops are also empowered by law to exercise a certain jurisdiction over all consecrated places and over all ordained persons. This jurisdiction they exercise for the most part through their consistorial courts, or through commissioners appointed under the Church Discipline Act of 1840. By the Clergy Discipline Act of 1802 it was decreed that the trial of clerks accused of unfitness to exercise the cure of souls should be before the consistory court with five assessors. Under the Public Worship Regulation Act of 1874, which gave to churchwardens and aggrieved parishioners the right to institute proceedings against the clergy for breaches of the law in the conduct of divine service, a discretionary right was reserved to the bishop to stay proceedings.

The bishops also exercise a certain jurisdiction over marriages, inasmuch as they have by the canons of the Church of England a power of dispensing with the proclamation of banns before marriage. These dispensations are termed marriage licences, and their legal validity is recognised by the Marriage Act of 1823. The bishops had formerly jurisdiction over all questions touching the validity of marriages and the status of married persons, but this jurisdiction has been transferred from the consistorial courts of the bishops to a court of the crown by the Matrimonial Causes Act of 1857. They have in a similar manner been relieved of their jurisdiction in testamentary matters, and in matters of defamation and of brawling in churches; and the only jurisdiction which they continue to exercise over the general laity is with regard to their use of the churches and churchyards. The churchwardens, who are representative officers of the parishes, are also executive officers of the bishops in all matters touching the decency and order of the churches and of the churchyards, and they are responsible to the bishops for the due discharge of their duties; but the abolition of church rates has relieved the churchwardens of the most onerous part of their duties, which was connected with the stewardship of the church funds of their parishes.

The bishops are still authorized by law to dedicate and set apart buildings for the solemnization of divine service, and grounds for the performance of burials, according to the rites and ceremonies of the Church of England; and such buildings

and grounds, after they have been duly consecrated according to law, cannot be diverted to any secular purpose except under the authority of an act of parliament.

The bishops of England have also jurisdiction to examine clerks who may be presented to benefices within their respective dioceses, and they are bound in each case by the 95th canon of 1549, to inquire and inform themselves of the sufficiency of each clerk within twenty-eight days, after which time, if they have not rejected him as insufficiently qualified, they are bound to institute him, or to license him, as the case may be, to the benefice, and thereupon to send their mandate to the archdeacon to induct him into the temporalities of the benefice. Where the bishop himself is patron of a benefice within his own diocese he is empowered to collate a clerk to it,—in other words, to confer it on the clerk without the latter being presented to him. Where the clerk himself is patron of the living, the bishop may institute him on his own petition. (See BENEFICE.)

As spiritual peers, bishops of the Church of England have (subject to the limitations stated below) seats in the House of Lords, though whether as barons or in their spiritual character has been a matter of dispute. The latter, however, would seem to be the case, since a bishop was entitled to his writ of summons after confirmation and before doing homage for his barony. Doubts having been raised whether a bishop of the Church of England, being a lord of parliament, could resign his seat in the Upper House, although several precedents to that effect are on record, a statute of the realm, which was confined to the case of the bishops of London and Durham, was passed in 1856, declaring that on the resignation of their sees being accepted by their respective metropolitans, those bishops should cease to sit as lords of parliament, and their sees should be filled up in the manner provided by law in the case of the avoidance of a bishopric. In 1869 the Bishops' Resignation Act was passed. It provided that, on any bishop desiring to retire on account of age or incapacity, the sovereign should be empowered to declare the see void by an order in council, the retiring bishop or archbishop to be secured the use of the episcopal residence for life and a pension of one-third of the revenues of the see, or £3000, whichever sum should prove the larger. Other sections defined the proceedings for proving, in case of need, the incapacity of a bishop, provided for the appointment of coadjutors and defined their status (Phillimore i. 82).

In view of the necessity for increasing the episcopate in the 19th century and the objection to the consequent increase of the spiritual peers in the Upper House, it was finally enacted by the Bishops Act of 1878 that only the archbishops and the bishops of London, Winchester and Durham should be always entitled to writs summoning them to the House of Lords. The rest of the twenty-five seats are filled up, as a vacancy occurs, according to seniority of consecration.

Bishops of the Church of England rank in order of precedence immediately above barons. They may marry, but their wives as such enjoy no title or precedence. Bishops are addressed as "Right Reverend" and have legally the style of "Lord," which, as in the case of Roman Catholic bishops in England, is extended to all, whether suffragans or holders of colonial bishoprics, by courtesy.

The insignia of the Anglican bishop are the rochet and the chimere, and the episcopal throne on the gospel side of the chancel of the cathedral church. The use of the mitre, pastoral staff and pectoral cross, which had fallen into complete disuse by the end of the 18th century, has been now very commonly, though not universally, revived; and, in some cases, the interpretation put upon the "Ornaments rubric" by the modern High Church school has led to a more complete revival of the pre-Reformation vestments.

In the Orthodox Church of the East and the various communions springing from it, the *potestas ordinis* of the bishop is the same as in the Western Church. Among his qualifications the most peculiar is that he must be unmarried, which, since the secular priests are compelled to marry, entails his belonging to the "black clergy" or

monks. The insignia of an oriental bishop, with considerable variation in form, are essentially the same as those of the Catholic West.

Besides bishops presiding over definite sees, there have been from time immemorial in the Christian Church bishops holding their jurisdiction in subordination to the bishop of the diocese. (1) The oldest of these were the *chorepiscopi* (*ἱεὶς χωρὰς ἐπισκοπῶν*), i.e. country bishops, who were delegated by the bishops of the cities in the early church to exercise jurisdiction in the remote towns and villages as these were converted from paganism. Their functions varied in different times and places, and by some it has been held that they were originally only presbyters. In any case, this class of bishops, which had been greatly curtailed in the East in A.D. 343 by the council of Laodicea, was practically extinct everywhere by the 10th century. It survived longest in Ireland, where in 1152 a synod, presided over by the papal legate, decreed that, after the death of the existing holders of the office, no more should be consecrated. Their place was taken by arch-presbyters and rural deans. (2) The *Episcopi regionarii*, or *gentium*, were simply missionary bishops without definite sees. Such were, at the outset, Boniface, the apostle of Germany, and Willibrord, the apostle of the Frisians. (3) Bishops *in partibus infidelium* were originally those who had been expelled from their sees by the pagans, and, while retaining their titles, were appointed to assist diocesan bishops in their work. In later times the custom arose of consecrating bishops for this purpose, or merely as an honorary distinction, with a title derived from some place once included within, but now beyond the bounds of Christendom. (4) *Coadjutor bishops* are such as are appointed to assist the bishop of the diocese when incapacitated by infirmity or by other causes from fulfilling his functions alone. Coadjutors in the early church were appointed with a view to their succeeding to the see; but this, though common in practice, is no longer the rule. In the Church of England the appointment and rights of coadjutor bishops were regulated by the Bishops' Resignation Act of 1869. Under this act the coadjutor bishop has the right of succession to the see, or in the case of the archiepiscopal sees and those of London, Winchester and Durham, to the see vacated by the bishop, translated from another diocese to fill the vacancy. (5) *Suffragan bishops* (*episcopi suffraganei* or *auxiliares*) are those appointed to assist diocesan bishops in their pontifical functions when hindered by infirmity, public affairs or other causes. In the Roman Church the appointment of the suffragan rests with the pope, on the petition of the bishop, who must prove that such is the custom of the see, name a suitable priest and guarantee his maintenance. The suffragan is given a title *in partibus*, but never that of archbishop, and the same title is never given to two suffragans in succession. In the Church of England the status of suffragan bishops was regulated by the Act 26 Henry VIII. c. 14. Under this statute, which, after long remaining inoperative, was amended and again put into force by the Suffragans' Nomination Act of 1888, every archbishop and bishop, being disposed to have a suffragan to assist him, may name two honest and discreet spiritual persons for the crown to give to one of them the title, name, style and dignity of a bishop of any one of twenty-six sees enumerated in the statute, as the crown may think convenient. The crown, having made choice of one of such persons, is empowered to present him by letters patent under the great seal to the metropolitan, requiring him to consecrate him to the same name, title, style and dignity of a bishop; and the person so consecrated is thereupon entitled to exercise, under a commission from the bishop who has nominated him, such authority and jurisdiction, within the diocese of such bishop, as shall be given to him by the commission, and no other.

The title of bishop survived the Reformation in certain of the Lutheran churches of the continent, in Denmark, Norway, Finland, Sweden and Transylvania; it was temporarily restored in Prussia in 1701, for the coronation of King Frederick I., again between 1816 and 1840 by Frederick William III., and in Nassau in 1818. In these latter

Orthodox
Eastern.

Lutheran
churches.

cases, however, the title bishop is equivalent to that of "superintendent," the form most generally employed. The Lutheran bishops, as a rule, do not possess or claim unbroken "apostolic succession"; those of Finland and Sweden are, however, an exception. The Lutheran bishops of Transylvania sit, with the Roman and Orthodox bishops, in the Hungarian Upper House. In some cases the secularization of episcopal principalities at the Reformation led to the survival of the title of bishop as a purely secular distinction. Thus the see of Osnabrück (Osnaburg) was occupied, from the peace of Westphalia to 1802, alternately by a Catholic and a Protestant prince. From 1762 to 1802 it was held by Frederick, duke of York, the last prince-bishop. Similarly, the bishopric of Schwerin survived as a Protestant prince-bishopric until 1648, when it was finally secularized and annexed to Mecklenburg, and the see of Lübeck was held by Protestant "bishops" from 1530 till its annexation to Oldenburg in 1803.¹

In other Protestant communities, e.g. the Moravians, the Methodist Episcopal Church and the Mormons, the office and title of bishop have survived, or been created. Their functions and status will be found described in the accounts of the several churches.

See Wetzer and Welte, *Kirchenlexikon*, s. "Bischof" and "Weihen"; Hinschius, *Kirchenrecht*, vol. ii.; Herzog-Hauck, *Realencyclopädie*, s. "Bischof" (the author rather arbitrarily classes Anglican with Lutheran bishops as not bishops in any proper sense at all); Phillimore's *Ecclesiastical Law*; the articles ORDER, HOLY; VESTMENTS; ECCLESIASTICAL JURISDICTION; EPISCOPACY. (W. A. P.)

BISHOP AUCKLAND, a market town in the Bishop Auckland parliamentary division of Durham, England, 11 m. S.S.W. of the city of Durham, the junction of several branches of the North Eastern railway. Pop. of urban district (1901) 11,969. It is beautifully situated on an eminence near the confluence of the Wear and the Gaunless. The parish church is 1 m. distant, at Auckland St Andrews, a fine cruciform structure, formerly collegiate, in style mainly Early English, but with earlier portions. The palace of the bishops of Durham, which stands at the north-east end of the town, is a spacious and splendid, though irregular pile. The site of the palace was first chosen by Bishop Anthony Beck, in the time of Edward I. The present building covers about 5 acres, and is surrounded by a park of 800 acres. On the Wear 1½ m. above Bishop Auckland there is a small and very ancient church at Escomb, massively built and tapering from the bottom upward. It is believed to date from the 7th century, and some of the stones are evidently from a Roman building, one bearing an inscription. These, no doubt, came from Binschester, a short distance up stream, where remains of a Roman fort (*Vinovia*) are traceable. It guarded the great Roman north road from York to Hadrian's wall. The industrial population of Bishop Auckland is principally employed in the neighbouring collieries and iron works.

BISHOP'S CASTLE, a market town and municipal borough in the southern parliamentary division of Shropshire, England; the terminus of the Bishop's Castle light railway from Craven Arms. Pop. (1901) 1378. It is pleasantly situated in a hilly district to the east of Clun Forest, climbing the flank and occupying the summit of an eminence. Of the castle of the bishops of Hereford, which gave the town its name, there are only the slightest fragments remaining. The town has some agricultural trade. It is governed by a mayor, 4 aldermen and 12 councillors. Area, 1867 acres.

Bishop's Castle was included in the manor of Lydbury, which belonged to the church of Hereford before the Conquest. The castle, at first called Lydbury Castle, was built by one of the bishops of Hereford between 1065 and 1154, to protect his manor from the Welsh, and the town which sprang up round the castle walls acquired the name of Bishop's Castle in the 13th century. In 1292 the bishop claimed to have a market every Friday, a fair on the eve, day and

morrow of the Decollation of St John, and assize of bread and ale in Bishop's Castle, which his predecessors had held from time immemorial. Ten years later he received a grant from Richard II. of a market every Wednesday and a fair on the 2nd of November and two days following. Although the town was evidently a borough by the 13th century, since the burgesses are mentioned as early as 1292, it has no charter earlier than the incorporation charter granted by Queen Elizabeth in 1572. This was confirmed by James I. in 1617 and by James II. in 1688. In 1584 Bishop's Castle returned two members to parliament, and was represented until 1832, when it was disfranchised.

BISHOP STORTFORD, a market town in the Hertford parliamentary division of Hertfordshire, England; 30½ m. N.N.E. from London by the Cambridge line of the Great Eastern railway. Pop. of urban district (1901) 7143. It lies on the river Stort, close to the county boundary with Essex, and has water-communication with London through the Lea and Stort Navigation. The church of St Michael, standing high above the valley, is a fine embattled Perpendicular building with western tower and spire. The high school, formerly the grammar school, was founded in the time of Elizabeth. Here were educated Sir Henry Chauncy, an early historian of Hertfordshire (d. 1719), and Cecil Rhodes, who was born at Bishop Stortford in 1853. There are a Nonconformist grammar school, a diocesan training college for mistresses, and other educational establishments. The industries include brewing and malting, coach-building, lime-burning and founding, and there are important horse and cattle markets.

Before the Conquest the manor of Bishop Stortford is said to have belonged to Eddeva the Fair, wife of Harold, who sold it to the bishop of London, from whom it was taken by William the Conqueror. William restored it after a few years, and with it gave the bishop a small castle called Waytemore, of which there are scanty remains. The dungeon of this castle, called "Bishop's Hole" or "Bishop's Prison," was used as an ecclesiastical prison until the 16th century. The town now possesses no early incorporation charters, and although both Chauncy and Salmon in their histories of Hertfordshire state that it was created a borough by charter of King John in 1206, the charter cannot now be found. The first mention of Bishop Stortford as a borough occurs in 1311, in which year the burgesses returned two members to parliament. The town was represented from that date until 1332, and again in 1335-1336, but the privilege was then allowed to lapse and has never been revived.

BISKRA, a town of Algeria, in the arrondissement of Batna, department of Constantine, 150 m. S.W. of the city of Constantine and connected with it and with Philippeville by rail. It lies in the Sahara 360 ft. above the sea, on the right bank of the Wad Biskra, a river which, often nearly dry for many months in the year, becomes a mighty torrent after one or two days' rain in winter. The name Biskra applies to a union of five or six villages of the usual Saharan type, scattered through an oasis 3 m. in length by less than 1 m. broad, and separated by huge gardens full of palm and olive trees. The houses are built of hardened mud, with doors and roof of palm wood. The foreign settlement is on the north of the oasis; it consists of a broad main street, the rue Berthe (from which a few side streets branch at right angles), lined with European houses, the whole in the style of a typical French winter resort, a beautiful public garden, with the church in the centre, an arcade, a pretentious *mairie* in pseudo-Moorish style with entrance guarded by terra-cotta lions, some good shops, a number of excellent hotels and cafés, a casino, clubs, and, near by, a street of dancing and singing girls of the tribe of Walad-Nail. East of the public garden is Fort St Germain, named after an officer killed in the insurrection of the Zaatcha in 1849; it is capable of resisting any attack of the Arabs, and extensive enough to shelter the whole of the civil population, who took refuge therein during the rebellion of 1871. It contains barracks, hospital and government offices. To the south-east lies the Villa Landon with magnificent gardens filled with tropical plants. The population (1906) of the chief settlement was 4218, of the whole oasis 10,413.

From November to April the climate of Biskra is delightful. Nowhere in Algeria can be found more genial temperature or clearer skies, and while in summer the thermometer often registers 110° F. in the shade, and 90° at night, the pure dryness of the air in this practically rainless region makes the heat

¹ The title prince-bishop, attached in Austria to the sees of Laibach, Seckau, Gurk, Brizzen, Trent and Lavant, and in Prussia to that of Breslau, no longer implies any secular jurisdiction, but is merely a title of honour recognized by the state, owing either to the importance of the sees or for reasons purely historical.

endurable. The only drawback to the climate is the prevalence of high cold winds in winter. These winds cause temperatures as low as 36°, but the mean reading, on an average of ten years, is 73°.

In the oasis are some 200,000 fruit trees, of which about 150,000 are date-palms, the rest being olives, pomegranates and apricots. In the centre of the oasis is the old kasbah or citadel.

In 1844 the duc d'Almale occupied this fort, and here, on the night of the 12th of May of that year, the 68 men who formed the French garrison were, with one exception, massacred by Arabs. In the fort are a few fragments of Roman work—all that remains of the Roman post *Ad Piscinam*.

Biskra is the capital of the Ziban (plural of Zab), a race of mixed Berber and Arab origin, whose villages extend from the southern slopes of the Aures to the Shat Melir. These villages, built in oases dotted over the desert, nestle in groves of date-palms and fruit trees and waving fields of barley. The most interesting village is that of Sidi Okba, 12 m. south-east of Biskra. It is built of houses of one story made of sun-dried bricks. The mosque is square, with a flat roof supported on clay columns, and crowned by a minaret. In the north-west corner of the mosque is the tomb of Sidi Okba, the leader of the Arabs who in the 1st century of the Hegira conquered Africa for Islam from Egypt to Tangier. Sidi Okba was killed by the Berbers near this place in A.D. 682. On his tomb is the inscription in Cufic characters, "This is the tomb of Okba, son of Naï. May God have mercy upon him." No older Arabic inscription is known to exist in Africa.

BISLEY, a village of Surrey, England, 3½ m. N.W. of Woking. The ranges of the National Rifle Association were transferred from Wimbledon here in 1890. (See *RIFLE*.)

BISMARCK, OTTO EDUARD LEOPOLD VON, PRINCE, duke of Lauenburg (1815-1898), German statesman, was born on the 1st of April 1815, at the manor-house of Schönhausen, his father's seat in the mark of Brandenburg. The family has, since the 14th century, belonged to the landed gentry, and many members had held high office in the kingdom of Prussia. His father (d. 1845), of whom he always spoke with much affection, was a quiet, unassuming man, who retired from the army in early life with the rank of captain of cavalry (*Rittmeister*). His mother, a daughter of Mencken, cabinet secretary to the king, was a woman of strong character and ability, who had been brought up at Berlin under the "Aufklärung." Her ambition was centred in her sons, but Bismarck in his recollections of his childhood missed the influences of maternal tenderness. There were several children of the marriage, which took place in 1806, but all died in childhood except Bernhard (1810-1893), Otto, and one sister, Malvina (b. 1827), who married in 1845 Oscar von Arnim. Young Bismarck was educated in Berlin, first at a private school, then at the gymnasium of the Graue Kloster (Grey Friars). At the age of seventeen he went to the university of Göttingen, where he spent a little over a year; he joined the corps of the Hannoverans and took a leading part in the social life of the students. He completed his studies at Berlin, and in 1835 passed the examinations which admitted him to the public service. He was intended for the diplomatic service, but spent some months at Aix-la-Chapelle in administrative work, and then was transferred to Potsdam and the judicial side. He soon retired from the public service; he conceived a great distaste for it, and had shown himself defective in discipline and regularity. In 1839, after his mother's death, he undertook, with his brother, the management of the family estates in Pomerania; at this time most of the estate attached to Schönhausen had to be sold. In 1844, after the marriage of his sister, he went to live with his father at Schönhausen. He and his brother took an active part in local affairs, and in 1846 he was appointed *Deichhauptmann*, an office in which he was responsible for the care of the dykes by which the country, in the neighbourhood of the Elbe, was preserved from inundation. During these years he travelled in England, France and Switzerland. The influence of his mother, and his own wide reading and critical character, made him at one time inclined to hold liberal opinions on govern-

ment and religion, but he was strongly affected by the religious revival of the early years of the reign of Frederick William IV.; his opinions underwent a great change, and under the influence of the neighbouring country gentlemen he acquired those strong principles in favour of monarchical government as the expression of the Christian state, of which he was to become the most celebrated exponent. His religious convictions were strengthened by his marriage to Johanna von Puttkamer, which took place in 1847.

In the same year he entered public life, being chosen as substitute for the representative of the lower nobility of his district in the estates-general, which were in that year summoned to Berlin. He took his seat with the extreme right, and distinguished himself by the vigour and originality with which he defended the rights of the king and the Christian monarchy against the Liberals. When the revolution broke out in the following year he offered to bring the peasants of Schönhausen to Berlin in order to defend the king against the revolutionary party, and in the last meeting of the estates voted in a minority of two against the address thanking the king for granting a constitution. He did not sit in any of the assemblies summoned during the revolutionary year, but took a very active part in the formation of a union of the Conservative party, and was one of the founders of the *Kreuzzeitung*, which has since then been the organ of the Monarchical party in Prussia. In the new parliament which was elected at the beginning of 1849, he sat for Brandenburg, and was one of the most frequent and most incisive speakers of what was called the Junker party. He took a prominent part in the discussions on the new Prussian constitution, always defending the power of the king. His speeches of this period show great debating skill, combined with strong originality and imagination. His constant theme was, that the party disputes were a struggle for power between the forces of revolution, which derived their strength from the fighters on the barricades, and the Christian monarchy, and that between these opposed principles no compromise was possible. He took also a considerable part in the debates on the foreign policy of the Prussian government; he defended the government for not accepting the Frankfurt constitution, and opposed the policy of Radowitz, on the ground that the Prussian king would be subjected to the control of a non-Prussian parliament. The only thing, he said, that had come out of the revolutionary year unharmed, and had saved Prussia from dissolution and Germany from anarchy, was the Prussian army and the Prussian civil service; and in the debates on foreign policy he opposed the numerous plans for bringing about the union of Germany, by subjecting the crown and Prussia to a common German parliament. He had a seat in the parliament of Erfurt, but only went there in order to oppose the constitution which the parliament had framed. He foresaw that the policy of the government would lead it into a position when it would have to fight against Austria on behalf of a constitution by which Prussia itself would be dissolved, and he was, therefore, one of the few prominent politicians who defended the complete change of front which followed the surrender of Olmütz.

It was probably his speeches on German policy which induced the king to appoint him Prussian representative at the restored diet of Frankfurt in 1851. The appointment was a bold one, as he was entirely without diplomatic ex-
Diplomatic career.

perience, but he justified the confidence placed in him. During the eight years he spent at Frankfurt he acquired an unrivalled knowledge of German politics. He was often used for important missions, as in 1852, when he was sent to Vienna. He was entrusted with the negotiations by which the duke of Augustenburg was persuaded to assent to the arrangements by which he resigned his claims to Schleswig and Holstein. The period he spent at Frankfurt, however, was of most importance because of the change it brought about in his own political opinions. When he went to Frankfurt he was still under the influence of the extreme Prussian Conservatives, men like the Gerlachs, who regarded the maintenance of the principle of the

Christian monarchy against the revolution as the chief duty of the Prussian government. He was prepared on this ground for a close alliance with Austria. He found, however, a deliberate intention on the part of Austria to humble Prussia, and to degrade her from the position of an equal power, and also great jealousy of Prussia among the smaller German princes, many of whom owed their thrones to the Prussian soldiers, who, as in Saxony and Baden, had crushed the insurgents. He therefore came to the conclusion that if Prussia was to regain the position she had lost she must be prepared for the opposition of Austria, and must strengthen herself by alliances with other powers. The solidarity of Conservative interests appeared to him now a dangerous fiction. At the time of the Crimean War he advocated alliance with Russia, and it was to a great extent owing to his advice that Prussia did not join the western powers. Afterwards he urged a good understanding with Napoleon, but his advice was met by the insuperable objection of King Frederick William IV. to any alliance with a ruler of revolutionary origin.

The change of ministry which followed the establishment of a regency in 1857 made it desirable to appoint a new envoy at Frankfurt, and in 1858 Bismarck was appointed ambassador at St Petersburg, where he remained for four years. During this period he acquired some knowledge of Russian, and gained the warm regard of the tsar, as well as of the dowager-empress, herself a Prussian princess. During the first two years he had little influence on the Prussian government; the Liberal ministers distrusted his known opinions on parliamentary government, and the monarchical feeling of the prince regent was offended by Bismarck's avowed readiness for alliance with the Italians and his disregard of the rights of other princes. The failure of the ministry, and the estrangement between King William and the Liberal party, opened to him the way to power. Roon, who was appointed minister of war in 1861, was an old friend of his, and through him Bismarck was thenceforward kept closely informed of the condition of affairs in Berlin. On several occasions the prospect of entering the ministry was open to him, but nothing came of it, apparently because he required a free hand in foreign affairs, and this the king was not prepared to give him. When an acute crisis arose out of the refusal of parliament, in 1862, to vote the money required for the reorganization of the army, which the king and Roon had carried through, he was summoned to Berlin; but the king was still unable to make up his mind to appoint him, although he felt that Bismarck was the only man who had the courage and capacity for conducting the struggle with parliament. He was, therefore, in June, made ambassador at Paris as a temporary expedient. There he had the opportunity for renewing the good understanding with Napoleon which had been begun in 1857. He also paid a short visit to England, but it does not appear that this had any political results. In September the parliament, by a large majority, threw out the budget, and the king, having nowhere else to turn for help, at Roon's advice summoned Bismarck to Berlin and appointed him minister-president and foreign minister.

Bismarck's duty as minister was to carry on the government against the wishes of the Lower House, so as to enable the king to complete and maintain the reorganized army. The *Ministry.* opposition of the House was supported by the country and by a large party at court, including the queen and crown prince. The indignation which his appointment caused was intense; he was known only by the reputation which in his early years he had won as a violent ultra-Conservative, and the apprehensions were increased by his first speech, in which he said that the German question could not be settled by speeches and parliamentary decrees, but only by blood and iron. His early fall was predicted, and it was feared that he might bring down the monarchy with him. Standing almost alone he succeeded in the task he had undertaken. For four years he ruled without a budget, taking advantage of an omission in the constitution which did not specify what was to happen in case the crown and the two Houses could not agree on a budget. The conflict of the ministers and the House assumed at times the

form of bitter personal hostility; in 1863 the ministers refused any longer to attend the sittings, and Bismarck challenged Virchow, one of his strongest opponents, to a duel, which, however, did not take place. In 1852 he had fought a duel with pistols against Georg von Vindre, a political opponent. In June 1863, as soon as parliament had risen, Bismarck published ordinances controlling the liberty of the press, which, though in accordance with the letter, seemed opposed to the intentions of the constitution, and it was on this occasion that the crown prince, hitherto a silent opponent, publicly dissociated himself from the policy of his father's ministers. Bismarck depended for his position solely on the confidence of the king, and the necessity for defending himself against the attempts to destroy this confidence added greatly to the suspiciousness of his nature. He was, however, really indispensable, for his resignation must be followed by a Liberal ministry, parliamentary control over the army, and probably the abdication of the king. Not only, therefore, was he secure in the continuance of the king's support, but he had also the complete control of foreign affairs. Thus he could afford to ignore the criticism of the House, and the king was obliged to acquiesce in the policy of a minister to whom he owed so much.

He soon gave to the policy of the monarchy a resolution which had long been wanting. When the emperor of Austria summoned a meeting of the German princes at Frankfurt to discuss a reform of the confederation, Bismarck insisted that the king of Prussia must not attend. He remained away, and his absence in itself made the congress unavailing. There can be no doubt that from the time he entered on office Bismarck was determined to bring to an issue the long struggle for supremacy in Germany between the house of Habsburg and the house of Hohenzollern. Before he was able to complete his preparations for this, two unforeseen occurrences completely altered the European situation, and caused the conflict to be postponed for three years. The first was the outbreak of rebellion in Poland. Bismarck, an inheritor of the older Prussian traditions, and recollecting how much of the greatness of Prussia had been gained at the expense of the Poles, offered his help to the tsar. By this he placed himself in opposition to the universal feeling of western Europe; no act of his life added so much to the repulsion with which at this time he was regarded as an enemy of liberty and right. He won, however, the gratitude of the tsar and the support of Russia, which in the next years was to be of vital service to him. Even more serious were the difficulties arising in Denmark. On the death of King Frederick VII. in 1863, Prince Frederick of Augustenburg came forward as claimant to the duchies of Schleswig and Holstein, which had hitherto been joined to the crown of Denmark. He was strongly supported by the whole German nation and by many of its princes. Bismarck, however, once more was obliged to oppose the current of national feeling, which imperiously demanded that the German duchies should be rescued from a foreign yoke. Prussia was bound by the treaty of London of 1852, which guaranteed the integrity of the Danish monarchy; to have disregarded this would have been to bring about a coalition against Germany similar to that of 1851. Moreover, he held that it would be of no advantage to Prussia to create a new German state; if Denmark were to lose the duchies, he desired that Prussia should acquire them, and to recognize the Augustenburg claims would make this impossible. His resistance to the national desire made him appear a traitor to his country. To check the agitation he turned for help to Austria; and an alliance of the two powers, so lately at variance, was formed. He then falsified all the predictions of the opposition by going to war with Denmark, not, as they had required, in support of Augustenburg, but on the ground that the king of Denmark had violated his promise not to oppress his German subjects. Austria continued to act with Prussia, and, after the defeat of the Danes, at the peace of Vienna the sovereignty of the duchies was surrendered to the two allies—the first step towards annexation by Prussia. There is no part of Bismarck's diplomatic work which deserves such careful study as these

events. Watched as he was by countless enemies at home and abroad, a single false step would have brought ruin and disgrace on himself; the growing national excitement would have burst through all restraint, and again, as fifteen years before, Germany divided and unorganized would have had to capitulate to the orders of foreign powers (see SCHELESWIG-HOLSTEIN QUESTION).

The peace of Vienna left him once more free to return to his elder policy. For the next eighteen months he was occupied in preparing for war with Austria. For this war he

War with Austria. was alone responsible; he undertook it deliberately as the only means of securing Prussian ascendancy in Germany. The actual cause of dispute was the disposition of the conquered duchies, for Austria now wished to put Augustenburg in as duke, a plan to which Bismarck would not assent. In 1865 a provisional arrangement was made by the treaty of Gastein, for Bismarck was not yet ready. He would not risk a war unless he was certain of success, and for this he required the alliance of Italy and French support; both he secured during the next year. In October 1865 he visited Napoleon at Biarritz and Paris. No formal treaty was made, but Napoleon promised to regard favourably an extension of Prussian power in Germany; while Bismarck led the emperor to believe that Prussia would help him in extending the frontier of France. A treaty of alliance with Italy was arranged in the spring of 1866; and Bismarck then with much difficulty overcame the reluctance of the king to embark in a war with his old ally. The results of the war entirely justified his calculations. Prussia, though opposed by all the German states except a few principalities in the north, completely defeated all her enemies, and at the end of a few weeks the whole of Germany lay at her feet.

The war of 1866 is more than that of 1870 the crisis of modern German history. It finally settled the controversy which had begun more than a hundred years before, and left *Settlement of 1866.* Prussia the dominant power in Germany. It determined that the unity of Germany should be brought about not by revolutionary means as in 1848, not as in 1849 had been attempted by voluntary agreement of the princes, not by Austria, but by the sword of Prussia. This was the great work of Bismarck's life; he had completed the programme foreshadowed in his early speeches, and finished the work of Frederick the Great. It is also the turning-point in Bismarck's own life. Having secured the dominance of the crown in Prussia and of Prussia in Germany, he could afford to make a reconciliation with the parties which had been his chief opponents, and turn to them for help in building up a new Germany. The settlement of 1866 was peculiarly his work. We must notice, first, how in arranging the terms of peace he opposed the king and the military party who wished to advance on Vienna and annex part of Austrian Silesia; with greater foresight he looked to renewing the old friendship with Austria, and insisted (even with the threat of resignation) that no territory should be demanded. The southern states he treated with equal moderation, and thereby was able to arrange an offensive and defensive alliance with them. On the other hand, in order to secure the complete control of North Germany, which was his immediate object, he required that the whole of Hanover, Hesse-Cassel, Hesse-Nassau and the city of Frankfort, as well as the Elbe duchies, should be absorbed in Prussia. He then formed a separate confederation of the North German states, but did not attempt to unite the whole of Germany, partly because of the internal difficulties which this would have produced, partly because it would have brought about a war with France. In the new confederation he became sole responsible minister, with the title *Bundes-Kansler*; this position he held till 1890, in addition to his former post of premier minister. In 1871 the title was altered to *Reichs-Kansler*.

The reconciliation with the Prussian parliament he effected by bringing in a bill of indemnity for the money which had been spent without leave of parliament. The Radicals still continued their opposition, but he thereby made possible the formation of a large party of moderate Liberals, who thenceforward supported him in his new Nationalist policy. He also, in the constitution for the new confederation, introduced a parliament

(*Bundestag*) elected by universal suffrage. This was the chief demand of the revolutionists in 1848; it was one to which in his early life he had been strongly opposed. His experience at Frankfort had diminished his dislike of popular representation, and it was probably to the advice of Lassalle that his adoption of universal suffrage was due. He first publicly proposed it just before the war; by carrying it out, notwithstanding the apprehensions of many Liberal politicians, he placed the new constitution on a firmer base than would otherwise have been possible.

Up to 1866 he had always appeared to be an opponent of the National party in Germany, now he became their leader. His next task was to complete the work which was half-finished, and it was this which brought about the second of the great wars which he undertook.

The relations with Napoleon III. form one of the most interesting but obscurest episodes in Bismarck's career. He has seen that he did not share the common prejudice against co-operation with France. He found Napoleon *Bismarck and France.* willing to aid Prussia as he had aided Piedmont, and was ready to accept his assistance. There was this difference, that he asked only for neutrality, not armed assistance, and it is improbable that he ever intended to alienate any German territory; he showed himself, however, on more than one occasion, ready to discuss plans for extending French territory, on the side of Belgium and Switzerland. Napoleon, who had not anticipated the rapid success of Prussia, after the battle of Königgrätz at the request of Austria came forward as mediator, and there were a few days during which it was probable that Prussia would have to meet a French attempt to dictate terms of peace. Bismarck in this crisis by deferring to the emperor in appearance avoided the danger, but he knew that he had been deceived, and the cordial understanding was never renewed. Immediately after an armistice had been arranged, Benedetti, at the orders of the French government, demanded as recompense a large tract of German territory on the left bank of the Rhine. This Bismarck peremptorily refused, declaring that he would rather have war. Benedetti then made another proposal, submitting a draft treaty by which France was to support Prussia in adding the South German states to the new confederation, and Germany was to support France in the annexation of Luxemburg and Belgium. Bismarck discussed, but did not conclude the treaty; he kept, however, a copy of the draft in Benedetti's handwriting, and published it in *The Times* in the summer of 1870 so as to injure the credit of Napoleon in England. The failure of the scheme made a contest with France inevitable, at least unless the Germans were willing to forgo the purpose of completing the work of German unity, and during the next four years the two nations were each preparing for the struggle, and each watching to take the other at a disadvantage.

It is necessary, then, to keep in mind the general situation in considering Bismarck's conduct in the months immediately preceding the war of 1870. In 1867 there was a dispute regarding the right to garrison Luxemburg. Bismarck then produced the secret treaties with the southern states, an act which was, as it were, a challenge to France by the whole of Germany. During the next three years the Ultramontane party hoped to bring about an anti-Prussian revolution, and Napoleon was working for an alliance with Austria, where Beust, an old opponent of Bismarck's, was chancellor. Bismarck was doubtless well informed as to the progress of the negotiations, for he had established intimate relations with the Hungarians. The pressure at home for completing the work of German unity was so strong that he could with difficulty resist it, and in 1870 he was much embarrassed by a request from Baden to be admitted to the confederation, which he had to refuse. It is therefore not surprising that he eagerly welcomed the opportunity of gaining the goodwill of Spain, and supported by all the means in his power the offer made by Marshal Prim that Prince Leopold of Hohenzollern should be chosen king of that country. It was only by his urgent and repeated representations that the prince was persuaded against his will to accept. The negotiations were

carried out with the greatest secrecy, but as soon as the acceptance was made known the French government intervened and declared that the project was inadmissible. Bismarck was away at Varzin, but on his instructions the Prussian foreign office in answer to inquiries denied all knowledge or responsibility. This was necessary, because it would have caused a bad impression in Germany had he gone to war with France in support of the prince's candidature. The king, by receiving Benedetti at Ems, departed from the policy of reserve Bismarck himself adopted, and Bismarck (who had now gone to Berlin) found himself in a position of such difficulty that he contemplated resignation. The French, however, by changing and extending their demands enabled him to find a cause of war of such nature that the

The Ems telegram.

whole of Germany would be united against French aggression. France asked for a letter of apology, and Benedetti personally requested from the king a promise that he would never allow the candidature to be resumed. Bismarck published the telegram in which this information and the refusal of the king were conveyed, but by omitting part of the telegram made it appear that the request and refusal had both been conveyed in a more abrupt form than had really been the case.¹ But even apart from this, the publication of the French demand, which could not be complied with, must have brought about a war.

In the campaign of 1870-71 Bismarck accompanied the headquarters of the army, as he had done in 1866. He was present at the battle of Gravelotte and at the surrender of Sedan, and it was on the morning of the 2nd of September that he had his famous meeting with Napoleon after the surrender of the emperor. He accompanied the king to Paris, and spent many months at Versailles. Here he was occupied chiefly with the arrangements for admitting the southern states to the confederation, and the establishment of the empire. He also underwent much anxiety lest the efforts of Thiers to bring about an interference by the neutral powers might be successful. He had to carry on the negotiations with the French preliminary to the surrender of Paris, and to enforce upon them the German terms of peace.

For Bismarck's political career after 1870 we must refer to the article GERMANY, for he was thenceforward entirely absorbed in the affairs of his country. The foreign policy he controlled absolutely. As chancellor he was responsible for the whole internal policy of the empire, and his influence is to be seen in every department of state, especially, however, in the great change of policy after 1878. During the earlier period the estrangement from the Conservatives, which had begun in 1866, became very marked, and brought about a violent quarrel with many of his old friends, which culminated in the celebrated Arnim trial. He incurred much criticism during the struggle with the Roman Catholic Church, and in 1873 he was shot at and slightly wounded by a youth called Rullmann, who professed to be an adherent of the Clerical party. Once before, in 1866, just before the outbreak of war, his life had been attempted by a young man called Cohen, a native of Württemberg, who wished to save Germany from a fratricidal war. In 1872 he retired from the presidency of the Prussian ministry, but returned after a few months. On several occasions he offered to retire, but the emperor always refused his consent, on the last time with the word "Never." In 1877 he took a long leave of absence for ten months. His health at this time was very bad. In 1878 he presided over the congress of Berlin. The following years were chiefly occupied, besides foreign affairs, which were always his first care, with important commercial reforms, and he held at this time also the office of Prussian minister of trade in addition to his other posts. During this period his relations with the

¹ It was not till many years later that our knowledge of these events (which is still incomplete) was established; in 1894 the publication of the memoirs of the king of Rumania showed, what had hitherto been denied, that Bismarck had taken a leading part in urging the election of the prince of Hohenzollern. It was in 1892 that the language used by Bismarck himself made it necessary for the German government to publish the original form of the Ems telegram.

Reichstag were often very unsatisfactory, and at no time did he resort so freely to prosecutions in the law-courts in order to injure his opponents, so that the expression *Bismarck-Beleidigung* was invented. He was engaged at this time in a great struggle with the Social-Democrats, whom he tried to crush by exceptional penal laws. The death of the emperor William in 1888 made a serious difference in his position. He had been bound to him by a long term of loyal service, which had been rewarded with equal loyalty. For his relations to the emperors Frederick and William II., and for the events connected with his dismissal from office in March 1890, we must refer to the articles under those names.

After his retirement he resided at Friedrichsruh, near Hamburg, a house on his Lauenburg estates. His criticisms of the government, given sometimes in conversation, sometimes in the columns of the *Hamburger Nachrichten*, caused an open breach between him and the emperor; and the new chancellor, Count Caprivi, in a circular despatch which was afterwards published, warned all German envoys that no real importance must be attached to what he said. When he visited Vienna for his son's wedding the German ambassador, Prince Reuss, was forbidden to take any notice of him. A reconciliation was effected in 1893. In 1895 his eightieth birthday was celebrated with great enthusiasm: the Reichstag alone, owing to the opposition of the Clericals and the Socialists, refused to vote an address. In 1891 he had been elected a member of the Reichstag, but he never took his seat. He died at Friedrichsruh on the 31st of July 1898.

Bismarck was made a count in 1865; in 1871 he received the rank of Fürst (prince). On his retirement the emperor created him duke of Lauenburg, but he never used the title, which was not inherited by his son. In 1866 he received £60,000 as his share of the donation voted by the Reichstag for the victorious generals. With this he purchased the estate of Varzin in Pomerania, which henceforth he used as a country residence in preference to Schönhausen. In 1871 the emperor presented him with a large part of the domains of the duchy of Lauenburg. On his seventieth birthday a large sum of money (£270,000) was raised by public subscription, of which half was devoted to repurchasing the estate of Schönhausen for him, and the rest was used by him to establish a fund for the assistance of schoolmasters. As a young man he was an officer in the Landwehr and militia, and in addition to his civil honours he was eventually raised to the rank of general. Among the numerous orders he received we may mention that he was the first Protestant on whom the pope bestowed the order of Christ; this was done after the cessation of the Kulturkampf and the reference of the dispute with Spain concerning the Caroline Islands to the arbitration of the pope.

Bismarck's wife died in 1894. He left one daughter and two sons. Herbert (1849-1904), the elder, was wounded at Mars-la-Tour, afterwards entered the foreign office, and acted as private secretary to his father (1871-1881). In 1882 he became councillor to the embassy at London, in 1884 was transferred to St Petersburg, and in 1885 became under-secretary of state for foreign affairs. In 1884 he had been elected to the Reichstag, but had to resign his seat when, in 1886, he was made secretary of state for foreign affairs and Prussian minister. He conducted many of the negotiations with Great Britain on colonial affairs. He retired in 1890 at the same time as his father, and in 1893 was again elected to the Reichstag. He married Countess Margarete Hoyos in 1892, and died on the 18th of September 1904. He left two daughters and three sons, of whom the eldest, Otto Christian Archibald (b. 1897), succeeded to the princely title. The second son, Wilhelm, who was president of the province of Prussia, died in 1901. By his wife, Sybilla von Arnim-Kröchlendorff, he left three daughters and a son, Count Nikolaus (b. 1896).

AUTHORITIES.—The literature on Bismarck's life is very extensive, and it is only possible to enumerate a few of the most important books. The first place belongs to his own works. These include his own memoirs, published after his death, under the title *Gedanken und Erinnerungen*; there is an English translation, *Bismarck: his Reflections and Reminiscences* (London, 1898). They are incomplete, but contain very valuable discussions on particular points. The speeches are of the greatest importance both for his character and for political history; of the numerous editions that by Horst Kohl, is

12 vols. (Stuttgart, 1892-1894), is the best; there is a cheap edition in Reclam's *Universalbibliothek*. Bismarck was an admirable letter-writer, and numbers of his private letters have been published; a collected edition has been brought out by Horst Kohl. His letters to his wife were published by Prince Herbert Bismarck (Stuttgart, 1900). A translation of a small selection of the private letters was published in 1876 by F. Maxse. Of great value for the years 1851-1858 is the correspondence with General L. v. Gerlach, which has been edited by Horst Kohl (3rd ed., Berlin, 1893). A selection of the political letters was also published under the title *Politische Briefe aus dem Jahre 1849-1859* (2nd ed., Berlin, 1890). Of far greater importance are the collections of despatches and state papers edited by Herr v. Poschinger. These include four volumes entitled *Preussen im Bundesrat, 1851-1859* (4 vols., Leipzig, 1882-1888), which contain his despatches during the time he was at Frankfurt. Next in importance are two works, *Bismarck als Volkswirth und Aemterstücke zur Wirtschaftspolitik des Fürsten Bismarck*, which are part of the collection of state papers, *Aemterstücke zur Geschichte der Wirtschaftspolitik in Preussen*. They contain full information on Bismarck's commercial policy, including a number of important state papers. A useful general collection is that by Ludwig Hahn, *Bismarck, sein politisches Leben*, &c. (5 vols., Berlin, 1878-1891), which includes a selection from letters, speeches and newspaper articles. These collections have only been possible owing to the extreme generosity which Bismarck showed in permitting the publication of documents; he always professed to have no secrets. A full account of the diplomatic history from 1863 to 1866 is given by Sybel in *Die Begründung des deutschen Reichs* (Munich, 1889-1894), written with the help of the Prussian archives. The last two volumes, covering 1866-1870, are of less value, as he was not able to use the archives for this period. Poschinger has also edited a series of works in which anecdotes, minutes of interviews and conversations are recorded; they are, however, of very unequal value. They are *Bismarck und die Parlamentarier*, *Fürst Bismarck und der Bundesrath*, *Die Ansprache des Fürsten Bismarck, Neue Tischgespräche*, and *Bismarck und die Diplomaten*. Selections from these have been published in English by Charles Lowe, *The Tabletalk of Prince Bismarck*, and by Sidney Whitman, *Conversations with Bismarck*. By far the fullest guide to Bismarck's life is Horst Kohl's *Fürst Bismarck, Register zu einer wissenschaftlichen Biographie* (Leipzig, 1891-1892), which contains a record of Bismarck's actions on each day, with references to and extracts from his letters and speeches. For the works of Moritz Busch, which contain graphic pictures of his daily life, see the article *Busch*. Further materials were published periodically in the *Bismarck-Jahrbuch*, edited by Horst Kohl (Berlin, 1894-1896; Stuttgart, 1897-1899). Herr v. Poschinger also brought out a *Bismarck-Portefeuille*. Of German biographies may be mentioned Hans Blum, *Bismarck und seine Zeit* (6 vols., Munich, 1894-1895), with a volume of appendices, &c. (1898); Heyck, *Bismarck* (Bielefeld, 1898); Kreutzer, *Otto von Bismarck* (2 vols., Leipzig, 1900); Klein-Hattungen, *Bismarck und seine Welt, 1815-1871*, Bd. I. (Berlin, 1902); Lenz, *Geschichte Bismarcks* (Leipzig, 1902); Penzler, *Fürst Bismarck nach seiner Entlassung* (7 vols., ib. 1897-1898); Liman, one volume under the same title (ib. 1901). There are English biographies by Charles Lowe, *Bismarck, a Political Biography* (revised edition in 1 vol., 1895), by James Headlam (1890), and by F. Stearns (Philadelphia, 1900). A useful bibliography of all works on Bismarck up to 1895 is Paul Schulze and Otto Koller's *Bismarck-Literatur* (Leipzig, 1896). (J. W. H.E.)

BISMARCK, the capital of North Dakota, U.S.A., and the county-seat of Burleigh county, on the E. bank of the Missouri river, in the S. central part of the state. Pop. (1890) 2186; (1900) 3319, of whom 746 were foreign-born; (1905) 4913; (1910) 5443. It is on the main line of the Northern Pacific, and on the Minneapolis, St Paul & Sault Ste Marie railways; and steamboats run from here to Mannheim, Mercer county, and Fort Yates, Morton county. The city is about 1650 ft. above sea-level. It contains the state capitol, the state penitentiary, a U.S. land office, a U.S. surveyor-general's office, a U.S. Indian school and a U.S. weather station; about a mile S. of the city is Fort Lincoln, a United States army post. Bismarck is the headquarters for navigation of the upper Missouri river, is situated in a good agricultural region, and has a large wholesale trade, shipping grain, hides, furs, wool and coal. It was founded in 1873, and was chartered as a city in 1876; from 1883 to 1880 it was the capital of Dakota Territory, on the division of which it became the capital of North Dakota.

BISMARCK ARCHIPELAGO, the collective name of a large number of islands lying N. and N.E. of New Guinea, between 1° and 7° S., and 146° and 153° E., belonging to Germany. The largest island is New Pomerania, and the archipelago also includes New Mecklenburg, New Hanover, with small attendant islands, the Admiralty Islands and a chain of islands off the

coast of New Guinea, the whole system lying in the form of a great amphitheatre, of oval shape. The archipelago was named in honour of the first chancellor of the German empire, after a German protectorate had been declared in 1884. (See ADMIRALTY ISLANDS, NEW MECKLENBURG, NEW POMERANIA, NEW GUINEA.)

•BISMILLAH, an Arabic exclamation, meaning "in the name of God."

BISMUTH, a metallic chemical element; symbol Bi, atomic weight 208.5 (O=16). It was probably unknown to the Greeks and Romans, but during the middle ages it became quite familiar, notwithstanding its frequent confusion with other metals. In 1450 Basil Valentine referred to it by the name "wismut," and characterized it as a metal; some years later Paracelsus termed it "wiasmat," and, in allusion to its brittle nature, affirmed it to be a "bastard" or "half-metal"; Georgius Agricola used the form "wismuth," latinized to "bismutum," and also the term "plumbum cinereum." Its elementary nature was imperfectly understood; and the impure specimens obtained by the early chemists explain, in some measure, its confusion with tin, lead, antimony, zinc and other metals; in 1505 Andreas Libavius confused it with antimony, and in 1675 Nicolas Lemery with zinc. These obscurities began to be finally cleared up with the researches of Johann Heinrich Pott (1698-1777), a pupil of Stahl, published in his *Esercitantiones chemicæ de Wismutho* (1769), and of N. Geoffroy, son of Claude Joseph Geoffroy, whose contribution to our knowledge of this metal appeared in the *Mémoires de l'Académie française* for 1753. Torbern Olof Bergman reinvestigated its properties and determined its reactions; his account, which was published in his *Opuscula*, contains the first fairly accurate description of the metal.

Ores and Minerals.—The principal source of bismuth is the native metal, which is occasionally met with as a mineral, usually in reticulated and arborescent shapes or as foliated and granular masses with a crystalline fracture. Although bismuth is readily obtained in fine crystals by artificial means, yet natural crystals are rare and usually indistinct; they belong to the rhombohedral system and a cube-like rhombohedron with interfacial angles of 92° 20' is the predominating form. There is a perfect cleavage perpendicular to the trigonal axis of the crystals: the fact that only two (opposite) corners of the cube-like crystals can be truncated by cleavage at once distinguishes them from true cubes. When not tarnished, the mineral has a silver-white colour with a tinge of red, and the lustre is metallic. Hardness 2-2½; specific gravity 9.70-9.83. The slight variations in specific gravity are due to the presence of small amounts of arsenic, sulphur or tellurium, or to enclosed impurities.

Bismuth occurs in metalliferous veins traversing gneiss or clay-slate, and is usually associated with ores of silver and cobalt. Well-known localities are Schneeberg in Saxony and Joachimsthal in Bohemia; at the former it has been found as arborescent groups penetrating brown Jasper, which material has occasionally been cut and polished for small ornaments. The mineral has been found in some Cornish mines and is fairly abundant in Bolivia (near Sorata, and at Taana in Potosi). It is the chief commercial source of bismuth.

The oxide, bismuth ochre, Bi₂O₃, and the sulphide, bismuth glance or bismuthite, are also of commercial importance. The former is found, generally mixed with iron, copper and arsenic oxides, in Bohemia, Siberia, Cornwall, France (Meymac) and other localities; it also occurs admixed with bismuth carbonate and hydrate. The hydrated carbonate, bismutite, is of less importance; it occurs in Cornwall, Bolivia, Arizona and elsewhere.

Of the rarer bismuth minerals we may notice the following:—the complex sulphides, copper bismuth glance or wittichenite, BiCu₂S₅, silver bismuth glance, bismuth cobalt pyrites, bismuth nickel pyrites or saynite, needle ore (patrinite or aikinite), BiCuPbS₅, emplectite, CuBiS₂, and kobellite, BiAsPb₂S₅; the sulphotelluride tetradymite; the selenide guanajuatite, Bi₂Se,

the basic tellurate montanite, $\text{Bi}_2(\text{OH})_2\text{TeO}_4$; the silicates eulyptite and agricolite, $\text{Bi}_2(\text{SiO}_3)_2$; and the uranyl arsenate walpurgite, $\text{Bi}(\text{UO}_2)_2(\text{OH})_2(\text{AsO}_4)$.

Metallurgy.—Bismuth is extracted from its ores by dry, wet, or electro-metallurgical methods, the choice depending upon the composition of the ore and economic conditions. The dry process is more frequently practised, for the easy reducibility of the oxide and sulphide, together with the low melting-point of the metal, renders it possible to effect a ready separation of the metal from the gangue and impurities. The extraction from ores in which the bismuth is present in the metallic condition may be accomplished by a simple lixiviation, or melting, in which the temperature is just sufficient to melt the bismuth, or by a complete fusion of the ore. The first process never extracts all the bismuth, as much as one-third being retained in the matte or speiss; the second is more satisfactory, since the extraction is more complete, and also allows the addition of reducing agents to decompose any admixed bismuth oxide or sulphide. In the lixiviation process the ore is heated in inclined cylindrical retorts, and the molten metal is tapped at the lower end; the residues being removed from the upper end. The fusion process is preferably carried out in crucible furnaces; shaft furnaces are unsatisfactory on account of the disintegrating action of the molten bismuth on the furnace linings.

Sulphuretted ores are smelted, either with or without a preliminary calcination, with metallic iron; calcined ores may be smelted with carbon (coal). The reactions are strictly analogous to those which occur in the smelting of galena (see LEAD), the carbon reducing any oxide, either present originally in the ore or produced in the calcination, and the iron combining with the sulphur of the bismuthite. A certain amount of bismuth sulphate is always formed during the calcination; this is subsequently reduced to the sulphide and ultimately to the metal in the fusion. Calcination in reverberatory furnaces and a subsequent smelting in the same type of furnace with the addition of about 3% of coal, lime, soda and fluorspar, has been adopted for treating the Bolivian ores, which generally contain the sulphides of bismuth, copper, iron, antimony, lead and a little silver. The lowest layer of the molten mass is principally a metallic bismuth, the succeeding layers are a bismuth copper matte, which is subsequently worked up, and a slag. Ores containing the oxide and carbonate are treated either by smelting with carbon or by a wet process.

In the wet process the ores, in which the bismuth is present as oxide or carbonate, are dissolved out with hydrochloric acid, or, if the bismuth is to be extracted from a matte or alloy, the solvent employed is *agua regia* or strong sulphuric acid. The solution of metallic chlorides or sulphates so obtained is precipitated by iron, the metallic bismuth filtered, washed with water, pressed in canvas bags, and finally fused in graphite crucibles, the surface being protected by a layer of charcoal. Another process consists in adding water to the solution and so precipitating the bismuth as oxochloride, which is then converted into the metal.

The crude metal obtained by the preceding processes is generally contaminated by arsenic, sulphur, iron, nickel, cobalt and antimony, and sometimes with silver or gold. A dry method of purification consists in a lixiviation on a hearth of peculiar construction, which occasions the separation of the unreduced bismuth sulphide and the bulk of the other impurities. A better process is to remelt the metal in crucibles with the addition of certain refining agents. The details of this process vary very considerably, being conditioned by the composition of the impure metal and the practice of particular works. The wet refining process is more tedious and expensive, and is only exceptionally employed, as in the case of preparing the pure metal or its salts for pharmaceutical or chemical purposes. The basic nitrate is the salt generally prepared, and, in general outline, the process consists in dissolving the metal in nitric acid, adding water to the solution, boiling the precipitated basic nitrate with an alkali to remove the arsenic and lead, dissolving the residue in nitric acid, and reprecipitating as basic nitrate with water. J. F. W. Hamps prepared chemically pure bismuth by fusing the metal with sodium carbonate and sulphur, dissolving the bismuth sulphide so formed in nitric acid, precipitating the bismuth as the basic nitrate, redissolving this salt in nitric acid, and then precipitating with ammonia. The bismuth hydroxide so obtained is finally reduced by hydrogen.

Properties.—Bismuth is a very brittle metal with a white crystalline fracture and a characteristic reddish-white colour. It crystallizes in rhombohedra belonging to the hexagonal system, having interfacial angles of $87^\circ 40'$. According to C. W. A. Kahlbaum, Roth and Siedler (*Zeit. Anorg. Chem.*, 29, p. 294), its specific gravity is 9.78143; Roberts and Wrighton give the specific gravity of solid bismuth as 9.82, and of molten bismuth as 10.055. It therefore expands on solidification; and as it retains this property in a number of alloys, the metal receives extensive application in forming type-metals. Its melting-point is variously given as 268.3° (F. Rudberg and A. D. von Riemsdijk) and 270.8° (C. C. Person); commercial bismuth melts at 260° (Ledebur), and electrolytic bismuth at 264° (Classen). It vaporizes in a vacuum at 292° , and its boiling-point, under atmospheric pressure, is between 1000° and 1450° (T. Carmelley and W. C. Williams). Regnault determined its

specific heat between 0° and 100° to be 0.0308; Kahlbaum, Roth and Siedler (*loc. cit.*) give the value 0.0305. Its thermal conductivity is the lowest of all metals, being 18 as compared with silver as 1000; its coefficient of expansion between 0° and 100° is 0.00134. Its electrical conductivity is approximately 1.2, silver at 0° being taken as 100; it is the most diamagnetic substance known, and its thermoelectric properties render it especially valuable for the construction of thermopiles.

The metal oxidizes very slowly in dry air at ordinary temperatures, but somewhat more rapidly in moist air or when heated. In the last case it becomes coated with a greyish-black layer of an oxide (dioxide (?)), at a red heat the layer consists of the trioxide (Bi_2O_3), and is yellow or green in the case of pure bismuth, and violet or blue if impure; at a bright red heat it burns with a bluish flame to the trioxide. Bismuth combines directly with the halogens, and the elements of the sulphur group. It readily dissolves in nitric acid, *agua regia*, and hot sulphuric acid, but tardily in hot hydrochloric acid. It is precipitated as the metal from solutions of its salts by the metals of the alkalis and alkaline earths, zinc, iron, copper, &c. In its chemical affinities it resembles arsenic and antimony; an important distinction is that it forms no hydrogen compound analogous to arsine and stibine.

Alloys.—Bismuth readily forms alloys with other metals. Treated with sodammonium it yields a bluish-black mass, BiNa , which takes fire in the air and decomposes water. A brittle potassium alloy of silver-white colour and lamellar fracture is obtained by calcining 20 parts of bismuth with 16 of cream of tartar at a strong red heat. When present in other metals, even in very small quantity, bismuth renders them brittle and impairs their electrical conductivity. With mercury it forms amalgams. Bismuth is a component of many ternary alloys characterized by their low fusibility and expansion in solidification; many of them are used in the arts (see FUSIBLE METAL).

Compounds.—Bismuth forms four oxides, of which the trioxide, Bi_2O_3 , is the most important. This compound occurs in nature as bismuth ochre, and may be prepared artificially by oxidizing the metal at a red heat, or by heating the carbonate, nitrate or hydrate. Thus obtained it is a yellow powder, soluble in the mineral acids to form soluble salts, which are readily precipitated as basic salts when the solution is diluted. It melts to a reddish-brown liquid, which solidifies to a yellow crystalline mass on cooling. The hydrate, $\text{Bi}(\text{OH})_3$, is obtained as a white powder by adding potash to a solution of a bismuth salt. Bismuth dioxide, BiO or Bi_2O_2 , is said to be formed by the limited oxidation of the metal, and as a brown precipitate by adding mixed solutions of bismuth and stannous chlorides to a solution of caustic potash. Bismuth tetroxide, Bi_4O_7 , sometimes termed bismuth bismuthate, is obtained by melting bismuth trioxide with potash, or by igniting bismuth trioxide with potash and potassium chlorate. It is also formed by oxidizing bismuth trioxide suspended in caustic potash with chlorine, the pentoxide being formed simultaneously; oxidation and potassium ferricyanide simply gives the tetroxide (Hauser and Vanino, *Zeit. Anorg. Chem.*, 1904, 39, p. 381). The hydrate, $\text{Bi}_2\text{O}_3 \cdot 2\text{H}_2\text{O}$, is also known. Bismuth pentoxide, Bi_2O_5 , is obtained by heating bisruthic acid, HBiO_2 , to 130°C .; this acid (in the form of its salts) being the product of the continued oxidation of an alkaline solution of bismuth trioxide.

Bismuth forms two chlorides: BiCl_3 and BiCl_5 . The dichloride, BiCl_2 , is obtained as a brown crystalline powder by fusing the metal with the trichloride, or in a current of chlorine, or by heating the metal with calomel to 250° . Water decomposes it to metallic bismuth and the oxochloride, BiOCl . Bismuth trichloride, BiCl_3 , was obtained by Robert Boyle by heating the metal with corrosive sublimate. It is the final product of burning bismuth in an excess of chlorine. It is a white substance, melting at 225° – 230° and boiling at 435° – 441° . With excess of water, it gives a white precipitate of the oxochloride, BiOCl . Bismuth trichloride forms double compounds with hydrochloric acid, the chlorides of the alkaline metals, ammonia, nitric oxide and nitrosyl chloride. *Bismuth trifluoride*, BiF_3 , a white powder, *bismuth tribromide*, BiBr_3 , golden yellow crystals, *bismuth iodide*, BiI_3 , greyish-black crystals, are also known. These compounds closely resemble the trichloride in their methods of preparation and their properties, forming oxyhaloids with water, and double compounds with ammonia, &c.

Carbonates.—The basic carbonate, $2(\text{BiO})_2\text{CO}_3 \cdot \text{H}_2\text{O}$, obtained as a white precipitate when an alkaline carbonate is added to a solution of bismuth nitrate, is employed in medicine. Another basic carbonate, $3(\text{BiO})_2\text{CO}_3 \cdot 2\text{Bi}(\text{OH})_3 \cdot 3\text{H}_2\text{O}$, constitutes the mineral bismutite.

Nitrates.—The normal nitrate, $\text{Bi}(\text{NO}_3)_3 \cdot 5\text{H}_2\text{O}$, is obtained in large transparent asymmetric prisms by evaporating a solution of the metal in nitric acid. The action of water on this solution produces a crystalline precipitate of basic nitrate, probably $\text{Bi}(\text{OH})_2\text{NO}_3$, though it varies with the amount of water employed. This precipitate constitutes the "magistry of bismuth" or "subnitrate of bismuth" of pharmacy, and under the name of pearl white, *Blanc d'Espagne* or *Blanc de fard* has long been used as a cosmetic.

Sulphides.—Bismuth combines directly with sulphur to form a disulphide, Bi_2S_3 , and a trisulphide, Bi_2S_5 , the latter compound being formed when the sulphur is in excess. A hydrated disulphide, $\text{Bi}_2\text{S}_3 \cdot 2\text{H}_2\text{O}$, is obtained by passing sulphuretted hydrogen into a solution of bismuth nitrate and stannous chloride. Bismuth

disulphide is a grey metallic substance, which is decomposed by hydrochloric acid with the separation of metallic bismuth and the formation of bismuth trichloride. Bismuth trisulphide, Bi_2S_3 , constitutes the mineral bismuthite, and may be prepared by direct union of its constituents, or as a brown precipitate by passing sulphuretted hydrogen into a solution of a bismuth salt. It is easily soluble in nitric acid. When heated to 200° it assumes the crystalline form of bismuthite. Bismuth forms several oxysulphides: $\text{Bi}_2\text{O}_3\text{S}$ constitutes the mineral karelinite found at the Zavadinski mine in the Altai; $\text{Bi}_2\text{O}_3\text{S}_2$ and $\text{Bi}_2\text{O}_3\text{S}_3$ have been prepared artificially. Bismuth also forms the sulphohaloids, BiSCl , BiSBr , BiSI , analogous to the oxyhaloids.

Bismuth sulphate, $\text{Bi}_2(\text{SO}_4)_3$, is obtained as a white powder by dissolving the metal or sulphide in concentrated sulphuric acid. Water decomposes it, giving a basic salt, $\text{Bi}_2(\text{SO}_4)(\text{OH})_2$, which on heating gives $(\text{BiO})_2\text{SO}_4$. Other basic salts are known.

Bismuth forms compounds similar to the trisulphide with the elements selenium and tellurium. The tritelluride constitutes the mineral tetradymite, Bi_2Te_3 .

Analysis.—Traces of bismuth may be detected by treating the solution with excess of tartaric acid, potash and stannous chloride, a precipitate or dark coloration of bismuth oxide being formed even when only one part of bismuth is present in 20,000 of water. The blackish brown sulphide precipitated from bismuth salts by sulphuretted hydrogen is insoluble in ammonium sulphide, but is readily dissolved by nitric acid. The metal can be reduced by magnesium, zinc, cadmium, iron, tin, copper and substances like hypophosphorous acid from acid solutions or from alkaline ones by formaldehyde. In quantitative estimations it is generally weighed as oxide, after precipitation as sulphide or carbonate, or in the metallic form, reduced as above.

Pharmacology.—The salts of bismuth are feebly antiseptic. Taken internally the subnitrate, coming into contact with water, tends to decompose, gradually liberating nitric acid, one of the most powerful antiseptics. The physical properties of the powder also give it a mild astringent action. There are no remote actions.

Therapeutics.—The subnitrate of bismuth is invaluable in certain cases of dyspepsia, and still more notably so in diarrhoea. It owes its value to the decomposition described above, by means of which a powerful antiseptic action is safely and continuously exerted. There is hardly a safer drug. It may be given in drachm doses with impunity. It colours the faeces black owing to the formation of sulphide.

BISMUTHITE, a somewhat rare mineral, consisting of bismuth trisulphide, Bi_2S_3 . It crystallizes in the orthorhombic system and is isomorphous with stibnite (Sb_2S_3), which it closely resembles in appearance. It forms loose interlacing aggregates of acicular crystals without terminal faces (only in a single instance has a terminated crystal been observed), or as masses with a foliated or fibrous structure. An important character is the perfect cleavage in one direction parallel to the length of the needles. The colour is lead-grey inclining to tin-white and often with a yellowish or iridescent tarnish. The hardness is 2; specific gravity 6.4-6.5. Bismuthite occurs at several localities in Cornwall and Bolivia, often in association with native bismuth and tin-ores. Other localities are known; for instance, Brandy Gill in Caldbeck Fells, Cumberland, where with molybdenite and apatite it is embedded in white quartz. The mineral was known to A. Cronstedt in 1758, and was named bismuthine by F. S. Brøndant in 1832. This name, which is also used in the forms bismuthite and bismuthinite, is rather unfortunate, since it is readily confused with bismite (bismuth oxide) and bismutite (basic bismuth carbonate), especially as the latter has also been used in the form bismuthite. The name bismuth-glance or bismutholamprite for the species under consideration is free from this objection.

(L. J. S.)

BISBYA, a group of ruin mounds, about 1 m. long and $\frac{1}{2}$ m. wide, consisting of a number of low ridges, nowhere exceeding 40 ft. in height, lying in the Jezireh, somewhat nearer to the Tigris than the Euphrates, about a day's journey to the south-east of Nippur, a little below 32° N. and about $45^\circ 40'$ E. Excavations conducted here for six months, from Christmas of 1903 to June 1904, for the university of Chicago, by Dr Edgar J. Banks, proved that these mounds covered the site of the ancient city of Adab (Ud-Nun), hitherto known only from a brief mention of its name in the introduction to the Khammurabi code (c. 2250 B.C.). The city was divided into two parts by a canal, on an island in which stood the temple, E-mach, with a *siggur*, or stage tower. It was evidently once a city of considerable importance, but

deserted at a very early period, since the ruins found close to the surface of the mounds belong to Dungi and Ur Gur, kings of Ur in the earlier part of the third millennium B.C. Immediately below these, as at Nippur, were found the remains of Naram-Sin and Sar-gon, c. 3000 B.C. Below these there were still 35 ft. of stratified remains, constituting seven-eighths of the total depth of the ruins. Besides the remains of buildings, walls, graves, &c., Dr Banks discovered a large number of inscribed clay tablets of a very early period, bronze and stone tablets, bronze implements and the like. But the two most notable discoveries were a complete statue in white marble, apparently the most ancient yet found in Babylonia (now in a museum in Constantinople), bearing the inscription—"E-mach, King Da-udu, King of Ud-Nun"; and a temple refuse heap, consisting of great quantities of fragments of vases in marble, alabaster, onyx, porphyry and granite, some of which were inscribed, and others engraved and inlaid with ivory and precious stones. (J. P. F.)

BISON, the name of the one existing species of European wild ox, *Bos (Bison) bonasus*, known in Russian as *subr*. Together with the nearly allied New World animal known in Europe as the (North) American bison, but in its own country as "buffalo," and scientifically as *Bos (Bison) bison*, the bison represents a group of the ox tribe distinguished from other species by the greater breadth and convexity of the forehead, superior length of limb, and the longer spinal processes of the dorsal vertebrae, which, with the powerful muscles attached for the support of the massive head, form a protuberance or hump on the shoulders. The bisons have also fourteen pairs of ribs, while the common ox has only thirteen. The forehead and neck of both species are covered with long, shaggy hair of a dark brown colour; and in winter the whole of the neck, shoulders and hump are similarly clothed, so as to form a curly, felted mane. This mane in the European species disappears in summer; but in the American bison it is to a considerable extent persistent.

The bison is now the largest European quadruped, measuring about 10 ft. long, exclusive of the tail, and standing nearly 6 ft. high. Formerly it was abundant throughout Europe, as is proved by the fossil remains of this or a closely allied form found on the continent and in England, associated with those of the extinct mammoth and rhinoceros. Caesar mentions the bison as abounding, along with the extinct aurochs or wild ox, in the forests of Germany and Belgium, where it appears to have been occasionally captured and afterwards exhibited alive in the Roman amphitheatres. At that period, and long after, it seems to have been common throughout central Europe, as we learn from the evidence of Herberstein in the 16th century. Nowadays bison are found in a truly wild condition only in the forests of the Caucasus, where they are specially protected by the Russian government. There is, however, a herd, somewhat in the condition of park-animals, in the forest of Byelovitsa, in Lithuania, where it is protected by the tsar, but nevertheless is gradually dying out. In 1862 the Lithuanian bisons numbered over 1200, but by 1872 they had diminished to 528, and in 1892 there were only 491. The prince of Pless has a small herd at Promnitz, his Silesian estate, founded by the gift of a bull and three cows by Alexander II. in 1855, his herd being the source of the menagerie supply.

Bison feed on a coarse aromatic grass, and browse on the leaves, shoots, bark and twigs of trees.

The American bison is distinguished from its European cousin by the following among other features: The hind-quarters are weaker and fall away more suddenly, while the withers are proportionately higher. Especially characteristic is the great mass of brown or blackish brown hair clothing the head, neck and forepart of the body. The shape of the skull and horns is also different; the horns themselves being shorter, thicker, blunter and more sharply curved, while the forehead of the skull is more convex and the sockets of the eyes are more distinctly tubular. This species formerly ranged over a third of North America in countless numbers, but is now practically extinct. The great herd was separated into a northern and

southern division by the completion of the Union Pacific railway, and the annual rate of destruction from 1870 to 1875 has been estimated at 2,500,000 head. In 1880 the completion of the Northern Pacific railway led to an attack upon the northern herd. The last of the Dakota bisons were destroyed by Indians in 1883, leaving then less than 1000 wild individuals in the United States.

A count which was concluded at the end of February 1903, put the number of captive bisons at 1119, of which 969 were in parks and zoological gardens in the United States, 41 in Canada and 109 in Europe. At the same time it was estimated that there were 34 wild bison in the United States and 600 in Canada.

In England small herds are kept by the duke of Bedford at Woburn Abbey, Bedfordshire, and by Mr C. J. Leyland at Haggerston Castle, Northumberland.

Two races of the American bison have been distinguished—the typical prairie form, and the woodland race, *B. bison atkabscae*; but the two are very similar. (R. L.)*

BISQUE (a French word of unknown origin, formerly spelt in English "biak"), a term for odds given in the games of tennis, lawn tennis, croquet and golf; in the two former a bisque is one point to be taken at any time during a "set" at the choice of the receiver of the odds, while in croquet and golf it is one extra stroke to be taken similarly during a game. The name is given, in cookery, to a thick soup, made particularly of crayfish or lobsters.

BISSELL, GEORGE EDWIN (1839-), American sculptor, son of a quarryman and marble-cutter, was born at New Preston, Connecticut, on the 16th of February 1839. During the Civil War he served as a private in the 23rd Connecticut volunteers in the Department of the Gulf (1862-1863), and on being mustered out became acting assistant paymaster in the South Atlantic squadron. At the close of the war he joined his father in business. He studied the art of sculpture abroad in 1875-1876, and lived much in Paris during the years 1883-1896, with occasional visits to America. Among his more important works are the soldiers' and sailors' monument, and a statue of Colonel Chatfield, at Waterbury, Connecticut; and statues of General Gates at Saratoga, New York, of Chancellor John Watts in Trinity churchyard, New York City; of Colonel Abraham de Peyster in Bowling Green, New York City; of Abraham Lincoln at Edinburgh; of Burns and "Highland Mary," in Ayr, Scotland; of Chancellor James Kent, in the Congressional library, Washington; and of President Arthur in Madison Square, New York City.

BISSEXT, or **BISSEXTRUS** (Lat. *bis*, twice; *sextus*, sixth), the day intercalated by the Julian calendar in the February of every fourth year to make up the six hours by which the solar year was computed to exceed the year of 365 days. The day was inserted after the 24th of February, i.e. the 6th day before the calends (1st) of March; there was consequently, besides the *sextus*, or sixth before the calends, the *bis-sextus* or "second sixth," our 25th of February. In modern usage, with the exception of ecclesiastical calendars, the intercalary day is added for convenience at the end of the month, and years in which February has 29 days are called "bissextile," or leap-years.

BISTRE, the French name of a brown paint made from the soot of wood, now largely superseded by Indian ink.

BIT (from the verb "to bite," either in the sense of a piece bitten off, or an act of biting, or a thing that bites or is bitten), generally, a piece of anything; the word is, however, used in various special senses, all derivable from its origin, either literally or metaphorically. The most common of these are (1) its use as the name of various tools, e.g. centre-bit; (2) a horse's "bit," or the metal mouth-piece of the bridle; (3) in money, a small sum of money of varying value (e.g. threepenny-bit), especially in the West Indies and southern United States.

BITHUR, a town in the Cawnpore district of the United Provinces of India, 12 m. N.W. of Cawnpore city. Pop. (1901) 7173. It is chiefly notable for its connexion with the mutiny of 1857. The last of the peshwas, Baji Rao, was banished to Bithur, and his adopted son, the Nana Sahib, made the town his head-

quarters. It was captured by Havelock on the 19th of July 1857, when the Nana's palaces were destroyed.

BITHYNIA (*Bithynia*), an ancient district in the N.W. of Asia Minor, adjoining the Propontis, the Thracian Bosphorus and the Euxine. According to Strabo it was bounded on the E. by the river Sangarius; but the more commonly received division extended it to the Parthenius, which separated it from Paphlagonia, thus comprising the district inhabited by the Mariandyni. On the W. and S.W. it was separated from Mysia by the river Rhyndacus; and on the S. it adjoined Phrygia Epictetus and Galatia. It is in great part occupied by mountains and forests, but has valleys and districts near the sea-coast of great fertility. The most important mountain range is the (so-called) "Mysian" Olympus (7600 ft.), which towers above Brusa and is clearly visible as far away as Constantinople (70 m.). Its summits are covered with snow for a great part of the year. East of this the range now called Ala-Dagh extends for above 100 m. from the Sangarius to Paphlagonia. Both of these ranges belong to that border of mountains which bounds the great tableland of Asia Minor. The country between them and the coast, covered with forests and traversed by few lines of route, is still imperfectly known. But the broad tract which projects towards the west as far as the shores of the Bosphorus, though hilly and covered with forests—the Turkish Aghatch Deniz, or "The Ocean of Trees"—is not traversed by any mountain chain. The west coast is indented by two deep inlets, (1) the northernmost, the Gulf of Ismid (anc. Gulf of Asiaticus), penetrating between 40 and 50 m. into the interior as far as Ismid (anc. Nicomedia), separated by an isthmus of only about 25 m. from the Black Sea; (2) the Gulf of Mudania or Gemlik (Gulf of Cius), about 25 m. long. At its extremity is situated the small town of Gemlik (anc. Cius) at the mouth of a valley, communicating with the lake of Isnik, on which was situated Nicaea.

The principal rivers are the Sangarius (mod. Sakaria), which traverses the province from south to north; the Rhyndacus, which separated it from Mysia; and the Billaeus (Filyas), which rises in the Ala-Dagh, about 50 m. from the sea, and after flowing by Boli (anc. Claudiopolis) falls into the Euxine, close to the ruins of the ancient Tium, about 40 m. north-east of Heraclea, having a course of more than 100 m. The Parthenius (mod. Bartan), the boundary of the province towards the east, is a much less considerable stream.

The natural resources of Bithynia are still imperfectly developed. Its vast forests would furnish an almost inexhaustible supply of timber, if rendered accessible by roads. Coal also is known to exist near Ereğli (Heraclea). The valleys towards the Black Sea abound in fruit trees of all kinds, while the valley of the Sangarius and the plains near Brusa and Isnik (Nicaea) are fertile and well cultivated. Extensive plantations of mulberry trees supply the silk for which Brusa has long been celebrated, and which is manufactured there on a large scale.

According to ancient authors (Herodotus, Xenophon, Strabo, &c.), the Bithynians were an immigrant Thracian tribe. The existence of a tribe called Thyni in Thrace is well attested, and the two cognate tribes of the Thyni and Bithyni appear to have settled simultaneously in the adjoining parts of Asia, where they expelled or subdued the Mysians, Caucones, and other petty tribes, the Mariandyni alone maintaining themselves in the north-east. Herodotus mentions the Thyni and Bithyni as existing side by side; but ultimately the latter must have become the more important, as they gave their name to the country. They were incorporated by Croesus with the Lydian monarchy, with which they fell under the dominion of Persia (546 B.C.), and were included in the satrapy of Phrygia, which comprised all the countries up to the Hellespont and Bosphorus. But even before the conquest by Alexander the Bithynians appear to have asserted their independence, and successfully maintained it under two native princes, Bas and Zipoetes, the last of whom transmitted his power to his son Nicomedes I., the first to assume the title of king. This monarch founded Nicomedia, which soon rose to great prosperity, and during his long reign (278-250 B.C.), as well as those of his successors, Prusias I.,

Prusias II. and Nicomedes II. (149-91 B.C.), the kingdom of Bithynia held a considerable place among the minor monarchies of Asia. But the last king, Nicomedes III., was unable to maintain himself against Mithradates of Pontus, and, after being restored to his throne by the Roman senate, he bequeathed his kingdom by will to the Romans (74 B.C.). Bithynia now became a Roman province. Its limits were frequently varied, and it was commonly united for administrative purposes with the province of Pontus. This was the state of things in the time of Trajan, when the younger Pliny was appointed governor of the combined provinces (103-105 A.D.), a circumstance to which we are indebted for valuable information concerning the Roman provincial administration. Under the Byzantine empire Bithynia was again divided into two provinces, separated by the Sangarius, to the west of which the name of Bithynia was restricted.

The most important cities were Nicomedia and Nicaea, which disputed with one another the rank of capital. Both of these were founded after Alexander the Great; but at a much earlier period the Greeks had established on the coast the colonies of Cius (afterwards Prusias, mod. Gemlik); Chalcedon, at the entrance of the Bosphorus, nearly opposite Constantinople; and Heraclea Pontica, on the Euxine, about 120 m. east of the Bosphorus. All these rose to be flourishing places of trade, as also Prusa at the foot of M. Olympus (see BAUSA). The only other places of importance at the present day are Ismid (Nicomedia) and Scutari.

See C. Texier, *Asie Mineure* (Paris, 1839); G. Perrot, *Galatie et Bithynie* (Paris, 1862); W. von Diebst in *Petermanns Mittheilungen*, Ergänzungsheft, 116 (Gotha, 1895). (E. H. B.; F. W. H.A.)

BITLIS, or **BEYLIS** (Arm. *Paghesh*), the chief town of a vilayet of the same name in Asiatic Turkey, situated at an altitude of 4700 ft., in the deep, narrow valley of the Bitlis Chai, a tributary of the Tigris. The main part of the town and the bazaars are crowded alongside the stream, while suburbs with scattered houses among orchards and gardens extend up two tributary streams. The houses are massive and well built of a soft volcanic tufa, and with their courtyards and gardens climbing up the hillsides afford a striking picture. At the junction of two streams in the centre of the town is a fine old castle, partly ruined, which, according to local tradition, occupies the site of a fortress built by Alexander the Great. It is apparently an Arab building, as Arabic inscriptions appear on the walls, but as the town stands on the principal highway between the Van plateau and the Mesopotamian plain it must always have been of strategic importance. The bazaars are crowded, covered across with branches in summer, and typical of a Kurdish town. The population numbers 35,000, of whom about 12,000 are Armenians and the remainder are Kurds or of Kurdish descent.

Kurdish beys and sheiks have much influence in the town and wild mountain districts adjoining, while the Sasun mountains, the scene of successive Armenian revolutions of late years, are not far off to the west. The town was ruled by a semi-independent Kurdish bey as late as 1836. There are some fine old mosques and *medresses* (colleges), and the Armenians have a large monastery and churches. There are British, French and Russian consuls in the town, and a branch of the American Mission with schools is established also. The climate is healthy and the thermometer rarely falls below 0° Fahr., but there is a heavy snowfall and the narrow streets are blocked for some five months in the year.

A good road runs southward down the pass, passing after a few miles some large chalybeate and sulphur springs. Roads also lead north to Mush and Erzerum and along the lake to Van. Postal communication is through Erzerum with Trebizond. Tobacco of an inferior quality is largely grown, and the chief industry is the weaving of a coarse red cloth. Manna and gum tragacanth are also collected. Fruit is also plentiful, and there are many vineyards close by.

The Bitlis vilayet comprises a very varied section of Asiatic Turkey, as it includes the Mush plain and the plateau country west of Lake Van, as well as a large extent of wild mountain

districts inhabited by turbulent Kurds and Armenians on either side of the central town of Bitlis, also some of the lower country about Sairt along the left bank of the main stream of the Tigris. The mountains have been little explored, but are believed to be rich in minerals, iron, lead, copper, traces of gold and many mineral springs are known to exist. (F. R. M.)

BITONTO (anc. *Butuntis*), a town and episcopal see of Apulia, Italy, in the province of Bari, 10 m. west by steam tramway from Bari. Pop. (1901) 30,617. It was a place of no importance in classical times. Its medieval walls are still preserved. Its cathedral is one of the finest examples of the Romanesque architecture of Apulia, and has escaped damage from later restorations. The palazzo Sylos-Labini has a fine Renaissance court of 1501.

BITSCH (Fr. *Büche*), a town of Germany, in Alsace-Lorraine, on the Horn, at the foot of the northern slope of the Vosges between Hagenau and Saargemünd. Pop. (1905) 4000. There are a Roman Catholic and a Protestant church, a classical school and an academy of forestry. The industries include shoe-making and watch-making, and there is some trade in grain and timber. The town of Bitsch, which was formed out of the villages of Rohr and Kaltenhausen in the 17th century, derives its name from the old stronghold (mentioned in 1172 as Bytys Castrum) standing on a rock some 250 ft. above the town. This had long given its name to the countship of Bitsch, which was originally in the possession of the dukes of Lorraine. In 1297 it passed by marriage to Eberhard I. of Zweibrücken, whose line became extinct in 1569, when the countship reverted to Lorraine. It passed with that duchy to France in 1766. After that date the town rapidly increased in population. The citadel, which had been constructed by Vauban on the site of the old castle after the capture of Bitsch by the French in 1624, had been destroyed when it was restored to Lorraine in 1698. This was restored and strengthened in 1740 into a fortress that proved impregnable in all succeeding wars. The attack upon it by the Prussians in 1793 was repulsed; in 1815 they had to be content with blockading it; and in 1870, though it was closely invested by the Germans after the battle of Wörth, it held out until the end of the war. A large part of the fortification is excavated in the red sandstone rock, and rendered bomb-proof; a supply of water is secured to the garrison by a deep well in the interior.

BITTER, KARL THEODORE FRANCIS (1867-), American sculptor, was born in Vienna on the 6th of December 1867. After studying art there, in 1889 he removed to the United States, where he became naturalized. In America he gained great popularity as a sculptor, and in 1906-1907 was president of the National Sculpture Society, New York. Among his principal works are: the Astor memorial gates, Trinity church, New York; "Elements Controlled and Uncontrolled," on the Administration Building at the Chicago Exposition; a large relief, "Triumph of Civilization," in the waiting-room of the Broad Street station of the Pennsylvania railway in Philadelphia; decorations for the Dewey Naval Arch in New York City; the "Standard Bearers," at the Pan-American Exposition grounds; a sitting statue and a bust of Dr Pepper, provost of the University of Pennsylvania; and the Villard and Hubbard memorials in the New York chamber of commerce.

BITTERFELD, a town of Germany, in the Prussian province of Saxony, 26 m. N from Leipzig by rail, on the river Mulde, and an important junction of railways from Leipzig and Halle to Berlin. Pop. (1900) 11,839. It manufactures drain-pipes, paper-roofing and machinery, and has saw-mills. Several coal-mines are in the vicinity. The town was built by a colony of Flemish immigrants in 1153. It was captured by the landgrave of Meissen in 1476, and belonged thenceforth to Saxony, until it was ceded to Prussia in 1815. Owing to its pleasant situation and accessibility, it has become a favourite residence of business men of Leipzig and Halle.

BITTERLING (*Rhodeus amarus*), a little carp-like fish of central Europe, belonging to the Cyprinid family. In it we have a remarkable instance of symbiosis. The genital papilla of the female acquires a great development during the breeding season and becomes produced into a tube nearly as long as the

fish itself; this acts as an ovipositor by means of which the comparatively few and large eggs (3 millimetres in diameter) are introduced through the gaping valves between the branchiae of pond mussels (*Unio* and *Anodonta*), where, after being inseminated, they undergo their development, the fry leaving their host about a month later. The mollusc reciprocates by throwing off its embryos on the parent fish, in the skin of which they remain encysted for some time, the period of reproduction of the fish and mussel coinciding.

BITTERN, a genus of wading birds, belonging to the family *Ardeidae*, comprising several species closely allied to the herons, from which they differ chiefly in their shorter neck, the back of which is covered with down, and the front with long feathers, which can be raised at pleasure. They are solitary birds, frequenting countries possessing extensive swamps and marshy grounds, remaining at rest by day, concealed among the reeds and bushes of their haunts, and seeking their food, which consists of fish, reptiles, insects and small quadrupeds, in the twilight. The common bittern (*Botaurus stellaris*) is nearly as large as the heron, and is widely distributed over the eastern hemisphere. Formerly it was common in Britain, but extensive drainage and persecution



Bittern.

have greatly diminished its numbers and it is now only an uncertain visitor. Not a winter passes without its appearing in some numbers, when its uncommon aspect, its large size, and beautifully pencilled plumage cause it to be regarded as a great prize by the lucky gun-bearer to whom it falls a victim. Its value as a delicacy for the table, once so highly esteemed, has long vanished. The old fable of this bird inserting its beak into a reed or plunging it into the ground, and so causing the booming sound with which its name will be always associated, is also exploded, and nowadays indeed so few people in Britain have ever heard its loud and awful voice, which seems to be uttered only in the breeding-season, and is therefore unknown in a country where it no longer breeds, that incredulity as to its booming at all has in some quarters succeeded the old belief in this as in other reputed peculiarities of the species. The bittern in the days of falconry was strictly preserved, and afforded excellent sport. It sits crouching on the ground during the day, with its bill pointing in the air, a position from which it is not easily roused, and even when it takes wing, its flight is neither swift nor long sustained. When wounded it requires to be approached with caution, as it will then attack either man or dog with its long sharp bill and its acute claws. It builds a rude nest among the reeds and flags, out of the materials which surround it, and

the female lays four or five eggs of a brownish olive. During the breeding season it utters a booming noise, from which it probably derives its generic name, *Botaurus*, and which has made it in many places an object of superstitious dread. Its plumage for the most part is of a pale buff colour, rayed and speckled with black and reddish brown. The American bittern (*Botaurus lentiginosus*) is somewhat smaller than the European species, and is found throughout the central and southern portions of North America. It also occurs in Britain as an occasional straggler. It is distinguishable by its uniform greyish-brown primaries, which want the tawny bars that characterize *B. stellaris*. Both species are good eating.

BITTERN (from "bitter"), the mother liquor obtained from sea-water or brines after the separation of the sodium chloride (common salt) by crystallization. It contains various magnesium salts (sulphate, chloride, bromide and iodide) and is employed commercially for the manufacture of Epsom salts (magnesium sulphate) and bromine. The same term is applied to a mixture of quassia, iron sulphate, *cocculus indicus*, liquorice, &c., used in adulterating beer.

BITTERS, the name given to aromatized (generally alcoholic) beverages containing a bitter substance or substances, used as tonics, appetizers or digestives. The bitterness is imparted by such substances as bitter orange rind, gentian, rhubarb, quassia, cascarilla, angostura, quinine and cinchona. Juniper, cinnamon, caraway, camomile, cloves and other flavouring agents are also employed in conjunction with the bitter principles, alcohol and sugar. Some bitters are prepared by simple maceration and subsequent filtration (see LIQUEURS), others by the more complicated distillation process. Those prepared by the latter process are the finer commercial articles. Bitters are usually sold under the name of the substance which has been used to give them the predominant flavour, such as orange, angostura or peach bitters, &c. The alcoholic strength of bitters varies, but is generally in the neighbourhood of 40% of alcohol. Some bitters, although possessing tonic properties, may be regarded as beverages pure and simple, notwithstanding the fact that they are seldom consumed in an undiluted state; others again, are obviously medicinal preparations and should be treated as such.

BITUMEN, the name applied by the Romans to the various descriptions of natural hydrocarbons, the word *petroleum* not being used in classical Latin. In its widest sense it embraces the whole range of these substances, including *natural gas*, the more or less liquid descriptions of *petroleum*, and the solid forms of *asphalt*, *albertite*, *gilsonite* or *uinshite*, *elaterite*, *azokerite* and *halchettite*. To distinguish bitumen intermediate in consistency between asphalt and the more liquid kinds of crude petroleum, the term *maltha* (Latin) is frequently employed. The bitumens of chief commercial importance may be grouped under the three headings of (1) *natural gas*, (2) *petroleum*, and (3) *asphalt*, and will be found fully described under these titles. In the scriptures there are numerous references to bitumen, among which the following may be quoted:—In Genesis ix. 3, we are told that in the building of the tower of Babel "slime had they for mortar," and in Genesis xiv. 10, that the vale of Siddim "was full of slime-pits," the word *slime* in the latter quotation from our version appearing as *bitumen* in the Vulgate. Herodotus alludes to the use of the bitumen brought down by the Is, a tributary of the Euphrates, as mortar in building the walls of Babylon. Diodorus, Curtius, Josephus, Bochart and others make similar mention of this use of bitumen, and Vitruvius tells us that it was employed in admixture with clay.

In its various forms, bitumen is one of the most widely distributed of substances. It occurs, though sometimes only in small quantity, in almost every part of the globe, and throughout the whole range of geological strata, from the Laurentian rocks to the most recent members of the Quaternary period. Although the gaseous and liquid forms of bitumen may be regarded as having been formed in the strata in which they are found or as having been received into such strata shortly after formation, the semi-solid and solid varieties may be considered to have been produced by the oxidation and evaporation of

liquid petroleum escaping from underlying or better preserved deposits into other strata, or into fissures where atmospheric action and loss of the more volatile constituents can take place. It should, however, be stated that there is some difference of opinion as to the precise manner of production of some of the solid forms of bitumen, and especially of ozokerite. (B. R.)

BITURIGES, a Celtic people, according to Livy (v. 34) the most powerful in Gaul in the time of Tarquinus Priscus. At some period unknown they split up into two branches—Bituriges Cubi and Bituriges Vivisci. The name is supposed to mean either "rulers of the world" or "perpetual kings."

The Bituriges Cubi, called simply Bituriges by Caesar, in whose time they acknowledged the supremacy of the Aedui, inhabited the modern diocese of Bourges, including the departments of Cher and Indre, and partly that of Allier. Their chief towns were Avaricum (Bourges), Argentomagus (Argenton-sur-Creuse), Neriomagus (Néris-les-Bains), Noviodunum (perhaps Villate). At the time of the rebellion of Vercingetorix (52 B.C.), Avaricum, after a desperate resistance, was taken by assault, and the inhabitants put to the sword. In the following year, the Bituriges submitted to Caesar, and under Augustus they were incorporated (in 28 B.C.) in Aquitania. Pliny (*Nat. Hist.* iv. 109) speaks of them as *liberi*, which points to their enjoying a certain amount of independence under Roman government. The district contained a number of iron works, and Caesar says they were skilled in driving galleries and mining operations.

The Bituriges Vivisci occupied the strip of land between the sea and the left bank of the Garonne, comprising the greater part of the modern department of Gironde. Their capital was Burdigala (Bordeaux), even then a place of considerable importance and a wine-growing centre. Like the Cubi, they also are called *liberi* by Pliny.

See A. Desjardins, *Géographie historique de la Gaule romaine*, ii. (1876-1893); A. Longnon, *Géographie de la Gaule au VI^e siècle* (1876); A. Holder, *All-celtischer Sprachschatz*; T. R. Holmes, *Caesar's Conquest of Gaul* (1899).

BITZIUS, ALBRECHT (1797-1854), Swiss novelist, best known by his pen name of "Jeremias Gotthelf," was born on the 4th of October 1797 at Morat, where his father was pastor. In 1804 the home was moved to Utzenstorf, a village in the Bernese Emmenthal. Here young Bitzius grew up, receiving his early education and consorting with the boys of the village, as well as helping his father to cultivate his gleebe. In 1812 he went to complete his education at Bern, and in 1820 was received as a pastor. In 1821 he visited the university of Göttingen, but returned home in 1822 to act as his father's assistant. On his father's death (1824) he went in the same capacity to Herzogenbuchsee, and later to Bern (1826). Early in 1831 he went as assistant to the aged pastor of the village of Lützelflüh, in the Upper Emmenthal (between Langnau and Burgdorf), being soon elected his successor (1832) and marrying one of his granddaughters (1833). He spent the rest of his life there, dying on the 22nd of October 1854, and leaving three children (the son was a pastor, the two daughters married pastors). His first work, the *Bauernspiegel*, appeared in 1837. It purported to be the life of Jeremias Gotthelf, narrated by himself, and this name was later adopted by the author as his pen name. It is a living picture of Bernese (or, strictly speaking, Emmenthal) village life, true to nature, and not attempting to gloss over its defects and failings. It is written (like the rest of his works) in the Bernese dialect of the Emmenthal, though it must be remembered that Bitzius was not (like Auerbach) a peasant by birth, but belonged to the educated classes, so that he reproduces what he had seen and learnt, and not what he had himself personally experienced. The book was a great success, as it was a picture of real life, and not of fancifully beribboned 18th-century villagers. Among his later tales are the *Leiden und Freuden eines Schulmeisters* (1838-1839), *Uli der Knecht* (1841), with its continuation, *Uli der Pächter* (1849), *Anne Bubi Joubert* (1843-1844), *Käthi die Grossmutter* (1847), *Die Käseri in der Vefreude* (1850), and the *Erlebnisse eines Schuldenbauers* (1854). He published also several volumes of shorter tales. One slight

drawback to some of his writings is the echo of local political controversies, for Bitzius was a Whig and strongly opposed to the Radical party in the canton, which carried the day in 1846.

Lives by C. Manuel, in the Berlin edition of Bitzius's works (Berlin, 1861), and by J. Ammann in vol. i. (Bern, 1884) of the *Sammlung Bernischer Biographien*. His works were issued in 24 vols. at Berlin, 1856-1861, while 10 vols., giving the original text of each story, were issued at Bern, 1898-1900 (edition not to be completed). (W. A. B. C.)

BIVOUCAC (a French word generally said to have been introduced during the Thirty Years' War, perhaps derived from *Beiwacht*, extra guard), originally, a night-watch by a whole army under arms to prevent surprise. In modern military parlance the word is used to mean a temporary encampment in the open field without tents, as opposed to "billets" or "cantonment" on the one hand and "camp" on the other. The use of bivouacs permits an army to remain closely concentrated for all emergencies, and avoids the necessity for numerous wagons carrying tents. Constant bivouacs, however, are trying to the health of men and horses, and this method of quartering is never employed except when the military situation demands concentration and readiness. Thus the outposts would often have to bivouac while the main body of the army lay in billets.

BIWA, a lake in the province of Omi, Japan. It measures 36 m. in length by 12 m. in extreme breadth, has an area of 180 sq. m., is about 330 ft. above sea-level, and has an extreme depth of some 300 ft. There are a few small islands in the lake, the principal being Chikubu-shima at the northern end.

Tradition alleges that Lake Biwa and the mountain of Fuji were produced simultaneously by an earthquake in 286 B.C. On the west of the lake the mountains Hiei-zan and Hira-yama slope down almost to its margin, and on the east a wide plain extends towards the boundaries of the province of Mino. It is drained by a river flowing out of its southern end, and taking its course into the sea at Osaka. This river bears in succession the names of Seta-gawa, Uji-gawa and Yodo-gawa. The lake abounds with fish, and the beauty of its scenery is remarkable. Small steamboats ply constantly to the points of chief interest, and around its shores are to be viewed the *Omi-no-hakki*, or "eight landscapes of Omi"; namely, the lake silvering under an autumn moon as one looks down from Ishi-yama; the snow at eve on Hira-yama; the glow of sunset at Seta; the groves and classic temple of Mii-dera as the evening bell sounds; boats sailing home from Yabase; cloudless peaks at Awazu; rain at nightfall over Karasaki; and wild geese sweeping down to Katata. The lake is connected with Kyoto by a canal constructed in 1890, and is thus brought into water communication with Osaka.

BIXIO, NINO (1821-1873), Italian soldier, was born on the 2nd of October 1821. While still a boy he was compelled by his parents to embrace a maritime career. After numerous adventures he returned to Italy in 1846, joined the Giovine Italia, and, on 4th November 1847, made himself conspicuous at Genoa by seizing the bridle of Charles Albert's horse and crying, "Pass the Ticino, Sire, and we are all with you." He fought through the campaign of 1848, became captain under Garibaldi at Rome in 1849, taking prisoners an entire French battalion, and gaining the gold medal for military valour. In 1859 he commanded a Garibaldian battalion, and gained the military cross of Savoy. Joining the Marsala expedition in 1860, he turned the day in favour of Garibaldi at Calatafimi, was wounded at Palermo, but recovered in time to besiege Reggio in Calabria (21st of August 1860), and, though again wounded, took part in the battle of Volturno, where his leg was broken. Elected deputy in 1861, he endeavoured to reconcile Cavour and Garibaldi. In 1866, at the head of the seventh division, he covered the Italian retreat from Custozza, ignoring the Austrian summons to surrender. Created senator in February 1870, he was in the following September given command of a division during the movement against Rome, took Civitá Vecchia, and participated in the general attack upon Rome (20th September 1870). He died of cholera at Achin Bay in Sumatra *en route* for Batavia, whither he

had gone in command of a commercial expedition (16th December 1873).

BIZERTA (properly pronounced Ben Zert; Fr. *Bizerte*), a seaport of Tunisia, in 37° 17' N., 9° 50' E. Pop. about 12,000. Next to Toulon, Bizerta is the most important naval port of France in the Mediterranean. It occupies a commanding strategic position in the narrowest part of the sea, being 714 m. E. of Gibraltar, 1168 m. W.N.W. of Port Said, 240 m. N.W. of Malta, and 420 m. S. by E. of Toulon. It is 60 m. by rail N.N.W. of Tunis. The town is built on the shores of the Mediterranean at the point where the Lake of Bizerta enters the sea through a natural channel, the mouth of which has been canalized. The modern town lies almost entirely on the north side of the canal. A little farther north are the ancient citadel, the walled "Arab" town and the old harbour (disused). The present outer harbour covers about 300 acres and is formed by two converging jetties and a breakwater. The north jetty is 4000 ft. long, the east jetty 3300 ft., and the breakwater—which protects the port from the prevalent north-east winds—3300 ft. long. The entrance to the canal is in the centre of the outer harbour. The canal is 2600 ft. long and 787 ft. wide on the surface. Its banks are lined with quays, and ships drawing 26 ft. of water can moor alongside. At the end of the canal is a large commercial harbour, beyond which the channel opens into the lake—in reality an arm of the sea—roughly circular in form and covering about 50 sq. m., two-thirds of its waters having a depth of 30 to 40 ft. The lake, which merchant vessels are not allowed to enter, contains the naval port and arsenal. There is a torpedo and submarine boat station on the north side of the channel at the entrance to the lake, but the principal naval works are at Sidi Abdallah at the south-west corner of the lake and 10 m. from the open sea. Here is an enclosed basin covering 123 acres with ample quays, dry docks and everything necessary to the accommodation, repair, re-equipment and coaling of a numerous fleet. Barracks, hospitals and water-works have been built the military town, called Ferryville, being self-contained.

Fortifications have been built for the protection of the port. They comprise (a) the older works surrounding the town; (b) a group of coast batteries on the high ground of Cape Bizerta or Guardia, 4 m. north-north-west of the town; these are grouped round a powerful fort called Jebel Kebir, and have a command of 300 to 800 ft. above sea-level; (c) another group of batteries on the narrow ground between the sea and the lake to the east of the town; the highest of these is the Jebel Tuila battery 265 ft. above sea-level.

The LAKE OF BIZERTA, called Tinja by the Arabs, abounds in excellent fish, especially mullets, the dried roe of which, called *botargo*, is largely exported, and the fishing industry employs a large proportion of the inhabitants. The western shore of the lake is low, and in many places is covered with olive trees to the water's edge. The south-eastern shores are hilly and wooded, and behind them rises a range of picturesque hills. A narrow and shallow channel leads from the western side of the lake into another sheet of water, the Lake of Ishkul, so called from Jebel Ishkul, a hill on its southern bank 1740 ft. high. The Lake of Ishkul is nearly as large as the first lake, but is very shallow. Its waters are generally sweet.

Bizerta occupies the site of the ancient Tyrian colony, Hippo Zarytus or Diarrhytus, the harbour of which, by means of a spacious pier, protecting it from the north-east wind, was rendered one of the safest and finest on this coast. The town became a Roman colony, and was conquered by the Arabs in the 7th century. The place thereafter was subject either to the rulers of Tunis or of Constantine, but the citizens were noted for their frequent revolts. They threw in their lot (c. 1530) with the pirate Khair-ed-Din, and subsequently received a Turkish garrison. Bizerta was captured by the Spaniards in 1535, but not long afterwards came under the Tunisian government. Centuries of neglect followed, and the ancient port was almost choked up, though the value of the fisheries saved the town from utter decay. Its strategic importance was one of the causes

which led to the occupation of Tunisia by the French in 1881. In 1890 a concession for a new canal and harbour was granted to a company, and five years later the new port was formally opened. Since then the canal has been widened and deepened, and the naval port at Sidi Abdallah created.

BIZET [ALEXANDRE CÉSAR LÉOPOLD] GEORGES (1838-1875), French musical composer, was born at Bougival, near Paris, on the 25th of October 1838, the son of a singing-master. He displayed musical ability at an early age, and was sent to the Paris Conservatoire, where he studied under Halévy and speedily distinguished himself, carrying off prizes for organ and fugue, and finally in 1857, after an ineffectual attempt in the previous year, the Grand Prix de Rome for a cantata called *Cloris et Clotilde*. A success of a different kind also befell him at this time. Offenbach, then manager of the Théâtre des Bouffes-Parisiens, had organized a competition for an operetta, in which young Bizet was awarded the first prize in conjunction with Charles Lecocq, each of them writing an operetta called *Docteur Miracle*. After the three years spent in Rome, an obligation imposed by the French government on the winners of the first prize at the Conservatoire, Bizet returned to Paris, where he achieved a reputation as a pianist and accompanist. On the 23rd of September 1863 his first opera, *Les Pêcheurs de perles*, was brought out at the Théâtre Lyrique, but owing possibly to the somewhat uninteresting nature of the story, the opera did not enjoy a very long run. The qualities displayed by the composer, however, were amply recognized, although the music was stated, by some critics, to exhibit traces of Wagnerian influence. Wagnerism at that period was a sort of spectre that haunted the imagination of many leading members of the musical press. It sufficed for a work to be at all out of the common for the epithet "Wagnerian" to be applied to it. The term, it may be said, was intended to be condemnatory, and it was applied with little understanding as to its real meaning. The score of the *Pêcheurs de perles* contains several charming numbers; its dreamy melodies are well adapted to fit a story laid in Eastern climes, and the music reveals a decided dramatic temperament. Some of its dances are now usually introduced into the fourth act of *Carmen*.

On the 3rd of June 1865 Bizet married a daughter of his old master, Halévy. His second opera, *La Jolie Fille de Perth*, produced at the Théâtre Lyrique on 26th December 1867, was scarcely a step in advance. The libretto was founded on Sir Walter Scott's novel, but the opera lacks unity of style, and its pages are marred by concessions to the vocalist. One number has survived, the characteristic Bohemian dance which has been interpolated into the fourth act of *Carmen*. In his third opera Bizet returned to an oriental subject. *Djamileh*, a one-act opera given at the Opéra Comique on the 22nd of May 1872, is certainly one of his most individual efforts. Again were accusations of Wagnerism hurled at the composer's head, and *Djamileh* did not achieve the success it undoubtedly deserved. The composer was more fortunate with the incidental music he wrote to Alphonse Daudet's drama, *L'Arlesienne*, produced in October 1872. Different numbers from this, arranged in the form of suites, have often been heard in the concert-room. Rarely have poetry and imagination been so well allied as in these exquisite pages, which seem to reflect the sunny skies of Provence.

Bizet's masterpiece, *Carmen*, was brought out at the Opéra Comique on the 3rd of March 1875. It was based on a version by Meilhac and Halévy of a study by Prosper Mérimée—in which the dramatic element was obscured by much descriptive writing. The detection of the drama underlying this psychological narrative was in itself a brilliant discovery, and in reconstructing the story in dramatic form the authors produced one of the most famous libretti in the whole range of opera. Still more striking than the libretto was the music composed by Bizet, in which the peculiar use of the flute and of the lowest notes of the harp deserves particular attention.

On the 3rd of June, three months after the production of *Carmen* in Paris, the genial composer expired after a few hours' illness from a heart affection. Before dying he had the satisfaction

of knowing that *Carmen* had been accepted for production at Vienna. After the Austrian capital came Brussels, Berlin and, in 1878, London, when *Carmen* was brought out at Her Majesty's theatre with immense success. The influence exercised by Bizet on dramatic music has been very great, and may be discerned in the realistic works of the young Italian school, as well as in those of his own countrymen.

BJÖRNEBORG (Finnish, *Pöri*), a district town of Finland, province of Abo-Björneborg, on the E. coast of the Gulf of Bothnia, at the mouth of the Kumo. Lat. 51° 8' N., long. 46° 0' E. Pop. (1904) 16,053, mostly Swedes. Large vessels cannot enter its roadstead, and stop at Råfö. The town has shipbuilding wharves, machine works, and several tanneries and brick-works, and has a total trade of over 16,000,000 marks, the chief export being timber.

BJÖRNSON, BJÖRNSTJERNE (1832-1910), Norwegian poet, novelist and dramatist, was born on the 8th of December 1832 at the farmstead of Björgen, in Kvikne, in Østerdal, Norway. In 1837 his father, who had been pastor of Kvikne, was transferred to the parish of Noeset, in Romsdal; in this romantic district the childhood of Björnson was spent. After some teaching at the neighbouring town of Molde, he was sent at the age of seventeen to a well-known school in Christiania to study for the university; his instinct for poetry was already awakened, and indeed he had written verses from his eleventh year. He matriculated at the university of Christiania in 1852, and soon began to work as a journalist, especially as a dramatic critic. In 1857 appeared *Synnøve Solbakken*, the first of Björnson's peasant-novels; in 1858 this was followed by *Arne*, in 1860 by *A Happy Boy*, and in 1868 by *The Fisher Maiden*. These are the most important specimens of his *bonde-fortællinger* or peasant-tales—a section of his literary work which has made a profound impression in his own country, and has made him popular throughout the world. Two of the tales, *Arne* and *Synnøve Solbakken*, offer perhaps finer examples of the pure peasant-story than are to be found elsewhere in literature.

Björnson was anxious "to create a new saga in the light of the peasant," as he put it, and he thought this should be done, not merely in prose fiction, but in national dramas or *folke-stykker*. The earliest of these was a one-act piece the scene of which is laid in the 12th century, *Between the Battles*, written in 1855, but not produced until 1857. He was especially influenced at this time by the study of Baggesen and Oehlenschläger, during a visit to Copenhagen 1856-1857. *Between the Battles* was followed by *Lame Hulda* in 1858, and *King Sverre* in 1861. All these efforts, however, were far excelled by the splendid trilogy of *Sigurd the Bastard*, which Björnson issued in 1862. This raised him to the front rank among the younger poets of Europe. His *Sigurd the Crusader* should be added to the category of these heroic plays, although it was not printed until 1872.

At the close of 1857 Björnson had been appointed director of the theatre at Bergen, a post which he held, with much journalistic work, for two years, when he returned to the capital. From 1860 to 1863 he travelled widely throughout Europe. Early in 1865 he undertook the management of the Christiania theatre, and brought out his popular comedy of *The Newly Married* and his romantic tragedy of *Mary Stuart in Scotland*. Although Björnson has introduced into his novels and plays songs of extraordinary beauty, he was never a very copious writer of verse; in 1870 he published his *Poems and Songs* and the epic cycle called *Arnijs Gelline*; the latter volume contains the magnificent ode called "Bergliot," Björnson's finest contribution to lyrical poetry. Between 1864 and 1874, in the very prime of life, Björnson displayed a slackening of the intellectual forces very remarkable in a man of his energy; he was indeed during these years mainly occupied with politics, and with his business as a theatrical manager. This was the period of Björnson's most fiery propaganda as a radical agitator. In 1871 he began to supplement his journalistic work in this direction by delivering lectures over the length and breadth of the northern countries. He possessed to a surprising degree the arts of the orator, combined with a magnificent physical prestige. From 1873 to 1876

Björnson was absent from Norway, and in the peace of voluntary exile he recovered his imaginative powers. His new departure as a dramatic author began with *A Bankruptcy* and *The Editor* in 1874, social dramas of an extremely modern and realistic cast.

The poet now settled on his estate of Aulestad in Gausdal. In 1877 he published another novel, *Magnhild*—an imperfect production, in which his ideas on social questions were seen to be in a state of fermentation, and gave expression to his republican sentiments in the polemical play called *The King*, to a later edition of which he prefixed an essay on "Intellectual Freedom," in further explanation of his position. *Captain Mansana*, an episode of the war of Italian independence, belongs to 1878. Extremely anxious to obtain a full success on the stage, Björnson concentrated his powers on a drama of social life, *Leonarda* (1879), which raised a violent controversy. A satirical play, *The New System*, was produced a few weeks later. Although these plays of Björnson's second period were greatly discussed, none of them (except *A Bankruptcy*) pleased on the boards. When once more he produced a social drama, *A Gannlet*, in 1883, he was unable to persuade any manager to stage it, except in a modified form, though this play gives the full measure of his power as a dramatist. In the autumn of the same year, Björnson published a mystical or symbolic drama *Beyond our Powers*, dealing with the abnormal features of religious excitement with extraordinary force; this was not acted until 1899, when it achieved a great success.

Meanwhile, Björnson's political attitude had brought upon him a charge of high treason, and he took refuge for a time in Germany, returning to Norway in 1882. Convinced that the theatre was practically closed to him, he turned back to the novel, and published in 1884, *Flags are Flying in Town and Port*, embodying his theories on heredity and education. In 1889 he printed another long and still more remarkable novel, *In God's Way*, which is chiefly concerned with the same problems. The same year saw the publication of a comedy, *Geography and Love*, which continues to be played with success. A number of short stories, of a more or less didactic character, dealing with startling points of emotional experience, were collected in 1894; among them those which produced the greatest sensation were *Dust*, *Mother's Hands*, and *Abraham's Hair*. Later plays were a political tragedy called *Paul Lange and Tora Parsberg* (1898), a second part of *Beyond our Powers* (1895), *Laboremus* (1901), *At Storhove* (1902), and *Dagbladet* (1904). In 1899, at the opening of the National theatre, Björnson received an ovation, and his saga-drama of *Sigurd the Crusader* was performed.

A subject which interested him greatly, and on which he occupied his indefatigable pen, was the question of the *bonde-maal*, the adopting of a national language for Norway distinct from the *dansk-norsk* (Danish-Norwegian), in which her literature has hitherto been written. Björnson's strong and sometimes rather narrow patriotism did not blind him to the fatal folly of such a proposal, and his lectures and pamphlets against the *maal-stræf* in its extreme form did more than anything else to save the language in this dangerous moment. Björnson was one of the original members of the Nobel committee, and was re-elected in 1900. In 1903 he was awarded the Nobel prize for literature. Björnson had done as much as any other man to rouse Norwegian national feeling, but in 1903, on the verge of the rupture between Norway and Sweden, he preached conciliation and moderation to the Norwegians. He was an eloquent advocate of Pan-Germanism, and, writing to the *Figaro* in 1905, he outlined a Pan-Germanic alliance of northern Europe and North America. He died on the 26th of April 1910.

See Björnson's *Samlæde Vaerker* (Copenhagen, 1900-1902, 11 vols.); *The Novels of Björnstjerne Björnson* (1894, &c.), edited by Edmund Gosse; G. Brandes, *Critical Studies* (1899); E. Tissot, *Le drame norvégien* (1893); C. D. af Wirsén, *Kritiker* (1901); Chr. Collin, *Björnstjerne Björnson* (2 vols., German ed., 1903), the most complete biography and criticism at present available; and B. Halvorsen, *Norsk Forfatter Lexikon* (1885). (E. G.)

BLACHFORD, FREDERIC ROGERS, BARON (1811-1889), British civil servant, eldest son of Sir Frederick Leman Rogers, 7th Bart. (whom he succeeded in the baronetcy in 1851), was

born in London on the 31st of January 1811. He was educated at Eton and Oriel College, Oxford, where he had a brilliant career, winning the Craven University scholarship, and taking a double first-class in classics and mathematics. He became a fellow of Oriel (1833), and won the Vinerian scholarship (1834), and fellowship (1840). He was called to the bar in 1837, but never practised. At school and at Oxford he was a contemporary of W. E. Gladstone, and at Oxford he began a lifelong friendship with J. H. Newman and R. W. Church; his classical and literary tastes, and his combination of liberalism in politics with High Church views in religion, together with his good social position and interesting character, made him an admired member of their circles. For two or three years (1841-1844) he wrote for *The Times*, and he helped to found *The Guardian* in 1846; he also did a good deal to assist the Tractarian movement. But he eventually settled down to the life of a government official. He began in 1844 as registrar of joint-stock companies, and in 1846 became commissioner of lands and emigration. Between 1857 and 1859 he was engaged in government missions abroad, connected with colonial questions, and in 1860 he was appointed permanent under-secretary of state for the colonies. Sir Frederic Rogers was the guiding spirit of the colonial office under six successive secretaries of state, and on his retirement in 1871 was raised to the peerage as Baron Blachford of Wisdome, a title taken from his place in Devonshire. He died on the 21st of November 1889.

A volume of his letters, edited by G. E. Marindin (1896), contains an interesting life, partly autobiographical.

BLACK, ADAM (1784-1874), Scottish publisher, founder of the firm of A. & C. Black, the son of a builder, was born in Edinburgh on the 20th of February 1784. After serving his apprenticeship to the bookselling trade in Edinburgh and London, he began business for himself in Edinburgh in 1808. By 1826 he was recognized as one of the principal booksellers in the city; and a few years later he was joined in business by his nephew Charles. The two most important events connected with the history of the firm were the publication of the 7th, 8th and 9th editions of the *Encyclopaedia Britannica*, and the purchase of the stock and copyright of the Waverley Novels. The copyright of the *Encyclopaedia* passed into the hands of Adam Black and a few friends in 1827. In 1851 the firm bought the copyright of the Waverley Novels for £27,000; and in 1861 they became the proprietors of De Quincey's works. Adam Black was twice lord provost of Edinburgh, and represented the city in parliament from 1856 to 1865. He retired from business in 1865, and died on the 24th of January 1874. He was succeeded by his sons, who removed their business in 1895 to London. There is a bronze statue of Adam Black in East Princes Street Gardens, Edinburgh.

See *Memoirs of Adam Black*, edited by Alexander Nicholson (2nd ed., Edinburgh, 1885).

BLACK, JEREMIAH SULLIVAN (1810-1883), American lawyer and statesman, was born in Stony Creek township, Somerset county, Pennsylvania, on the 10th of January 1810. He was largely self-educated, and before he was of age was admitted to the Pennsylvania bar. He gradually became one of the leading American lawyers, and in 1851-1857 was a member of the supreme court of Pennsylvania (chief-justice 1851-1854). In 1857 he entered President Buchanan's cabinet as attorney-general of the United States. In this capacity he successfully contested the validity of the "California land claims"—claims to about 19,000 sq. m. of land, fraudulently alleged to have been granted to land-grabbers and others by the Mexican government prior to the close of the Mexican War. From the 17th of December 1860 to the 4th of March 1861 he was secretary of state. Perhaps the most influential of President Buchanan's official advisers, he denied the constitutionality of secession, and urged that Fort Sumter be properly reinforced and defended. "For . . . the vigorous assertion at last in word and in deed that the United States is a nation," says James Ford Rhodes, "for pointing out the way in which the authority of the Federal government might be exercised without infringing on the rights

of the states, the gratitude of the American people is due to Jeremiah S. Black." He became reporter to the Supreme Court of the United States in 1861, but after publishing the reports for the years 1861 and 1862 he resigned, and devoted himself almost exclusively to his private practice, appearing in such important cases before the Supreme Court as the one known as *Ex-Parte Miligan*, in which he ably defended the right of trial by jury, the McCauley case and the *United States v. Blyew et al.* After the Civil War he vigorously opposed the Congressional plan of reconstructing the late Confederate states, and himself drafted the message of President Johnson, vetoing the Reconstruction Act of the 2nd of March 1867. Black was also for a short time counsel for President Andrew Johnson, in his trial on the article of impeachment, before the United States Senate, and for William W. Belknap (1829-1890), secretary of war from 1869 to 1876, who in 1876 was impeached on a charge of corruption; and with others he represented Samuel J. Tilden during the contest for the presidency between Tilden and Hayes (see ELECTORAL COMMISSION). He died at Brockie, Pennsylvania, on the 19th of August 1883.

See *Essays and Speeches of Jeremiah S. Black, with a Biographical Sketch* (New York, 1885), by his son, C. F. Black.

BLACK, JOSEPH (1728-1799), Scottish chemist and physician, was born in 1728 at Bordeaux, where his father—a native of Belfast but of Scottish descent—was engaged in the wine trade. At the age of twelve he was sent to a grammar school in Belfast, whence he removed in 1746 to study medicine in Glasgow. There he had William Cullen for his instructor in chemistry, and the relation between the two soon became that of professor and assistant rather than of master and pupil. The action of lithontriptic medicines, especially lime-water, was one of the questions of the day, and through his investigations of this subject Black was led to the chemical discoveries associated with his name. The causticity of alkaline bodies was explained at that time as depending on the presence in them of the principle of fire, "phlogiston"; quicklime, for instance, was chalk which had taken up phlogiston, and when mild alkalis such as sodium or potassium carbonate were causticized by its aid, the phlogiston was supposed to pass from it to them. Black showed that on the contrary causticization meant the loss of something, as proved by loss of weight; and this something he found to be an "air," which, because it was fixed in the substance before it was causticized, he spoke of as "fixed air." Taking *magnesia alba*, which he distinguished from limestone with which it had previously been confused, he showed that on being heated it lost weight owing to the escape of this fixed air (named carbonic acid by Lavoisier in 1781), and that the weight was regained when the calcined product was made to reabsorb the fixed air with which it had parted. These investigations, by which Black not only gave a great impetus to the chemistry of gases by clearly indicating the existence of a gas distinct from common air, but also anticipated Lavoisier and modern chemistry by his appeal to the balance, were described in the thesis *De humore acido a cibis orto, et magnesia alba*, which he presented for his doctor's degree in 1754; and a fuller account of them was read before the Medical Society of Edinburgh in June 1755, and published in the following year as *Experiments upon magnesia, quicklime and some other alkaline substances*.

It is curious that Black left to others the detailed study of this "fixed air" he had discovered. Probably the explanation is pressure of other work. In 1756 he succeeded Cullen as lecturer in chemistry at Glasgow, and was also appointed professor of anatomy, though that post he was glad to exchange for the chair of medicine. The preparation of lectures thus took up much of his time, and he was also gaining an extensive practice as a physician. Moreover, his attention was engaged on studies which ultimately led to his doctrine of latent heat. He noticed that when ice melts it takes up a quantity of heat without undergoing any change of temperature, and he argued that this heat, which as was usual in his time he looked upon as a subtle fluid, must have combined with the particles of ice and thus become latent in its substance. This hypothesis he verified quantitatively

by experiments, performed at the end of 1761. In 1764, with the aid of his assistant, William Irvine (1743-1787), he further measured the latent heat of steam, though not very accurately. This doctrine of latent heat he taught in his lectures from 1761 onwards, and in April 1762 he described his work to a literary society in Glasgow. But he never published any detailed account of it, so that others, such as J. A. Deluc, were able to claim the credit of his results. In the course of his inquiries he also noticed that different bodies in equal masses require different amounts of heat to raise them to the same temperature, and so founded the doctrine of specific heats; he also showed that equal additions or abstractions of heat produced equal variations of bulk in the liquid of his thermometers. In 1766 he succeeded Cullen in the chair of chemistry in Edinburgh, where he devoted practically all his time to the preparation of his lectures. Never very robust, his health gradually became weaker and ultimately he was reduced to the condition of a valetudinarian. In 1795 he received the aid of a coadjutor in his professorship, and two years later he lectured for the last time. He died in Edinburgh on the 6th of December 1799 (not on the 26th of November as stated in Robison's life).

As a scientific investigator, Black was conspicuous for the carefulness of his work and his caution in drawing conclusions. Holding that chemistry had not attained the rank of a science—his lectures dealt with the "effects of heat and mixture"—he had an almost morbid horror of hasty generalization or of anything that had the pretensions of a fully fledged system. This mental attitude, combined with a certain lack of initiative and the weakness of his health, probably prevented him from doing full justice to his splendid powers of experimental research. Apart from the work already mentioned he published only two papers during his life-time—"The supposed effect of boiling on water, in disposing it to freeze more readily" (*Phil. Trans.*, 1775), and "An analysis of the waters of the hot springs in Iceland" (*Trans. Roy. Soc. Ed.*, 1794).

After his death his lectures were written out from his own notes, supplemented by those of some of his pupils, and published with a biographical preface by his friend and colleague, Professor John Robison (1739-1805), in 1803, as *Lectures on the Elements of Chemistry, delivered at the University of Edinburgh*.

BLACK, WILLIAM (1841-1898), British novelist, was born at Glasgow on the 9th of November 1841. His early ambition was to be a painter, but he made no way, and soon had recourse to journalism for a living. He was at first employed in newspaper offices in Glasgow, but obtained a post on the *Morning Star* in London, and at once proved himself a descriptive writer of exceptional vivacity. During the war between Prussia and Austria in 1866 he represented the *Morning Star* at the front, and was taken prisoner. This paper shortly afterwards failed, and Black joined the editorial staff of the *Daily News*. He also edited the *Examiner*, at a time when that periodical was already moribund. After his first success in fiction, he gave up journalism, and devoted himself entirely to the production of novels. For nearly thirty years he was successful in retaining the popular favour. He died at Brighton on the 10th of December 1898, without having experienced any of that reaction of the public taste which so often follows upon conspicuous successes in fiction. Black's first novel, *James Merle*, published in 1864, was a complete failure; his second, *Love or Marriage* (1868), attracted but very slight attention. *In Silk Attire* (1869) and *Kilmory* (1870) marked a great advance on his first work, but in 1871 *A Daughter of Ethel* suddenly raised him to the height of popularity, and he followed up this success by a string of favourites. Among the best of his books are *The Strange Adventures of a Phaeton* (1872); *A Princess of Thule* (1874); *Madcap Violet* (1876); *MacLeod of Dare* (1878); *White Wings* (1880); *Swirise* (1880); *Skandian Bells* (1883); *Judith Shakespeare* (1884); *White Feather* (1885); *Donald Ross of Heimra* (1891); *Highland Cousins* (1894); and *Wild Eclis* (1898). Black was a thoroughgoing sportsman, particularly fond of fishing and yachting, and his best stories are those which are laid amid the breezy mountains of his native land, or upon the deck of a yacht at sea off its wild coast. His

descriptions of such scenery are simple and picturesque. He was a word-painter rather than a student of human nature. His women are stronger than his men, and among them are many wayward and lovable creatures; but subtlety of intuition plays no part in his characterization. Black also contributed a life of Oliver Goldsmith to the *English Men of Letters* series.

BLACK APE, a sooty, black, short-tailed, and long-faced representative of the macaques, inhabiting the island of Celebes, and generally regarded as forming a genus by itself, under the name of *Cynopithecus niger*, but sometimes relegated to the rank of a subgenus of *Macacus*. The nostrils open obliquely at some distance from the end of the snout, and the head carries a crest of long hair. There are several local races, one of which was long regarded as a separate species under the name of the Moor macaque, *Macacus maurus*. (See PRIMATES.)

BLACKBALL, a token used for voting by ballot against the election of a candidate for membership of a club or other association. Formerly white and black balls about the size of pigeons' eggs were used respectively to represent votes for and against a candidate for such election; and although this method is now generally obsolete, the term "blackball" survives both as noun and verb. The rules of most clubs provide that a stated proportion of "blackballs" shall exclude candidates proposed for election, and the candidates so excluded are said to have been "blackballed"; but the ballot (*q.v.*) is now usually conducted by a method in which the favourable and adverse votes are not distinguished by different coloured balls at all. Either voting papers are employed, or balls—of which the colour has no significance—are cast into different compartments of a ballot-box according as they are favourable or adverse to the candidate.

BLACKBERRY, or **BRAMBLE**, known botanically as *Rubus fruticosus* (natural order Rosaceae), a native of the north temperate region of the Old World, and abundant in the British Isles as a copse and hedge-plant. It is characterized by its prickly stem, leaves with usually three or five ovate, coarsely toothed stalked leaflets, many of which persist through the winter, white or pink flowers in terminal clusters, and black or red-purple fruits, each consisting of numerous succulent drupels crowded on a dry conical receptacle. It is a most variable plant, exhibiting many more or less distinct forms which are regarded by different authorities as sub-species or species. In America several forms of the native blackberry, *Rubus nigrobaccus* (formerly known as *R. villosus*), are widely cultivated; it is described as one of the most important and profitable of bush-fruits.

For details see F. W. Card in L. H. Bailey's *Cyclopedia of American Horticulture* (1900).

BLACKBIRD (*Turdus merula*), the name commonly given to a well-known British bird of the *Turdidae* family, for which the ancient name was ouzel (*q.v.*), Anglo-Saxon *æsel*, equivalent of the German *Amsel*, a form of the word found in several old English books. The plumage of the male is of a uniform black colour, that of the female various shades of brown, while the bill of the male, especially during the breeding season, is of a bright gamboge yellow. The blackbird is of a shy and restless disposition, courting concealment, and rarely seen in flocks, or otherwise than singly or in pairs, and taking flight when startled with a sharp shrill cry. It builds its nest in March, or early in April, in thick bushes or in ivy-clad trees, and usually rears at least two broods each season. The nest is a neat structure of coarse grass and moss, mixed with earth, and plastered internally with mud, and here the female lays from four to six eggs of a blue colour speckled with brown. The blackbird feeds chiefly on fruits, worms, the larvae of insects and snails, extracting the last from their shells by dexterously chipping them on stones; and though it is generally regarded as an enemy of the garden, it is probable that the amount of damage by it to the fruit is largely compensated for by its undoubted services as a vermin-killer. The notes of the blackbird are rich and full, but monotonous as compared with those of the song-thrush. Like many other singing birds it is, in the wild state, a

mocking-bird, having been heard to imitate the song of the nightingale, the crowing of a cock, and even the cackling of a hen. In confinement it can be taught to whistle a variety of tunes, and even to imitate the human voice.

The blackbird is found in every country of Europe, even breeding—although rarely—beyond the arctic circle, and in eastern Asia as well as in North Africa and the Atlantic islands. In most parts of its range it is migratory, and in Britain every autumn its numbers receive considerable accession from passing visitors. Allied species inhabit most parts of the world, excepting Africa south of the Sahara, New Zealand and Australia proper, and North America. In some of these the legs as well as the bill are yellow or orange; and in a few both sexes are glossy black. The ring-ousel, *Turdus torquatus*, has a dark bill and conspicuous white gorget, whence its name. It is rarer and more local than the common blackbird, and occurs in England only as a temporary spring and autumn visitor.

BLACK BUCK (*Antelope cervicapra*), the Indian Antelope, the sole species of its genus. This antelope, widely distributed in India, with the exception of Ceylon and the region east of the Bay of Bengal, stands about 32 in. high at the shoulder; the general hue is brown deepening with age to black; chest, belly and inner sides of limbs pure white, as are the muzzle and chin, and an area round the eyes. The horns are long, ringed, and form spirals with from three to five turns. The doe is smaller in size, yellowish-fawn above, and this hue obtains also in young males. These antelopes frequent grassy districts and are usually found in herds. Coursing black-buck with the cheeta (*q.s.*) is a favourite Indian sport.

BLACKBURN, COLIN BLACKBURN, BARON (1813–1896), British judge, was born in Selkirkshire in 1813, and educated at Eton and at Trinity College, Cambridge, taking high mathematical honours in 1835. He was called to the bar in 1838, and went the northern circuit. His progress was at first slow, and he employed himself in reporting and editing, with T. F. Ellis, eight volumes of the highly-esteemed Ellis and Blackburn reports. His deficiency in all the more brilliant qualities of the advocate almost confined his practice to commercial cases, in which he obtained considerable employment in his circuit; but he continued to belong to the outside bar, and was so little known to the legal world that his promotion to a puisne judgeship in the court of queen's bench in 1859 was at first ascribed to Lord Campbell's partiality for his countrymen, but Lord Lyndhurst, Lord Wensleydale and Lord Cranworth came forward to defend the appointment. Blackburn himself is said to have thought that a county court judgeship was about to be offered him, which he had resolved to decline. He soon proved himself one of the soundest lawyers on the bench, and when he was promoted to the court of appeal in 1876 was considered the highest authority on common law. In 1876 he was made a lord of appeal and a life peer. Both in this capacity and as judge of the queen's bench he delivered many judgments of the highest importance, and no decisions have been received with greater respect. In 1886 he was appointed a member of the commission charged to prepare a digest of the criminal law, but retired on account of indisposition in the following year. He died at his country residence, Doonholm in Ayrshire, on the 8th of January 1896. He was the author of a valuable work on the *Law of Sales*.

See *The Times*, 10th of January 1896; E. Manson, *Builders of our Law* (1904).

BLACKBURN, JONATHAN (c. 1700–c. 1765), American portrait painter, was born in Connecticut. He seems to have been the son of a painter, and to have had a studio in Boston in 1750–1765; among his patrons were many important early American families, including the Apthorps, Amorys, Bulfinches, Lowells, Ewings, Saltonstalls, Winthrop, Winslows and Otises of Boston. Some of his portraits are in the possession of the public library of Lexington, Massachusetts, and of the Massachusetts Historical Society, but most of them are privately owned and are scattered over the country, the majority being in Boston. John Singleton Copley was his pupil, and it is said that he finally left his studio in Boston, through jealousy of

Copley's superior success. He was a good portrait painter, and some of his pictures were long attributed to Copley.

BLACKBURN, a municipal, county and parliamentary borough of Lancashire, England, 210 m. N.W. by N. from London, and 24½ N.N.W. from Manchester, served by the Lancashire & Yorkshire and the London & North Western railways, with several lines from all parts of the county. Pop. (1891) 120,064; (1901) 127,626. It lies in the valley of a stream called in early times the Blackeburn, but now known as the Brook. The hills in the vicinity rise to some 900 ft., and among English manufacturing towns Blackburn ranks high in beauty of situation. Besides numerous churches and chapels the public buildings comprise a large town hall (1856), market house, exchange, county court, municipal offices, chamber of commerce, free library, and, outside the town, an infirmary. There are an Elizabethan grammar school, in modern buildings (1884) and an excellent technical school. The Corporation Park and Queen's Park are well laid out, and contain ornamental waters. There is an efficient tramway service, connecting the town with Darwen, 5 m. south. The cotton industry employs thousands of operatives, the iron trade is also very considerable, and many are engaged in the making of machines; but a former woollen manufacture is almost extinct. Blackburn's speciality in the cotton industry is weaving. Coal, lime and building stone are abundant in the neighbourhood. Blackburn received a charter of incorporation in 1851, and is governed by a mayor, 14 aldermen and 42 councillors. The county borough was created in 1888. The parliamentary borough, which returns two members, is co-extensive with the municipal, and lies between the Accrington and Darwen divisions of the county. Area, 7432 acres.

Blackburn is of considerable antiquity; indeed, the 6th century is allocated to the original foundation of a church on the site of the present parish church. Of another church on this site Cranmer was rector after the Reformation. Blackburn was for some time the chief town of a district called Blackburnshire, and as early as the reign of Elizabeth ranked as a flourishing market town. About the middle of the 17th century it became famous for its "checks," which were afterwards superseded by a similar linen-and-cotton fabric known as "Blackburn greys." In the 18th century the ability of certain natives of the town greatly fostered its cotton industry; thus James Hargreaves here probably invented his spinning jenny about 1764, though the operatives, fearing a reduction of labour, would have none of it, and forced him to quit the town for Nottingham. He was in the employment of Robert Peel, grandfather of the prime minister of that name, who here instituted the factory system, and as the director of a large business carefully fostered the improvement of methods.

See W. A. Abram, *History of Blackburn* (Blackburn, 1897).

BLACKBURNE, FRANCIS (1782–1867), lord chancellor of Ireland, was born at Great Footstown, Co. Meath, Ireland, on the 11th of November 1782. Educated at Trinity College, Dublin, he was called to the English bar in 1805, and practised with great success on the home circuit. Called to the Irish bar in 1822, he vigorously administered the Insurrection Act in Limerick for two years, effectually restoring order in the district. In 1826 he became a squire-at-law, and in 1830, and again, in 1841, was attorney-general for Ireland. In 1842 he became master of the rolls in Ireland, in 1846 chief-justice of the queen's bench, and in 1852 (and again in 1866) lord chancellor of Ireland. In 1856 he was made a lord justice of appeal in Ireland. He is remembered as having prosecuted O'Connell and presided at the trial of Smith O'Brien. He died on the 17th of September 1867.

BLACKCOCK (*Tetrao tetrix*), the English name given to a bird of the family *Tetraonidae* or grouse, the female of which is known as the grey hen and the young as poults. In size and plumage the two sexes offer a striking contrast, the male weighing about 4 lb. its plumage for the most part of a rich glossy black shot with blue and purple, the lateral tail feathers curved outwards so as to form, when raised, a fan-like crescent, and the eyebrows destitute of feathers and of a bright vermilion red. The female,

on the other hand, weighs only 2 lb, its plumage is of a russet brown colour irregularly barred with black, and its tail feathers are but slightly forked. The males are polygamous, and during autumn and winter associate together, feeding in flocks apart from the females; but with the approach of spring they separate, each selecting a locality for itself, from which it drives off all intruders, and where morning and evening it seeks to attract the other sex by a display of its beautiful plumage, which at this season attains its greatest perfection, and by a peculiar cry, which Selby describes as "a crowing note, and another similar to the noise made by the whetting of a scythe." The nest, composed of a few stalks of grass, is built on the ground, usually



Blackcock.

beneath the shadow of a low bush or a tuft of tall grass, and here the female lays from six to ten eggs of a dirty-yellow colour speckled with dark brown. The blackcock then rejoins his male associates, and the female is left to perform the labours of hatching and rearing her young brood. The plumage of both sexes is at first like that of the female, but after moulting the young males gradually assume the more brilliant plumage of their sex. There are also many cases on record, and specimens may be seen in the principal museums, of old female birds assuming, to a greater or less extent, the plumage of the male. The blackcock is very generally distributed over the highland districts of northern and central Europe, and in some parts of Asia. It is found on the principal heaths in the south of England, but is specially abundant in the Highlands of Scotland.

BLACK COUNTRY, THE, a name commonly applied to a district lying principally in S. Staffordshire, but extending into Worcestershire and Warwickshire, England. This is one of the chief manufacturing centres in the United Kingdom, and the name arises from the effect of numerous collieries and furnaces, which darken the face of the district, the buildings and the atmosphere. Coal, ironstone and clay are mined in close proximity, and every sort of iron and steel goods is produced. The district extends 15 m. N.W. from Birmingham, and includes Smethwick, West Bromwich, Dudley, Oldbury, Sedgley, Tipton, Būston, Wednesbury, Wolverhampton and Walsall as its most important centres. The ceaseless activity of the Black Country is most readily realized when it is traversed, or viewed from such an elevation as Dudley Castle Hill, at night, when the glare of furnaces appears in every direction. The district is served by numerous branches of the Great Western, London & North Western, and Midland railways, and is intersected by canals, which carry a heavy traffic, and in some places are made to surmount physical obstacles with remarkable engineering skill, as in the case of the Castle Hill tunnels at Dudley. Among the numerous branches of industry there are several characteristic of certain individual centres. Thus, locks are a specialty at

Wolverhampton and Willenhall, and keys at Wednesfield; horses' bits, harness-fittings and saddlery at Walsall and Bloxwich, anchors and cables at Tipton, glass at Smethwick; and nails and chains at Cradley.

BLACK DROP, in astronomy, an apparent distortion of the planet Mercury or Venus at the time of internal contact with the limb of the sun at the beginning or end of a transit. It has been in the past a source of much perplexity to observers of transits, but is now understood to be a result of irradiation, produced by the atmosphere or by the aberration of the telescope.

BLACKFOOT (*Siksika*), a tribe and confederacy of North American Indians of Algonquian stock. The name is explained as an allusion to their leggings being observed by the whites to have become blackened by marching over the freshly burned prairie. Their range was around the headwaters of the Missouri, from the Yellowstone northward to the North Saskatchewan and westward to the Rockies. The confederacy consisted of three tribes, the Blackfoot or Siksika proper, the Kaina and the Piegan. During the early years of the 19th century the Blackfoots were one of the strongest Indian confederacies of the north-west, numbering some 40,000. At the beginning of the 20th century there were about 5000, some in Montana and some in Canada.

See Jean L'Heureux, *Customs and Religious Ideas of Blackfoot Indians in J. A. I.*, vol. xv. (1886); G. B. Grinnell, *Blackfoot Lodge Tales* (1892); G. Catlin, *North American Indians* (1876); *Handbook of American Indians* (Washington, 1907), under "Siksika."

BLACK FOREST (Ger. *Schwarzwald*; the *Silva Marciana* and *Abnoba* of the Romans), a mountainous district of south-west Germany, having an area of 1844 sq. m., of which about two-thirds lie in the grand duchy of Baden and the remaining third in the kingdom of Württemberg. Bounded on the south and west by the valley of the Rhine, to which its declivities abruptly descend, and running parallel to, and forming the counterpart of the Vosges beyond, it slopes more gently down to the valley of the Neckar in the north and to that of the Nagold (a tributary of the Neckar) on the north-east. Its total length is 100 m., and its breadth varies from 36 m. in the south to 21 in the centre and 13 in the north. The deep valley of the Kinzig divides it laterally into halves, of which the southern, with an average elevation of 3000 ft., is the wilder and contains the loftiest peaks, which again mostly lie towards the western side. Among them are the Feldberg (4898 ft.), the Herzogenhorn (4600), the Blössling (4260) and the Blauen (3820). The northern half has an average height of 2000 ft. On the east side are several lakes, and here the majority of the streams take their rise. The configuration of the hills is mainly conical and the geological formation consists of gneiss, granite (in the south) and red sandstone. The district is poor in minerals; the yield of silver and copper has almost ceased, but there are workable coal seams near Offenburg, where the Kinzig debouches on the plain. The climate in the higher districts is raw and the produce is mostly confined to hardy cereals, such as oats. But the valleys, especially those on the western side, are warm and healthy, enclose good pasture land and furnish fruits and wine in rich profusion. They are clothed up to a height of about 2000 ft. with luxuriant woods of oak and beech, and above these again and up to an elevation of 4000 ft., surrounding the hills with a dense dark belt, are the forests of fir which have given the name to the district. The summits of the highest peaks are bare, but even on them snow seldom lies throughout the summer.

The Black Forest produces excellent timber, which is partly sawn in the valleys and partly exported down the Rhine in logs. Among other industries are the manufactures of watches, clocks, toys and musical instruments. There are numerous mineral springs, and among the watering places Baden-Baden and Wildbad are famous. The towns of Freiburg, Rastatt, Offenburg and Lahr, which lie under the western declivities, are the chief centres for the productions of the interior.

The Black Forest is a favourite tourist resort and is opened up by numerous railways. In addition to the main lines in the valleys of the Rhine and Neckar, which are connected with the towns lying on its fringe, the district is intersected by the

Schwarzwaldbahn from Offenburg to Singen, from which various small local lines ramify.

BLACK HAWK (Ma'katakawimesheka'ka, "Black Sparrow Hawk"), (1767-1838, American Indian warrior of the Sauk and Fox tribes, was born at the Sauk village on Rock river, near the Mississippi, in 1767. He was a member of the Thunder gens of the Sauk tribe, and, though neither an hereditary nor an elected chief, was for some time the recognized war leader of the Sauk and Foxes. From his youth he was intensely bloodthirsty and hostile to the Americans. Immediately after the acquisition of "Louisiana," the Federal government took steps for the removal of the Sauk and Foxes, who had always been a disturbing element among the north-western Indians, to the west bank of the Mississippi river. As early as 1804, by a treaty signed at St Louis on the 3rd of November, they agreed to the removal in return for an annuity of \$1000. British influences were still strong in the upper Mississippi valley and undoubtedly led Black Hawk and the chiefs of the Sauk and Fox confederacy to repudiate this agreement of 1804, and subsequently to enter into the conspiracy of Tecumseh and take part with the British in the war of 1812. The treaties of 1815 at Portage des Sioux (with the Foxes) and of 1816 at St Louis (with the Sauk) substantially renewed that of 1804. That of 1816 was signed by Black Hawk himself, who declared, however, when in 1823 Chief Keokuk and a majority of the two nations crossed the river, that the consent of the chiefs had been obtained by fraud. In 1830 a final treaty was signed at Prairie du Chien, by which all title to the lands of the Sauk and Foxes east of the Mississippi was ceded to the government, and provision was made for the immediate opening of the tract to settlers. Black Hawk, leading the party in opposition to Keokuk, at once refused to accede to this cession and threatened to retaliate if his lands were invaded. This precipitated what is known as the Black Hawk War. Settlers began pouring into the new region in the early spring of 1831, and Black Hawk in June attacked several villages near the Illinois-Wisconsin line. After massacring several isolated families, he was driven off by a force of Illinois militia. He renewed his attack in the following year (1832), but after several minor engagements, in most of which he was successful, he was defeated (21st of July) at Wisconsin Heights on the Wisconsin river, opposite Prairie du Sac, by Michigan volunteers under Colonels Henry Dodge and James D. Henry, and fleeing westward was again decisively defeated on the Mississippi at the mouth of the Bad Axe river (on the 1st and 2nd of August) by General Henry Atkinson. His band was completely dispersed, and he himself was captured by a party of Winnebagoes. At Fort Armstrong, Rock Island, on the 21st of September, a treaty was signed, by which a large tract of the Sauk and Fox territory was ceded to the United States; and the United States granted to them a reservation of 400 sq. m., the payment of \$20,000 a year for thirty years, and the settlement of certain traders' claims against the tribe. With several warriors Black Hawk was sent to Fortress Monroe, Virginia, where he was confined for a few weeks; afterwards he was taken by the government through the principal Eastern cities. On his release he settled in 1837 on the Sauk and Fox reservation on the Des Moines river, in Iowa, where he died on the 3rd of October 1838.

See Frank E. Stevens, *The Black Hawk War* (Chicago, 1903); R. G. Thwaites, "The Story of the Black Hawk War" in vol. xii. of the *Collections of the State Historical Society of Wisconsin*; J. B. Patterson, *Life of Ma-ho-lai-me-she-kia-kia-kiak or Black Hawk* (Boston, 1834), purporting to be Black Hawk's story as told by himself; and Benjamin Drake, *Life of Black Hawk* (Cincinnati, 1846).

BLACKHEATH, an open common in the south-east of London, England, mainly in the metropolitan borough of Lewisham. This high-lying tract was crossed by the Roman Watling Street from Kent, on a line approximating to that of the modern Shooter's Hill; and was a rallying ground of Wat Tyler (1381), of Jack Cade (1450), and of Audley, leader of the Cornish rebels, defeated and captured here by the troops of Henry VII. in 1497. It also witnessed the acclamations of the citizens of London on the return of Henry V. from the victory of Agincourt, the formal meeting between Henry VIII. and Anne of Cleves, and that

between the army of the restoration and Charles II. The introduction into England of the game of golf is traditionally placed here in 1608, and attributed to King James I. and his Scottish followers. The common, the area of which is 267 acres, is still used for this and other pastimes. For the residential district to which Blackheath gives name, see LEWISHAM.

BLACK HILLS, an isolated group of mountains, covering an area of about 6000 sq. m. in the adjoining corners of South Dakota and Wyoming, U.S.A. They rise on an average some 2000 ft. above their base, the highest peak, Harney, having an altitude above the sea of 7216 ft. They are drained and in large part enclosed by the North (or Belle Fourche) and South forks of the Cheyenne river (at whose junction a fur-trading post was established about 1830); and are surrounded by semi-arid, alkaline plains lying 3000 to 3500 ft. above the sea. The mass has an elliptical shape, its long axis, which extends nearly N.N.W.-S.S.E., being about 120 m. and its shorter axis about 40 m. long. The hills are formed by a short, broad, anticlinal fold, which is flat or nearly so on its summit. From this fold the stratified beds have in large part been removed, the more recent having been almost entirely eroded from the elevated mass. The edges of these are now found encircling the mountains and forming a series of fairly continuous rims of hogbacks. The carboniferous and older stratified beds still cover the west half of the hills, while from the east half they have been removed, exposing the granite. Scientific exploration began in 1849, and systematic geological investigation about 1875. Rich gold placers had already been discovered, and in 1875 the Sioux Indians within whose territory the hills had until then been included, were removed, and the lands were open to white settlers. Subsequently low-grade quartz mines were found and developed, and have furnished a notable part of the gold supply of the country (about \$100,000,000 from 1875 to 1901). The output is to-day relatively small in comparison with that of many other fields, but there are one or two permanent gold mines of great value working low-grade ore. The silver product from 1879 to 1901 was about \$4,154,000. Deposits of copper, tin, iron and tungsten have been discovered, and a variety of other mineral products (graphite, mica, spodumene, coal, petroleum, &c.). In sharp contrast to the surrounding plains the climate is subhumid, especially in the higher Harney region. There is an abundance of fertile soil and magnificent grazing land. A third of the total area is covered with forests of pine and other trees, which have for the most part been made a forest-reserve by the national government. Jagged crags, sudden abysses, magnificent canyons, forests with open parks, undulating hills, mountain prairies, freaks of weathering and erosion, and the enclosing lines of the successive hog-backs afford scenery of remarkable variety and wild beauty. There are several interesting limestone caverns, and Sylvan Lake, in the high mountain district, is an important resort.

See the publications of the United States Geological Survey (especially Professional Paper No. 26, *Economic Resources of the Northern Black Hills*, 1904), and of the South Dakota School of Mines (Bulletin No. 4, containing a history and bibliography of Black Hills investigations); also R. L. Dodge, *The Black Hills: A Minute Description* . . . (New York, 1876).

BLACKIE, JOHN STUART (1809-1895), Scottish scholar and man of letters, was born in Glasgow on the 28th of July 1809. He was educated at the New Academy and afterwards at the Marischal College, in Aberdeen, where his father was manager of the Commercial Bank. After attending classes at Edinburgh University (1825-1826), Blackie spent three years at Aberdeen as a student of theology. In 1829 he went to Germany, and after studying at Göttingen and Berlin (where he came under the influence of Heeren, Otfried Müller, Schleiermacher, Neander and Böckh) he accompanied Bunsen to Italy and Rome. The years spent abroad extinguished his former wish to enter the Church, and at his father's desire he gave himself up to the study of law. He had already, in 1824, been placed in a lawyer's office, but only remained there six months. By the time he was admitted a member of the Faculty of Advocates (1834) he had acquired a strong love of the classics and a taste for letters in

general. A translation of *Faust*, which he published in 1834, met with considerable success. After a year or two of desultory literary work he was (May 1839) appointed to the newly-instituted chair of Humanity (Latin) in the Marischal College. Difficulties arose in the way of his installation, owing to the action of the Presbytery on his refusing to sign unreservedly the Confession of Faith; but these were eventually overcome, and he took up his duties as professor in November 1841. In the following year he married. From the first his professorial lectures were conspicuous for the unconventional enthusiasm with which he endeavoured to revivify the study of the classics; and his growing reputation, added to the attention excited by a translation of *Aeschylus* which he published in 1850, led to his appointment in 1852 to the professorship of Greek at Edinburgh University, in succession to George Dunbar, a post which he continued to hold for thirty years. He was somewhat erratic in his methods, but his lectures were a triumph of influential personality. A journey to Greece in 1853 prompted his essay *On the Living Language of the Greeks*, a favourite theme of his, especially in his later years; he adopted for himself a modern Greek pronunciation, and before his death he endowed a travelling scholarship to enable students to learn Greek at Athens. Scottish nationality was another source of enthusiasm with him; and in this connexion he displayed real sympathy with Highland home life and the grievances of the crofters. The foundation of the Celtic chair at Edinburgh University was mainly due to his efforts. In spite of the many calls upon his time he produced a considerable amount of literary work, usually on classical or Scottish subjects, including some poems and songs of no mean order. He died in Edinburgh on the 2nd of March 1895. Blackie was a Radical and Scottish nationalist in politics, but of a fearlessly independent type; he was one of the "characters" of the Edinburgh of the day, and was a well-known figure as he went about in his plaid, worn shepherd-wise, wearing a broad-brimmed hat, and carrying a big stick. His published works include (besides several volumes of verse) *Homer and the Iliad* (1866), maintaining the unity of the poems; *Four Phases of Morals: Socrates, Aristotle, Christianity, Utilitarianism* (1871); *Essay on Self-Culture* (1874); *Horae Hellenicae* (1874); *The Language and Literature of the Scottish Highlands* (1876); *The Natural History of Atheism* (1877); *The Wise Men of Greece* (1877); *Lay Sermons* (1881); *Alluvions* (1882); *The Wisdom of Goethe* (1883); *The Scottish Highlanders and the Land Laws* (1885); *Life of Burns* (1888); *Scottish Song* (1889); *Essays on Subjects of Moral and Social Interest* (1890); *Christianity and the Ideal of Humanity* (1893). Amongst his political writings may be mentioned a pamphlet *On Democracy* (1867), *On Forms of Government* (1867), and *Political Tracts* (1868).

See Anna M. Stoddart, *John Stuart Blackie* (1895); A. Stoddart-Walker, *Selected Poems of J. S. Blackie*, with an appreciation (1896); Howard Angus Kennedy, *Professor Blackie* (1895).

BLACK ISLE, THE, a district in the east of the county of Ross and Cromarty, Scotland, bounded N. by Cromarty Firth, E. by Moray Firth, S. by Inner Moray Firth (or Firth of Inverness) and Beaulie Firth, and W. by the river Conon and the parish of Urray. It is a diamond-shaped peninsula jutting out from the mainland in a north-easterly direction, the longer axis, from Muir of Ord station to the South Sutor at the entrance to Cromarty Firth, measuring 20 m., and the shorter, from Ferryton Point to Craighton Point, due north and south, 12 m., and it has a coastline of 52 m. Originally called *Ardmeaneach* (Gaelic *ard*, height; *meaneach*, monk, "the monk's height," from an old religious house on the finely-wooded ridge of Mulbuie), it derived its customary name from the fact that, since snow does not lie in winter, the promontory looks black while the surrounding country is white. Within its limits are comprised the parishes of Urquhart and Logie Wester, Killarnan, Knockbain (Gaelic *cnac*, hill; *bdn*, white), Avoch (pron. Auch), Rosemarkie, Resolis (Gaelic *rudha* or *ros solais*, "cape of the light") or Kirkmichael and Cromarty. The Black Isle branch of the Highland railway runs from Muir of Ord to Fortrose; steamers connect Cromarty with Invergordon and Inverness, and Fortrose with Inverness; and there are ferries,

on the southern coast, at North Kessock (for Inverness) and Chanony (for Fort George), and, on the northern coast, at Alcaig (for Dingwall), Newhallpoint (for Invergordon), and Cromarty (for Nigg). The principal towns are Cromarty and Fortrose. Rosehaugh, near Avoch, belonged to Sir George Mackenzie, founder of the Advocates' library in Edinburgh, who earned the sobriquet of "Bloody" from his persecution of the Covenanters. Redcastle, on the shore, near Killarnan church, dates from 1179 and is said to have been the earliest inhabited house in the north of Scotland. On the forfeiture of the earldom of Ross it became a royal castle (being visited by Queen Mary), and afterwards passed for a period into the hands of the Mackenzies of Gairloch. The chief industries are agriculture—high farming flourishes owing to the great fertility of the peninsula—and stone-quarrying and fisheries (mainly from Avoch). The whole district, though lacking water, is picturesque and was once forested. The Mulbuie ridge, the highest point of which is 838 ft. above the sea, occupies the centre and is the only elevated ground. Antiquarian remains are somewhat numerous, such as forts and cairns in Cromarty parish, and stone circles in Urquhart and Logie Wester and Knockbain parishes, the latter also containing a hut circle and rock fortresses.

BLACKLOCK, THOMAS (1721-1791), Scottish poet, the son of a bricklayer, was born at Annan, in Dumfriesshire, in 1721. When not quite six months old he lost his sight by small-pox, and his career is largely interesting as that of one who achieved what he did in spite of blindness. Shortly after his father's death in 1740, some of Blacklock's poems began to be handed about among his acquaintances and friends, who arranged for his education at the grammar-school, and subsequently at the university of Edinburgh, where he was a student of divinity. His first volume of *Poems* was published in 1746. In 1754 he became deputy librarian for the Faculty of Advocates, by the kindness of Hume. He was eventually estranged from Hume, and defended James Beattie's attack on that philosopher. Blacklock was among the first friends of Burns in Edinburgh, being one of the earliest to recognize his genius. He was in 1762 ordained minister of the church of Kirkcudbright, a position which he soon resigned; in 1767 the degree of doctor in divinity was conferred on him by Marischal College, Aberdeen. He died on the 7th of July 1791.

An edition of his poems in 1793 contains a life by Henry Mackenzie. **BLACKMAIL**, a term, in English law, used in three special meanings, at different times. The usual derivation of the second half of the word is from Norman Fr. *maille* (*medalia*; cf. "medal"), small copper coin; the *New English Dictionary* derives from "mail" (*q.v.*), meaning rent or tribute. (1) The primary meaning of "blackmail" was rent paid in labour, grain or baser metal (*i.e.* money other than sterling money), called *reditus nigri*, in contradistinction to rent paid in silver or white money (*mailles blanches*). (2) In the northern counties of England (Northumberland, Westmorland and the bishopric of Durham) it signified a tribute in money, corn, cattle or other consideration exacted from farmers and small owners by freebooters in return for immunity from robbers or moss-troopers. By a statute of 1601 it was made a felony without benefit of clergy to receive or pay such tribute, but the practice lingered until the union of England and Scotland in 1707. (3) The word now signifies extortion of money or property by threats of libel, persecution, exposure, &c. See such headings as **COERCION**, **CONSPIRACY**, **EXTORTION**, and authorities quoted under **CRIMINAL LAW**.

BLACKMORE, SIR RICHARD (c. 1650-1729), English physician and writer, was born at Corsham, in Wiltshire, about 1650. He was educated at Westminster school and St Edmund Hall, Oxford. He was for some time a schoolmaster, but finally, after graduating in medicine at Padua, he settled in practice as a physician in London. He supported the principles of the Revolution, and was accordingly knighted in 1697. He held the office of physician in ordinary both to William III. and Anne, and died on the 9th of October 1729. Blackmore had a

passion for writing epics. *Prince Arthur, an Heroick Poem in X Books* appeared in 1695, and was followed by six other long poems before 1723. Of these *Creation . . .* (1712), a philosophical poem intended to refute the atheism of Vanini, Hobbes and Spinoza, and to unfold the intellectual philosophy of Locke, was the most favourably received. Dr Johnson anticipated that this poem would transmit the author to posterity "among the first favourites of the English muse," while John Dennis went so far as to describe it as "a philosophical poem, which has equalled that of Lucretius in the beauty of its versification, and infinitely surpassed it in the solidity and strength of its reasoning." These opinions have not been justified, for the poem, like everything else that Blackmore wrote, is dull and tedious. His *Creation* appears in Johnson's and Anderson's collections of the British poets. He left also works on medicine and on theological subjects.

BLACKMORE, RICHARD DODDRIDGE (1825-1900), English novelist, was born on the 7th of June 1825 at Longworth, Berkshire, of which village his father was curate in charge. He was educated at Blundell's school, Tiverton, and Exeter College, Oxford, where he obtained a scholarship. In 1847 he took a second class in classics. Two years later he entered as a student at the Middle Temple, and was called to the bar in 1852. His first publication was a volume of *Poems by Melanther* (1854), which showed no particular promise, nor did the succeeding volume, *Ebullia* (1855), suggest that Blackmore had the makings of a poet. He was nevertheless enthusiastic in his pursuit of literature; and when, a few years later, the complete breakdown of his health rendered it clear that he must remove from London, he determined to combine a literary life in the country with a business career as a market-gardener. He acquired land at Teddington, and set earnestly to work, the literary fruits of his new surroundings being a translation of the *Georgics*, published in 1862. In 1864 he published his first novel, *Clara Vaughan*, the merits of which were promptly recognized. *Cradock Nowell* (1866) followed, but it was in 1869 that he suddenly sprang into fame with *Lorna Doone*. This fine story was a pioneer in the romantic revival; and appearing at a jaded hour, it was presently recognized as a work of singular charm, vigour and imagination. Its success could scarcely be repeated, and though Blackmore wrote many other capital stories, of which the best known are *The Maid of Sker* (1872), *Christowell* (1880), *Perlycross* (1894), *Tales from the Telling House* (1896) and *Darrel* (1897), he will always be remembered almost exclusively as the author of *Lorna Doone*. He continued his quiet country life to the last, and died at Teddington on the 20th of January 1900, in his seventy-fifth year. *Lorna Doone* has the true out-of-door atmosphere, is shot through and through with adventurous spirit, and in its dramatic moments shows both vigour and intensity. The heroine, though she is invested with qualities of fairy which are scarcely human, is an idyllic and haunting figure; and John Ridd, the bluff hero, is, both in purpose and achievement, a veritable giant of romance. The story is a classic of the West country, and the many pilgrimages that are made annually to the Doone Valley (the actual characteristics of which differ materially from the descriptions given in the novel) are entirely inspired by the buoyant imagination of Richard Blackmore. A memorial window and tablet to his memory were erected in Exeter cathedral in 1904.

BLACK MOUNTAIN, a mountain range and district on the Hazara border of the North-West Frontier Province of India. It is inhabited by Yusufzai Pathans. The Black Mountain itself has a total length of 25 to 30 m., and an average height of 8000 ft. above the sea. It rises from the Indus basin near the village of Kiara, up to its watershed by Brudrud; thence it runs north-west by north to the point on the crest known as Chittabut. From Chittabut the range runs due north, finally descending by two large spurs to the Indus again. The tribes which inhabit the western face of the Black Mountain are the Hassanzais (2300 fighting men), the Akazais (1165 fighting men) and the Chagarzais (4800 fighting men), all sub-sections of the Yusufzai Pathans. It was in this district that the Hindostani Fanatics had their

stronghold, and they were responsible for much of the unrest on this part of the border.

The Black Mountain is chiefly notable for four British expeditions:—

1. Under Lieut.-Colonel F. Mackeson, in 1852-53, against the Hassanzais. The occasion was the murder of two British customs officers. A force of 3800 British troops traversed their country, destroying their villages and grain, &c.

2. Under Major-General A. T. Wilde, in 1868. The occasion was an attack on a British police post at Oghi in the Agror Valley by all three tribes. A force of 12,500 British troops entered the country and the tribes made submission.

3. The First Hazara Expedition in 1888. The cause was the constant raids made by the tribes on villages in British territory, culminating in an attack on a small British detachment, in which two English officers were killed. A force of 12,500 British troops traversed the country of the tribes, and severely punished them. Punishment was also inflicted on the Hindostani Fanatics of Palosi.

4. The Second Hazara Expedition of 1891. The Black Mountain tribes fired on a force within British limits. A force of 7300 British troops traversed the country. The tribesmen made their submission and entered into an agreement with government to preserve the peace of the border.

The Black Mountain tribes took no part in the general frontier rising of 1897, and after the disappearance of the Hindostani Fanatics they sank into comparative unimportance.

BLACKPOOL, a municipal and county borough and seaside resort in the Blackpool parliamentary division of Lancashire, England, 46 m. N. of Liverpool, served by the Lancashire & Yorkshire, and London & North Western railways. Pop. (1891) 23,846; (1901) 47,346. The town, which is quite modern, contains many churches and chapels of all denominations, a town hall, public libraries, the Victoria hospital, three piers, theatres, ball-rooms, and other places of public amusement, including a lofty tower, resembling the Eiffel Tower of Paris. The municipality maintains an electric tram service. There are handsome promenades along the sea front, which command fine views. Extensive works upon these, affording a sea front unsurpassed by that of any English watering-place, were completed in 1905. The beach is sandy and the bathing good. The borough was created in 1876 (county borough, 1904), and is governed by a mayor, 12 aldermen and 36 councillors. Area, exclusive of foreshore, 3496 acres; including foreshore, 4244 acres.

BLACK ROD (more fully, "Gentleman Usher of the Black Rod"), an official of the House of Lords, instituted in 1350. His appointment is by royal letters patent, and his title is due to his staff of office, an ebony stick surmounted with a gold lion. He is a personal attendant of the sovereign in the Upper House, and is also usher of the order of the Garter, being doorkeeper at the meetings of the knights' chapter. He is responsible for the maintenance of order in the House of Lords, and on him falls the duty of arresting any peer guilty of breach of privilege or other offence of which the House takes cognizance. But the duty which brings him most into prominence is that of summoning the Commons and their speaker to the Upper House to hear a speech from the throne or the royal assent given to bills. If the sovereign is present in parliament, Black Rod commands the attendance of the gentlemen of the Commons, but when lords commissioners represent the king, he only desires such attendance. Black Rod is on such occasions the central figure of a curious ceremony of much historic significance. As soon as the attendants of the House of Commons are aware of his approach, they close the doors in his face. Black Rod then strikes three times with his staff, and on being asked "Who is there?" replies "Black Rod." Being then admitted he advances to the bar of the House, makes three obeisances and says, "Mr Speaker, the king commands this honourable House to attend his majesty immediately in the House of Lords." This formality originated in the famous attempt of Charles I. to arrest the five members, Hampden, Pym, Holles, Hesilrige and Strode, in 1642. Indignant

at this breach of privilege, the House of Commons has ever since maintained its right of freedom of speech and uninterrupted debate by the closing of the doors on the king's representative.

BLACK SEA (or **EUXINE**; anc. *Pontus Euxinus*),¹ a body of water lying almost entirely between the latitudes 41° and 45° N., but extending to about 47° N. near Odessa. It is bounded N. by the southern coast of Russia; W. by Rumania, Turkey and Bulgaria; S. and E. by Asia Minor. The northern boundary is broken at Kertch by a strait entering into the Sea of Azov, and at the junction of the western and southern boundary is the Bosphorus, which unites the Black Sea with the Mediterranean through the Sea of Marmora and the Dardanelles. The 100-fathom line is about 10 to 20 m. from the shore except in the north-west corner between Varna and Sevastopol, where it extends 140 m. seawards. The greatest depth is 1030 fathoms (1127 Russian fathoms) near the centre, there being only one basin. The steepest incline outside 100 fathoms is to the south-east of the Crimea and at Amastra; the incline to the greater depths is also steep off the Caucasus and between Trebizond and Batum. The conditions that prevail in the Black Sea are very different from those of the Mediterranean or any other sea. The existence of sulphuretted hydrogen in great quantities below 100 fathoms, the extensive chemical precipitation of calcium carbonate, the stagnant nature of its deep waters, and the absence of deep-sea life are conditions which make it impossible to discuss it along with the physical and biological conditions of the Mediterranean proper.

The depths of the Black Sea are lifeless, higher organic life not being known to exist below 100 fathoms. Fossiliferous remains of *Dreissena*, *Cardium* and other molluscs have, however, been dredged up, which help to show that conditions formerly existed in the Black Sea similar to those that exist at the present day in the Caspian Sea. According to N. Andrusov, when the union of the Black Sea with the Mediterranean through the Bosphorus took place, salt water rushed into it along the bottom of the Bosphorus and killed the fauna of the less saline waters. This gave rise to a production of sulphuretted hydrogen which is found in the deposits, as well as in the deeper waters.

Observations on temperature and salinity have only been taken during summer. During summer the surface salinity of the Black Sea is from 1.70 to 2.00 ‰ down to 50 fathoms, whereas in the greater depths it attains a salinity of 2.25 ‰. The temperature is rather remarkable, there being an intermediate cold layer between 25 and 50 fathoms. This is due to the sinking of the cold surface water (which in winter reaches freezing-point) on to the top of the denser more saline water of the greater depths. There is thus a minimum circulation in the greater depths causing there uniformity of temperature, an absence of the circulation of oxygen by other means than diffusion, and a protection of the sulphuretted hydrogen from the oxidation which takes place in homologous situations in the open ocean. The temperature down to 25 fathoms is from 78.3° to 46.2° F., and in the cold layer, between 25 and 50 fathoms, is from 46.2° to 43.5° F., rising again in greater depths to 48.2° F.

The *Sea of Marmora* may be looked upon as an arm of the Aegean Sea and thus part of the Mediterranean proper. Its salinity is comparable to that of the eastern basin of the Mediterranean, which is greater than that of the Black Sea, viz. 4 ‰. Similar currents exist in the Bosphorus to those of the Strait of Gibraltar. Water of less salinity flows outwards from the Black Sea as an upper current, and water of greater salinity from the *Sea of Marmora* flows into the Black Sea as an under-current. This under-current flows towards Cape Tarhangut, where it divides into a left and right branch. The left branch is appreciably noticed near Odessa and the north-west corner; the right branch sweeps past the Crimea, strikes the Caucasian shore (where it comes to the surface running across, but not into, the south-east corner of the Black Sea), and finally disperses flowing westwards along the northern coast of Asia Minor between Cape Jason and

Sinope. This current causes a warmer climate where it strikes. So marked is this current that it has to be taken into account in the navigation of the Black Sea.

The *Sea of Azov* is exceedingly shallow, being only about 6 fathoms in its deepest part, and it is largely influenced by the river Don. Its water is considerably fresher than the Black Sea, varying from 1.55 to 0.68 ‰. It freezes more readily and is not affected by the Mediterranean current.

See N. Andrusov, "Physical Exploration of the Black Sea," in *Geographical Journal*, vol. i. p. 49.

BLACK SEA (Russ. *Chernomorskaya*), a military district of the province of Kuban, formerly an independent province of Transcaucasia, Russia; it includes the narrow strip of land along the N.E. coast of the Black Sea from Novorossiysk to the vicinity of Pitsunda, between the sea and the crest of the main range of the Caucasus. Area, 2836 sq. m. Pop. (1897) 54,228; (1906, estimate) 71,900. It is penetrated by numerous spurs of this range, which strike the sea abruptly at right angles to the coast, and in many cases plunge down into it sheer. Owing to its southern exposure, its sheltered position, and a copious rainfall, vegetation, in part of a sub-tropical character, grows in great profusion. In consequence, however, of the mountainous character of the region, it is divided into a large number of more or less isolated districts, and there is little intercourse with the country north of the Caucasus, the passes over the range being few and difficult (see CAUCASUS). But since the Russians became masters of this region, its former inhabitants (Circassian tribes) have emigrated in thousands, so that the country is now only thinly inhabited. It is divided into three districts—Novorossiysk, with the town (pop. in 1897, 16,208) of the same name, which acts as the capital of the Black Sea district; Velyaminovsk; and Sochi. Novorossiysk is connected by rail, at the west end of the Caucasus, with the Rostov-Vladikavkaz line, and a mountain road leads from Velyaminovsk (or Tuapse) to Maikop in the province of Kuban.

BLACKSTONE, SIR WILLIAM (1723–1780), English jurist, was born in London, on the 10th of July 1723. His parents having died when he was young, his early education, under the care of his uncle, Dr Thomas Bigg, was obtained at the Charterhouse, from which, at the age of fifteen, he was sent to Pembroke College, Oxford. He was entered in the Middle Temple in 1741. In 1744 he was elected a fellow of All Souls' College. From this period he divided his time between the university and the Temple, where he took chambers in order to attend the law courts. In 1746 he was called to the bar. Though but little known or distinguished as a pleader, he was actively employed, during his occasional residences at the university, in taking part in the internal management of his college. In May 1749, as a small reward for his services, and to give him further opportunities of advancing the interests of the college, Blackstone was appointed steward of its manors. In the same year, on the resignation of his uncle, Seymour Richmond, he was elected recorder of the borough of Wallingford in Berkshire. In 1750 he became doctor of civil law. In 1753 he decided to retire from London work to his fellowship and an academical life, still continuing the practice of his profession as a provincial counsel.

His lectures on the laws of England appear to have been an early and favourite idea; for in the Michaelmas term immediately after he abandoned London, he entered on the duty of reading them at Oxford; and we are told by the author of his *Life*, that even at their commencement, the high expectations formed from the acknowledged abilities of the lecturer attracted to these lectures a very crowded class of young men of the first families, characters and hopes. Bentham, however, declares that he was a "formal, precise and affected lecturer—just what you would expect from the character of his writings—cold, reserved and wary, exhibiting a frigid pride." It was not till the year 1758 that the lectures in the form they now bear were read in the university. Blackstone, having been unanimously elected to the newly-founded Vinerian professorship, on the 25th of October read his first introductory lecture, afterwards prefixed to the first volume of his celebrated *Commentaries*. It is doubtful

¹ The early Greek navigators gave it the epithet of *æsius*, i.e. unfriendly to strangers, but as Greek colonies sprang up on the shores this was changed to *æsius*, friendly to strangers.

whether the *Commentaries* were originally intended for the press; but many imperfect and incorrect copies having got into circulation, and a pirated edition of them being either published or preparing for publication in Ireland, the author thought proper to print a correct edition himself, and in November 1765 published the first volume, under the title of *Commentaries on the Laws of England*. The remaining parts of the work were given to the world in the course of the four succeeding years. It may be remarked that before this period the reputation which his lectures had deservedly acquired for him had induced him to resume practice in London; and, contrary to the general order of the profession, he who had quitted the bar for an academic life was sent back from the college to the bar with a considerable increase of business. He was likewise elected to parliament, first for Hindon, and afterwards for Westbury in Wilts; but in neither of these departments did he equal the expectations which his writings had raised. The part he took in the Middlesex election drew upon him many attacks as well as a severe animadversion from the caustic pen of "Junius." This circumstance probably strengthened the aversion he professed to parliamentary attendance, "where," he said, "amidst the rage of contending parties, a man of moderation must expect to meet with no quarter from any side." In 1770 he declined the place of solicitor-general; but shortly afterwards, on the promotion of Sir Joseph Yates to a seat in the court of common pleas, he accepted a seat on the bench, and on the death of Sir Joseph succeeded him there also. He died on the 14th of February 1780.

The design of the *Commentaries* is exhibited in his first Vinerian lecture printed in the introduction to them. The author there dwells on the importance of noblemen, gentlemen and educated persons generally being well acquainted with the laws of the country; and his treatise, accordingly, is as far as possible a popular exposition of the laws of England. Falling into the common error of identifying the various meanings of the word law, he advances from the law of nature (being either the revealed or the inferred will of God) to municipal law, which he defines to be a rule of civil conduct prescribed by the supreme power in a state commanding what is right and prohibiting what is wrong. On this definition he founds the division observed in the *Commentaries*. The objects of law are rights and wrongs. Rights are either rights of persons or rights of things. Wrongs are either public or private. These four headings form respectively the subjects of the four books of the *Commentaries*.

Blackstone was by no means what would now be called a scientific jurist. He has only the vaguest possible grasp of the elementary conceptions of law. He evidently regards the law of gravitation, the law of nature, and the law of England, as different examples of the same principle—as rules of action or conduct imposed by a superior power on its subjects. He propounds in terms the doctrine that municipal or positive laws derive their validity from their conformity to the so-called law of nature or law of God. "No human laws," he says, "are of any validity if contrary to this." His distinction between rights of persons and rights of things, implying, as it would appear, that things as well as persons have rights, is attributable to a misunderstanding of the technical terms of the Roman law. In distinguishing between private and public wrongs (civil injuries and crimes) he fails to seize the true principle of the division. Austin, who accused him of following slavishly the method of Hale's *Analysis of the Law*, declares that he "blindly adopts the mistakes of his rude and compendious model; missing invariably, with a nice and surprising infelicity, the pregnant but obscure suggestions which it proffered to his attention, and which would have guided a discerning and inventive writer to an arrangement comparatively just." By the want of precise and closely-defined terms, and his tendency to substitute loose literary phrases, he falls occasionally into irreconcilable contradictions. Even in discussing a subject of such immense importance as equity, he hardly takes pains to discriminate between the legal and popular senses of the word, and, from the small place which equity jurisprudence occupies in his arrangement, he would scarcely seem to have realized its true position in the

law of England. Subject, however, to these strictures the completeness of the treatise, its serviceable if not scientific order, and the power of lucid exposition possessed by the author demand emphatic recognition. Blackstone's defects as a jurist are more conspicuous in his treatment of the underlying principles and fundamental divisions of the law than in his account of its substantive principles.

Blackstone by no means confines himself to the work of a legal commentator. It is his business, especially when he touches on the framework of society, to find a basis in history and reason for all the most characteristic English institutions. There is not much either of philosophy or fairness in this part of his work. Whether through the natural conservatism of a lawyer, or through his own timidity and subserviency as a man and a politician, he is always found to be a specious defender of the existing order of things. Bentham accuses him of being the enemy of all reform, and the unscrupulous champion of every form of professional chicanery. Austin says that he truckled to the sinister interests and mischievous prejudices of power, and that he flattered the overweening conceit of the English in their own institutions. He displays much ingenuity in giving a plausible form to common prejudices and fallacies; but it is by no means clear that he was not imposed upon himself. More undeniable than the political fairness of the treatise is its merits as a work of literature. It is written in a most graceful and attractive style, and although no opportunity of embellishment has been lost, the language is always simple and clear. Whether it is owing to its literary graces, or to its success in flattering the prejudices of the public to which it was addressed, the influence of the book in England has been extraordinary. Not lawyers only, and lawyers perhaps even less than others, accepted it as an authoritative revelation of the law. It performed for educated society in England much the same service as was rendered to the people of Rome by the publication of their previously unknown laws. It is more correct to regard it as a handbook of the law for laymen than as a legal treatise; and as the first and only book of the kind in England it has been received with somewhat indiscriminating reverence. It is certain that a vast amount of the constitutional sentiment of the country has been inspired by its pages. To this day Blackstone's criticism of the English constitution would probably express the most profound political convictions of the majority of the English people. Long after it has ceased to be of much practical value as an authority in the courts, it remains the arbiter of all public discussions on the law or the constitution. On such occasions the *Commentaries* are apt to be construed as strictly as if they were a code. It is curious to observe how much importance is attached to the *ipsisima verba* of a writer who aimed more at presenting a picture intelligible to laymen than at recording the principles of the law with technical accuracy of detail.

See also the article ENGLISH LAW.

BLACK VEIL, in the Roman Catholic Church, the symbol of the most complete renunciation of the world and adoption of a nun's life. On the appointed day the nun goes through all the ritual of the marriage ceremony, after a solemn mass at which all the inmates of the convent assist. She is dressed in bridal white with wreath and veil, and receives a wedding-ring, as spouse of the Church. Afterwards she presides at a wedding-breakfast, at which a bride-cake is cut. She thus bids adieu to all her friends, and having previously taken the white veil, the betrothal, she now assumes the black, and for ever forswears the world and its pleasures. Her hair is cut short, and her bridal robes are exchanged for the sombre religious habit. Her wedding-ring, however, she continues to wear, and it is buried with her.

BLACKWATER, the name of a number of rivers and streams in England, Scotland and Ireland. The Blackwater in Essex, which rises near Saffron Walden, has a course of about 40 m. to the North Sea. The most important river of the name is in southern Ireland, rising in the hills on the borders of the counties Cork and Kerry, and flowing nearly due east for the greater part of its course, as far as Cappoquin, where it turns abruptly southward, and discharges through an estuary into Youghal Bay.

The length of its valley (excluding the lesser windings of the river) is about 90 m., and the drainage area about 1300 sq. m. It is navigable only for a few miles above the mouth, but its salmon fisheries are both attractive to sportsmen and of considerable commercial value. The scenery of its banks is at many points very beautiful.

BLACKWATER FEVER, a disease occurring in tropical countries and elsewhere, which is often classed with malaria (q.v.). It is characterized by irregular febrile paroxysms, accompanied by rigors, bilious vomiting, jaundice and haemoglobinuria (Sambon). It has a wide geographical distribution, including tropical Africa, parts of Asia, the West Indies, the southern United States, and—in Europe—Greece, Sicily and Sardinia; but its range is not coextensive with malaria. Malarial parasites have occasionally been found in the blood. Some authorities believe it to be caused by the excessive use of quinine, taken to combat malaria. This theory has had the support of Koch, but it is not generally accepted. If it were correct, one would expect blackwater fever to be regularly prevalent in malarial countries and to be more or less coextensive with the use of quinine, which is not at all the case. It often resembles yellow fever, but the characteristic black vomit of yellow fever rarely occurs in blackwater fever, while the black urine from which the latter derives its name is equally rare in the former. According to the modern school of tropical parasitology, blackwater fever is neither a form of malaria nor produced by quinine, but a specific disease due to a protozoal parasite akin to that which causes the redwater fever of cattle.

BLACKWELL, THOMAS (1701-1757), Scottish classical scholar, was born at Aberdeen on the 4th of August 1701. He took the degree of M.A. at the Marischal College in 1718. He was appointed professor of Greek in 1723, and was principal of the institution from 1748 until his death on the 8th of March 1757. In 1735 his first work, *An Inquiry into the Life and Writings of Homer*, was published anonymously. It was reprinted in 1736, and followed (in 1747) by *Proofs of the Enquiry into Homer's Life and Writings*, a translation of the copious notes in foreign languages which had previously appeared. This work, intended to explain the causes of the superiority of Homer to all the poets who preceded or followed him, shows considerable research, and contains many curious and interesting details; but its want of method made Bentley say that, when he had gone through half of it, he had forgotten the beginning, and, when he had finished the reading of it, he had forgotten the whole. Blackwell's next work (also published anonymously in 1748) was *Letters Concerning Mythology*. In 1752 he took the degree of doctor of laws, and in the following year published the first volume of *Memoirs of the Court of Augustus*; the second volume appeared in 1755, the third in 1764 (prepared for the press, after Blackwell's death, by John Mills). This work shows considerable originality and erudition, but is even more unmethodical than his earlier writings and full of unnecessary digressions. Blackwell has been called the restorer of Greek literature in the north of Scotland; but his good qualities were somewhat spoiled by pomposity and affectation, which exposed him to ridicule.

BLACKWOOD, WILLIAM (1776-1834), Scottish publisher, founder of the firm of William Blackwood & Sons, was born of humble parents at Edinburgh on the 20th of November 1776. At the age of fourteen he was apprenticed to a firm of booksellers in Edinburgh, and he followed his calling also in Glasgow and London for several years. Returning to Edinburgh in 1804, he opened a shop in South Bridge Street for the sale of old, rare and curious books. He undertook the Scottish agency for John Murray and other London publishers, and gradually drifted into publishing on his own account, removing in 1816 to Princes Street. On the 1st of April 1817 was issued the first number of the *Edinburgh Monthly Magazine*, which on its seventh number, bore the name of *Blackwood's* as the leading part of the title. "Maga," as this magazine soon came to be called, was the organ of the Scottish Tory party, and round it gathered a host of able writers. William Blackwood died on the 16th of September 1834, and was succeeded by his two sons, Alexander and Robert,

who added a London branch to the firm. In 1845 Alexander Blackwood died, and shortly afterwards Robert.

A younger brother, John Blackwood (1818-1870), succeeded to the business; four years later he was joined by Major William Blackwood, who continued in the firm until his death in 1861. In 1862 the major's elder son, William Blackwood (b. 1836), was taken into partnership. John Blackwood was a man of strong personality and great business discernment; it was in the pages of his magazine that George Eliot's first stories, *Scenes of Clerical Life*, appeared. He also inaugurated the "Ancient Classics for English readers" series. On his death Mr William Blackwood was left in sole control of the business. With him were associated his nephews, George William and J. H. Blackwood, sons of Major George Blackwood, who was killed at Maiwand in 1880.

See *Annals of a Publishing House: William Blackwood and his Sons* (1897-1898), the first two volumes of which were written by Mrs Oliphant; the third, dealing with John Blackwood, by his daughter, Mrs Gerald Porter.

BLADDER (from A.S. *blæddre*, connected with *blawan*, to blow, cf. Ger. *Blase*), the membranous sac in animals which receives the urine secreted from the kidneys. The word is also used for any similar sac, such as the gall-bladder, the swim-bladder in fishes, or the small vesicle in various seaweeds.

BLADDER AND PROSTATE DISEASES. The urinary bladder in man (for the anatomy see URINARY SYSTEM), being the temporary reservoir of the renal secretion, and, as such, containing the urine for longer or shorter periods, is liable to various important affections. These are dealt with in the first part of this article. The diseases of the prostate are so intimately allied that they are best considered, as in the subsequent section, as part of the same subject.

Diseases of the Bladder.

Cystitis, or inflammation of the bladder, which may be acute or chronic, is due to the invasion of the mucous lining by micro-organisms, which gain access either from the urethra, the kidneys or the blood-stream. It is easy to see how the diplococci of gonorrhoea may infect the bladder-membrane by direct extension of the inflammation, and how the bacilli which are swarming in the neighbouring bowel may find access to the urethra or bladder when the intervening tissues have been rendered penetrable by a wound or by inflammation. Sometimes, however, especially in the female, the germs from the large intestine enter the bladder by way of the vulva and the urethra.

Any condition leading to disturbance of the function of the bladder, such as enlargement of the prostate, stricture of the urethra, stone, or injury, may cause cystitis by preparing the way for bacillary invasion. The bacilli of tuberculosis and of typhoid fever may set up cystitis by coming down into the bladder from the kidneys with the urine, or they reach it by the blood-stream, or invade it by the urethra. Another way of cystitis being set up is by the introduction of the germs of suppuration by a catheter or bougie sweeping them in from the urethra; or the instrument itself may be unsterilized and dirty and so may introduce them. It used formerly to be thought that wet or cold was enough to cause inflammation of the bladder, but the probability is that this acts only by lowering the resistance of the lining membrane of the bladder, and preparing it for the invasion of the germs which were merely waiting for an opportunity. In the same way, gout or injury may lead to the lurking bacilli being enabled to effect their attack. But in every case disease-germs are the cause of the trouble, and they may be found in the urine. The first effect of inflammation is to render the bladder irritable, so that as soon as a few drops of urine have collected, the individual has intense or uncontrollable desire to micturate. The effort may be very painful and may be accompanied by bleeding from the overloaded blood-vessels of the inflamed membrane. In addition to blood, pus is likely to be found in the urine, which by this time is alkaline and ammoniacal, and teeming with micro-organisms. As regards *treatment*, the patient should be at once sent to bed in a warm room, and should

sit several times a day in a very hot hip-bath. When he has got back to bed, a fomentation under oil-silk, or some other waterproof material, should be placed over the lower part of the abdomen. The diet should be milk (diluted with hot or cold water), barley-water, and bread and butter; no alcoholic drink should be allowed. If the urine is acid, bicarbonate of soda may be given, or citrate of soda; if alkaline, urotropine—a derivative of formic aldehyde—may prove a useful urinary disinfectant. If the straining and distress are great, a suppository of $\frac{1}{4}$ or $\frac{1}{2}$ a grain of morphia may be introduced into the rectum every two or three hours. The bowels must be kept freely open. If the urine is foul, the bladder should be frequently washed out by a soft catheter and two or three feet of india-rubber tubing with a funnel at the other end, weak and abundant hot lotions of Sanitas or Condy's fluid being used.

Chronic cystitis is the condition left when the acute symptoms have passed away, but it is liable at any moment to resume the acute condition. If the cystitis is very intractable, refusing to yield to hot irrigations, and to washings with nitrate of silver lotion, it may be advisable to open the bladder from the front, and to explore, treat, drain and rest it.

In *tuberculous cystitis* there is added to the symptoms the discovery of the bacilli of tuberculosis in the urine, and cystoscopic examination may reveal the presence of tubercles of the mucous membrane or even of ulceration. The patient is probably losing weight, and he may present foci of tuberculosis at the back of the testicle, the lung or kidney, or in a joint or bone, or in a lymphatic gland. Treatment is rebellious and unpromising. Washings and lotions give but temporary relief, and if the bladder is opened for rest, and for a more direct treatment, the germs of suppuration may enter, and, working in conjunction with the bacilli, may cause great havoc. Koch's tuberculin treatment should certainly be given a trial. This consists of the injection into the body of an emulsion of dead tubercle bacilli which have been sterilized by heat. As a result of this injection the blood sets to work to form an "opsonin"—a protective material which so modifies the disease-germs as to render them attractive to the white corpuscles of the patient's blood (phagocytes), which then seize upon and destroy them. Sir A. E. Wright has devised a delicate method of examination of the blood (the calculation of the opsonic index) which tells when the tuberculin injections should be resorted to and when withheld (see BLOOD).

Calculi and Gravel.—Uric acid is deposited from the urine either as small crystals resembling cayenne pepper, or else, in combination with soda and ammonia, as an amorphous "brick-dust" deposit, which, on cooling, leaves a red stain on the bottom of the vessel, soluble in hot water. These substances are derived from the disintegration of nitrogenized food taken in excess of demand, and from the breaking down of the human tissues. They occur therefore in fevers, in wasting diseases, and in the normal subject after excessive muscular exercises, especially if these exercises have been accompanied with so much perspiration that the excess of water from the blood has escaped by the skin rather than by the kidneys. The abundance of this deposit is in accordance with the amount of heat developed and work done in the body, and corresponds with the dust and ashes raked out of the fire-box of the locomotive after a long run. But supposing that the uric acid debris continues to be excessive, the risk of the formation of renal or vesical calculi becomes considerable, and it may be advisable to place the patient on a restricted nitrogenized diet, to induce him to drink large quantities of water, and to keep his bowels so loose with watery laxatives, such as Epsom salts or sulphate of soda, that the waste products of his body are made to escape by the bowels rather than by the kidneys. In addition to the salts just mentioned, an occasional dose of blue pill will prove helpful. A course of treatment at Contrexéville or Carlsbad may be taken with advantage.

Alkaline urine is unable to hold the phosphates of ammonia and magnesia in solution, so they are deposited in abundance either in the kidney or bladder. If the voided urine is allowed to stand in a tall glass they sink to the bottom with pus and mucus in a cloudy

deposit. To remedy this condition it is necessary to treat the cystitis with which the bacterial decomposition of the urine is associated. It may be that a calculus of acid urine, such as one of uric acid or oxalate of lime, has been resting in the bladder and keeping up incessant irritation, and that the micro-organisms of decomposition or suppuration have found their way to the mucous lining of the bladder from either the bowel, the urethra or the blood-stream; undergoing cultivation there they break up the urea into carbonate of ammonia and so render the urine alkaline. This alkaline urine deposits its phosphates, which light upon the calculus and encrust it with a mortary shell, which may go on increasing in size until it may even fill the bladder. Sometimes the nucleus of a calculus is a chip of bone or a blood-clot, or some foreign substance which has been introduced into the bladder. Sooner or later the urine becomes alkaline and the calculus is encrusted with lime salts.

When urine contains a larger amount of chemical constituents than it can conveniently hold in solution, a certain quantity crystallizes out, and may be deposited in the kidney or in the bladder. If the crystals run together in the kidney the resulting concretion may either remain in that organ or may find its way into the bladder, where it may remain to form the nucleus of a larger vesical calculus, or, especially in the case of females, it may, while still small, escape from the bladder during micturition.

In children, in whom there is a rapid disintegration of nitrogenized tissues, a uric acid calculus in escaping from the bladder may block the urethra and give rise to sudden retention of urine. On introducing a metal "sound," the surgeon may strike the stone, and if it happens to be near the bladder he may push it back and subsequently remove it by crushing. But if it has made its way some distance along the urethra, so that he can feel it from the outside, he should remove it by a clean incision.

A stone in the bladder worries the nerves of the mucous membrane, and, giving them the impression that the bladder contains much water, causes the desire and need for micturition to be constant. The irritation causes an excessive secretion of mucus, just as a piece of grit under the eyelid causes a constant running from the eye. So the urine, if allowed to stand, gives a copious deposit. During micturition the contracting bladder bruises its congested blood-vessels against the stone, so that towards the end of micturition blood appears in the urine. Lastly, cystitis occurs, and the urine contains fetid pus. A stone in the bladder gives rise to pain at the end of the penis, and it is apt suddenly to stop the flow of urine during micturition.

The association of any of these symptoms leads the surgeon to suspect the presence of a stone in the bladder, and he confirms his suspicions by introducing a slender steel rod, a "sound," by which he strikes and feels the stone. Further confirmation may be obtained by the help of the X-rays, or, in the adult, by using a cystoscope. In a child the stone may often be felt by a finger in the rectum, the front of the bladder being pressed by a hand on the lower part of the abdomen. The *cystoscope* is a straight, hollow metal tube about the size of a long cedar pencil, which the surgeon introduces into the adult bladder, which has already been filled with warm boracic lotion. Down the tube run two fine wires which control a minute electric lamp at the bladder end of the instrument. At that end also is a small glass window which prevents the fluid escaping by the tube, and also a prism; at the other end of the tube is an eye-piece. By the use of this slender speculum the practised surgeon can recognize the presence of tubercle or tuberculous ulceration of the bladder, stone, or other foreign material, and innocent or malignant growths. He can also watch the urine entering the bladder by the openings of the ureters, and determine from which kidney blood or pus is coming.

The treatment of stone in the bladder is governed by various conditions. Speaking generally, the surgeon prefers to introduce a lithotrite and crush the stone into small fragments, and then to flush out the fragments by using a full-sized, hollow metal catheter and an india-rubber wash-bottle. Even in children this operation may generally be adopted with success, the stone being crushed to atoms and the fragments being washed out to

the last small chip. But if the stone is a very hard one (as are some of the oxalate of lime calculi), or if it is very large, or if the bladder or the prostate gland is in a state of advanced disease, or if the urethra is not roomy enough to admit instruments of adequate calibre, the crushing operation (*lithotripsy*) must be deemed unsuitable, and the stone must be removed by a cutting operation (*lithotomy*).

Lithotomy.—Cutting for stone has been long practised; but up to the beginning of the 19th century it was performed only by a few men, who, bolder than their contemporaries, had specially worked at that operation and had attained celebrity as skilful lithotomists. Patients went long distances to be operated on by them, and certain of the older surgeons, as William Cheselden, performed a large number of operations with most excellent results. The operation was by an incision from the perineum, and is ordinarily spoken of as *lateral lithotomy*. It was splendidly designed, and gave good results, especially in children. But it is now a thing of the past, having almost entirely given place to the *high* or *supra-pubic* operation. In the high operation the patient, being duly prepared, is placed upon his back and the bladder is washed out with hot boracic lotion, and when the lotion returns quite clean a final injection is made until the bladder is felt rising above the pubes. Then the india-rubber tube is removed from the silver catheter by which the injection has been made, and the end of the catheter is plugged by a spigot. An incision is then made in the middle line of the abdomen over the bladder region. The incision must be kept as low as possible, so that the bladder may be reached below the peritoneum, which, higher up, gives it an external, serous coat. As the bladder is approached, a good many veins are seen to be in the way, some of which have to be wounded. The bladder-wall is recognized by its coarse network of pale muscular fibres, through which, on each side of the middle line, a strong suture is passed, so that when the bladder is opened and the lotion comes rushing out, the opening which has been made into the bladder may not sink into the depths of the pelvis. A finger introduced into the bladder makes out the exact size and position of the stone, or stones, and the removal is effected by special forceps. Bleeding having ceased, the bladder-wound is partly or entirely closed by sutures and allowed to fall into the pelvis, the catheter having been removed. It is advisable to leave a drainage tube in the abdominal wound for a while, so that if urine leaks from the bladder-wound it may find a ready escape to the dressings.

Litholapaxy.—Lithotripsy consists of two parts—the crushing of the stone, and the removal of the detritus. The two stages are now carried out at one "sitting," without an interval being allowed between them, as was formerly the practice, and the term "litholapaxy" designates this method. The patient having been anaesthetized, 10 oz. of hot boracic lotion are injected, and the crushing instrument, the lithotrite, is then passed into the bladder. The lithotrite has two blades, a "male" and a "female," the latter fenestrated, the former solid with its surface notched. When the stone is fixed between the blades the screw is used, and great pressure is applied evenly, gradually and continuously to the stone. The lithotrite is made of very tough steel, so that hard stones may be crushed without danger of the instrument breaking or bending. Care must be taken not to catch the bladder-wall with the lithotrite. This danger is avoided by raising the point of the lithotrite immediately after grasping the stone and before crushing. The stone breaks into two or more pieces, and these fragments must be crushed, one by one, until they are powdered fine enough to escape by the large evacuating catheter. If the stone be large and hard, half an hour or longer may be required to crush it sufficiently fine. When the surgeon fails to catch any more large pieces, the presumption is that the stone has been thoroughly broken up. The lithotrite is then withdrawn and the detritus is washed out by an "aspirator," which consists of a stiff elastic ball which is connected with a trap, into which fragments of stone fall so as not to pass out on the instrument being used at later periods in the operation. A large catheter, with the eye very near the end of

the short curve, is passed into the bladder; the aspirator, full of boracic lotion, is attached to the catheter, and a few ounces of the fluid are expressed from the aspirator into the bladder by squeezing the rubber ball. When the pressure is taken off the ball, it dilates and draws the fluid out of the bladder, and with it some of the detritus, which falls into the trap. This is repeated until all the fragments have been removed. After the operation the patient sometimes suffers from discomfort. His urine should be drawn off by a soft catheter at regular intervals for a few days. If the pain be severe, it can generally be relieved by fomentations. The patient must be kept in bed after the operation, and in cases where the stone has been large and the bladder irritable, the surgeon should insist on his remaining there for at least a week; in those cases which go on favourably the patients are soon able to perform their ordinary duties. Fatal terminations, however, do now and again occur from suppression of urine, the result of the old-standing kidney disease which so often complicates these cases.

To Brigade-Surgeon Lieutenant-Colonel Dennis Francis Keegan, of the Indian Medical Service, is due the fact that the operation of crushing and promptly removing all fragments of a vesical calculus is as well suited for boys as for men. In entire opposition to long-standing European prejudices, Keegan's operation is now firmly and permanently established. The old operation (Cheselden's) of cutting a stone out through the bottom of a boy's bladder is now seldom resorted to, and if a stone in a boy is found too large or too hard to lend itself to the crushing operation, it is removed by a vertical incision through the lower part of the anterior wall of the abdomen, as described above. For a successful performance of the crushing operation in a boy a small lithotrite has, of course, to be used, and it must be of the very best English make. The operation has to be done with the utmost gentleness and thoroughness, not a particle of the crushed stone being left in the bladder, since otherwise the piece left becomes the nucleus of a fresh stone and the trouble recurs.

The treatment of vesical calculi by other means than operative surgery is of little value. Attempts have been made to dissolve them by internal remedies, or by the injection of chemical agents into the bladder; but, although such methods have for a time been apparently successful, they have invariably been found worthless for removing calculi once actually formed. Nevertheless, much can be done towards *preventing* the formation of calculi in those who have a tendency to their formation, by attention to diet, by taking proper exercise, and by the internal administration of drugs.

Rupture of the bladder may be caused by a kick or blow over the upper part of the abdomen, or by a wheel passing over it; or it may be a complication of fracture of the pelvis. If the rupture is in that part of the bladder which is uncovered by the peritoneum, the extravasated urine may be cut down upon and let out with good prospect of success; but if the rupture is in the upper or hinder part of the bladder the urine is let loose into the general peritoneal cavity and sets up peritonitis, which is more than likely to prove fatal. If the surgeon knows that the bladder is ruptured he should operate at once in order to provide escape for the urine, and also to sew up the rent. If the possibility of the bladder being ruptured be even suspected, the surgeon should pass a catheter. Perhaps he draws off an ounce or two of blood-stained urine. This makes him doubly suspicious, so he injects into the bladder five, eight or ten ounces of warm boracic lotion, and, leaving it there for a few minutes, he measures the amount which he is able afterwards to withdraw. If he finds that a certain amount is lost he is assured that a leakage has taken place and he at once proceeds to operate. If only the diagnosis is made promptly, and the operation is at once undertaken the outlook is not unfavourable. A generation or so back nearly all the cases of rupture of bladder ended fatally.

Villous disease of the bladder is innocent: that is to say, it does not spread to the neighbouring structures or implicate the lymphatic glands. The villi are slender, branched, filamentous processes which, springing from the floor of the bladder, float in the urine like seaweed. They are freely supplied with blood-vessels, so that when a piece of a villus is broken off there is likely to be blood in the urine. Indeed, painless haemorrhage is one of the characteristic features of the disease, and when fragments of the "seaweed" are found in the urine the diagnosis is clear. If the bladder is opened from the front, as already described, the villi may be nipped off by special forceps and the disease permanently cured.

Malignant disease of the bladder is almost always the warty form of cancer known as epithelioma. It springs as a sessile growth from the mucous membrane of the floor near the opening of one of the ureters, and, worrying the sensory nerves, causes irritability of the bladder and incontinence of urine. In due course septic germs reach the bladder, either from the urethra, the bowel, the kidneys or the blood-stream, and cystitis sets in. When ulceration has taken place, blood occurs in the urine, and the patient—generally beyond middle age—suffers dull or lancinating pains. Eventually the rectum may also be involved and the distress becomes extreme. The presence of the growth may be determined by sounding the bladder, by the cystoscope, and by the finger in the rectum. If the growth invades the outlet, retention of urine may occur, and the surgeon may be compelled to open the bladder from the front of the abdomen. In cases where operation is out of the question, washing the bladder with hot boracic lotion may give great relief. The treatment of cancer of the bladder by operation is, as a rule, unsatisfactory, because of the close proximity of the growth to the ureters and to the rectum. If, however, the disease were recognized early and had not invaded the neighbouring structures, and if it were upon the upper or the anterior part of the bladder, its removal might be hopefully undertaken.

Hypertrophy. *Dilatation.*—When there is long-continued obstruction to the flow of urine, as in stricture of the urethra, or enlargement of the prostate, the bladder-wall becomes much thickened, the muscular fibres increasing both in size and number; the condition is known as "hypertrophy." Hypertrophy may be accompanied by dilatation of the bladder, a condition which the bladder may assume when the voiding of its contents is interfered with for a length of time.

Paralysis of the bladder is a want of contractile power in the muscular fibres of the bladder-wall. It may result from injuries whereby the spinal cord is lacerated or pressed upon, so that the micturition centre, which is situated in the lumbar region, is thrown out of working order. The result may be either retention or incontinence of urine; sometimes there is at first retention, which later is followed by incontinence. Paralysis is also met with in certain nervous diseases, as in locomotor ataxia, and in various cerebral lesions, as in apoplexy.

Atony of the bladder is a paresis or partial paralysis. It is due to a want of tone in the muscular fibres, and is frequently the result of over-distension of the bladder, such as may occur in cases of enlargement of the prostate. The patient is unable to empty the bladder, and the condition of atony gets increasingly worse.

In both paralysis and atony the indication is carefully to prevent over-distension by the urine being retained too long, and at the same time to treat by appropriate means the cause which has produced or is keeping up the condition.

Incontinence of urine may occur in the adult or in the child, but is due to widely different causes in the two cases. In the child it may be simply a bad habit, the child not having been properly trained; but more frequently there is a want of control in the micturition-centre, so that the child passes its water unwittingly, especially during the night. In adults it is not so much a condition of incontinence in the sense of water being passed against the will, but is a suggestion that the bladder is already full, the water which passes being the overflow from a too full reservoir. It is usually caused by an obstruction external to the bladder, e.g. enlarged prostate or stricture of the urethra; a calculus may produce the condition. In the child an attempt must be made to improve the tone of the micturition-centre by the use of belladonna or strychnine internally, and of a blister or faradism externally over the lumbar region, and every effort should be made to train the child to pass water at stated times and regular intervals. In the adult the cause which produces the over-distension must be removed if possible; but, as a rule, the patient has to be provided with a catheter, which he can pass before the bladder has filled to overflowing. A soft flexible catheter should be given in preference to a rigid or semi-rigid one. The best form is the red-rubber catheter, and he should be taught the need of keeping it absolutely clean. In the case of children incontinence of urine means irritability; in adults it means overflow.

The condition termed by Sir James Paget *stammering micturition* is analogous to speech stammering, and occurs in those who are nervous and easily put out. It would seem to be due to the sphincter of the bladder not relaxing synchronously with the contraction of the detrusor, and is sometimes caused by external irritation, such as preputial adhesions. Occasionally not a drop of urine can be passed, or a little passes and then a sudden stoppage occurs; the more the patient strains the worse he becomes, until at last there is complete retention of urine. The trouble can sometimes be cured by the removal of irritating causes, and in these cases, as well as in those in which no such cause can be discovered, care should be taken to avoid those difficulties which have given rise to the patient's worst failures. If at any time he should fail to perform the act of micturition, he ought not to strain, but should quietly wait for a little before making any further effort. Regularity in the times of making water is also of much importance.

Retention of urine may occur in paralysis of the bladder, or in conditions where the patient is suffering from an illness which blunts

the nervous sensibility, such as apoplexy, concussion of the brain, or typhoid fever. It is, however, more commonly due to obstruction anterior to the bladder, as in stricture of the urethra or enlargement of the prostate. The distended bladder can be felt as a rounded swelling above the pubes, and perhaps reaching to the level of the navel. Percussion over it gives a dull note. When the bladder is distended, it is necessary to evacuate it as soon as possible. If there is no obstruction to the flow of urine, the retention being due to atony or paralysis, a soft catheter is passed and the water drawn off. But when there is an obstruction which cannot be overcome, aspiration has to be resorted to, the needle of the aspirator being pushed through the abdominal wall into the bladder. The point of puncture in the abdominal wall is in the middle line a few inches above the symphysis pubis. The bladder may be emptied in this way very many times in the same person with only good result.

Diseases of Prostate Gland.

The prostate gland may become acutely inflamed as the result of the backward extension of gonorrhoeal inflammation of the urethra; it may also be attacked by the germs of ordinary suppuration as well as by the bacilli of tuberculosis. A sudden enlargement of a large gland lying against the outlets of the bladder and the bowel renders micturition difficult, painful or impossible, and interferes with defecation. Pressure of the seat of the chair upon the perineum also causes distress, so the man sits sideways and on the edge of the seat. If abscess forms, it should be incised from the perineum; if allowed to run its course it may burst into the bladder, the urethra or the rectum, and set up serious complication. The treatment of prostatitis (inflammation of the prostate) consists in rest in bed, sitz-baths and fomentations. If retention of urine takes place a soft catheter must be passed. In the early stage of an acute attack a dozen leeches upon the perineum may do good. The bowels must be kept freely open, and from time to time, as the pain demands, a morphia suppository may be introduced into the bowel.

Chronic prostatitis is a legacy from a recent or long-past attack of gonorrhoea. The enlargement gives rise to a feeling of weight and fulness in the perineum, irritability of the bladder, and a gleet-like urethral discharge. Manual examination reveals the presence of a large, hard mass in front of the bladder, and in the mass there can often be felt softish or tender areas which seem to threaten abscess. On urine being passed into a glass, a cloudiness is seen, and material like pieces of vermicelli or broken threads may be noticed. These are the castings from the long tubular glands, and are characteristic of chronic inflammation of the prostate. The occasional passage of a large metal bougie, the use of weak lotions of nitrate of silver, the administration of quinine and iron, and the application of blisters to the perineum, may be tried as circumstances direct. The patient should lead a quiet life, free from sexual excitement. Horse-exercise, cycle-riding, rough games and alcohol should be avoided.

Enlargement of the prostate exists in a considerable proportion of men of about sixty years of age and onward. It consists of an uncontrolled growth of the normal muscular and glandular tissue of the prostate, interfering with, or absolutely stopping, the outflow of the urine. Gently pushing the bladder upwards and backwards, it increases the length of the urethra, so that in order to draw off retained urine the catheter must be longer than ordinary, but inasmuch as there is no actual narrowing of the passage it may be of full calibre. The beak should be well turned up so that it may ride in front of, and surmount, the median enlargement. Because of the thick, ring-like mass of new tissue around the outlet of the bladder, there is difficulty in micturition, and because the muscular bladder wall is now unable to contract upon all its contents a certain amount of urine is retained. As the enlarged prostate bulges up in the floor of the bladder, a pouch or hollow forms behind it, from which the muscular wall is unable to dislodge the stagnant urine. This keeps up constant irritation, and if by chance the germs of decomposition find their way thither, cystitis sets in and the patient's condition becomes serious, not only because of the risk to which his tired and irritated kidneys are submitted, but because of the possibility of a phosphatic stone being formed in the bladder. The seriousness of enlargement of the prostate does not depend upon the size of the growth so much as upon the inability of the patient to empty his bladder completely.

The surgeon forms his estimate of the size of the prostate by rectal examination. But sometimes a patient has retention of urine from

enlarged prostate, when by this method of manual examination the amount of increase appears quite unimportant. The explanation is that the enlargement is chiefly confined to a small piece of the gland which protrudes like a tongue into the water-way. Robert M^cGill of Leeds was the first surgeon to remove by a supra-pubic operation this tongue-like process of new prostatic growth. Attempts had sometimes been made to get rid of it by instrumentation through the urethra, but they had not met with much success.

When the surgeon has made out the existence of an enlargement of the prostate, the next thing is to find to what extent this interferes with the bladder being emptied. To do this, he asks the patient to pass as much water as he is able, and then with due precautions introduces a soft catheter and measures the amount of urine which he thus draws off—half an ounce, an ounce, two ounces, however much it may be. It is this "residual urine" which causes the annoyance and the danger of enlarged prostate, and unless arrangements can be made for its regular withdrawal serious trouble is almost certain to ensue. The passing of a large catheter may have the effect of so opening up the water-way that, at any rate for a time, the irritability of the bladder may cease, in which case the patient may be instructed in the art of passing a catheter for himself. Or the surgeon may find that in addition to the regular passing of a large catheter an occasional washing-out of the bladder with hot boracic lotion is all that is needed in the way of active treatment. At the same time, however, the patient is placed upon a plain and wholesome diet with little or no alcohol, and he is instructed to lead in every respect a regular and quiet life. To many men with enlarged prostate the passing of an instrument night and morning is no great hardship, while to others the idea of leading what is called a "catheter life" appears intolerable, or, having for a time been patiently carried out, is found not only severely trying but greatly disappointing.

In some people the very first passing of a catheter sets up a local and constitutional disturbance, the bladder being rendered irritable and intolerant, the temperature going up, and shiverings and perspirations manifesting themselves. This condition was formerly called "catheter fever," and was looked upon as something mysterious and peculiar. It is now generally understood to be the result of septic inoculation of the interior of the bladder.

Lastly, in other persons the passing of the catheter is attended with so much difficulty, distress or bleeding, that something more helpful and effectual is urgently called for.

Operative Treatment.—It has long been known that large tumours of the uterus sometimes dwindle if the ovaries are removed by operation, and Professor William White of Philadelphia thought that prostatic growths might be similarly influenced by the removal of the testicles. Beyond question considerable improvement has followed this operation in cases of enlargement of the prostate, especially where the enlargement seemed to be general, soft and vascular. A similar though perhaps a slower effect is produced when the duct of the testis, the vas deferens, is divided on each side of the body. If there is no great urgency about the case this treatment may well be tried, the bladder being all the while duly emptied by catheter and washed by irrigation. But if the case is urgent, there being difficulty or bleeding with the passing of the catheter, the bladder being excessively irritable and the urine foul, a more radical measure is needed. The best operation is that upon the lines laid down by Robert M^cGill, who opened the bladder through the anterior abdominal wall and removed that part of the prostate gland which was blocking the water-way. M^cGill's operation was improved upon by Eugene Fuller of New York, who, in 1895, published a full account of his procedure.¹ Having opened the bladder from the front (as in supra-pubic lithotomy), he introduced his left index finger into the rectum and thrust the prostate gland towards the right index finger, which was then in the bladder. With the nail of that finger, or with the end of a pair of scissors, he made a rent in the mucous membrane of the bladder and the capsule of the gland, and then shelled out the mass of new tissue which had caused the prostatic enlargement. This operation is called "prostatectomy," which means the removal of the prostate gland. The prostate gland, however, is not removed, but only a muscular and glandular mass (adenoma), which, growing within the prostatic capsule, encircles the urethra and squeezes the original gland tissue out of existence. Following on the lines of M^cGill and Fuller, P. J. Frey has done excellent work in England towards placing this operation upon a sound basis.

Subsequently to the operation the bladder enjoys complete

¹ *Diseases of the Genito-urinary System*, by Eugene Fuller, M.D. (London and New York, 1900).

and needful rest, and the kidneys, which previously were in a condition of perpetual disturbance, improve in working power. The wound in the bladder and in the abdominal wall gradually closes; the function of the bladder returns, and the patient is soon able to go back to his usual occupation in greatly improved health and vigour. The operation is, necessarily, a serious one, and the age of the patient, the condition of his bladder, of his kidneys, and of his blood-vessels, require to be taken into consideration; still, the operation gives an excellent account of itself in statistics, and if a practical surgeon advises a patient to accept its risks his counsel may well be followed.

Malignant disease of the prostate is distinguished from senile glandular enlargement by the rapidity of its growth, by the frequency of the bleeding which is associated with the introduction of a catheter, and by the marked wasting which the individual undergoes. Unfortunately, by the time that the cancerous nature of the disease is definitely recognized, the prospect of relief being afforded by operation is small. (E. O.)*

BLADDER-WORT, the name given to a submerged water plant, *Utricularia vulgaris*, with finely divided leaves upon which are borne small bladders provided with trap-door entrances which open only inwards. Small crustaceans and other aquatic animals push their way into the bladders and are unable to escape. The products of the decay of the organisms thus

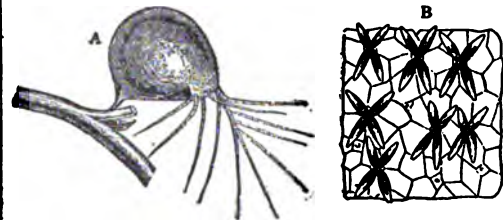

A, Bladder of *Utricularia neglecta* (after Darwin), enlarged. B, stellate hairs from interior of bladder of *U. vulgaris*.

captured are absorbed into the plant by star-shaped hairs which line the interior of the bladder. In this way the plant is supplied with nitrogenous food from the animal kingdom. Bladder-wort bears small, yellow, two-lipped flowers on a stem which rises above the surface of the water. It is found in pools and ditches in the British Isles, and is widely distributed in the north temperate zone. The genus contains about two hundred species in tropical and temperate regions.

BLADES, WILLIAM (1824–1890), English printer and bibliographer, was born at Clapham, London, on the 5th of December 1824. In 1840 he was apprenticed to his father's printing business in London, being subsequently taken into partnership. The firm was afterwards known as Blades, East & Blades. His interest in printing led him to make a study of the volumes produced by Caxton's press, and of the early history of printing in England. His *Life and Typography of William Caxton, England's First Printer*, was published in 1861–1863, and the conclusions which he set forth were arrived at by a careful examination of types in the early books, each class of type being traced from its first use to the time when, spoilt by wear, it passed out of Caxton's hands. Some 450 volumes from the Caxton Press were thus carefully compared and classified in chronological order. In 1877 Blades took an active part in organizing the Caxton celebration, and strongly supported the foundation of the Library Association. He was a keen collector of old books, prints and medals. His publications relate chiefly to the early history of printing, the *Enemies of Books*, his most popular work, being produced in 1881. He died at Sutton in Surrey on the 27th of April 1890.

BLAENAVON, or **BLAENAFON**, an urban district in the northern parliamentary division of Monmouthshire, England, 15 m. N. by W. of Newport, on the Great Western, London & North Western and Rhymney railways. Pop. (1901) 10,869. It lies in the uppermost part of the Afon Lwyd valley, at an elevation exceeding 1000 ft., in a wild and mountainous district, on the eastern

edge of the great coal and iron mining region of Glamorganshire and Monmouthshire. There are very extensive iron and steel works, with blast furnaces and rolling mills in the district, which employ the large industrial population.

BLAGOVYESHCHENSK, a town of East Siberia, chief town of the Amur government, on the left bank of the Amur, near its confluence with the Zeya in 50° 15' N. lat. and 127° 38' E. long., 610 m. by river above Khabarovsk. Founded in 1856, the town had, in 1900, 37,368 inhabitants, and is the seat of the bishop of Amur and Kamchatka. There are steam flour-mills and iron-works. It is a centre for tea exported to Russia, cattle brought from Transbaikalia and Mongolia for the Amur, and for grain.

BLAIKIE, WILLIAM GARDEN (1820-1899), Scottish divine, was born on the 5th of February 1820, at Aberdeen, where his father had been the first provost of the reformed corporation. After studying at the Marischal College, where Alexander Bain and David Masson were among his contemporaries, he went in 1839 to Edinburgh to complete his theological course under Thomas Chalmers. In 1842 he was presented to the living of Drumblade by Lord Kintore, with whose family he was connected. The Disruption controversy reached its climax immediately afterwards, and Blaikie, whose sympathies were entirely with Chalmers, was one of the 474 ministers who signed the deed of demission and gave up their livings. He was Free Church minister at Pilrig, between Edinburgh and Leith, from 1844 to 1868. Keenly interested in questions of social reform, his first publication was a pamphlet, which was afterwards enlarged into a book called *Better Days for Working People*. It received public commendation from Lord Brougham, and 60,000 copies were sold. He formed an association for providing better homes for working people, and the Pilrig Model Buildings were erected. He also undertook the editorship of the *Free Church Magazine*, and then that of the *North British Review*, which he carried on until 1863. In 1864 he was asked to undertake the Scottish editorship of the *Sunday Magazine*, and for this magazine much of his most characteristic literary work was done, especially in the editorial notes, then a new feature in magazine literature.

In 1868 Blaikie was called to the chair of apologetics and pastoral theology at New College, Edinburgh. In dealing with the latter subject he was seen at his very best. He had wide experience, a comprehensive grasp of facts, abundant sympathy, an extensive knowledge of men, and a great capacity for teaching. In 1870 he was one of two representatives chosen from the Free Church of Scotland to attend the united general assembly of the Presbyterian churches of the United States. He prolonged his visit to make a thorough acquaintance with American Presbyterianism, and this, followed by a similar tour in Europe, fitted him to become the real founder of the Presbyterian Alliance. Much of his strength in the later years of life was given to this work. In 1892 he was elected to the chairmanship of the general assembly, the last of the moderators who had entered the church before the disruption. In 1897 he resigned his professorship, and died on the 11th of June 1899.

Blaikie was an ardent philanthropist, and an active and intelligent temperance reformer, in days when this was far from easy. He raised £14,000 for the relief of the Waldensian churches. Although he took an active part in the affairs of his denomination, he was not a mere ecclesiastic. He had a keen eye for the evidences of spiritual growth or decline, and emphasized the need of maintaining a high level of spiritual life. He welcomed Moody to Scotland, and the evangelist made his headquarters with him during his first visit. His best books are *The Work of the Ministry—A Manual of Homiletic and Pastoral Theology* (1873); *The Books of Samuel in the Expositors' Bible Series* (2 vols.); *The Personal Life of David Livingstone* (1880); *After Fifty Years* (1893), an account of the Disruption Movement in the form of letters of a grandfather; *Thomas Chalmers* (1896). (D. MN.)

BLAINE, JAMES GILLESPIE (1830-1893), American statesman, was born in West Brownsville, Pennsylvania, on the 31st of January 1830, of sturdy Scottish-Irish stock on the side of his father. He was the great-grandson of Colonel Ephraim Blaine

(1741-1804), who during the War of Independence served in the American army, from 1778 to 1782 as commissary-general of the Northern Department. With many early evidences of literary capacity and political aptitude, J. G. Blaine graduated at Washington College in Washington, Pennsylvania, in 1847, and subsequently taught successively in the Military Institute, Georgetown, Kentucky, and in the Institution for the Blind at Philadelphia. During this period, also, he studied law. Settling in Augusta, Maine, in 1854, he became editor of the *Kennebec Journal*, and subsequently of the *Portland Advertiser*. But his editorial work was soon abandoned for a more active public career. He was elected to the lower house of the state legislature in 1858, and served four years, the last two as speaker. He also became chairman of the Republican state committee in 1859, and for more than twenty years personally directed every campaign of his party.

In 1862 he was elected to Congress, serving in the House thirteen years (December 1863 to December 1876), followed by a little over four years in the Senate. He was chosen speaker of the House in 1869 and served three terms. The House was the fit arena for his political and parliamentary ability. He was a ready and powerful debater, full of resource, and dexterous in controversy. The tempestuous politics of the war and reconstruction period suited his aggressive nature and constructive talent. The measures for the rehabilitation of the states that had seceded from the Union occupied the chief attention of Congress for several years, and Blaine bore a leading part in framing and discussing them. The primary question related to the basis of representation upon which they should be restored to their full rank in the political system. A powerful section contended that the basis should be the body of legal voters, on the ground that the South could not then secure an increment of political power on account of the emancipated blacks unless these blacks were admitted to political rights. Blaine, on the other hand, contended that representation should be based on population instead of voters, as being fairer to the North, where the ratio of voters varied widely, and he insisted that it should be safeguarded by security for impartial suffrage. This view prevailed, and the Fourteenth Amendment to the Constitution was substantially Blaine's proposition. In the same spirit he opposed a scheme of military governments for the southern states, unless associated with a plan by which, upon the acceptance of prescribed conditions, they could release themselves from military rule and resume civil government. He was the first in Congress to oppose the claim, which gained momentary and widespread favour in 1867, that the public debt, pledged in coin, should be paid in greenbacks. The protection of naturalized citizens who, on return to their native land, were subject to prosecution on charges of disloyalty, enlisted his active interest and support, and the agitation, in which he was conspicuous, led to the treaty of 1870 between the United States and Great Britain, which placed adopted and native citizens on the same footing.

As the presidential election of 1876 approached, Blaine was clearly the popular favourite of his party. His chance for securing the nomination, however, was materially lessened by persistent charges which were brought against him by the Democrats that as a member of Congress he had been guilty of corruption in his relations with the Little Rock & Fort Smith and the Northern Pacific railways.¹ By the majority of Republicans, at least, he was considered to have cleared himself completely, and in the Republican national convention he missed by only twenty-eight votes the nomination for president, being finally beaten by a combination of the supporters of all the other candidates. Thereupon he entered the Senate, where his activity was unabated. Currency legislation was especially prominent. Blaine, who had previously opposed greenback inflation now resisted depreciated silver coinage. He was the earnest champion of the advancement of American shipping, and advocated liberal subsidies, insisting that the policy of protection should be applied on sea as well as on land. The Republican national

¹ This attack led to a dramatic scene in the House, in which Blaine fervidly asseverated his denial.

convention of 1880, divided between the two nearly equal forces of Blaine and General U. S. Grant—John Sherman of Ohio also having a considerable following—struggled through thirty-six ballots, when the friends of Blaine, combining with those of Sherman, succeeded in nominating General James A. Garfield. In the new administration Blaine became secretary of state, but, owing to the assassination of President Garfield and the reorganization of the cabinet by President Chester A. Arthur, he held the office only until December 1881. His brief service was distinguished by several notable steps. In order to promote the friendly understanding and co-operation of the nations on the American continent he projected a Pan-American congress, which, after being arranged for, was frustrated by his retirement. He also sought to secure a modification of the Clayton-Bulwer treaty, and in an extended correspondence with the British government strongly asserted the policy of an exclusive American control of any isthmian canal which might be built to connect the Atlantic and Pacific oceans.

With undiminished hold on the imagination and devotion of his followers he was nominated for president in 1884. After a heated canvass, in which he made a series of brilliant speeches, he was beaten by a narrow margin in New York. By many, including Blaine himself, the defeat was attributed to the effect of a phrase, "Rum, Romanism and Rebellion," used by a clergyman, Rev. Samuel D. Burchard (1812-1891), on the 29th of October 1884, in Blaine's presence, to characterize what, in his opinion, the Democratic party stood for. The phrase was not Blaine's, but his opponents made use of it to misrepresent his attitude toward the Roman Catholics, large numbers of whom are supposed, in consequence, to have withdrawn their support. Refusing to be a presidential candidate in 1888, he became secretary of state under President Harrison, and resumed his work which had been interrupted nearly eight years before. The Pan-American congress, then projected, now met in Washington, and Blaine, as its master spirit, presided over and guided its deliberation through its session of five months. Its most important conclusions were for reciprocity in trade, a continental railway and compulsory arbitration in international complications. Shaping the tariff legislation for this policy, Blaine negotiated a large number of reciprocity treaties which augmented the commerce of his country. He upheld American rights in Samoa, pursued a vigorous diplomacy with Italy over the lynching of seven Italians, all except three of them American naturalized citizens, in New Orleans on the 14th of May 1891, held a firm attitude during the strained relations between the United States and Chile (growing largely out of the killing and wounding of American sailors of the U.S. ship "Baltimore" by Chileans in Valparaiso on the 16th of October 1891), and carried on with Great Britain a resolute controversy over the seal fisheries of Bering Sea,—a difference afterwards settled by arbitration. He resigned on the 4th of June 1892, on the eve of the meeting of the Republican national convention, wherein his name was ineffectually used, and he died at Washington, D.C., on the 27th of January 1893.

During his later years of leisure he wrote *Twenty Years of Congress* (1884-1886), a brilliant historical work in two volumes. Of singularly alert faculties, with a remarkable knowledge of the men and history of his country, and an extraordinary memory, his masterful talent for politics and state-craft, together with his captivating manner and engaging personality, gave him, for nearly two decades, an unrivalled hold upon the fealty and affection of his party.

See the *Biography of James G. Blaine* (Norwich, Conn., 1895) by Mary Abigail Dodge ("Gail Hamilton"), and, in the "American Statesmen Series," *James G. Blaine* (Boston, 1905) by C. E. Stawood; also *Mrs Blaine's Letters* (1908). (C. E. S.)

BLAINVILLE, HENRI MARIE DUCROTAY DE (1777-1850), French naturalist, was born at Arques, near Dieppe, on the 12th of September 1777. About 1796 he went to Paris to study painting, but he ultimately devoted himself to natural history, and attracted the attention of Baron Cuvier, for whom he occasionally lectured at the Collège de France and at the

Athenaeum. In 1812 he was aided by Cuvier to obtain the chair of anatomy and zoology in the Faculty of Sciences at Paris, but subsequently an estrangement grew up between the two men and ended in open enmity. In 1825 Blainville was admitted a member of the Academy of Sciences; and in 1830 he was appointed to succeed J. B. Lamarck in the chair of natural history at the museum. Two years later, on the death of Cuvier, he obtained the chair of comparative anatomy, which he continued to occupy for the space of eighteen years, proving himself no unworthy successor to his great teacher. He died at Paris on the 1st of May 1850. Besides many separate memoirs, he was the author of *Prodrome d'une nouvelle distribution méthodique du règne animal* (1816); *Ostéographie ou description iconographique comparée du squelette, &c.* (1839-1864); *Faune française* (1821-1830); *Cours de physiologie générale et comparée* (1833); *Manuel de malacologie et de conchyliologie* (1825-1827); *Histoire des sciences de l'organisme* (1845).

BLAIR, FRANCIS PRESTON (1791-1876), American journalist and politician, was born at Abingdon, Virginia, on the 12th of April 1791. He removed to Kentucky, graduated at Transylvania University in 1811, took to journalism, and was a contributor to Amos Kendall's paper, the *Argus*, at Frankfort. In 1830, having become an ardent follower of Andrew Jackson, he was made editor of the *Washington Globe*, the recognized organ of the Jackson party. In this capacity, and as a member of Jackson's "Kitchen Cabinet," he long exerted a powerful influence; the *Globe* was the administration organ until 1841, and the chief Democratic organ until 1845; Blair ceased to be its editor in 1849. In 1848 he actively supported Martin Van Buren, the Free Soil candidate, for the presidency, and in 1852 he supported Franklin Pierce, but soon afterwards helped to organize the new Republican party, and presided at its preliminary convention at Pittsburg, Pennsylvania, in February 1856. He was influential in securing the nomination of John C. Frémont at the June convention (1856), and of Abraham Lincoln in 1860. After Lincoln's re-election in 1864 Blair thought that his former close personal relations with the Confederate leaders might aid in bringing about a cessation of hostilities, and with Lincoln's consent went unofficially to Richmond and induced President Jefferson Davis to appoint commissioners to confer with representatives of the United States. This resulted in the futile "Hampton Roads Conference" of the 3rd of February 1865 (see LINCOLN, ABRAHAM). After the Civil War Blair became a supporter of President Johnson's reconstruction policy, and eventually rejoined the Democratic party. He died at Silver Spring, Maryland, on the 18th of October 1876.

His son, **MONTGOMERY BLAIR** (1813-1883), politician and lawyer, was born in Franklin county, Kentucky, on the 10th of May 1813. He graduated at West Point in 1835, but, after a year's service in the Seminole War, left the army, studied law, and began practice at St Louis, Missouri. After serving as United States district attorney (1839-1843), as mayor of St Louis (1842-1843), and as judge of the court of common pleas (1843-1849), he removed to Maryland (1852), and devoted himself to law practice principally in the Federal supreme court. He was United States solicitor in the court of claims from 1855 until 1858, and was associated with George T. Curtis as counsel for the plaintiff in the Dred Scott case in 1857. In 1860 he took an active part in the presidential campaign in behalf of Lincoln, in whose cabinet he was postmaster-general from 1861 until September 1864, when he resigned as a result of the hostility of the Radical Republican faction, who stipulated that Blair's retirement should follow the withdrawal of Frémont's name as a candidate for the presidential nomination in that year. Under his administration such reforms and improvements as the establishment of free city delivery, the adoption of a money order system, and the use of railway mail cars were instituted—the last having been suggested by George B. Armstrong (d. 1871), of Chicago, who from 1869 until his death was general superintendent of the United States railway mail service. Differing from the Republican party on the reconstruction policy, Blair gave his adherence to the Democratic party after the Civil

War. He died at Silver Spring, Maryland, on the 27th of July 1883.

Another son, FRANCIS PRESTON BLAIR, jun. (1821-1875), soldier and political leader, was born at Lexington, Kentucky, on the 19th of February 1821. After graduating at Princeton in 1841 he practised law in St Louis, and later served in the Mexican War. He was ardently opposed to the extension of slavery and supported Martin Van Buren, the Free Soil candidate for the presidency in 1848. He served from 1852 to 1856 in the Missouri legislature as a Free Soil Democrat, in 1856 joined the Republican party, and in 1857-1860 and 1861-1862 was a member of Congress, where he proved an able debater. Immediately after South Carolina's secession, Blair, believing that the southern leaders were planning to carry Missouri into the movement, began active efforts to prevent it and personally organized and equipped a secret body of 1000 men to be ready for the emergency. When hostilities became inevitable, acting in conjunction with Captain (later General) Nathaniel Lyon, he suddenly transferred the arms in the Federal arsenal at St Louis to Alton, Illinois, and a few days later (May 10, 1861) surrounded and captured a force of state guards which had been stationed at Camp Jackson in the suburbs of St Louis with the intention of seizing the arsenal. This action gave the Federal cause a decisive initial advantage in Missouri. Blair was promoted brigadier-general of volunteers in August 1862 and a major-general in November 1862. In Congress as chairman of the important military affairs committee his services were of the greatest value. He commanded a division in the Vicksburg campaign and in the fighting about Chattanooga, and was one of Sherman's corps commanders in the final campaigns in Georgia and the Carolinas. In 1866 like his father and brother he opposed the Congressional reconstruction policy, and on that issue left the Republican party. In 1868 he was the Democratic candidate for vice-president on the ticket with Horatio Seymour. In 1871-1873 he was a United States senator from Missouri. He died in St Louis, on the 8th of July 1875.

BLAIR, HUGH (1718-1800), Scottish Presbyterian divine, was born on the 7th of April 1718, at Edinburgh, where his father was a merchant. Entering the university in 1730 he graduated M.A. in 1739; his thesis, *De Fundamentis et Obligatione Legis Naturæ*, contains an outline of the moral principles afterwards unfolded in his sermons. He was licensed to preach in 1741, and a few months later the earl of Leven, hearing of his eloquence, presented him to the parish of Colleslie in Fife. In 1743 he was elected to the second charge of the Canongate church, Edinburgh, where he ministered until removed to Lady Yester's, one of the city churches, in 1754. In 1757 the university of St Andrews conferred on him the degree of D.D., and in the following year he was promoted to the High Church, Edinburgh, the most important charge in Scotland. In 1759 he began, under the patronage of Lord Kames, to deliver a course of lectures on composition, the success of which led to the foundation of a chair of rhetoric and *belles lettres* in the Edinburgh University. To this chair he was appointed in 1762, with a salary of £70 a year. Having long taken interest in the Celtic poetry of the Highlands, he published in 1763 a laudatory *Dissertation* on Macpherson's *Ossian*, the authenticity of which he maintained. In 1777 the first volume of his *Sermons* appeared. It was succeeded by four other volumes, all of which met with the greatest success. Samuel Johnson praised them warmly, and they were translated into almost every language of Europe. In 1780 George III. conferred upon Blair a pension of £200 a year. In 1783 he retired from his professorship and published his *Lectures on Rhetoric*, which have been frequently reprinted. He died on the 27th of December 1800. Blair belonged to the "moderate" or latitudinarian party, and his *Sermons* have been criticized as wanting in doctrinal definiteness. His works display little originality, but are written in a flowing and elaborate style. He is remembered chiefly by the place he fills in the literature of his time. *Blair's Sermons* is a typical religious book of the period that preceded the Anglican revival.

See J. Hall, *Account of Life and Writings of Hugh Blair* (1807).

BLAIR, JAMES (1656-1743), American divine and educationalist, was born in Scotland, probably at Edinburgh, in 1656. He graduated M.A. at Edinburgh University in 1673, was beneficed in the Episcopal Church in Scotland, and for a time was rector of Cranston Parish in the diocese of Edinburgh. In 1682 he left Scotland for England, and three years later was sent by the bishop of London, Henry Compton, as a missionary to Virginia. He soon gained great influence over the colonists both in ecclesiastical and in civil affairs, and, according to Prof. Moses Coit Tyler, "probably no other man in the colonial time did so much for the intellectual life of Virginia." He was the minister of Henrico parish from 1685 until 1694, of the Jamestown church from 1694 until 1710, and of Bruton church at Williamsburg from 1710 until his death. From 1689 until his death he was the commissary of the bishop of London for Virginia, the highest ecclesiastical position in the colony, his duties consisting "in visiting the parishes, correcting the lives of the clergy, and keeping them orderly." In 1693, by the appointment of King William III., he became a member of the council of Virginia, of which he was for many years the president. Largely because of charges brought against them by Blair, Governor Sir Edmund Andros, Lieutenant-governor Francis Nicholson, and Lieutenant-governor Alexander Spotswood were removed in 1698, 1705 and 1722 respectively. Blair's greatest service to the colony was rendered as the founder, and the president from 1693 until his death, of the College of William and Mary, for which he himself secured a charter in England. "Thus, James Blair may be called," says Tyler, "the creator of the healthiest and most extensive intellectual influence that was felt in the Southern group of colonies before the Revolution." He died on the 18th of April 1743, and was buried at Jamestown, Va. He published a collection of 117 discourses under the title *Our Saviour's Divine Sermon on the Mount* (4 vols., 1722; second edition, 1732), and, in collaboration with Henry Hartwell and Edward Chilton, a work entitled *The Present State of Virginia and the College* (1727; written in 1693), probably the best account of the Virginia of that time.

See Daniel E. Motley's *Life of Commissary James Blair* (Baltimore, 1901; series xix. No. 10, of the Johns Hopkins University Studies in Historical and Political Science), and, for a short sketch and an estimate, M. C. Tyler's *A History of American Literature, 1607-1765* (New York, 1878).

BLAIR, ROBERT (1699-1746), Scottish poet, eldest son of the Rev. Robert Blair, one of the king's chaplains, was born at Edinburgh in 1699. He was educated at Edinburgh University and in Holland, and in 1731 was appointed to the living of Athelstaneford in East Lothian. He married in 1738 Isabella, daughter of Professor William Law. The possession of a small fortune gave him leisure for his favourite pursuits, gardening and the study of English poets. He died at Athelstaneford on the 4th of February 1746. His only considerable work, *The Grave* (1743), is a poem written in blank verse of great vigour and freshness, and is much less conventional than its gloomy subject might lead one to expect. Its religious subject no doubt contributed to its great popularity, especially in Scotland; but the vogue it attained was justified by its picturesque imagery and occasional felicity of expression. It inspired William Blake to undertake a series of twelve illustrative designs, which were engraved by Louis Schiavonetti, and published in 1808.

See the biographical introduction prefixed to his *Poetical Works*, by Dr Robert Anderson, in his *Poets of Great Britain*, vol. viii. (1794.)

BLAIR ATHOLL (Gaelic *Blair*, "a plain"), a village and parish of Perthshire, Scotland, 35½ m. N.W. of Perth by the Highland railway. Pop. (1901) 367; of parish, 1722. It is situated at the confluence of the Tilt and the Garry. The oldest part of Blair Castle, a seat of the duke of Atholl, dates from 1269; as restored and enlarged in 1869-1872 from the plans of David Bryce, R.S.A., it is a magnificent example of the Scottish baronial style. It was occupied by the marquess of Montrose prior to the battle of Tippermuir in 1644, stormed by the Cromwellians in 1653, and garrisoned on behalf of James II. in 1689. The Young Pretender stayed in it in 1745, and the duke of

Cumberland in 1746. The body of Viscount Dundee, conveyed hither from the battlefield of Killiecrankie, was buried in the church of Old Blair, in which a monument was erected to his memory in 1889 by the 7th duke of Atholl. The grounds surrounding the castle are among the most beautiful in the Highlands. A golf course has been laid down south-east of the village, between the railway and the Garry, and every September a great display of Highland games is held. Ben-y-gloe (3671 ft. high), the scene of the hunt given in 1529 by the earl of Atholl in honour of James V. and the queen dowager, may be climbed by way of Fender Burn, a left-hand tributary of the Tilt. The falls of Fender, near the old bridge of Tilt, are eclipsed by the falls of Bruar, 4 m. west of Blair Atholl, formed by the Bruar, which rising in Ben Dearg (3304 ft.), flows into the Garry after an impetuous course of 10 m.

BLAIRGOWRIE, a police burgh of Perthshire, Scotland, situated on the Ericht. Pop. (1901) 3378. It is the terminus of a branch line of the Caledonian railway from Coupar Angus, from which it is $4\frac{1}{2}$ m. distant, and is 16 m. N. by E. of Perth by road. The town is entirely modern, and owes its progress to the water-power supplied by the Ericht for linen and jute factories. There are also sawmills, breweries and a large factory for bee appliances. Strawberries, raspberries and other fruits are largely grown in the neighbourhood. A park was presented to the town in 1892. On the left bank of the Ericht, opposite Blairgowrie, with which it is connected by a four-arched bridge, stands the town and police burgh of Rattray (pop. 2019), where there are flax and jute mills. Donald Cargill the Covenanter, who was executed at Edinburgh, was a native of the parish. Four miles west of Blairgowrie, on the coach road to Dunkeld, lies Loch Clunie, of some interest historically. On a crannog in the lake are the ruins of a small castle which belonged to James ("the Admirable") Crichton, and the large mound near the loch was the site of the castle in which Edward I. lodged on one of his Scottish expeditions.

BLAKE, EDWARD (1833-), Irish-Canadian statesman, eldest son of William Hume Blake of Cashel Grove, Co. Galway, who settled in Canada in 1832, and there became a distinguished lawyer and chancellor of Ontario, was born on the 13th of October 1833 at Adelaide in Middlesex county, Ontario. Educated at Upper Canada College and the university of Toronto, Blake was called to the bar in 1856 and quickly obtained a good practice, becoming Q. C. in 1864. In 1867 he was elected member for West Durham in the Dominion parliament, and for South Bruce in the provincial legislature, in which he became leader of the Liberal opposition two years later. On the defeat of John Sandfield Macdonald's government in 1871 Blake became prime minister of Ontario, but resigned this office the same year in consequence of the abolition of dual representation. He declined the leadership of the Liberal party in the Dominion parliament, but, having taken an active part in bringing about the overthrow of Sir John Macdonald's ministry in 1873, joined the Liberal cabinet of Alexander Mackenzie, though without portfolio or salary. Impaired health soon compelled him to resign, and to take the voyage to Europe; on his return in 1875 he rejoined the cabinet as minister of justice, in which office it fell to him to take the chief part in framing the constitution of the supreme court of Canada. Continued ill-health compelled him in 1877 again to seek rest in Europe, having first exchanged the portfolio of justice for the less exacting office of president of the council. During his absence the Liberal government was driven from power by the elections of 1878; and Blake himself, having failed to secure re-election, was for a short time without a seat in parliament. From 1880 to 1887 he was leader of the opposition, being succeeded on his resignation of the position in the latter year by Mr. (afterwards Sir) Wilfrid Laurier. In 1892 he became a member of the British House of Commons as an Irish Nationalist, being elected for South Longford. But he did not fulfil the expectations which had been formed on the strength of his colonial reputation; he took no very prominent part in debate, and gave little evidence of his undoubted oratorical gifts. In 1907 he retired from public life. In 1858 he had married

Margaret, daughter of Benjamin Cronyn, first bishop of Huron.

See John Charles Dent, *The Last Forty Years: Canada Since the Union of 1841* (2 vols., Toronto, 1881); J. S. Willison, *Sir Wilfrid Laurier and the Liberal Party* (2 vols., London, 1904).

BLAKE, ROBERT (1599-1657), English parliamentarian and admiral, was born at Bridgwater in Somersetshire. The day of his birth is not known, but he was baptized on the 27th of September 1599. Blake was the eldest son of a well-to-do merchant, and received his early education at the grammar school of Bridgwater. In 1615 he was sent to Oxford, entering at first St Alban's Hall, but removing afterwards to Wadham College, then recently founded. He remained at the university till 1625, but failed to obtain any college preferment. Nothing is known of his life with certainty for the next fifteen years. An anonymous Dutch writer, in the *Hollandische Mercurius* (1652), represents him as saying that he had lived in Schiedam "for five or six years" in his youth. He doubtless engaged in trade, and apparently with success. When, after eleven years of kingship without parliaments, a parliament was summoned to meet in April 1640, Blake was elected to represent his native borough. This parliament, named "the Short," was dissolved in three weeks, and the career of Blake as a politician was suspended. Two years later the inevitable conflict began. Blake declared for the Parliament, and served under Sir John Horner. In 1643 he was entrusted with the command of one of the forts of Bristol. This he stoutly held during the siege of the town by Prince Rupert, and earned the approval of parliament by refusing to surrender his post till duly informed of the capitulation. In 1644 he gained high distinction by the resolute defence of Lyme in Dorsetshire. The siege was raised on the 23rd of May, and on the 8th of July Blake took Taunton by surprise, and notwithstanding its imperfect defences and inadequate supplies, held the town for the Parliament against two sieges by the Royalists until July 1645, when it was relieved by Fairfax. In 1645 he re-entered parliament as member for Taunton, when the Royalist Colonel Windham was expelled.

He adhered to the Parliamentary party after the king's death, and within a month (February 1649) was appointed, with Colonels Dean and Popham, to the command of the fleet, under the title of General of the Sea. In April he was sent in pursuit of Prince Rupert, who with the Royalist fleet had entered the harbour of Kinsale in Ireland. There he blockaded the prince for six months; and when the latter, in want of provisions, and hopeless of relief, succeeded in making his escape with the fleet and in reaching the Tagus, Blake followed him thither, and again blockaded him for some months. The king of Portugal refusing permission for Blake to attack his enemy, the latter made reprisals by falling on the Portuguese fleet, richly laden, returning from Brazil. He captured seventeen ships and burnt three, bringing his prizes home without molestation. After re-activating his fleet, he sailed again, captured a French man-of-war, and then pursued Prince Rupert, who had been asked to go away by the Portuguese and had entered the Mediterranean. In November 1650 Blake destroyed the bulk of the Royalist squadron near Cartagena. The thanks of parliament were voted to Blake, and he received a grant of £1000. He was continued in his office of admiral and general of the sea; and in May following he took, in conjunction with Ayscue, the Scilly Islands. For this service the thanks of parliament were again awarded him, and he was soon after made a member of the council of state.

In 1652 war broke out with the Dutch, who had made great preparations for the conflict. In March the command of the fleet was given to Blake for nine months; and in the middle of May the Dutch fleet of forty-five ships, led by their great admiral Tromp, appeared in the Downs. Blake, who had only twenty ships, sailed to meet them, and the battle took place off Dover on the 10th of May. The Dutch were defeated in an engagement of four or five hours, lost two ships, and withdrew under cover of darkness. Attempts at accommodation were made by the states, but they failed. Early in July war was formally declared,

and in the same month Blake captured a large part of the Dutch fishery-fleet and the twelve men-of-war that formed their convoy. On the 28th of September Blake and Penn again encountered the Dutch fleet, now commanded by De Ruyter and De Witt, off the Kentish Knock, defeated it, and chased it for two days. The Dutch took refuge in Goree. A third battle was fought near the end of November. By this time the ships under Blake's command had been reduced in number to forty, and nearly the half of these were useless for want of seamen. Tromp, who had been reinstated in command, appeared in the Downs, with a fleet of eighty ships besides ten fireships. Blake, nevertheless, risked a battle off Dungeness, but was defeated, and withdrew into the Thames. The English fleet having been refitted, put to sea again in February 1653; and on the 18th Blake, at the head of eighty ships, encountered Tromp in the Channel. The Dutch force, according to Clarendon, numbered 100 ships of war, but according to the official reports of the Dutch, only seventy. The battle was severe, and continued through three days, the Dutch, however, retreating, and taking refuge in the shallow waters off the French coast. In this action Blake was severely wounded. The three English admirals put to sea again in May; and on the 3rd and 4th of June another battle was fought near the North Foreland. On the first day Dean and Monk were repulsed by Tromp; but on the second day the scales were turned by the arrival of Blake, and the Dutch retreated to the Texel.

Ill-health now compelled Blake to retire from the service for a time, and he did not appear again on the seas for about eighteen months; meanwhile he sat as a member of the Little Parliament (Barebones's). In November 1654 he was selected by Cromwell to conduct a fleet to the Mediterranean to exact compensation from the duke of Tuscany, the knights of Malta, and the piratical states of North Africa, for wrongs done to English merchants. This mission he executed with his accustomed spirit and with complete success. Tunis alone dared to resist his demands, and Tunis paid the penalty of the destruction of its two fortresses by English guns. In the winter of 1655-1656, war being declared against Spain, Blake was sent to cruise off Cadiz and the neighbouring coasts, to intercept the Spanish shipping. One of his captains captured a part of the Plate fleet in September 1656. In April 1657 Blake, then in very ill health, suffering from dropsy and scurvy, and anxious to have assistance in his arduous duties, heard that the Plate fleet lay at anchor in the bay of Santa Cruz, in the island of Tenerife. The position was a very strong one, defended by a castle and several forts with guns. Under the shelter of these lay a fleet of sixteen ships drawn up in crescent order. Captain Stayner was ordered to enter the bay and fall on the fleet. This he did. Blake followed him. Broad-sides were poured into the castle and the forts at the same time; and soon nothing was left but ruined walls and charred fragments of burnt ships. The wind was blowing hard into the bay; but suddenly, and fortunately for the heroic Blake, it shifted, and carried him safely out to sea. "The whole action," says Clarendon, "was so incredible that all men who knew the place wondered that any sober man, with what courage soever endowed, would ever have undertaken it; and they could hardly persuade themselves to believe what they had done; while the Spaniards comforted themselves with the belief that they were devils and not men who had destroyed them in such a manner." The English lost one ship and 200 men killed and wounded. The thanks of parliament were voted to officers and men; and a very costly jewel (diamond ring) was presented to Blake, "as a testimony," says Cromwell in his letter of 10th June, "of our own and the parliament's good acceptance of your carriage in this action." "This was the last action of the brave Blake."

After again cruising for a time off Cadiz, his health failing more and more, he was compelled to make homewards before the summer was over. He died at sea, but within sight of Plymouth, on the 17th of August 1657. His body was brought to London and embalmed, and after lying in state at Greenwich House was interred with great pomp and solemnity in Westminster

Abbey. In 1661 Charles II. ordered the exhumation of Blake's body, with those of the mother and daughter of Cromwell and several others. They were cast out of the abbey, and were reburied in the churchyard of St Margaret's. "But that regard," says Johnson, "which was denied his body has been paid to his better remains, his name and his memory. Nor has any writer dared to deny him the praise of intrepidity, honesty, contempt of wealth, and love of his country." Clarendon bears the following testimony to his excellence as a commander:—"He was the first man that declined the old track, and made it apparent that the science might be attained in less time than was imagined. He was the first man that brought ships to contemn castles on the shore, which had ever been thought very formidable, but were discovered by him to make a noise only, and to fright those who could be rarely hurt by them."

A life of Blake is included in the work entitled *Lives, English and Foreign*. Dr Johnson wrote a short life of him, and in 1852 appeared Hepworth Dixon's fuller narrative, *Robert Blake, Admiral and General at Sea*. Much new matter for the biography of Blake will be found in the *Letters and Papers Relating to the First Dutch War*, edited by S. R. Gardiner for the Navy Records Society (1898-1899.)

BLAKE, WILLIAM (1757-1827), English poet and painter, was born in London, on the 28th of November 1757. His father, James Blake, kept a hosier's shop in Broad Street, Golden Square; and from the scanty education which the young artist received, it may be judged that the circumstances of the family were not very prosperous. For the facts of William Blake's early life the world is indebted to a little book, called *A Father's Memoirs on a Child*, written by Dr Malkin in 1806. Here we learn that young Blake quickly developed a taste for design, which his father appears to have had sufficient intelligence to recognize and assist by every means in his power. At the age of ten the boy was sent to a drawing school kept by Henry Pars in the Strand, and at the same time he was already cultivating his own taste by constant attendance at the different art sale rooms, where he was known as the "little connoisseur." Here he began to collect prints after Michelangelo, and Raphael, Dürer and Heemskerck, while at the school in the Strand he had the opportunity of drawing from the antique. After four years of this preliminary instruction Blake entered upon another branch of art study. In 1777 he was apprenticed to James Basire, an engraver of repute, and with him he remained seven years. His apprenticeship had an important bearing on Blake's artistic education, and marks the department of art in which he was made technically proficient. In 1778, at the end of his apprenticeship, he proceeded to the school of the Royal Academy, where he continued his early study from the antique, and had for the first time an opportunity of drawing from the living model.

This is in brief all that is known of Blake's artistic education. That he ever, at the academy or elsewhere, systematically studied painting we do not know; but that he had already begun the practice of water colour for himself is ascertained. So far, however, the course of his training in art schools, and under Basire, was calculated to render him proficient only as a draughtsman and an engraver. He had learned how to draw, and he had mastered besides the practical difficulties of engraving, and with these qualifications he entered upon his career. In 1780 he exhibited a picture in the Royal Academy Exhibition, conjectured to have been executed in water colours, and he continued to contribute to the annual exhibitions up to the year 1808. In 1782 he married Catherine Boucher, the daughter of a market-gardener at Battersea, with whom he lived always on affectionate terms, and the young couple after their marriage established themselves in Green Street, Leicester Fields. Blake had already become acquainted with some of the rising artists of his time, amongst them Stothard, Flaxman and Fuseli, and he now began to see something of literary society. At the house of the Rev. Henry Mathew, in Rathbone Place, he used to recite and sometimes to sing poems of his own composition, and it was through the influence of this gentleman, combined with that of Flaxman, that Blake's first volume of poetry was printed and published in 1783. From this time forward the artist came before the world in a double capacity. By education as well as native

talent, he was pledged to the life of a painter, and these *Poetical Sketches*, though they are often no more than the utterances of a boy, are no less decisive in marking Blake as a future poet.

For a while the two gifts are exhibited in association. To the close of his life Blake continued to print and publish, after a manner of his own, the inventions of his verse illustrated by original designs, but there is a certain period in his career when the union of the two gifts is peculiarly close, and when their service to one another is unquestionable. In 1784 Blake, moving from Green Street, set up in company with a fellow-pupil, Parker, as print-seller and engraver next to his father's house in Broad Street, Golden Square, but in 1787 this partnership was severed, and he established an independent business in Poland Street. It was from this house, and in 1787, that the *Songs of Innocence* were published, a work that must always be remarkable for beauty both of verse and of design, as well as for the singular method by which the two were combined and expressed by the artist. Blake became in fact his own printer and publisher. He engraved upon copper, by a process devised by himself, both the text of his poems and the surrounding decorative design, and to the pages printed from the copper plates an appropriate colouring was afterwards added by hand. The poetic genius already discernible in the first volume of *Poetical Sketches* is here more decisively expressed, and some of the songs in this volume deserve to take rank with the best things of their kind in our literature. In an age of enfeebled poetic style, when Wordsworth, with more weighty apparatus, had as yet scarcely begun his reform of English versification, Blake, unaided by any contemporary influence, produced a work of fresh and living beauty; and if the *Songs of Innocence* established Blake's claim to the title of poet, the setting in which they were given to the world proved that he was also something more. For the full development of his artistic powers we have to wait till a later date, but here at least he exhibits a just and original understanding of the sources of decorative beauty. Each page of these poems is a study of design, full of invention, and often wrought with the utmost delicacy of workmanship. The artist retained to the end this feeling for decorative effect; but as time went on, he considerably enlarged the imaginative scope of his work, and decoration then became the condition rather than the aim of his labour.

Notwithstanding the distinct and precious qualities of this volume, it attracted but slight attention, a fact perhaps not very wonderful, when the system of publication is taken into account. Blake, however, proceeded with other work of the same kind. The same year he published *The Book of Thel*, more decidedly mystic in its poetry, but scarcely less beautiful as a piece of illumination; *The Marriage of Heaven and Hell* followed in 1790; and in 1793 there are added *The Gates of Paradise*, *The Vision of the Daughters of Albion*, and some other "Prophetic Books." It becomes abundantly clear on reaching this point in his career that Blake's utterances cannot be judged by ordinary rules. The *Songs of Experience*, put forth in 1794 as a companion to the earlier *Songs of Innocence*, are for the most part intelligible and coherent, but in these intervening works of prophecy, as they were called by the author, we get the first public expression of that phase of his character and of his genius upon which a charge of insanity has been founded. The question whether Blake was or was not mad seems likely to remain in dispute, but there can be no doubt whatever that he was at different periods of his life under the influence of illusions for which there are no outward facts to account, and that much of what he wrote is so far wanting in the quality of sanity as to be without a logical coherence. On the other hand, it is equally clear that no madness imputed to Blake could equal that which would be involved in the rejection of his work on this ground. The greatness of Blake's mind is even better established than its frailty, and in considering the work that he has left we must remember that it is by the sublimity of his genius, and not by any mental defect, that he is most clearly distinguished from his fellows. With the publication of the *Songs of Experience* Blake's poetic career,

so far at least as ordinary readers are concerned, may be said to close. A writer of prophecy he continued for many years, but the works by which he is best known in poetry are those earlier and simpler efforts, supplemented by a few pieces taken from various sources, some of which were of later production. But although Blake the poet ceases in a general sense at this date, Blake the artist is only just entering upon his career. In the *Songs of Innocence* and *Experience*, and even in some of the earlier *Books of Prophecy*, the two gifts worked together in perfect balance and harmony; but at this point the supremacy of the artistic faculty asserts itself, and for the remainder of his life Blake was pre-eminently a designer and engraver. The labour of poetical composition continues, but the product passes beyond the range of general comprehension; while, with apparent inconsistency, the work of the artist gains steadily in strength and coherence, and never to the last loses its hold upon the understanding. It may almost be said without exaggeration that his earliest poetic work, *The Songs of Innocence*, and nearly his latest effort in design, the illustrations to *The Book of Job*, take rank among the sanest and most admirable products of his genius. Nor is the fact, astonishing enough at first sight, quite beyond a possible explanation. As Blake advanced in his poetic career, he was gradually hindered and finally overpowered by a tendency that was most serviceable to him in design. His inclination to substitute a symbol for a conception, to make an image do duty for an idea, became an insuperable obstacle to literary success. He endeavoured constantly to treat the intellectual material of verse as if it could be moulded into sensuous form, with the inevitable result that as the ideas to be expressed advanced in complexity and depth of meaning, his poetic gifts became gradually more inadequate to the task of interpretation. The earlier poems dealing with simpler themes, and put forward at a time when the bent of the artist's mind was not strictly determined, do not suffer from this difficulty; the symbolism then only enriches an idea of no intellectual intricacy; but when Blake began to concern himself with profounder problems the want of a more logical understanding of language made itself strikingly apparent. If his ways of thought and modes of workmanship had not been developed with an intensity almost morbid, he would probably have been able to distinguish and keep separate the double functions of art and literature. As it is, however, he remains as an extreme illustration of the ascendancy of the artistic faculty. For this tendency to translate ideas into image, and to find for every thought, however simple or sublime, a precise and sensuous form, is of the essence of pure artistic invention. If this be accepted as the dominant bent of Blake's genius, it is not so wonderful that his work in art should have strengthened in proportion as his poetic powers waned; but whether the explanation satisfies all the requirements of the case or not, the fact remains, and cannot be overlooked by any student of Blake's career.

In 1796 Blake was actively employed in the work of illustration. Edwards, a bookseller of New Bond Street, projected a new edition of Young's *Night Thoughts*, and Blake was chosen to illustrate the work. It was to have been issued in parts, but for some reason not very clear the enterprise failed, and only a first part, including forty-three designs, was given to the world. These designs were engraved by Blake himself, and they are interesting not only for their own merit but for the peculiar system by which the illustration has been associated with the text. It was afterwards discovered that the artist had executed original designs in water-colour for the whole series, and these drawings, 537 in number, form one of the most interesting records of Blake's genius. Gilchrist, the painter's biographer, in commenting upon the engraved plates, regrets the absence of colour, "the use of which Blake so well understood, to relieve his simple design and give it significance," and an examination of the original water-colour drawings fully supports the justice of his criticism. Soon after the publication of this work Blake was introduced by Flaxman to the poet Hayley, and in the year 1801 he accepted the suggestion of the latter, that he should take up his residence at Felpham in Sussex. The mild and

amable poet had planned to write a life of Cowper, and for the illustration of this and other works he sought Blake's help and companionship. The residence at Felpham continued for three years, partly pleasant and partly irksome to Blake, but apparently not very profitable to the progress of his art. One of the annoyances of his stay was a malicious prosecution for treason set on foot by a common soldier whom Blake had summarily ejected from his garden; but a more serious drawback was the increasing irritation which the painter seems to have experienced from association with Hayley. In 1804 Blake returned to London, to take up his residence in South Moulton Street, and as the fruit of his residence in Felpham, he published, in the manner already described, the prophetic books called the *Jerusalem*, *The Emanation of the Giant Albion*, and *Milton*. The first of these is a very notable performance in regard to artistic invention. Many of the designs stand out from the text in complete independence, and are now and then of the very finest quality.

In the years 1804-1805 Blake executed a series of designs in illustration of Robert Blair's *The Grave*, of much beauty and grandeur, though showing stronger traces of imitation of Italian art than any earlier production. These designs were purchased from the artist by an adventurous and unscrupulous publisher, Cromek, for the paltry sum of £21, and afterwards published in a series of engravings by Schiavonetti. Despite the ill treatment Blake received in the matter, and the other evils, including a quarrel with his friend Stothard as to priority of invention of a design illustrating the Canterbury Pilgrims, which his association with Cromek involved, the book gained for him a larger amount of popularity than he at any other time secured. Stothard's picture of the Canterbury Pilgrims was exhibited in 1807, and in 1809 Blake, in emulation of his rival's success, having himself painted in water-colour a picture of the same subject, opened an exhibition, and drew up a *Descriptive Catalogue*, curious and interesting, and containing a very valuable criticism of Chaucer.

The remainder of the artist's life is not outwardly eventful. In 1813 he formed, through the introduction of George Cumberland of Bristol, a valuable friendship with John Linnell and other rising water-colour painters. Amongst the group Blake seems to have found special sympathy in the society of John Varley, who, himself addicted to astrology, encouraged Blake to cultivate his gift of inspired vision; and it is probably to this influence that we are indebted for several curious drawings made from visions, especially the celebrated "ghost of a flea" and the very humorous portrait of the builder of the Pyramids. In 1821 Blake removed to Fountain Court, in the Strand, where he died on the 12th of August 1827. The chief work of these last years was the splendid series of engraved designs in illustration of the book of Job. Here we find the highest imaginative qualities of Blake's art united to the technical means of expression which he best understood. Both the invention and the engraving are in all ways remarkable, and the series may fairly be cited in support of a very high estimate of his genius. None of his works is without the trace of that peculiar artistic instinct and power which seizes the pictorial element of ideas, simple or sublime, and translates them into the appropriate language of sense; but here the double faculty finds the happiest exercise. The grandeur of the theme is duly reflected in the simple and sublime images of the artist's design, and in the presence of these plates we are made to feel the power of the artist over the expressive resources of human form, as well as his sympathy with the imaginative significance of his subject.

A life of Blake, with selections from his works, by Alexander Gilchrist, was published in 1863 (new edition by W. G. Robertson, 1906); in 1868 A. C. Swinburne published a critical essay on his genius, remarkable for a full examination of the Prophetic Books, and in 1874 William Michael Rossetti published a memoir prefixed to an edition of the poems. In 1893 appeared *The Works of William Blake*, edited by E. J. Ellis and W. B. Yeats. But for a long time all the editors paid too little attention to a correct following of Blake's own MSS. The text of the poems was finally edited with exemplary care and thoroughness by John Sampson in his edition of the *Poetical Works* (1905), which has rescued Blake from the "improvements" of previous editors. See also *The Letters of*

William Blake, together with a Life by Frederick Tatham; edited by A. G. B. Russell (1906); and Basil de Selincourt, *William Blake* (1909). (J. C. C.)

BLAKELOCK, RALPH ALBERT (1847-), American painter, was born in New York, on the 15th of October, 1847. He graduated at the College of the City of New York in 1867. In art he was self-taught and markedly original. Until ill-health necessitated the abandonment of his profession, he was a most prolific worker, his subjects including pictures of North American Indian life, and landscapes—notably such canvases as "The Indian Fisherman"; "Ta-wo-koka: or Circle Dance"; "Silvery Moonlight"; "A Waterfall by Moonlight"; "Solitude"; and "Moonlight on Long Island Sound."

BLAKENEY, WILLIAM BLAKENEY, BARON (1672-1761), British soldier, was born at Mount Blakeney in Limerick in 1672. Destined by his father for politics, he soon showed a decided preference for a military career, and at the age of eighteen headed the tenants in defending the Blakeney estate against the Rapparees. As a volunteer he went to the war in Flanders, and at the siege of Venlo in 1702 won his commission. He served as a subaltern throughout Marlborough's campaigns, and is said to have been the first to drill troops by signal of drum or colour. For many years after the peace of Utrecht he served unnoticed, and was sixty-five years of age before he became a colonel. This neglect, which was said to be due to the hostility of Lord Verney, ceased when the duke of Richmond was appointed colonel of Blakeney's regiment, and thenceforward his advance was rapid. Brigadier-general in the Cartagena expedition of 1741, and major-general a little later, he distinguished himself by his gallant and successful defence of Stirling Castle against the Highlanders in 1745. Two years later George II. made him lieutenant-general and lieutenant-governor of Minorca. The governor of that island never set foot in it, and Blakeney was left in command for ten years.

In 1756 the Seven Years' War was precluded by a swift descent of the French on Minorca. Fifteen thousand troops under marshal the duc de Richelieu, escorted by a strong squadron under the marquis de la Gallissonnière, landed on the island on the 18th of April, and at once began the siege of Fort St Philip, where Blakeney commanded at most some 5000 soldiers and workmen. The defence, in spite of crumbling walls and rotted gun platforms, had already lasted a month when a British fleet under vice-admiral the Hon. John Byng appeared. La Gallissonnière and Byng fought, on the 20th of May, an indecisive battle, after which the relieving squadron sailed away and Blakeney was left to his fate. A second expedition subsequently appeared off Minorca, but it was then too late, for after a heroic resistance of seventy-one days the old general had been compelled to surrender the fort to Richelieu (April 18-June 28, 1756). Only the ruined fortifications were the prize of the victors. Blakeney and his little garrison were transported to Gibraltar with absolute liberty to serve again. Byng was tried and executed; Blakeney, on his return to England, found himself the hero of the nation. Rewards came freely to the veteran. He was made colonel of the Enniskillen regiment of infantry, knight of the Bath, and Baron Blakeney of Mount Blakeney in the Irish peerage. A little later Van Most's statue of him was erected in Dublin, and his popularity continued unabated for the short remainder of his life. He died on the 20th of September 1761, and was buried in Westminster Abbey.

See *Memoirs of General William Blakeney* (1757).

BLAKESLEY, JOSEPH WILLIAMS (1808-1885), English divine, was born in London on the 6th of March 1808, and was educated at St Paul's school, London, and at Corpus Christi and Trinity Colleges, Cambridge. In 1831 he was elected a fellow, and in 1839 a tutor of Trinity. In 1833 he took holy orders, and from 1845 to 1872 held the college living of Ware, Hertfordshire. Over the signature "Hertfordshire Incumbent" he contributed a large number of letters to *The Times* on the leading social and political subjects of the day, and he also wrote many reviews of books for that paper. In 1863 he was made a canon of Canterbury, and in 1872 dean of Lincoln. Dean Blakesley was the

author of the first English *Life of Aristotle* (1839), an edition of Herodotus (1852-1854) in the *Bibliotheca Classica*, and *Four Months in Algeria* (1850). He died on the 18th of April 1885.

BLAMIRE, SUSANNA (1747-1794), English poet, daughter of a Cumberland yeoman, was born at Cardew Hall, near Dalston, in January 1747. Her mother died while she was a child, and she was brought up by her aunt, a Mrs Simpson of Thackwood, who sent her niece to the village school at Raughton Head. Susanna Blamire's earliest poem is "Written in a Churchyard, on seeing a number of cattle grazing," in imitation of Gray. She lived an uneventful life among the farmers of the neighbourhood, and her gaiety and good-humour made her a favourite in rustic society. In 1767 her elder sister Sarah married Colonel Graham of Gartmore. "An Epistle to her friends at Gartmore" gives a playful description of the monotonous simplicity of her life. To her Perthshire visits her songs in the Scottish vernacular are no doubt partly due. Her chief friend was Catharine Gilpin of Scaley Castle. The two ladies spent the winters together in Carlisle, and wrote poems in common. Susanna Blamire died in Carlisle on the 5th of April 1794. The poems which were not collected during her lifetime, were first published in 1842 by Henry Lonsdale as *The Poetical Works of Miss Susanna Blamire, "the Muse of Cumberland,"* with a memoir by Mr Patrick Maxwell. Some of her songs rank among the very best of north-country lyrics. "And ye shall walk in silk attire" and "What ails this heart o' mine," are well known, and were included in Johnson's *Scott's Musical Museum*.

BLANC, (JEAN JOSEPH CHARLES) LOUIS (1811-1882), French politician and historian, was born on the 29th of October 1811 at Madrid, where his father held the post of inspector-general of finance under Joseph Bonaparte. Failing to receive aid from Pozzo di Borgo, his mother's uncle, Louis Blanc studied law in Paris, living in poverty, and became a contributor to various journals. In the *Revue des progrès*, which he founded, he published in 1839 his study on *L'Organisation du travail*. The principles laid down in this famous essay form the key to Louis Blanc's whole political career. He attributes all the evils that afflict society to the pressure of competition, whereby the weaker are driven to the wall. He demanded the equalization of wages, and the merging of personal interests in the common good—"à chacun selon ses besoins, de chacun selon ses facultés." This was to be effected by the establishment of "social workshops," a sort of combined co-operative society and trade-union, where the workmen in each trade were to unite their efforts for their common benefit. In 1841 he published his *Histoire de dix ans 1830-1840*, an attack upon the monarchy of July. It ran through four editions in four years.

In 1847 he published the two first volumes of his *Histoire de la Révolution Française*. Its publication was interrupted by the revolution of 1848, when Louis Blanc became a member of the provisional government. It was on his motion that, on the 25th of February, the government undertook "to guarantee the existence of the workmen by work"; and though his demand for the establishment of a ministry of labour was refused—as beyond the competence of a provisional government—he was appointed to preside over the government labour commission (*Commission du Gouvernement pour les travailleurs*) established at the Luxembourg to inquire into and report on the labour question. On the 10th of May he renewed, in the National Assembly, his proposal for a ministry of labour, but the temper of the majority was hostile to socialism, and the proposal was again rejected. His responsibility for the disastrous experiment of the national workshops he himself denied in his *Appel aux honnêtes gens* (Paris, 1849), written in London after his flight; but by the insurgent mob of the 15th of May and by the victorious Moderates alike he was regarded as responsible. Between the *sans-culottes*, who tried to force him to place himself at their head, and the national guards, who maltreated him, he was nearly done to death. Rescued with difficulty, he escaped with a false passport to Belgium, and thence to London; in his absence he was condemned by the special tribunal established at Bourges, in connection with the *communiards*, to deportation. Against trial and sentence he

alike protested, developing his protest in a series of articles in the *Nouveau Monde*, a review published in Paris under his direction. These he afterwards collected and published as *Pages de l'histoire de la révolution de 1848* (Brussels, 1850).

During his stay in England he made use of the unique collection of materials for the revolutionary period preserved at the British Museum to complete his *Histoire de la Révolution Française* 12 vols. (1847-1862). In 1858 he published a reply to Lord Normanby's *A Year of Revolution in Paris* (1858), which he developed later into his *Histoire de la révolution de 1848* (2 vols., 1870-1880). As far back as 1839 Louis Blanc had vehemently opposed the idea of a Napoleonic restoration, predicting that it would be "despotism without glory," "the Empire without the Emperor." He therefore remained in exile till the fall of the Second Empire in September 1870, after which he returned to Paris and served as a private in the national guard. On the 8th of February 1871 he was elected a member of the National Assembly, in which he maintained that the republic was "the necessary form of national sovereignty," and voted for the continuation of the war; yet, though a member of the extreme Left, he was too clear-minded to sympathize with the Commune, and exerted his influence in vain on the side of moderation. In 1878 he advocated the abolition of the presidency and the senate. In January 1879 he introduced into the chamber a proposal for the amnesty of the Communists, which was carried. This was his last important act. His declining years were darkened by ill-health and by the death, in 1876, of his wife (Christina Groh), an Englishwoman whom he had married in 1865. He died at Cannes on the 6th of December 1882, and on the 12th of December received a state funeral in the cemetery of Père-Lachaise.

Louis Blanc possessed a picturesque and vivid style, and considerable power of research; but the fervour with which he expressed his convictions, while placing him in the first rank of orators, tended to turn his historical writings into political pamphlets. His political and social ideas have had a great influence on the development of socialism in France. His *Discours politiques* (1847-1881) was published in 1882. His most important works, besides those already mentioned, are *Lettres sur l'Angleterre* (1866-1867), *Dix années de l'histoire de l'Angleterre* (1879-1881), and *Questions d'aujourd'hui et de demain* (1873-1884).

See L. Fiaux, *Louis Blanc* (1883).

BLANC, MONT, the culminating point (15,782 ft.) of the mountain range of the same name, which forms part of the Pennine Alps, and is divided unequally between France, Italy and Switzerland. The actual highest summit is wholly French and is the loftiest peak in the Alps, and in Europe also, if certain peaks in the Caucasus be excluded. At Geneva the mountain was in former days named the Montagne Maudite, but the present name seems to have been always used locally. On the north is the valley of Chamonix, and on the east the head of the valley of Aosta. Among the great glaciers which stream from the peak the most noteworthy are those of Bossons and Tacconnaz (northern slope) and of Brenva and Miage (southern slope). The first ascent was made in 1786 by two Chamonix men, Jacques Balmat and Dr Michel Paccard, and the second in 1787 by Balmat with two local men. Later in 1787 H. B. de Saussure made the third ascent, memorable in many respects, and was followed a week later by Colonel Beaufoy, the first Englishman to gain the top. These ascents were all made from Chamonix, which is still the usual starting point, though routes have been forced up the peak from nearly every side, those on the Italian side being much steeper than that from Chamonix. The ascent from Chamonix is now frequently made in summer (rarely in winter also), but, owing to the great height of the mountain, the view is unsatisfactory, though very extensive (Lyons is visible). There is an inn at the Grands Mulets (9000 ft.). In 1890 M. Vallot built an observatory and shelter hut (14,312 ft.) on the Bosses du Dromadaire (north-west ridge of the mountain), and in 1893 T. J. C. Janssen constructed an observatory just below the very summit.

See C. Durier, *Le Mont Blanc* (4th ed., Paris, 1897); C. E. Mathews, *The Annals of Mont Blanc* (London 1898); P. Güsefeldt, *Der*

Montblanc (Berlin, 1894, also a French translation, Geneva, 1899); L. Kurz, *Climbers' Guide to the Châin of Mont Blanc*, section vi. (London, 1892); L. Kurz and X. Imfeld, *Carte de la chaîne du Mont Blanc* (1896, new edition 1905). (W. A. B. C.)

BLANCHARD, SAMUEL LAMAN (1804-1845), British author and journalist, the son of a painter and glazier, was born at Great Yarmouth on the 15th of May 1804. He was educated at St Olave's school, Southwark, and then became clerk to a proctor in Doctors' Commons. At an early age he developed literary tastes, contributing dramatic sketches to a paper called *Drama*. For a short time he was a member of a travelling dramatic company, but subsequently became a proof-reader in London, and wrote for the *Monthly Magazine*. In 1827 he was made secretary of the Zoological Society, a post which he held for three years. In 1828 he published *Lyric Offerings*, dedicated to Charles Lamb. He had a very varied journalistic experience, editing in succession the *Monthly Magazine*, the *True Sun*, the *Constitutional*, the *Court Journal*, the *Courier*, and *George Cruikshank's Omnibus*; and from 1841 till his death he was connected with the *Examiner*. In 1846 Bulwer-Lytton collected a number of his prose-essays under the title *Sketches of Life*, to which a memoir of the author was prefixed. His verse was collected in 1876 by Blanchard Jerrold. Over-work broke down his strength, and, unnerved by the death of his wife, he died by his own hand on the 15th of February 1845.

His eldest son, SIDNEY LAMAN BLANCHARD, who was the author of *Yesterday and To-day in India*, died in 1883.

BLANCHE, JACQUES ÉMILE (1861-), French painter, was born in Paris. He enjoyed an excellent cosmopolitan education, and was brought up at Passy in a house once belonging to the princesse de Lamballe, which still retained the atmosphere of 18th-century elegance and refinement and influenced his taste and work. Although he received some instruction in painting from Gervex, he may be regarded as self-taught. He acquired a great reputation as a portrait painter; his art is derived from French and English sources, refined, sometimes super-elegant, but full of character. Among his chief works are his portraits of his father, of Pierre Louÿs, the Thaulow family, Aubrey Beardsley and Yvette Guilbert.

BLANCHE OF CASTILE (1188-1252), wife of Louis VIII. of France, third daughter of Alphonso VIII., king of Castile, and of Eleanor of England, daughter of Henry II., was born at Valencia. In consequence of a treaty between Philip Augustus and John of England, she was betrothed to the former's son, Louis, and was brought to France, in the spring of 1200, by John's mother Eleanor. On the 22nd of May 1200 the treaty was finally signed, John ceding with his niece the fiefs of Issoudun and Gracay, together with those that André de Chavigny, lord of Châteauroux, held in Berry, of the English crown. The marriage was celebrated the next day, at Portmort on the right bank of the Seine, in John's domains, as those of Philip lay under an interdict.

Blanche first displayed her great qualities in 1216, when Louis, who on the death of John claimed the English crown in her right, invaded England, only to find a united nation against him. Philip Augustus refused to help his son, and Blanche was his sole support. The queen established herself at Calais and organized two fleets, one of which was commanded by Eustace the Monk, and an army under Robert of Courtenay; but all her resolution and energy were in vain. Although it would seem that her masterful temper exercised a sensible influence upon her husband's gentler character, her rôle during his reign (1223-1226) is not well known. Upon his death he left Blanche regent and guardian of his children. Of her twelve or thirteen children, six had died, and Louis, the heir—afterwards the sainted Louis IX.,—was but twelve years old. The situation was critical, for the hard-won domains of the house of Capet seemed likely to fall to pieces during a minority. Blanche had to bear the whole burden of affairs alone, to break up a league of the barons (1226), and to repel the attack of the king of England (1230). But her energy and firmness overcame all dangers. There was an end to the calumnies circulated against her, based on the poetical homage rendered her by Theobald IV., count of Champagne, and the

prolonged stay in Paris of the papal legate, Romano Bonaventura, cardinal of Sant' Angelo. The nobles were awed by her warlike preparations or won over by adroit diplomacy, and their league was broken up. St Louis owed his life to his mother, but he himself always remained somewhat under the spell of her imperious personality. After he came of age (1236) her influence upon him may still be traced. In 1248 she again became regent, during Louis IX.'s absence on the crusade, a project which she had strongly opposed. In the disasters which followed she maintained peace, while draining the land of men and money to aid her son in the East. At last her strength failed her. She fell ill at Melun in November 1252, and was taken to Paris, but lived only a few days. She was buried at Maubuisson.

Besides the works of Joinville and William of Nangis, see Élie Berger, "Histoire de Blanche de Castille, reine de France." in *Bibliothèque des écoles françaises d'Athènes et de Rome*, vol. lxx. (Paris, 1895); Le Nain de Tillemont, "Vie de Saint Louis," ed by J. de Gaulle for the *Société de l'histoire de France* (6 vols., 1847-1851); and Paulin Paris, "Nouvelles recherches sur les meurs de la reine Blanche et de Thibaud," in *Cabinet historique* (1858).

BLANCH FEE, or **BLANCH HOLDING** (from Fr. *blanc*, white), an ancient tenure in Scottish land law, the duty payable being in silver or white money in contradistinction to gold. The phrase was afterwards applied to any holding of which the quit-rent was merely nominal, such as a penny, a peppercorn, &c.

BLANDFORD, or **BLANDFORD FORUM**, a market town, and municipal borough in the northern parliamentary division of Dorsetshire, England, on the Stour, 19 m. N.W. of Bournemouth by the Somerset & Dorset railway. Pop. (1901) 3649. The town is ancient, but was almost wholly destroyed by fire in the 18th century. The church of St Peter and St Paul, a classical building, was built in 1732. There are a grammar-school (founded in 1521 at Milton Abbas, transferred to Blandford in 1775), a Blue Coat school (1729), and other educational charities. Remnants of a mansion of the 14th century, Damory Court, are seen in a farmhouse, and an adjoining Perpendicular chapel is used as a barn. There are numerous early earthworks on the chalk hills in the neighbourhood. The fine modern mansion of Bryanston, in the park adjoining the town, is the seat of Lord Portman. The municipal borough is under a mayor, 4 aldermen, and 12 councillors. Area, 145 acres.

BLANDRATA, or **BLANDRATA, GIORGIO** (c. 1515-1588), Italian physician and polemic, who came of the De Blandrate family, powerful from the early part of the 13th century, was born at Saluzzo, the youngest son of Bernardino Blandrata. He graduated in arts and medicine at Montpellier in 1533, and specialized in the functional and nervous disorders of women. In 1544 he made his first acquaintance with Transylvania; in 1553 he was with Alciati in the Grisons; in 1557 he spent a year at Geneva, in constant intercourse with Calvin, who distrusted him. He attended the English wife (Jane Stafford) of Count Celso Massimiliano Martinengo, preacher of the Italian church at Geneva, and fostered anti-trinitarian opinions in that church. In 1558 he found it expedient to remove to Poland, where he became a leader of the heretical party at the synods of Pinczów (1558) and Kasionz (1560 and 1562). His point was the suppression of extremes of opinion, on the basis of a confession literally drawn from Scripture. He obtained the position of court physician to the queen dowager, the Milanese Bona Sforza. She had been instrumental in the burning (1539) of Catharine Weygel, at the age of eighty, for anti-trinitarian opinions; but the writings of Ochino had altered her views, which were now anti-Catholic. In 1563 Blandrata transferred his services to the Transylvanian court, where the daughters of his patroness were married to ruling princes. He revisited Poland (1576) in the train of Stephen Báthory, whose tolerance permitted the propagation of heresies; and when (1579) Christopher Báthory introduced the Jesuits into Transylvania, Blandrata found means of conciliating them. Throughout his career he was accompanied by his two brothers, Ludovico and Alphonso, the former being canon of Saluzzo. In Transylvania, Blandrata co-operated with Francis Dávid (c. 1579), the anti-trinitarian bishop, but in 1578 two circumstances broke the

connexion. Blandrata was charged with "Italian vice"; Dávid renounced the worship of Christ. To influence Dávid, Blandrata sent for Faustus Socinus from Basel. Socinus was Dávid's guest, but the discussion between them led to no result. At the instance of Blandrata, Dávid was tried and condemned to prison at Déva (in which he died) on the charge of innovation. Having amassed a fortune, Blandrata returned to the communion of Rome. His end is obscure. According to the Jesuit, Jacob Wujek, he was strangled by a nephew (Giorgio, son of Alphonso) in May 1588. He published a few polemical writings, some in conjunction with Dávid.

See Malacarne, *Commentario delle Opere e delle Vicende di G. Blandrata* (Padova, 1814); Wallace, *Anti-trinitarian Biography*, vol. ii. (1850). (A. G. O.)

BLANE, SIR GILBERT (1749-1834), Scottish physician, was born at Blanefield, Ayrshire, on the 29th of August 1749. He was educated at Edinburgh university, and shortly after his removal to London became private physician to Lord Rodney, whom he accompanied to the West Indies in 1770. He did much to improve the health of the fleet by attention to the diet of the sailors and by enforcing due sanitary precautions, and it was largely through him that in 1795 the use of lime-juice was made obligatory throughout the navy as a preventive of scurvy. Enjoying a number of court and hospital appointments he built up a good practice for himself in London, and the government constantly consulted him on questions of public hygiene. He was made a baronet in 1812 in reward for the services he rendered in connexion with the return of the Walcheren expedition. He died in London on the 26th of June 1834. Among his works were *Observations on the Diseases of Seamen* (1795) and *Elements of Medical Logic* (1819).

BLANFORD, WILLIAM THOMAS (1832-1905), English geologist and naturalist, was born in London on the 7th of October 1832. He was educated in private schools in Brighton and Paris, and with a view to the adoption of a mercantile career spent two years in a business house at Civita Vecchia. On returning to England in 1851 he was induced to enter the newly established Royal School of Mines, which his younger brother Henry F. Blanford (1834-1893), afterwards head of the Indian Meteorological Department, had already joined; he then spent a year in the mining school at Freiberg, and towards the close of 1854 both he and his brother obtained posts on the Geological Survey of India. In that service he remained for twenty-seven years, retiring in 1882. He was engaged in various parts of India, in the Raniganj coalfield, in Bombay, and in the coalfield near Talchir, where boulders considered to have been ice-borne were found in the Talchir strata—a remarkable discovery confirmed by subsequent observations of other geologists in equivalent strata elsewhere. His attention was given not only to geology but to zoology, and especially to the land-mollusca and to the vertebrates. In 1866 he was attached to the Abyssinian expedition, accompanying the army to Mágdala and back; and in 1871-1872 he was appointed a member of the Persian Boundary Commission. The best use was made of the exceptional opportunities of studying the natural history of those countries. For his many contributions to geological science Dr Blanford was in 1883 awarded the Wollaston medal by the Geological Society of London; and for his labours on the zoology and geology of British India he received in 1901 a royal medal from the Royal Society. He had been elected F.R.S. in 1874, and was chosen president of the Geological Society in 1888. He was created C.I.E. in 1904. He died in London on the 23rd of June 1905. His principal publications were: *Observations on the Geology and Zoology of Abyssinia* (1870), and *Manual of the Geology of India*, with H. B. Medlicott (1879).

Biography, with bibliography and portrait, in *Geological Magazine*, January 1905.

BLANK (from the Fr. *blanc*, white), a word used in various senses based on that of "left white," i.e. requiring something to be filled in; thus a "blank cheque" is one which requires the amount to be inserted, an insurance policy in blank, where the name of the beneficiary is lacking, "blank verse" (q.v.)

verse without rhyme, "blank cartridge" that contains only powder and no ball or shot. The word is also used, as a substantive, for a ticket in a lottery or sweepstake which does not carry a number or the name of a horse running or for an unstamped metal disc in coining.

BLANKENBERGHE, a seaside watering-place on the North Sea in the province of West Flanders, Belgium, 12 m. N.E. of Ostend, and about 9 m. N.W. of Bruges, with which it is connected by railway. It is more bracing than Ostend, and has a fine parade over a mile in length. During the season, which extends from June to September, it receives a large number of visitors, probably over 60,000 altogether, from Germany as well as from Belgium. There is a small fishing port as well as a considerable fishing-fleet. Two miles north of this place along the dunes is Zeebrugge, the point at which the new ship-canal from Bruges enters the North Sea. Fixed population (1904) 5025.

BLANKENBURG. (1) A town and health resort of Germany, in the duchy of Brunswick, at the N foot of the Harz Mountains, 12 m. by rail S.W. from Halberstadt. Pop. (1901) 10,173. It has been in large part rebuilt since a fire in 1836, and possesses a castle, with various collections, a museum of antiquities, an old town hall and churches. There are pine-needle baths and a hospital for nervous diseases. Gardening is a speciality. In the vicinity is a cliff or ridge of rock called Teufelsmauer (Devil's wall), from which fine views are obtained across the plain and into the deep gorges of the Harz Mountains.

(2) Another **BLANKENBURG**, also a health-resort, is situated in Schwarzburg-Rudolstadt, Thuringia, at the confluence of the rivers Rinne and Schwarza, and at the entrance of the Schwarzatal. Its environs are charming, and to the north of it, on an eminence, rise the fine ruins of the castle of Greifenstein, built by the German king Henry I., and from 1275 to 1583 the seat of a cadet branch of the counts of Schwarzburg.

BLANKETEERS, the nickname given to some 5000 operatives who on the 10th of March 1817 met in St Peter's Field, near Manchester, to march to London, each carrying blankets or rugs. Their object was to see the prince regent and lay their grievances before him. The Habeas Corpus Act was suspended, and the leaders were seized and imprisoned. The bulk of the demonstration yielded at once. The few stragglers who persisted in the march were intercepted by troops, and treated with considerable severity. Eventually the spokesmen had an interview with the ministers, and some reforms were the result.

BLANK VERSE, the unrhymed measure of iambic decasyllable in five beats which is usually adopted in English epic and dramatic poetry. The epithet is due to the absence of the rhyme which the ear expects at the end of successive lines. The decasyllabic line occurs for the first time in a Provençal poem of the 10th century, but in the earliest instances preserved it is already constructed with such regularity as to suggest that it was no new invention. It was certainly being used almost simultaneously in the north of France. Chaucer employed it in his *Complaynte to Pitee* about 1370. In all the literatures of western Europe it became generally used, but always with rhyme. In the beginning of the 16th century, however, certain Italian poets made the experiment of writing decasyllables without rhyme. The tragedy of *Sophonisba* (1515) of G. G. Trissino (1478-1550) was the earliest work completed in this form; it was followed in 1525 by the didactic poem *Le Api* (The Bees), of Giovanni Rucellai (1475-1525), who announced his intention of writing "*Con verso Etrusco dalle rime sciolto*," in consequence of which expression this kind of metre was called *versi sciolti* or blank verse. In a very short time this form was largely adopted in Italian dramatic poetry, and the comedies of Ariosto, the *Aminta* of Tasso and the *Pastor Fido* of Guarini are composed in it. The iambic blank verse of Italy was, however, mainly hendecasyllabic, not decasyllabic, and under French influences the habit of rhyme soon returned.

Before the close of Trissino's life, however, his invention had been introduced into another literature, where it was destined to enjoy a longer and more glorious existence. Towards the

close of the reign of Henry VIII., Henry Howard, earl of Surrey, translated two books of the *Aeneid* into English rhymeless verse, "drawing" them "into a strange metre." Surrey's blank verse is stiff and timid, permitting itself no divergence from the exact iambic movement:—

"Who can express the slaughter of that night,
Or tell the number of the corpses slain,
Or can in tears bewail them worthily?
The ancient famous city falleth down,
That many years did hold such seignory."

Surrey soon found an imitator in Nicholas Grimoald, and in 1562 blank verse was first applied to English dramatic poetry in the *Corbodus* of Sackville and Norton. In 1576, in the *Steel Glass* of Gascoigne, it was first used for satire, and by the year 1585 it had come into almost universal use for theatrical purposes. In Lyly's *The Woman in the Moon* and Peele's *Arraignement of Paris* (both of 1584) we find blank verse struggling with rhymed verse and successfully holding its own. The earliest play written entirely in blank verse is supposed to be *The Misfortunes of Arthur* (1587) of Thomas Hughes. Marlowe now immediately followed, with the magnificent movement of his *Tamburlaine* (1589), which was mocked by satirical critics as "the swelling bombast of bragging blank verse" (Nash) and "the spacious volubility of a drumming decasyllable" (Greene), but which introduced a great new music into English poetry, in such "mighty lines" as

"Still climbing after knowledge infinite,
And always moving as the restless spheres,"

or:—

"See where Christ's blood streams in the firmament."

Except, however, when he is stirred by a particularly vivid emotion, the blank verse of Marlowe continues to be monotonous and uniform. It still depends too exclusively on a counting of syllables. But Shakespeare, after having returned to rhyme in his earliest dramas, particularly in *The Two Gentlemen of Verona*, adopted blank verse conclusively about the time that the career of Marlowe was closing, and he carried it to the greatest perfection in variety, suppleness and fulness. He released it from the excessive bondage that it had hitherto endured; as Robert Bridges has said, "Shakespeare, whose early verse may be described as syllabic, gradually came to write a verse dependent on stress." In comparison with that of his predecessors and successors, the blank verse of Shakespeare is essentially regular, and his prosody marks the admirable mean between the stiffness of his dramatic forerunners and the laxity of those who followed him. Most of Shakespeare's lines conform to the normal type of the decasyllable, and the rest are accounted for by familiar and rational rules of variation. The ease and fluidity of his prosody were abused by his successors, particularly by Beaumont and Fletcher, who employed the soft feminine ending to excess; in Massinger dramatic blank verse came too near to prose, and in Heywood and Shirley it was relaxed to the point of losing all nervous vigour.

The later dramatists gradually abandoned that rigorous difference which should always be preserved between the cadence of verse and prose, and the example of Ford, who endeavoured to revive the old severity of blank verse, was not followed. But just as the form was sinking into dramatic desuetude, it took new life in the direction of epic, and found its noblest proficient in the person of John Milton. The most intricate and therefore the most interesting blank verse which has been written is that of Milton in the great poems of his later life. He reduced the elisions, which had been frequent in the Elizabethan poets, to law; he admitted an extraordinary variety in the number of stresses; he deliberately inverted the rhythm in order to produce particular effects; and he multiplied at will the caesurae or breaks in a line. Such verses as

"Arrayed with reflected purple and gold—
Shoots invisible virtue even to the deep—
Universal reproach, far worse to bear—
Me, me only, just object of his ire"—

are not mistaken in rhythm, nor to be scanned by forcing them to obey the conventional stress. They are instances, and

Paradise Lost is full of such, of Milton's exquisite art in ringing changes upon the metrical type of ten syllables, five stresses and a rising rhythm, so as to make the whole texture of the verse respond to his poetical thought. Writing many years later in *Paradise Regained* and in *Samson Agonistes*, Milton retained his system of blank verse in its general characteristics, but he treated it with increased dryness and with a certain harshness of effect. It is certainly in his biblical drama that blank verse has been pushed to its most artificial and technical perfection, and it is there that Milton's theories are to be studied best; yet it must be confessed that learning excludes beauty in some of the very audacious irregularities which he here permits himself in *Samson Agonistes*. Such lines as

"Made arms ridiculous, useless the forgery—
My griefs not only pain me as a lingering disease—
Drunk with idolatry, drunk with wine—
Justly, yet despair not of his final pardon"—

are constructed with perfect comprehension of metrical law, yet they differ so much from the normal structure of blank verse that they need to be explained, and to imitate them would be perilous. A persistent weakness in the third foot has ever been the snare of English blank verse, and it is this element of monotony and dullness which Milton is ceaselessly endeavouring to obviate by his wonderful inversions, elisions and breaks.

After the Restoration, and after a brief period of experiment with rhymed plays, the dramatists returned to the use of blank verse, and in the hands of Otway, Lee and Dryden, it recovered much of its magnificence. In the 18th century, Thomson and others made use of a very regular and somewhat monotonous form of blank verse for descriptive and didactic poems, of which the *Night Thoughts* of Young is, from a metrical point of view, the most interesting. With these poets the form is little open to licence, while inversions and breaks are avoided as much as possible. Since the 18th century, blank verse has been subjected to constant revision in the hands of Wordsworth, Coleridge, Shelley, Keats, Tennyson, the Brownings and Swinburne, but no radical changes, of a nature unknown to Shakespeare and Milton, have been introduced into it.

See J. A. Symonds, *Blank Verse* (1895); Walter Thomas, *Le Décasyllabe romain et sa fortune en Europe* (1904); Robert Bridges, *Milton's Prosody* (1894); Ed. Guest, *A History of English Rhythms* (1882); J. Motheré, *Les Théories du vers héroïque anglais* (1886); J. Schipper, *Englische Metrik* (1881-1888). (E. G.)

BLANQUI, JÉRÔME ADOLPHE (1798-1854), French economist, was born at Nice on the 21st of November 1798. Beginning life as a schoolmaster in Paris, he was attracted to the study of economics by the lectures of J. B. Say, whose pupil and assistant he became. Upon the recommendation of Say he was in 1825 appointed professor of industrial economy and of history at the Conservatoire des Arts et Métiers. In 1833 he succeeded Say as professor of political economy at the same institution, and in 1838 was elected a member of the Académie des Sciences Morales et Politiques. In 1838 appeared his most important work, *Histoire de l'économie politique en Europe, depuis les anciens jusqu'à nos jours*. He was indefatigable in research, and for the purposes of his economic inquiries travelled over almost the whole of Europe and visited Algeria and the East. He contributed much to our knowledge of the conditions of the working-classes, especially in France. Other works of Blanqui were *De la situation économique et morale de l'Espagne en 1846*; *Résumé de l'histoire du commerce et de l'industrie* (1826); *Précis élémentaire d'économie politique* (1826); *Les Classes ouvrières en France* (1848).

BLANQUI, LOUIS AUGUSTE (1805-1881), French publicist, was born on the 8th of February 1805 at Puget-Théniers, where his father, Jean Dominique Blanqui, was at that time sub-prefect. He studied both law and medicine, but found his real vocation in politics, and at once constituted himself a champion of the most advanced opinions. He took an active part in the revolution of July 1830, and continuing to maintain the doctrine of republicanism during the reign of Louis Philippe, was condemned to repeated terms of imprisonment. Implicated in the armed outbreak of the Société des Saisons, of which he was a

leading spirit, he was in the following year, 1840, condemned to death, a sentence that was afterwards commuted to imprisonment for life. He was released by the revolution of 1848, only to resume his attacks on existing institutions. The revolution, he declared, was a mere change of name. The violence of the *Société républicaine centrale*, which was founded by Blanqui to demand a modification of the government, brought him into conflict with the more moderate Republicans, and in 1849 he was condemned to ten years' imprisonment. In 1865, while serving a further term of imprisonment under the Empire, he contrived to escape, and henceforth continued his propaganda against the government from abroad, until the general amnesty of 1869 enabled him to return to France. Blanqui's leaning towards violent measures was illustrated in 1870 by two unsuccessful armed demonstrations: one on the 12th of January at the funeral of Victor Noir, the journalist shot by Pierre Bonaparte; the other on the 14th of August, when he led an attempt to seize some guns at a barrack. Upon the fall of the Empire, through the revolution of the 4th of September, Blanqui established the club and journal *La patrie en danger*. He was one of the band that for a moment seized the reins of power on the 31st of October, and for his share in that outbreak he was again condemned to death on the 17th of March of the following year. A few days afterwards the insurrection which established the Commune broke out, and Blanqui was elected a member of the insurgent government, but his detention in prison prevented him from taking an active part. Nevertheless he was in 1872 condemned along with the other members of the Commune to transportation; but on account of his broken health this sentence was commuted to one of imprisonment. In 1879 he was elected a deputy for Bordeaux; although the election was pronounced invalid, Blanqui was set at liberty, and at once resumed his work of agitation. At the end of 1880, after a speech at a revolutionary meeting in Paris, he was struck down by apoplexy, and expired on the 1st of January 1881. Blanqui's uncompromising communism, and his determination to enforce it by violence, necessarily brought him into conflict with every French government, and half his life was spent in prison. Besides his innumerable contributions to journalism, he published an astronomical work entitled *L'Éternité par les astres* (1872), and after his death his writings on economic and social questions were collected under the title of *Critique sociale* (1885).

A biography by G. Geoffroy, *L'Enfermé* (1897), is highly coloured and decidedly partisan.

BLANTYRE, the chief town of the Nyasaland protectorate, British Central Africa. It is situated about 3000 ft. above the sea in the Shiré Highlands 300 m. by river and rail N.N.W. of the Chinde mouth of the Zambezi. Pop. about 6000 natives and 100 whites. It is the headquarters of the principal trading firms and missionary societies in the protectorate. It is also a station on the African trans-continental telegraph line. The chief building is the Church of Scotland church, a fine red brick building, a mixture of Norman and Byzantine styles, with lofty turrets and white domes. It stands in a large open space and is approached by an avenue of cypresses and eucalyptus. The church was built entirely by native labour. Blantyre was founded in 1876 by Scottish missionaries, and is named after the birthplace of David Livingstone.

BLANTYRE (Gaelic, "the warm retreat"), a parish of Lanarkshire, Scotland. Pop. (1901) 14,145. The parish lies a few miles south-east of Glasgow, and contains High Blantyre (pop. 2521), Blantyre Works (or Low Blantyre), Stonefield and several villages. The whole district is rich in coal, the mining of which is extensively carried on. Blantyre Works (pop. 1683) was the birthplace of David Livingstone (1813-1873) and his brother Charles (1821-1873), who as lads were both employed as piecers in a local cotton-mill. The scanty remains of Blantyre Priory, founded towards the close of the 13th century, stand on the left bank of the Clyde, almost opposite the beautiful ruins of Bothwell Castle. High Blantyre and Blantyre Works are connected with Glasgow by the Caledonian railway. Stonefield (pop. 7288), the most populous place in

the parish, entirely occupied with mining, lies between High Blantyre and Blantyre Works. Calderwood Castle on Rotten Calder Water, near High Blantyre, is situated amid picturesque scenery.

BLARNEY, a small town of Co. Cork, Ireland, in the mid parliamentary division, 5 m. N.W. of the city of Cork on the Cork & Muskerry light railway. Pop. (1901) 928. There is a large manufacture of tweed. The name "blarney" has passed into the language to denote a peculiar kind of persuasive eloquence, alleged to be characteristic of the natives of Ireland. The "Blarney Stone," the kissing of which is said to confer this faculty, is pointed out within the castle. The origin of this belief is not known. The castle, built c. 1446 by Cormac McCarthy, was of immense strength, and parts of its walls are as much as 18 ft. thick. To its founder is traced by some the origin of the term "blarney," since he delayed by persuasion and promises the surrender of the castle to the lord president. Richard Millikin's song, "The Groves of Blarney" (c. 1798), contributed to the fame of the castle, which is also bound up with the civil history of the county and the War of the Great Rebellion.

BLASHFIELD, EDWIN HOWLAND (1848-), American artist, was born on the 15th of December 1848 in New York City. He was a pupil of Bonnat in Paris, and became (1888) a member of the National Academy of Design in New York. For some years a genre painter, he later turned to decorative work, marked by rare delicacy and beauty of colouring. He painted mural decorations for a dome in the manufacturers' building at the Chicago Exposition of 1893; for the dome of the Congressional library, Washington; for the capitol at St Paul, Minnesota; for the Baltimore court-house; in New York City for the Appellate court house, the grand ball-room of the Waldorf-Astoria hotel, the Lawyers' club, and the residences of W. K. Vanderbilt and Collis P. Huntington; and in Philadelphia for the residence of George W. Drexel. With his wife he wrote *Italian Cities* (1900) and edited Vasari's *Lives of the Painters* (1896), and was well known as a lecturer and writer on art. He became president of the Society of Mural Painters, and of the Society of American Artists.

BLASTIUS (or **BLAISE**), **SAINT**, bishop of Sebaste or Sivas in Asia Minor, martyred under Diocletian on the 3rd of February 316. The Roman Catholic Church holds his festival on the 3rd of February, the Orthodox Eastern Church on the 11th. His flesh is said to have been torn with woolcombers' irons before he was beheaded, and this seems to be the only reason why he has always been regarded as the patron saint of woolcombers. In pre-Reformation England St Blaise was a very popular saint, and the council of Oxford in 1222 forbade all work on his festival. Owing to a miracle which he is alleged to have worked on a child suffering from a throat affection, who was brought to him on his way to execution, St Blaise's aid has always been held potent in throat and lung diseases. The woolcombers of England still celebrate St Blaise's day with a procession and general festivities. He forms one of a group of fourteen (i.e. twice seven) saints, who for their help in time of need have been associated as objects of particularly devoted worship in Roman Catholic Germany since the middle of the 13th century.

See William Hone, *Every Day Book*, i. 210.

BLASPHEMY (through the Fr from Gr *βλασφημία*, profane language, slander, probably derived from root of *βλάπτω*, to injure, and *φήμη*, speech), literally, defamation or evil-speaking, but more peculiarly restricted to an indignity offered to the Deity by words or writing. By the Mosaic law death by stoning was the punishment for blasphemy (Lev. xxiv. 16). The 77th Novel of Justinian assigned death as the penalty, as did also the Capitularies. The common law of England treats blasphemy as an indictable offence. All blasphemies against God, as denying His being, or providence, all contumelious reproaches of Jesus Christ, all profane scoffing at the Holy Scriptures, or exposing any part thereof to contempt or ridicule, are punishable by the temporal courts with fine, imprisonment and also infamous corporal punishment. An act of Edward VI (1547; repealed

1553, and revived 1558) enacts that persons reviling the sacrament of the Lord's Supper, by contemptuous words or otherwise, shall suffer imprisonment. Persons denying the Trinity were deprived of the benefit of the Act of Toleration by an act of 1688. An act of 1697-1698, commonly called the Blasphemy Act, enacts that if any person, educated in or having made profession of the Christian religion, should by writing, preaching, teaching or advised speaking, deny any one of the Persons of the Holy Trinity to be God, or should assert or maintain that there are more gods than one, or should deny the Christian religion to be true, or the Holy Scriptures to be of divine authority, he should, upon the first offence, be rendered incapable of holding any office or place of trust, and for the second incapable of bringing any action, of being guardian or executor, or of taking a legacy or deed of gift, and should suffer three years' imprisonment without bail. It has been held that a person offending under the statute is also indictable at common law (*Rex v. Carlisle*, 1819, where Mr Justice Best remarks, "In the age of toleration, when that statute passed, neither churchmen nor sectarians wished to protect in their infidelity those who disbelieved the Holy Scriptures"). An act of 1812-1813 excepts from these enactments "persons denying as therein mentioned respecting the Holy Trinity," but otherwise the common and the statute law on the subject remain as stated. In the case of *Rex v. Woolston* (1728) the court declared that they would not suffer it to be debated whether to write against Christianity in general was not an offence punishable in the temporal courts at common law, but they did not intend to include disputes between learned men on particular controverted points.

The law against blasphemy has practically ceased to be put in active operation. In 1841 Edward Moxon was found guilty of the publication of a blasphemous libel (Shelley's *Queen Mab*), the prosecution having been instituted by Henry Hetherington, who had previously been condemned to four months' imprisonment for a similar offence, and wished to test the law under which he was punished. In the case of *Cowan v. Milbourn* (1867) the defendant had broken his contract to let a lecture-room to the plaintiff, on discovering that the intended lectures were to maintain that "the character of Christ is defective, and his teaching misleading, and that the Bible is no more inspired than any other book," and the court of exchequer held that the publication of such doctrine was blasphemy, and the contract therefore illegal. On that occasion the court reaffirmed the dictum of Chief Justice Hale, that Christianity is part of the laws of England. The commissioners on criminal law (sixth report) remark that "although the law forbids all denial of the being and providence of God or the Christian religion, it is only when irreligion assumes the form of an insult to God and man that the interference of the criminal law has taken place." In England the last prominent prosecution for blasphemy was the case of *R. v. Ramsey & Foote*, 1883; 48 L.T. 739, when the editor, publisher and printer of the *Freethinker* were sentenced to imprisonment; but police court proceedings were taken as late as 1908 against an obscure Hyde Park orator who had become a public nuisance.

Profane cursing and swearing is made punishable by the Profane Oaths Act 1745, which directs the offender to be brought before a justice of the peace, and fined five shillings, two shillings or one shilling, according as he is a gentleman, below the rank of gentleman, or a common labourer, soldier, &c.

By the law of Scotland, as it originally stood, the punishment of blasphemy was death, but by an act of 1825, amended in 1837, blasphemy was made punishable by fine or imprisonment or both.

In France, blasphemy (which included, also, speaking against the Holy Virgin and the saints, denying one's faith, or speaking with impiety of holy things) was from very early times punished with great severity. The punishment was death in various forms, burning alive, mutilation, torture or corporal punishment. In the United States the common law of England was largely followed, and in most of the states, also, statutes were enacted against the offence but, as in England, the law is practically

never put in force. In Germany, the punishment for blasphemy is imprisonment varying from one day to three years, according to the gravity of the offence. To constitute the offence, the blasphemy must be uttered in public, be offensive in character, and have wounded the religious susceptibilities of some other person. In Austria, whoever commits blasphemy by speech or writing is liable to imprisonment for any term from six months up to ten years, according to the seriousness of the offence.

BLASS, FRIEDRICH (1843-1907), German classical scholar, was born on the 22nd of January 1843 at Osnabrück. After studying at Göttingen and Bonn from 1860 to 1863, he lectured at several gymnasia and at the university of Königsberg. In 1876 he was appointed extraordinary professor of classical philology at Kiel, and ordinary professor in 1881. In 1892 he accepted a professorship at Halle, where he died on the 5th of March 1907. He frequently visited England, and was intimately acquainted with leading British scholars. He received an honorary degree from Dublin University in 1892, and his readiness to place the results of his labours at the disposal of others, together with the courtesy and kindness of his disposition, won the respect of all who knew him. Blass is chiefly known for his works in connexion with the study of Greek oratory: *Die griechische Beredsamkeit von Alexander bis auf Augustus* (1865); *Die attische Beredsamkeit* (1868-1880; 2nd ed., 1887-1898), his greatest work; editions for the Teubner series of Andocides (1880), Antiphon (1881), Hyperides (1881, 1894), Demosthenes (Dindorf's ed., 1885), Isocrates (1886), Dinarchus (1888), Demosthenes (Rehdantz' ed., 1893), Aeschines (1896), Lycurgus, *Leocrates* (1902); *Die Rhythmen der attischen Kunstprosa* (1901); *Die Rhythmen der asiatischen und römischen Kunstprosa* (1905). Among his other works are editions of Eudoxus of Cnidus (1887), the *Ἀθηναίων πολιτεία* (4th ed., 1903), a work of great importance, and Bacchylides (3rd ed., 1904); *Grammatik des neutesamenlichen Griechisch* (1902; Eng. trans. by H. St John Thackeray, 1905); *Hermeneutik und Kritik und Paläographie, Buchwesen, und Handschriftenkunde* (vol. i. of Müller's *Handbuch der klassischen Altertumswissenschaft*, 1891); *Über die Aussprache des Griechischen* (1888; Eng. trans. by W. J. Purton, 1890); *Die Interpolationen in der Odyssee* (1904); contributions to Collitz's *Sammlung der griechischen Dialektschriften*; editions of the texts of certain portions of the New Testament (Gospels and Acts). His last work was an edition of the *Choephoroi* (1906).

See notices in the *Academy*, March 16, 1907 (J. P. Mahaffy); *Classical Review*, May 1907 (J. E. Sandys), which contains also a review of *Die Rhythmen der asiatischen und römischen Kunstprosa*.

BLASTING, the process of rending or breaking apart a solid body, such as rock, by exploding within it or in contact with it some explosive substance. The explosion is accompanied by the sudden development of gas at a high temperature and under a tension sufficiently great to overcome the resistance of the enclosing body, which is thus shattered and disintegrated. Before the introduction of explosives, rock was laboriously excavated by hammer and chisel, or by the ancient process of "fire-setting," i.e. building a fire against the rock, which, on cooling, splits and flakes off. To hasten disintegration, water was often applied to the heated rock, the loosened portion being afterwards removed by pick or hammer and wedge. In modern times blasting has become a necessity for the excavation of rock and other hard material, as in open surface cuts, quarrying, tunnelling, shaft-sinking and mining operations in general.

For blasting, a hole is generally drilled to receive the charge of explosive. The depth and diameter of the hole and the quantity of explosive used are all variable, depending on the character of the rock and of the explosive, the shape of the mass to be blasted, the presence or absence of cracks or fissures, and the position of the hole with respect to the free surface of the rock. The shock of a blast produces impulsive waves acting radially in all directions, the force being greatest at the centre of explosion and varying inversely as the square of the distance from the charge. This is evidenced by the observed facts. Immediately surrounding the explosive, the rock is often finely splintered and crushed. Beyond this is a zone in which it is completely broken and

displaced or projected, leaving an enveloping mass of more or less ragged fractured rock only partially loosened. Lastly, the diminishing waves produce vibrations which are transmitted to considerable distances. Theoretically, if a charge of explosive be fired in a solid material of perfectly homogeneous texture and at a proper distance from the free surface, a conical mass will be blown out to the full depth of the drill hole, leaving a funnel-shaped cavity. No rock, however, is of uniform mineralogical and physical character, so that in practice there is only a rough approximation to the conical crater, even under the most favourable conditions. Generally, the shape of the mass blasted out is extremely irregular, because of the variable texture of the rock and the presence of cracks, fissures and cleavage planes. The ultimate or resultant useful effect of the explosion of a confined charge is in the direction where the least resistance is presented. In the actual work of rock excavation it is only by trial, or by deductions based on experience, that the behaviour of a given rock can be determined and the quantity of explosive required properly proportioned.

Blasting, as usually carried on, comprises several operations: (1) drilling holes in the rock to be blasted; (2) placing in the hole the charge of explosive, with its fuze; (3) tamping the charge, *i.e.* compacting it and filling the remainder of the hole with some suitable material for preventing the charge from blowing out without breaking the ground; (4) igniting or detonating the charge; (5) clearing away the broken material. The holes for blasting are made either by hand, with hammer and drill or jumper, or by machine drill, the latter being driven by steam, compressed air, or electricity, or, in rare cases, by hydraulic power. Drill holes ordinarily vary in diameter from 1 to 3 in., and in depth from a few inches up to 15 or 20 ft. or more. The deeper holes are made only in surface excavation of rock, the shallower, to a maximum depth of say 12 ft., being suitable for tunnelling and mining operations.

Hand Drilling.—The work is either "single-hand" or "double-hand." In single-hand drilling, the miner wields the hammer with one hand, and with the other holds the drill or "bit," rotating it slightly after every blow in order to keep the hole round and prevent the drill from sticking fast; in double-hand work, one man strikes, while the other holds and rotates the drill. For large and deep holes, two hammermen are sometimes employed.

A miner's drill is a steel bar, occasionally round but generally of octagonal cross-section, one end of which is forged out to a cutting edge (fig. 1). The edge of the drill is made either straight, like that of a chisel, or with a convex curve, the latter shape being best for very hard rock. For hard rock the cutting edge should be rather thicker and blunter, and therefore stronger, than for soft rock. Drills are made of high-grade steel, as they must

be tempered accurately and uniformly. The diameter of drill steel for hand work is usually from $\frac{3}{4}$ to 1 in., and the length of cutting edge, or gauge, of the drill is always greater than the diameter of the shank, in the proportion of from 7:4 to 4:3. Holes over 10 or 12 in. deep generally require the use of a set of drills of different lengths and depending in number on the depth required. The shortest drill, for starting the hole, has the widest cutting edge, the edges of the others being successively narrower and graduated to follow each other properly, as drill after drill is dulled in deepening the hole. Thus the hole decreases in diameter as it is made deeper. The miner's hammer (fig. 2) ranges in weight from 3½ to 4½ lb for single-hand drilling, up to 8 or 10 lb for double-hand. If the hole is directed downward, a little water is poured into it at intervals, to keep the cutting edge of the drill cool and make a thin mud of the cuttings. From time to time the hole is cleaned out by the "scraper" or "spoon,"

a long slender iron bar, forged in the shape of a hollow semi-cylinder, with one end flattened and turned over at right angles. If the hole is directed steeply upward and the rock is dry, the cuttings will run out continuously during the drilling; otherwise the scraper is necessary, or a small pipe with a plunger like a syringe is used for washing out the cuttings. The "jumper" is a long steel bar, with cutting edges on one or both ends, which is alternately raised and dropped in the hole by one or two men. In rock work the jumper is rarely used except for holes directed steeply downward, though for coal or soft shale or slate it may be em-

ployed for drilling holes horizontally or upward. Other tools used in connexion with rock-drilling are the pick and gad.

Holes drilled by hand usually vary in depth from say 18 to 36 in., according to the nature of the rock and purpose of the work, though deeper holes are often made. For soft rock, single-hand drilling is from 20 to 30% cheaper than double-hand, but this difference does not hold good for the harder rocks. For these double-hand drilling is preferable, and may even be essential, to secure a reasonable speed of work.

Machine Drills.—The introduction of machine drills in the latter part of the 19th century exerted an important influence on the work of rock excavation in general, and specially on the art of mining. By their use many great tunnels and other works involving rock excavation under adverse conditions have been rapidly and successfully carried out. Before the invention of machine drills such work progressed slowly and with difficulty. Nearly all machine drills are of the reciprocating or percussive type, in which the drill bit is firmly clamped to the piston rod and delivers a rapid succession of strong blows on the bottom of the hole. The ordinary compressed air drill (which may, for surface work, be operated also by steam) may be taken as an illustration. The piston works in a cylinder, provided with a valve motion somewhat similar to that of a steam-engine, together with an automatic device for producing the necessary rotation of the piston and drill bit. While at work the machine is mounted on a heavy tripod (fig. 3); or, if underground, sometimes on an iron column or bar, firmly wedged in position between the roof and floor, or side walls, of the tunnel or mine working. As the hole is deepened, the entire drill head is gradually fed forward on its support by a screw feed, a succession of longer and longer drill bits being used as required.

Among the numerous types and makes of percussion drill may be named the following:—Adelaide, Climax, Darlington, Dubois-François, Ferroux, Froelich, Hirmant, Ingersoll, Jeffrey, Leyner, McKiernan, Rand, Schram, Sergeant, Sullivan and Wood. One of the simplest of the machine drills is the Darlington (figs. 4 and 5): *a* is the cylinder; *b*, piston rod; *c*, bit; *d, d*, air inlets.

either being used according to the position of the drill while at work; *a*, piston; *j*, rifle-bar for rotating piston and bit; *k*, ratchet attached to *j*; *l*, brass nut, screwed into *a*, and in which *j* works; *f*, chuck for holding drill-bit; *m*, air port communicating between ends of cylinder, front and back of piston; *e*, exhaust port. This machine has no valve. From its construction, the compressed air (or steam) is always acting on the annular shoulder round the forward end of the piston. The piston is thereby forced back on the

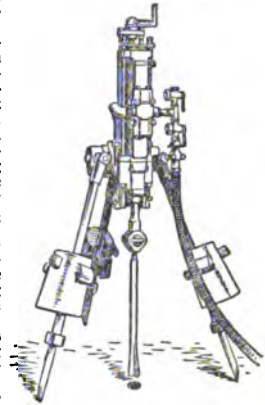
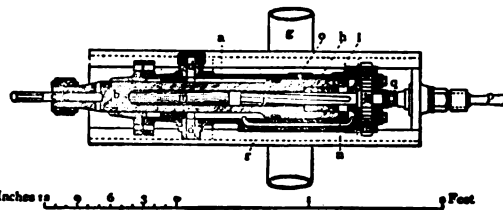
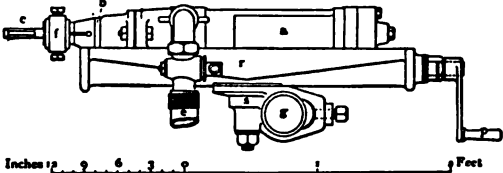

FIG. 3.—Ingersoll-Sergeant Mining Drill.



FIGS. 4 and 5.—Darlington's Rock Drill.

FIG. 1.—Sledge-hammer.

in-stroke until the port *s* is uncovered. This admits the compressed air to the rear end of the cylinder, and as the area of this end of the piston is much greater than that of the shoulder on the other end, the piston is driven forward and strikes its blow. When it has advanced far enough to cover the exhaust port *e*, the air behind the piston is exhausted, and, under the constant inward pressure noted above, the stroke is reversed. The rotation of piston and bit is caused by the ratchet-bar *j*. On the outward stroke, *j*, with its ratchet, *h*, is free to turn under a couple of pawls and springs, and consequently the piston delivers its blow without rotation. On the inward stroke the ratchet is held fast by the pawls, and the piston and bit are forced to rotate through a small part of a revolution. The cylinder is fed forward with respect to the shell *r*, by rotating the handle *p*, which works a long screw-bar engaging with a nut on the under side of the cylinder. The shell *r* is bolted to the clamp *z*, which in turn is mounted on the hollow column or bar *g*, or on a tripod, according to the character of the work. By means of the adjustable clamp *s*, the machine can be set for drilling a hole in any desired direction. The drill makes from 400 to 800 strokes per minute.

The "New Ingersoll" drill, which may be taken as an example of the numerous machines in which valves are used, is shown in section in fig. 6. The steam or compressed air is distributed through the ports alternately to the ends of the cylinder, by the reciprocations of a spool-valve working in a chest mounted on the cylinder. The movements of this valve are caused by the strokes of the main piston, which, by means of the wide annular groove around the middle of the piston, alternately open and close the spool-valve exhaust ports. Fig. 3 shows the Ingersoll "Light Mining drill," as mounted on a tripod, and in position for drilling a hole vertically downward. In the Leyner drill the drill-bit is not connected to the piston, but is struck a quick succession of blows by the latter. An important feature of this machine is the provision for directing a stream of water into the hole for clearing out the cuttings. For this purpose the shank of the drill-bit is perforated longitudinally, the water being supplied under pressure from a small tank, to which compressed air is led.

A rock drill of entirely different design, the Brandt, has been successfully used in Europe for driving railway tunnels. It is operated by hydraulic power, the pressure water being supplied by a pump. The hollow drill-bit, which has a serrated cutting edge, is forced under heavy pressure against the bottom of the hole, and is rotated slowly—at six to eight revolutions per minute—by a pair of small hydraulic cylinders, thus grinding and crushing the rock instead of chipping it. The bottom of the hole is kept clean and the drill-bit cooled by a stream of water passing down through its hollow shank. On account of its size and weight, this machine is not suitable for mine work.

Most of the machine drills are made in a number of sizes, from 2 in. up to 5 in. diameter of cylinder, the larger sizes being capable of drilling holes 5 in. diameter and 30 ft. deep. They range in weight from say 95 to 690 lb for the drill head (unmounted), the tripods weighing from 40 to 260 lb, exclusive of the weights placed for stability on the tripod legs (fig. 3). The sizes in most common use for mining are from 2½ in. to 3½ in. diameter of cylinder. In rock of average hardness the best drills make from 4 to 7½ linear ft. of hole per hour. For use in narrow veins, or other confined workings underground, several extremely small and light compressed air drills have been introduced, as, for example, the Franke and Wonder, the first of which weighs complete only 16 lb, and the second 18 lb. These drills are held in the hands of the miner in the required position, and strike a rapid succession of light blows. A large number of mechanical drills operated by hand power have been invented. Some imitate hand-drilling in the mode of delivering the blow; in

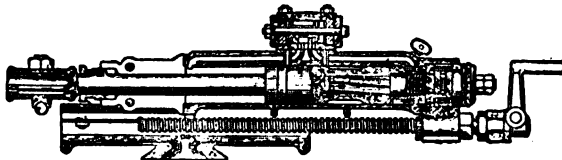

FIG. 6.—New Ingersoll Drill.

others the drill-bit is caused to reciprocate by means of combinations of crank and spring. None of these machines is entirely satisfactory, and but few are in use.

Among percussion rock-drills operated by electricity are the Blakray, Box, Durkee, Marvin and Siemens-Halske. The Marvin drill works with a solenoid; most of the others have crank and spring movements for producing the reciprocations of the piston. Power is furnished by a small electric motor, either mounted on the machine itself, as with the Box drill, or more often standing on the ground and transmitting its power through a flexible shaft. Although rather frequently used, electric percussion drills cannot yet be considered entirely successful, at least for mine service, in competition with compressed air machines. Another type of electric drill, however,

has been successfully used in collieries, viz. rotary auger drills, mounted on light columns and driven through gearing by diminutive motors. These are intended for boring in coal, slate or other similar soft material. Hand augers resembling a carpenter's brace and bit are also often used in collieries.

Whatever may be the method of drilling, after the hole has been completed to the depth required, it is finally cleaned out by a scraper or swab; or, when compressed air drills are used, by a jet of air directed into the hole by a short piece of pipe connected through a flexible hose with the compressed air supply pipe. The hole is then ready for the charge.

Location and Arrangement of Holes.—For hand drilling in mining the position of the holes is determined largely by the character and

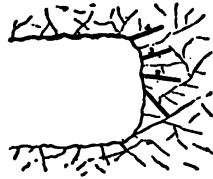

FIG. 7.

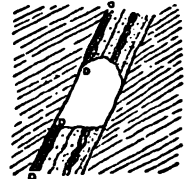

FIG. 8.

shape of the face of rock to be blasted. The miner observes the joints and cracks of the rock, placing the holes to take advantage of them and so obtain the best result from the blast. In driving a tunnel or drift, as in figs. 7 and 8, the rock joints can be made of material assistance by beginning with hole No. 1 and following in succession by Nos. 2, 3 and 4. Frequently the ore, or vein matter, is separated from the wall-rock by a thin, soft layer of clay (D. D., fig. 8). This would act almost as a free face, and the first holes of the round would be directed at an angle towards it, for blasting out a wedge; after which the positions of the other holes would be chosen.

When machine drills are employed, less attention is given to natural cracks or joints, chiefly because when the drill is once set up

several holes at different angles can be drilled in succession by merely swinging the cylinder of the machine into a new position with respect to its mounting. According to one method, the holes are placed with some degree of symmetry, in roughly concentric rings, as shown by figs. 9 and 10. The centre holes are blasted first, and are followed by the others in one or more volleys as indicated by the dotted lines. Another method is the "centre cut," in which the holes are drilled in parallel rows on each side of the centre line of the tunnel drift or shaft. Those in the two rows nearest the middle are directed towards each other, and enclose a prism of rock, which is first blasted out by heavy charges, after which the rows of side holes will break with relatively light charges.

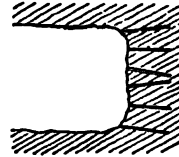

FIG. 9.

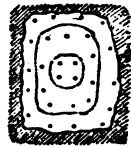

FIG. 10.

Explosives.—A great variety of explosives are in use for blasting purposes. Up to 1864, gunpowder was the only available explosive, but in that year Alfred Nobel first applied nitroglycerin for blasting, and in 1867 invented dynamite. This name was originally applied to his mixture of nitroglycerin with kieselguhr, but now includes also other mechanical mixtures or chemical compounds which develop a high explosive force as compared with gunpowder. Besides these there are the so-called flameless or safety explosives, used in collieries where inflammable gases are given off from the coal.

Explosives.—A great variety of explosives are in use for blasting purposes. Up to 1864, gunpowder was the only available explosive, but in that year Alfred Nobel first applied nitroglycerin for blasting, and in 1867 invented dynamite. This name was originally applied to his mixture of nitroglycerin with kieselguhr, but now includes also other mechanical mixtures or chemical compounds which develop a high explosive force as compared with gunpowder. Besides these there are the so-called flameless or safety explosives, used in collieries where inflammable gases are given off from the coal.

Gunpowder, or black powder, is seldom used for rock-blasting, except in quarrying building-stone, where slow explosives of relatively low power are desirable to avoid shattering the stone, and in such collieries as do not require the use of safety explosives. Gunpowder is exploded by deflagration, by means of a fuse, and exerts a comparatively slow and rending force. The high explosives, on the other hand, are exploded by detonation, through the agency of a fuse and fulminating cap, exerting a quick, shattering, rather than a rending force. Dynamites and flameless explosives are made in a variety of strengths, and are packed in waterproofed cartridges of different sizes. The grades of dynamite most commonly employed contain from 35 to 60% of nitroglycerin; the stronger are used for tough rock or deep holes, or for holes unfavourably placed in narrow mine workings, as sometimes in shaft-sinking or tunnelling. When of good quality high explosives are safer to handle than gunpowder,

as they cannot be ignited by sparks and are not so easily exploded. The ordinary dynamites used in mining are about four times as powerful as gunpowder.

Nitroglycerin in its liquid form is now rarely used for blasting, partly because its full strength is not often necessary but chiefly because of the difficulty and danger of transporting, handling and charging it. If employed at all, it is charged in thin tinned plate cases or rubber-cloth cartridges.

Blasting with Black Powder.—The powder is coarse-grained, usually from $\frac{1}{8}$ to $\frac{1}{4}$ in. in size, and is charged in paper cartridges, $\frac{1}{2}$ to 10 in. long and of a proper diameter to fit loosely in the drill hole. A piece of fuzes, long enough to reach a little beyond the mouth of the hole, is inserted in the cartridge and tied fast. For wet holes paraffined paper is used, the miner waterproofing the joints with grease. When more than one cartridge is required for the blast, that which has the fuzes attached is usually charged last. The cartridges are carefully rammed down by a wooden tamping bar and the remainder of the hole filled with tamping. This consists of finely broken rock, dry clay or other comminuted material, carefully compacted by the tamping bar on top of the charge. The fuzes in a cord, having in the centre a core of gunpowder, enclosed in several layers of linen or hemp waterproofed covering. It is ignited by the miner's candle or lamp, or by a candle end so placed at the mouth of the hole that the flame must burn its way through the fuzes covering. As the fuzes burn slowly, at the rate of 2 or 3 ft. per minute, the miner uses a sufficient length to allow him to reach a place of safety.

For blasting in coal, "squibs" instead of fuzes are often used. A squib is simply a tiny paper rocket, about $\frac{1}{4}$ in. diameter by 3 in. long, containing fine gunpowder and having a sulphur slow-match at one end. It is fired into the charge through a channel in the tamping. This channel may be formed by a piece of $\frac{1}{4}$ in. gas pipe, tamped in the hole and reaching the charge; or a "needle," a long-taper iron rod, is laid longitudinally in the hole, with its point entering the charge, and after the tamping is finished, by carefully withdrawing the needle a little channel is left, through which the squib is fired. In this connexion it may be noted that for breaking ground in gaseous collieries several substitutes for explosives have been used to a limited extent, e.g. plugs of dry wood driven tightly into a row of drill holes, and which on being wetted swell and split the coal; quicklime cartridges, which expand powerfully on the application of water; simple wedges, driven by hammer into the drill holes; multiple wedges, inserted in the holes and operated by hydraulic pressure from a small hand force-pump.

Blasting with High Explosives.—High explosives are fired either by ordinary fuzes and detonating cap or by electric fuzes. Detonating caps of ordinary strength contain 10 to 15 grains of fulminating mixture. The cap is crimped tight on the end of the fuzes, embedded in the cartridge, and on being exploded by fire from the fuzes detonates the charge. The number of cartridges charged depends on the depth of hole, the length of the line of least resistance, and the toughness and other characteristics of the rock. Each cartridge should be solidly tamped, and, to avoid waste spaces in the hole, which would reduce the effect of the blast, it is customary to split the paper covering lengthwise with a knife. This allows the dynamite to spread under the pressure of the tamping bar. The cap is often placed in the cartridge preceding the last one charged, but it is better to insert it last, in a piece of cartridge called a "primer." Though the dynamites are not exploded by sparks, they should nevertheless always be handled carefully. It is not so essential to fill the hole completely and so thoroughly to compact the tamping, as in charging black powder, because of the greater rapidity and shattering force of the explosion of dynamite; tamping, however, should never be omitted, as it increases the efficiency of the blast. In exploding dynamite, strong caps, containing say 15 grains of fulminating powder, produce the best results. Weaker caps are not economical, as they do not produce complete detonation of the dynamite. This is especially true if the weather be cold. Dynamite then becomes less sensitive, and the cartridges should be gently warmed before charging, to a temperature of not more than 80° F. Poisonous fumes are often produced by the explosion of the nitroglycerin compounds. These are probably largely due to incomplete detonation, by which part of the nitroglycerin is vaporized or merely burned. This is most likely to occur when the dynamite is chilled, or of poor quality, or when the cap is too weak. There is generally but little inconvenience from the fumes, except in confined underground workings, where ventilation is important.

Like nitroglycerin, the common dynamites freeze at a temperature of from 42° to 46° F. They are then comparatively safe, and so far as possible should be transported in the frozen state. At very low temperatures dynamite again becomes somewhat sensitive to shock. When it is frozen at ordinary temperatures even the strongest detonating caps fail to develop the full force. In thawing dynamite, care must be exercised. The fact that a small quantity will often burn quietly has led to the dangerously mistaken notion that mere heating will not cause explosion. It is chiefly a question of temperature. If the quantity ignited by flame be large enough to heat the entire mass to the detonating point (say 360° F.) before all is consumed, an explosion will result. Furthermore, dynamite, when even moderately heated, becomes extremely sensitive to shocks.

There are several accepted modes of thawing dynamite: (1) In a water bath, the cartridges being placed in a vessel surrounded on the sides and bottom by warm water contained in a larger enclosing vessel. The warm water may be renewed from time to time, or the water bath placed over a candle or small lamp, set on a stove. (2) In two vessels, similar to the above, with the space between them occupied by air, provided the heat applied can be definitely limited, as by using a candle. (3) When large quantities of dynamite are used a supply may be kept on shelves in a wooden room or chamber, warmed by a stove, or by a coil of pipe heated by exhaust steam from an engine. Live steam should not be used, as the heat might become excessive. Thawing should always take place slowly, never before an open fire or by direct contact with a stove or steam pipes and care must be taken that the heat does not rise high enough to cause sweating or exudation of liquid nitroglycerin from the cartridges, which would be a source of danger.

For the storage of explosives at mines, etc., proper magazines must be provided, situated in a safe place, not too near other buildings, and preferably of light though fireproof construction. Masonry magazines, though safer from some points of view, may be the cause of greater damage in event of an explosion, because the brick or stones act as projectiles. Isolated and abandoned mine workings, if dry, are sometimes used as magazines.

Firing blasts by electricity has a wide application for both surface and underground work. An electrical fuzes (fig. 11) consists of a pair of fine, insulated copper wires, several feet long and about $\frac{1}{16}$ of an inch in diameter, with their bare ends inserted in a detonating cap. For firing, the fuzes wires are joined to long leading wires, connected with some source of electric current. By joining the fuzes wires in series or in groups, any number of holes may be fired simultaneously, according to the current available. A round of holes fired in this way, as for driving tunnels, sinking shafts, or in large surface excavations, produces better results, both in economy of explosive and effect of the blast, than when the holes are fired singly or in succession. Also, the miners are enabled to prepare for the blast with more care and deliberation, and then to reach a place of safety before the current is transmitted. Another advantage is that there is no danger of a hole "hanging fire," which sometimes causes accidents in using ordinary fuzes.

Hanging fire may be due to a cut, broken or damaged powder fuzes, which may smoulder for some time before communicating fire to the charge. "Miss-fires," which also are of not infrequent occurrence with both ordinary and electric fuzes, are cases where explosion from any cause fails to take place. After waiting a sufficient length of time before approaching the charged hole, the miner carefully removes the tamping down to within a few inches of the explosives and inserts and fires another cartridge, the concussion usually detonating the entire charge. Sometimes another hole is drilled near the one which has missed. No attempt to remove the old charge should ever be made.

High tension electricity, generated by a frictional machine, provided with a condenser, was formerly much used for blasting. The bare ends of the fuzes wires in the detonating cap are placed say $\frac{1}{2}$ in. apart, leaving a gap across which a spark is discharged, passing through a priming charge of some sensitive composition. The priming is not only combustible but also a conductor of electricity, such as an intimate mixture of potassium chlorate with copper sulphide and phosphide. By the combustion of the priming the fulminate mixture in the cap is detonated. As these fuzes are more apt to deteriorate when exposed to dampness than fuzes for low-tension current, and the generating machine is rather clumsy and fragile, low-tension current is more generally employed. It may be generated by a small, portable dynamo, operated by hand, or may be derived from a battery or from any convenient electric circuit. The ends of the fuzes wires in the detonating cap are connected by a fine platinum filament (fig. 11), embedded in a gunotton priming on top of the fulminating mixture, and explosion results from the heat generated by the resistance opposed to the passage of the current through the filament. Blasting machines are made in several sizes, the smaller ones being capable of firing simultaneously from ten to twenty holes. The fuzes must obviously be of uniform electrical resistance, to ensure that all the connected charges will explode simultaneously. The premature explosion of any one of the fuzes would break the circuit.

In the actual operations of blasting, definite rules for the proportioning of the charges are rarely observed, and although the blasts made by a skilful miner seldom fail to do their work, it is a common fault that too much, rather than too little, explosive is used. The high explosives are especially liable to be wasted, probably through lack of appreciation of their power as compared with that of black powder. Among the indications of excessive charges are the production of much finely broken rock or of crushed and splintered rock around the bottom of the hole, and excessive displacement or projection of the rock broken by the blast. In beginning any new piece of work, such waste may be avoided or reduced by making



FIG. 11. Electrical Fuzes.

trial shots with different charges and depths of hole, and noting the results; also by letting contracts under which the workmen pay for the explosive. In surface rock excavation the location and determination of the depth of the holes and the quantity of explosive used, are occasionally put in charge of one or more skilled men, who direct the work and are responsible for the results obtained.

Blasting in surface excavations and quarries is sometimes done on an immense scale—called "mammoth blasting." Shafts are sunk, or tunnels driven, in the mass of rock to be blasted, and, connected with them, a number of chambers are excavated to receive the charges of explosive. The preparation for such blasts may occupy months, and many tons of gunpowder or dynamite are at times exploded simultaneously, breaking or dislodging thousands, or even hundreds of thousands, of tons of rock. This method is adopted for getting stone cheaply, as for building macadamized roads, dams and breakwaters, obtaining limestone for blast furnace flux, and occasionally in excavating large railway cuttings. It is also applied in submarine blasting for the removal of reefs obstructing navigation, and sometimes for loosening extensive banks of partly cemented gold-bearing gravel, preparatory to washing by hydraulic mining.

AUTHORITIES.—For further information on drilling and blasting see—Callon, *Lectures on Mining* (1876), vol. i, chs. v. and vi.; Foster, *Text-book of Ore and Stone Mining* (1909), ch. iv.; Hughes, *Text-book of Coal Mining* (1901), ch. iii.; H. S. Drinker, *Tunnelling, Explosive Compounds and Rock Drills* (1878); M. C. Hlsang, *Manual of Mining* (1905), pp. 596-696; Kohler, *Der Bergbaukunde* (1897), pp. 104-208; Daw, *The Blasting of Rock* (1898); Prelini, *Earth and Rock Excavation* (1905), chs. v., vi. and vii.; Gillette, *The Excavation of Rock* (1904); Guttman, *Blasting* (1892); Spon's *Dictionary of Engineering*, art. "Boring and Blasting"; Eissler, *Modern High Explosives* (1893), pts. ii. and iii.; Walke, *Lectures on Explosives* (1897), chs. xix.-xxii. Also: *Proc. Inst. Civ. Eng.* (London), vol. lxxxv. p. 264; *Trans. Inst. Min. Eng.* (England), vol. xiv., xv. and xvi. (arts. by W. Maurice), vol. xxvi. pp. 322, 348, vol. xxiv. p. 526 and vol. xxv. p. 108; *Trans. Amer. Soc. Civ. Eng.*, vol. xxvii. p. 530; *Trans. Amer. Inst. Min. Eng.*, vol. xviii. p. 370, vol. xxix. p. 405 and vol. xxxiv. p. 871; *South Wales Inst. Eng.* (1888); *Jour. As. Eng. Soc.*, vol. vii. p. 58; *Jour. Chem. Met. and Mining Soc. of South Africa*, August 1905; *School of Mines Quarterly*, N. Y., vol. ix. p. 308; *Colliery Guardian*, April 15, 1898, and February 6, 1903; *Mines and Minerals*, February 1905, p. 348, January 1906, p. 259, and April 1906, p. 393; *Eng. and Mining Jour.*, April 19, 1902, p. 552; *The Engineer*, February 24, 1905; *Elec. Rev.*, June 9, 1899; *Eng. News*, vol. xxxii. p. 249, and August 3, 1905; *Gluckauf*, September 28, 1901, and July 5, 1902; *Osterr. Zeitschr. f. Berg- u. Huttenwesen*, May 18, 25, 1901, April 18, 1903 and November, 18, 1905; *Annales des mines*, vol. xviii. pp. 217-248. (R. P.)

BLAUBEUREN, a town of Germany, in the kingdom of Württemberg, 12 m. W. of Ulm, with which it is connected by railway. Pop. (1900) 3114. It is romantically situated in a wild and deep valley of the Swabian Alps at an altitude of 1600 ft. and is partly surrounded by ancient walls. Of the three churches (two Evangelical and one Roman Catholic) the most remarkable is the abbey church (*Klosterkirche*), a late Gothic building dating from 1465-1496, the choir of which contains beautiful 15th century carved choir-stalls and a fine high altar with a triptych (1496). The choir only is used for service (Protestant), the nave being used as a gymnasium. The town church (*Stadtkirche*) also has a fine altar with triptych. The Benedictine abbey, founded in 1095, was used after the Reformation as a school, and is now an Evangelical theological seminary. There are two hospitals in the town.

BLAVATSKY, HELENA PETROVNA (1831-1891), Russian theosophist, was born at Ekaterinoslav, on the 31st of July (O.S.) 1831, the daughter of Colonel Peter Hahn, a member of a Mecklenburg family, settled in Russia. She married in her seventeenth year a man very much her senior, Nicephore Blavatsky, a Russian official in Caucasia, from whom she was separated after a few months; in later days, when seeking to invest herself with a halo of virginity, she described the marriage as a nominal one. During the next twenty years Mme Blavatsky appears to have travelled widely in Canada, Texas, Mexico and India, with two attempts on Tibet. In one of these she seems to have crossed the frontier alone in disguise, been lost in the desert, and, after many adventures, been conducted back by a party of horsemen. The years from 1848 to 1858 were alluded to subsequently as "the veiled period" of her life, and she spoke vaguely of a seven years' sojourn in "Little and Great Tibet," or preferably of a "Himalayan retreat." In 1858 she revisited Russia, where she created a sensation as a spiritualistic medium. About 1870 she acquired

prominence among the spiritualists of the United States, where she lived for six years, becoming a naturalized citizen. Her leisure was occupied with the study of occult and kabbalistic literature, to which she soon added that of the sacred writings of India, through the medium of translations. In 1875 she conceived the plan of combining the spiritualistic "control" with the Buddhistic legends about Tibetan sages. Henceforth she determined to exclude all control save that of two Tibetan adepts or "mahatmas." The mahatmas exhibited their "astral bodies" to her, "precipitated" messages which reached her from the confines of Tibet in an instant of time, supplied her with sound doctrine, and incited her to perform tricks for the conversion of sceptics. At New York, on the 17th of November 1875, with the aid of Colonel Henry S. Olcott, she founded the "Theosophical Society" with the object of (1) forming a universal brotherhood of man, (2) studying and making known the ancient religions, philosophies and sciences, (3) investigating the laws of nature and developing the divine powers latent in man. The Brahmanic and Buddhistic literature supplied the society with its terminology, and its doctrines were a curious amalgam of Egyptian, kabbalistic, occultist, Indian and modern spiritualistic ideas and formulas. Mme Blavatsky's principal books were *Isis Unveiled* (New York, 1877), *The Secret Doctrine, the Synthesis of Science, Religion and Philosophy* (1888), *The Key to Theosophy* (1891). The two first of these are a mosaic of unacknowledged quotations from such books as K. R. H. Mackenzie's *Royal Masonic Encyclopaedia*, C. W. King's *Gnostics*, Zeller's *Plato*, the works on magic by Dunlop, E. Salverte, Joseph Ennesmore, and Des Mousseaux, and the mystical writings of Eliphas Levi (L. A. Constant). *A Glossary of Theosophical Terms* (1890-1892) was compiled for the benefit of her disciples. But the appearance of Home's *Lights and Shadows of Spiritualism* (1877) had a prejudicial effect upon the propaganda, and Heliona P. Blavatsky (as she began to style herself) retired to India. Thence she contributed some clever papers, "From the Caves and Jungles of Hindostan" (published separately in English, London, 1892) to the *Russky Vjestnik*. Defeated in her object of obtaining employment in the Russian secret service, she resumed her efforts to gain converts to theosophy. For this purpose the exhibition of "physical phenomena" was found necessary. Her jugglery was cleverly conceived, but on three occasions was exposed in the most conclusive manner. Nevertheless, her cleverness, volubility, energy and will-power enabled her to maintain her ground, and when she died on the 8th of May 1891 (White Lotus Day), at the theosophical headquarters in the Avenue Road, London, she was the acknowledged head of a community numbering not far short of 100,000, with journalistic organs in London, Paris, New York and Madras.

Much information respecting her will be found in V. S. Solovyov's *Modern Priestess of Isis*, translated by Walter Leaf (1895), in Arthur Lillie's *Madame Blavatsky and Her Theosophy* (1895), and in the report made to the Society for Psychical Research by the Cambridge graduate despatched to investigate her doings in India. See also the article THEOSOPHY.

BLAYDES, FREDERICK HENRY MARVELL (1818-1908), English classical scholar, was born at Hampton Court Green, on the 29th of September 1818, being a collateral descendant of Andrew Marvell, the satirist and friend of Milton. He was educated at St Peter's school, York, and Christ Church, Oxford. He was Hertford scholar in 1838, took a second class in literae humaniores in 1840, and was subsequently elected to a studentship at Christ Church. In 1842 he took orders, and from 1843 to 1886 was vicar of Harringworth in Northamptonshire. During a long life he devoted himself almost entirely to the study of the Greek dramatists. His editions and philological papers are remarkable for bold conjectural emendations of corrupt (and other) passages. His distinction was recognized by his being made an honorary LL.D. of Dublin, Ph.D. of the university of Buda Pest and a fellow of the royal society of letters at Athens. He died at Southsea on the 7th of September 1908.

His works include—*Aristophanes: Comedies and Fragments*, with critical notes and commentary (1880-1893); *Clouds, Knights, Frogs, Wasps* (1873-1878); *Opera Omnia*, with critical notes (1886);

Sophocles; Oedipus Coloneus, Oedipus Tyrannus and Antigone (in the *Bibliotheca Classica*, 1859); *Philoctetes* (1870), *Trachiniae* (1871), *Electra* (1873), *Ajax* (1875), *Antigone* (1905); *Aeschylus: Agamemnon* (1898), *Choephoroi* (1899), *Euromides* (1900), *Adersaria Critica in Comicarum Graecorum Fragmenta* (1890); in *Tragicorum Graec. Frag.* (1894), in *Aeschylus* (1895), in *Varios Poetas Graecos et Latinos* (1898), in *Aristophanem* (1899), in *Sophoclem* (1899), in *Euripidem* (1901), in *Herodotum* (1901), in *Analectica Comica Graeca* (1905); *Analectica Tragic Graeca* (1906).

BLAYDON, an urban district in the Chester-le-Street parliamentary division of Durham, England, on the Tyne, 4 m. W. of Newcastle by a branch of the North-Eastern railway. Pop. (1881) 10,687; (1901) 19,617. The chief industries are coal-mining, iron-founding, pipe, fire-brick, chemical manure and bottle manufactures. In the vicinity is the beautiful old mansion of Stella, and below it Stellaheugh, to which the victorious Scottish army crossed from Newburn on the Northumberland bank in 1640, after which they occupied Newcastle.

BLAYE-ST-STE LUCE, a town of south-western France, capital of an *arrondissement* in the department of Gironde, on the right bank of the Gironde (here over 2 m. wide), 35 m. N. of Bordeaux by rail. Pop. (1906) of the town, 3423; of the commune, 4890. The town has a citadel built by Vauban on a rock beside the river, and embracing in its enceinte ruins of an old Gothic chateau. The latter contains the tomb of Caribert, king of Toulouse, and son of Clotaire II. Blaye is also defended by the Fort Platé on an island in the river and the Fort Médoc on its left bank, both of the 17th century. The town is the seat of a sub-prefect, and has tribunals of first instance and of commerce and a communal college. It has a small river-port, and carries on trade in wine, brandy, grain, fruit and timber. The industries include the building of small vessels, distilling, flour-milling, and the manufacture of oil and candles. Fine red wine is produced in the district.

In ancient times Blaye (*Blavia*) was a port of the Santones. Tradition states that the hero Roland was buried in its basilica, which was on the site of the citadel. It was early an important stronghold which played an important part in the wars against the English and the Religious Wars. The duchess of Berry was imprisoned in its fortress in 1832-1833.

BLAZE (A.-S. *Naess*, a torch), a fire or bright flame; more nearly akin to the Ger. *Blas*, pale or shining white, is the use of the word for the white mark on the face of a horse or cow, and the American use for a mark made on a tree by cutting off a piece of the bark. The word "to blaze," in the sense of to noise abroad, comes from the A.-S. *Naesan*, to blow, cf. the Ger. *Blasen*; in sense, if not in origin, it is confused with "blazon" in heraldry.

BLAZON, a heraldic shield, a coat of arms properly "described" according to the rules of heraldry, hence a proper heraldic description of such a coat. The O. Fr. *blason* seems originally to have meant simply a shield as a means of defence and not a shield-shaped surface for the display of armorial bearings, but this is difficult to reconcile with the generally accepted derivation from the Ger. *blasen*, to blow, proclaim, English "blaze," to noise abroad, to declare. In the 16th century the heraldic term, and "blaze" and "blazon" in the sense of proclaim, had much influence on each other.

BLEACHING, the process of whitening or depriving objects of colour, an operation incessantly in activity in nature by the influence of light, air and moisture. The art of bleaching, of which we have here to treat, consists in inducing the rapid operation of whitening agencies, and as an industry it is mostly directed to cotton, linen, silk, wool and other textile fibres, but it is also applied to the whitening of paper-pulp, bees'-wax and some oils and other substances. The term bleaching is derived from the A.-S. *Naesan*, to bleach, or to fade, from which also comes the cognate German word *bleichen*, to whiten or render pale. Bleachers, down to the end of the 18th century, were known in England as "whitsters," a name obviously derived from the nature of their calling.

The operation of bleaching must from its very nature be of the same antiquity as the work of washing textures of linen,

cotton or other vegetable fibres. Clothing repeatedly washed, and exposed in the open air to dry, gradually assumes a whiter and whiter hue, and our ancestors cannot have failed to notice and take advantage of this fact. Scarcely anything is known with certainty of the art of bleaching as practised by the nations of antiquity. Egypt in early ages was the great centre of textile manufactures, and her white and coloured linens were in high repute among contemporary nations. As a uniformly well-bleached basis is necessary for the production of a satisfactory dye on cloth, it may be assumed that the Egyptians were fairly proficient in bleaching, and that still more so were the Phoenicians with their brilliant and famous purple dyes. We learn, from Pliny, that different plants, and likewise the ashes of plants, which no doubt contained alkali, were employed as detergents. He mentions particularly the *Struthium* as much used for bleaching in Greece, a plant which has been identified by some with *Gypsophila Struthium*. But as it does not appear from John Sibthorp's *Flora Graeca*, edited by Sir James Smith, that this species is a native of Greece, Dr Sibthorp's conjecture that the *Struthium* of the ancients was the *Saponaria officinalis*, a plant common in Greece, is certainly more probable.

In modern times, down to the middle of the 18th century, the Dutch possessed almost a monopoly of the bleaching trade although we find mention of bleach-works at Southwark near London as early as the middle of the 17th century. It was customary to send all the brown linen, then largely manufactured in Scotland, to Holland to be bleached. It was sent away in the month of March, and not returned till the end of October, being thus out of the hands of the merchant more than half a year.

The Dutch mode of bleaching, which was mostly conducted in the neighbourhood of Haarlem, was to steep the linen first in a waste lye, and then for about a week in a potash lye poured over it boiling hot. The cloth being taken out of this lye and washed, was next put into wooden vessels containing buttermilk, in which it lay under a pressure for five or six days. After this it was spread upon the grass, and kept wet for several months, exposed to the sunshine of summer.

In 1728 James Adair from Belfast proposed to the Scottish Board of Manufactures to establish a bleachfield in Galloway; this proposal the board approved of, and in the same year resolved to devote £2000 as premiums for the establishment of bleachfields throughout the country. In 1732 a method of bleaching with kelp, introduced by R. Holden, also from Ireland, was submitted to the board; and with their assistance Holden established a bleachfield for prosecuting his process at Pitkerro, near Dundee.

The bleaching process, as at that time performed, was very tedious, occupying a complete summer. It consisted in steeping the cloth in alkaline lyes for several days, washing it clean, and spreading it upon the grass for some weeks. The steeping in alkaline lyes, called *bucking*, and the bleaching on the grass, called *crofting*, were repeated alternately for five or six times. The cloth was then steeped for some days in sour milk, washed clean and crofted. These processes were repeated, diminishing every time the strength of the alkaline lye, till the linen had acquired the requisite whiteness.

For the first improvement in this tedious process, which was faithfully copied from the Dutch bleachfields, manufacturers were indebted to Dr Francis Home of Edinburgh, to whom the Board of Trustees paid £100 for his experiments in bleaching. He proposed to substitute water acidulated with sulphuric acid for the sour milk previously employed, a suggestion made in consequence of the new mode of preparing sulphuric acid, contrived some time before by Dr John Roebuck, which reduced the price of that acid to less than one-third of what it had formerly been. When this change was first adopted by the bleachers, there was the same outcry against its corrosive effects as arose when chlorine was substituted for crofting. A great advantage was found to result from the use of sulphuric acid, which was that a souring with sulphuric acid required at the longest only twenty-four hours, and often not more than twelve; whereas, when sour milk was employed, six weeks, or even two

months, were requisite, according to the state of the weather. In consequence of this improvement, the process of bleaching was shortened from eight months to four, which enabled the merchant to dispose of his goods so much the sooner, and consequently to trade with less capital.

No further modification of consequence was introduced in the art till the year 1787, when a most important change was initiated by the use of chlorine (*q.v.*), an element which had been discovered by C. W. Scheele in Sweden about thirteen years before. The discovery that this gas possesses the property of destroying vegetable colours, led Berthollet to suspect that it might be introduced with advantage into the art of bleaching, and that it would enable practical bleachers greatly to shorten their processes. In a paper on chlorine or oxygenated muriatic acid, read before the Academy of Sciences at Paris in April 1785, and published in the *Journal de Physique* for May of the same year (vol. xxvi. p. 325), he mentions that he had tried the effect of the gas in bleaching cloth, and found that it answered perfectly. This idea is still further developed in a paper on the same substance, published in the *Journal de Physique* for 1786. In 1786 he exhibited the experiment to James Watt, who, immediately upon his return to England, commenced a practical examination of the subject, and was accordingly the person who first introduced the new method of bleaching into Great Britain. We find from Watt's own testimony that chlorine was practically employed in the bleachfield of his father-in-law, Mr Macgregor, in the neighbourhood of Glasgow, in March 1787. Shortly thereafter the method was introduced at Aberdeen by Messrs Gordon, Barron & Co., on information received from De Saussure through Professor Patrick Copland of Aberdeen. Thomas Henry of Manchester was the first to bleach with chlorine in the Lancashire district, and to his independent investigations several of the early improvements in the application of the material were due.

In these early experiments, the bleacher had to make his own chlorine and the goods were bleached either by exposing them in chambers to the action of the gas or by steeping them in its aqueous solution. If we consider the inconveniences which must have arisen in working with such a pungent substance as free chlorine, with its detrimental effect on the health of the work-people, it will be readily understood that the process did not at first meet with any great amount of success. The first important improvement was the introduction in 1792 of *eau de Javel*, which was prepared at the Javel works near Paris by absorbing chlorine in a solution of potash (1 part) in water (8 parts) until effervescence began. The greatest impetus to the bleaching industry was, however, given by the introduction in 1799 of chloride of lime, or bleaching-powder, by Charles Tennant of Glasgow, whereby the bleacher was supplied with a reagent in solid form which contained up to one-third of its weight of available chlorine. Latterly frequent attempts have been made to replace bleaching-powder by hypochlorite of soda, which is prepared by the bleacher as required, by the electrolytic decomposition of a solution of common salt in specially constructed cells, but up to the present this mode of procedure has met with only a limited success (see ALKALI MANUFACTURE.).

Bleaching of Cotton.

Cotton is bleached in the raw state, as yarn and in the piece. In the raw state, and as yarn, the only impurities present are those which are naturally contained in the fibres and which include cotton wax; fatty acids, pectic substances, colouring matters, albuminoids and mineral matter, amounting in all to some 5% of the weight of the material. Both in the raw state and in the manufactured condition cotton also contains small black particles which adhere firmly to the material and are technically known as "motes." These consist of fragments of the cotton seed husk, which cannot be completely removed by mechanical means. The bleaching of cotton pieces is more complicated, since the bleacher is called upon to remove the sizing materials with which the manufacturer strengthens the warp before weaving (see below).

In principle, the bleaching of cotton is a comparatively simple process in which three main operations are involved, viz. (1) boiling with an alkali; (2) bleaching the organic colouring matters by means of a hypochlorite or some other oxidizing agent; (3) souring, *i.e.* treating with weak hydrochloric or sulphuric acid. For loose cotton and yarn these three operations are sufficient, but for piece goods a larger number of operations is usually necessary in order to obtain a satisfactory result.

Loose Cotton.—The bleaching of loose or raw cotton previous to spinning is only carried out to a very limited extent, and consists essentially in first steeping the material in a warm solution of soda for some hours, after which it is washed and treated with a solution of bleaching powder or sodium hypochlorite. It is then again washed, soured with weak sulphuric or hydrochloric acid, and ultimately washed free from acid. Careful treatment is necessary in order to avoid any undue matting of the fibres, while any drastic treatment, such as heating with caustic soda and soap, as used for other cotton materials, cannot be employed, since the natural wax would thereby be removed, and this would detract from the spinning qualities of the fibre. In case the cotton is not intended to be spun, but is to serve for cotton wool or for the manufacture of gun cotton, more drastic treatment can be employed, and is, in fact, desirable. Thus, cotton waste is first extracted with petroleum spirit or some other suitable solvent, in order to remove any mineral oil or grease which may be present. It is then boiled with dilute caustic soda and resin soap, washed, bleached white with bleaching-powder, washed, soured and finally washed free from acid. In these operations, a certain amount of matting is unavoidable, and it is consequently necessary to open out the material after drying, in scutchers.

Cotton Yarn.—Cotton yarn is bleached in the form of cops, hanks or warps. In principle the processes employed are the same in each case, but the machinery necessarily differs. Most yarn is bleached in the hank, and it will suffice to give an account of this process only. The sequence of operations is the same as in the bleaching of cotton waste, and these can be conducted for small lots in an ordinary rectangular wooden vat as used in dyeing, in which the yarn is suspended in the liquor from poles which rest with their ends on the two longer sides of the vat. For bleaching yarn in bulk, however, this mode of procedure would involve so much manual labour that the process would become too expensive. It is, therefore, mainly with the object of economy that machinery has been introduced, by means of which large quantities can be dealt with at a time.

The first operation, viz. that of boiling in alkali, is carried out in a "kier," a large, egg-ended, upright cylindrical vessel, constructed of boiler-plate and capable of treating from one to three tons of yarn at a time. In construction, the kiers used for yarn bleaching are similar in construction to those used for pieces (see below). The yarn to be bleached is evenly packed in the kier, and is then boiled by means of steam with the alkaline lye (3–4% of soda ash or 2% caustic soda on the weight of the cotton being usually employed) for periods varying from six to twelve hours. It is essential that a thorough circulation of the liquor should be maintained during the boiling, and this is effected either by means of a steam injector, or in other ways. As a rule low pressure kiers (working up to 10 lb pressure) are employed for yarn bleaching, though some bleachers prefer to use high pressure kiers for the purpose.

When the boiling has continued for the requisite time (6–8 hours), the steam is shut off, and the kier liquor blown off, when the yarn is washed in the kier by filling the latter with water and then running off, this operation being repeated two or three times. The hanks are now transferred to a stone cistern provided with a false bottom, from beneath which a pipe connects the cistern with a well situated below the floor line. The well contains a solution of bleaching-powder, usually of 2° Tw. strength, and this is drawn up by means of a centrifugal brass pump and showered over the top of the goods through a perforated wooden tray, passing on by gravitation through the goods back into the well. The circulation is maintained for one and a half to two hours, when the yarn will be found to be white. The bleaching-powder solution is now allowed to drain off, and water is circulated through the cistern to wash out what bleaching powder remains in the goods. The souring is next carried out either in the same or in a separate cistern by circulating hydrochloric or sulphuric acid of 2° Tw. for about half an hour. This is also allowed to drain, and the yarn is thoroughly washed to remove all acid, when it is taken out and wrung or hydroextracted. At this stage the yarn may be dyed in light or bright shades without further treatment, but if it is to be sold as white yarn, it is blued. The bluing may either be effected by dyeing or tinting with a colouring matter like Victoria blue 4R or acid violet, or by treatment in wash stocks with a suspension of ultramarine in weak soap until the colour is uniformly distributed throughout the material. The yarn is now straightened out and dried.

The bleaching of cotton yarn is a very straightforward process, and it is very seldom that either complications or faults arise, providing that reasonable care and supervision are exercised.

The *raison d'être* of the various operations is comparatively simple.

The effect of boiling with alkali is to remove the pectic acid, the fatty acids, part of the cotton wax and the bulk of the colouring matter, while the albuminoids are destroyed and the motes swelled up. If soap be used along with the alkali, the whole of the wax is removed by emulsification. In the operation of bleaching proper, the calcium hypochlorite of the chloride of lime through coming into contact with the carbonic acid of the atmosphere suffers decomposition according to the equation, $\text{Ca}(\text{OCl})_2 + \text{CO}_2 + \text{H}_2\text{O} \rightarrow \text{CaCO}_3 + 2\text{HOCl}$, and the hypochlorous acid thus liberated destroys the colouring matter still remaining from the first operation, by oxidation. At the same time the motes which were swelled up by the alkali are broken up into small fragments and are thus removed. In the operation of souring, the lime which has been deposited on the fibres during the treatment with bleaching powder is dissolved, while at the same time any other metallic oxides (iron, copper, &c.) are removed.

Cotton Pieces.—By far the largest bulk of cotton is bleached in the piece, as it can be more conveniently and more economically dealt with in this form than in any other. Though similar in principle to yarn bleaching, the process of piece bleaching is somewhat more complex because the pieces contain in addition to the natural impurities of the cotton a considerable amount of foreign matter in the form of size which has been incorporated with the warp before weaving, with the object of strengthening it. This size consists essentially of starch (*farina*), with additions of tallow, zinc chloride, and occasionally other substances such as paraffin wax, magnesium chloride, soap, &c., all of which must be removed if a perfect bleach is to result. Besides, mineral oil stains from the machinery of the weaving-shed are of common occurrence in piece goods.

Cotton pieces are bleached either for whites, for prints or for dyed goods. The processes employed for these different classes vary but slightly and only in detail. The most drastic bleach is that required for goods which are subsequently to be printed. For dyed goods, the main object is not so much to obtain a perfect white as to remove any impurities which might interfere with the dyeing, while avoiding the formation of any oxycellulose. In bleaching for whites ("market bleaching") it is essential that the white should be as perfect as possible, and such goods are consequently invariably blued after bleaching.

For small lots (1-20 pieces) the bleaching can be conducted on very simple machines. Thus many small piece dyers conduct the whole of their bleaching on the jigger, a simple form of dyeing machine on which most cotton piece goods are dyed (see DYEING). For muslins, laces and other very light fabrics, which will not stand rough handling, the operations are conducted mainly by hand, washing being effected in the dash-wheel (fig. 1), which consists of a cylindrical box, revolving on its axis. It has four divisions, as shown by the dotted lines, and an opening into each division. A number of pieces are put into each, abundance of water is admitted behind, and the knocking of the pieces as they alternately dash from one side of the division to the other during the revolution of the wheel effects the washing. The process lasts from four to six minutes.

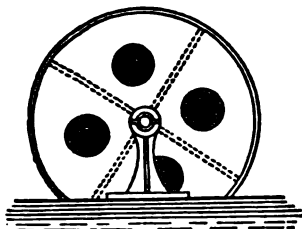

FIG. 1.—Section of a Dash-wheel.

For velveteens, corduroys, heavy drills, pocketings and other fabrics in which creasing has to be avoided as much as possible, the so-called "open bleach" is resorted to, which differs from the ordinary process chiefly in that the goods are treated throughout at full width.

The great bulk of cotton pieces is bleached in rope form, i.e. stitched together end to end and laterally collapsed, so that they will pass through a ring of 4 to 5 in. in diameter.

The first operation which the goods undergo on arriving in the grey-room of the bleachworks is that of stamping with tar or some other indelible material in order that they may be identified after passing through the whole process. They are then stitched together end to end by means of special sewing machines, the stitch being of such a nature (chain stitch) that the thread can be ripped out at one pull at the end of the operations.

Souring.—In the condition in which the pieces leave the loom and come into the hands of the bleacher, the surface of the fabric is seen to be covered with a nap of projecting fibres which gives it a downy appearance. For some classes of goods this is not a disadvantage, but in the majority of cases, especially for prints where a clean surface is essential, the nap is removed before bleaching. This is usually effected by running the pieces at full width over a couple of arched copper plates heated to a full red heat by direct fire. An arrangement of the kind is shown in fig. 2, in which the singe-plates, *a* and *b*, are mounted over the flues of a coal fire. The plate *b* is most highly heated, *a* being at the end of the flue farthest

removed from the fire. The cloth enters over a rail *A*, and in passing over the plate *a* is thoroughly dried and prepared for the singeing it receives when it comes to the highly-heated plate *b*. A block *d*, carrying two rails in the space between the plates, can be raised or lowered so as to increase or lessen the pressure of the cloth against the plates, or, if necessary, to lift it quite free of contact with them. The pieces on leaving the singeing machine are passed either through a water trough or through a steam box with the object of extinguishing sparks, and are then plaited down. The speed at

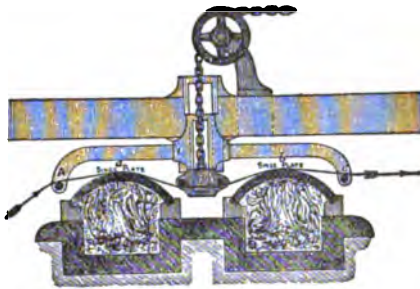

FIG. 2.—Section of Singe-stove.

which the pieces travel over the singe plates is necessarily considerable and varies with different classes of material.¹

In lieu of plates, a cast-iron cylinder is sometimes employed ("roller singeing"), the heating being effected by causing the flame of the fire to be drawn through the roller, which is carried on two small rollers at each end and revolves slowly in the reverse direction to that followed by the piece, thus exposing continuously a freshly heated surface and avoiding uneven cooling.

For figured pieces which have an uneven surface, it is obvious that plate or roller singeing would only affect the portions which project most, leaving the rest untouched. For such goods, "gas singeing" is employed, which consists in running the pieces over a non-luminous gas flame, the breadth of which slightly exceeds that of the piece, or in drawing the flame right through the piece.² The construction of an ordinary gas singeing apparatus is seen in section in fig. 3. Coal gas mixed with air is sent under pressure through pipe *a* into the burners *b, b*, where the mixture burns with an intense heat. The cloth travels in the direction of the arrows, and in passing over the small nap rollers *c* comes into contact with the flame four times in succession before leaving the machine.

Gas singeing is also used for plain goods, and being cleaner and under better control has largely replaced plate singeing.

At this stage the goods which have been browned on

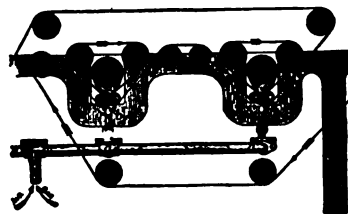

FIG. 3.—Gas Singeing Apparatus.

the surface by singeing are ready for the bleaching operations. A great many innovations have been introduced in recent years in the bleaching of calico, but although it is generally admitted that in point of view of time and economy many of these processes offer considerable advantages, the old process, in which a lime boil precedes the other operations is still the one which is most largely employed by bleachers in England. In this, the sequence of operations is the following—

Grey Washing.—This operation (which is sometimes omitted) simply consists in running the pieces through an ordinary washing machine (as shown in fig. 5) through water in order to wet them out. On leaving the machine they are piled in a heap and left over night, when fermentation sets in, which results in the starch being to a large extent hydrolysed and rendered soluble in water.

Lime Boil.—In this operation, which is also known as *bowking* (Ger. *beuchen*), the pieces are first run through milk of lime contained in an ordinary washing machine and of such a strength

¹ Besides being used for cotton goods, plate singeing is also employed for certain classes of worsted goods (alpaca, bunting, &c.), and for most union goods (cotton warp and worsted weft).

² A machine working on this principle has been constructed by F. Binder, and the makers of the machine (Messrs Mather & Platt, Ltd.) claim that it does better service than the machines constructed on the older principle.

that they take up about 4% of their weight of lime (CaO). They are then run over winches and guided through smooth porcelain rings ("pot-eyes") into the kier, where they are evenly packed by boys who enter the vessel through the manhole at the top. It is of the greatest importance that the goods should be evenly packed, for, if channels or loosely-packed places are left, the liquor circulating through the kier, when boiling is subsequently in progress, will follow the line of least resistance, and the result is an uneven treatment. Of the numerous forms of kier in use, the injector kier is the one most generally adopted. This consists of an egg-ended cylindrical vessel constructed of stout boiler plate and shown in sectional elevation in fig. 4. The kier is from 10 to 12 ft. in height and from 6 to 7 ft. in diameter, and stands on three iron legs riveted to the sides, but not shown in the figure. The bottom exit pipe E is covered with a shield-shaped false bottom of boiler plate, or (and this is more usual) the whole bottom of the kier is covered with large rounded stones from the river bed, the object in either case being simply to provide space for the accumulation of liquor and to prevent the pipe E being blocked. The cloth is evenly packed up to within about 3 to 4 ft. of the manholes M, when lime water is run in through the liquor pipe until the level of the liquid reaches within about 2 ft. of the top of the goods. The manholes are now closed, and steam is turned on at the injector J by opening the valve V. The effect of this is to suck the liquor through E, and to force it up through pipe P into the top of the kier, where it dashes against the umbrella-shaped shield U and is distributed over the pieces, through which it percolates, until on arriving at E it is again carried to the top of the kier, a continuous circulation being thus effected. As the circulation proceeds, the steam condensing in the liquor rapidly heats the latter to the boil, and as soon as, in the opinion of the foreman, all air has been expelled, the blow-through tap is closed and the boiling is continued for periods varying from six to twelve hours under 20-60 lb pressure. Steam is now turned off, and by opening the valve V the liquor, which is of a dark-brown colour, is forced out by the pressure of the steam it contains.

The pieces are now run through a continuous washing machine, which is provided with a plentiful supply of water. The machine,

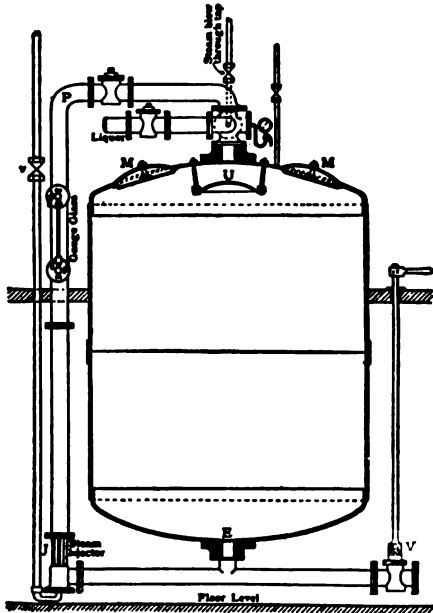

FIG. 4.—High Pressure Blow-through Kier.

which is shown in fig. 5, consists essentially of a wooden vat, over which there is a pair of heavy wooden (sycamore) bowls or squeezers. The pieces enter the machine at each end, as indicated by the arrows, and pass rapidly through the bowls down to the bottom of the vat over a loose roller, thence between the first pair of guide pegs through the bowls again, and travel thus in a spiral direction until they arrive at the middle of the machine, when they leave at the side opposite to that on which they entered. The same type of machine is used for liming, chemicking, and souring.

The next operation is the "grey sour," in which the goods are run through a washing machine containing hydrochloric acid of 2° Tw. strength, with the object of dissolving out the lime which the goods retain in considerable quantity after the lime boil. The goods are then well washed, and are now boiled again in the ash-bowking kier, which is similar in construction to the lime kier, with soda ash (3%) and a solution of rosin (1½%) in caustic soda (1½%)

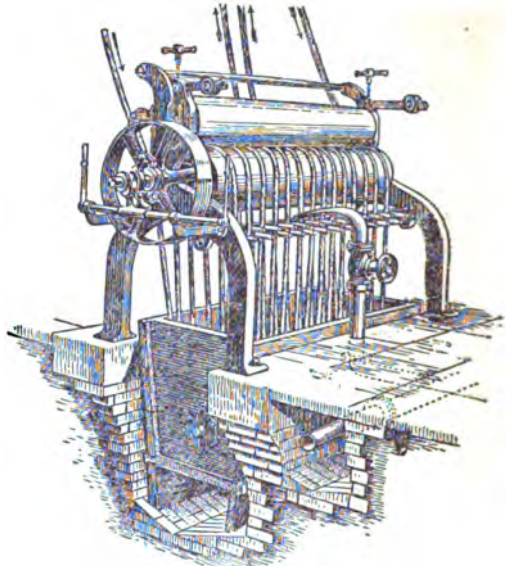

FIG. 5.—Roller Washing Machine.

for eight to ten hours. For white bleaching the rosin soap is omitted, soda ash alone being employed.

The pieces are now washed free from alkali and the bleaching proper or "chemicking" follows. This operation may be effected in various ways, but the most efficient is to run the goods in a washing machine through bleaching powder solution at ½-1° Tw., and allow them to lie loosely piled over night, or in some cases for a longer period. They are now washed, run through dilute sulphuric or hydrochloric acid at 2° Tw. ("white sour") and washed again. Should the white not appear satisfactory at this stage (and this is usually the case with very heavy or dense materials), they are boiled again in soda ash, chemicked with bleaching powder at ½-1° Tw. or even weaker, soured and washed. It is of the utmost importance that the final washing should be as thorough as possible, in order to completely remove the acid, for if only small quantities of the latter are left in the goods, they are liable to become tender in the subsequent drying, through formation of hydrocellulose.

The modern processes of bleaching cotton pieces differ from the one described above, chiefly in that the lime boil is entirely dispensed with, its place being taken by a treatment in the kier with caustic soda (or a mixture of caustic soda and soda ash) and resin soap. The best known and probably the most widely practised of these processes is one which was worked out by the late M. Horace Koehlin in conjunction with Sir William Mather, and this differs from the old process not only in the sequence of the operations but also in the construction of the kier. This consists of a horizontal egg-ended cylinder, and is shown in transverse and longitudinal sections in figs. 6 and 7. One of the ends E constitutes a door which can be raised or lowered by means of the power-driven chain C. The goods to be bleached are packed in wagons W outside the kier, and when filled these are pushed home into the kier, so that the pipes p fit with their flanges on to the fixed pipes at the bottom of the kier. The heating is effected by means of steam pipes at the lowest extremity of the kier, while the circulation of the liquor is brought about by means of the centrifugal pump P, which draws the liquor through the pipes p from beneath the false bottoms of the wagons and showers it over distributors D on to the goods. By this mode of working a considerable economy is effected in point of time, as the kier can be worked almost continuously; for as soon as one lot of goods has been boiled, the wagons are run out and two freshly-packed wagons take their place. The following is the sequence of operations:—The goods are first steeped over night in

dilute sulphuric acid, after which they are washed and run through old kier liquor from a previous operation. They are then packed evenly in the wagons which are pushed into the kier, and, the door having been closed, they are boiled for about eight hours at 7-15 lb pressure with a liquor containing soda ash, caustic soda, resin soap and a small quantity of sulphite of soda. The rest of the operations (chemicking, souring and washing) are the same as in the old process.

A somewhat different principle is involved in the Thies-Herzig process. In this the kier is vertical, and the circulation of the liquor is effected by means of a centrifugal or other form of pump, while the heating of the liquor is brought about outside the kier in a separate

The machine consists essentially of a series of copper or tinned iron cylinders, which are geared together so as to run at a uniform speed. Steam at 10-15 lb pressure is admitted through the journal bearings at one side of the machine, and the condensed water is forced out continuously through the bearings at the other side. The pieces pass in the direction of the arrow (fig. 9) over a scrimp rail or expanding roller round the first cylinder, then in a zigzag direction over all succeeding cylinders, and ultimately leave the machine dry, being mechanically plaited down at the other end.

If the bleaching process has been properly conducted, the pieces should not only show a uniform white colour, but their strength should remain unimpaired. Careful experiments conducted by the late Mr Charles O'Neill showed in fact that carefully bleached cotton may actually be stronger than in the unbleached condition, and this result has since been corroborated by others. Excessive blueing, which is frequently resorted to in order to cover the defects of imperfect bleaching, can readily be detected by washing a sample of the material in water, or, better still, in water containing a little ammonia, and then comparing with the original. The formation of oxycellulose during the bleaching process may either take place in boiling under pressure with lime or caustic soda in consequence of the presence of air in the kier, or through excessive action of bleaching powder, which may either result from the latter not being properly dissolved or being used too strong. Its detection may be effected by dyeing a sample of the bleached cotton in a cold, very dilute solution of methylene blue for about ten minutes, when any portions of the fabric in which the cellulose has been converted into oxycellulose will assume a darker colour than the rest. The depth of the colour is at the same time an indication of the extent to which such conversion has taken place. Most bleached cotton contains some oxycellulose, but as long as the formation has not proceeded far enough to cause tendering, its presence is of no importance in white goods. If, on the other hand, the cotton has to be subsequently dyed with direct cotton colours (see DYEING), the presence of oxycellulose may result in uneven dyeing. Tendering of the pieces, due to insufficient washing after the final souring operation, is a common defect in bleached goods. As a rule the free acid can be detected by extracting the tendered material with distilled water and adding to the extract a drop of methyl orange solution, when the latter will turn pink if free acid be present. Other defects which may occur in bleached goods are iron stains, mineral oil stains, and defects due to the addition of paraffin wax in the size.

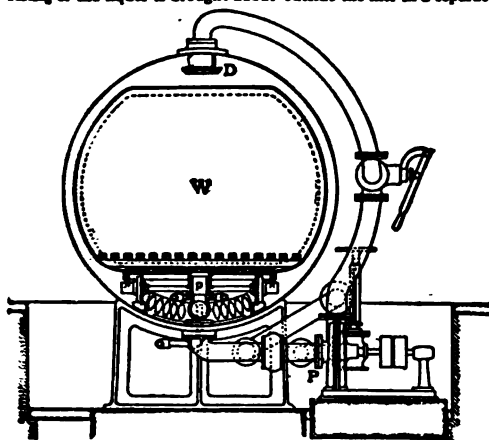

FIG. 6.—The Mather Kier, cross section.

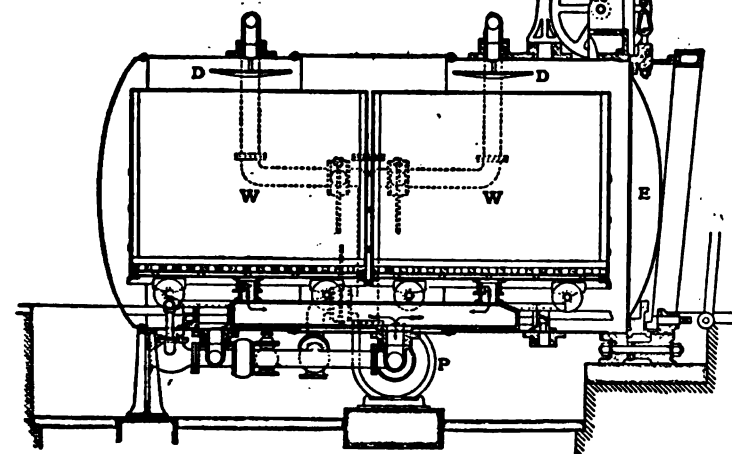

FIG. 7.—The Mather Kier, longitudinal section.

vessel between the pump and the kier by means of indirect steam. The sequence of operations is similar to that adopted in the Mather-Koschian process, differing chiefly from the latter in the first operation, which consists in running the goods, after singeing, through very dilute boiling sulphuric or hydrochloric acid, containing in either case a small proportion of hydrofluoric acid, and then running them through a steam box, the whole operation lasting from twenty to sixty seconds.

Bleached by any of the above processes, the cloth is next passed over a mechanical contrivance known as a "scutcher," which opens it out from the rope form to its full breadth, and is then dried on a continuous drying machine. Fig. 8 shows the appearance and construction of an improved form of the horizontal drying machine, which is in more common use for piece goods than the vertical form.

they do not usually exceed 5%. Furthermore these impurities, which include colouring matter, intracellular substances and a peculiar wax known as "flox wax," are more difficult to attack than those which are present in cotton, and the difficulty is still further enhanced in the case of piece goods owing to their dense or impervious character.

Till towards the end of the 18th century the bleaching of linen both in the north of Ireland and in Scotland was accomplished by bowking in cows' dung and souring with sour milk, the pieces being exposed to light on the grass between these operations for prolonged periods. Subsequently potash and later on soda

Bleaching of Linen.

The bleaching of linen is a much more complicated and tedious process than the bleaching of cotton. This is due in part to the fact that in linen the impurities amount to 20% or more of the weight of the fibre, whereas in cotton

was substituted for the cows' dung, while sour milk was replaced by sulphuric acid. This "natural bleach" is still in use in Holland, a higher price being paid for linen bleached in this way than for the same material bleached with the aid of bleaching powder. In the year 1744 Dr James Ferguson of Belfast received a premium of £300 from the Irish Linen Board for the application of lime in the bleaching of linen. Notwithstanding this reward,

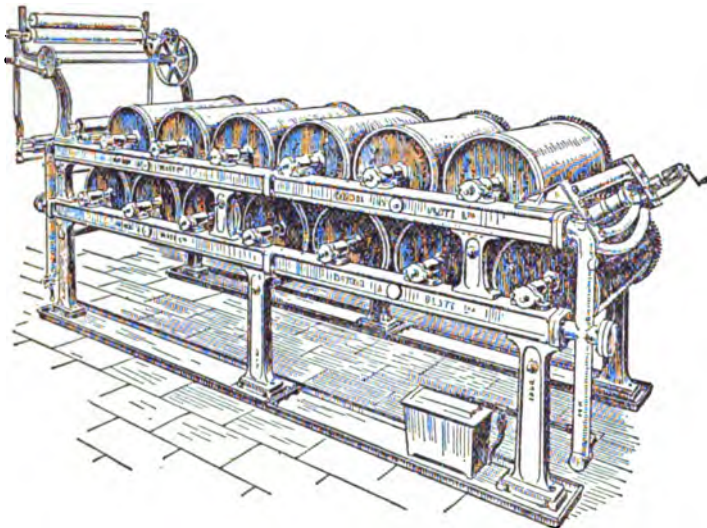

FIG. 8.—Mather & Platt's Horizontal Drying Machine.

the use of lime in the bleaching of linen was for a long time afterwards forbidden in Ireland under statutory penalties, and so late as 1815 Mr Barklie, a respectable linen bleacher of Linen Vale, near Keady, was "prosecuted for using lime in the whitening of linens in his bleachyard."

The methods at present employed for the bleaching of linen are, except in one or two unimportant particulars, the same as were used in the middle of the 19th century. In principle they resemble those used in cotton bleaching, but require to be frequently repeated, while an additional operation, which is a relic of the old-fashioned process, viz. that of "grassing" or "crofting," is still essential for the production of the finest whites. Considerably more care has to be exercised in linen bleaching than is the case with cotton, and the process consequently necessitates a greater amount of manual labour. The practical result of this is that whereas cotton pieces can be bleached and finished in less than a week, linen pieces require at least six weeks. Many attempts have naturally been made to shorten and cheapen the process, but without success. The use of stronger reagents and more drastic treatment, which would at first suggest itself, incurs the risk of injury to the fibre, not so much in respect to actual tendering as to the destruction of its characteristic gloss, while if too drastic a treatment is employed at the beginning the colouring matter is liable to become set in the fibre, and it is then almost impossible to remove it. Among the many modern improvements which have been suggested, mention may be made of the use of hypochlorite of soda in place of bleaching powder, the use of oil in the first treatment in alkali (Cross & Parkes), while de Keukelaere suggests the use of sodium sulphide for this purpose. With the object of dispensing with the operation of grassing, which besides necessitating much manual labour is subject to the influences of the atmospheric conditions, Siemens & Halske of Berlin have suggested exposure of the goods in a chamber to the action of electrolytically prepared ozone. Jardin seeks to achieve the same object by steeping the linen in dilute nitric acid.

Since the qualities of linen which are submitted to the bleacher vary considerably, and the mode of treatment has to be varied accordingly, it is not possible to give more than a bare outline of linen bleaching.

Linen is bleached in the yarn and in the piece. Whenever one of the operations is repeated, the strength of the reagent is successively diminished. In yarn-bleaching the sequence of the operations is about as follows:—(1) Boil in kier with soda ash. (2) Reel in bleaching powder. This operation, which is peculiar to linen bleaching, consists in suspending the hanks from a square roller into bleaching powder solution contained in a shallow stone trough. The roller revolves slowly, so that the hanks, while passing continuously through the bleaching powder, are for the greater part of the time being exposed to the air. (3) Sour in sulphuric acid. (4) Scald in soda ash. (The term "scalding" means boiling in a kier.) (5) Reel in bleaching powder. (6) Sour in sulphuric acid. (7) Scald in soda ash. (8) Dip, i.e. steep in bleaching powder. (9) Sour in sulphuric acid. (10) Scald in soda ash. (11) Dip in bleaching powder. (12) Sour in sulphuric acid. For a full white, two more operations are usually required, viz. (13) scald in soda ash, and (14) dip in bleaching powder. Washing intervenes between all these operations.

Pieces are not stamped as in the case of cotton, but thread-marked by hand with cotton dyed Turkey red. They are then sewn together end to end, and subjected to the following operations:—

Boil with lime in kier.

The pieces are now separated and made up into bundles (except in the case of very light linens, which may pass through the whole of the operations in rope form) and soured with sulphuric acid.

First lye boil with soda ash and caustic soda.

Second lye boil. For some classes of goods no less than six lye boils may be required.

Grass between lye boils (according to their number). Rub with rubbing boards. This is also a speciality in linen bleaching, and consists of a mechanical treatment with soft soap, the object of which is to remove black stains in the yarn.

Bleach with hypochlorite of soda.

Scald. The two latter treatments are repeated three to five times, each series constituting a "turn." Grassing intervenes between each turn, and in some instances the pieces are rubbed before the last soda boil.

The pieces are next steeped in large vessels (kiers) in weak hypo-

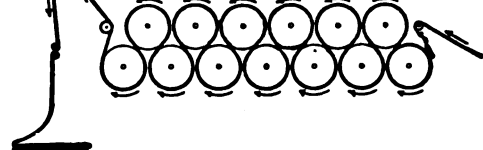

FIG. 9.—Diagram showing the Horizontal Drying Machine threaded with Cloth.

chlorite of soda, and then in weak sulphuric acid, these treatments being repeated several times.

Ultimately the goods are mill-washed, blued with smalt and dried.

Bleaching of other Vegetable Textile Fabrics.

Hemp may be bleached by a process similar to that used for linen, but this is seldom done owing to the expense entailed. *China grass* is bleached like cotton. *Jute* contains in its raw state a considerable amount of colouring matter and intracellular substance. Since the individual fibres are very short, the

complete removal of the latter would be attended by a disintegration of the material. Although it is possible to bleach jute white, this is seldom if ever carried out on a large scale owing to the great expense involved. A half-bleach on jute is obtained by steeping the goods alternately in bleaching powder (or hypochlorite of soda) and sulphuric acid, washing intervening. For a cream these treatments are repeated.

Bleaching of Straw.

In the Luton district, straw is bleached principally in the form of plait, in which form it is imported. The bleaching is effected by steeping the straw for periods varying from twelve hours to several days in fairly strong alkaline peroxide of hydrogen. The number of baths depends upon the quality of straw and the degree of whiteness required. Good whites are thus obtained, and no further process would be necessary if the hats had not subsequently to be "blocked" or pressed at a high temperature which brings about a deterioration of the colour. After bleaching with peroxide and drying, the straw consequently undergoes a further process of sulphuring, i.e. exposure to gaseous sulphurous acid. Panama hats are bleached after making up, but in this case only peroxide of hydrogen is used and a very lengthy treatment entailing sometimes fourteen days' steeping is required.

Bleaching of Wool.

In the condition in which it is delivered to the manufacturers wool is generally a very impure article, even if it has been washed on the sheep's back before shearing. The impurities which it contains consist in the main of the natural grease (in reality a kind of wax) exuded from the skin of the sheep and technically known as the "yolk," the dried-up perspiration from the body of the sheep, technically called "suint," and dust, dirt, burrs, &c., which mechanically adhere to the sticky surfaces of the fibres. In this condition wool is quite unfit for any manufacturing purposes and must be cleansed before any mechanical operations can be commenced. Formerly the washing was effected in stale urine, which owed its detergent properties mainly to the presence of ammonium carbonate. The stale urine or *lami* was diluted with four to five times its bulk of water, and in this liquor, heated to 40°-50° C., the washing was effected.

At the present day this method has been entirely abandoned, the washing or "scouring" being effected with soap, assisted by ammonia, potash, soda or silicate of soda. The finest qualities of wool are washed with soft soap and potash, while for inferior qualities, cheaper detergents are employed. The operation is in principle perfectly simple, the wool being submerged in the warm soap solution, where it is moved about with forks and then taken out and allowed to drain. A second treatment in weaker soap serves to complete the process. In dealing with large quantities, wool-washing machines are employed, which consist essentially of long cast-iron troughs which contain the soap solution. The wool to be washed is fed in at one end of the machine and is slowly propelled to the other end by means of a system of mechanically-driven forks or rakes. As it passes from the machine, it is squeezed through a pair of rollers. Three such machines are usually required for efficient washing, the first containing the strongest and the third the weakest soap.

The washing of wool is in the main a mechanical process, in which the water dissolves out the suint while the soap emulsifies the yolk and thus removes it from the fibre. The attendant earthy impurities pass mechanically into the surrounding liquid and are swilled away.

In some works the wool is washed first with water alone, the aqueous extract thus obtained being evaporated to dryness and the residue calcined. A very good quality of potash is thus obtained as a by-product. In many works in Yorkshire and elsewhere, the dirty soap liquors obtained in wool-washing are not allowed to run to waste, but are run into tanks and there treated with sulphuric acid. The effect of this treatment is to decompose the soap, and the fatty acids along with the wool-grease rise as a magma to the surface. The purified product is known in the trade as "Yorkshire grease."

Attempts have been made from time to time to extract the natural grease from wool by means of organic solvents, such as carbon bisulphide, carbon tetrachloride, petroleum spirit, &c., but have not met with much success.

Worsted yarn spun on the English system, as well as woollen yarn and fabrics made from them, contain oil which has been incorporated with the wool to facilitate the spinning. This oil must be got rid of previous to bleaching, and this is effected by scouring in warm soap with or without the assistance of alkalis.

The actual bleaching of wool may be effected in two ways, viz. by treating the material either with sulphurous acid or with hydrogen peroxide. Sulphurous acid may either be applied in the gaseous form or in solution as bisulphite of soda. In working by the first method, which is technically known as "stoving," the scoured yarn is wetted in very weak soap containing a small amount of blue colouring matter, wrung or hydro-extracted and then suspended in a chamber or stove. Sulphur contained in a vessel on the floor of the chamber is now lighted, and the door having been closed, is allowed to burn itself out. The goods are left thus exposed to the sulphur dioxide overnight, when they are taken out and washed in water. For piece goods a somewhat different arrangement is employed, the pieces passing through a slit into a chamber supplied with sulphur dioxide, then slowly up and down over a large number of rollers and ultimately emerging again at the same slit. Wool may also be bleached by steeping in a fairly strong solution of bisulphite of soda and then washing well in water. Wool bleached with sulphurous acid or bisulphite is readily affected by alkalis, the natural yellow colour returning on washing with soap or soda. A more permanent bleach is obtained by steeping the wool in hydrogen peroxide (of 12 volumes strength), let down with about three times its bulk of water and rendered slightly alkaline with ammonia or silicate of soda. Black or brown wools cannot be bleached white, but when treated with peroxide they assume a golden colour, a change which is frequently desired in human hair.

Bleaching of Silk.

In raw silk, the fibre proper is uniformly coated with a proteid substance known as *silk-gum*, *silk-gluce* or *sericine* which amounts to 10-25% of the weight of the material, and it is only after the removal of this coating that the characteristic properties of the fibre become apparent. This is effected by the process of "discharging" or "boiling-off," which consists in suspending the hanks of raw silk over poles or sticks in a vat containing a strong hot soap solution (30% of soap on the weight of the silk). The liquor is kept just below boiling point for two or three hours, the hanks being turned from time to time. During the process, the sericine at first swells up considerably, the fibres becoming slippery, but as the operation proceeds it passes into solution. It is important that only soft water should be used for boiling-off since calcareous impurities are liable to mar the lustre of the silk.

The silk is now rinsed in weak soda solution and wrung. In this condition it is suitable for being dyed, but if it is to be bleached, the hanks are tied up loosely with smooth tape, put into coarse linen bags to prevent the silk becoming entangled, and boiled again in soap solution which is half as strong as that used in the first operation. The hanks are now taken out, rinsed in a weak soda solution, washed in water and wrung.

The actual bleaching of silk is usually effected by stoving as in the case of wool, with this difference, that the operation is repeated several times and bleuing or tinting with other colours is effected after bleaching. Silk may also be bleached with peroxide of hydrogen, but this method is only used for certain qualities of spun silk and for tussore.

Ornamental feathers are best bleached by steeping in peroxide of hydrogen, rendered slightly alkaline by the addition of ammonia. The same treatment is applied to the bleaching of *ibory*. If peroxide of hydrogen could be prepared at a moderate cost, it would doubtless find a much more extensive application in bleaching, since it combines efficiency with safety, and gives good results with both vegetable and animal substances. (E. K.)

BLEAK, or **BLICK** (*Alburnus lucidus*), a small fish of the Cyprinid family, allied to the bream and the minnow, but with a more elongate body, resembling a sardine. It is found in European streams, and is caught by anglers, being also a favourite in aquariums. The well-known and important industry of "Essence Orientale" and artificial pearls, carried on in France and Germany with the crystalline silvery colouring matter of

the bleek, was introduced from China about the middle of the 17th century.

BLEEK, FRIEDRICH (1793–1859), German Biblical scholar, was born on the 4th of July 1793, at Ahrensböck, in Holstein, a village near Lübeck. His father sent him in his sixteenth year to the gymnasium at Lübeck, where he became so much interested in ancient languages that he abandoned his idea of a legal career and resolved to devote himself to the study of theology. After spending some time at the university of Kiel, he went to Berlin, where, from 1814 to 1817, he studied under De Wette, Neander and Schleiermacher. So highly were his merits appreciated by his professors—Schleiermacher was accustomed to say that he possessed a special *charisma* for the science of "Introduction"—that in 1818 after he had passed the examinations for entering the ministry he was recalled to Berlin as *Repetent* or tutorial fellow in theology, a temporary post which the theological faculty had obtained for him. Besides discharging his duties in the theological seminary, he published two dissertations in Schleiermacher's and G. C. F. Lücke's *Journal* (1819–1820, 1822), one on the origin and composition of the Sibylline Oracles "Über die Entstehung und Zusammensetzung der Sibyllinischen Orakel," and another on the authorship and design of the Book of Daniel, "Über Verfasser und Zweck des Buches Daniel." These articles attracted much attention, and were distinguished by those qualities of solid learning, thorough investigation and candour of judgment which characterized all his writings. Bleek's merits as a rising scholar were recognized by the minister of public instruction, who continued his stipend as *Repetent* for a third year, and promised further advancement in due time. But the attitude of the political authority underwent a change. De Wette was dismissed from his professorship in 1819, and Bleek, a favourite pupil, incurred the suspicion of the government as an extreme democrat. Not only was his stipend as *Repetent* discontinued, but his nomination to the office of professor extraordinarius, which had already been signed by the minister Karl Altenstein, was withheld. At length it was found that Bleek had been confounded with a certain Baueleven Blech, and in 1823 he received the appointment.

During the six years that Bleek remained at Berlin, he twice declined a call to the office of professor ordinarius of theology, once to Greifswald and once to Königsberg. In 1829, however, he was induced to accept Lücke's chair in the recently-founded university of Bonn, and entered upon his duties there in the summer of the same year. For thirty years he laboured with ever-increasing success, due not to any attractions of manner or to the enunciation of novel or bizarre opinions, but to the soundness of his investigations, the impartiality of his judgments, and the clearness of his method. In 1843 he was raised to the office of consistorial councillor, and was selected by the university to hold the office of rector, a distinction which has not since been conferred upon any theologian of the Reformed Church. He died suddenly of apoplexy on the 27th of February 1859.

Bleek's works belong entirely to the departments of Biblical criticism and exegesis. His views on questions of Old Testament criticism were "advanced" in his own day; for on all the disputed points concerning the unity and authorship of the books of the Old Covenant he was opposed to received opinion. But with respect to the New Testament his position was conservative. An opponent of the Tübingen school, his defence of the genuineness and authenticity of the gospel of St John is among the ablest that have been written; and although on some minor points his views did not altogether coincide with those of the traditional school, his critical labours on the New Testament must nevertheless be regarded as among the most important contributions to the maintenance of orthodox opinions. His greatest work, his commentary on the epistle to the Hebrews (*Brief an die Hebräer erläutert durch Einleitung, Übersetzung, und fortlaufenden Commentar*, in three parts, 1828, 1836 and 1840) won the highest praise from men like De Wette and Fr. Delitzsch. This work was abridged by Bleek for his college lectures, and was published in that condensed form in

1848. In 1846 he published his contributions to the criticism of the gospels (*Beiträge zur Evangelien Kritik*, pt. i.), which contained his defence of St John's gospel, and arose out of a review of J. H. A. Ebrard's *Wissenschaftliche Kritik der Evangelischen Geschichte* (1842).

After his death were published:—(1) His *Introduction to the Old Testament (Einleitung in das Alte Testament)*, (3rd ed., 1869); Eng. trans. by G. H. Venables (from 2nd ed., 1869); in 1878 a new edition (the 4th) appeared under the editorship of J. Wellhausen, who made extensive alterations and additions; (2) his *Introduction to the New Testament* (3rd ed., W. Mangold, 1875); Eng. trans. (from 2nd German ed.) by William Urwick (1869, 1870); (3) his *Exposition of the First Three Gospels (Synoptische Erklärung der drei ersten Evangelien)*, by H. Holtzmann (1862); (4) his *Lectures on the Apocalypse (Vorlesungen über die Apokalypse)*, (Eng. trans. 1875). Besides these there has also appeared a small volume containing *Lectures on Colossians, Philemon and Ephesians* (Berlin, 1865). Bleek also contributed many articles to the *Studien und Kritiken*. For further information as to Bleek's life and writings, see Kamphausen's article in Herzog-Hauck, *Realencyclopädie*; Frédéric Lichtenberger's *Histoire des idées religieuses en Allemagne*, vol. iii.; Dietzel's *Geschichte des Alten Testaments* (1869); and T. K. Cheyne's *Founders of Old Testament Criticism* (1893).

BLEEK, WILHELM HEINRICH IMMANUEL (1827–1875), German philologist, son of Friedrich Bleek, was born in 1827 at Berlin. He studied first at Bonn and afterwards at Berlin, where his attention was directed towards the philological peculiarities of the South African languages. In his doctor's dissertation (Bonn, 1851), *De nominum generibus linguarum Africae Australis*, he endeavoured to show that the Hottentot language was of North African descent. In 1854 his health prevented him accompanying Dr W. B. Baikie in the expedition to the Niger; but in the following year he accompanied Bishop Colenso to Natal, and was enabled to prosecute his researches into the language and customs of the Kaffirs. Towards the close of 1856 he settled at Cape Town, and in 1857 was appointed interpreter by Sir George Grey. In 1859 he was compelled by ill-health to visit Europe, and on his return in the following year he was made librarian of the valuable collection of books presented to the colony by Sir George Grey. In 1869 he visited England, where the value of his services was recognized by a pension from the civil list. He died at Cape Town on the 17th of August 1875. His works, which are of considerable importance for African and Australian philology, consist of the *Vocabulary of the Mozambique Language* (London, 1856); *Handbook of African, Australian and Polynesian Philology* (Cape Town and London, 3 vols., 1858–1863); *Comparative Grammar of the South African Languages* (vol. 1., London, 1869); *Reynard the Fox in South Africa, or Hottentot Fables and Tales* (London, 1864); *Origin of Language* (London, 1869).

BLENDE, or SPHALERITE, a naturally occurring zinc sulphide, ZnS, and an important ore of zinc. The name blende was used by G. Agricola in 1546, and is from the German *blenden*, to blind, or deceive, because the mineral resembles lead-ore in appearance but contains no lead, and was consequently often rejected as worthless. Sphalerite, introduced by E. F. Glocker in 1847, has the same meaning (Gr. *σφαλερός*, deceptive), and so have the miners' terms "mock ore," "false lead," and "black jack." The term "blende" was at one time used in a generic sense, and as such enters into the construction of several old names of German origin; the species under consideration is therefore sometimes distinguished as zinc-blende.

Crystals of blende belong to that subclass of the cubic system in which there are six planes of symmetry parallel to the faces of the rhombic dodecahedron and none parallel to the cubic faces; in other words, the crystals are cubic with inclined hemihedrism, and have no centre of symmetry. The fundamental form is the tetrahedron. Fig. 1 shows a combination of two tetrahedra, in which the four faces of one tetrahedron are larger than the four faces of the other; further, the two sets of faces differ in surface

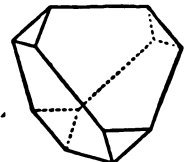

FIG. 1.

characters, those of one set being dull and striated, whilst those of the other set are bright and smooth. A common form, shown in fig. 2, is a combination of the rhombic dodecahedron with a three-faced tetrahedron y (311); the six faces meeting in each triad axis are often rounded together into low conical forms. The crystals are frequently twinned, the twin-axis coinciding with a triad axis; a rhombic dodecahedron so twinned (fig. 3) has no re-entrant angles. An important character of blende is the perfect dodecahedral cleavage, there being six directions of cleavage parallel to the faces of the rhombic dodecahedron, and angles between which are 60° .

When chemically pure, which is rarely the case, blende is colourless and transparent; usually, however, the mineral is yellow, brown or black, and often opaque, the depth of colour and degree of transparency depending on the amount of iron present. The streak, or colour of the powder, is brownish or light yellow, rarely white. The lustre is resinous to adamantine, and the index of refraction high (2.369 for sodium light). The substance is usually optically isotropic, though sometimes it exhibits anomalous double refraction; fibrous zinc sulphide which is doubly refracting is to be referred to the hexagonal

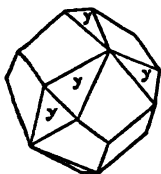

FIG. 2.

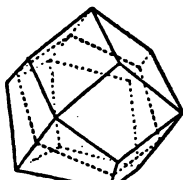

FIG. 3.

species wurtzite. The specific gravity is 4.0, and the hardness 4. Crystals exhibit pyroelectrical characters, since they possess four uniterminal triad axes of symmetry.

Crystals of blende are of very common occurrence, but owing to twinning and distortion and curvature of the faces, they are often rather complex and difficult to decipher. For this reason the mineral is not always readily recognized by inspection, though the perfect dodecahedral cleavage, the adamantine lustre, and the brown streak are characters which may be relied upon. The mineral is also frequently found massive, with a coarse or fine granular structure and a crystalline fracture; sometimes it occurs as a soft, white, amorphous deposit resembling artificially precipitated zinc sulphide. A compact variety of a pale liver-brown colour and forming concentric layers with a reniform surface is known in Germany as *Schalen-Blende* or *Leberblende*.

A few varieties of blende are distinguished by special names, these varieties depending on differences in colour and chemical composition. A pure white blende from Franklin in New Jersey is known as cleiophane; snow-white crystals are also found at Nordmark in Vermland, Sweden. Black blende containing ferrous sulphide, in amounts up to 15 or 20% isomorphously replacing zinc sulphide, is known as marmatite (from Marmato near Guayabal in Colombia, South America) and christophite (from St Christoph mine at Breitenbrunn near Eibenstock in Saxony). Transparent blende of a red or reddish-brown colour, such as that found near Holywell in Flintshire, is known as "ruby-blende" or "ruby-zinc." Phibramite is the name given to a cadmiferous blende from Phibram in Bohemia. Other varieties contain small amounts of mercury, tin, manganese or thallium. The elements gallium and indium were discovered in blende.

Blende occurs in metalliferous veins, often in association with galena, also with chalcopyrite, barytes, fluor spar, &c. In ore-deposits containing both lead and zinc, such as those filling cavities in the limestones of the north of England and of Missouri, the galena is usually found in the upper part of the deposit, the blende not being reached until the deeper parts are worked.

Blende is also found sporadically in sedimentary rocks; for example, in nodules of clay-ironstone in the Coal Measures, in the cement-doggers of the Lias, and in the casts of fossil shells. It has occasionally been found on the old timbers of mines. In these cases the zinc sulphide has probably arisen from the reduction of sulphate by organic matter.

Localities for fine crystallized specimens are numerous. Mention may be made of the brilliant black crystals from Alston Moor in Cumberland; St Agnes in Cornwall and Derbyshire. Yellow crystals are found at Kapnik-Bánya, near Nagy-Bánya in Hungary. Transparent yellow cleavage masses of large size occur in limestone in the zinc mines at Picos de Europa in the province of Santander, Spain. Beautiful isolated tetrahedra of transparent yellow blende are found in the snow-white crystalline dolomite of the Binnenthal in the Valais, Switzerland. (L. J. S.)

BLENHEIM (Ger. *Blindheim*), a village of Bavaria, Germany, in the district of Swabia, on the left bank of the Danube, 30 m. N.E. from Ulm by rail, a few miles below Höchstädt. Pop. 700. It was the scene of the defeat of the French and Bavarians under Marshals Tallard and Marsin, on the 13th of August 1704, by the English and the Austrians under the duke of Marlborough and Prince Eugene. In consideration of his military services and especially his decisive victory, a princely mansion was erected by parliament for the duke of Marlborough near Woodstock in Oxfordshire, England, and was named Blenheim Palace after this place.

The battle of Blenheim is also called Höchstädt, but the title accepted in England has the advantage that it distinguishes this battle from that won on the same ground a year previously, by the elector of Bavaria over the imperial general Styrum (9-20 September 1703), and from the fighting between the Austrians under Krag and the French under Moreau in June 1800 (see FRENCH REVOLUTIONARY WARS). The ground between the hills and the marshy valley of the Danube forms a defile through which the main road from Donauwörth led to Ulm; parallel streams divide the narrow plain into strips. On one of these streams, the Nebel, the French and Bavarians (somewhat superior in numbers) took up their position facing eastward, their right flank resting on the Danube, their left in the under-features of the hilly ground, and their front covered by the Nebel, on which were the villages of Oberglau, Unterglau and Blenheim. The imperialist army of Eugene and the allies under Marlborough (52,000 strong) encamped 5 m. to the eastward along another stream, their flanks similarly protected. On the 2nd-13th of August 1704 Eugene and Marlborough set their forces in motion towards the hostile camps; several streams had to be crossed on the march, and it was seven o'clock (five hours after moving off) when the British of Marlborough's left wing, next the Danube, deployed opposite Blenheim, which Tallard thereupon garrisoned with a large force of his best infantry, aided by a battery of 24-pounder guns. The French and Bavarians were taken somewhat by surprise, and were arrayed in two separate armies, each with its cavalry on the wings and its foot in the centre. Thus the centre of the combined forces consisted of the cavalry of Marsin's right and of Tallard's left.

Here was the only good ground for mounted troops, and Marlborough followed Tallard's example when forming up to attack, but it resulted from the dispositions of the French marshal that this weak point of junction of his two armies was exactly that at which decisive action was to be expected. Tallard therefore had a few horse on his right between the Danube and Blenheim, a mass of infantry in his centre at Blenheim itself, and a long line of cavalry supported by a few battalions forming his left wing in the plain, and connecting with the right of Marsin's army. This army was similarly drawn up. The cavalry right wing was in the open, the French infantry near Oberglau, which was strongly held, the Bavarian infantry next on the left, and finally the Bavarian cavalry with a force of foot on the extreme left in the hills. The elector of Bavaria commanded his own troops in person. Marlborough and Eugene on their part were to attack respectively Tallard and Marsin. The

right wing under Eugene had to make a difficult march over broken ground before it could form up for battle, and Marlborough waited, with his army in order of battle between Unterglau and Blenheim, until his colleague should be ready. At 12.30 the battle opened. Lord Cutts, with a detachment of Marlborough's left wing, attacked Blenheim with the utmost fury. A third of the leading brigade (British) was killed and wounded in the vain attempt to break through the strong defences of the village, and some French squadrons charged upon it as it retired; a colour was captured in the *mêlée*, but a Hessian brigade in second line drove back the cavalry and retook the colour. After the repulse of these squadrons, in which some British cavalry from the centre took part, Cutts again moved forward. The second attack, though pressed even more fiercely, fared no better than the first, and the losses were heavier than before. The duke then ordered Cutts to observe the enemy in Blenheim, and concentrated all his attention on the centre. Here, between Unterglau and Blenheim, preparations were being made, under cover of artillery, for the crossing of the Nebel, and farther up-stream a corps was sent to attack Oberglau. This attack failed completely, and it was not until Marlborough himself, with fresh battalions, drove the French back into Oberglau that the allies were free to cross the Nebel.

In the meanwhile the first line of Marlborough's infantry had crossed lower down, and the first line of cavalry, following them across, had been somewhat severely handled by Tallard's cavalry. The squadrons under the Prussian general Bothmar, however, made a dashing charge, and achieved considerable temporary success. Eugene was now closely engaged with the elector of Bavaria, and both sides were losing heavily. But Eugene carried out his holding attack successfully. Marsin dared not reinforce Tallard to any extent, and the duke was preparing for the grand attack. His whole force, except the detachment of Cutts, was now across the Nebel, and he had formed it in several lines with the cavalry in front. Marlborough himself led the cavalry; the French squadrons received the attack at the halt, and were soon broken. Marsin's right swung back towards its own army. Those squadrons of Tallard's left which retained their order fell back towards the Danube, and a great gap was opened in the centre of the defence, through which the victorious squadrons poured. Wheeling to their left the pursuers drove hundreds of fugitives into the Danube, and Eugene was now pressing the army of Marsin towards Marlborough, who re-formed and faced northward to cut off its retreat. Tallard was already a prisoner, but in the dusk and confusion Marsin slipped through between the duke and Eugene. General Churchill, Marlborough's brother, had meanwhile surrounded the French garrison of Blenheim; and after one or two attempts to break out, twenty-four battalions of infantry and four regiments of dragoons, many of them the finest of the French army, surrendered.

The losses of the allies are stated at 4500 killed and 7500 wounded (British 670 killed and 1500 wounded). Of the French and Bavarians 11,000 men, 100 guns and 200 colours and standards were taken; besides the killed and wounded, the numbers of which were large but uncertain—many were drowned in the Danube. Marsin's army, though it lost heavily, was drawn off in good order; Tallard's was almost annihilated.

BLANNERHASSETT, HARMAN (1765-1831), Irish-American lawyer, son of an Irish country gentleman of English stock settled in Co. Kerry, was born on the 8th of October 1765. He was educated at Trinity College, Dublin, and in 1790 was called to the Irish bar. After living for several years on the continent, he married in 1796 his niece, Margaret Agnew, daughter of Robert Agnew, the lieutenant-governor of the Isle of Man. Ostracised by their families for this step the couple decided to settle in America, where Blennerhassett in 1798 bought an island in the Ohio river about 2 m. below Parkersburg, West Virginia. Here in 1805 he received a visit from Aaron Burr (*q.v.*), in whose conspiracy he became interested, furnishing liberal funds for its support, and offering the use of his island as a rendezvous for the gathering of arms and supplies and the training of volunteers. When the conspiracy collapsed, the mansion and

island were occupied and plundered by the Virginia militia. Blennerhassett fled, was twice arrested and remained a prisoner until after Burr's release. The island was then abandoned, and Blennerhassett was in turn a cotton planter in Mississippi, and a lawyer (1819-1822) in Montreal, Canada. After returning to Ireland, he died in the island of Guernsey on the 2nd of February 1831. His wife, who had considerable literary talent and who published *The Deserted Isle* (1822) and *The Widow of the Rock and Other Poems* (1824), returned to the United States in 1840, and died soon afterward in New York City while attempting to obtain through Congress payment for property destroyed on the island.

See William H. Safford, *Life of Harman Blennerhassett* (Cincinnati, 1853); W. H. Safford (editor), *The Blennerhassett Papers* (Cincinnati, 1864); and "The True Story of Harman Blennerhassett," by Therese Blennerhassett-Adams, in the *Century Magazine* for July 1901, vol. liii.

BLERA (mod. *Bleda*), an ancient Etruscan town on the Via Clodia, about 32 m. N.N.W. of Rome. It was of little importance, and is only mentioned by geographers and in inscriptions. It is situated on a long, narrow tongue of rock at the junction of two deep glens. Some remains of the town walls still exist, and also two ancient bridges, both belonging to the Via Clodia, and many tombs hewn in the rock—small chambers imitating the architectural forms of houses, with beams and rafters represented in relief. See G. Dennis, *Cities and Cemeteries of Etruria*, i. 207. There was another Blera in Apulia, on the road from Venusia to Tarentum.

BLESSINGTON, MARGUERITE, COUNTESS OF (1780-1849), Irish novelist and miscellaneous writer, daughter of Edmund Power, a small landowner, was born near Clonmel, Co. Tipperary, Ireland, on the 1st of September 1780. Her childhood was made unhappy by her father's character and poverty, and her early womanhood wretched by her compulsory marriage at the age of fifteen to a Captain Maurice St Leger Farmer, whose drunken habits brought him at last as a debtor to the king's bench prison, where, in October 1817, he died. His wife had left him some time before, and in February 1818 she married Charles John Gardiner, earl of Blessington. Of rare beauty, charm and wit, she was no less distinguished for her generosity and for the extravagant tastes which she shared with her husband, which resulted in encumbering his estates with a load of debt. In the autumn of 1822 they went abroad, spent four months of the next year at Genoa in close intimacy with Byron, and remained on the continent till Lord Blessington's death in May 1829. Some time before this they had been joined by Count D'Orsay, who in 1827 married Lady Harriet Gardiner, Lord Blessington's only daughter by a former wife. D'Orsay, who had soon separated from his wife, now accompanied Lady Blessington to England and lived with her till her death. Their home, first at Seamore Place, and afterwards Gore House, Kensington, became a centre of attraction for whatever was distinguished in literature, learning, art, science and fashion. After her husband's death she supplemented her diminished income by contributing to various periodicals as well as by writing novels. She was for some years editor of *The Book of Beauty* and *The Keepsake*, popular annuals of the day. In 1834 she published her *Conversations with Lord Byron*. Her *Idler in Italy* (1839-1840), and *Idler in France* (1841) were popular for their personal gossip and anecdote, descriptions of nature and sentiment. Early in 1849, Count D'Orsay left Gore House to escape his creditors; the furniture and decorations were sold, and Lady Blessington joined the count in Paris, where she died on the 4th of June 1849.

Her *Literary Life and Correspondence* (3 vols.), edited by R. R. Madden, appeared in 1855. Her portrait was painted in 1808 by Sir Thomas Lawrence.

BLIDA, a town of Algeria, in the department of Algiers, 32 m. by railway S.W. from Algiers, on the line to Oran. Pop. (1906) 16,866. It lies surrounded with orchards and gardens, 630 ft. above the sea, at the base of the Little Atlas, on the southern edge of the fertile plain of the Metija, and the right bank of the Wad-el-Kebrir affluent of the Chiffa. The abundant water of this stream provides power for large corn

mills and several factories, and also supplies the town, with its numerous fountains and irrigated gardens. Blida is surrounded by a wall of considerable extent, pierced by six gates, and is further defended by Fort Mimich, crowning a steep hill on the left bank of the river. The present town, French in character, has well-built modern streets with many arcades, and numbers among its buildings several mosques and churches, extensive barracks and a large military hospital. The principal square, the place d'Armes, is surrounded by arcaded houses and shaded by trees. The centre of a fertile district, and a post on one of the main routes in the country, Blida has a flourishing trade, chiefly in oranges and flour. The orange groves contain over 50,000 trees, and in April the air for miles round is laden with the scent of the orange blossoms. In the public gardens is a group of magnificent olive trees. The products of the neighbouring cork trees and cedar groves are a source of revenue to the town. In the vicinity are the villages of Joinville and Montpensier, which owe their origin to military camps established by Marshal Valée in 1838; and on the road to Medea are the tombs of the marabout Mahommed-el-Kebir, who died in 1580, and his two sons.

Blida, *i.e. boleida*, diminutive of the Arab word *belad*, city, occupies the site of a military station in the time of the Romans, but the present town appears to date from the 16th century. A mosque was built by order of Khair-ed-din Barbarossa, and under the Turks the town was of some importance. In 1825 it was nearly destroyed by an earthquake, but was speedily rebuilt on a site about a mile distant from the ruins. It was not till 1838 that it was finally held by the French, though they had been in possession for a short time eight years before. In April 1906 it was chosen as the place of detention of Behanzin, the ex-king of Dahomey, who died in December of that year.

Blida is the chief town of a commune of the same name, having (1906) a population of 33,332.

BLIGH, WILLIAM (1754-1817), English admiral, was born of a good Cornish family in 1754. He accompanied Captain Cook in his second expedition (1772-1774) as sailing-master of the "Resolution." During the voyage, the bread-fruit, already known to Dampier, was found by them at Otaheite; and after seeing service under Lord Howe and elsewhere, "Bread-fruit Bligh," as he was nicknamed, was despatched at the end of 1787 to the Pacific in command of H.M.S. "Bounty," for the purpose of introducing it into the West Indies from the South Sea Islands. Bligh sailed from Otaheite, after remaining there about six months; but, when near the Friendly Islands, a mutiny (April 28, 1789) broke out on board the "Bounty," headed by Fletcher Christian, the master's mate, and Bligh, with eighteen others, was set adrift in the launch. The mutineers themselves settled on Pitcairn Island (*q.v.*), but some of them were afterwards captured, brought to England and in three cases executed. This mutiny, which forms the subject of Byron's *Island*, did not arise so much from tyranny on the part of Bligh as from attachments contracted between the seamen and the women of Otaheite. After suffering severely from hunger, thirst and storms, Bligh and his companions landed at Timor in the East Indies, having performed a voyage of about 4000 m. in an open boat. Bligh returned to England in 1790, and he was soon afterwards appointed to the "Providence," in which he effected the purpose of his former appointment by introducing the bread-fruit tree into the West India Islands. He showed great courage at the mutiny of the *Nore* in 1797, and in the same year took part in the battle of Camperdown, where Admiral Duncan defeated the Dutch under De Winter. In 1801 he commanded the "Glatton" (54) at the battle of Copenhagen, and received the personal commendations of Nelson. In 1805 he was appointed "captain general and governor of New South Wales." As he made himself intensely unpopular by the harsh exercise of authority, he was deposed in January 1808 by a mutiny headed by Major George Johnston of the 102nd foot, and was imprisoned by the mutineers till 1810. He returned to England in 1811, was promoted to rear-admiral in

that year, and to vice-admiral in 1814. Major Johnston was tried by court martial at Chelsea in 1811, and was dismissed the service. Bligh, who was an active, persevering and courageous officer, died in London in 1817.

BLIND, MATHILDE (1841-1896), English author, was born at Mannheim on the 21st of March 1841. Her father was a banker named Cohen, but she took the name of Blind after her step-father, the political writer, Karl Blind (1826-1907), one of the exiled leaders of the Baden insurrection in 1848-1849, and an ardent supporter of the various 19th-century movements for the freedom and autonomy of struggling nationalities. The family was compelled to take refuge in England, where Mathilde devoted herself to literature and to the higher education of women. She produced also three long poems, "The Prophecy of St Oran" (1881), "The Heather on Fire" (1886), an indignant protest against the evictions in the Highlands, and "The Ascent of Man" (1888), which was to be the epic of the theory of evolution. She wrote biographies of George Eliot (1883) and Madame Roland (1886), and translated D.F. Strauss's *The Old Faith and the New* (1873-1874) and the *Memoirs of Marie Bashkirtseff* (1890). She died on the 26th of November 1896, bequeathing her property to Newnham College, Cambridge.

A complete edition of her poems was edited by Mr Arthur Symons in 1900, with a biographical introduction by Dr Richard Garnett.

BLIND HOOKEY, a game of chance, played with a full pack of cards. The deal, which is an advantage, is decided as at whist, the cards being shuffled and cut as at whist. The dealer gives a parcel of cards to each player including himself. Each player puts the amount of his stake on his cards, which he must not look at. The dealer has to take all bets. He then turns up his parcel, exposing the bottom card. Each player in turn does the same, winning or losing according as his cards are higher or lower than the dealer's. Ties pay the dealer. The cards rank as at whist. The suits are of no importance, the cards taking precedence according to their face-value.

BLINDING, a form of punishment anciently common in many lands, being inflicted on thieves, adulterers, perjurers and other criminals. The inhabitants of Apollonia (Illyria) are said to have inflicted this penalty on their "watch" when found asleep at their posts. It was resorted to by the Roman emperors in their persecutions of the Christians. The method of destroying the sight varied. Sometimes a mixture of lime and vinegar, or barely scalding vinegar alone, was poured into the eyes. Sometimes a rope was twisted round the victim's head till the eyes started out of their sockets. In the middle ages the punishment seems to have been changed from total blindness to a permanent injury to the eyes, amounting, however, almost to blindness, produced by holding a red-hot iron dish or basin before the face. Under the forest laws of the Norman kings of England blinding was a common penalty. Shakespeare makes King John order his nephew Arthur's eyes to be burnt out.

BLINDMAN'S-BUFF (from an O. Fr. word, *bufe*, a blow, especially a blow on the cheek), a game in which one player is blindfolded and made to catch and identify one of the others, who in sport push him about and "buffet" him.

BLINDNESS, the condition of being blind (a common Teutonic word), *i.e.* devoid of sight (see also **VISION**; and **EYE: Diseases**). The data furnished in various countries by the census of 1901 showed generally a decrease in blindness, due to the progress in medical science, use of antiseptics, better sanitation, control of infectious diseases, and better protection in shops and factories. Blindness is much more common in hot countries than in temperate and cold regions, but Finland and Iceland are exceptions to the general rule.¹ In hot countries the eyes are affected by the glaring sunlight, the dust and the dryness of the air. From statistics in Italy, France and Belgium, localities on the coast seem to have more blind persons than those at a distance from the sea.

¹ There are no late returns for Iceland, but the last available statistics gave 3400 per million. A paper written in 1903 on blindness in Egypt stated that 1 in every 50 of the population was blind.

The following table gives the number of blind persons as reported in the census of each country. Unless otherwise stated, it refers to the statistics of 1900.

Country.	Total Number.	Number per Million of Population.
Austria	14,582	540
Belgium	3448	487
Canada	3279	610
Denmark	1047	427
England	25,317	778
France	27,174	698
Finland ¹	3229	119
Germany	34,334	609
Hungary	19,377	1006
Ireland	4263	954
Italy	38,160	1175
Holland (1890)	2114	414
Norway	1879	838
Portugal	5650	1040
Sweden	3413	664
Switzerland (1895)	2107	722
Scotland	3253	727
Spain (1877)	24,608	1006
Russia		about 2000
United States (corrected census)	85,662	1125

CAUSES AND PREVENTION

There are many cases of complete or partial blindness which might have been prevented, and a knowledge of the best methods of prevention and cure should be spread as widely as possible. Magnus, Bremer, Steffen and Rössler are of opinion that 40% of the cases of blindness might have been prevented. Hayes gives 33.35% as positively avoidable, 38.75% possibly avoidable, and 46.27% as a conservative estimate. Cohn regards blindness as certainly preventable in 33%, as probably preventable in 43%, and as quite unpreventable in only 24%. If we take the lowest of these figures, and assume that 400 out of every 1000 blind persons might have been saved from such a calamity, we realize the importance of preventative measures. For the physiology and pathology of the eye generally, see VISION and EYE.

The great majority of these cases are due to infantile purulent ophthalmia. This arises from inoculation of the eyes with hurtful material at time of birth. If the contagious discharges are allowed to remain, violent inflammation is set up which usually ends in the loss of sight. It depends on the presence of a microbe, and the effective application of a weak solution of nitrate of silver is curative, if made in a proper manner at an early period of the case. In Germany, midwives are expressly prohibited by law from treating any affection of the eyes or eyelids of infants, however slight. On the appearance of the first symptoms, they are required to represent to the parents, or others in charge, that medical assistance is urgently needed, or, if necessary, they are themselves to report to the local authorities and the district doctor. Neglect of these regulations entails liability to punishment. Eleven of the United States of America have enacted laws requiring that, if one or both eyes of an infant should become inflamed, swollen or reddened at any time within two weeks of its birth, it shall be the duty of the midwife or nurse having charge of such infant to report in writing within six hours, to the health officer or some legally qualified physician, the fact that such inflammation, swelling or redness exists. The penalty for failure to comply is fine or imprisonment.

The following weighty words, from a paper prepared by Dr Park Lewis, of Buffalo, N.Y., for the American Medical Association, show that laws are not sufficient to prevent evil, unless supported by strong public sentiment:—

"When an enlightened, civilized and progressive nation quietly and passively, year after year, permits a multitude of its people unnecessarily to become blind, and more especially when one-quarter

¹ Previous returns from Finland have shown a much larger number of blind persons, but these statistics were supplied by the British consul in St Petersburg from the last census.

of these are infants, the reason for such a startling condition of affairs demands explanation. That such is the fact, practically all reliable ophthalmologists agree.

"From a summary of carefully tabulated statistics it has been demonstrated that at least four-tenths of all existing blindness might have been avoided had proper preventative or curative measures been employed, while one-quarter of this, or one-tenth of the whole, is due to *ophthalmia neonatorum*, an infectious, preventable and almost absolutely curable disease. Perhaps this statement will take on a new meaning when it is added that there are in the state of New York alone more than 6000, and in the United States more than 50,000 blind people; of these 600 in the one state, and 5000 in the country, would have been saved from lives of darkness and unhappiness, in having lost all the joys that come through sight, and of more or less complete dependence—for no individual can be as self-sufficient without as with eyes—if a simple, safe and easily applied precautionary measure had been taken at the right time and in the right way to prevent this affliction. The following three vital facts are not questioned, but are universally accepted by those qualified to know:—

"1. The ophthalmia of infancy is an infectious germ disease.
"2. By the instillation of a silver salt in the eyes of a new-born infant the disease is prevented from developing in all but an exceedingly small number of the cases in which it would otherwise have appeared.

"3. In practically all those few exceptional cases the disease is absolutely curable, if like treatment is employed at a sufficiently early period.

"Since these facts are no longer subjects of discussion, but are universally accepted by all educated medical men, the natural inquiry follows: Why, as a common-sense proposition, are not these simple, harmless, preventive measures invariably employed, and why, in consequence of this neglect, does a nation sit quietly and indifferently by, making no attempt to prevent this enormous and needless waste of human eyes?

"The reasons are three-fold, and lie—first, with the medical profession; second, with the lay public; third, with the state.

"For the education of its blind children annually New York alone pays *per capita* at least \$350, and a yearly gross sum amounting to much more than \$100,000. If, as sometimes happens, the blind citizen is a dependent throughout a long life, the cost of maintenance is not less than \$10,000, and the mere cost in money will be multiplied many times in that a productive factor, by reason of blindness, has been removed from the community.

"If, therefore, as an economic proposition, it were realized how vitally it concerns the state that not one child shall needlessly become blind, thereby increasing the public financial burden, there is no doubt that early and effective measures would be instituted to protect the state from this unnecessary and extravagant expenditure of public funds.

"Eleven states have passed legislative enactments requiring that the midwife shall report each case to the proper health authority, and affixing a penalty for the failure to do so. As has been intimated, however, it is not by any means always under the ministrations of midwives that these cases occur, and, like all laws behind which is not a strong and well-informed public sentiment, this law is rarely enforced. A more effective method must be devised. Every physician having to do with the parturient woman, every obstetrician, every midwife, must be frequently and constantly advised of the dangers and possibilities of this disease, the necessity of prevention, and the value of early and correct treatment. They must then have placed in their hands, ready for instant use, a safe and efficient preparation, issued by the health authorities as a guarantee as to its quality and efficiency.

"An important step was taken in this direction when a resolution was passed by the House of Delegates at the annual meeting of the New York State Medical Society, requesting the various health officers of the state to include *ophthalmia neonatorum* among contagious diseases which must be reported to the local boards of health.

"The second essential, in order that the cause of infantile ophthalmia be abolished, is that a solution of the necessary silver salt be prepared under the authority of somebody capable of inspiring universal confidence, and that it be distributed by the health department of every state gratuitously to every obstetrician, physician or midwife qualified to care for the parturient woman. The nature of the solution, together with the character of the descriptive card which should accompany it, should be determined by a committee, chosen by the president of the American Medical Association, which should have among its members at least one representative ophthalmologist, one obstetrician and one sanitarian. The conclusions of this committee should be reported back to the House of Delegates, so that the preparation and its text should carry with it, on the great authority of this association, the assurance that the solution is entirely safe and necessary, and that its use should invariably be part of the toilet of every new-born child. The solution, probably silver nitrate, could be put up either by the state itself or by some trustworthy pharmacist, at an insignificant cost; its purity and sterility should be vouched for by the board of health of the state. It should be enclosed in specially prepared receptacles,

each containing a special quantity, and so arranged that it may be used drop by drop. These, properly enclosed, accompanied by a brief lucid explanation of the danger of the disease, the necessity of this gemicide, the method of its employment, and the right subsequent care of the eyes, should be sent to the obstetrician on the receipt of each birth certificate.

"I have said that responsibility for the indifference that is annually resulting in such frightful disaster lies primarily with the state, the public and the medical profession.

"The state is already aroused to the necessity of taking effective measures to wipe out this controllable plague. Bills have been introduced in the legislature of Massachusetts and of New York, providing for the appointment of commissions for the blind, one of whose duties will be to study the causes of unnecessary blindness and to suggest preventative measures."

One of the most common diseases of the eye is trachoma, often called "granular lids," because the inner surface of the lid seems to be covered with little granulations. The disease sometimes lasts for years without causing blindness, though it gives rise to great irritation. It is generally attended by a discharge, which is highly contagious, producing the same disease if it gets into other eyes. Want of cleanliness is one of the most important factors in the propagation of trachoma, hence its great prevalence in Oriental countries. Trachoma is very prevalent in Egypt, where those suffering from total or partial blindness are said to amount to 10% of the population. During Napoleon's Egyptian campaign, nearly every soldier, out of an army of 32,000 men, was affected. During the following twenty years the disease spread through almost all European armies. In the Belgian army, there was one trachomatous soldier out of every five, and up to 1834 no less than 4000 soldiers had lost both eyes and 10,000 one eye. It is a disease which is very common in workhouse schools, orphan asylums and similar establishments. Unlike ophthalmia of new-born children, it is difficult to cure, and a total separation of the diseased from the healthy children should be effected.

About one-half of those who are blinded by injuries lose the second eye by sympathetic ophthalmia. It is a constant source of danger to those who retain an eye blinded by injury. Blindness from this cause can be prevented by the removal of the injured eye, but unfortunately the proposal often meets with opposition from the patient.

Glaucoma is a disease which almost invariably leads to total blindness; but in most cases it can be arrested by a simple operation if the case is seen sufficiently early.

Myopia, or "short-sight," makes itself apparent in children between the ages of seven and nine. Neglect of a year or two may do serious mischief. Short-sight, when not inherited, is produced by looking intently and continuously at near objects. Children should be encouraged to describe objects at a distance, with which they are unacquainted, and parents should choose out-door occupations and amusements for children who show a tendency to short-sightedness.

A report was issued in 1906, by the school board of Glasgow, as to an investigation by Dr H. Wright Thomas, ophthalmic surgeon, regarding the eyesight of school children, which includes the following passage. Dr Wright Thomas states that the teachers tested the visual acuteness of 52,493 children, and found 28,565, or 35%, to be below what is regarded as the normal standard. He examined the 28,565 defectives by retinoscopy, and found that 11,209, or 21% of the whole, had ocular defects. The proportion of these cases was highest in the poor and closely-built districts and in old schools, and was lowest in the better-class schools and those near the outskirts of the city. Defective vision, apart from ocular defect, seems to be due partly to want of training of the eyes for distant objects and partly to exhaustion of the eyes, which is easily induced when work is carried on in bad light, or the nutrition of the children is defective from bad feeding and unhealthy surroundings. Regarding training of the eyes for distant objects, much might be done in the infant department by the total abolition of sewing, which is definitely hurtful to such young eyes, and

the substitution of competitive games involving the recognition of small objects at a distance of 20 ft. or more. An annual testing by the teachers, followed by medical inspection of the children found defective, would soon cause all existing defects to be corrected, and would lead to the detection of those which develop during school life.

HISTORY OF INSTITUTIONS

Although there is a record of a hospital established by St Basil at Caesarea, Cappadocia, in the 4th century, a refuge by the hermit St Lymnee (d. c. 455) at Syr, Syria, in the 5th century, and an institution by St Bertrand, bishop of Le Mans, in the 7th century, the first public effort to benefit the blind was the founding of a hospital at Paris, in 1260, by Louis IX., for 300 blind persons. The common legend is that he founded it as an asylum for 300 of his soldiers who had become blinded in the crusade in Egypt, but the statutes of the founder are preserved, and no mention is made of crusaders. This Hospice des Quinze-Vingts, increased by subsequent additions to its funds, still assists the adult blind of France. The pensioners are divided into two classes—those who are inmates of the hospital (300), and those who receive pensions in the form of out-door relief. All appointments to inmates or pensions are vested in the minister of the Interior, and applicants must be of French nationality, totally blind and not less than forty years of age.

From the time of St Louis to the 18th century, there are records of isolated cases of blind persons who were educated, and of efforts to devise tangible apparatus to assist them.

Girolamo Cardan, the 16th-century Italian physician, conceived the idea that the blind could be taught to read and write by means of touch. About 1517 Francesco Lucas in Spain, and Rampazetto in Italy, made use of large letters cut in wood for instructing the blind. In 1646 a book, on the condition of the blind, was written by an Italian, and published in Italian and French, under the title of *L'Aveugle affligé et consolé*. In 1670 a book was written on the instruction of the blind by Lana Terzi, the Jesuit. In 1676 Jacques Bernoulli, the Swiss savant, taught a blind girl to read, but the means of her instruction were not made known. In 1749 D. Diderot wrote his *Lettre sur les aveugles à l'usage de ceux qui voient*, to show how far the intellectual and moral nature of man is modified by blindness. Dr S. G. Howe, who many years after translated and printed the "Letter" in embossed type, characterizes it as abounding with errors of fact and inference, but also with beauties and suggestions. The heterodox speculations contained in his "Letter on the Blind" caused Diderot to be imprisoned three months in the Bastille. He was released because his services were required for the forthcoming *Encyclopaedia*. Rousseau visited Diderot in prison, and is reported to have suggested a system of embossed printing. J. Locke, G. W. Leibnitz, Molineau and others discussed the effect of blindness on the human mind. In Germany, Weissenbourg had used signs in relief and taught Mlle Paradis.

Prior to the 18th century, blind beggars existed in such numbers that they struggled for standing room in positions favourable for asking alms. Their very affliction led to their being used as spectacles for the amusement of the populace. The degraded state of the masses of the blind in France attracted the attention of Valentin Haüy. In 1771, at the annual fair of St Ovid, in Paris, an innkeeper had a group of blind men attired in a ridiculous manner, decorated with peacock tails, asses' ears, and pasteboard spectacles without glasses, in which condition they gave a burlesque concert, for the profit of their employer. This sad scene was repeated day after day, and greeted with loud laughter by the gaping crowds. Among those who gazed at this outrage to humanity was the philanthropist Valentin Haüy, who left the disgraceful scene full of sorrow. "Yes," he said to himself, "I will substitute truth for this mocking parody. I will make the blind to read, and they shall be enabled to execute harmonious music." Haüy collected all the information he could gain respecting the blind, and began teaching a blind boy who had gained his living by begging at a church

door. Encouraged by the success of his pupil, Haty collected other blind persons, and in 1785 founded in Paris the first school for the blind (the Institution Nationale des Jeunes Aveugles), and commenced the first printing in raised characters. In 1786, before Louis XVI. and his court at Versailles, he exhibited the attainments of his pupils in reading, writing, arithmetic, geography and music, and in the same year published an account of his methods, entitled *Essai sur l'éducation des aveugles*. As the novelty wore off, contributions almost came to an end, and the Blind School must have ceased to exist, had it not been taken, in 1791, under the protection of the state.

The emperor of Russia, and later the dowager empress, having learned of Haty's work, invited him to visit St Petersburg for the purpose of establishing a similar institution in the Russian capital. On his journey Haty was invited by the king of Prussia to Charlottenburg. He took part in the deliberations of the Academy of Sciences in Berlin, and as a result a school was founded there.

Edward Rushton, a blind man, was the projector of the first institution for the blind in England—the School for the Indigent Blind, Liverpool. In 1790 Rushton suggested to the literary and philosophical society of which he was a member, the establishment of a benefit club for the indigent blind. The idea was communicated to his friend, J. Christie, a blind musician, and the latter thought the scheme should also include the instruction of young blind persons. They circulated letters amongst individuals who would be likely to give their assistance, and the Rev. Henry Dannett warmly advocated the undertaking. It was mainly due to his co-operation and zeal that Messrs Rushton and Christie's plan was carried out, and the Liverpool asylum was opened in 1791. Thomas Blacklock of Edinburgh, a blind poet and scholar, translated Haty's work on the *Education of the Blind*. He interested Mr David Millar, a blind gentleman, the Rev. David Johnston and others in the subject, and after Blacklock's death the Edinburgh Asylum for the Relief of the Indigent and Industrious Blind was established (1793). Institutions were established in the United Kingdom in the following order:—

School for the Indigent Blind, Liverpool	1791
Royal Blind Asylum, Edinburgh	1793
Bristol Asylum	1793
School for the Indigent Blind, Southwark (now removed to Leatherhead)	1799
Norwich Asylum and School	1803
Richmond Asylum, Dublin	1810
Aberdeen Asylum	1812
Molyneux Asylum, Dublin	1815
Glasgow Asylum and School	1827
Belfast School	1831
Wilberforce School, York	1833
Limerick Asylum	1834
London Society for Teaching the Blind to Read, St John's Wood, N.	1838
Royal Victoria School for the Blind, Newcastle-on-Tyne	1838
West of England Institute for the Blind, Exeter	1838
Henshaw's Blind Asylum, Manchester County and City of Cork Asylum	1839
Catholic Asylum, Liverpool	1841
Brighton Asylum	1842
Midland Institute for the Blind, Nottingham	1843
General Institute for the Blind, Birmingham	1848
Macan Asylum, Armagh	1854
St Joseph's Asylum, Dublin	1858
St Mary's Asylum, Dublin	1858
Institute for the Blind, Devonport	1860
South Devon and Cornwall Institute for the Blind, Plymouth	1860
School for the Blind, Southsea	1864
Institute for the Blind, Dundee	1865
South Wales Institute for the Blind, Swansea	1863
School for the Blind, Leeds	1866
College for the Sons of Gentlemen, Worcester	1866
Northern Counties Institute for the Blind, Inverness	1866
Royal Normal College and Academy of Music for the Blind, Upper Norwood	1872
School for the Blind, Sheffield	1879
Barclay Home and School for Blind Girls, Brighton	1893
Homes for Blind Children, Preston	1893
North Stafford School, Stoke-on-Trent	1897

Many of the early institutions were asylums, and to the present day schools for the blind are regarded by the public as asylums rather than as educational establishments. With nearly all these schools workshops were connected. In 1856 Miss Gilbert, the blind daughter of the bishop of Chichester, established a workshop in Berners Street, London, and since that date workshops have been started in many of the provincial towns.

After the beginning of the 19th century, institutions for the blind were established in various parts of Europe. The institution at Vienna was founded in 1804 by Dr W. Klein, a blind man, and he remained at its head for fifty years. That of Berlin was established in 1806, Amsterdam, Prague and Dresden in 1808, Copenhagen in 1811. There are more than 150 on the European continent, most of them receiving aid from the government, and being under government supervision.

The first school for the blind in the United States was founded in Boston, Mass., chiefly through the efforts of Dr John D. Fisher, a young physician who visited the French school. It was incorporated in 1829, and in honour of T. H. Perkins (1764-1854) who gave his mansion to the institution was named the Perkins Institution and Massachusetts Asylum (now School) for the Blind. Aid was granted by the state from the beginning. In 1831 Dr Samuel G. Howe (q.v.) was appointed director, and held that position for nearly forty-four years, being succeeded by his son-in-law Michael Anagnos (d. 1906), who established a kindergarten for the blind at Jamaica Plain, in connexion with the Perkins Institution. Dr Howe was interested in many charitable and sociological movements, but his life-work was on behalf of the blind. One of his most notable achievements was the education of Laura Bridgman (q.v.) who was deaf, dumb and blind, and this has since led to the education of Helen Keller and other blind deaf-mutes. The New York Institution was incorporated in 1831, and the Pennsylvania Institution was founded at Philadelphia by the Society of Friends in 1833. The Ohio was founded at Columbus in 1837, Virginia at Staunton in 1839, Kentucky at Louisville in 1842, Tennessee at Nashville in 1844, and now every state in the Union makes provision for the education of the blind.

STATISTICS

In England and Wales the total number of persons returned in 1901 as afflicted with blindness was 25,317, being in the proportion of 778 per million living, or 1 blind person in every 1285 of the population. The following table *England and Wales* shows that the proportion of blind persons to population has diminished at each successive enumeration since 1851, in which year particulars of those afflicted in this manner were ascertained for the first time. It will, however, be noted that, although the decrease in the proportion of blind in the latest intercensal period was still considerable, yet the rate of decrease which had obtained between 1871 and 1891 was not maintained.

Year.	Number of Blind.	Blind per Million of the Population.	Persons Living to one Blind Person.
1851	18,306	1021	979
1861	19,352	964	1037
1871	21,590	951	1052
1881	22,832	879	1138
1891	23,467	809	1236
1901	25,317	778	1285

The following table, which gives the proportions of blind per million living at the earlier age-groups, shows that in the decennium 1891-1901, as also in recent previous intercensal periods, there was a decrease in the proportion of blind children in England and Wales generally; it thus lends support to the contention, in the *General Report* for 1891, that the decrease was due either to the lesser prevalence, or to the more efficient treatment, of purulent ophthalmia and other infantile maladies which may result in blindness.

Age-Period.	1851	1861	1871	1881	1891	1901
Under 5 years	198	196	185	166	155	129
5-10	297	256	259	288	188	192
10-15	365	366	359	359	290	323
15-20	416	413	494	388	370	329
20-25	481	443	451	422	385	359
Total under 25	339	322	317	298	269	261

In 1886 a royal commission on the blind, deaf and dumb was appointed by the government, and, after taking much valuable evidence, issued an exhaustive and instructive report. Following on the practical recommendations submitted by this commission, the Elementary Education (Blind and Deaf Children) Act 1893, was passed, under which the education of the blind became for the first time compulsory. In terms of this statute, the school authorities were made responsible for the provision of suitable elementary education for blind children up to sixteen years of age, and grants of £3. 3s. for elementary subjects, and of £2. 2s. for industrial training, were contributed by the state towards the cost of educating children in schools certified as efficient within the meaning of the Elementary Education Act 1876. The principal aim of the Education Act of 1893 was to supply education in some useful profession or trade which will enable the blind to earn their livelihood and to become useful citizens; but the weak spot was that no provision was made therein for the completion of their education and industrial training after the age of sixteen.

In England and Wales, in 1907, there were twenty-four resident schools and forty-three workshops for the blind. In many of the large towns, day classes for the education of blind children have been established by local education authorities. There are forty-six home teaching societies, who send teachers to visit the blind in their homes, to teach adults who wish to learn to read, to act as colporteurs, to lend and exchange useful books, and to act as Scripture readers to those who are aged and infirm. All the home teaching societies for the blind and many public libraries lend embossed books. The public library at Oxford has nearly 400 volumes of classical works for the use of university students.

A society was instituted in 1847 by Dr W. Moon for stereotyping and embossing the Scriptures and other books in "Moon" type. The type has been adapted to over 400 languages and dialects. After Dr Moon's death in 1884 the work was carried on by his daughter, Miss Adelaide Moon, and the books are much used by the adult blind.

In 1868 Dr T. R. Armitage, being aware of the great improvements which had been made in the education of the blind in other countries, founded the British and Foreign Blind Association. This association was formed for the purpose of promoting the education and employment of the blind, by ascertaining what had been done in these respects in various countries, by endeavouring to supply deficiencies where these were found to exist, and by attempting to bring about greater harmony of action between the different existing schools and institutions. It gave a new impetus to the education and training of the blind in the United Kingdom. At that time their education was in a state of chaos. The Bible, or a great part of it, had been printed in five different systems. The founders took as an axiom that the relative merits of the various methods of education through the sense of touch should be decided by those and those only who have to rely on this sense. The council, who were all totally or partially blind, spent two years in comparing the different systems of embossed print. In 1869 and 1870 Dr Armitage corresponded with Dr J. R. Russ in regard to the New York Point. No trouble was spared to arrive at a right conclusion. The Braille system was finally adopted, and the association at once became a centre for supplying frames for writing Braille, printed books, maps, music and other educational apparatus for the blind. All books printed by the association are printed from stereotyped plates embossed by blind copyists. About 3000 separate works, varying in length from 1 to 12 volumes,

have been copied by hand to meet the requirements of public libraries and individuals. About 700 ladies, who give their services, make the first Braille copy of these books, and they are recopied by blind scribes, chiefly women and girls, who are paid for their work.

The National Lending library, London, was founded in 1882. It has over 5500 volumes in Braille and other types. Books are forwarded to all parts of the United Kingdom.

There are fourteen magazines published in embossed type in the United Kingdom.

There are thirty-six pension societies—the principal are Hetherington's, Day's, the Clothworkers', the Cordwainers', the National Blind Relief Society, Royal Blind Pension Society and Indigent Blind Visiting Society.

The Gardner Trust administers the income of £300,000 left by Henry Gardner in 1879. The income is used for instructing the blind in the profession of music, in suitable trades, handicrafts and professions other than music, for pensions, and free grants to institutions and individuals for special purposes.

According to the census of 1901, Scotland had 3253 (or 727 per million) blind persons, as against 2797 in 1891, but in a paper read at the conference in Edinburgh, 1906, the superintendent of the Glasgow Mission to the Out-door Blind stated that there were 738 employed or being educated in institutions, and 3238 known as "out-door blind," making a total of 3996. There are in Scotland ten missions, so distributed as to cover the whole country, and regular visits are made as far north as the Orkney and Shetland Islands. In carrying on the work, there are twenty-four paid missionaries or teachers and a large number of voluntary helpers. These societies originated in a desire to teach the blind to read in their own homes, and to provide them with the Scriptures and other religious books, but the social, intellectual and temporal needs of the blind also receive a large share of attention. These teachers afford the best means of circulating embossed literature, therefore the library committee of the Glasgow corporation has agreed to purchase books and place them in the mission library instead of in the public library. As the institutions provide for only a small number of the blind, strenuous efforts are made by the committee and teachers of missions to find some employment for the many adults who come under their care.

In Glasgow, a ladies' auxiliary furnishes work for 150 knitters, and takes the responsibility of disposing of their work. In Scotland there are five schools for the young blind, and in connexion with each is a workshop for adults. In Edinburgh the school is at West Craigmillar, and the workshop in the city, but both are under the same board of directors.

According to the census of 1901, there were 4253 totally blind persons in Ireland, a proportion of 954 per million, as against 1135 in 1891. Of these, 2430 were over 60 years of age and 11 over 100. These figures do not include the partially blind, who numbered 1217. The fact that so many aged blind persons are to be found in Ireland is doubtless due to an ophthalmic epidemic which occurred during the Irish famine. There are twelve institutions, a home mission and home teaching society; nine of these institutions are asylums, that system having been largely adopted in Ireland. The scarcity of manufacturing industries, except in a few northern counties, entails a lack of work suited to the blind. The Elementary Education Act (Blind and Deaf) does not extend to Ireland.

The following table gives the number of blind in age-groups in 1901:—

Age-Period.	Number.	Age-Period.	Number.
Under 5 years	10	50-55	392
5-10	38	55-60	314
10-15	64	60-65	617
15-20	73	65-70	382
20-25	95	70-75	540
25-30	116	75-80	306
30-35	146	80-85	372
35-40	146	85-90	118
40-45	205	95 and upwards	95
45-50	224		

In the Dominion of Canada, South Africa, the states of the Australian Commonwealth and New Zealand, provision is made by the government for the education of the young blind, and in some cases for training the adults in handicrafts. Embossed literature is carried free of expense, and on the Victorian railways no charge is made for the guide who accompanies a blind person.

British Colonies.

The following were the census returns for 1901:—

Victoria	1082	Tasmania	173
New South Wales	884	New Zealand	274 (1891)
South Australia	315	Natal	68
Queensland	209	Cape Colony	2802 (1904)
West Australia	121	Canada	3279

In Australia there are institutions for the blind at Melbourne, Sydney, Adelaide, Brighton, Brisbane and Maylands near Perth. In New Zealand the institution is at Auckland.

In Cape Colony, between 1875 and 1891, there was an extraordinary increase in blindness, but between 1891 and 1904 the rate per 10,000 has decreased 23.78%. There is an institution at Worcester for deaf-mutes and blind, founded in 1881. It is supported by a government grant, fees and subscription.

Schools for the blind were established by the Dominion government at Brantford, Ontario (1871), and Halifax, Nova Scotia (1867).

In Montreal there are two private institutions, the M'Kay Institute for Protestant Deaf-Mutes and Blind, and a school for Roman Catholic children under the charge of the Sisters of Charity.

In the United States the education of the blind is not regarded as a charity, but forms part of the educational system of the country, and is carried on at the public expense. According to the

Annual Report of the Commissioner of Education for 1908, there were 40 state schools, with 4,340 pupils. The value of apparatus, grounds and buildings was \$9,201,161. For salaries and other expenditure, the aggregate was \$1,460,732. The United States government appropriates \$10,000 annually for printing embossed books, which are distributed among the different state schools for the blind. Beside these state schools, there are workshops for the blind subsidized by the state government or the municipality. Commissions composed of able men have recently been appointed in several of the states to take charge of the affairs of the blind from infancy to old age. The exhaustive summary of the 12th census enables these commissions to communicate with every blind person in their respective states.

At the 12th census a change was made in the plan for securing the returns, and the work of the enumerators was restricted to a brief preliminary return, showing only the name, sex, age, post office address, and nature of the existing defects in all persons alleged to be blind or deaf. Dr Alexander Graham Bell, of Washington, D.C., was appointed expert special agent of the census office for the preparation of a report on the deaf and blind. He was empowered to conduct in his own name a correspondence relating to this branch of the census inquiry. A circular containing eighteen questions was addressed to every blind person given in the census, and from the data contained in the replies the following tables (I., II., III., IV.) have been compiled.

TABLE I.—*The Blind, by Degree of Blindness and Sex.*

Sex.	The Blind.	The Totally Blind.	The Partially Blind.
Number—			
Total	64,763	35,645	29,118
Male	37,054	20,144	16,910
Female	27,709	15,501	12,208
Per cent distribution—			
Total	100.0	100.0	100.0
Male	57.2	56.5	58.1
Female	42.8	43.5	41.9
Number per 1,000,000 population of same sex—			
Both sexes	852	469	383
Male	955	519	436
Female	745	417	328

The enumerators reported a total of 101,123 persons alleged to be blind as defined in the instructions contained in the schedules, but this number was greatly reduced as a result of the correspondence directly with the individuals, 8842 reporting that the alleged defect did not exist, and 6544 that they were blind only in one eye but were able to see with the other, and hence did not come within the scope of the inquiry. No replies were received in 19,884 cases in which personal schedules were sent, although repeated inquiries were made; consequently these cases were dropped. In 380 cases the personal schedules returned were too incomplete for use, and in 75 cases duplication was discovered. The number of cases remaining for statistical treatment, after making the eliminations

TABLE II.—*The Blind, by Degree of Blindness, Age-Periods, Colour and Nativity.*

Degree of Blindness and Age-Period.	All Classes.	White.			Coloured.
		Total.	Native.	Foreign-born.	
Number—					
The blind	64,763	56,535	45,479	10,694	8228
Under 20 years	8,308	7,252	6,937	231	1056
20 years and over	56,165	49,067	38,388	10,420	7098
Age unknown	290	216	154	43	74
The totally blind	35,645	30,359	23,636	6,811	5286
Under 20 years	4,123	3,543	3,377	129	580
20 years and over	31,363	26,704	20,179	6,363	4659
Age unknown	159	112	80	19	47
The partially blind	29,118	26,176	21,843	4,183	2942
Under 20 years	4,185	3,709	3,560	102	476
20 years and over	24,802	22,363	18,209	4,057	2439
Age unknown	131	104	74	24	27
Number per 1,000,000 population of same age—					
The blind	852	846	804	1,047	896
Under 20 years	247	250	248	215	229
20 years and over	1,334	1,305	1,348	1,143	1574
The totally blind	469	454	418	637	576
Under 20 years	123	122	121	120	126
20 years and over	745	710	708	698	1033
The partially blind	383	392	386	410	320
Under 20 years	124	128	127	95	103
20 years and over	589	595	639	445	541

and corrections, was 64,763, representing 35,645 totally blind, and 29,118 partially blind. This number, however, can be considered only as the minimum, as an unknown proportion of the blind were not located by the enumerators, and doubtless a considerable proportion of the 19,884 persons who failed to return the personal schedules should be included in the total.

Blindness, either total or partial, is so largely a defect of the aged, and occurs with so much greater frequency as the age advances and the population diminishes, that in any comparison of the proportion of the blind in the general population of different classes, such as native and foreign-born whites, or white and coloured, the age distribution of the population of each class should be constantly borne in mind. The differences in this respect account for many of the differences in the gross ratios, and it is only when ratios are compared for classes of population of identical ages that their relative liability to blindness can be properly inferred.

Table II. shows the classification, by degree of blindness, of the blind under twenty years of age, twenty years of age and over, and of unknown age, with respect to colour and nativity, with the number at the specified ages per million of population in the same age-group.

The relationship or consanguinity of parents of the 64,763 blind was reported in 56,507 cases, in 2527 (or 4.5%) of which the parents were related as cousins.

In 57,726 cases the inquiry as to the existence of blind relatives was answered; 10,967 (or 19%) of this number reported that they had blind relatives.

Of the 2527 blind persons whose parents were cousins, 993 (or 39.3%) had blind relatives,—844 having blind brothers, sisters or ancestors, and 149 having blind collateral relatives or descendants.

Of the 53,080 blind whose parents were not related, 9490 (or 17.6%) had blind relatives, 7395 having blind brothers, sisters or ancestors, and 2095 having blind collateral relatives or descendants.

It was found that, of the 2527 blind whose parents were cousins, 632 (or 25%) were congenitally blind, of whom 350 (or 55.4%) had also blind relatives of the classes specified; while, among the 53,080 whose parents were not so related, the number of congenitally blind was 3666 (or but 6.8%), of whom only 1023 (or 27.9%) had blind relatives.

In 1883 the number of blind in France was estimated at 32,056, the total population of the country being 38,000,000; 2548 of the

blind were under, and 29,508 above, 21 years of age; of the former 157 were receiving instruction in 21 schools supported by the state, by the city of Paris, by some of the departments, and by some religious bodies. The four Parisian institutions are the Institution Nationale des Jeunes Aveugles, the École Braille (founded in 1863), the Etablissement des Sœurs Aveugles de St Paul

TABLE III.—The Blind, by Degree of Blindness and Age-Periods.

Age-Period.	The Blind.	The Totally Blind.	The Partially Blind.
Number—			
All ages	64,763	35,645	29,118
Under 10 years	2,307	1,262	1,045
10-19 "	6,001	2,861	3,140
20-29 "	4,861	2,851	2,010
30-39 "	5,024	3,077	1,947
40-49 "	6,504	3,778	2,726
50-59 "	8,530	4,791	3,739
60-69 "	10,507	5,835	4,672
70-79 "	11,421	6,132	5,289
80-89 "	7,490	3,885	3,605
90-99 "	1,596	851	745
100 years and over	232	163	69
Age unknown	290	159	131
Number per 1,000,000 population of same age—			
All ages	852	469	383
Under 10 years	128	70	58
10-19 "	384	183	201
20-29 "	351	206	145
30-39 "	478	293	185
40-49 "	645	491	354
50-59 "	1,653	930	723
60-69 "	3,396	1,886	1,510
70-79 "	8,136	4,368	3,768
80-89 "	22,022	11,423	10,599
90-99 "	52,746	28,125	24,621
100 years and over	66,210	46,518	19,692
Age unknown	1,446	793	653

founded in 1852), and that of the Frères de Saint Jean de Dieu (founded in 1875).

The number of the blind in Germany was about 39,000, or 870 per million in 1885. The number of institutions was 28, nearly all being educational, with a total of 2139 pupils. All these institutions, except two which are supported entirely by private munificence, are largely assisted by the state, the communes or the provinces. Seventeen of them derive their entire requirements from the state, so that they are quite independent of private charity, while the remainder are only supplemented from public funds so far as the private contributions fall short of the expenses.

The following extracts were made from an official communication from Hofrath Böttner, director of the institution for the blind in Dresden, to the royal commission, concerning the care and supervision (Fürsorge) of the blind after their discharge from the institution—

"When twenty years of age, the blind are usually discharged from the institution. Long experience has taught us that the care and supervision of the blind after their discharge from the institution are quite as important as their education and training in the institution. It would, in our opinion, be unjust to remove them from their sad surroundings, educate and accustom them to higher wants, and then allow them to sink backward into their former miserable way of life. After much deliberation it was decided to remain in connexion with the discharged blind, to visit them in their places of abode, to learn their wants, to study the difficulties which they experienced in supporting themselves independently, and, as far as possible, to remove their grievances. Director Georzi began this work in 1843. Director Reinhard continued it from 1867 to 1879, and the present director has followed the same path. With the knowledge of these difficulties the Fürsorge (care) for discharged blind steadily advanced, and has won the confidence of the Saxon people. It was decided that, on the discharge of the blind person, the director should select a trustworthy person, residing in his future place of abode, to give him advice and practical help, to protect him from imposition, and to keep up communication with the director. If this guardian is unable to advise or help, he then writes to the director, who, if necessary, comes to the place, and this is all the easier as he travels

free on all railways in Saxony. The result of these visits, as well as all communications from the guardian, the letters from the blind person, and every document relating to him, are entered in a register kept at the institution. These guardians are respectable, benevolent, practical men, capable of procuring custom for their wards. But there was no doubt that, in spite of these arrangements, the discharged blind were unable to support themselves without the assistance of capital, whether in money or outfit. The blind man can do as good work as the man who can see; but as a rule he does not work so quickly, and if the man who is not blind has to use every exertion to support himself and his family, the blind man to do the same requires some special help, without which he will either not be able to compete, or will have to lead a life of great privation.

"The first difficulty when a blind pupil is starting in life is to provide himself with the necessary tools and material. These the institution supplies to him, and continues through life to afford him moral and material help; and by this means the greater part of the blind are enabled to save money for sickness and old age. Those who cannot return to their relations cannot at once meet all their expenses, and the weak and old need special help. A part of the money for their board and lodging is paid for those who have to be settled in other places on account of the death or untrustworthiness of their relatives.

"The fund for the discharged blind is administered by the director of the institution. The number of those assisted amounts at present to about 400, who live respectably in all parts of Saxony, are almost self-supporting, and feel themselves free men. For, just as a son does not feel galled by a gift from his father, so they are not ashamed to receive assistance from their second paternal home, the institution."

The number of the blind in Holland, according to the census of the 1st of December 1869, was 1593, or one in every 2247 of the general population. The Protestants and Roman Catholics were about equally balanced. No cognizance was taken of the blind in the census of 1879. There is only one blind institution, that of Amsterdam, with 69 pupils, with a preparatory school at Benuchem (with 20 pupils) and an asylum for adults with 52 inmates (unmarried). Besides these, there are workshops at Amsterdam, Rotterdam, the Hague, Utrecht and Middelburg.

According to the census of 1870, there were in Denmark 1249 blind (577 males and 672 females), or one blind for every 1428 persons. One institution has been established by government, *Denmark*. i.e. the Royal Institution for the Blind, at Copenhagen; 100 children, aged to and upwards, are here educated. There is a preparatory school for blind children under 10 years of age, and an asylum for blind females, most of whom are former pupils of the royal school. An association for promoting the self-dependence of the blind assists not only former pupils of the school but every blind man or woman willing and able to work.

The number of blind persons in Sweden, according to the census

TABLE IV.—The Blind, by Consanguinity of Parents, Degree of Blindness, and Blind Relatives of Other Classes.

Consanguinity of Parents.	Total.	Blind Brothers, Sisters or Ancestors.	Collateral Relatives or Descendants alone, Blind.	No Blind Relatives or Relatives by Marriage alone, Blind.	Not Stated.
All classes—					
The blind	64,763	8629	2338	46,759	7037
Totally blind	35,645	4378	1215	26,349	3703
Partially blind	29,118	4251	1123	20,410	3334
Parents cousins—					
The blind	2,527	844	149	1,456	78
Totally blind	1,291	435	78	739	39
Partially blind	1,236	409	71	717	39
Parents not cousins—					
The blind	53,980	7395	2095	43,368	1122
Totally blind	29,892	3720	1090	24,541	541
Partially blind	24,088	3675	1005	18,827	581
Consanguinity of parents not stated—					
The blind	8,256	390	94	1,935	5837
Totally blind	4,462	223	47	1,069	3123
Partially blind	3,794	167	47	866	2714

of December 1880, was 3723, being at the rate of one blind person for every 1226 of the general population. At the beginning of the year 1879, the instruction of the blind in Sweden was completely separated from that of the deaf and dumb, on the grounds that it hindered the intellectual development of the blind—a conclusion which experience shows to be tolerably correct. Since

July 1888 the Royal Institution of the Blind has obtained a new building at Tomtebodav, near Stockholm.

The law of the 8th of July 1881, concerning the instruction of abnormal children, has imposed on the state the duty of establishing a sufficient number of schools for the blind in Norway, as well as for the other abnormal children. All the blind of the country, from 9 years of age until the age of 21, are compelled to be educated, with a maximum of 8 years of instruction for each pupil.

The census of 1873 showed that in Finland there were 7959 blind in a total population of about 2,000,000 inhabitants, the proportion reaching the very high figure of one for every 251 of the total population. Nevertheless there were only 160 of school age. For these there are two institutions, one at Helsingfors, where the instruction is given in the Swedish language, and where there are about 12 pupils, and another at Kuopio, where the instruction is given in the Finnish language, and where the pupils number about 30.

According to information received from the I.R. Central Commission for Statistics, the number of blind in the provinces represented in the Austrian Reichsrath amounted to 15,582 in the year 1884. Of these, 2345 were children up to 15 years of age, namely 433 below 5, 779 from 5 to 10, and 1113 from 10 to 15 years. The total number of institutions for blind children in Austria amounts to 8. The blind children of school age who are not placed in special institutions are compulsorily taught in the public general free schools, as far as practicable. The number of blind in the whole dominion of the crown of St Stephen was 208,391.

The number of blind persons in Italy was 21,718, according to the census of 1881, and those of school age were estimated to form 25% of the whole, or about 5429 in number. But no special cognizance of the blind is taken in the government census. There are 20 institutions, schools and workshops for the blind.

Statistics with regard to the number and condition of the blind in the Russian empire are of a very limited character, and it is only of late years that any attempt has been made to draw up any accurate returns with regard to them. The total number of the blind throughout the empire is generally reckoned at from 160,000 to 200,000, thus making 1600 to 2000 per million inhabitants. In Russia there are 21 institutions for the support of the blind.

In Egypt the blind are very numerous in comparison with other countries, and although no exact statistics are at present obtainable on this point, it is computed that the proportion is at least one totally blind person to every 50 of the population.

This is principally the result of acute ophthalmia occurring in infancy, and it is fostered by the superstitious observance which prevents the mothers from washing their children from the time of birth until they are two years old, at which late date only they are weaned. There is also a great deal of infection carelessly and ignorantly conveyed direct from eye to eye, by means of unwashed fingers, and this is accountable for the occurrence of much more eye-disease than any that may be caused by the proverbial flies. The only employment followed by the blind, both Mahomedan and Coptic (or native Christian), and that only to a limited extent, is recitation aloud—the former repeating portions of the Koran at funerals, and the latter chanting the church-ritual in their services; the blind girls and women are without occupation. Practically no education is given to the blind as a class, and anything which they learn has to be acquired orally by frequent repetition. The blind were not always so completely neglected, as the native ecclesiastical authorities (*Wakf*) gave an annual grant of £2000 for the continued maintenance of a school for the blind and the deaf and dumb in Cairo, which taught about 80 day-pupils; the latter years of the school were passed under the ministry of education, and it was ultimately discontinued. Such a condition of affairs appealed to Dr T. R. Armitage, and explains his motive in trying to establish some proper means for affording the blind in Egypt the necessary scholastic instruction and other training. In Egypt, as in other countries, it is occasionally very difficult, and takes some time, to start any enterprise such as this on a satisfactory and practical footing, and it was left for Mrs T. R. Armitage to be the means of successfully carrying out her husband's wishes in this particular. In 1900 Mrs Armitage asked Dr Kenneth Scott to prepare a scheme for the education and welfare of the blind in Egypt, on lines suggested to her. This, through the British and Foreign Blind Association, was submitted to Queen Victoria, who graciously commanded it to be sent, through the foreign office, to the khedive, who in mark of approbation and encouragement generously gave a handsome donation towards its realization. The Institution for the Blind was established at Zeitoun, Cairo, early in the year 1901, through funds provided by Mrs T. R. Armitage. The object of the institution, which is wholly unsectarian in character, is to educate and train the blind mentally and physically and in industrial occupations, and at the same time to improve their moral standard, so that eventually they may become in great measure, or even completely, self-supporting. (Dr Kenneth Scott.)

India has a large proportion of blind inhabitants, ranging from one in 600 in some provinces, to one in 400 in others, with a total of more than half a million. Until recently, little had been done in

the way of organized effort to educate them, though many of the missionaries had helped individual cases. At Amritsar a large and well-organized work for the blind has been carried on for many years. This school has now been moved to

Rajpur, and helps 70 blind women and children. In 1903 a government school and hospital were established at Bombay as a memorial to Queen Victoria. Reading, writing, arithmetic, tailoring, type-writing, carpentering, lathework and carpet-weaving are taught. There are small schools at Parantji, Calcutta, Palancottah, Calicut, Coorg, Chota-Nagpur, and at Moulinein in Burma. The memorial to Queen Victoria in Ceylon took the form of work for the blind. J. Knowles, with the help of L. Garthwaite of the Indian Civil Service, devised a scheme of oriental Braille, which has been adopted by the British and Foreign Bible Society for the production of the Scriptures in Eastern languages.

Blindness is very prevalent in China, and to eye-diseases, neglect and dirt, must be added leprosy and smallpox as causes. Blind beggars may be seen on every highway, clamouring for alms. As in India their pitiful condition attracted the attention of the missionaries. W. H. Murray, a Scottish missionary in Peking, made a simple and ingenious adaptation of the Braille symbols to the complicated system of Chinese printing, in which over 4000 characters are required. It was necessary to represent at least 408 sounds, and each one was given a corresponding Braille number. When a pupil reads the number he knows instantly the sound for which it stands. A school for the blind was established at Peking, and the version of the Scriptures printed at Peking can be read in all the provinces where the Northern Mandarin dialect is spoken (see Miss Gordon Cumming, *The Inventor of the Numeral Type for China*). A Braille code has recently been arranged for Mandarin, based on a system of initials and finals, by Miss Gariand of the China Inland Mission. At Foochow there is a large school for boys and girls in connexion with the Church Missionary Society. At Ningpo, Amoy, Canton and Fukien work for the blind is carried on by the missionaries.

The blind in Japan have long been trained in massage, acupuncture and music, and until recently, with few exceptions, none but the blind engaged in these occupations. From three to five years are required to become proficient in massage, but a blind person is then able to support himself. In Yokohama, with a population of half a million, there are 1000 men and women engaged in massage, and all but about 100 of these are blind. In 1878 a school for the blind and deaf-mutes was established in Kyoto, and soon after one in Tokyo. Japan has four schools for the blind, and seven combined schools for the blind and deaf-mutes.

As in other Eastern countries, blindness is very prevalent in Palestine. Ophthalmic hospitals and medical attendance are now available in the larger towns, and the missionary schools have done much to inculcate habits of cleanliness, therefore there is a slight decrease in the number of the blind. The home and school for blind girls in Jerusalem is the outcome of a day school opened in 1896 by an American missionary. There is also a small school at Urfa under the auspices of the American mission in that town.

EDUCATION

As more sensations are received through the eye than through any other organ, the mind of a blind child is vacant, and the training should begin early or the mind will degenerate.

Indirectly the loss of sight results in inaction. If no one encourages a blind child to move, he will sit quietly in a corner, and when he leaves his seat will move timidly about. This want of activity produces bad physical effects, and further delays mental growth. The blind are often injured, some of them ruined for life, through the ignorance and mistaken kindness of their friends during early childhood. They should be taught to walk, to go up and down stairs, to wash, dress and feed themselves.

They should be carefully taught correct postures and attitudes, and to avoid making grimaces. They should be told the requirements of social conventions which a seeing child learns through watching his elders. They have no consciousness that their habits are disagreeable, and the earlier unsightly mannerisms are corrected the better. It is a fallacy to suppose that the other senses of the blind are naturally sharper than those of the seeing. It is only when the senses of hearing and touch have been cultivated that they partially replace sight, and such cultivation can begin with very young children.

Blind children have a stronger claim upon the public for education than other children, because they start at a disadvantage in life, they carry a burden in their infirmity, they come mostly of poor parents, and without special instruction and training they are almost certain to become a public charge during life.

Public authorities should adopt the most efficient plan for preparing blind children to become active, independent men and women, rather than consider the cheapest and easiest method of educating them. We cannot afford to give the blind an education that is not the best of its kind in the trade or profession they will have to follow. There are many seeing persons with little education who are useful citizens and successful in various industries, but an uneducated blind person is helpless, and must become dependent.

The surroundings of the blind do not favour the development of activity, self-reliance and independence. Parents and friends find it easier to attend to the wants and requirements of their blind children than to teach them to be self-helpful in the common acts of everyday life. A mistaken kindness leads the friends to guard every movement and prevent physical exertion. As a rule, the vitality of the blind is much below the average vitality of seeing persons, and any system of education which does not recognize and overcome this defect will be a failure. It is the lack of energy and determination, not the want of sight, that causes so many failures among the blind.

A practical system of education, which has for its object to make the blind independent and self-sustaining, must be based upon a comprehensive course of physical development. **Physical training.** A blind man who has received mechanical training, general education, or musical instruction, without physical development, is like an engine provided with everything necessary except motive power.

Schools for the blind should be provided with well-equipped gymnasia, and the physical training should include various kinds of mass and apparatus work. Large and suitable playgrounds are also essential. Besides a free space where they can run and play, it should have a supply of swings, tilts, jumping-boards, stilts, chairs-à-bancs, skittle-alleys, &c. Any game that allows of sides being taken adds greatly to the enjoyment, and is a powerful incentive to play. The pupils should be encouraged to enter into various competitions, as walking, running, jumping, leap-frog, sack-racing, shot-pitching, tug-of-war, &c. Cycling, rowing, swimming and roller-skating are not only beneficial but most enjoyable.

The subjects in the school curriculum should be varied according to the age and capacity of the pupils, but those which cultivate the powers of observation and the perceptive faculties should have a first place. **Mental training.** Object lessons or nature study should have a large share of attention. Few people realize that a blind child knows nothing of the size, shape and appearance of common objects that lie beyond the reach of his arm. When he has once been shown how to learn their characteristics, he will go on acquiring a knowledge of his surroundings unaided by a teacher. Again, a careful drill in mental arithmetic, combining accuracy with rapidity, is essential. A good command of English should be cultivated by frequent exercises in composition, and by committing to memory passages of standard prose and poetry. In his secondary course, the choice of subjects must depend upon his future career. Above all, stimulate a love of good reading.

From the earliest years manual dexterity should be cultivated by kindergarten work, modelling, sewing, knitting and loyld.

Blind children who have not had the advantage of this early handwork find much more difficulty when they begin a regular course in technical training. **Early manual training.** Early manual training cultivates the perceptive faculties, gives activity to the body, and prepares the hands and fingers for pianoforte-playing, pianoforte-tuning and handicrafts.

Besides a good general education, the blind must have careful and detailed training in some handicraft, or thorough preparation for some profession. The trades and professions open to them are few, and if they fall in one of these they cannot turn quickly to some other line of work. Those who have charge of their education should avail themselves of the knowledge that has been gained in all countries, in order to decide wisely in regard to the trade or occupation for which each pupil should be prepared. It may be some kind

of handicraft, pianoforte-tuning, school-teaching, or the profession of music; the talent and ability of each child should be carefully considered before finally deciding his future occupation. The failure to give the blind a practical education often means dependence through life.

Pianoforte-tuning as an employment for the blind originated in Paris. About 1830 Claud Montal and a blind fellow-pupil attempted to tune a piano. The seeing tuner in charge of the school pianos complained to the director, and they were forbidden to touch the works, but the two friends procured an old piano and continued their efforts. Finally, the director, convinced of their skill, gave them charge of all the school pianos, and classes were soon started for the other pupils. When Montal left the institution he encountered great prejudice, but his skill in tuning became known to the professors of the Conservatoire, and his work rapidly increased and success was assured. Montal afterwards established a manufactory, and remained at its head for many years. Tuning is an excellent employment for the blind, and one in which they have certain advantages. The seeing who excel in the business go through a long apprenticeship, and one must give the blind even more careful preparation. They must work a number of hours daily, under suitable tuition, for several years. After a careful examination by an expert pianoforte-tuning authority, every duly qualified tuner should be furnished with an official certificate of proficiency, and tuners who cannot take the required examinations ought not to be allowed to impose upon the public.

Music in its various branches, when properly taught, is the best and most lucrative employment for the blind. To become successful in the profession, it is necessary for the blind to have opportunities of instruction, practice, study, and hearing music equal to those afforded the seeing, with whom they will have to compete in the open market. **Musical training.** If the blind musician is to rise above mediocrity, systematic musical instruction in childhood is indispensable, and good instruction will avail little unless the practice is under constant and judicious supervision. The musical instruction, in its several branches of harmony, pianoforte, organ and vocal culture, must be addressed to the mind, not merely to the ear. This is the only possible method by which musical training can be made of practical use to the blind. The blind music teacher or organist must have a well-disciplined mind, capable of analysing and dealing with music from an intellectual point of view. If the mental faculties have not been developed and thoroughly disciplined, the blind musician, however well he may play or sing, will be a failure as a teacher. The musical instruction must be more thorough, more analytical, more comprehensive, than corresponding instruction given to seeing persons. In 1871 Dr Armitage published a book on the education and employment of the blind, in which he stated that of the blind musicians trained in the United Kingdom not more than one-half per cent were able to support themselves, whereas of those trained in the Paris school 30 % supported themselves fully, and 30 % partially, by the profession of music.

To provide a better education and improve the musical training of the blind, the Royal Normal College was established in 1872.¹ Its object was to afford the young blind a thorough general and musical education, to qualify them to earn a living by various intellectual pursuits, especially as organists, pianists, teachers and pianoforte-tuners. From the first, the founders of the college maintained that the blind could only be made self-sustaining by increasing their intelligence, bodily activity and dexterity, by inculcating business habits, by arousing their self-respect, and by creating in their minds a belief in the possibility

¹ Its principal (responsible, with Dr Armitage, the duke of Westminster and others, for its foundation) was Sir F. J. Campbell, LL.D., F.R.G.S., F.S.A., educated a blind man, who, born in Tennessee, U.S.A., in 1812, and educated at the Nashville school, and afterwards in music at Leipzig and Berlin, had from 1858 to 1869 been associated with Dr Howe at the Perkins Institution, Boston. He was knighted in 1909.

of future self-maintenance. A kindergarten department was opened in 1881. In July 1896 Queen's Scholarship examinations were held at the Royal Normal College, for the first time, for blind students, and the institution recognized by the Education Department as a training college for blind school-teachers.

From the first day a pupil enters school until he finishes his course of training, care must be taken to implant business habits.

Blind children are allowed to be idle and helpless at home; they do not learn to appreciate the value of time, and in after years this is one of the most difficult lessons to inculcate. Having drifted through childhood, they are content to drift through life. The important habits of punctuality, regularity and precision should be cultivated in all the arrangements and requirements. A great effort should be made to lift the blind from pauperism. As soon as pupils enter a school, all semblance of pauper origin should be removed. They must be inspired with a desire for independence and a belief in its possibility. In the public mind blindness has been so long and closely associated with dependence and pauperism that schools for the blind, even the most progressive, have been regarded hitherto as asylums rather than educational establishments. A sad mistake in the training of the blind is the lack of an earnest effort to improve their social condition. The fact that their education has been left to charity has helped to keep them in the ranks of dependents.

The question of day-classes versus boarding-schools has been much discussed. It is claimed by some that a blind child gains more independence if kept at home and educated in a school with the seeing. This theory is not verified by practical experience. At home its blindness makes the child an exception, and often it takes little or no part in the active duties of everyday life. Again, in a class of seeing children the blind member is treated as an exception. The memory is cultivated at the expense of the other faculties, and the facility with which it recites in certain subjects causes it to make a false estimate of its attainments. The fundamental principles in different branches are imperfectly understood, from the failure to follow the illustrations of the teacher. In the playgrounds, a few irrepresibles join in active games, but most of the blind children prefer a quiet corner.

For the sake of economy, schools for deaf-mutes and the blind are sometimes united. As the requirements of the two classes are entirely separate and distinct, the union is undesirable, whether for general education or industrial training. The plan was tried in America, but has been given up in most of the states. To meet the difficulty of proper classification with small numbers, blind boys and girls are taught in the same classes. The acquaintances then made lead to intimacy in later years and foster intermarriage among the blind. Intermarriage among the blind is a calamity, both for them and for their children; some who might have been successful business men are to-day begging in the streets in consequence of intermarriage.

In every school or class there will be a certain number of young blind children who, from neglect, want of food, or other causes, are feeble in body and defective in intellect; such children are a great burden in any class or school, and require special treatment and instruction. Educational authorities should unite and have one or two schools in a healthful locality for mentally defective blind children.

More and more, in educational work for the seeing, there is a tendency to specialize, and thus enable each student to have the best possible instruction in the subjects that bear most directly on his future calling. To prepare the blind for self-maintenance, there should be an equally careful study of the ability of each child.

A scheme of education which has for its object to make the blind a self-sustaining class should include: kindergarten schools for children from 5 to 8 years of age; preparatory schools from 8 to 11; intermediate schools from 11 to 14. At 14 an intelligent opinion can be formed in regard to the future career of the pupils. They will fall naturally into the following categories:—(a) A certain number will succeed better in

handicraft than in any other calling, and should be drafted into a suitable mechanical school. (b) A few will have special gifts for general business, and should be educated accordingly. (c) A few will have the ability and ambition to prepare for the university, and the special college should afford them the most thorough preparation for the university examinations. (d) Some will have the necessary talent, combined with the requisite character and industry, to succeed in the musical profession; in addition to a liberal education, these should have musical instruction, equal to that given to the seeing, in the best schools of music. (e) Some may achieve excellent success as pianoforte-tuners, and in a pianoforte-tuning school strict business habits should be cultivated, and the same attention to work required as is demanded of seeing workmen in well-regulated pianoforte factories.

The United Kingdom stands almost alone in allowing the education of the blind to depend upon charity. In the United States, each state government not only makes liberal provision for the education and training of the blind, but most of them provide grounds, buildings and a complete equipment in all departments. Although it costs much more *per capita*, from £40 to £60 per annum, the blind are as amply provided with the means of education as the seeing. The government of the United States appropriates \$10,000 per annum for printing embossed books for the blind. Most of the European countries and the English colonies provide by taxation for the education of the blind.

TYPES

The earliest authentic records of tangible letters for the blind describe a plan of engraving the letters upon blocks of wood, the invention of Francesco Lucas, a Spaniard, who dedicated it to Philip II. of Spain in the 16th century. In 1640 Pierre Moreau, a writing-master in Paris, cast a movable leaden type for the use of the blind, but being without means to carry out his plan, abandoned it. Pins inserted in cushions were next tried, and large wooden letters. After these came a contrivance of Du Puisieux, a blind man, who had metal letters cast and set them in a small frame with a handle. Whilst these experiments were going on in France, attempts had also been made in Germany. R. Weissenbourg (a resident of Mannheim), who lost his sight when about seven years of age, made use of letters cut in cardboard, and afterwards pricked maps in the same material. By this method he taught Mlle Paradis, the talented blind musician and the friend of Valentin Haüy.

To Haüy belongs the honour of being the first to emboss paper as a means of reading for the blind; his books were embossed in large and small italics, from movable type set by his pupils. The following is an account of the origin of his discovery. Haüy's first pupil was François Lesueur, a blind boy whom he found begging at the porch door of St Germain des Prés. While Lesueur was sorting the papers on his teacher's desk, he came across a card strongly indented by the types in the press. The blind lad showed his master he could decipher several letters on the card. Immediately Haüy traced with the handle of his pen some signs on paper. The boy read them, and the result was printing in relief, the greatest of Haüy's discoveries. In 1821 Lady Elizabeth Lowther brought embossed books and types from Paris, and with the types her son, Sir Charles Lowther, Bart., printed for his own use the Gospel of St Matthew. The work of Haüy was taken up by Mr Gall of Edinburgh, Mr Alston of Glasgow, Dr Howe of Boston, Mr Friedlander of Philadelphia, and others. In 1827 James Gall of Edinburgh embossed some elementary works, and published the Gospel of St John in 1834. His plan was to use the common English letter and replace curves by angles.

In 1832 the Edinburgh Society of Arts offered a gold medal for the best method of printing for the blind, and it was awarded to Dr Edmond Fry of London, whose alphabet consisted of ordinary capital letters without their small strokes. In 1836 the Rev. W. Taylor of York and John Alston in Glasgow began to print with Fry's type. Mr Alston's appeal for a printing fund met with a hearty response, and a grant of £400 was made by the treasury;

In 1838 he completed the New Testament, and at the end of 1840 the whole Bible was published in embossed print. In 1833 printing for the blind was commenced in the United States at Boston and Philadelphia. Dr S. G. Howe in Boston used small English letters without capitals, angles being employed instead of curves, while J. R. Friedlander in Philadelphia used only

right-hand row in which vertical line, of the printed table the speech sound is to be found.

Louis Braille, a pupil and afterwards a professor of the Institution Nationale des Jeunes Aveugles, Paris, studied all the various methods in which arbitrary characters were used. Barbier's letter, although it gave a large number of combinations, was too long to be covered by the finger in reading, and Louis Braille reduced the number of dots. In 1834 Braille perfected his system. Dr Armitage considered it was the greatest advance that had ever been made in the education of the blind.

The Braille alphabet consists of varying combinations of six dots in an oblong, of which the vertical side contains three, and the horizontal two dots . There are 63 possible combinations of these six dots, and after the letters of the alphabet have been supplied, the remaining signs are used for punctuation, contractions, &c.

"For writing, a ruler is used, consisting of a metal bed either grooved or marked by groups of little pits, each group consisting of six; over this bed is fitted a brass guide, punched with oblong holes whose vertical diameter is three-tenths of an inch, while the horizontal diameter is two-tenths. The pits are arranged in two parallel lines, and the guide is hinged on the bed in such a way that when the two are locked together the openings in the guide correspond exactly to the pits in the bed. The brass guide has a double row of openings, which enables the writer to write two lines; when these are written, he shifts his guide downwards until two little pins, which project from the under surface at its ends, drop into corresponding holes of a wooden board; then two more lines are written, and this operation is repeated until the bottom of the page is reached. The paper is introduced between the frame and the metal bed. The instrument for writing is a blunt awl, which carries a little cap of paper before it into the grooves or pits of the bed, thereby producing a series of little pits in the paper on the side next the writer. When taken out and turned over, little prominences are felt, corresponding to the pits on the other side. The reading is performed from left to right, consequently the writing is from right to left; but this reversal presents no practical difficulty as soon as the pupil had caught the idea that in reading and writing alike he has to go *forwards*.

"The first ten letters, from 'a' to 'j', are formed in the upper and middle grooves; the next ten, from 'k' to 't', are formed by adding one lower back dot to each letter of the first series; the third row is formed from the first by adding two lower dots to each letter; the fourth row, similarly, by adding one lower front dot.

"The first ten letters, when preceded by the prefix for numbers, stand for the nine numbers and the cipher. The same signs, written in the lower and middle grooves, instead of the upper and middle, serve for punctuation. The seven last letters of each series stand for the seven musical notes—the first series representing quavers, the second minims, the third semibreves, the fourth crotchets. Rests, accidentals, and every other sign used in music can be readily and clearly expressed without having recourse to the staff of five lines which forms the basis of ordinary musical notation, and which, though it has been reproduced for the blind, can only be considered as serving to give them an

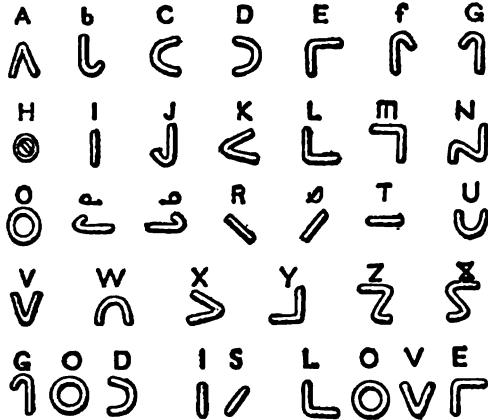
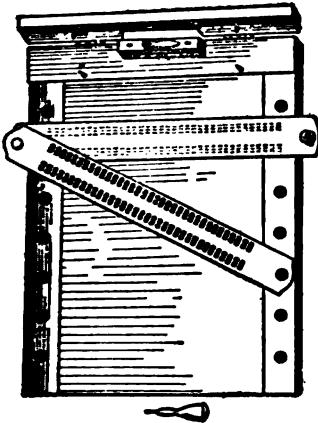

FIG. 1.—Moon Alphabet.

Roman capitals. About 1838 T. M. Lucas of Bristol, a shorthand writer, and J. H. Frere of Blackheath, each introduced an alphabet of simpler forms, and based their systems on stenography. In 1847 Dr Moon of Brighton brought out a system which partially retains the outline of the Roman letters. This type is easily read by the adult blind, and is still much used by the home teaching societies. The preceding methods are all known as line types, but the one which is now in general use is a point type.

In the early part of the 19th century Captain Charles Barbier,



Apparatus for writing Braille.

1st. Line	A	B	C	D	E	F	G	H	I	J
2nd. Line	K	L	M	N	O	P	Q	R	S	T
3rd. Line	U	V	X	Y	Z	and	for	of	the	with
4th. Line	th	th	th	th	wh	ed	er	on	ow	W

Braille Alphabet. The black dots represent the raised points of the sign in their position in relation to the group of six.

FIG. 2.

a French officer, substituted embossed dots for embossed lines. The slate for writing was also invented by him.

Barbier arranged a table of speech sounds, consisting of six lines with six sounds in each line. His rectangular cell contained two vertical rows of six points each. The number of points in the left-hand row indicates in which horizontal line, and that in the

idea of the method employed by the seeing, and cannot, of course, be written. By means of this dotted system, a blind man is able to keep memoranda or accounts, write his own music, emboss his own books from dictation, and carry on correspondence."

The Braille system for literature and music was brought into general use in England by Dr T. R. Armitage. Through his wise,

Man's World [translated by Ernest Thomson] (Paris, 1904); Prof. A. Mell, *Encyclopädisches Handbuch des Blindenwesens* (Vienna, 1899). (F. J. C.)

BLISS, CORNELIUS NEWTON (1833—), American merchant and politician, was born at Fall River, Massachusetts, on the 26th of January 1833. He was educated in his native city and in New Orleans, where he early entered his step-father's counting-house. Returning to Massachusetts in 1849, he became a clerk and subsequently a junior partner in a prominent Boston commercial house. Later he removed to New York City to establish a branch of the firm. In 1881 he organized and became president of Bliss, Fabyan & Company, one of the largest wholesale dry-goods houses in the country. A consistent advocate of the protective tariff, he was one of the organizers, and for many years president, of the American Protective Tariff League. In politics an active Republican, he was chairman of the Republican state committee in 1887 and 1888, and contributed much to the success of the Harrison ticket in New York in the latter year. He was treasurer of the Republican national committee from 1892 to 1904, and was secretary of the interior in President McKinley's cabinet from 1897 to 1899.

BLISTER (a word found in many forms in Teutonic languages, cf. Ger. *Blase*; it is ultimately connected with the same root as in "blow," cf. "bladder"), a small vesicle filled with serous fluid raised on the skin by a burn, by rubbing on a hard surface, as on the hand in rowing, or by other injury; the term is also used of a similar condition of the skin caused artificially, as a counter-irritant in cases of inflammation, by the application of mustard, of various kinds of fly (see *CANTHARIDES*) and of other vesicatories. Similar small swellings, filled with fluid or air, on plants and on the surface of steel or paint, &c., are also called "blisters."

BLIZZARD (origin probably onomatopoeic, cf. "blast," "bluster"), a furious wind driving fine particles of choking, blinding snow whirling in icy clouds. The conditions to which the name was originally given occur with the northerly winds in rear of the cyclones crossing the eastern states of America during winter.

BLOCH, MARK ELIEZER (c. 1723—1799), German naturalist, was born at Ansbach, of poor Jewish parents, about 1723. After taking his degree as doctor at Frankfurt-on-Order he established himself as a physician at Berlin. His first scientific work of importance was an essay on intestinal worms, which gained a prize from the Academy of Copenhagen, but he is best known by his important work on fishes (see *ICHTHYOLOGY*). Bloch was fifty-six when he began to write on ichthyological subjects. To begin at his time of life a work in which he intended not only to give full descriptions of the species known to him from specimens or drawings, but also to illustrate each species in a style truly magnificent for his time, was an undertaking the execution of which most men would have despaired of. Yet he accomplished not only this task, but even more than he at first contemplated. He died at Carlsbad on the 6th of August 1799.

BLOCK, MAURICE (1816—1901), French statistician, was born in Berlin of Jewish parents on the 18th of February 1816. He studied at Bonn and Giessen, but settled in Paris, becoming naturalized there. In 1844 he entered the French ministry of agriculture, becoming in 1852 one of the heads of the statistical department. He retired in 1862, and thenceforth devoted himself entirely to statistical studies, which have gained for him a wide reputation. He was elected a member of the Academie des Sciences Morales et Politiques in 1880. He died in Paris on the 9th of January 1901. His principal works are: *Dictionnaire de l'administration française* (1856); *Statistique de la France* (1860); *Dictionnaire général de la politique* (1862); *L'Europe politique et sociale* (1869); *Traité théorique et pratique de statistique* (1878); *Les Progrès de l'économie politique depuis Adam Smith* (1890); he also edited from 1856 *L'Annuaire de l'économie politique et de la statistique*, and wrote in German *Die Bevölkerung des französischen Kaiserreichs* (1861); *Die Bevölkerung Spaniens und Portugals* (1861); and *Die Machtstellung der europäischen Staaten* (1862).

BLOCK (from the Fr. *Bloc*, and possibly connected with an Old Ger. *Block*, obstruction, cf. "balk"), a piece of wood. The word is used in various senses, e.g. the block upon which people were beheaded, the block or mould upon which a hat is shaped, a pulley-block, a printing-block, &c. From the sense of a solid mass comes the expression, a "block" of houses, i.e. a rectangular space covered with houses and bounded by four streets. From the sense of "obstruction" comes a "block" in traffic, a block in any proceedings, and the block system of signalling on railways.

BLOCKADE (Fr. *Blockade*, Ger. *Blockade*), a term used in maritime warfare. Originally a blockade by sea was probably nothing more than the equivalent in maritime warfare of a blockade or siege on land in which the army investing the blockaded or besieged place is in actual physical possession of a zone through which it can prevent and forbid ingress and egress. An attempt to cross such a zone without the consent of the investing army would be an act of hostility against the besiegers. A maritime blockade, when it formed part of a siege, would obviously also be a close blockade, being part of the military cordon drawn round the besieged place. Even from the first, however, differences would begin to grow up in the conditions arising out of the operations on land and on sea. Thus whereas conveying merchandise across military lines would be a deliberate act of hostility against the investing force, a neutral ship which had sailed in ignorance of the blockade for the blockaded place might in good faith cross the blockade line without committing a hostile act against the investing force. With the development of recognition of neutral rights the involuntary character of the breach would be taken into account, and notice to neutral states and to approaching vessels would come into use. With the employment in warfare of larger vessels in the place of the more numerous small ones of an earlier age, notice, moreover, would tend to take the place of *de facto* investment, and at a time when communication between governments was still slow and precarious, such notice would sometimes be given as a possible measure of belligerent tactics before the blockade could be actually carried out. Out of these circumstances grew up the abuse of "paper blockades."

The climax was reached in the "Continental Blockade" decreed by Napoleon in 1806, which continued till it was abolished by international agreement in 1812. This blockade forbade all countries under French dominion or allied with France to have any communication with Great Britain. Great Britain replied in 1807 by a similar measure. The first nation to protest against these fictitious blockades was the United States. Already in 1800 John Marshall, secretary of state, wrote to the American minister in Great Britain pointing out objections which have since been universally admitted. In the following interesting passage he said:—

"Ports not effectually blockaded by a force capable of completely investing them have yet been declared in a state of blockade. . . . If the effectiveness of the blockade be dispensed with, then every port of the belligerent powers may at all times be declared in a state of blockade, and the commerce of neutrals be thereby subjected to universal capture. But if this principle be strictly adhered to, the capacity to blockade will be limited by the naval force of the belligerent and, in consequence, the mischief to neutral commerce cannot be very extensive. It is, therefore, of the last importance to neutrals that this principle be maintained unimpaired. I observe that you have pressed this reasoning on the British minister, who replies that an occasional absence of a fleet from a blockaded port ought not to change the state of the place. Whatever force this observation may be entitled to, where that occasional absence has been produced by an accident, as a storm, which for a moment blows off a fleet and forces it from its station, which station it immediately resumes, I am persuaded that where a part of the fleet is applied, though only for a time, to other objects or comes into port, the very principle requiring an effective blockade, which is that the mischief can only be coextensive with the naval force of the belligerent, requires that during such temporary absence the commerce to the neutrals to the place should be free."¹

¹ John Marshall, secretary of state, to Rufus King, minister to England, 20th of September 1800, Am. State Papers, Class I, For. Rel. II, No. 181, J. B. Moore, *Digest of International Law*, vii, 788.

Again in 1803 James Madison wrote to the then American minister in London:—

"The law of nations requires to constitute a blockade that there should be the presence and position of a force rendering access to the prohibited place manifestly difficult and dangerous."

In 1836 and 1837 Great Britain as well as the United States asserted that blockades in order to be binding must be effective. This became gradually the recognized view, and when in 1856 the powers represented at the congress of Paris inserted in the declaration there adopted that "blockades in order to be binding must be effective, that is to say, maintained by a force sufficient really to prevent access to the coast of an enemy," they were merely enunciating a rule which neutral states had already become too powerful to allow belligerents to disregard.

Blockade is universally admitted to be a belligerent right to which under international law neutrals are obliged to submit. It is now also universally admitted that the above-quoted rule of the Declaration of Paris forms part of international law, independently of the declaration. Being, however, exclusively a belligerent right, it cannot be exercised except by a belligerent force. Even a *de facto* belligerent has the right to institute a blockade binding on neutrals if it has the means of making it effective, though the force opposed to it may treat the *de facto* belligerent as rebels.

It is also admitted that, being exclusively a belligerent right, it cannot be exercised in time of peace, but there has been some inconsistency in practice (see PACIFIC BLOCKADE) which will probably lead governments, in order to avoid protests of neutral powers against belligerent rights being exercised in mere coercive proceedings, to exercise all the rights of belligerents and carry on *de facto* war to entitle them to use violence against neutral infringers. This was done in the case of the blockade of Venezuela by Great Britain, Germany and Italy in 1902-1903.

The points upon which controversy still arises are as to what constitutes an "effective" blockade and what a sufficient notice of blockade to warrant the penalties of violation, viz. confiscation of the ship and of the cargo unless the evidence demonstrates the innocence of the cargo owners. A blockade to be effective must be maintained by a sufficient force to prevent the entrance of neutral vessels into the blockaded port or ports, and it must be duly proclaimed. Subject to these principles being complied with, "the question of the legitimacy and effectiveness of a blockade is one of fact to be determined in each case upon the evidence presented" (Thomas F. Bayard, American secretary of state, to Messrs Kamer & Co., 19th of February 1886). The British manual of naval prize law sums up the cases in which a blockade, validly instituted, ceases to be effectively maintained, as follows:—(1) If the blockading force abandons its position, unless the abandonment be merely temporary or caused by stress of weather, or (2) if it be driven away by the enemy, or (3) if it be negligent in its duties, or (4) if it be partial in the execution of its duties towards one ship rather than another, or towards the ships of one nation rather than those of another. These cases, however, are based on decisions of the British admiralty court and cannot be relied on absolutely as a statement of international law.

As regards notice the following American instructions were given to blockading officers in June 1808:—

"Neutral vessels are entitled to notification of a blockade before they can be made prize for its attempted violation. The character of this notification is not material. It may be actual, as by a vessel of the blockading force, or constructive, as by a proclamation of the government maintaining the blockade, or by common notoriety. If a neutral vessel can be shown to have had notice of the blockade in any way, she is good prize, and should be sent in for adjudication; but should formal notice not have been given, the rule of constructive knowledge arising from notoriety should be construed in a manner liberal to the neutral.

"Vessels appearing before a blockaded port, having sailed without notification, are entitled to actual notice by a blockading vessel.

They should be boarded by an officer, who should enter in the ship's log the fact of such notice, such entry to include the name of the blockading vessel giving notice, the extent of the blockade, the date and place, verified by his official signature. The vessel is then to be set free; and should she again attempt to enter the same or any other blockaded port as to which she has had notice, she is good prize. Should it appear from a vessel's clearance that she sailed after notice of blockade had been communicated to the country of her port of departure, or after the fact of blockade had, by a fair presumption, become commonly known at that port, she should be sent in as a prize."

The passages in italics are not in accordance with the views held by other states, which do not recognize the binding character of a diplomatic notification or of constructive notice from notoriety.

The subject was brought up at the second Hague Conference (1907). The Italian and Mexican delegations submitted projects, but after a declaration by the British delegate in charge of the subject (Sir E. Satow) that blockade not having been included in the Russian programme, his government had given him no instructions upon it, the subject, at his suggestion, was dropped. A *Veto*, however, was adopted in favour of formulating rules on all branches of the laws and customs of naval war, and a convention was agreed to for the establishment of an international Prize Court (see PRIZE). Under Art. 7 of the latter convention the Court was to apply the "rules of international law," and in their absence the "general principles of justice and equity." As soon as possible after the close of the second Hague Conference the British government took steps to call a special conference of the maritime powers, which sat from December 4, 1908 to February 26, 1909. Among the subjects dealt with was Blockade, the rules relating to which are as follow:—

Art. 1. A blockade must not extend beyond the ports and coasts belonging to or occupied by the enemy.

Art. 2. In accordance with the Declaration of Paris of 1856, a blockade, in order to be binding, must be effective—that is to say, it must be maintained by a force sufficient really to prevent access to the enemy coastlines.

Art. 3. The question whether a blockade is effective is a question of fact.

Art. 4. A blockade is not regarded as raised if the blockading force is temporarily withdrawn on account of stress of weather.

Art. 5. A blockade must be applied impartially to the ships of all nations.

Art. 6. The commander of a blockading force may give permission to a warship to enter, and subsequently to leave, a blockaded port.

Art. 7. In circumstances of distress, acknowledged by an officer of the blockading force, a neutral vessel may enter a place under blockade and subsequently leave it, provided that she has neither discharged nor shipped any cargo there.

Art. 8. A blockade, in order to be binding, must be declared in accordance with Article 9, and notified in accordance with Articles 11 and 16.

Art. 9. A declaration of blockade is made either by the blockading power or by the naval authorities acting in its name. It specifies (1) the date when the blockade begins; (2) the geographical limits of the coastline under blockade; (3) the period within which neutral vessels may come out.

Art. 10. If the operations of the blockading power, or of the naval authorities acting in its name, do not tally with the particulars, which, in accordance with Article 9 (1) and (2), must be inserted in the declaration of blockade, the declaration is void, and a new declaration is necessary in order to make the blockade operative.

Art. 11. A declaration of blockade is notified: (1) to neutral powers, by the blockading power by means of a communication addressed to the governments direct, or to their representatives accredited to it; (2) to the local authorities, by the officer commanding the blockading force. The local authorities will, in turn, inform the foreign consular officers at the port or on the coastline under blockade as soon as possible.

Art. 12. The rules as to declaration and notification of blockade apply to cases where the limits of a blockade are extended, or where a blockade is re-established after having been raised.

Art. 13. The voluntary raising of a blockade, as also any restriction in the limits of a blockade, must be notified in the manner prescribed by Article 11.

Art. 14. The liability of a neutral vessel to capture for breach of blockade is contingent on her knowledge, actual or presumptive, of the blockade.

Art. 15. Failing proof to the contrary, knowledge of the blockade is presumed if the vessel left a neutral port subsequently to the notification of the blockade to the power to which such port belongs, provided that such notification was made in sufficient time.

¹ James Madison, secretary of state, to Mr Thornton, 27th of October 1803. 14 M.S. Dom. Let. 215. Moore, *Digest of International Law*, vii. 78p.

Art. 16. If a vessel approaching a blockaded port has no knowledge, actual or presumptive, of the blockade, the notification must be made to the vessel itself by an officer of one of the ships of the blockading force. This notification should be entered in the vessel's logbook, and must state the day and hour, and the geographical position of the vessel at the time. If through the negligence of the officer commanding the blockading force no declaration of blockade has been notified to the local authorities, or if in the declaration, as notified, no period has been mentioned within which neutral vessels may come out, a neutral vessel coming out of the blockaded port must be allowed to pass free.

Art. 17. Neutral vessels may not be captured for breach of blockade except within the area of operations of the warships detailed to render the blockade effective.

Art. 18. The blockading forces must not bar access to neutral ports or coasts.

Art. 19. Whatever may be the ulterior destination of a vessel or of her cargo, she cannot be captured for breach of blockade, if, at the moment, she is on her way to a non-blockaded port.

Art. 20. A vessel which has broken blockade outwards, or which has attempted to break blockade inwards, is liable to capture so long as she is pursued by a ship of the blockading force. If the pursuit is abandoned, or if the blockade is raised, her capture can no longer be effected.

Art. 21. A vessel found guilty of breach of blockade is liable to condemnation. The cargo is also condemned, unless it is proved that at the time of the shipment of the goods the shipper neither knew nor could have known of the intention to break the blockade. (T. Ba.)

BLOCKHOUSE, in fortification, a small roofed work serving as a fortified post for a small garrison. The word, common since 1500, is of uncertain origin, and was applied to what is now called a *fort d'arrêt*, a detached fort blocking the access to a landing, channel, pass, bridge or defile. The modern blockhouse is a building, sometimes of two storeys, which is loopholed on all sides, and not infrequently, in the case of two-storey blockhouses, provided with a *mâchicoulis* gallery. Blockhouses are built of wood, brick, stone, corrugated iron or any material available. During the South African War (1899-1902) they were often sent from England to the front in ready-made sections.

BLOEMAERT, ABRAHAM (1564-1651), Dutch painter and engraver, was born at Gorinchem, the son of an architect. He was first a pupil of Gerrit Splinter (pupil of Frans Floris) and of Joes de Beer, at Utrecht. He then spent three years in Paris, studying under several masters, and on his return to his native country received further training from Hieronymus Francken. In 1591 he went to Amsterdam, and four years later settled finally at Utrecht, where he became dean of the Guild of St Luke. He excelled more as a colourist than as a draughtsman, was extremely productive, and painted and etched historical and allegorical pictures, landscapes, still-life, animal pictures and flower pieces. Among his pupils are his four sons, Hendrick, Frederick, Cornelis and Adriaan (all of whom achieved considerable reputation as painters or engravers), the two Honthorsts and Jacob G. Cuyp.

BLOEMEN, JAN FRANS VAN (1662-1740), Flemish painter, was born at Antwerp, and studied and lived in Italy. At Rome he was styled *Orizonte*, on account of his painting of distance in his landscapes, which are reminiscent of Gaspard Poussin and much admired. His brothers Pieter (1657-1719), styled *Standaart* (from his military pictures), and Norbert (1670-1746), were also well-known painters.

BLOEMFONTEIN, capital of the Orange Free State, in 29° 8' S., 26° 18' E. It is situated on the open veld, surrounded by a few low kopjes, 4518 ft. above the sea, 105 m. by rail E. by S. of Kimberley, 750 N.E. by E. of Cape Town, 450 N. by E. of Port Elizabeth, and 257 S.W. of Johannesburg.

Bloemfontein is a very pleasant town, regularly laid out with streets running at right angles and a large central market square. Many of the houses are surrounded by large wooded gardens. Through the town runs the Bloemspuit. After a disastrous flood in 1904 the course of this spring was straightened and six stone bridges placed across it. There are several fine public buildings, mostly built of red brick and a fine-grained white stone quarried in the neighbourhood. The Raadzaal, a building in the Renaissance style, faces Market Square. Formerly the meeting-place of the Orange Free State Raad, it is now the seat

of the provincial council. In front of the old Raadzaal (used as law courts) is a statue of President Brand. In Douglas Street is an unpretentious building used in turn as a church, a raadzaal, a court-house and a museum. In it was signed (1854) the convention which recognized the independence of the Free State Boers (see ORANGE FREE STATE: *History*). Among the churches the most important, architecturally, are the Dutch Reformed, a building with two spires, and the Anglican cathedral, which has a fine interior. The chief educational establishment is Grey University College, built 1906-1908 at a cost of £125,000. It stands in grounds of 300 acres, a mile and a half from the town. In the town is the original Grey College, founded in 1856 by Sir George Grey, when governor of Cape Colony. The post and telegraph office in Market Square is one of the finest buildings in the town. The public library is housed in a handsome building in Warden Street. Opposite it is the new national museum.

Bloemfontein possesses few manufactures, but is the trading centre of the province. Having a dry healthy climate, it is a favourite residential town and a resort for invalids, being recommended especially for pulmonary disease. The mean maximum temperature is 76.7° Fahr., the mean minimum 45.8°; the mean annual rainfall about 24 in. There is an excellent water-supply, obtained partly from Bloemspuit, but principally from the Modder river at Sanna's Post, 22 m. to the east, and from reservoirs at Moches Dam and Magdepoort.

The population in 1904 was 33,883, of whom, including the garrison of 3487, 15,501 were white, compared with a white population of 2077 in 1890. The coloured inhabitants are mostly Bechuana and Basuto. Most of the whites are of British origin, and English is the common language of all, including the Dutch.

The *spruit* or spring which gives its name to the town was called after one of the emigrant farmers, Jan Bloem. The town dates from 1846, in which year Major H. D. Warden, then British resident north of the Orange, selected the site as the seat of his administration. When in 1854 independence was conferred on the country the town was chosen by the Boers as the seat of government. It became noted for the intelligence of its citizens, and for the educational advantages it offered at the time when education among the Boers was thought of very lightly. In 1892 the railway connecting it with Cape Town and Johannesburg was completed. During the Anglo-Boer War of 1899-1902 it was occupied by the British under Lord Roberts without resistance (13th of March 1900), fourteen days after the surrender of General Cronje at Paardeberg. In Market Square on the 28th of the following May the annexation of the Orange Free State to the British dominions was proclaimed. In 1907 the first session of the first parliament elected under the constitution granting the colony self-government was held in Bloemfontein. In 1910 when the colony became a province of the Union of South Africa under its old designation of Orange Free State, Bloemfontein was chosen as the seat of the Supreme Court of South Africa. Its growth as a business centre after the close of the war in 1902 was very marked. The rateable value increased from £700,000 in 1901 to £2,400,000 in 1905.

BLOET, ROBERT (d. 1123), English bishop, was chancellor to William I. and Rufus. From the latter he received the see of Lincoln (1093) in succession to Remigius. His private character was indifferent; but he administered his see with skill and prudence, built largely, and kept a magnificent household, which served as a training-school even for the sons of nobles. Bloet was active in assisting Henry I. during the rebellion of 1102, and became that monarch's justiciar. Latterly, however, he fell out of favour, and, although he had been very rich, was impoverished by the fines which the king extorted from him. Perhaps his wealth was his chief offence in the king's eyes; for he was in attendance on Henry when seized with his last illness. He was the patron of the chronicler Henry of Huntingdon, whom he advanced to an archdeaconry.

Henry of Huntingdon and W. Malmsbury (*De Gestis Pontificum*) are original authorities. See E. A. Freeman's *William Rufus*; Sir James Ramsay, *The Foundations of England*, vol. ii. (H. W. C. D.)

BLOIS, LOUIS DE (1506-1566), Flemish mystical writer, generally known under the name of **BLOSIUS**, was born in October 1506 at the château of Donstienne, near Liège, of an illustrious family to which several crowned heads were allied. He was educated at the court of the Netherlands with the future emperor Charles V. of Germany, who remained to the last his staunch friend. At the age of fourteen he received the Benedictine habit in the monastery of Liessies in Hainaut, of which he became abbot in 1530. Charles V. pressed in vain upon him the archbishopric of Cambrai, but Blosius studiously exerted himself in the reform of his monastery and in the composition of devotional works. He died at his monastery on the 7th of January 1566.

Blosius's works, which were written in Latin, have been translated into almost every European language, and have appealed not only to Roman Catholics, but to many English laymen of note, such as W. E. Gladstone and Lord Coleridge. The best editions of his collected works are the first edition by J. Frojus (Louvain, 1568), and the Cologne reprints (1572, 1587). His best-known works are:—the *Institutio Spiritualis* (Eng. trans., *A Book of Spiritual Instruction*, London, 1900); *Consolatio Pusillanimitatis* (Eng. trans., *Comfort for the Faint-Hearted*, London, 1903); *Sacellum Animae Fidelis* (Eng. trans., *The Sanctuary of the Faithful Soul*, London, 1905); all these three works were translated and edited by Father Bertrand Wiberforce, O.F., and have been reprinted several times; and especially *Speculum Monachorum* (French trans. by Félicité de Lamennais, Paris, 1809; Eng. trans., Paris, 1876; re-edited by Lord Coleridge, London, 1871, 1872, and inserted in "Pater-noster" series, 1901).

See Georges de Blois, *Louis de Blois, son Bénédictin au XVI^e siècle* (Paris, 1875), Eng. trans. by Lady Lovat (London, 1878, &c.).

BLOIS, a town of central France, capital of the department of Loir-et-Cher, 35 m. S.W. of Orleans, on the Orleans railway between that city and Tours. Pop. (1906) 18,457. Situated in a thickly-wooded district on the right bank of the Loire, it covers the summits and slopes of two eminences between which runs the principal thoroughfare of the town named after the philosopher Denis Papin. A bridge of the 18th century from which it presents the appearance of an amphitheatre, unites Blois with the suburb of Vienne on the left bank of the river. The streets of the higher and older part of the town are narrow and tortuous, and in places so steep that means of ascent is provided by flights of steps. The famous château of the family of Orleans (see ARCHITECTURE: *Renaissance Architecture in France*), a fine example of Renaissance architecture, stands on the more westerly of the two hills. It consists of three main wings, and a fourth and smaller wing, and is built round a courtyard. The most interesting portion is the north-west wing, which was erected by Francis I., and contains the room where Henry, duke of Guise, was assassinated by order of Henry III. The striking feature of the interior facade is the celebrated spiral staircase tower, the bays of which, with their beautifully sculptured balustrades, project into the courtyard (see ARCHITECTURE, Plate VIII. fig. 84). The north-east wing, in which is the entrance to the castle, was built by Louis XII. and is called after him; it contains picture-galleries and a museum. Opposite is the Gaston wing, erected by Gaston, duke of Orleans, brother of Louis XIII., which contains a majestic domed staircase. In the north corner of the courtyard is the Salle des États, which, together with the donjon in the west corner, survives from the 15th century. Of the churches of Blois, the cathedral of St Louis, a building of the end of the 17th century, but in Gothic style, is surpassed in interest by St Nicolas, once the church of the abbey of St Laumer, and dating from the 12th and 13th centuries. The picturesqueness of the town is enhanced by many old mansions, the chief of which is the Renaissance Hôtel d'Alluye, and by numerous fountains, among which that named after Louis XII. is of very graceful design. The prefecture, the law court, the corn-market and the fine stud-buildings are among the chief modern buildings.

Blois is the seat of a bishop, a prefect, and a court of assizes.

It has a tribunal of first instance, a tribunal of commerce, a board of trade arbitration, a branch of the Bank of France, a communal college and training-colleges. The town is a market for the agricultural and pastoral regions of Beauce and Sologne, and has a considerable trade in grain, the wines of the Loire valley, and in horses and other live-stock. It manufactures boots and shoes, biscuits, chocolate, upholstering materials, furniture, machinery and earthenware, and has vinegar-works, breweries, leather-works and foundries.

Though of ancient origin, Blois is first distinctly mentioned by Gregory of Tours in the 6th century, and was not of any importance till the 9th-century, when it became the seat of a powerful countship (see below). In 1196 Count Louis granted privileges to the townsmen; the commune, which survived throughout the middle ages, probably dated from this time. The counts of the Châtillon line resided at Blois more often than their predecessors, and the oldest parts of the château (13th century) were built by them. In 1429 Joan of Arc made Blois her base of operations for the relief of Orleans. After his captivity in England, Charles of Orleans in 1440 took up his residence in the château, where in 1462 his son, afterwards Louis XII., was born. In the 16th century Blois was often the resort of the French court. Its inhabitants included many Calvinists, and it was in 1562 and 1567 the scene of struggles between them and the supporters of the Roman church. In 1576 and 1588 Henry III., king of France, chose Blois as the meeting-place of the states-general, and in the latter year he brought about the murders of Henry, duke of Guise, and his brother, Louis, archbishop of Reims and cardinal, in the château, where their deaths were shortly followed by that of the queen-mother, Catherine de' Medici. From 1617 to 1619 Marie de' Medici, wife of King Henry IV., exiled from the court, lived at the château, which was soon afterwards given by Louis XIII. to his brother Gaston, duke of Orleans, who lived there till his death in 1660. The bishopric dates from the end of the 17th century. In 1814 Blois was for a short time the seat of the regency of Marie Louise, wife of Napoleon I.

See L. de la Saussaye, *Blois et ses environs* (1873); *Histoire du château de Blois* (1873); L. Bergevin et A. Dupré, *Histoire de Blois* (1847).

BLOIS, COUNTSHIP OF. From 865 to about 940 the countship of Blois was one of those which were held in fee by the margrave of Neustria, Robert the Strong, and by his successors, the abbot Hugh, Odo (or Eudes), Robert II. and Hugh the Great. It then passed, about 940 and for nearly three centuries, to a new family of counts, whose chiefs, at first vassals of the dukes of France, Hugh the Great and Hugh Capet, became in 987, by the accession of the Capetian dynasty to the throne of France, the direct vassals of the crown. These new counts were originally very powerful. With the countship of Blois they united, from 940 to 1044, that of Touraine, and from about 950 to 1218, and afterwards from 1260 to 1286, the countship of Chartres remained in their possession.

The counts of Blois of the house of the Theobalds (Thibauds) began with Theobald I., the Cheat, who became count about 940. He was succeeded by his son, Odo (Eudes) I., about 975. Theobald II., eldest son of Odo I., became count in 996, and was succeeded by Odo II., younger son of Odo I., about 1005. Odo II. was one of the most warlike barons of his time. With the already considerable domains which he held from his ancestors, he united the heritage of his kinsman, Stephen I., count of Troyes. In 1033 he disputed the crown of Burgundy with the emperor, Conrad the Salic, and perished in 1037 while fighting in Lorraine. He was succeeded in 1037 by his eldest son, Theobald III., who was defeated by the Angevins in 1044, and was forced to give up the town of Tours and its dependencies to the count of Anjou. In 1089 Stephen Henry, eldest son of Theobald III., became count. He took part in the first crusade, fell into the hands of the Saracens, and died in captivity; he married Adela, daughter of William I., king of England. In 1102 Stephen Henry was succeeded by his son, Theobald IV. the Great, who united the countship of Troyes with his domains

in 1128. In 1135, on the death of his maternal uncle, Henry I., king of England, he was called to Normandy by the barons of the duchy, but soon renounced his claims on learning that his younger brother, Stephen, had just been proclaimed king of England. In 1152 Theobald V, the Good, second son of Theobald IV., became count; he died in 1191 in Syria, at the siege of Acre. His son Louis succeeded in 1191, took part in the fourth crusade, and after the taking of Constantinople was rewarded with the duchy of Nicaea. He was killed at the battle of Adrianople in 1205, in which year he was succeeded by his son, Theobald VI. the Young, who died childless. In 1218 the countship passed to Margaret, eldest daughter of Theobald V.; and to Walter (Gautier) of Avesnes, her third husband.

The Châtillon branch of the counts of Blois began in 1230 with Mary of Avesnes, daughter of Margaret of Blois and her husband, Hugh of Châtillon, count of St Pol. In 1241 her brother, John of Châtillon, became count of Blois, and was succeeded in 1279 by his daughter, Joan of Châtillon, who married Peter, count of Alençon, fifth son of Louis IX., king of France. In 1286 Joan sold the countship of Chartres to the king of France. Hugh of Châtillon, her first-cousin, became count of Blois in 1293, and was succeeded by his son, Guy I., in 1307. In 1342 Louis II., eldest son of Guy I., died at the battle of Crécy, and his brother, Charles of Blois, disputed the duchy of Brittany with John of Montfort. Louis III., eldest son of Louis II., became count in 1346, and was succeeded by John II., second son of Louis II., in 1372. In 1381 Guy II., brother of Louis III. and John II., succeeded in 1381, but died childless. Overwhelmed with debt, he had sold the countship of Blois to Louis I., duke of Orleans, brother of King Charles VI., who took possession of it in 1397.

In 1498 the countship of Blois was united with the crown by the accession of King Louis XII., grandson and second successor of Louis I., duke of Orleans.

See Bernier, *Histoire de Blois* (1682); La Saussaye, *Histoire de la ville de Blois* (1846).

BLOMEFIELD, FRANCIS (1705-1752), English topographer of the county of Norfolk, was born at Fersfield, Norfolk, on the 23rd of July 1705. On leaving Cambridge in 1727 he was ordained, becoming in 1729 rector of Hargham, Norfolk, and immediately afterwards rector of Fersfield, his father's family living. In 1733 he mooted the idea of a history of Norfolk, for which he had begun collecting material at the age of fifteen, and shortly afterwards, while collecting further information for his book, discovered some of the famous *Paston Letters*. By 1736 he was ready to put some of the results of his researches into type. At the end of 1739 the first volume of the *History of Norfolk* was completed. It was printed at the author's own press, bought specially for the purpose. The second volume was ready in 1745. There is little doubt that in compiling his book Blomefield had frequent recourse to the existing historical collections of Le Neve, Kirkpatrick and Tanner, his own work being to a large extent one of expansion and addition. To Le Neve in particular a large share of the credit is due. When half-way through his third volume, Blomefield, who had come up to London in connexion with a special piece of research, caught smallpox, of which he died on the 16th of January 1752. The remainder of his work was published posthumously, and the whole eleven volumes were republished in London between 1805 and 1810.

BLOMEFIELD, SIR ARTHUR WILLIAM (1829-1899), English architect, son of Bishop C. J. Blomefield, was born on the 6th of March 1829, and educated at Rugby and Trinity, Cambridge. He was then articled as an architect to P. C. Hardwick, and subsequently obtained a large practice on his own account. He became president of the Architectural Association in 1861, and a fellow (1867) and vice-president (1886) of the Royal Institute of British Architects. In 1887 he became architect to the Bank of England, and designed the law courts branch in Fleet Street, and he was associated with A. E. Street in the building of the law courts. In 1889 he was knighted. He died on the 30th of October 1899. He was twice married, and brought up two sons, Charles J. Blomefield and Arthur Conran Blomefield, to his own

profession, of which they became distinguished representatives. Among the numerous churches which Sir Arthur Blomefield designed, his work at St Saviour's, Southwark, is a notable example of his use of revived Gothic, and he was highly regarded as a restorer.

BLOMEFIELD, CHARLES JAMES (1786-1857), English divine, was born on the 29th of May 1786 at Bury St Edmunds. He was educated at the local grammar school and at Trinity College, Cambridge, where he gained the Browne medals for Latin and Greek odes, and carried off the Craven scholarship. In 1808 he graduated as third wrangler and first medallist, and in the following year was elected to a fellowship at Trinity College. The first-fruits of his scholarship was an edition of the *Prometheus* of Aeschylus in 1810; this was followed by editions of the *Septem contra Thebas*, *Persae*, *Choephorae*, and *Agamemnon*, of Callimachus, and of the fragments of Sappho, Sophron and Alcaeus. Blomefield, however, soon ceased to devote himself entirely to scholarship. He had been ordained in 1810, and held in quick succession the livings of Chesterford, Quarrington, Dunton, Great and Little Chesterford, and Tuddenham. In 1817 he was appointed private chaplain to Wm. Howley, bishop of London. In 1819 he was nominated to the rich living of St Botolph's, Bishopsgate, and in 1822 he became archdeacon of Colchester. Two years later he was raised to the bishopric of Chester where he carried through many much-needed reforms. In 1828 he was translated to the bishopric of London, which he held for twenty-eight years. During this period his energy and zeal did much to extend the influence of the church. He was one of the best debaters in the House of Lords, took a leading position in the action for church reform which culminated in the ecclesiastical commission, and did much for the extension of the colonial episcopate; and his genial and kindly nature made him an invaluable mediator in the controversies arising out of the tractarian movement. His health at last gave way, and in 1856 he was permitted to resign his bishopric, retaining Fulham Palace as his residence, with a pension of £6000 per annum. He died on the 5th of August 1857. His published works, exclusive of those above mentioned, consist of charges, sermons, lectures and pamphlets, and of a *Manual of Private and Family Prayers*. He was a frequent contributor to the quarterly reviews, chiefly on classical subjects.

See *Memoirs of Charles James Blomefield, D. D., Bishop of London, with Selections from his Correspondence*, edited by his son, Alfred Blomefield (1863); G. E. Biber, *Bishop Blomefield and his Times* (1857).

BLOMEFIELD, EDWARD VALENTINE (1788-1816); English classical scholar, brother of Bishop C. J. Blomefield, was born at Bury St Edmunds on the 14th of February 1788. Going to Calus College, Cambridge, he was thirteenth wrangler in 1811, obtained several of the classical prizes of the university, and became a fellow and lecturer at Emmanuel College. In 1813 he travelled in Germany and made the acquaintance of some of the great scholars of Germany. On his return, he published in the *Museum Criticum* (No. ii.) an interesting paper on "The Present State of Classical Literature in Germany." Blomefield is chiefly known by his translation of Matthiae's *Greek Grammar* (1819), which was prepared for the press by his brother. He died on the 9th of October 1816, his early death depriving Cambridge of one who seemed destined to take a high place amongst her most brilliant classical scholars.

See "Memoir of Edward Valentine Blomefield," by Bishop Monk, in *Museum Criticum*, No. vii.

BLONDEL, DAVID (1591-1655), French Protestant clergyman, was born at Châlons-sur-Marne in 1591, and died on the 6th of April 1655. In 1650 he succeeded G. J. Vossius in the professorship of history at Amsterdam. His works were very numerous; in some of them he showed a remarkable critical faculty, as in his dissertation on Pope Joan (1647, 1657), in which he came to the conclusion, now universally accepted, that the whole story is a mere myth. Considerable Protestant indignation was excited against him on account of this book.

BLONDEL, JACQUES FRANÇOIS (1705-1774), French architect, began life as an architectural engraver, but developed into an architect of considerable distinction, if of no great

originality. As architect to Louis XV. from 1755 he necessarily did much in the rococo manner, although it would seem that he conformed to fashion rather than to artistic conviction. He was among the earliest founders of schools of architecture in France, and for this he was distinguished by the Academy; but he is now best remembered by his voluminous work *L'Architecture française*, in which he was the continuator of Marot. The book is a precious collection of views of famous buildings, many of which have disappeared or been remodelled.

BLONDIN (1824-1897), French tight-rope walker and acrobat, was born at St Omer, France, on the 28th of February 1824. His real name was Jean Francois Gravelet. When five years old he was sent to the École de Gymnase at Lyons and, after six months' training as an acrobat, made his first public appearance as "The Little Wonder." His superior skill and grace as well as the originality of the settings of his acts, made him a popular favourite. He especially owed his celebrity and fortune to his idea of crossing Niagara Falls on a tight-rope, 1100 ft. long, 100 ft. above the water. This he accomplished, first in 1859, a number of times, always with different theatric variations: blindfold, in a sack, trundling a wheelbarrow, on stilts, carrying a man on his back, sitting down midway while he made and ate an omelette. In 1861 Blondin first appeared in London, at the Crystal Palace, turning somersaults on stilts on a rope stretched across the central transept, 170 ft. from the ground. In 1862 he again gave a series of performances at the Crystal Palace, and elsewhere in England, and on the continent. After a period of retirement he reappeared in 1880, his final performance being given at Belfast in 1896. He died at Ealing, London, on the 19th of February 1897.

BLOOD, the circulating fluid in the veins and arteries of animals. The word itself is common to Teutonic languages; the O. Eng. is *blod*, cf. Gothic *blōth*, Dutch *bloed*, Ger. *Blut*. It is probably ultimately connected with the root which appears in "blow," "bloom," meaning flourishing or vigorous. The Gr. word for blood, *αἷμα*, appears as a prefix *hæmo-* in many compound words. As that on which the life depends, as the supposed seat of the passions and emotions, and as that part which a child is believed chiefly to inherit from its parents, the word "blood" is used in many figurative and transferred senses; thus "to have his blood," "to fire the blood," "cold blood," "blood-royal," "half" or "whole blood," &c. The expression "blue blood" is from the Spanish *sangre azul*. The nobles of Castile claimed to be free from all admixture with the darker blood of Moors or Jews, a proof being supposed to lie in the blue veins that showed in their fairer skins. The common English expletive "bloody," used as an adjective or adverb, has been given many fanciful origins; it has been supposed to be a contraction of "by our Lady," or an adaptation of the oath common during the 17th century, "sblood," a contraction of "God's blood." The exact origin of the expression is not quite clear, but it is certainly merely an application of the adjective formed from "blood." The *New English Dictionary* suggests that it refers to the use of "blood" for a young rowdy of aristocratic birth, which was common at the end of the 17th century, and later became synonymous with "dandy," "buck," &c.; "bloody drunk" meant therefore "drunk as a blood," "drunk as a lord." The expression came into common colloquial use as a mere intensive, and was so used till the middle of the 18th century. There can be little doubt that the use of the word has been considerably affected by the idea of blood as the vital principle, and therefore something strong, vigorous, and parallel as an intensive epithet with such expressions as "thundering," "awfully" and the like.

ANATOMY AND PHYSIOLOGY

In all living organisms, except the most minute, only a minimum number of cells can come into immediate contact with the general world, whence is to be drawn the food supply for the whole organism. Hence those cells—and they are by far the most numerous—which do not lie on the food-absorbing surface, must gain their nutriment by some indirect means. Further,

each living cell produces waste products whose accumulation would speedily prove injurious to the cell, hence they must be constantly removed from its immediate neighbourhood and indeed from the organism as a whole. In this instance again, only a few cells can lie on a surface whence such materials can be directly discharged to the exterior. Hence the main number of the cells of the organism must depend upon some mechanism by which the waste products can be carried away from them to that group of cells whose duty it is to modify them, or discharge them from the body. These two ends are attained by the aid of a circulating fluid, a fluid which is constantly flowing past every cell of the body. From it the cells extract the food materials they require for their sustenance, and into it they discharge the waste materials resulting from their activity. This circulating medium is the blood.

Whilst undoubtedly the two functions of this circulating fluid above given are the more prominent, there are yet others of great importance. For instance, it is known that many tissues as a result of their activity produce certain chemical substances which are of essential importance to the life of other tissue cells. These substances—*internal secretions* as they are termed—are carried to the second tissue by the blood stream. Again, many instances are known in which two distant tissues communicate with one another by means of chemical messengers, bodies termed *hormones* (ὁρμῶν, to stir up), which are produced by one group of cells, and sent to the other group to excite them to activity. Here, also, the path by which such messengers travel is the blood stream. A further and most important manner in which the circulating fluid is utilized in the life of an animal is seen in the way in which it is employed in protecting the body should it be invaded by micro-organisms.

Hence it is clear that the blood is of the most vital importance to the healthy life of the body. But the fact that it is present as a circulating medium exposes the animal to a great danger, viz. that it may be lost should any vessel carrying it become ruptured. This is constantly liable to happen, but to minimize as far as possible any such loss, the blood is endowed with the peculiar property of *clotting*, i.e. of setting to a solid or stiff jelly by means of which the orifices of the torn vessels become plugged and the bleeding stayed.

The performance of these essential functions depends upon the maintenance of a continuous flow past all tissue cells, and this is attained by the circulatory mechanism, consisting of a central pump, the heart, and a system of ramifying tubes, the arteries, through which the blood is forced from the heart to every tissue (see **VASCULAR SYSTEM**). A second set of tubes, the veins, collects the blood and returns it to the heart. In many invertebrates the circulating fluid is actually poured into the tissue spaces from the open terminals of the arteries. From these spaces it is in turn drained away by the veins. Such a system is termed a *haemolymph system* and the circulating fluid the haemolymph. Here the essential point gained is that the fluid is brought into direct contact with the tissue cells. In all vertebrates, the ends of the arteries are united to the commencements of the veins by a plexus of extremely minute tubes, the capillaries, consequently the blood is always retained within closed tubes and never comes into contact with the tissue cells. It is while passing through the capillaries that the blood performs its work; here the blood stream is at its slowest and is brought nearest to the tissue cell, only being separated from it by the extremely thin wall of the capillary and by an equally thin layer of fluid. Through this narrow barrier the interchanges between cell and blood take place.

The advantage gained in the vertebrate animal by retaining the blood in a closed system of tubes lies in the great diminution of resistance to the flow of blood, and the consequent great increase in rate of flow past the tissue cells. Hence any food stuffs which can travel quickly through the capillary wall to the tissue cell outside can be supplied in proportionately greater quantity within a given time, without requiring any very great increase in the concentration of that substance in the blood. Conversely, any highly diffusible substance may be withdrawn

from the tissues by the blood at a similarly increased pace. These conditions are more peculiarly of importance for the supply of oxygen and the removal of carbonic acid—especially for the former, because the amount of it which can be carried by the blood is small. But as the rate at which a tissue lives, *i.e.* its activity, depends upon the rate of its chemical reactions, and as these are fundamentally oxidative, the more rapidly oxygen is carried to a tissue the more rapidly it can live, and the greater the amount of work it can perform within a given time. The rate of supply is of much less importance in the case of the other food substances because they are far more soluble in water, so that the supply in sufficient quantity can easily be met by a relatively slow blood flow. Hence we find that the gradual evolution of the animal kingdom goes hand in hand with the gradual development of a greater oxygen-carrying capacity of the blood and an increase in the rate of its flow.

In the groundwork of a tissue are a number of spaces—the *tissue spaces*. They are filled with fluid and intercommunicate freely, finally connecting with a number of fine tubes, the lymphatics, through which excess of fluid or any solid particles present are drained away. The contained fluid acts as an intermediary between the blood and the cell; from it, the cell takes its various food stuffs, these having in the first instance been derived from the blood, and into it the cell discharges its waste products. On the course of the lymphatics a number of typical structures, the lymphatic glands, are placed, and the lymph has to pass through these structures where any deleterious products are retained, and the fluid thus purified is drained away by further lymphatics and finally returned to the blood. Thus there is a second stream of fluid from the tissues, but one vastly slower than that of the blood. The flow is too slow for it to act as the vehicle for the removal of those waste products (carbonic acid, &c.) which must of necessity be removed quickly. These must be removed by the blood. The same is true for the main number of other waste products, which, however, being of small molecular size are readily absorbed into the blood stream.

But in addition to fluid, the tissue spaces may at times be found to contain solid matter in the form of particles, which may represent the debris of destroyed cells, or which are, as is quite commonly the case, micro-organisms. Apparently such material cannot be removed from a tissue by absorption into the blood stream—indeed in the case of living organisms such an absorption would in many instances rapidly prove fatal, and special provision is made to prevent such an accident. These, therefore, are made to travel along the lymphatic channels, and so, before gaining access to the blood stream and thus to the body generally, have to run the gauntlet of the protective mechanism provided by the lymphatic glands, where in the major number of cases they are readily destroyed.

Hence we see that first and foremost we have to regard the blood as a food-carrier to all the cells of the body; in the second place as the vehicle carrying away most if not all the waste products; in a third direction, it is acting as a means for transmitting chemical substances manufactured in one tissue to distant cells of the body for whose nutrition or excitation they may be essential; and in addition to these important functions there is yet another whose value it is almost impossible to over-estimate, for it plays the essential rôle in rendering the animal immune to the attacks of invading organisms. The question of immunity is discussed elsewhere, and it is sufficient merely to indicate the chief means by which the blood subserves this essential protective mechanism. Should living organisms find their way into the surface cells or within the tissue spaces, the body fights them in a number of ways. (1) It may produce one or more chemical substances capable of neutralizing the toxic material produced by the organism. (2) It may produce chemical substances which act as poisons to the micro-organism, either paralysing it or actually killing it. Or (3) the organism may be attacked and taken up into the body of wandering cells, *e.g.* certain of the leucocytes, and then digested by them. Such cells are therefore called phagocytes ($\phi\acute{\alpha}\gamma\epsilon\upsilon\sigma$, to eat). Thus, by its

power of reacting in these ways the body has become capable of withstanding the attacks of many different varieties of micro-organisms, of both animal and vegetable origin.

General Properties.—Blood is an opaque, viscid liquid of bright red colour possessing a distinct and characteristic odour, especially when warm. Its opacity is due to the presence of a very large number of solid particles, the blood corpuscles, having a higher refractive index than that of the liquid in which they float. The specific gravity in man averages about 1.055. The specific gravity of the liquid portion, the plasma (Gr. $\pi\lambda\acute{\alpha}\sigma\mu\alpha$, something formed or moulded, $\pi\lambda\acute{\alpha}\sigma\sigma\epsilon\upsilon$, to mould), is about 1.027, whilst that of the corpuscles amounts to 1.088. To litmus it reacts as a weak alkali.

Blood Plasma.—The plasma is a solution in water of a varied number of substances, and as a solvent it confers on the blood its power of acting as a carrier of food stuffs and waste products. One important food substance, oxygen, is, however, only partly carried in solution, being mainly combined with haemoglobin in the red corpuscles. The food stuffs carried by the plasma are proteins, carbohydrates, salts and water. The main waste products dissolved in it are ammonium carbonate, urea, urates, xanthin bases, creatin and small amounts of other nitrogenous bodies, carbonic acid as carbonates, other carbon compounds such as cholesterolin, lecithin and a number of other substances. Thus, if we take mammalian blood as a type, the plasma would have the following approximate composition:—

In 1000 grms. plasma—		
Water		901.51
Substances not vaporizing at 120° C.—		
Fibrin		8.06
Other proteins and organic substances		81.92
Inorganic substances—		
Chlorine	3.536	
Sulphuric acid	0.129	
Phosphoric acid	0.145	
Potassium	0.314	
Sodium	3.410	
Calcium	0.298	
Magnesium	0.218	
Oxygen	0.455	
		8.905
		98.49
		1000.00

Proteins.—The proteins of the blood plasma belong to the two classes of the albumins and the globulins. The globulins present are named fibrinogen and serum-globulin; as its name implies, the chief physiological property of fibrinogen is that it can give rise to fibrin, the solid substance formed when blood clots. It possesses the typical properties of a globulin, *i.e.* it coagulates on heating (in this instance at a temperature of 56° C.), and is precipitated by half saturating its solution with ammonium sulphate. It differs from other globulins in that it is less soluble. It is only present in very small quantities, 0.4%. The other globulin, serum-globulin, is not coagulated until 75° C. is reached, and we now know that it is in reality a mixture of several proteins, but so far these have not been completely separated from one another and obtained in a pure form. On dialysing a solution of serum-globulin a part is precipitated, and this portion has been termed the eu-globulin fraction, the remainder being known, in contradistinction, as the pseudo-globulin. Again, on diluting a solution and adding a small amount of acetic acid a precipitate is formed which in some respects differs from the remainder of the globulin present. Whether in these two instances we are dealing with approximately pure substances is extremely doubtful. A further important point in connexion with the chemistry of the globulins is that dextrose may be found among their decomposition products, *i.e.* that a part of it, or possibly the whole, possesses a glucoside character.

Serum-albumin gives all the typical colour and precipitation reactions of the albumins. If plasma be weakly acidified with sulphuric acid, then treated with crystals of ammonium sulphate until a slight precipitate forms, filtered and the filtrate allowed to evaporate very slowly, typical crystals of serum-albumin may form. According to many it is a uniform and specific

substance, but others hold the view that it consists of at least three distinct substances, as shown by the fact that if a solution be gradually heated coagulation will occur at three different temperatures, viz. at 73°, 77° and 84° C. On the other hand the close agreement between different analyses of even the amorphous preparations points to there being but one serum-albumin.

When blood clots two new proteins make their appearance in the fluid part of the blood, or serum, as it is now called. The first of these is fibrin ferment (for its origin see section on Clotting below). The other, fibrinoglobulin, possesses all the typical characteristics of the globulins and coagulates at 64° C.

Carbohydrates.—Three several carbohydrates are described as occurring in plasma, viz. glycogen, animal gum and dextrose. If glycogen is present in solution in the plasma it is there in very small quantities only, and has probably arisen from the destruction of the white blood corpuscles, since some leucocytes undoubtedly contain glycogen. A small amount of carbohydrate having the formula for starch and yielding a reducing sugar on hydrolysis with acid has also been described. The constant carbohydrate constituent of plasma, however, is dextrose. This is present to the approximate amount of 0.15% in arterial blood. The amount may be much greater in the blood of the portal vein during carbohydrate absorption, and according to some observers there is less in venous than in arterial blood, but the difference is small and falls within the error of observation. The statement that when no absorption is taking place the blood of the hepatic vein is richer in dextrose than that of the portal vein (Bernard) is denied by Pavy.

Fats.—Plasma or serum is as a rule quite clear, but after a meal rich in fats it may become quite milky owing to the presence of neutral fats in a very fine state of subdivision. This suspended fat rapidly disappears from the blood after fat absorption has ceased. To some extent it varies in composition with that of the fat absorbed, but usually consists of the glycerides of the common fatty acids—palmitic, stearic and oleic. In addition, there is a small amount of fatty acid in solution in the plasma. As to the form in which this occurs there is some uncertainty. It is possibly present as a soap or even as a neutral fat, since a little can be dissolved in plasma, the solvent substance being probably protein or cholesterol. Fatty acids also appear to be present to some extent combined with cholesterol forming cholesterol esters (about 0.06%).

Other Organic Compounds.—In addition to the substances above described, belonging to the three main classes of food stuffs, there are still other organic bodies present in plasma in small amounts, which for convenience we may classify as non-nitrogenous and nitrogenous. Among the former may be mentioned lactic acid, glycerin, a lipochrome, and probably many other substances of a similar type whose separation has not yet been effected.

The non-protein nitrogenous constituents consist of the following: ammonia as carbonate or carbamate (0.2 to 0.6%), urea (0.02 to 0.05%), creatine, creatinine, uric acid, xanthine, hypoxanthine and occasionally hippuric acid. Three ferments are also described as being present: (1) a glycolytic ferment exerting an action upon dextrose; (2) a lipase or fat-splitting ferment; and (3) a diastase capable of converting starch into sugar.

Salts.—The saline constituents of plasma comprise chlorides, phosphates, carbonates and possibly sulphates, of sodium, potassium, calcium and magnesium. The most abundant metal is sodium and the most abundant acid is hydrochloric. These two are present in sufficient amount to form about 0.65% of sodium chloride. The phosphate is present to about 0.02%. Sulphuric acid is always present if the blood has been calcined for the purposes of the analysis, and may then be present to about 0.013%. This is, however, probably produced during the destruction of the protein, since it has been shown that no sulphate can be removed from normal plasma by dialysis. The amount of potassium present (0.03%) is less than one-tenth of that of the sodium, and the quantities of calcium and magnesium are even less.

Formed Elements.—When viewed under the microscope the main number of these are seen to be small yellow bodies of very uniform size, size and shape varying, however, in different animals. When observed in bulk they have a red colour, their presence in fact giving the typical colour to blood. These are the red blood corpuscles or erythrocytes (Gr. *ερυθρός*, red). Mingled with them in the blood are a smaller number of corpuscles which possess no colour and have therefore been called white blood corpuscles or leucocytes (Gr. *λευκός*, white). Lastly, there are present a large number of small lens-shaped structures, less in number than the red corpuscles, and much more difficult to distinguish. These are known as blood platelets.

Red Corpuscles.—These are present in very large numbers and, under normal conditions, all possess exactly the same appearance. With rare exceptions their shape is that of a biconcave disk with bevelled edges, the size varying somewhat in different animals, as is seen in the following table which gives their diameters:—

Man	0.0075 mm.
Dog	0.0073 mm.
Rabbit	0.0069 mm.
Cat	0.0065 mm.
Goat	0.0041 mm.

The coloured corpuscles of amphibia as well as of nearly all vertebrates below mammals are biconvex and elliptical. The following are the dimensions of some of the more common:—

Pigeon	0.0147 mm. long by 0.0065 mm. wide.
Frog	0.0223 " " 0.0157 " "
Newt	0.0293 " " 0.0195 " "
Proteus	0.0580 " " 0.0350 " "
Amphiuma	0.0770 " " 0.0460 " "

Their number also varies as follows:—

Man	4,000,000 to 5,000,000 per cub. mm.
Goat	9,000,000 to 10,000,000 " "
Sheep	13,000,000 to 14,000,000 " "
Birds	1,000,000 to 4,000,000 " "
Fish	250,000 to 2,000,000 " "
Frog	500,000 per cub. mm.
Proteus	36,000 " "

In mammals they are apparently homogeneous in structure, have no nucleus, but possess a thin envelope. Their specific gravity is distinctly higher than that of the plasma (1.088), so that if clotting has been prevented, blood on standing yields a large deposit which may form as much as half the total volume of the blood.

Chemical Composition.—On destruction the red corpuscles yield two chief proteins, haemoglobin and a nucleo-protein, and a number of other substances similar to those usually obtained on the break-down of any cellular tissue, such for instance as lecithin, cholesterol and inorganic salts. The most important protein is the haemoglobin. To it the corpuscle owes its distinctive property of acting as an oxygen carrier, for it possesses the power of combining chemically with oxygen and of yielding up that same oxygen whenever there is a decrease in the concentration of the oxygen in the solvent. Thus in a given solution of haemoglobin the amount of it which is combined with oxygen depends absolutely on the oxygen concentration. The greatest dissociation of oxyhaemoglobin occurs as the oxygen tension falls from about 40 to 20 mm. of mercury. That the oxygen forms a definite compound with the haemoglobin is proved by the fact that haemoglobin thoroughly saturated with oxygen (oxyhaemoglobin) has a definite absorption spectrum showing two bands between the D and E lines, whilst haemoglobin from which the oxygen has been completely removed only gives one band between those lines. In association with this, oxyhaemoglobin has a typical bright red colour, whereas haemoglobin is dark purple. A further striking characteristic of haemoglobin is that it contains iron in its molecule. The amount present, though small bears a perfectly definite quantitative relation to the amount of oxygen with which the haemoglobin is capable of combining (two atoms of oxygen to one of iron). One gram of haemoglobin crystals can combine with 1.34 cc. of oxygen. On destruction with an acid or alkali, haemoglobin yields a pigment portion, haematin, and a protein portion, globin, the latter belonging to the group of the histones (Gr. *ἱστίον*, web, tissue).

In this cleavage the iron is found in the pigment. By the use of a strong acid, it may be made to yield iron-free pigment, the remainder of the molecule being much further decomposed.

Destruction and Formation.—In the performance of their work the corpuscles gradually deteriorate. They are then destroyed, chiefly in the liver, but whether the whole of this process is effected by the liver alone is not decided. It is proved, however, that the destruction of the haemoglobin is entirely effected there. It was for a long time considered to be one of the functions of the spleen to examine the red corpuscles and to destroy or in some way to mark those no longer fitted for the performance of their work. It is proved that the destruction of the haemoglobin is entirely effected in the liver, since both the main cleavage products may be traced to this organ, which discharges the pigmentary portion as the bile pigment, but retains the iron-protein moiety at any rate for a time. The amount of bile pigment eliminated during the day indicates that the destruction must be considerable, and since the number of corpuscles does not vary there must be an equivalent formation of new ones. This takes place in the red bone-marrow, where special cells are provided for their continuous production. In embryonic life their formation is effected in another way. Certain mesodermic cells, resembling those of the connective tissue, collect masses of haemoglobin, and from these elaborate red blood corpuscles which thus come to lie in the fluid part of the cell. By a canalization of the branches of these cells which unite with branches of other cells the precursors of the blood capillaries are formed.

White Blood Corpuscles.—These constitute the second important group of formed elements in the blood, and number about 12,000 to 20,000 per cubic mm. They are typical wandering cells carried to all parts of the body by the blood stream, but often leave that stream and gain the tissue spaces by passing through the capillary wall. They exist in many varieties and were first classified according as, under the microscope, they presented a granular appearance or appeared clear. The cells were also distinguished from one another according as they possessed fine or coarse granules. The granules are confined to the protoplasm of the cell, and it has been shown that they differ chemically, because their staining properties vary. Thus, some granules select an acid stain, and the cells containing them are then designated *acidophile* or *eosinophile*;¹ other granules select a basic stain and are called *basophile*, while yet others prefer a neutral stain (*neutrophils*).

In human blood the following varieties of leucocytes may be distinguished:—

1. **The Polymorphonuclear Cell.**—This possesses a nucleus of very complicated outline and a fair amount of protoplasm filled with numbers of fine granules which stain with eosin. They vary in size but are usually about 0.01 mm. in diameter. They are highly amoeboid and phagocytic, and form about 70% of the total number of leucocytes.

2. **The Coarsely Granular Eosinophile Cell.**—These large cells contain a number of well-defined granules which stain deeply with acid dyes. The nucleus is crescentic. The cells amount to about 2% of the total number of leucocytes, though the proportion varies considerably. They are actively amoeboid.

3. **The Lymphocyte.**—This is the smallest leucocyte, being only about 0.0065 mm. in diameter. It has a large spherical nucleus with a small rim of clear protoplasm surrounding it. It forms from 15 to 40% of the number of leucocytes, and is less markedly amoeboid than the other varieties.

4. **The Hyaline** (Gr. *ύαλος*, glassy, crystalline, *υαλος*, glass) **cell or macrocyte** (Gr. *μακρός*, long or large).—This is a cell similar to the last with a spherical, oval or indented nucleus, but it has much more protoplasm. It constitutes about 4% of all the leucocytes and is highly amoeboid and phagocytic.

5. **The Basophile Cell.**—This possesses a spherical nucleus and the protoplasm contains a small number of granules staining

deeply with basic dyes. It is rarely found in the blood of adults except in certain diseases.

Functions.—These cells act as scavengers or as destroyers of living organisms that may have gained access to the tissue spaces. They play an important part in the chemical processes underlying the phenomena of immunity, and some at least are of importance in starting the process of clotting.

They are constantly suffering destruction in the performance of their work. Many, too, are lost to the body by their passage through the different mucous surfaces. Their origin is still obscure in many points. The lymphocytes are derived from lymphoid tissue, wherever it exists in the different parts of the body. The polymorphonuclear and eosinophile cells are derived from the bone-marrow, each by division of specific mother cells located in that tissue. The macrocyte is believed by many to represent a further stage in the development of the lymphocyte. Their rate of formation may be influenced by a variety of conditions—for instance, they are found to vary in number according to the diet and also, to a considerable extent, in disease.

Platelets.—The platelets or thrombocytes (Gr. *θρομβος*, clot) are the third class of formed elements occurring in mammalian blood. There are still, however, many observers who consider that platelets are not present in the normal circulating blood, but only make their appearance after it has been shed or otherwise injured. They are minute lens-shaped structures, and may amount to as many as 800,000 per cubic mm. Under certain conditions, examination has shown that they are protoplasmic and amoeboid, and that each one contains a central body of different staining properties from the remainder of the structure. This has been regarded by some as a nucleus. On being brought into contact with a foreign surface they adhere to it firmly, very rapidly passing through a number of phases resulting ultimately in the formation of granular debris. In shed blood they tend to collect into groups, and during clotting, fibrin filaments may be observed to shoot out from these clumps.

Variations in the Blood of different Animals.—If we contrast the blood of different animals of the vertebrate class we find striking differences both in microscopic appearances and in chemical properties. In the first place, the corpuscles vary in amount and in kind. Thus, whilst in a mammal the corpuscles form 40 to 50% of the total volume of the blood, in the lower vertebrates the volume is much less, e.g. in frogs as low as 25% and in fishes even lower. The deficiency is chiefly in the red corpuscles, the ratio of white to red increasing as we examine the blood from animals lower in the scale. The corpuscles themselves are also found to vary, especially the red ones. In the mammal they are biconcave disks with bevelled edges, they do not contain a nucleus so that they are not cells. In the bird they are larger, ellipsoidal in shape and have a large nucleus in the centre of the cell. In reptiles and amphibia the red corpuscles are also nucleated, but the *stroma* portion containing the haemoglobin is arranged in a thickened annular part encircling the nucleus. When seen from the flat they are oval in section. In fishes the corpuscles show very much the same structure. A further very significant difference to be observed between the bloods of different vertebrates is in the amount of haemoglobin they contain; thus in the lower classes, fishes and amphibia, not only is the number of red corpuscles small but the amount of haemoglobin each corpuscle contains is relatively low. The concentration of the haemoglobin in the corpuscles attains its maximum in the mammal and the bird. Since the haemoglobin is practically the same from whatever animal it is obtained and can only combine with the same amount of oxygen, the oxygen-capacity of the blood of any vertebrate is in direct proportion to the amount of haemoglobin it contains. Therefore we see that as we ascend the scale in the vertebrate series the oxygen-carrying capacity of the blood rises. This increase was a natural preliminary condition for the progress of evolution. In order that a more active animal might be developed the main essential was that the chemical processes of the cell should be carried out more rapidly, and as these processes are fundamentally oxidative,

¹ The suffix *-phile*, Greek *φιλῶν*, to love, prefer, is in scientific terminology frequently applied to substances that exhibit such preference for particular stains or reagents, the names of which form the first part of the word.

Increased activity entails an increased rate of supply of oxygen. This latter has been brought about in the animal kingdom in two ways, first by an increase in the concentration of the haemoglobin of the blood effected by an increase both in the number of corpuscles and in the amount of haemoglobin contained in each, and secondly by an increase in the rate at which the blood has been made to pass through the tissues. In the lower vertebrates the blood pressure is low and the haemoglobin content of the blood is low, consequently both rate of blood-flow and oxygen-content are low. In contrast with this, in higher vertebrates the blood pressure is high and the haemoglobin content of the blood is high, consequently both rate of blood-flow and oxygen-content are high. We must associate with this important step in evolution the means employed for the more rapid absorption of oxygen and for its increased rate of discharge to the tissues, the most important features of which are a diminution in the size of the corpuscle and the attainment of its peculiar shape, both resulting in the production of a relatively enormous corpuscular surface in a unit volume of blood.

Variations are also found in the white corpuscles as well as in the red, but these differences are not so striking and lie chiefly in unimportant details of structure of individual cells. Enormous variations are to be found in different species of mammals, but the cells generally conform to the types of secreting cells or phagocytes.

The platelets also differ in the different species. In the frog, for instance, many are spindle-shaped and contain a nucleus-like structure. Birds' blood is stated to contain no platelets. The variations in number of these bodies have not been satisfactorily ascertained on account of the difficulties involved in any attempt to preserve them and to render them visible under the microscope.

Differences are also found in the chemical composition of the plasma. The chief variation is in the amount of protein present, which attains its maximum concentration in birds and mammals, while in reptiles, amphibia and fishes it is much less. The bloods of the latter two classes are much more watery than that of the mammal. Moreover, it has been proved that there are specific differences in the chemical nature of the various proteins present even between different varieties of mammals. Thus the ratio of the globulin fraction to the albumin fraction may vary considerably, and again, one or other of the proteins may be quite specific for the animal from which it is derived.

Clotting.—If a sample of blood be withdrawn from an animal, within a short time it undergoes a series of changes and becomes converted into a stiff jelly. It is said to *clot*. If the process is watched it is seen to start first from the surfaces where it is in contact with any foreign body; thence it extends through the blood until the whole mass sets solid. A short time elapses before this process commences—a time dependent upon two chief conditions, viz. the temperature at which the blood is kept and the extent of foreign surface with which it is brought into contact. Thus in a mammal the blood clots most quickly at a temperature a little above body temperature, while if the blood be cooled quickly the clotting is considerably delayed and in the case of some animals altogether prevented. For example, human blood kept at body temperature clots in three minutes, while if allowed to cool to room temperature the first sign of clotting may not make its appearance until eight minutes after its removal from the body. The process of clotting is also considerably accelerated by making the blood flow in a thin stream over a wide surface. The full completion of the process occupies some time if the blood be kept quiet, but ultimately the whole mass of the blood becomes converted into a solid. At this stage the containing vessel may be inverted without any drop of fluid escaping. A short time after this stage has been reached drops of a yellow fluid appear upon the surface and, increasing in size and number, run together to form a layer of fluid separated from the clot. This fluid is termed *serum*; its appearance is due to the contraction of the clot, which thus squeezes out the fluid from between its solid constituents. Contraction continues for about twenty-four hours, at the end of which time a large quantity (one-third or more of the total volume) of serum may have

been separated. The clot contracts uniformly, thus preserving throughout the same general shape as that of the vessel in which the blood has been collected. Finally the clot swims freely in the serum which it has expressed.

The cause of the clot formation has been found to be the precipitation of a solid from the liquid plasma of the blood. This solid is in the form of very minute threads and hence is termed *fibrin*. The threads traverse the mass of blood in every possible direction, interlacing and thus confining in their meshes all the solid elements of the blood. Soon after their deposition they begin to contract, and as the meshwork they form is very minute they carry with them all the corpuscles of the blood. These with the fibrin form the shrunken clot.

If the rate at which blood clots be retarded either by cooling or by some other process the corpuscles may have time to settle, partially or completely, in which case distinct layers may form. The lowermost of these contains chiefly the red corpuscles, the second layer may be grey owing to the high percentage of leucocytes present, while a third, marked by opalescence only, may be very rich in platelets. Above these a clear layer of fluid may be found. This is *plasma*. The formation of these layers depends solely upon the rate of sedimentation of these elements, the rate depending partly upon differences in specific gravity, and partly upon the tendency the corpuscles have to run into clumps. Horse's blood offers one of the best instances of the clumping of red corpuscles, and in this animal sedimentation of the red corpuscles is most rapid.

If now such a sedimented blood is allowed to clot the process is found to start in the middle two layers, i.e. in those containing the white corpuscles and platelets. From these layers it spreads through the rest of the liquid, being most retarded, however, in the red corpuscle layer, and particularly so if the sedimentation has been very complete. Not only does the clotting process start from the layers containing the leucocytes and platelets, but in them it also proceeds more quickly. These observations clearly indicate that the clotting process is initiated by some change starting from these elements.

The object of the clotting of the blood is quite clear. It is to prevent, as far as possible, any loss of blood when there is an injury to an animal's vessels. The shed blood becomes converted into a solid, and this, extending into the interior of the ruptured vessel, forms a plug and thus arrests the bleeding. It is found that clotting is especially accelerated whenever the blood touches a foreign tissue, for instance, the outer layers of a torn blood-vessel wall, muscle tissue, &c., i.e. in exactly those conditions in which rapid clotting becomes of the greatest importance. Yet another very pregnant fact in connexion with clotting is that if an animal be bled rapidly and the blood collected in successive samples it is found that those collected last clot most quickly. Hence the more excessive the haemorrhage in any case, the greater becomes the onset of the natural cure for the bleeding, viz. clotting.

When we begin to inquire into the nature of clotting we have to determine in the first place whence the fibrin is derived. It has long been known that two chemical substances at least are requisite for its production. Thus certain fluids are known, e.g. some samples of hydrocele or pericardial fluid, which will not clot spontaneously, but will clot rapidly when a small quantity of serum or of an old blood-clot is added to it. The constituent substance which is present in the first-named fluids is known as fibrinogen, and that present in the serum or the clot is known as fibrin-ferment or *thrombin*.

Fibrinogen is present in living blood dissolved in the plasma; it is also present in such fluids as hydrocele or pericardial effusions, which, though capable of clotting, do not clot spontaneously. Thrombin, on the other hand, does not exist in living blood, but only makes its appearance there after blood is shed. It is not yet certain what is the nature of the final reaction between fibrinogen and thrombin. The possibilities are, that thrombin may act—(1) by acting upon fibrinogen, which it in some way converts into fibrin, (2) by uniting with fibrinogen to form fibrin, or (3) by yielding part of itself to the fibrinogen which thus

becomes converted into fibrin. The experimental study of the rate of fibrin formation, when different strengths of thrombin solutions are allowed to act upon a fibrinogen solution, leads us to the probable conclusion that the first of these three possibilities is the correct one, and that thrombin therefore exerts a true ferment action upon fibrinogen. It is known that in the reaction, in addition to the formation of fibrin, yet another protein makes its appearance. This is known as fibrinoglobulin, and apparently it arises from the fibrinogen, so that the change would be one of cleavage into fibrin and fibrinoglobulin. It is very noteworthy that although the amount of fibrin formed during the clotting appears very bulky, yet the actual weight is extremely small, not more than 0.4 grms. from 100 cc. of blood.

Having ascertained that the clotting is due to the action of thrombin upon fibrinogen, we now see that the next step to be explained is the origin of thrombin. It has been shown that the final step in its formation consists in the combination of another substance, termed prothrombin, with calcium. Any soluble calcium salt is found to be effective in this respect, and conversely the removal of soluble calcium (e.g. by sodium oxalate) will prevent the formation of thrombin and therefore of clotting.

In the next place it can be proved that prothrombin does not exist as such in circulating blood, so that the problem becomes an inquiry as to the origin of prothrombin. Experiment has shown that in its turn prothrombin arises from yet another precursor, which is named thrombogen, and that thrombogen also is not to be found in circulating blood but only makes its appearance after the blood is shed. The conversion of thrombogen into prothrombin has been proved to be due to the action of a second ferment which has been named thrombokinase, and this latter is again absent from living blood. Hence the question arises, whence are derived thrombogen and thrombokinase? In the study of this question it has been found that if the blood of birds be collected direct from an artery through a perfectly clean cannula into a clean and dust-free glass vessel, it does not clot spontaneously. The plasma collected from such blood is found to contain thrombogen but no thrombokinase. A somewhat similar plasma may be prepared from a mammal's blood by collecting samples of blood from an artery into vessels which have been thoroughly coated with paraffin, though in this instance thrombogen may be absent as well as thrombokinase. If plasma containing thrombogen but no thrombokinase be treated with a saline extract of any tissues it will soon clot. The saline extract contains thrombokinase. This ferment can therefore be derived from most tissues, including also the white blood corpuscles and the platelets. Thrombogen is produced from the leucocytes, but it is not yet certain whether it is also formed from the platelets. The discovery of the origin of the thrombokinase from tissue cells explains a fact that has long been known, namely, that if in collecting blood, it is allowed to flow over cut tissues, clotting is most markedly accelerated. The fact that birds' blood if very carefully collected will not clot spontaneously tends to prove that thrombokinase is not derived from the leucocytes, and makes probable its origin from the platelets, for it is known that birds' blood apparently does not contain platelets, at any rate in the form in which they are found in mammalian blood. When examining the general properties of platelets, attention was drawn to the remarkably rapid manner in which they undergo change on coming into contact with a foreign surface. It is apparently the actual contact which initiates these changes, changes which are fundamentally chemical in character, resulting in the production of thrombokinase and possibly also of thrombogen.

Thus as our knowledge at present stands the following statement gives a recapitulated account of the changes which constitute the many phases of clotting. When blood escapes from a blood-vessel it comes into contact with a foreign surface, either a tissue or the damaged walls of the cut vessel. Very speedily this contact results in the discharge of thrombogen and thrombokinase, the former from the white blood corpuscles and also possibly from the platelets, the latter from the platelets

or from the tissue with which the blood comes in contact. The interaction of these two bodies next results in the formation of prothrombin, which, combining with the calcium of any soluble lime salt present, forms thrombin or fibrin-ferment. The last step in the change is the action of thrombin upon fibrinogen to form fibrin, and the clot is complete.

The intrinsic value to the animal of these changes is quite plain. The power of clotting and thus stopping haemorrhage is of essential importance, and yet this clotting must not occur within the living blood-vessels, or it would speedily result in death. That the tissues should be able to accelerate the process is of very obvious value. That the inner lining of the blood-vessels does not act as a foreign tissue is possibly due to the extreme smoothness of their surface.

Further, an animal must always be exposed to a possible danger in the absorption of some thrombin from a mass of clotted blood still retained within the body, and we know that if a quantity of active ferment be injected into the blood-stream intravascular clotting does result. Under all usual conditions this is obviated, the protective mechanism being of a twofold character. First, it is found that thrombin becomes converted very quickly into an inactive modification. Serum, for instance, very quickly loses its power of inducing clotting in fibrinogen solutions. Secondly, the body has been found to possess the power of making a substance, antithrombin, which can combine with thrombin forming a substance which is quite inactive as far as clotting is concerned. Finally, there is evidence that normal blood contains a small quantity of this substance, antithrombin, and that under certain conditions the amount present may be enormously increased. (T. G. Bæ.)

Pathology of the Blood.

The changes in the blood in disease are probably as numerous and varied as the diseases which attack the body, for the blood is not only the medium of respiration, but also of nutrition, of defence against organisms and of many other functions, none of which can be affected without corresponding alterations occurring in the circulating fluid. The immense majority of these changes are, however, so subtle that they escape detection by our present methods. But in certain directions, notably in regard to the relations with micro-organisms, changes in the blood-plasma can be made out, though they are not associated in all cases with changes in the formed elements which float in it, nor with any obvious microscopic or chemical alterations.

The phenomena of immunity to the attacks of bacteria or their toxins, of agglutinative action, of opsonic action, of the precipitin tests, and of haemolysis, are all largely *immunity*, dependent on the inherent or acquired characters of the blood serum. It is a commonplace that different people vary in their susceptibility to the attacks of different organisms, and different species of animals also vary greatly. This "natural immunity" is due partly to the power possessed by the leucocytes or white blood corpuscles of taking into their bodies and digesting or holding in an inert state organisms which reach the blood—phagocytosis,—partly to certain bodies in the blood serum which have a bactericidal action, or whose presence enables the phagocytes to deal more easily with the organisms. This natural immunity can be heightened when it exists, or an artificial immunity can be produced in various ways. Doses of organisms or their toxins can be injected on one or several occasions, and provided that the lethal dose be not reached, in most cases an increased power of resistance is produced. The organisms may be injected alive in a virulent condition, or with their virulence lessened by heat or cold, by antiseptics, by cultivation in the presence of oxygen, or by passage through other animals, or they may first be killed, or their toxins alone injected. The method chosen in each case depends on the organism dealt with. The result of this treatment is that in the animal treated protective substances appear in the serum, and these substances can be transferred to the serum of another animal or of man; in other words the active immunity of the experimental animal can be translated into

the passive immunity of man. According to the nature of the substances injected into the former, its serum may be antitoxic, if it has been immunized against any particular toxin, or antibacterial, if against an organism. Familiar examples of these are, of the former diphtheria antitoxin, of the latter anti-plague and anti-typhoid sera. An antitoxin exerts its effects by actual combination with the respective toxin, the combination being inert. It is probable that the ultimate source of the antitoxin is to be found in the living cells of the tissues and that it passes from them into the blood. The action of an antibacterial serum depends on the presence in it of a substance known as "immune-body," which has a special affinity and power of combining with the bacterium used. In order that it may exert this power it requires the presence of a substance normally present in the serum known as "complement." The development of these "anti-bodies," though it has been studied mainly in connexion with bacteria and their toxins, is not confined to their action, but can be demonstrated in regard to many other substances, such as ferments, tissue cells, red corpuscles, &c. In some animals, for example, the blood serum has the power of dissolving the red corpuscles of an animal of different species; e.g. the guinea-pig's serum is "haemolytic" to the red corpuscles of the ox. This haemolytic power (haemolysis) can be increased by repeated injections of red corpuscles from the other animal, in this case also, as in the bacterial case, by the production and action of immune-body and complement. The antiserum produced in the case of the red corpuscles may sometimes, if injected into the first animal, whose red corpuscles were used, cause extensive destruction of its red corpuscles, with haemoglobinuria, and sometimes a fatal result.

Opsonic action depends on the presence of a substance, the "opsonin," in the serum of an immunized animal, which makes the organism in question more easily taken up by the phagocytes (leucocytes) of the blood. The opsonin becomes fixed to the organisms. It is present to a certain extent in normal serum, but can be greatly increased by the process of immunization; and the "opsonic index," or relation between the number of organisms taken up by leucocytes when treated with the serum of a healthy person or "control," and with the serum of a person affected with any bacterial disease and under treatment by immunization, is regarded by some as representing the degree of immunity produced.

Agglutinative action is evidence of the presence in a serum of a somewhat similar set of substances, known as "agglutinins." When a portion of an antiserum is added to an emulsion of the corresponding organism, the organisms, if they are motile, cease to move, and in any case become gathered together into clumps. In all probability several different bodies are concerned in this process. This reaction, in its practical applications at least, may be regarded as a reaction of infection rather than of immunization as ordinarily understood, for it is found that the blood serum of patients suffering from typhoid, Malta fever, cholera, and many other bacterial diseases, agglutinates the corresponding organisms. This fact has come to be of great importance in diagnosis.

The precipitin test depends on a somewhat analogous reaction. If the serum of an animal be injected repeatedly into another animal of different species, a "precipitin" appears in the serum of the animal treated, which causes a precipitate when added to the serum of the first animal. The special importance of this fact is that it can be utilized as a method of distinguishing between human blood and that of animals, which is often of importance in medical jurisprudence.

In this summary the facts adduced are practically all biological, and are due to the extraordinary activity with which the study of bacteriology (*q.v.*) has been pursued in recent years. The chemistry of the blood has not hitherto been found to give information of clinical or diagnostic importance, and nothing need here be added to what is said above on the physiology of the blood. Enough has been said, however, to show the extraordinary complexity of the apparently simple blood serum.

The methods at present employed in examining the blood

clinically are: the enumeration of the red and white corpuscles per cubic millimetre; the estimation of the percentage of haemoglobin and of the specific gravity of the blood; the microscopic examination of freshly-drawn blood and of blood films made upon cover-glasses, fixed and stained. In special cases the alkalinity and the rapidity of coagulation may be ascertained, or the blood may be examined bacteriologically. We have no universally accepted means of estimating, during life, the total amount of blood in the body, though the method of J. S. Haldane and J. Lorrain Smith, in which the total oxygen capacity of the blood is estimated, and its total volume worked out from that datum, has seemed to promise important results (*Journ. of Physiol.* vol. xxv. p. 331, 1900). After death the amount of blood sometimes seems to be increased, and sometimes, as in "pernicious anaemia," it is certainly diminished. But the high counts of red corpuscles which are occasionally reported as evidence of plethora or increase of the total blood are really only indications of concentration of the fluid except in certain rare cases. It is necessary, therefore, in examining blood diseases, to confine ourselves to the study of the blood-unit, which is always taken as the cubic millimetre, without reference to the number of units in the body.

Anaemia is often used as a generic term for all blood diseases, for in almost all of them the haemoglobin is diminished, either as a result of diminution in the number of the red corpuscles in which it is contained, or because the individual red corpuscles contain a smaller amount of haemoglobin than the normal. As haemoglobin is the medium of respiratory interchange, its diminution causes obvious symptoms, which are much more easily appreciated by the patient than those caused by alterations in the plasma or the leucocytes. It is customary to divide anaemias into "primary" and "secondary": the primary are those for which no adequate cause has as yet been discovered; the secondary, those whose cause is known. Among the former are usually included chlorosis, pernicious anaemia, and sometimes the leucocythaemias; among the latter, the anaemias due to such agencies as malignant disease, malaria, chronic metallic poisoning, chronic haemorrhage, tubercle, Bright's disease, infective processes, intestinal parasites, &c. As our knowledge advances, however, this distinction will probably be given up, for the causes of several of the primary anaemias have been discovered. For example, the anaemia due to *bothrioccephalus*, an intestinal parasite, is clinically indistinguishable from the other forms of pernicious anaemia with which it used to be included, and leucocythaemia has been declared by Löwit, though probably erroneously, to be due to a blood parasite closely related to that of malaria. In all these conditions there is a considerable similarity in the symptoms produced and in the pathological anatomy. The general symptoms are pallor of the skin and mucous membranes, weakness and lassitude, shortness of breath, palpitation, a tendency to fainting, and usually also gastro-intestinal disturbance, headache and neuralgia. The heart is often dilated, and on auscultation the systolic murmurs associated with that condition are heard. In fatal cases the internal organs are found to be pale, and very often their cells contain an excessive amount of fat. In many anaemias there is a special tendency to haemorrhage. Most of the above symptoms and organic changes are directly due to diminished respiratory interchange from the loss of haemoglobin, and to its effect on the various organs involved. The diagnosis depends ultimately in all cases upon the examination of the blood.

Though the relative proportions of the leucocytes are probably continually undergoing change even in health, especially as the result of taking food, the number of red corpuscles remains much more constant. Through the agency of some unknown mechanism, the supply of fresh red corpuscles from the bone-marrow keeps pace with the destruction of effete corpuscles, and in health each corpuscle contains a definite and constant amount of haemoglobin. The disturbance of this arrangement in anaemia may be due to loss or to increased destruction of corpuscles, to the supply of a smaller number of new ones, to a

diminution of the amount of haemoglobin in the individual new corpuscles, or to a combination of these causes. It is most easy to illustrate this by describing what happens after a haemorrhage. If this is small, the loss is replaced by the fully-formed corpuscles held in reserve in the marrow, and there is no disturbance. If it is larger, the amount of fluid lost is first made up by fluid drawn from the tissues, so that the number of corpuscles is apparently diminished by dilution of the blood; the erythroblasts, or formative red corpuscles, of the bone-marrow are stimulated to proliferation, and new corpuscles are quickly thrown into the circulation. These are apt, however, to be small and to contain a subnormal amount of haemoglobin, and it is only after some time that they are destroyed and their place taken by normal corpuscles. If the loss has been very great, nucleated red corpuscles may even be carried into the bloodstream. The blood possesses a great power of recovery, if time be given it, because the organ (bone-marrow) which forms so many of its elements never, in health, works at high pressure. Only a part of the marrow, the so-called red marrow, is normally occupied by erythroblastic tissue, the rest of the medullary cavity of the bones being taken up by fat. If any long-continued demand for red corpuscles is made, the fat is absorbed, and its place gradually taken by red marrow. This compensatory change is found in all chronic anaemias, no matter what their cause may be, except in some rare cases in which the marrow does not react.

It is often very difficult, especially in "secondary" anaemias, to say which of the above processes is mainly at work. In acute anaemias, such as those associated with septicaemia, there is no doubt that blood destruction plays the principal part. But if the cause of anaemia is a chronic one, a gastric cancer, for instance, though there may possibly be an increased amount of destruction of corpuscles in some cases, and though there is often loss by haemorrhage, the cancer interferes with nutrition, the blood is impoverished and does not nourish the erythroblasts in the marrow sufficiently, and the new corpuscles which are turned out are few and poor in haemoglobin. In chronic anaemias, regeneration always goes on side by side with destruction, and it is important to remember that the state of the blood in these conditions gives the measure, not of the amount of destruction which is taking place so much as of the amount of regeneration of which the organism is capable. The evidence of destruction has often to be sought for in other organs, or in secretions or excretions.

Of the so-called primary anaemias the most common is *chlorosis*, an anaemia which occurs only in the female sex, between the ages of fifteen and twenty-five as a rule. Its symptoms are those caused by a diminution of haemoglobin, and though it is never directly fatal, and is extremely amenable to treatment with iron preparations, its subjects very frequently suffer from relapses at varying intervals after the first attack. Its causation is probably complex. Bad hygienic conditions, over-fatigue, want of proper food, especially of the iron-containing proteids of meat, the strain put upon the blood and blood-forming organs by the accession of puberty and the occurrence of menstruation, all probably play a part in it. It has also been suggested that internal secretions may be concerned in stimulating the bone-marrow, and that in the female sex in particular the genital organs may act in this way. Imperfect assumption of function by these organs at puberty, caused perhaps by some of the above-mentioned conditions, might lead to sluggishness in the bone-marrow, and to the supply to the blood of the poorly-formed corpuscles deficient in haemoglobin which are characteristic of the disease. Chlorosis is the type of anaemias from imperfect blood-formation. Lorrain Smith has produced evidence to show that the total amount of haemoglobin in the body is not diminished in this disease, but that the blood-plasma is greatly increased in amount, so that the haemoglobin is diluted and the amount in each blood-unit greatly lessened.

Pernicious anaemia is a rarer disease than chlorosis, occurs usually later in life, and is distributed nearly equally between the two sexes. But it is of great importance because of its almost uniformly fatal termination, though its downward course

is generally broken by temporary improvement on one or more occasions. The symptoms are those of a progressive anaemia, in which gastro-intestinal disturbance usually plays a large part, and nervous symptoms are common, and they become at last much more severe than those of any secondary anaemia. The patient may die in the first attack, but more usually, when things seem to be at their worst, improvement sets in, either spontaneously or as the result of treatment, and the patient slowly regains apparent health. This remission may be followed by a relapse, that again by a remission, and so on, but as a rule the disease is fatal within, at the outside, two or three years.

The prime cause of the disease is not known. It seems probable indeed that the causal factors are numerous. Severe malarial infection, syphilis, pregnancy, chronic gastro-intestinal disease, chronic gas-poisoning, are all, in different cases, known to have been causally associated with it, and it is probable that a congenital weakness of the bone-marrow has often to do with its production, as in many cases a family or hereditary history of the disease can be obtained. The condition is now regarded as a chronic toxæmia, partly because of the clinical symptoms and pathological appearances, partly because analogous conditions can be produced experimentally by such poisons as saponin and toluyldiamin, and partly because of the facts of *botrioccephalus* anaemia. The site of production of the toxin, or toxins, for it is possible that several may have the same effect on the blood, is possibly not always the same, but must often be the alimentary canal, as *botrioccephalus* anaemia proves. Not all persons affected with this intestinal tapeworm contract the disease, but only those in whose intestines the worm is dead and decomposing or sometimes only "sick." The expulsion of the worm puts an end to the absorption of the toxin and the patients recover. No adequate explanation of the formation of the toxin in the immense majority of the cases, in which there is no tapeworm, has yet been given. It is certain that no organism as yet known is concerned.

This toxæmia affects the marrow and through it the blood, the gastro-intestinal apparatus and the nervous system, especially the spinal cord, in different proportions in different cases. The effect upon the marrow is to alter the type of red corpuscle formation, causing a reversion to the embryonic condition, in which the nucleated red corpuscles are large (megaloblasts), and the corpuscles in the blood formed from them are also large, are apparently ill suited to the needs of the adult, and easily break down, as the deposits of iron in the liver, spleen, kidneys and marrow prove. Whether this reversion is due to an exhaustion of the normal process or to an inhibition of it is not definitely known. The result is that the circulating red corpuscles are enormously diminished; it is usual to find 1,000,000 or less in the cubic millimetre instead of the normal 5,000,000. Though the haemoglobin is of course absolutely diminished, it is always, in severe cases, present in relatively higher percentage than the red corpuscles, because the average red corpuscle is larger and contains more haemoglobin than the normal. The large nucleated red corpuscles (megaloblasts) with which the marrow is crowded, often appear in the blood.

Other anaemias, such as those known as *lymphadenoma*, or Hodgkin's disease, *splenic anaemia*, *chloroma*, *leucanaemia* and the *anaemia pseudo-leucæmica* of children, need not be described here, as they are either rare or their occurrence or nature is still too much under discussion.

The number and nature of the leucocytes in the blood bears no constant or necessary relation to the number or condition of the red corpuscles, and their variations depend on entirely different conditions. The number in the Leucocytes. cubic millimetre is usually about 7000, but may vary in health from 5000 to 10,000. A diminution in their number is known as *leucopenia*, and is found in starvation, in some infective diseases, as for example in typhoid fever, in malaria and Malta fever, and in pernicious anaemia. An increase is very much more frequent, and is known as *leucocytosis*, though in this term is usually connoted a relative increase in the proportion of the polymorphonuclear neutrophile leucocytes.

Leucocytosis occurs under a great variety of conditions, normally to a slight extent during digestion, during pregnancy, and after violent exercise, and abnormally after haemorrhage, in the course of inflammations and many infective diseases, in malignant disease, in such toxic states as uraemia, and after the ingestion of nuclein and other substances. It does not occur in some infective diseases, the most important of which are typhoid fever, malaria, influenza, measles and uncomplicated tuberculosis. In all cases where it is sufficiently severe and long continued, the reserve space in the bone-marrow is filled up by the active proliferation of the leucocytes normally found there, and is used as a nursery for the leucocytes required in the blood. In many cases leucocytosis is known to be associated with the defence of the organism from injurious influences, and its amount depends on the relation between the severity of the attack and the power of resistance. There may be an increase in the proportions present in the blood of lymphocytes (*lymphocytosis*), and of eosinophilic cells (*eosinophilia*). This latter change is associated specially with some forms of asthma, with certain skin diseases, and with the presence of animal parasites in the body, such as *ankylostoma* and *filaria*.

The disease in which the number of leucocytes in the blood is greatest is *leucocythaemia* or *leucaemia*. There are two main forms of this disease, in both of which there are anaemia, enlargement of the spleen and lymphatic glands, or of either of them, leucocytic hypertrophy of the bone-marrow, and deposits of leucocytes in the liver, kidney and other organs. The difference lies in the kind of leucocytes present in excess in the blood, blood-forming organs and deposits in the tissues. In the one form these are lymphocytes, which are found in health mainly in the marrow, the blood itself, the lymph glands and in the lymphatic tissue round the alimentary canal; in the other they are the kinds of leucocytes normally found in the bone-marrow—myelocytes, neutrophils, basophile and eosinophile, and polymorphonuclear cells, also neutrophils, basophile and eosinophile. The clinical course of the two forms may differ. The first, known as *lymphatic leucaemia* or *lymphoemia*, may be acute, and prove fatal in a few weeks or even days with rapidly advancing anaemia, or may be chronic and last for one or two years or longer. The second, known as spleno-myelogenous leucaemia or *myeloemia*, is almost always chronic, and may last for several years. Recovery does not take place, though remissions may occur. The use of the X-rays has been found to influence the course of this disease very favourably. The most recent view of the pathology of the disease is that it is due to an overgrowth of the bone-marrow leucocytes, analogous in some respects to tumour growth and caused by the removal of some controlling mechanism rather than by stimulation. The anaemia accompanying the disease is due partly to the leucocyte overgrowth, which takes up the space in the marrow belonging of right to red corpuscle formation and interferes with it. (G.L.G.)

BLOOD-LETTING. There are certain morbid conditions when a patient may obtain marked relief from the abstraction of a certain amount of blood, from three or four ounces up to twenty or even thirty in extreme cases. This may be effected by venesection, or the application of leeches, or more rarely by cupping (q.v.). Unfortunately, in years gone by, blood-letting was used to such excess, as a cure for almost every known disease, that public opinion is now extremely opposed to it. In certain pathological conditions, however, it brings relief and saves life when no other means would act with sufficient promptness to take its place.

Venesection, in which the blood is usually withdrawn from the median-basilic vein of the arm, has the disadvantage that it can only be performed by the medical man, and that the patient's friends are generally very much opposed to the idea. But the public are not nearly so prejudiced against the use of leeches; and as the nurse in charge can be instructed to use these if occasion arises, this is the form of blood-letting usually practised to-day. From one to twelve leeches are applied at the time, the average leech withdrawing some two drachms of blood. Should this prove insufficient, as much again can be abstracted

by the immediate application of hot fomentations to the wounds. They should always be applied over some bony prominence, that pressure may be effectively used to stop the haemorrhage afterwards. They should never be placed over superficial veins, or where there is much loose subcutaneous tissue. If, as is often the case, there is any difficulty in making them bite, the skin should be pricked at the desired spot with the point of a sterilized needle, and the leech will then attach itself without further trouble. Also they must be left to fall off of their own accord, the nurse never dragging them forcibly off. If cold and pressure fail to stop the subsequent haemorrhage, a little powdered alum or other styptic may be inserted in the wound. The following are the main indications for their use, though in some cases they are better replaced by venesection. (1) For stagnation of blood on the right side of the heart with constant dyspnoea, cyanosis, &c. In acute lung disease, the sudden obstruction to the passage of blood through the lungs throws such an increased strain on the right ventricle that it may dilate to the verge of paralysis; but by lessening the total volume of blood, the heart's work is lightened for a time, and the danger at the moment tided over. This is a condition frequently met with in the early stages of acute pneumonia, pleurisy and bronchitis, when the obstruction is in the lungs, the heart being normal. But the same result is also met with as a result of failure of compensation with back pressure in certain forms of heart disease (q.v.). (2) To lower arterial tension. In the early stages of cerebral haemorrhage (before coma has supervened), when the heart is working vigorously and the tension of the pulse is high, a timely venesection may lead to arrest of the haemorrhage by lowering the blood pressure and so giving the blood in the ruptured vessel an opportunity to coagulate. (3) In various convulsive attacks, as in acute uraemia.

BLOOD-MONEY, colloquially, the reward for betraying a criminal to justice. More strictly it is used of the money-penalty paid in old days by a murderer to the kinsfolk of his victim. These fines completely protected the offender from the vengeance of the injured family. The system was common among the Scandinavian and Teutonic races previous to the introduction of Christianity, and a scale of payments, graduated according to the heinousness of the crime, was fixed by laws, which further settled who could exact the blood-money, and who were entitled to share it. Homicide was not the only crime thus expiable: blood-money could be exacted for all crimes of violence. Some acts, such as killing any one in a church or while asleep, or within the precincts of the royal palace, were "bot-less"; and the death penalty was inflicted. Such a criminal was outlawed, and his enemies could kill him wherever they found him.

BLOODSTONE, the popular name of the mineral heliotrope, which is a variety of dark green chalcidony or plasma, with bright red spots, splashes and streaks. The green colour is due to a chloritic mineral; the red to haematite. Some coarse kinds are opaque, resembling in this respect jasper, and some writers have sought to restrict the name "bloodstone" to green jasper, with red markings, thus making heliotrope a translucent and bloodstone an opaque stone, but, though convenient, such a distinction is not generally recognized. A good deal of bloodstone comes from India, where it occurs in the Deccan traps, and is cut and polished at Cambay. The stone is used for seals, knife-handles and various trival ornaments. Bloodstone is not very widely distributed, but is found in the basaltic rocks of the Isle of Rum in the west of Scotland, and in a few other localities. Haematite (Gr. *αἷμα*, blood), or native peroxide of iron, is also sometimes called "bloodstone."

BLOOM (from A.S. *blōma*, a flower), the blossom of flowering plants, or the powdery film on the skin of fresh-picked fruit; hence applied to the surface of newly-minted coins or to a cloudy appearance on the varnish of painting due to moisture; also, in metallurgy, a term used of the rough billets of iron and steel, which have undergone a preliminary hammering or rolling, and are ready for further working.

BLOOMER, AMELIA JENKS (1818-1804), American dress-reformer and women's rights advocate, was born at Homer, New

York, on the 27th of May 1818. After her marriage in 1840 she established a periodical called *The Lily*, which had some success. In 1849 she took up the idea—previously originated by Mrs Elizabeth Smith Miller—of a reform in woman's dress, and the wearing of a short skirt, with loose trousers, gathered round the ankles. The name of "bloomers" gradually became popularly attached to any divided-skirt or knickerbocker dress for women. Until her death on the 30th of December 1894 Mrs Bloomer took a prominent part in the temperance campaign and in that for woman's suffrage.

BLOOMFIELD, MAURICE (1855-), American Sanskrit scholar, was born on the 23rd of February 1855, in Bielitz, Austrian Silesia. He went to the United States in 1867, and ten years later graduated from Furman University, Greenville, South Carolina. He then studied Sanskrit at Yale, under W. D. Whitney, and at Johns Hopkins, to which university he returned as associate professor in 1881 after a stay of two years in Berlin and Leipzig, and soon afterwards was promoted professor of Sanskrit and comparative philology. His papers in the *American Journal of Philology* number a few in comparative linguistics, such as those on assimilation and adaptation in congeneric classes of words, and many valuable "Contributions to the Interpretation of the Vedas," and he is best known as a student of the Vedas. He translated, for Max-Müller's *Sacred Books of the East*, the Hymns of the Atharva-Veda (1897); contributed to the Bühler-Kielhorn *Grundriss der indo-arischen Philologie und Altertumskunde* the section "The Atharva-Veda and the Gopatha Brāhmana" (1896); was first to edit the *Kaūçika-Sūtra* (1890), and in 1907 published, in the Harvard Oriental series, *A Vedic Concordance*. In 1905 he published *Cerberus, the Dog of Hades*, a study in comparative mythology.

BLOOMFIELD, ROBERT (1766-1823), English poet, was born of humble parents at the village of Honington, Suffolk, on the 3rd of December 1766. He was apprenticed at the age of eleven to a farmer, but he was too small and frail for field labour, and four years later he came to London to work for a shoemaker. The poem that made his reputation, *The Farmer's Boy*, was written in a garret in Bell Alley. The manuscript, declined by several publishers, fell into the hands of Capell Loft, who arranged for its publication with woodcuts by Bewick in 1800. The success of the poem was remarkable, over 25,000 copies being sold in the next two years. His reputation was increased by the appearance of his *Rural Tales* (1802), *News from the Farm* (1804), *Wild Flowers* (1806) and *The Banks of the Wyre* (1811). Influential friends attempted to provide for Bloomfield, but ill-health and possibly faults of temperament prevented the success of these efforts, and the poet died in poverty at Shefford, Bedfordshire, on the 19th of August 1823. His *Remains in Poetry and Verse* appeared in 1824.

BLOOMFIELD, a town of Essex county, New Jersey, U.S.A., about 12 m. W. of New York, and directly adjoining the city of Newark on the N. Pop. (1900) 9668, of whom 2267 were foreign-born; (1905, state census) 11,668; (1910), 15,070. Area, 5,4280. m. Bloomfield is served by the Erie, and the Delaware, Lackawanna & Western railways, and by several electric lines connecting with Newark, Montclair, Orange, East Orange and other neighbouring places. It is a residential suburb of Newark and New York, is the seat of a German theological school (Presbyterian, 1869) and has the Jarvie Memorial library (1902). There is a Central Green, and in 1908 land was acquired for another park. Among the town's manufactures are silk and woollen goods, paper, electric elevators, electric lamps, rubber goods, safety pins, hats, cream separators, brushes and novelties. The value of the town's factory products increased from \$3,370,924 in 1900 to \$4,645,483 in 1905, or 37.8%. First settled about 1670-1675 by the Dutch and by New Englanders from the Newark colony, Bloomfield was long a part of Newark, the principal settlement at first being known as Wardsession. In 1796 it was named Bloomfield in honour of General Joseph Bloomfield (1753-1823), who served (1775-1778) in the War of American Independence, reaching the rank of major, was governor of New Jersey in 1801-1802 and 1803-1812, brigadier-

general in the United States army during the War of 1812, and a Democratic representative in Congress from 1817 to 1821. The township of Bloomfield was incorporated in 1812. From it were subsequently set off Belleville (1839), Montclair (1868) and Glen Ridge (1895).

BLOOMINGTON, a city and the county-seat of McLean county, Illinois, U.S.A., in the central part of the state, about 125 m. S.W. of Chicago. Pop. (1890) 20,484; (1900) 23,286, of whom 3611 were foreign-born, there being a large German element; (1910 census) 25,768. The city is served by the Chicago & Alton, the Illinois Central, the Cleveland, Chicago, Cincinnati & St Louis, and the Lake Erie & Western railways, and by electric inter-urban lines. Bloomington is the seat of the Illinois Wesleyan University (Methodist Episcopal, co-educational, founded in 1850), which comprises a college of liberal arts, an academy, a college of law, a college of music and a school of oratory, and in 1907 had 1350 students. In the town of NORMAL (pop. in 1900, 3795), 2 m. north of Bloomington, are the Illinois State Normal University (opened at Bloomington in 1857 and removed to its present site in 1860), one of the first normal schools in the Middle West, and the state soldiers' orphans' home (1869). Bloomington has a public library, and Franklin and Miller parks; among its principal buildings are the court house, built of marble, and the Y.M.C.A. building. Among the manufacturing establishments are foundries and machine shops, including the large shops of the Chicago & Alton railway, slaughtering and meat-packing establishments, flour and grist mills, printing and publishing establishments, a caramel factory and lumber factories. The value of the city's factory products increased from \$3,011,899 in 1900 to \$5,777,000 in 1905, or 91.8%. There are valuable coal mines in and near the city, and the city is situated in a fine farming region. Bloomington derives its name from Blooming Grove, a small forest which was crossed by the trails leading from the Galena lead mines to Southern Illinois, from Lake Michigan to St Louis, and from the Eastern to the far Western states. The first settlement was made in 1822, but the town was not formally founded until 1831, when it became the county-seat of McLean county. The first city charter was obtained in 1850, and in 1857 the public school system was established. In 1856 Bloomington was the meeting place of a state convention called by the Illinois editors who were opposed to the Kansas-Nebraska Bill (see DECATUR). This was the first convention of the Republican party in Illinois; among the delegates were Abraham Lincoln, Richard Yates, John M. Palmer and Owen Lovejoy. The city has been the residence of a number of prominent men, including David Davis (1815-1886), an associate justice of the United States Supreme Court in 1862-1877, a member of the United States Senate in 1877-1883, and president *pro tempore* of the Senate in 1881-1883; Governor John M. Hamilton (1847-1905), Governor Joseph W. Fifer (b. 1840); and Adlai Ewing Stevenson (b. 1835), a Democratic representative in Congress in 1875-1877 and 1879-1881, and vice-president of the United States in 1893-1897. Bloomington's prosperity increased after 1867, when coal was first successfully mined in the vicinity.

In the *Transactions* of the Illinois State Historical Society for 1905 may be found a paper, "The Bloomington Convention of 1856 and Those Who Participated in it."

BLOOMINGTON, a city and the county-seat of Monroe county, Indiana, U.S.A., about 45 m. S. by W. of Indianapolis. Pop. (1890) 4018; (1900) 6460, including 396 negroes; (1910) 8338. It is served by the Chicago, Indianapolis & Louisville and the Indianapolis Southern (Illinois Central) railways. Bloomington is the seat of the Indiana University (co-educational since 1868), established as a state seminary in 1820, and as Indiana College in 1828, and chartered as the State university in 1838; in 1907-1908 it had 80 instructors, 2051 students, and a library of 65,000 volumes; its school of law was established in 1842, suspended in 1877 and re-established in 1889; its school of medicine was established in 1903; but most of the medical course is given in Indianapolis; a graduate school was organized in 1904; and a summer school (or summer term of eleven weeks) was first

held in 1905. Dr David Starr Jordan was the first president of the university in 1885-1891, when it was thoroughly reorganized and its curriculum put on the basis of major subjects and departments. The university's biological station is on Winona Lake, Kosciusko county. Among the manufactures of Bloomington are furniture and wooden ware. There are valuable limestone quarries in the vicinity. The city was first settled about 1818.

BLOOMSBURG, a town and the county-seat of Columbia county, Pennsylvania, U.S.A., on Fishing Creek, 2 m. from its confluence with the Susquehanna, and about 40 m. S.W. of Wilkes-Barre. Pop. (1890) 4635; (1900) 6170 (213 foreign-born); (1910) 7413. It is served by the Delaware, Lackawanna & Western, the Philadelphia & Reading, and the Bloomsburg & Sullivan and the Susquehanna, Bloomsburg & Berwick railways (the last two only 30 m. and 39 m. long respectively); and is connected with Berwick, Catawissa and Danville by electric lines. The town is built on a bluff commanding extensive views. Among the manufactures of Bloomsburg are railway cars, carriages, silk and woollen goods, furniture, carpets, wire-drawing machines and gun carriages. Iron ore was formerly obtained from the neighbouring hills. The town is the seat of a state normal school, established as such in 1869. Bloomsburg was laid out as a town in 1802, became the county-seat in 1846, and was incorporated in 1870.

BLOUNT, CHARLES (1654-1693), English author, was born at Upper Holloway on the 27th of April 1654. His father, Sir Henry Blount (1602-1682), was the author of a *Voyage to the Levant*, describing his own travels. He gave his son a careful education, and is said to have helped him in his *Anima Mundi; or An Historical Narration of the Opinions of the Antients concerning Man's Soul after his Life, according to unenlightened Nature* (1670), which gave great offence by the sceptical views expressed in it. It was suppressed by order of the bishop of London, and even burnt by some over-zealous official, but a re-issue was permitted. Blount was an admirer of Hobbes, and published his "Last Sayings" (1679), a pamphlet consisting of extracts from *The Leviathan*. Great is *Diana of the Ephesians, or the Original of Idolatry, together with the Political Institution of the Gentiles' Sacrifices* (1680) attracted severe criticism on the ground that in depreciating the evils of priestcraft Blount was attacking Christianity itself. His best-known book, *The Two First Books of Philostratus concerning the Life of Apollonius Tyaneus* . . . (1680), is said to have been prohibited in 1693, chiefly on account of the notes, which are stated by Bayle (note, s.v. *Apollonius*) to have been taken mainly from a MS. of Lord Herbert of Cherbury. Blount contributed materially to the removal of the restrictions on the freedom of the press, with two pamphlets (1693) by "Philopatris," mainly derived from Milton's *Areopagitica*. He also laid a successful trap for the censor, Edmund Bohun. Under the name of "Junius Brutus" he wrote a pamphlet entitled "King William and Queen Mary Conquerors." The title-page set forth the theory of the justice of title by conquest, which Blount knew to be agreeable to Bohun. It was duly licensed, but was ordered by the House of Commons to be burnt by the common hangman, as being diametrically opposed to the attitude of William's government on the subject. These proceedings showed the futility of the censorship, and hastened its overthrow.

Blount had fallen in love with his deceased wife's sister, and, in despair of overcoming her scruples as to the legality of such a marriage, shot himself in the head. He survived for some time, refusing help except from his sister-in-law. Alexander Pope asserted (*Epilogue to the Satires*, Note, l. 124) that he wounded himself in the arm, pretending to kill himself, and that the result was fatal contrary to his expectations. He died in August 1693.

Shortly before his death a collection of his pamphlets and private papers was printed with a preface by Charles Gildon, under the title of the *Oracles of Reason*. His *Miscellaneous Works* (1695) is a fuller edition by the same editor.

BLOUNT (or **BLOUNT**), EDWARD (b. 1565?), the printer, in conjunction with Isaac Jaggard, of *Mr William Shakespeares*

Comedies, Histories and Tragedies. Published according to the true Originall Copies (1623), usually known as the first folio of Shakespeare. It was produced under the direction of John Heming (d. 1630) and Henry Condell (d. 1627), both of whom had been Shakespeare's colleagues at the Globe theatre, but as Blount combined the functions of printer and editor on other occasions, it is fair to conjecture that he to some extent edited the first folio. The Stationers' Register states that he was the son of Ralph Blount or Blunt, merchant tailor of London, and apprenticed himself in 1578 for ten years to William Ponsonby, a stationer. He became a freeman of the Stationers' Company in 1588. Among the most important of his publications are Giovanni Florio's Italian-English dictionary and his translation of Montaigne, Marlowe's *Hero and Leander*, and the *Six Court Comedies* of John Lyly. He himself translated *Ars Aulica, or the Courtier's Arte* (1607) from the Italian of Lorenzo Ducci, and *Christian Policie* (1632) from the Spanish of Juan de Santa Maria.

BLOUNT, THOMAS (1618-1679), English antiquarian, was the son of one Myles Blount, of Orleton in Herefordshire. He was born at Bordesley, Worcestershire. Few details of his life are known. It appears that he was called to the bar at the Inner Temple, but, being a zealous Roman Catholic, his religion interfered considerably with the practice of his profession. Retiring to his estate at Orleton, he devoted himself to the study of the law as an amateur, and also read widely in other branches of knowledge. He died at Orleton on the 26th of December 1679. His principal works are *Glossographia; or, a dictionary interpreting the hard words of whatsoever language, now used in our refined English tongue* (1656, reprinted in 1707), which went through several editions and remains most amusing and instructive reading; *Nomolexicon: a law dictionary interpreting such difficult and obscure words and terms as are found either in our common or statute, ancient or modern laws* (1670; third edition, with additions by W. Nelson, 1717); and *Fragmenta Antiquitatis: Ancient Tenures of land, and jocular customs of some manners* (1679; enlarged by J. Beckwith and republished, with additions by H. M. Beckwith, in 1815; again revised and enlarged by W. C. Hazlitt, 1874). Blount's *Boscobel* (1651), giving an account of Charles II.'s preservation after Worcester, with the addition of the king's own account dictated to Pepys, has been edited with a bibliography by C. G. Thomas (1894).

BLOUNT, SIR THOMAS POPE (1649-1697), English author, eldest son of Sir Henry Blount and brother of Charles Blount (q.v.), was born at Upper Holloway on the 12th of September 1649. He succeeded to the estate of Tittenhanger on his mother's death in 1678, and in the following year was created a baronet. He represented the borough of St Albans in the two last parliaments of Charles II. and was knight of the shire from the revolution till his death. He married Jane, daughter of Sir Henry Caesar, by whom he had five sons and nine daughters. He died at Tittenhanger on the 30th of June 1697. His *Censura celebrum authorum sive tractatus in quo varia virorum doctorum de clarissimis cujusque seculi scriptoribus judicia traduntur* (1690) was originally compiled for Blount's own use, and is a dictionary in chronological order of what various eminent writers have said about one another. This necessarily involved enormous labour in Blount's time. It was published at Geneva in 1694 with all the quotations from modern languages translated into Latin, and again in 1710. His other works are *A Natural History, containing many not common observations extracted out of the best modern writers* (1693), *De re poetica, or remarks upon Poetry, with Characters and Censures of the most considerable Poets* . . . (1694), and *Essays on Several Occasions* (1692). It is on this last work that his claims to be regarded as an original writer rest. The essays deal with the perversion of learning, a comparison between the ancients and the moderns (to the advantage of the latter), the education of children, and kindred topics. In the third edition (1697) he added an eighth essay, on religion, in which he deprecated the multiplication of ceremonies. He displays throughout a hatred of pedantry and convention, which makes his book still interesting.

See A. Kippis, *Biographia Britannica* (1780), vol. ii. For an account of Blount's family see Robert Clutterbuck, *History and Antiquities of the County of Hertford* (1815), vol. i. pp. 207-212.

BLOUNT, WILLIAM (1749-1800), American politician, was born in Bertie county, North Carolina, on the 26th of March 1749. He was a member of the Continental Congress in 1783-1784 and again in 1786-1787, of the constitutional convention at Philadelphia in 1787, and of the state convention which ratified the Federal constitution for North Carolina in 1789. From 1790 until 1796 he was, by President Washington's appointment, governor of the "Territory South of the Ohio River," created out of land ceded to the national government by North Carolina in 1789. He was also during this period the superintendent of Indian affairs for this part of the country. In 1791 he laid out Knoxville (Tennessee) as the seat of government. He presided over the constitutional convention of Tennessee in 1796, and, on the state being admitted to the Union, became one of its first representatives in the United States Senate. In 1797 his connexion became known with a scheme, since called "Blount's Conspiracy," which provided for the co-operation of the American frontiersmen, assisted by Indians, and an English force, in the seizure on behalf of Great Britain of the Floridas and Louisiana, then owned by Spain, with which power England was then at war. As this scheme, if carried out, involved the corrupting of two officials of the United States, an Indian agent and an interpreter, a breach of the neutrality of the United States, and the breach of Article V. of the treaty of San Lorenzo el Real (signed on the 27th of October 1795) between the United States and Spain, by which each power agreed not to incite the Indians to attack the other, Blount was impeached by the House of Representatives on the 7th of July 1797, and on the following day was formally expelled from the Senate for "having been guilty of high misdemeanor, entirely inconsistent with his public trust and duty as a senator." On the 20th of January 1798 articles of impeachment were adopted by the House of Representatives. On the 14th of January 1799, however, the Senate, sitting as a court of impeachment, decided that it had no jurisdiction, Blount not then being a member of the Senate, and, in the Senate's opinion, not having been, even as a member, a civil officer of the United States, within the meaning of the constitution. The case is significant as being the first case of impeachment brought before the United States Senate. "In a legal point of view, all that the case decides is that a senator of the United States who has been expelled from his seat is not after such expulsion subject to impeachment" (Francis Wharton, *State Trials*). In effect, however, it also decided that a member of Congress was not in the meaning of the constitution a civil officer of the United States and therefore could not be impeached. The "conspiracy" was disavowed by the British government, which, however, seems to have secretly favoured it. Blount was enthusiastically supported by his constituents, and upon his return to Tennessee was made a member and the presiding officer of the state senate. He died at Knoxville on the 21st of March 1800.

For a defence of Blount, see General Marcus J. Wright's *Account of the Life and Services of William Blount* (Washington, D. C., 1884).

BLOUSE, a word (taken from the French) used for any loosely fitting bodice belted at the waist. In France it meant originally the loose upper garment of linen or cotton, generally blue, worn by French workmen to preserve their clothing, and, by transference, the workman himself.

BLOW, JOHN (1648-1708), English musical composer, was born in 1648, probably at North Collingham in Nottinghamshire. He became a chorister of the chapel royal, and distinguished himself by his proficiency in music; he composed several anthems at an unusually early age, including *Lord, Thou hast been our refuge*; *Lord, rebuke me not*; and the so-called "club anthem," *I will always give thanks*, the last in collaboration with Pelham Humphrey and William Turner, either in honour of a victory over the Dutch in 1665, or—more probably—simply to commemorate the friendly intercourse of the three choristers. To this time also belongs the composition of a two-part setting

of Herrick's *Goe, perjur'd man*, written at the request of Charles II. to imitate Carissimi's *Dixie, a cielei*. In 1669 Blow became organist of Westminster Abbey. In 1673 he was made a gentleman of the chapel royal, and in the September of this year he was married to Elizabeth Braddock, who died in childbirth ten years later. Blow, who by the year 1678 was a doctor of music, was named in 1685 one of the private musicians of James II. Between 1680 and 1687 he wrote the only stage composition by him of which any record survives, the *Masque for the Entertainment of the King: Venus and Adonis*. In this Mary Davies played the part of Venus, and her daughter by Charles II., Lady Mary Tudor, appeared as Cupid. In 1687 he became master of the choir of St Paul's church; in 1695 he was elected organist of St Margaret's, Westminster, and is said to have resumed his post as organist of Westminster Abbey, from which in 1689 he had retired or been dismissed to make way for Purcell. In 1699 he was appointed to the newly created post of composer to the chapel royal. Fourteen services and more than a hundred anthems by Blow are extant. In addition to his purely ecclesiastical music Blow wrote *Great sir, the joy of all our hearts*, an ode for New Year's day 1681-1682; similar compositions for 1683, 1686, 1687, 1688, 1689, 1693 (?), 1694 and 1700; odes, &c., for the celebration of St Cecilia's day for 1684, 1691, 1695 and 1700; for the coronation of James II. two anthems, *Behold, O God, our Defender*, and *God spake sometimes in visions*; some harpsichord pieces for the second part of Playford's *Musick's Handmaid* (1689); *Epicidium for Queen Mary* (1695); *Ode on the Death of Purcell* (1696). In 1700 he published his *Amphion Anglicus*, a collection of pieces of music for one, two, three and four voices, with a figured-bass accompaniment. A famous page in Burney's *History of Music* is devoted to illustrations of "Dr Blow's Crudities," most of which only show the meritorious if immature efforts in expression characteristic of English music at the time, while some of them (where Burney says "Here we are lost") are really excellent. Blow died on the 1st of October 1708 at his house in Broad Sanctuary, and was buried in the north aisle of Westminster Abbey.

BLOW-GUN, a weapon consisting of a long tube, through which, by blowing with the mouth, arrows or other missiles can be shot accurately to a considerable distance. Blow-guns are used both in warfare and the chase by the South American Indian tribes inhabiting the region between the Amazon and Orinoco rivers, and by the Dyaks of Borneo. In the 18th century they were also known to certain North American Indians, especially the Choctaws and Cherokees of the lower Mississippi. Captain Bossu, in his *Travels through Louisiana* (1756), says of the Choctaws: "They are very expert in shooting with an instrument made of reeds about 7 ft. long, into which they put a little arrow feathered with the wool of the thistle (wild cotton?)." The blow-guns of the South American Indians differ in style and workmanship. That of the Macusis of Guiana, called *pucoma*, is the most perfect. It is made of two tubes, the inner of which, called *oorah*, is a light reed $\frac{3}{4}$ in. in diameter which often grows to a length of 15 ft. without a joint. This is enclosed, for protection and solidity, in an outer tube of a variety of palm (*Iriartella setigera*). The mouth-piece is made of a circlet of silk-grass, and the farther end is feruled with a kind of nut, forming a sight. A rear open sight is formed of two teeth of a small rodent. The length of the *pucoma* is about 12 ft. and its weight 1½ lb. The arrows, which are from 12 to 18 in. long and very slender, are made of ribs of the cocorite palm-leaf. They are usually feathered with a tuft of wild cotton, but some have in place of the cotton a thin strip of bark curled into a cone, which, when the shooter blows into the *pucoma*, expands and completely fills the tube, thus avoiding windage. Another kind of arrow is furnished with fibres of bark fixed along the shaft, imparting a rotary motion to the missile, a primitive example of the theory of the rifle. The arrows used in Peru are only a few inches long and as thin as fine knitting-needles. All South American blow-gun arrows are steeped in poison. The natives shoot very accurately with the *pucoma* at distances up to 50 or 60 yds.

The blow-gun of the Borneo Dyaks, called *sumpitan*, is from

6 to 7 ft. long and made of ironwood. The bore, of $\frac{1}{2}$ in., is made with a long pointed piece of iron. At the muzzle a small iron hook is affixed, to serve as a sight, as well as a spear-head like a bayonet and for the same purpose. The arrows used with the *saupiquan* are about 10 in. long, pointed with fish-teeth, and feathered with pith. They are also envenomed with poison.

Poisoned arrows are also used by the natives of the Philippine island of Mindanao, whose blow-pipes, from 3 to 4 ft. long and made of bamboo, are often richly ornamented and even jewelled.

The principle of the blow-gun is, of course, the same as that of the common "pea-shooter."

See *Sport with Rod and Gun in American Woods and Waters*, by A. M. Mayer, vol. ii. (Edinburgh, 1884); *Wanderings in South America*, &c., by Charles Waterton (London, 1828); *The Head Hunters of Borneo*, by Carl Bock (London, 1881).

BLOWITZ, HENRI GEORGES STEPHAN ADOLPHE DE (1825-1903), Anglo-French journalist, was born, according to the account given in his memoirs, at his father's chateau in Bohemia on the 28th of December 1825. At the age of fifteen he left home, and travelled over Europe for some years in company with a young professor of philology, acquiring a thorough knowledge of French, German and Italian and a mixed general education. The finances of his family becoming straitened, young Blowitz was on the point of starting to seek his fortune in America, when he became acquainted in Paris with M. de Falloux, minister of public instruction, who appointed him professor of foreign languages at the Tours Lycée, whence, after some years, he was transferred to the Marseilles Lycée. After marrying in 1850 he resigned his professorship, but remained at Marseilles, devoting himself to literature and politics. In 1869 information which he supplied to a legitimist newspaper at Marseilles with regard to the candidature of M. de Lesseps as deputy for that city led to a demand for his expulsion from France. He was, however, allowed to remain, but had to retire to the country. In 1870 his predictions of the approaching fall of the Empire caused the demand for his expulsion to be renewed. While his case was under discussion the battle of Sedan was fought, and Blowitz effectually ingratiated himself with the authorities by applying for naturalization as a French subject. Once naturalized, he returned to Marseilles, where he was fortunately able to render considerable service to Thiers, who subsequently employed him in collecting information at Versailles, and when this work was finished offered him the French consularship at Riga. Blowitz was on the point of accepting this post when Laurence Oliphant, then Paris correspondent of *The Times*, for which Blowitz had already done some occasional work, asked him to act as his regular assistant for a time, Frederick Hardman, the other Paris correspondent of *The Times*, being absent. Blowitz accepted the offer, and when, later on, Oliphant was succeeded by Hardman he remained as assistant correspondent. In 1873 Hardman died, and Blowitz became chief Paris correspondent to *The Times*. In this capacity he soon became famous in the world of journalism and diplomacy. In 1875 the duc de Decazes, then French foreign minister, showed Blowitz a confidential despatch from the French ambassador in Berlin (in which the latter warned his government that Germany was contemplating an attack on France), and requested the correspondent to expose the German designs in *The Times*. The publication of the facts effectually aroused European public opinion, and any such intention was immediately thwarted. Blowitz's most sensational journalistic feat was achieved in 1878, when his enterprise enabled *The Times* to publish the whole text of the treaty of Berlin at the actual moment that the treaty was being signed in Germany. In 1877 and again in 1888 Blowitz rendered considerable service to the French government by his exposure of internal designs upon the Republic. He died on the 18th of January 1903.

My Memoirs, by H. S. de Blowitz, was published in 1903.

BLOWPIPE, in the arts and chemistry, a tube for directing a jet of air into a fire or into the flame of a lamp or gas jet, for the purpose of producing a high temperature by accelerating the combustion. The blowpipe has been in common use from the earliest times for soldering metals and working glass, but its introduction into systematic chemical analysis is to be

ascribed to A. F. Cronstedt, and not to Anton Swab, as has been maintained (see J. Landauer, *Ber.* 26, p. 898). The first work on this application of the blowpipe was by G. v. Engeström, and was published in 1770 as an appendix to a treatise on mineralogy. Its application has been variously improved at the hands of T. O. Bergman, J. G. Gahn, J. J. Berzelius, C. F. Plattner and others, but more especially by the two last-named chemists.

The simplest and oldest form of blowpipe is a conical brass tube, about 7 in. in length, curved at the small end into a right angle, and terminating in a small round orifice, which is applied to the flame, while the larger end is applied to the mouth.

Where the blast has to be kept up for only a few seconds, this instrument is quite serviceable, but in longer chemical operations inconvenience arises from the condensation of moisture exhaled by the lungs in the tube. Hence most blowpipes are now made with a cavity for retaining the moisture. Cronstedt placed a bulb in the centre of his blowpipe. Dr Joseph Black's instrument consists of a conical tube of tin plate, with a small brass tube, supporting the nozzle, inserted near the wider end, and a mouth-piece at the narrow end.

The sizes of orifice recommended by Plattner are 0.4 and 0.5 mm. A trumpet mouth-piece is recommended from the support it gives to the cheeks when inflated. The mode of blowing is peculiar, and requires some practice; an uninterrupted blast is kept up by the muscular action of the cheeks, while the ordinary respiration goes on through the nostrils.

If the flame of a candle or lamp be closely examined, it will be seen to consist of four parts—(a) a deep blue ring at the base, (b) a dark cone in the centre, (c) a luminous portion round this, and (d) an exterior pale blue envelope (see **FLAME**). In blowpipe work only two of these four parts are made use of, viz. the pale envelope, for oxidation, and the luminous portion, for reduction. To obtain a good *oxidizing flame*, the blowpipe is held with its nozzle inserted in the edge of the flame close over the level of the wick, and blown into gently and evenly. A conical jet is thus produced, consisting of an inner cone, with an outer one commencing near its apex—the former, corresponding to (a) in the free flame, blue and well defined; the latter corresponding to (d), pale blue and vague. The heat is greatest just beyond the point of the inner cone, combustion being there most complete. Oxidation is better effected (if a very high temperature be not required) the farther the substance is from the apex of the inner cone, for the air has thus freer access. To obtain a good *reducing flame* (in which the combustible matter, very hot, but not yet burned, is disposed to take oxygen from any compound containing it), the nozzle, with smaller orifice, should just touch the flame at a point higher above the wick, and a somewhat weaker current of air should be blown. The flame then appears as a long, narrow, luminous cone, the end being enveloped by a dimly visible portion of flame corresponding to that which surrounds the free flame, while there is also a dark nucleus about the wick. The substance to be reduced is brought into the luminous portion, where the reducing power is strongest.

Various materials are used as supports for substances in the blowpipe flame; the principal are charcoal, platinum and glass or porcelain. *Charcoal* is valuable for its infusibility and low conductivity for heat (allowing substances to be strongly heated upon it), and for its powerful reducing properties; so that it is chiefly employed in testing the fusibility of minerals and in reduction. The best kind of charcoal is that of close-grained pine or alder; it is cut in short prisms, having a flat smooth surface at right angles to the rings of growth. In this a shallow hole is made for receiving the substance to be held in the flame. Gas-carbon is sometimes used, since it is more permanent in the flame than wood charcoal. *Platinum* is employed in oxidizing processes, and in the fusion of substances with fluxes; also in observing the colouring effect of substances on the blowpipe flame (which effect is apt to be somewhat masked by charcoal). Most commonly it is used in the form of wire, with a small bend or loop at the end.

The mouth blowpipe is unsuitable for the production of a large flame, and cannot be used for any lengthy operations; hence recourse must be made to types in which the air-blast is occasioned by mechanical means. The laboratory form in common use consists of a bellows worked by either hand or foot, and a special type of gas burner formed of two concentric tubes, one conveying the blast, the other the gas; the supply of air and gas being regulated by stopcocks. The *hot blast blowpipe* of T. Fletcher, in which the blast is heated by passing through a copper coil heated by a separate burner, is only of service when a pointed flame of a fairly high temperature is required. Blowpipes in which oxygen is used as the blast have been manufactured by Fletcher, Russell & Co., and have proved of great service in conducting fusions which require a temperature above that yielded by the air-blowpipe.

For the applications of the blowpipe in chemical analysis see CHEMISTRY: *Analytical*.

BLÜCHER, GEBHARD LEBERECHEIT VOM (1742-1819), Prussian general field marshal, prince of Wahlstadt in Silesia, was born at Rostock on the 16th of December 1742. In his fourteenth year he entered the service of Sweden, and in the Pomeranian campaign of 1760 he was taken prisoner by the Prussians. He was persuaded by his captors to enter the Prussian service. He took part in the later-battles of the Seven Years' War, and as a hussar officer gained much experience of light cavalry work. In peace, however, his ardent spirit led him into excesses of all kinds, and being passed over for promotion he sent in his resignation, to which Frederick replied, "Captain Blücher can take himself to the devil" (1773). He now settled down to farming, and in fifteen years he had acquired an honourable independence. But he was unable to return to the army until after the death of Frederick the Great. He was then reinstated as major in his old regiment, the Red Hussars. He took part in the expedition to Holland in 1787, and in the following year became lieutenant-colonel. In 1789 he received the order *pour le mérite*, and in 1794 he became colonel of the Red Hussars. In 1793 and 1794 he distinguished himself in cavalry actions against the French, and for his success at Kirrweiler he was made a major-general. In 1801 he was promoted lieutenant-general.

He was one of the leaders of the war party in Prussia in 1805-1806, and served as a cavalry general in the disastrous campaign of the latter year. At Auerstädt Blücher repeatedly charged at the head of the Prussian cavalry, but without success. In the retreat of the broken armies he commanded the rearguard of Prince Hohenlohe's corps, and upon the capitulation of the main body of Prenzlau he carried off a remnant of the Prussian army to the northward, and in the neighbourhood of Lübeck he fought a series of combats, which, however, ended in his being forced to surrender at Ratkau (November 7, 1806). His adversaries testified in his capitulation that it was caused by "want of provisions and ammunition." He was soon exchanged for General Victor, and was actively employed in Pomerania, at Berlin, and at Königsberg until the conclusion of the war. After the war, Blücher was looked upon as the natural leader of the patriot party, with which he was in close touch during the period of Napoleonic domination. His hopes of an alliance with Austria in the war of 1809 were disappointed. In this year he was made general of cavalry. In 1812 he expressed himself so openly on the alliance of Russia with France that he was recalled from his military governorship of Pomerania and virtually banished from the court.

When at last the Napoleonic domination was ended by the outbreak of the War of Liberation in 1813, Blücher of course was at once placed in high command, and he was present at Lützen and Bautzen. During the armistice he worked at the organization of the Prussian forces, and when the war was resumed Blücher became commander-in-chief of the Army of Silesia, with Gneisenau and Müffling as his principal staff officers, and 40,000 Prussians and 50,000 Russians under his control. The autumn campaign of 1813 will be found described in the article NAPOLEONIC CAMPAIGNS, and it will here be sufficient to say that the most conspicuous military quality displayed by

Blücher was his unrelenting energy. The irresolution and divergence of interests usual in allied armies found in him a restless opponent, and the knowledge that if he could not induce others to co-operate he was prepared to attempt the task in hand by himself often caused other generals to follow his lead. He defeated Marshal Macdonald at the Katzbach, and by his victory over Marmont at Möckern led the way to the decisive overthrow of Napoleon at Leipzig, which place was stormed by Blücher's own army on the evening of the last day of the battle. On the day of Möckern (October 16, 1813) Blücher was made a general field marshal, and after the victory he pursued the routed French with his accustomed energy. In the winter of 1813-1814 Blücher, with his chief staff officers, was mainly instrumental in inducing the allied sovereigns to carry the war into France itself. The combat of Brienne and the battle of La Rothière were the chief incidents of the first stage of the celebrated campaign of 1814, and they were quickly followed by the victories of Napoleon over Blücher at Champaubert, Vauchamps and Montmirail. But the courage of the Prussian leader was undiminished, and his great victory of Laon (March 9 to 10) practically decided the fate of the campaign. After this Blücher infused some of his own energy into the operations of Prince Schwarzenberg's Army of Bohemia, and at last this army and the Army of Silesia marched in one body direct upon Paris. The victory of Montmartre, the entry of the allies into the French capital, and the overthrow of the First Empire were the direct consequences. Blücher was disposed to make a severe retaliation upon Paris for the calamities that Prussia had suffered from the armies of France had not the allied commanders intervened to prevent it. Blowing up the bridge of Jena was said to be one of his contemplated acts. On the 3rd of June 1814 he was made prince of Wahlstadt (in Silesia on the Katzbach battlefield), and soon afterwards he paid a visit to England, being received everywhere with the greatest enthusiasm.

After the peace he retired to Silesia, but the return of Napoleon soon called him to further service. He was put in command of the Army of the Lower Rhine with General Gneisenau as his chief of staff (see WATERLOO CAMPAIGN). In the campaign of 1815 the Prussians sustained a very severe defeat at the outset at Ligny (June 16), in the course of which the old field marshal was ridden over by cavalry charges, his life being saved only by the devotion of his aide-de-camp, Count Nostitz. He was unable to resume command for some hours, and Gneisenau drew off the defeated army. The relations of the Prussian and the English headquarters were at this time very complicated, and it is uncertain whether Blücher himself was responsible for the daring resolution to march to Wellington's assistance. This was in fact done, and after an incredibly severe march Blücher's army intervened with decisive and crushing effect in the battle of Waterloo. The great victory was converted into a success absolutely decisive of the war by the relentless pursuit of the Prussians, and the allies re-entered Paris on the 7th of July. Prince Blücher remained in the French capital for some months, but his age and infirmities compelled him to retire to his Silesian residence at Kriebowitz, where he died on the 12th of September 1819, aged seventy-seven. He retained to the end of his life that wildness of character and proneness to excesses which had caused his dismissal from the army in his youth, but however they may be regarded, these faults sprang always from the ardent and vivid temperament which made Blücher a dashing leader of horse. The qualities which made him a great general were his patriotism and the hatred of French domination which inspired every success of the War of Liberation. He was twice married, and had, by his first marriage, two sons and a daughter. Statues were erected to his memory at Berlin, Breslau and Rostock.

Of the various lives of Prince Blücher, that by Varnhagen von Ense (1827) is the most important. His war diaries of 1793-1794, together with a memoir (written in 1805) on the subject of a national army, were edited by Golz and Ribbentrop (*Campagne Journal 1793-4 von G. L. v. Blücher*).

BLUE (common in different forms to most European languages), the name of a colour, used in many colloquial

phrases. From the fact of various parties, political and other, having adopted the colour blue as their badge, various classes of people have come to be known as "blue" or "blues"; thus "true blue" meant originally a staunch Presbyterian, the Covenanters having adopted blue as their colour as opposed to red, the royal colour; similarly, in the navy, there was in the 18th century a "Blue Squadron," Nelson being at one time "Rear-Admiral of the Blue"; again, in 1690, the Royal Horse Guards were called the "Blues" from their blue uniforms, or, from their leader, the earl of Oxford, the "Oxford Blues"; also, from the blue ribbon worn by the knights of the Garter comes the use of the phrase as the highest mark of distinction that can be worn, especially applied on the turf to the winning of the Derby. The "blue Peter" is a rectangular blue flag, with a white square in the centre, hoisted at the top of the foremast as a signal that a vessel is about to leave port. At Oxford and Cambridge a man who represents his university in certain athletic sports is called a "blue" from the "colours" he is then entitled to wear, dark blue for Oxford and light blue for Cambridge.

BLUEBEARD, the monster of Charles Perrault's tale of *Barbe Bleue*, who murdered his wives and hid their bodies in a locked room. Perrault's tale was first printed in his *Histoires et contes à l'usage des enfants* (1697). The essentials of the story—Bluebeard's prohibition to his wife to open a certain door during his absence, her disobedience, her discovery of a gruesome secret, and her timely rescue from death—are to be found in other folklore stories, none of which, however, has attained the fame of *Bluebeard*. A close parallel exists in an Estonian legend of a husband who had already killed eleven wives, and was prevented from killing the twelfth, who had opened a secret room, by a gooseherd, the friend of her childhood. In "The Feather Bird" of Grimm's *Hausmärchen*, three sisters are the victims, the third being rescued by her brothers. Bluebeard, though Perrault does not state the number of his crimes, is generally credited with the murder of seven wives. His history belongs to the common stock of folklore, and has even been ingeniously fitted with a mythical interpretation. In France the Bluebeard legend has its local habitation in Brittany, but whether the existing traditions connecting him with Gilles de Rais (*q.v.*) or Comorre the Cursed, a Breton chief of the 6th century, were anterior to Perrault's time, we have no means of determining. The identification of Bluebeard with Gilles de Rais, the *bleu d'extermination* of Michelet's forcible language, persists locally in the neighbourhood of the various castles of the baron, especially at Machecoul and Tiffauges, the chief scenes of his infamous crimes. Gilles de Rais, however, had only one wife, who survived him, and his victims were in the majority of cases young boys. The traditional connexion may arise simply from the not improbable association of two monstrous tales. The less widespread identification of Bluebeard with Comorre is supported by a series of frescoes dating only a few years later than the publication of Perrault's story, in a chapel at St Nicolas de Bieuzy dedicated to St Tryphine, in which the tale of Bluebeard is depicted as the story of the saint, who in history was the wife of Comorre. Comorre or Conomor had his original headquarters at Carhair, in Finistère. He extended his authority by marriage with the widow of Iona, chief of Domnonia, and attempted the life of his stepson Judwal, who fled to the Frankish court. About 547 or 548 he obtained in marriage, through the intercession of St Gildas, Tryphine, daughter of Weroc, count of Vannes. The pair lived in peace at Castel Finans for some time, but Comorre, disappointed in his ambitions in the Vannetais, presently threatened Tryphine. She took flight, but her husband found her hiding in a wood, when he gave her a wound on the skull and left her for dead. She was tended and restored to health by St Gildas, and after the birth of her son retired to a convent of her own foundation. Eventually Comorre was defeated and slain by Judwal. In legend St Tryphine was decapitated and miraculously restored to life by Gildas. Alain Bouchard (*Grandes croniques*, Nantes, 1531) asserts that Comorre had already put several wives to death before he married Tryphine. In the

Legendes bretonnes of the count d'Ameseuil the church legend becomes a charming fairy tale.

See also E. A. Vizetelly, *Bluebeard* (1902); E. Sidney Hartland, "The Forbidden Chamber," in *Folklore*, vol. iii. (1885); and the editions of the *Contes* of Charles Perrault (*q.v.*). Cf. A. France, *Les Sept Femmes de Barbe Bleue* (1909).

BLUE-BOOK, the general name given to the reports and other documents printed by order of the parliament of the United Kingdom, so called from their being usually covered with blue paper, though some are bound in drab and others have white covers. The printing of its proceedings was first adopted by the House of Commons in 1681, and in 1836 was commenced the practice of selling parliamentary papers to the public. All notices of questions, resolutions, votes and proceedings in both Houses of Parliament are issued each day during the session; other publications include the various papers issued by the different government departments, the reports of committees and commissions of inquiry, public bills, as well as returns, correspondence, &c., specially ordered to be printed by either house. The papers of each session are so arranged as to admit of being bound up in regular order, and are well indexed. The terms upon which blue-books, single papers, &c., are issued to the general public are one halfpenny per sheet of four pages, but for an annual subscription of £20 all the parliamentary publications of the year may be obtained; but subscriptions can be arranged so that almost any particular class of publication can be obtained—for example, the daily votes and proceedings can be obtained for an annual subscription of £3, the House of Lords papers for £10, or the House of Commons papers for £15. Any publication can also be purchased separately.

Most foreign countries have a distinctive colour for the binding of their official publications. That of the United States varies, but foreign diplomatic correspondence is bound in red. The United States government publications are not only on sale (as a rule) but are widely supplied gratis, with the result that important publications soon get out of print, and it is difficult to obtain access to many valuable reports or other information, except at a public library. German official publications are bound in white; French, in yellow; Austrian, in red; Portuguese, in white; Italian, in green; Spanish, in red; Mexican, in green; Japanese, in grey; Chinese, in yellow.

BLUESTOCKING, a derisive name for a literary woman. The term originated in or about 1750, when Mrs Elizabeth Montagu (*q.v.*) made a determined effort to introduce into society a healthier and more intellectual tone, by holding assemblies at which literary conversation and discussions were to take the place of cards and gossip. Most of those attending were conspicuous by the plainness of their dress, and a Mr Benjamin Stillingfleet specially caused comment by always wearing blue or worsted stockings instead of the usual black silk. It was in special reference to him that Mrs Montagu's friends were called the Bluestocking Society or Club, and the women frequenting her house in Hill Street came to be known as the "Bluestocking Ladies" or simply "bluestockings." As an alternative explanation, the origin of the name is attributed to Mrs Montagu's deliberate adoption of blue stockings (in which fashion she was followed by all her women friends) as the badge of the society she wished to form. She is said to have obtained the idea from Paris, where in the 17th century there was a revival of a social reunion in 1590 on the lines of that formed in 1400 at Venice, the ladies and men of which wore blue stockings. The term had been applied in England as early as 1653 to the Little Parliament, in allusion to the puritanically plain and coarse dress of the members.

BLUFF (a word of uncertain origin; possibly connected with an obsolete Dutch word, *blaf*, broad), an adjective used of a ship, meaning broad and nearly vertical in the bows; similarly, of a cliff or shore, presenting a bold and nearly perpendicular front; of a person, good-natured and frank, with a rough or abrupt manner. Another word "bluff," perhaps connected with German *verblüffen*, to baffle, meant originally a horse's blinker, the corresponding verb meaning to blindfold; it survives

as a term in such games as poker, where "to bluff" means to bet heavily on a hand so as to make an opponent believe it to be stronger than it is; hence such phrases as "the game of bluff," "a policy of bluff."

BLUM, ROBERT FREDERICK (1857-1903), American artist, was born in Cincinnati, Ohio, on the 9th of July 1857. He was employed for a time in a lithographic shop, and studied at the McMicken Art School of Design in Cincinnati, and at the Pennsylvania Academy of Fine Arts in Philadelphia, but he was practically self-taught, and early showed great and original talent. He settled in New York in 1879, and his first published sketches—of Japanese jugglers—appeared in *St Nicholas*. His most important work is a large frieze in the Mendelssohn Music Hall, New York, "Music and the Dance" (1895). His pen-and-ink work for the *Century* magazine attracted wide attention, as did his illustrations for Sir Edwin Arnold's *Japonica*. In the country and art of Japan he had been interested for many years. "A Daughter of Japan," drawn by Blum and W. J. Baer, was the cover of *Scribner's Magazine* for May 1893, and was one of the earliest pieces of colour-printing for an American magazine. In *Scribner's* for 1893 appeared also his "Artist's Letters from Japan." He was an admirer of Fortuny, whose methods somewhat influenced his work. Blum's Venetian pictures, such as "A Bright Day at Venice" (1882), had lively charm and beauty. He died on the 8th of June 1903 in New York City. He was a member of the National Academy of Design, being elected after his exhibition in 1892 of "The Ameya"; and was president of the Painters in Pastel. Although an excellent draughtsman and etcher, it was as a colourist that he chiefly excelled.

BLUMENBACH, JOHANN FRIEDRICH (1752-1840), German physiologist and anthropologist, was born at Gotha on the 11th of May 1752. After studying medicine at Jena, he graduated doctor at Göttingen in 1775, and was appointed extraordinary professor of medicine in 1776 and ordinary professor in 1778. He died at Göttingen on the 22nd of January 1840. He was the author of *Institutiones Physiologicae* (1787), and of a *Handbuch der vergleichenden Anatomie* (1804), both of which were very popular and went through many editions, but he is best known for his work in connexion with anthropology, of which science he has been justly called the founder. He was the first to show the value of comparative anatomy in the study of man's history, and his craniometrical researches justified his division of the human race into several great varieties or families, of which he enumerated five—the Caucasian or white race, the Mongolian or yellow, the Malayan or brown race, the Negro or black race, and the American or red race. This classification has been very generally received, and most later schemes have been modifications of it. His most important anthropological work was his description of sixty human crania published originally in *fasciculi* under the title *Collectionis suae craniorum diversarum gentium illustratae decades* (Göttingen, 1790-1828).

BLUMENTHAL, LEONHARD, COUNT VON (1810-1900), Prussian field marshal, son of Captain Ludwig von Blumenthal (killed in 1813 at the battle of Dennewitz), was born at Schwedt-on-Oder on the 30th of July 1810. Educated at the military schools of Culm and Berlin, he entered the Guards as 2nd lieutenant in 1827. After serving in the Rhine provinces, he joined the topographical division of the general staff in 1846. As lieutenant of the 31st foot he took part in 1848 in the suppression of the Berlin riots, and in 1849 was promoted captain on the general staff. The same year he served on the staff of General von Bonin in the Schleswig-Holstein campaign, and so distinguished himself, particularly at Fredericia, that he was appointed chief of the staff of the Schleswig-Holstein army. In 1850 he was general staff officer of the mobile division under von Tietzen in Hesse-Cassel. He was sent on a mission to England in that year (4th class of Red Eagle), and on several subsequent occasions. Having attained the rank of lieutenant-colonel, he was appointed personal adjutant to Prince Frederick Charles in 1850. In 1860 he became colonel of the 31st, and later of the 71st, regiment. He was chief of the staff of the III. army corps when,

on the outbreak of the Danish War of 1864, he was nominated chief of the general staff of the army against Denmark, and displayed so much ability, particularly at Düppel and the passage to Alsen island, that he was promoted major-general and given the order *pour le mérite*. In the war of 1866 Blumenthal occupied the post of chief of the general staff to the crown prince of Prussia, commanding the 2nd army. It was upon this army that the brunt of the fighting fell, and at Königgrätz it decided the fortunes of the day. Blumenthal's own part in these battles and in the campaign generally was most conspicuous. On the field of Königgrätz the crown prince said to his chief of staff, "I know to whom I owe the conduct of my army," and Blumenthal soon received promotion to lieutenant-general and the oak-leaf of the order *pour le mérite*. He was also made a knight of the Hohenzollern Order. From 1866 to 1870 he commanded the 14th division at Düsseldorf. In the Franco-German War of 1870-71 he was chief of staff of the 3rd army under the crown prince. Blumenthal's soldierly qualities and talent were never more conspicuous than in the critical days preceding the battle of Sedan, and his services in the war have been considered as scarcely less valuable and important than those of Moltke himself. In 1871 Blumenthal represented Germany at the British manoeuvres at Chobham, and was given the command of the IV. army corps at Magdeburg. In 1873 he became a general of infantry, and ten years later he was made a count. In 1888 he was made a general field marshal, after which he was in command of the 4th and 3rd army inspections. He retired in 1896, and died at Quellendorf near Köthen on the 21st of December 1900.

Blumenthal's diary of 1866 and 1870-1871 has been edited by his son, Count Albrecht von Blumenthal (*Tagebuch des G. F. M. von Blumenthal*, 1902; an English translation (*Journals of Count von Blumenthal*) was published in 1903).

BLUNDERBUSS (a corruption of the Dutch *donder*, thunder, and the Dutch *bus*; cf. Ger. *Büchse*, a box or tube, hence a thunder-box or gun), an obsolete muzzle-loading firearm with a bell-shaped muzzle. Its calibre was large so that it could contain many balls or slugs, and it was intended to be fired at a short range, so that some of the charge was sure to take effect. The word is also used by analogy to describe a blundering and random person or talker.

BLUNT, JOHN HENRY (1823-1884), English divine, was born at Chelsea in 1823, and before going to the university of Durham in 1850 was for some years engaged in business as a manufacturing chemist. He was ordained in 1852 and took his M.A. degree in 1855, publishing in the same year a work on *The Atonement*. He held in succession several preferments, among them the vicarage of Kennington near Oxford (1868), which he vacated in 1873 for the crown living of Beverston in Gloucestershire. He had already gained some reputation as an industrious theologian, and had published among other works an annotated edition of the Prayer Book (1867), a *History of the English Reformation* (1868), and a *Book of Church Law* (1872), as well as a useful *Dictionary of Doctrinal and Historical Theology* (1870). The continuation of these labours was seen in a *Dictionary of Sects and Heresies* (1874), an *Annotated Bible* (3 vols., 1878-1879), and a *Cyclopaedia of Religion* (1884), and received recognition in the shape of the D.D. degree bestowed on him in 1882. He died in London on the 11th of April 1884.

BLUNT, JOHN JAMES (1794-1855), English divine, was born at Newcastle-under-Lyme in Staffordshire, and educated at St John's College, Cambridge, where he took his degree as fifteenth wrangler and obtained a fellowship (1816). He was appointed a Wort's travelling bachelor 1818, and spent some time in Italy and Sicily, afterwards publishing an account of his journey. He proceeded M.A. in 1819, B.D. 1826, and was Hulsean Lecturer in 1831-1832 while holding a curacy in Shropshire. In 1834 he became rector of Great Oakley in Essex, and in 1839 was appointed Lady Margaret professor of divinity at Cambridge. In 1854 he declined the see of Salisbury, and he died on the 18th of June 1855. His chief book was *Undesigned Coincidences in the Writings both of the Old and New Testaments*

(1833; fuller edition, 1847). Some of his writings, among them the *History of the Christian Church during the First Three Centuries* and the lectures *On the Right Use of the Early Fathers*, were published posthumously.

A short memoir of him appeared in 1856 from the hand of William Selwyn, his successor in the divinity professorship.

BLUNT, WILFRID SCAWEN (1840—), English poet and publicist, was born on the 17th of August 1840 at Petworth House, Sussex, the son of Francis Scawen Blunt, who served in the Peninsular War and was wounded at Corunna. He was educated at Stonyhurst and Oscott, and entered the diplomatic service in 1858, serving successively at Athens, Madrid, Paris and Lisbon. In 1867 he was sent to South America, and on his return to England retired from the service on his marriage with Lady Anne Noel, daughter of the earl of Lovelace and a granddaughter of the poet Byron. In 1872 he succeeded, by the death of his elder brother, to the estate of Crabtree Park, Sussex, where he established a famous stud for the breeding of Arab horses. Mr and Lady Anne Blunt travelled repeatedly in northern Africa, Asia Minor and Arabia, two of their expeditions being described in *Lady Anne's Bedouins of the Euphrates* (2 vols., 1879) and *A Pilgrimage to Mejd* (2 vols., 1881). Mr Blunt became known as an ardent sympathizer with Mahomedan aspirations, and in his *Future of Islam* (1888) he directed attention to the forces which afterwards produced the movements of Pan-Islamism and Mahdism. He was a violent opponent of the English policy in the Sudan, and in *The Wind and the Whirlwind* (in verse, 1883) prophesied its downfall. He supported the national party in Egypt, and took a prominent part in the defence of Arabi Pasha. *Ideas about India* (1885) was the result of two visits to that country, the second in 1883-1884. In 1885 and 1886 he stood unsuccessfully for parliament as a Home Ruler; and in 1887 he was arrested in Ireland while presiding over a political meeting in connexion with the agitation on Lord Clanricarde's estate, and was imprisoned for two months in Kilmainham. His best-known volume of verse, *Love Sonnets of Protesus* (1880), is a revelation of his real merits as an emotional poet. *The Poetry of Wilfrid Blunt* (1888), selected and edited by W. E. Henley and Mr. George Wyndham, includes these sonnets, together with "Worth Forest, a Pastoral," "Griselda" (described as a "society novel in rhymed verse"), translations from the Arabic, and poems which had appeared in other volumes.

BLUNTSCHLI, JOHANN KASPAR (1808-1881), Swiss jurist and politician, was born at Zürich on the 7th of March 1808, the son of a soap and candle manufacturer. From school he passed into the *Politische Institut* (a seminary of law and political science) in his native town, and proceeding thence to the universities of Berlin and Bonn, took the degree of *doctor juris* in the latter in 1830. Returning to Zürich in 1830, he threw himself with ardour into the political strife which was at the time unsettling all the cantons of the Confederation, and in this year published *Über die Verfassung der Stadt Zürich* (On the Constitution of the City of Zürich). This was followed by *Das Volk und der Sonnenstein* (1830), a work in which, while pleading for constitutional government, he showed his bitter repugnance of the growing Swiss radicalism. Elected in 1837 a member of the *Grosser Rath* (Great Council), he became the champion of the moderate conservative party. Fascinated by the metaphysical views of the philosopher Friedrich Rohrer (1814-1856), a man who attracted little other attention, he endeavoured in *Psychologische Studien über Staat und Kirche* (1844) to apply them to political science generally, and in particular as a panacea for the constitutional troubles of Switzerland. Bluntschli, shortly before his death, remarked, "I have gained renown as a jurist, but my greatest desert is to have comprehended Rohrer." This philosophical essay, however, coupled with his uncompromising attitude towards both radicalism and ultramontanism, brought him many enemies, and rendered his continuance in the council, of which he had been elected president, impossible. He resigned his seat, and on the overthrow of the *Sonderbund* in 1847, perceiving that all hope of power for his party was lost, took leave of Switzerland with the pamphlet *Stimme eines Schweizerers*

über die Bundesreform (1847), and settled at Munich, where he became professor of constitutional law in 1848.

At Munich he devoted himself with energy to the special work of his chair, and, resisting the temptation to identify himself with politics, published *Allgemeines Staatsrecht* (1851-1852); *Lehre vom modernen Staat* (1855-1876); and, in conjunction with Karl Ludwig Theodor Brater (1819-1866), *Deutsches Staatswörterbuch* (11 vols., 1857-1879; abridged by Edgar Loening in 3 vols., 1869-1875). Meanwhile he had assiduously worked at his code for the canton of Zürich, *Privatrechtliches Gesetzbuch für den Kanton Zürich* (4 vols., 1854-1856), a work which was much praised at the time, and which, particularly the section devoted to contracts, served as a model for codes both in Switzerland and other countries. In 1861 Bluntschli received a call to Heidelberg as professor of constitutional law (*Staatsrecht*), where he again entered the political arena, endeavouring in his *Geschichte des allgemeinen Staatsrechts und der Politik* (1864) "to stimulate," as he said, "the political consciousness of the German people, to cleanse it of prejudices and to further it intellectually." In his new home, Baden, he devoted his energies and political influence, during the Austro-Prussian War of 1866, towards keeping the country neutral. From this time Bluntschli became active in the field of international law, and his fame as a jurist belongs rather to this province than to that of constitutional law. His *Das moderne Kriegrecht* (1866); *Das moderne Völkerrecht* (1868), and *Das Beulrecht im Krieg* (1878) are likely to remain invaluable text-books in this branch of the science of jurisprudence. He also wrote a pamphlet on the "Alabama" case.

Bluntschli was one of the founders, at Ghent in 1873, of the Institute of International Law, and was the representative of the German emperor at the conference on the international laws of war at Brussels. During the latter years of his life he took a lively interest in the *Protestantenverein*, a society formed to combat reactionary and ultramontane views of theology. He died suddenly at Karlsruhe on the 21st of October 1881. His library was acquired by Johns Hopkins University at Baltimore, U.S.A.

Among his works, other than those before mentioned, may be cited *Deutsches Privatrecht* (1853-1854); *Deutsche Staatslehre für Gebildete* (1874); and *Deutsche Staatslehre und die heutige Staatenwelt* (1880).

For notices of Bluntschli's life and works see his interesting autobiography, *Denkwürdiges aus meinem Leben* (1884); von Holtzendorff, *Bluntschli und seine Verdienste um die Staatswissenschaften* (1882); Brockhaus, *Konversations-Lexicon* (1901); and a biography by Meyer von Kronau, in *Allgemeine deutsche Biographie*.

BLYTH, a market town and seaport of Northumberland, England, in the parliamentary borough of Morpeth, 9 m. E.S.E. of that town, at the mouth of the river Blyth, on a branch of the North Eastern railway. Pop. of urban district (1901) 5472. This is the port for a considerable coal-mining district, and its harbour, on the south side of the river, is provided with mechanical appliances for shipping coal. There are five dry docks, and upwards of 1½ m. of quays. Timber is largely imported. Some shipbuilding and the manufacture of rope, sails and ship-fittings are carried on, and the fisheries are valuable. Blyth is also in considerable favour as a watering-place; there are a pleasant park, a pier, protecting the harbour, about 1 m. in length, and a sandy beach affording sea-bathing. The river Blyth rises near the village of Kirkheaton, and has an easterly course of about 25 m. through a deep, well-wooded and picturesque valley.

B'NAI B'RITH (OR SONS OF THE COVENANT), **INDEPENDENT ORDER OF**, a Jewish fraternal society. It was founded at New York in 1843 by a number of German Jews, headed by Henry Jones, and is the oldest as well as the largest of the Jewish fraternal organizations. Its membership in 1908 was 35,870, its 481 lodges and 10 grand lodges being distributed over the United States, Germany, Austria-Hungary, Rumania, Egypt and Palestine. Its objects are to promote a high morality among Jews, regardless of differences as to dogma and ceremonial customs, and especially to inculcate the supreme virtues of

charity and brotherly love. Political and religious discussions were from the first excluded from the debates of the order. In 1851 the first grand lodge was established at New York; in 1856, the number of district lodges having increased, the supreme authority was vested in a central body consisting of one member from each lodge; and by the present constitution, adopted in 1868, this authority is vested in a president elected for five years, an executive committee and court of appeals (elected as before). The first lodge in Germany was instituted at Berlin in 1883. A large number of charitable and other public institutions have been established in the United States and elsewhere by the order, of which may be mentioned the large orphan asylum in Cleveland, the home for the aged and infirm at Yonkers, N.Y., the National Jewish hospital for consumptives at Denver, and the Maimonides library in New York City. The B'nai B'rith society has also co-operated largely with other Jewish philanthropic organizations in succouring distressed Israelites throughout the world.

See the *Jewish Encyclopedia* (1902), s.v.

BOA, a name formerly applied to all large serpents which, devoid of poison fangs, kill their prey by constriction; but now confined to that subfamily of the *Boidae* which are devoid of teeth in the premaxilla and are without supraorbital bones. The others are known as pythons (*q.v.*). The true boas comprise some forty species; most of them are American, but the genus *Eryx* inhabits North Africa, Greece and south-western Asia; the genus *Enygrus* ranges from New Guinea to the Fiji; *Casarea dussumieri* is restricted to Round Island, near Mauritius; and two species of *Boa* and one of *Corallus* represent this subfamily in Madagascar, while all the other boas live in America, chiefly in tropical parts. All *Boidae* possess vestiges of pelvis and hind limbs, appearing externally as claw-like spurs on each side of the vent, but they are so small that they are practically without function in climbing. The usually short tail is prehensile.

One of the commonest species of the genus *Boa* is the *Boa constrictor*, which has a wide range from tropical Mexico to Brazil. The head is covered with small scales, only one of the preoculars being enlarged. The general colour is a delicate pale brown, with about a dozen and a half darker cross-bars, which are often connected by a still darker dorso-lateral streak, enclosing large oval spots. On each side is a series of large dark brown spots with light centres. On the tail the markings become bolder, brick red with black and yellow. The under parts are yellowish with black dots. This species rarely reaches a length of more than 10 ft. It climbs well, prefers open forest in the neighbourhood of water, is often found in plantations where it retires into a hole in the ground, and lives chiefly on birds and small mammals. Like most true boas, it is of a very gentle disposition and easily domesticates itself in the palm or reed thatched huts of the natives, where it hunts the rats during the night.

The term "boa" is applied by analogy to a long article of women's dress wound round the neck.

BOABDIL (a corruption of the name Abu Abdullah), the last Moorish king of Granada, called *el chico*, the little, and also *el zogybi*, the unfortunate. A son of Muley Abu'l Hassan, king of Granada, he was proclaimed king in 1482 in place of his father, who was driven from the land. Boabdil soon after sought to gain prestige by invading Castile. He was taken prisoner at Lucena in 1483, and only obtained his freedom by consenting to hold Granada as a tributary kingdom under Ferdinand and Isabella, king and queen of Castile and Aragon. The next few years were consumed in struggles with his father and his uncle Abdullah ez Zagal. In 1491 Boabdil was summoned by Ferdinand and Isabella to surrender the city of Granada, and on his refusal it was besieged by the Castilians. Eventually, in January 1492, Granada was surrendered, and the king spent some time on the lands which he was allowed to hold in Andalusia. Subsequently he crossed to Africa, and is said to have been killed in battle fighting for his kinsman, the ruler of Fez. The spot from which Boabdil looked for the last time on Granada is still shown, and is known as "the last sigh of the Moor" (*el ultimo suspiro del Moro*).

See J. A. Conde, *Domineio de los Arabes en España* (Paris, 1840), translated into English by Mrs J. Foster (London, 1854-1855); Washington Irving, *The Alhambra* (New York, ed. 1880).

BOADICEA, strictly *BOUDICCA*, a British queen in the time of the emperor Nero. Her husband Prasutagus ruled the Iceni (in what is now Norfolk) as an autonomous prince under Roman suzerainty. On his death (A.D. 61) without male heir, his dominions were annexed, and the annexation was carried out brutally. He had by his will divided his private wealth between his two daughters and Nero, trusting thereby to win imperial favour for his family. Instead, his wife was scourged (doubtless for resisting the annexation), his daughters outraged, his chief tribesmen plundered. The proud, fierce queen and her people rose, and not alone. With them rose half Britain, enraged, for other causes, at Roman rule. Roman taxation and conscription lay heavy on the province; in addition, the Roman government had just revoked financial concessions made a few years earlier, and L. Annaeus Seneca, who combined the parts of a moralist and a money-lender, had abruptly recalled large loans made from his private wealth to British chiefs. A favourable chance for revolt was provided by the absence of the governor-general, Suetonius Paulinus, and most of his troops in North Wales and Anglesey. All south-east Britain joined the movement. Paulinus rushed back without waiting for his troops, but he could do nothing alone. The Britons burnt the Roman municipalities of Verulam and Colchester, the mart of London, and several military posts, massacred "over 70,000" Romans and Britons friendly to Rome, and almost annihilated the Ninth Legion marching from Lincoln to the rescue. At last Paulinus, who seems to have rejoined his army, met the Britons in the field. The site of the battle is unknown. One writer has put it at Chester; others at London, where King's Cross had once a narrow escape of being christened Boadicea's Cross, and actually for many years bore the name of Battle Bridge, in supposed reference to this battle. Probably, however, it was on Watling Street, between London and Chester. In a desperate soldiers' battle Rome regained the province. Boadicea took poison; thousands of Britons fell in the fight or were hunted down in the ensuing guerrilla. Finally, Rome adopted a kinder policy, and Britain became quiet. But the scantiness of Romano-British remains in Norfolk may be due to the severity with which the Iceni were crushed.

See Tacitus, *Annals*, xiv.; *Agric.* xv.; Dio lxxii. The name Boadicea seems to mean in Celtic much the same as Victoria. (F. J. H.)

BOAR (O. Eng. *bær*; the word is found only in W. Ger. languages, cf. Dutch *beer*, Ger. *Eber*), the name given to the uncastrated male of the domestic pig (*q.v.*), and to some wild species of the family *Suidae* (see *SWINE*). The European wild boar (*Sus scrofa*) is distributed over Europe, northern Africa, and central and northern Asia. It has long been extinct in the British Isles, where it once abounded, but traces have been found of its survival in Chartley Forest, Staffordshire, in an entry of 1683 in an account-book of the steward of the manor, and it possibly remained till much later in the more remote parts of Scotland and Ireland (J. E. Harting, *Extinct British Animals*, 1880). The wild boar is still found in Europe, in marshy woodland districts where there is plenty of cover, and it is fairly plentiful in Spain, Austria, Russia and Germany, particularly in the Black Forest.

From the earliest times, owing to its great strength, speed, and ferocity when at bay, the boar has been one of the favourite beasts of the chase. Under the old forest laws of England it was one of the "beasts of the forest," and, as such, under the Norman kings the unprivileged killing of it was punishable by death or the loss of a member. It was hunted in England and in Europe on foot and on horseback with dogs, while the weapon of attack was always the spear. In Europe the wild boar is still hunted with dogs, but the spear, except when used in emergencies and for giving the *coup de grâce*, has been given up for the gun. It is also shot in great forest drives in Austria, Germany and Russia. The Indian wild boar (*Sus cristatus*) is slightly taller than *Sus scrofa*, standing some 30 to 40 in. at the shoulder. It

is found throughout India, Ceylon and Burma. Here the horse and spear are still used, and the sport is one of the most popular in India. (See FIG-STICKING.)

The boar is one of the four heraldic beasts of venery, and was the cognizance of Richard III., king of England. As an article of food the boar's head was long considered a special delicacy, and its serving was attended with much ceremonial. At Queen's College, Oxford, the dish is still brought on Christmas day in procession to the high-table, accompanied by the singing of a carol.

BOARD (O. Eng. *borð*), a plank or long narrow piece of timber. The word comes into various compounds to describe boards used for special purposes, or objects like boards (drawing-board, ironing-board, sounding-board, chess-board, cardboard, back-board, notice-board, scoring-board). The phrase "to keep one's name on the boards," at Cambridge University, signifies to remain a member of a college; at Oxford it is "on the books." In bookbinding, pasteboard covers are called boards. Board was early used of a table, hence such phrases as "bed and board," "board and lodging"; or of a gaming-table, as in the phrase "to sweep the board," meaning to pocket all the stakes, hence, figuratively, to carry all before one. The same meaning leads to "Board of Trade," "Local Government Board," &c.

From the meaning of border or side, and especially ship's side, comes "sea-board," meaning sea-coast, and the phrases "aboard" (Fr. *abord*), "over-board," "by the board"; similarly "weather-board," the side of a ship which is to windward; "larboard and starboard" (the former of uncertain origin, Mid. Eng. *laddelbord* or *lathelbord*; the latter meaning "steering side," O. Eng. *steorbord*, the rudder of early ships working over the steering side), signifying (to one standing at the stern and looking forward) the left and right sides of the ship respectively.

BOARDING-HOUSE, a private house in which the proprietor provides board and lodging for paying guests. The position of a guest in a boarding-house differs in English law, to some extent, on the one hand from that of a lodger in the ordinary sense of the term, and on the other from that of a guest in an inn. Unlike the lodger, he frequently has not the exclusive occupation of particular rooms. Unlike the guest in an inn, his landlord has no lien upon his property for rent or any other debt due in respect of his board (*Thompson v. Lacy*, 1820, 3 B. and Ald. 283). The landlord is under an obligation to take reasonable care for the safety of property brought by a guest into his house, and is liable for damages in case of breach of this obligation (*Scarborough v. Cosgrove*, 1905, 2 K.B. 803). Again, unlike the innkeeper, a boarding-house keeper does not hold himself out as ready to receive all travellers for whom he has accommodation, for which they are ready to pay, and of course he is entitled to get rid of any guest on giving reasonable notice (see *Lamond v. Richard*, 1897, 1 Q.B. 541, 548). What is reasonable notice depends on the terms of the contract; and, subject thereto, the course of payment of rent is a material circumstance (see **LANDLORD AND TENANT**). Apparently the same implied warranty of fitness for habitation at the commencement of the tenancy which exists in the case of furnished lodgings (see **LODGER AND LODGINGS**) exists also in the case of boarding-houses; and the guest in a boarding-house, like a lodger, is entitled to all the usual and necessary conveniences of a dwelling-house.

The law of the United States is similar to English law.

Under the French Code Civil, claims for subsistence furnished to a debtor and his family during the last year of his life by boarding-house keepers (*maitres de pension*) are privileged over the generality of moveables, the privilege being exerciseable after legal expenses, funeral expenses, the expenses of the last illness, and the wages of servants for the year elapsed and what is due for the current year (art. 2101 (5)). Keepers of taverns (*aubergistes*) and hotels (*hôtelliers*) are responsible for the goods of their guests—the committal of which to their custody is regarded as a deposit of necessity (*dépot nécessaire*). They are

liable for the loss of such goods by theft, whether by servants or strangers, but not where the loss is due to *force majeure* (arts. 1952-1954). Their liability for money and bearer securities not actually deposited is limited to 1000 francs (law of 18th of April 1880). These provisions are reproduced in substance in the Civil Codes of Quebec (arts. 1814, 1815, 1904, 2006) and of St Lucia (art. 1880). In Quebec, boarding-house keepers have a lien on the goods of their guests for the value or price of any food or accommodation furnished to them, and have also a right to sell their baggage and other property, if the amount remains unpaid for three months, under conditions similar to those imposed on innkeepers in England (art. 1816 A; and see **INNS AND INNKEEPERS**); also in the Civil Code of St Lucia (arts. 1578, 1714, 1715). (A. W. R.)

BOARDING-OUT SYSTEM, in the English poor law, the boarding-out of orphan or deserted children with suitable foster-parents. The practice was first authorized in 1868, though for many years previously it had been carried out by some boards of guardians on their own initiative. Boarding-out is governed by two orders of the Local Government Board, issued in 1889. The first permits guardians to board-out children within their own union, except in the metropolis. The second governs the boarding-out of children in localities outside the union. The sum payable to the foster-parents is not to exceed 4s. per week for each child. The system has been much discussed by authorities on the administration of the poor law. It has been objected that few working-men with an average-sized family can afford to devote such an amount for the maintenance of each child, and that, therefore, boarded-out children are better off than the children of the independent (Fawcett, *Pauperism*). Working-class guardians, also, do not favour the system, being suspicious as to the disinterestedness of the foster-parents. On the other hand, it is argued that from the economic and educational point of view much better results are obtained by boarding-out children; they are given a natural life, and when they grow up they are without effort merged in the general population (Mackay, *Hist. Eng. Poor Law*). See also **POOR LAW**.

The "boarding-out" of lunatics is, in Scotland, a regular part of the lunacy administration. It has also been successfully adopted in Belgium. (See **INSANITY**.)

BOARDMAN, GEORGE DANA (1801-1831), American Baptist missionary, was born at Livermore, Me., and educated at Waterville College and Andover Theological Seminary. In 1825 he went to India as a missionary, and in 1827 to Burma, where his promising work among the Karens was cut short by his early death. His widow married another well-known Burmese missionary, Adoniram Judson.

His son, **GEORGE DANA BOARDMAN**, the younger (1828-1903), made the voyage from Burma to America alone when six years of age. He graduated in 1852 at Brown University, and from the Newton Theological Institution in 1855. He held Baptist pastorates at Rochester (1856-1864), and at Philadelphia, and was president of the American Baptist Missionary Union, 1880-1884. At Philadelphia he is said to have taken his congregation through every verse of the New Testament in 643 Wednesday evening lectures, which occupied nearly eighteen years, and afterwards to have begun on the Old Testament in similar fashion. Among his published works are *Studies in the Model Prayer* (1879), and *Epiphanies of the Risen Lord* (1879).

BOASE, HENRY SAMUEL (1799-1883), English geologist, the eldest son of Henry Boase (1763-1827), banker, of Madron, Cornwall, was born in London on the 2nd of September 1799. Educated partly at Tiverton grammar-school, and partly at Dublin, where he studied chemistry, he afterwards proceeded to Edinburgh and took the degree of M.D. in 1821. He then settled for some years as a medical practitioner at Penzance; there geology engaged his particular attention, and he became secretary of the Royal Geological Society of Cornwall. The results of his observations were embodied in his *Treatise on Primary Geology* (1834), a work of considerable merit in regard to the older crystalline and igneous rocks and the subject of

mineral veins. In 1837 he removed to London, where he remained for about a year, being elected F.R.S. In 1838 he became partner in a firm of bleachers at Dundee. He retired in 1871, and died on the 5th of May 1883.

BOAT (O. Eng. *bāt*; the true etymological connexion with Dutch and Ger. *boot*; Fr. *bateau*, Ital. *battello* presents great difficulties; Celtic forms are from O. Eng.), a comparatively small open craft for conveyance on water, usually propelled by some form of oar or sail.

The origin of the word "boat" is probably to be looked for in the A.S. *bāt*=a stem, a stick, a piece of wood. If this be so, the term in its inception referred to the material of which the primitive vessel was constructed, and in this respect may well be contrasted with the word "ship," of which the primary idea was the *process* by which the material was fashioned and adapted for the use of man.

We may assume that primitive man, in his earliest efforts to achieve the feat of conveying himself and his belongings by water, succeeded in doing so—(1) by fastening together a quantity of material of sufficient buoyancy to float and carry him above the level of the water; (2) by scooping out a fallen tree so as to obtain buoyancy enough for the same purpose. In these two processes is to be found the genesis of both boat and ship, of which, though often used as convertible terms, the former is generally restricted to the smaller type of vessel such as is dealt with in this article. For the larger type the reader is referred to SHIP.

Great must have been the triumph of the man who first discovered that the rushes or the trunks he had managed to tie together would, propelled by a stick or a branch (cf. *remus* and *remus*) used as pole or paddle, convey him safely across the river or lake, which had hitherto been his barrier. But use multiplies wants, discovers deficiencies, suggests improvements. Man soon found out that he wanted to go faster than the raft would move, that the water washed over and up through it, and this need of speed, and of dry carrying power, which we find operative throughout the history of the boat down to the present day, drove him to devise other modes of flotation as well as to try to improve his first invention.

The invention of the hollowed trunk, of the "dug-out" (monoxylon), however it came about, whenever and wherever it came into comparison with the raft, must have superseded the latter for some purposes, though not by any means for all. It was superior to the raft in speed, and was, to a certain extent, water-tight. On the other hand it was inferior in carrying power and stability. But the two types once conceived had come to stay, and to them severally, or to attempts to combine the useful properties of both, may be traced all the varieties of vessel to which the name of boat may be applied.

The development of the raft is admirably illustrated in the description, given us by Homer in the *Odyssey*, of the construction by the hero Ulysses of a vessel of the kind. Floating timber is cut down and carefully shaped and planed with axe and adze, and the timbers are then exactly fitted face to face and compacted with trenails and dowels, just as the flat floor of a lump or lighter might be fashioned and fitted nowadays. A platform is raised upon the floor and a bulwark of osiers contrived to keep out the wash of the waves (cf. *infra*, Malay boats). It seems as if the poet, who was intimately acquainted with the sea ways of his time, intended to convey the idea of progress in construction, as illustrated by the technical skill of his hero, and the use of the various tools with which he supplies him.

On the other hand the dug-out had its limitations. The largest tree that could be thrown and scooped out afforded but a narrow space for carrying goods, and presented problems as to stability which must have been very difficult to solve. The shaping of bow and stern, the bulging out of the sides, the flattening of the bottom, the invention of a keel piece, the attempt to raise the sides by building up with planks, all led on towards the idea of constructing a boat properly so called, or perhaps to the invention of the canoe, which in some ways may be regarded as the intermediate stage between dug-out and boat.

Meanwhile the raft had undergone improvements such as those which Homer indicates. It had arrived at a floor composed of timbers squared and shaped. It had risen to a platform, the prototype of a deck. It was but a step to build up the sides and turn up the ends, and at this point we reach the genesis of ark and punt, of sanpan and junk, or, in other words, of all the many varieties of flat-bottomed craft.

When once we have reached the point at which the improvements in the construction of the raft and dug-out bring them, as it were, within sight of each other, we can enter upon the history of the development of boats properly so called, which, in accordance with the uses and the circumstances that dictated their build, may be said to be descended from the raft or the dug-out, or from the attempt to combine the respective advantages of the two original types.

Uses and circumstances are infinite in variety and have produced an infinite variety of boats. But we may safely say that in all cases the need to be satisfied, the nature of the material available, and the character of the difficulties to be overcome have governed the reason and tested the reasonableness of the architecture of the craft in use.

It is not proposed in this article to enter at any length into the details of the construction of boats, but it is desirable, for the sake of clearness, to indicate certain broad distinctions in the method of building, which, though they run back into the far past, in some form or other survive and are in use at the present day.

The tying of trunks together to form a raft is still not unknown in the lumber trade of the Danube or of North America, nor was it in early days confined to the raft. It extended to many boats properly so called, even to many of those built by the Vikings of old. It may still be seen in the Madras surf boats, and in those constructed out of driftwood by the inhabitants of Easter Island in the south Pacific. Virgil, who was an archaeologist, represents Charon's boat on the Styx as of this construction, and notes the defect, which still survives, in the craft of the kind when loaded—

"Gemit sub pondere cymba
Sutilla, et multam accipit rimosa paludem"
Aen. vi. 303.

Next to the raft, and to be counted in direct descent from it, comes the whole class of flat-bottomed boats including punts and lighters. As soon as the method of constructing a solid floor, with trenails and dowels, had been discovered, the method of converting it into a water-tight box was pursued, sides were attached plank fashion, with strong knees to stiffen them, and cross pieces to *yoke* or *key* (cf. *ἵβρον, κλῆίς*) them together. These thwarts once fixed naturally suggested seats for those that plied the paddle or the oar. The ends of the vessel were shaped into bow or stern, either turned up, or with the side planking convergent in stem or stern post, or joined together fore and aft by bulkheads fitted in, while interstices were made water-tight by caulking, and by smearing with bitumen or some resinous material.

The evolution of the boat as distinct from the punt, or flat-bottomed type, and following the configuration of the dug-out in its length and rounded bottom, must have taxed the inventive art and skill of constructors much more severely than that of the raft. It is possible that the coracle or the canoe may have suggested the construction of a framework of sufficient stiffness to carry a water-tight wooden skin, such as would successfully resist the pressure of wind and water. And in this regard two methods were open to the builder, both of which have survived to the present day: (1) the construction first of the shell of the boat, into which the stiffening ribs and cross ties were subsequently fitted; (2) the construction first of a framework of requisite size and shape, on to which the outer skin of the boat was subsequently attached.

Further, besides the primitive mode of tying the parts together, two main types of build must be noticed, in accordance with which a boat is said to be either carvel-built or

clinker-built. (1) A boat is carvel-built when the planks are laid edge to edge so that they present a smooth surface without. (2) A boat is clinker-built when each plank is laid on so as to overlap the one below it, thus presenting a series of ledges running longitudinally.

The former method is said to be of Mediterranean, or perhaps of Eastern origin. The latter was probably invented by the old Scandinavian builders, and from them handed down through the fishing boats of the northern nations to our own time.

The accounts of vessels used by the Egyptians and Phoenicians generally refer to larger craft which naturally fall under the head of *SHIP* (q.v.). The Nile boats, however, described by Herodotus (ii. 60), built of acacia wood, were no doubt of various sizes, some of them quite small, but all following the same type of construction, built up brick fashion, the blocks being fastened internally to long poles secured by cross pieces, and the interstices caulked with papyrus. The ends rose high above the water, and to prevent hogging were often attached by a truss running longitudinally over crutches from stem to stern.

The Assyrian and Babylonian vessels described by Herodotus (i. 194), built up of twigs and boughs, and covered with skins smeared with bitumen, were really more like huge coracles and hardly deserve the name of boats.

The use of boats by the Greeks and Romans is attested by the frequent reference to them in Greek and Latin literature, though, as regards such small craft, the details given are hardly enough to form the basis of an accurate classification.

We hear of small boats attendant on a fleet (*καλέριον*, Thuc. i. 53), and of similar craft employed in piracy (Thuc. iv. 9), and in one case of a sculling boat, or pair oar (*ἀκέρων ἀμφουδόν*, Thuc. iv. 67), which was carted up and down between the town of Megara and the sea, being used for the purpose of marauding at night. We are also familiar with the passage in the Acts (xvii.) where in the storm they had hard work "to come by the boat"; which same boat the sailors afterwards "let down into the sea, under colour as though they would have cast anchors out of the foreship," and would have escaped to land in her themselves, leaving the passengers to drown, if the centurion and soldiers acting upon St Paul's advice had not cut off the ropes of the boat and let her fall off.

There can be little doubt that boat races were in vogue among the Greeks (see Prof. Gardner, *Journal of Hellenic Studies*, ii. 91 ff.), and probably formed part of the Panathenaic and Isthmian festivals. It is, however, difficult to prove that small boats took part in these races, though it is not unlikely that they may have done so. The testimony of the coins, such as it is, points to galleys, and the descriptive term (*πλοῖον ἀμιλλόν*) leads to the same conclusion.

It is hardly possible now to define the differences which separated *ἀκέρων*, *ἀκέρων*, from *αἰλας*, *καλέριον*, or from *λίβητος*, or *σπυρίδιον*. They seem all to have been rowing boats, probably carvel-built, some with keels (*ακασιῶν μοδῶν καρισσῶν*, Plin. ix. 19), and to have varied in size, some being simply sculling boats, and others running up to as many as thirty oars.

Similarly in Latin authors we have frequent mention of boats accompanying ships of war. Of this there is a well-known instance in the account of Caesar's invasion of Britain (*B.C.* iv. 26), when the boats of the fleet, and the pinnaces, were filled with soldiers and sent to assist the Legionaries who were being fiercely attacked as they waded on to the shore. There is also an instance in the civil war, which is a prototype of a modern attack of torpedo boats upon men of war, when Antonius manned the pinnaces of his large ships to the number of sixty, and with them attacked and defeated an imprudent squadron of Quadrantines (*B.C.* iii. 24). The class of boats so frequently mentioned as *acastivæ* seems to have contained craft of all sizes, and to have been used for all purposes, whether as pleasure boats or as dispatch vessels, or for piracy. In fact the term was employed vaguely just as we speak of craft in general.

The *lembus*, which is often referred to in Livy and Polybius, seems to have been of Illyrian origin, with fine lines and sharp bows. The class contained boats of various sizes, and with a variable number of oars (biremis, Livy xxiv. 40, sexdecim, Livy xxxiv. 35); and it is interesting to note the origin in this case, as the invention of the light Liburnian galleys, which won the battle of Actium, and altered the whole system of naval construction, came from the same seaboard.

Besides these, the piratical *στυγοπαρονες* (see *Cic. In Verrem*), and the poetical *phaselus*, deserve mention, but here again we are met with the difficulty of distinguishing boats from ships. There is also an interesting notice in Tacitus (*Hist.* iii. 47) of boats hastily constructed by the natives of the northern coast of Asia Minor, which he describes as of broad beam with narrow sides (probably meaning that the sides "tumbled home"), joined together without any fastenings of brass or iron. In a sea-way the sides were raised with planks added till they were cased in as with a roof, whence their name *casaræ*, and so they rolled about in the waves, having prow and stern alike and convertible rowlocks, so that it was a matter of indifference and equally safe, or perhaps unsafe, whichever way they rowed.

Similar vessels were constructed by Germanicus in his north German campaign (*Ann.* ii. 6) and by the Suiones (*Ger.* 44). These also had stern and stern alike, and remind us of the old Norse construction, being rowed either way, having the oars loose in the rowlock, and not, as was usual in the south, attached by a thong to the thowl pin.

Lastly, as a class of boat directly descended from the raft, we may notice the flat-bottomed boats or punts or lighters which plied on the Tiber as ferry-boats, or carrying goods, which were called *codicariæ* from *condes*, the old word for a plank.

It is difficult to trace any order of development in the construction of boats during the Byzantine period, or the middle ages. Sea-going vessels according to their size carried one or more boats, some of them small boats with two or four oars, others boats of a larger size fitted with masts and sail as well as with oars. We find *lembus* and *phaselus* as generic names in the earlier period, but the indications as to size and character are vague and variable. The same may be said of the *batelli*, *coquets*, *chaloupes*, *chalans*, *galkes*, &c., of which, in almost endless number and variety, the nautical erudition of M. Jal has collected the names in his monumental works, *Archivologie navale* and the *Glossaire nautique*.

It is clear, however, that in many instances the names, originally applied to boats properly so called, gradually attached themselves to larger vessels, as in the case of *chaloupe* and others, a fact which leads to the conclusion that the type of build followed originally in smaller vessels was often developed on a larger scale, according as it was found useful and convenient, while the name remained the same. Many of these types still survive and may be found in the Eastern seas, or in the Mediterranean or in the northern waters, each of which has its own peculiarities of build and rig.

It would be impossible within our limits to do justice to the number and variety of existing types in sea-going boats, and for more detailed information concerning them the reader would do well to consult *Mast and Sail in Europe and Asia*, by H. Warington Smyth, an excellent and exhaustive work, from which much of the information which follows regarding them has been derived.

In the Eastern seas the Chinese *sampan* is ubiquitous. Originally a small raft of three timbers with fore end upturned, it grew into a boat in very early times, and has given its name to a very large class of vessels. With flat bottom, and considerable width in proportion to its length, the normal sampan runs out into two tails astern, the timbers rounding up, and the end being built in like a bulkhead, with room for the rudder to work between it and the transom which connects the two projecting upper timbers of the stern. Some of them are as much as 30 ft. in

Existing types.

length and 8 to 10 ft. in beam. They are good carriers and speedy under sail.

The Chinese in all probability were the earliest of all peoples to solve the chief problems of boat building, and after their own fashion to work out the art of navigation, which for them has now been set and unchanged for thousands of years. They appear to have used the lee-board and centre-board in junks and sampans, and to have extended their trade to India and even beyond, centuries before anything like maritime enterprise is heard of in the north of Europe.

As regards the practice of long boat racing on rivers or tidal waters the Chinese are easily antecedent in time to the rest of the world. On great festivals in certain places the Dragon boat race forms part of the ceremony. The Dragon boats are just over 73 ft. long, with 4 ft. beam, and depth 21 in. The rowing or paddling space is about 63 ft. and the number of thwarts 27, thus giving exactly the same number of rowers as that of the Zygites in the Greek trireme. The two extremities of the boat are much cambered and rise to about 2 ft. above the water. At about 15 ft. from each end the single plank gives place to three; so as to offer a concave surface to the water. The paddle blade is spade-like in form and about 6½ in. broad.

Both in Siam and Burma there is a very large river population, and boat racing is on festival days a common amusement. The typical craft, however, is the Duck-boat, which in the shape of hull is in direct contrast to the dug-out form, and primarily intended for sailing. It is interesting to note that the Siamese method of slinging and using quarter rudders is the oldest used by men in sailing craft, being in fact the earliest development from the simple paddle rudder, which has in all ages been the first method of steering boats. The king of Siam's state barge, we are told, is steered by long paddles, precisely in the same way as is figured in the case of the Egyptian boats of the 3rd dynasty (6000 B.C.). On the other hand the slung quarter rudders are the same in fashion as those used by Roman and Greek merchantmen, by Norsemen and Anglo-Saxons, and by medieval seamen down to about the 14th century.

The Malays have generally the credit of being expert boat-builders, but the local conditions are not such as to favour the construction of a good type of boat. "Small displacement, hollow lines, V-shaped sections, shallow draught and lack of beam" result in want of stability and weatherliness. But it is among them that the ancient process of dug-out building still survives and flourishes, preserving all the primitive and ingenious methods of hollowing the tree trunk, of forcing its sides outwards, and in many cases building them up with added planks, so that from the dug-out a regular boat is formed, with increased though limited carrying power, increased though still hardly sufficient stability.

To ensure this last very necessary quality many devices and contrivances are resorted to.

In some cases (just as Ulysses is described as doing by Homer, *Od.* v. 256) the boatman fastens bundles of reeds or of bamboos all along the sides of his boat. These being very buoyant not only act as a defence against the wash of the waves, but are sufficient to keep the boat afloat in any sea.

But the most characteristic device is the outrigger, a piece of floating wood sharpened at both ends, which is fixed parallel to the longer axis of the boat, at a distance of two or three beams, by two or more poles laid at right angles to it. This, while not interfering materially with the speed of the boat, acts as a counterpoise to any pressure on it which would tend, owing to its lack of stability, to upset it, and makes it possible for the long narrow dug-out to face even the open sea. It is remarkable that this invention, which must have been seen by the Egyptians and Phoenicians in very early times, was not introduced by them into the Mediterranean. Possibly this was owing to the lack of large timber suitable for dug-outs, and the consequent evolution by them of boat from raft, with sufficient beam to rely upon for stability.

On the other hand in the boats of India the influence of Egyptian and Arab types of build is apparent, and the dinghy of

the Hugli is cited as being in form strangely like the ancient Egyptian model still preserved in the Ghizeh museum. Coming westward the dominant type of build is that of the Arab *dhows*, the boat class of which has all the characteristics of the larger vessel developed from it, plenty of beam, overhanging stem and transom stern. The planking of the shell over the wooden frame has a double thickness which conduces to dryness and durability in the craft.

On the Nile it is interesting to find the *naggar* preserving, in its construction out of blocks of acacia wood pinned together, the old-world fashion of building described by Herodotus. The *gaiassa* and *dakabiak* are too large to be classed as boats, but they and their smaller sisters follow the Arab type in build and rig.

It is noteworthy that nothing apparently of the ancient Egyptian or classical methods of build survives in the Mediterranean, while the records of the development of boat-building in the middle ages are meagre and confusing. The best illustrations of ancient methods of construction, and of ancient seamanship, are to be found, if anywhere, in the East, that conservative storehouse of types and fashions, to which they were either communicated, or from which they were borrowed, by Egyptians or Phoenicians, from whom they were afterwards copied by Greeks and Romans.

In the Mediterranean the chief characteristics of the types belonging to it are "carvel-build, high bow, round stern and deep rudder hung on stern post outside the vessel."

In the eastern basin the long-bowed wide-sterned *caïque* of the Bosphorus is perhaps the type of boat best known, but both Greek and Italian waters abound with an unnumbered variety of boats of "beautiful lines and great carrying power." In the Adriatic, the Venetian gondola, and the light craft generally, are of the type developed from the raft, flat-bottomed, and capable of navigating shallow waters with minimum of draught and maximum of load.

In the western basin the majority of the smaller vessels are of the sharp-sterned build. Upon the boats of the *felucca* class, long vessels with easy lines and low free-board, suitable for rowing as well as sailing, the influence of the long galley of the middle ages was apparent. In Genoese waters at the beginning of the 19th century there were single-decked rowing vessels, which preserved the name of galley, and were said to be the descendants of the Liburnians that defeated the many-banked vessels of Antonius at Actium. But the introduction of steam vessels has already relegated into obscurity these memorials of the past.

Along the Riviera and the Spanish coast a type of boat is noticeable which is peculiar for the inward curve of both stem and stern from a keel which has considerable camber, enabling them to be beached in a heavy surf.

On the Douro, in Portugal, it is said that the boats which may be seen laden with casks of wine, trailing behind them an enormously long steering paddle, are of Phoenician ancestry, and that the curious signs, which many of them have painted on the cross board over the cabin, are of Semitic origin though now undecipherable.

Coming to the northern waters, as with men, so with boats, we meet with a totally different type. Instead of the smooth exterior of the carvel-build, we have the more rugged form of clinker-built craft with great beam, and raking stems and stems, and a wide flare forward. In the most northern waters the strakes of the sea-going boats are wide and of considerable thickness, of oak or fir, often compacted with wooden trenails, strong and fit to do battle with the rough seas and rough usage which they have to endure.

In most of these the origin of form and character is to be sought for in the old Viking vessels or long *keeles* of the 5th century A.D., with curved and elevated stem and stern posts, and without decks or, at the most, half decked.

In the Baltic and the North Sea most of the fishing boats follow this type, with, however, considerable variety in details. It is noticeable that here also, as in other parts of the world, and at other times, the pressing demand for speed and carrying power

has increased the size in almost all classes of boats till they pass into the category of ships. At the same time the carvel-build is becoming more common, while, in the struggle for life, steam and motor power are threatening to obliterate the old types of rowing and sailing boats altogether.

Next to the Norse skiff and its descendants, perhaps the oldest type of boat in northern waters is to be found in Holland, where the conditions of navigation have hardly altered for centuries. It is to the Dutch that we chiefly owe the original of our pleasure craft, but, though we have developed these enormously, the Dutch boats have remained pretty much the same. The clinker-build and the wide rounded bow are now very much of the same character as they are represented in the old pictures of the 17th and 18th centuries.

The development of boat-building in the British Isles during the 19th century has been unceasing and would need a treatise to itself to do it justice. The expansion of the fishing industry and the pressure of competition have stimulated constant improvement in the craft engaged, and here also are observable the same tendencies to substitute carvel, though it is more expensive, for clinker build, and to increase the length and size of the boats, and the gradual supersession of sail and oar by steam power. Under these influences we hear of the *fish* and the *skiff* classes, old favourites in northern waters, being superseded by the more modern *Zulus*, which is supposed to unite the good qualities of both; and these in turn running to such a size as to take them outside the category of boats. But even in the case of smaller boats the *Zulu* model is widely followed, so that they have actually been imported to the Irish coast for the use of the crofter fishermen in the congested districts.

For the Shetland *sewers* and the broad boats of the Orkneys, and the *sabbies* of the west coast of Scotland, the curious will do well to refer to H. Warington Smyth's most excellent account.

On the eastern coast of England the influence of the Dutch type of build is manifest in many of the flat-bottomed and mostly round-ended craft, such as the Yorkshire *Billyboy*, and partly in the *coble*, which latter is interesting as built for launching off beaches against heavy seas, and as containing relics of Norse influence, though in the main of Dutch origin.

The life-boats of the eastern coast are in themselves an admirable class of boat, with fine lines, great length, and shallow draught, wonderful in their daring work in foul weather and heavy seas, in which as a rule their services are required. Here, however, as in the fishing boats, the size is increasing, and steam is appropriating to itself the provinces of the sail and the oar.

The wherry of the Norfolk Broads has a type of its own, and is often fitted out as a pleasure boat. It is safe and comfortable for inland waters, but not the sort of boat to live in a sea-way in anything but good weather.

The Thames and its estuary rejoice in a great variety of boats, of which the old *Peter* boat (so called after the legend of the foundation of the abbey on Thorney Island) preserved a very ancient type of build, shorter and broader than the old Thames pleasure wherry. But these and the old *hatch* boat have now almost disappeared. Possibly survivors may still be seen on the upper part of the tidal river. Round the English coast from the mouth of the Thames southwards the conditions of landing and of hauling up boats above high-water mark affect the type, demanding strong clinker-build and stout timbers. Hence there is a strong family resemblance in most of the short boats in use from the North Foreland round to Brighton. Among these are the life-boats of Deal and the other Channel ports, which have done and are still doing heroic work in saving life from wrecks upon the Goodwins and the other dangerous shoals that beset the narrowing sleeve of the English Channel.

Farther down, along the southern coast, and to the west, where harbours are more frequent, a finer and deeper class of boats, chiefly of carvel-build, is to be found. The Cornish ports are the home of a great boat-building industry, and from them a large number of the finest fishing boats in the world are turned out annually. Most of them are built with stem and stern alike, with full and bold quarters, and ample floor.

It is not possible here to enumerate, much less to describe in detail, the variety of types in sea-going boats which have been elaborated in England and in America. For this purpose reference should be made to the list of works given at the end of the article.

The following is a list of the boats at present used in the royal navy. They have all of them a deep fore foot, and with the exception of the whalers and Berthon boats, upright stems and transom sterns. The whalers have a raking stem and a sharp stern, and a certain amount of sheer in the bows.

	Length. Feet.	Beam. Ft. in.	Depth. Ft. in.
1a. Dinghy. Freeboard about 9 in. Weight 3 cwt. 2 qr. Between thwarts 2 ft. 9 in. Elm	13½	4' 8"	2' 2"
1b. Skiff dinghy for torpedo boats. Free- board about 9 in. Carry about ten men in moderate weather. Between thwarts 2 ft. 7½ in. Weight 3 cwt. 4 lb. Yellow pine	16	4' 6"	1' 10"
2a. Whaler for destroyers. 5 in. sheer. Yellow pine	25	5' 6"	2'
2b. Whaler. Between thwarts 2 ft. 10 in. Freeboard about 12 in. Weight, 8 cwt. Strakes No. 13. Lap ½ in. Elm (All have bilge strakes with hand-holes.)	27	5' 6"	2' 2"
3. Gig. Between thwarts 2 ft. 9½ in. Weight 8 cwt. 2 qr. 15, lb. 13 Strakes. Elm	30	5' 6"	2' 2"
4. Cutter. Between thwarts 3 ft. 1 in. To carry 49 men. Carvel built	30	8' 1"	2' 8½"
5. Pinnace. Between thwarts 3 ft. Carvel-built. Elm	36	10' 2"	3' 5"
6. Launch. Between thwarts 3 ft. 1 in. To carry 140 men. Double skin diagonal. Teak	42	11' 6"	4' 6"
7. Berthon collapsible boats weighing 7 cwt. for destroyers.			

With the exception of the larger classes, viz. cutters, pinnaces and launches, the V-shape of bottom is still preserved, which does not tend to stability, and it is difficult to see why the smaller classes have not followed the improvement made in their larger sisters.

Though the number and variety of sea-going boats is of much greater importance, no account of boats in general would be complete without reference to the development of pleasure craft upon rivers and inland waters, especially in England, during the past century. There is a legend, dating from Saxon times, which tells of King Edgar the Peaceable being rowed on the Dee from his palace in Chester to the church of St John, by eight kings, himself the ninth, steering this ancient 8-oar; but not much is heard of rowing in England until 1453, when John Norman, lord mayor of London, set the example of going by water to Westminster, which, we are told, made him popular with the watermen of his day, as in consequence the use of pleasure boats by the citizens became common. Thus it was that the old Thames pleasure wherry, with its high bows and low sharp stern and V-shaped section, and the old skiff came into vogue, both of which have now given way to boats, mostly of clinker-build, but with rounder bottoms and greater depth, safer and more comfortable to row in.

In 1715 Thomas Doggett (*q.v.*) founded a race which is still rowed in peculiar sculling boats, straked, and with sides flaring up to the sill of the rowlock. Strutt tells us of a regatta in 1775 in which watermen contended in pair-oared boats or skiffs.

At the beginning of the 19th century numerous rowing clubs flourished on the upper tidal waters of the Thames, and we hear of four-oared races from Westminster to Putney, and from Putney to Kew, in what we should now consider large and heavy boats, clinker-built, with bluff entry.

Longer boats, 8-oars, and 10-oars, seem to have been existent at the end of the 18th century. Eton certainly had one 10-oar, and three 8-oars, and two 6-oars, before 1811. The record of 8-oar races at Oxford begins in 1815, at Cambridge in

Pleasure
boats and
racing.

1827. Pair-oar and sculling races in lighter boats seem to have come in soon after 1820, and the first Oxford and Cambridge eight-oared race was rowed in 1829, in which year also Eton and Westminster contended at Putney.

Henley regatta was founded in 1839, and since that date the building of racing boats, eights, fours, pairs, and sculling boats, has made great progress. The products of the present time are arch, in lightness of build and swiftness of propulsion, as would have been thought impossible between 1820 and 1830.

In the middle of the 19th century the long boats in use were mostly clinker-built with a keel. At Oxford the torpids were rowed, as now, in clinker-built craft, but the summer races were rowed in carvel-built boats, which also had a keel.

In 1855 the first keelless 8-oar made its appearance at Henley, built by Mat Taylor for the Royal Chester Rowing Club. The new type was constructed on moulds, bottom upwards, a cedar skin bent and fitted on to the moulds, and the ribs built in after the boat had been turned over.

In 1857 Oxford rowed in a similar boat at Putney, 55 ft. long, 25 in. beam. From that time the keelless racing boat has held its own, fours and pairs and sculling boats all following suit. But with the introduction of sliding seats racing eights have developed in length to 63 ft. or more, with considerable camber, and a beam of 23-24 in. There are, however, still advocates of the shorter type with broader beam, and it is noticeable that the Belgian boat that won the Grand Challenge at Henley in 1906 did not exceed 60 ft. The boat in which Oxford won the University race in 1901 was 56 ft. long with 27 in. of beam.

In sculling boats the acceptance of the Australian type of build has led to the construction of a much shorter boat with broader beam than that which was in vogue twenty years ago. The same tendency has not shown itself so pronouncedly in pair oars, but will no doubt be manifest in time as the build improves. In fact we may expect the controversy between long and short racing boats, and the proper method of propelling them respectively, to be carried a step farther. The tendency, with the long slide, and long type of boat, is to try to avoid "pinch" by adopting the scullers' method of easy beginning, and strong drive with the legs, and sharp finish to follow, but it remains to be seen whether superior pace is not to be obtained in a shorter boat by sharp beginning at a reasonable angle to the boat's side, and a continuous drive right out to the finish of the stroke.

Appended is a list of pleasure boats in use (1909) on the Thames, with their measurements (in feet and inches).

Class of Boat.	Length.	Beam.	Depth.
Racing eight . . .	56' to 63'	23' to 27'	9' to 10'
Clinker eight . . .	56' to 60'	24' to 27'	9' to 10'
Clinker four . . .	38' to 42'	23' to 24'	8' to 9'
Tub four . . .	30' to 32'	3' 8" - 3' 10"	13" from keel to top of stem
Outrigger pair . . .	30' to 34'	14' to 16'	7' to 8'
Outrigger sculls . . .	25' to 30'	10' to 13'	5½' to 6'
Coaching gigs . . .	26' to 28'	3' to 3' 4"	10½' to 14"
Skiffs (Thames) . . .	24' to 26'	3' 9" to 4'	12"
Skiffs (Eton) . . .	27'	2' 3"	9½"
Gigs (pleasure) . . .	24' to 26'	4'	15' to 16'
Randans . . .	27' to 30'	4' to 4' 6"	13" from keel to top of stem
Whiffs . . .	20' to 23'	1' 4" to 1' 6"	6" from keel to top of stem
Whiff Gigs . . .	19' to 20'	2' 8" to 2' 10"	12" over all
Punta racers . . .	20' to 34'	1' 3" to 1' 6"	6" to 7"
" semi racers . . .	28' to 30'	2'	9' to 10½"
" pleasure . . .	26' to 28'	2' 9" to 3'	12" to 13"

AUTHORITIES.—For ancient boats: *Dict. Ant.*, "Navis"; C. Torr, *Ancient Ships*; Smith, *Voyage and Shipwreck of St Paul*; Graser, *De re navali*; Breusing, *Die Nautik der Alten*; Contre-amiral Serre, *La Marine des anciens*; Jules Var, *L'Art navistique dans l'antiquité*. Medieval: Jal, *Archéologie navale*, and *Glossaire navistique*; Marquis de Folin, *Bateaux et navires, progrès de la construction navale*; W. S. Lindsay, *History of Merchant Shipping and Ancient Commerce*. Modern: H. Warrington Smyth, *Mast and Sail in Europe and Asia*; Dixon Kempe, *Manual of Yacht and Boat Sailing*; H. C. Folkhard, *The Sailing Boat*; F. G. Aflalo, *The Sea Fishing Industry of England and Wales*; R. C. Leslie, *Old Sea Wings*, &c. (E. W.A.)

BOATSWAIN (pronounced "bo'sen"; derived from "boat" and "swain," a servant), the warrant officer of the navy who in sailing-ships had particular charge of the boats, sails, rigging, colours, anchors and cordage. He superintended the rigging of the ship in dock, and it was his duty to summon the crew to work by a whistle. The office still remains, though with functions modified by the introduction of steam. In a merchant ship the boatswain is the foreman of the crew and is sometimes also third or fourth mate.

BOBBILI, a town of British India, in the Vizagapatam district of Madras, 70 m. north of Vizagapatam town. Pop. (1901) 17,387. It is the residence of a raja of old family, whose estate covers an area of 227 sq. m.; estimated income, £40,000; permanent land revenue, £9,000.

The attack on the fort at Bobbili made by General Bussy in 1756 is one of the most memorable episodes in Indian history. There was a constant feud between the chief of Bobbili and the raja of Vizianagram; and when Bussy marched to restore order the raja persuaded him that the fault lay with the chief of Bobbili and joined the French with 11,000 men against his rival. In spite of the fact that the French field-pieces at once made practicable breaches in the mud walls of the fort, the defenders held out with desperate valour. Two assaults were repulsed after hours of hand-to-hand fighting; and when, after a fresh bombardment, the garrison saw that their case was hopeless, they killed their women and children, and only succumbed at last to a third assault because every man of them was either killed or mortally wounded. An old man, however, crept out of a hut with a child, whom he presented to Bussy as the son of the dead chief. Three nights later four followers of the chief of Bobbili crept into the tent of the raja of Vizianagram and stabbed him to death. The child, Chinna Ranga Rao, was invested by Bussy with his father's estate, but during his minority it was seized by his uncle. After a temporary arrangement of terms with the raja of Vizianagram the old feud broke out again, and the Bobbili chief was forced to take refuge in the nizam's country. In 1794, however, on the break-up of the Vizianagram estate, Chinna Ranga Rao was restored by the British, and in 1801 a permanent settlement was made with his son. The title of raja was recognized as hereditary in the family; that of maharaja was conferred as a personal distinction on Sir Venkataswetalapati Ranga Rao, K.C.I.E., the adopted great-great-grandson of Chinna Ranga Rao.

For the siege see *Imp. Gazetteer of India* (Oxford, 1908), s. v. "Bobbili Estate."

BOBBIO, a town and episcopal see of Lombardy, Italy, in the province of Pavia, 32½ m. S.W. of Piacenza by road. Pop. (1901) 4848. Its most important building is the church dedicated to St Columban, who became first abbot of Bobbio in 595 or 612, and died there in 615. It was erected in Lombard style in the 11th or 12th century (to which period the campanile belongs) and restored in the 13th. The cathedral is also interesting. Bobbio was especially famous for the manuscripts which belonged to the monastery of St Columban, and are now dispersed, the greater part being in the Vatican library at Rome, and others at Milan and Turin. The cathedral archives contain documents of the 10th and 11th centuries.

See M. Stokes, *Six Months in the Apennines* (London, 1892), 154 seq.; C. Cipolla, in *L'Arte* (1904), 241.

BOBER, a river of Germany, the most considerable of the left bank tributaries of the Oder; it rises at an altitude of 2440 ft., on the northern (Silesian) side of the Riesengebirge. In its upper course it traverses a higher plateau, whence, after passing the town of Landeshut, it descends through a narrow and fertile valley to Kupferberg. Here its romantic middle course begins, and after dashing through a deep ravine between the towns of Hirschberg and Lwenzberg, it gains the plain. In its lower course it meanders through pleasant pastures, bogland and pine forests in succession, receives the waters of various mountain streams, passes close by Bunzlau and through Sagan, and finally, after a course of 160 m., joins the Oder at Crossen. Swollen by the melting of the winter snows and by heavy rains in the

mountains, it is frequently a torrent, and is thus, except in the last few miles, unnavigable for either boats or rafts.

BOBRUISK, a town and formerly a first-class fortress of Russia, in the government of Minsk, and 100 m. by rail S.E. of the town of Minsk, in 53° 15' N. lat. and 28° 52' E. long., on the right bank of the Berezina river, and on the railway from Libau and Vilna to Ekaterinograd. Pop. (1860) 23,761; (1897) 35,177, of whom one-half were Jews. In the reign of Alexander I. there was erected here, at the confluence of the Bobruiska with the Berezina, nearly a mile from the town, a fort, which successfully withstood a bombardment by Napoleon in 1812, and was made equal to the best in Europe by the emperor Nicholas I. It was demolished in 1897, the defences being antiquated. The town has a military hospital and a departmental college. There are ironworks and flour-mills; and corn and timber are shipped to Libau. The town was half burnt down in 1902.

BOCAGE, MANUEL MARIA BARBOSA DE (1765-1805), Portuguese poet, was a native of Setubal. His father had held important judicial and administrative appointments, and his mother, from whom he took his last surname, was the daughter of a Portuguese vice-admiral of French birth who had fought at the battle of Matapan. Bocage began to make verses in infancy, and being somewhat of a prodigy grew up to be flattered, self-conscious and unstable. At the age of fourteen, he suddenly left school and joined the 7th infantry regiment; but tiring of garrison life at Setubal after two years, he decided to enter the navy. He proceeded to the royal marine academy in Lisbon, but instead of studying he pursued love adventures, and for the next five years burnt incense on many altars; while his retentive memory and extraordinary talent for improvisation gained him a host of admirers and turned his head. The Brazilian *modinhas*; little rhymed poems sung to a guitar at family parties, were then in great vogue, and Bocage added to his fame by writing a number of these, by his skill in extemporizing verses on a given theme, and by allegorical idyllic pieces, the subjects of which are similar to those of Watteau's and Boucher's pictures. In 1786 he was appointed *guardamarinhô* in the Indian navy, and he reached Goa by way of Brazil in October. There he came into an ignorant society full of petty intrigue, where his particular talents found no scope to display themselves; the glamour of the East left him unmoved and the climate brought on a serious illness. In these circumstances he compared the heroic traditions of Portugal in Asia, which had induced him to leave home, with the reality, and wrote his satirical sonnets on "The Decadence of the Portuguese Empire in Asia," and those addressed to Afonso de Albuquerque and D. João de Castro. The irritation caused by these satires, together with rivalries in love affairs, made it advisable for him to leave Goa, and early in 1789 he obtained the post of lieutenant of the infantry company at Damaun; but he promptly deserted and made his way to Macao, where he arrived in July-August. According to a modern tradition much of the *Lusiads* had been written there, and Bocage probably travelled to China under the influence of Camoens, to whose life and misfortunes he loved to compare his own. Though he escaped the penalty of his desertion, he had no resources and lived on friends, whose help enabled him to return to Lisbon in the middle of the following year.

Once back in Portugal he found his old popularity, and resumed his vagabond existence. The age was one of reaction against the Pombaline reforms, and the famous intendant of police, Manique, in his determination to keep out French revolutionary and atheistic propaganda, forbade the importation of foreign classics and the discussion of all liberal ideas. Hence the only vehicle of expression left was satire, which Bocage employed with an unsparring hand. His poverty compelled him to eat and sleep with friends like the turbulent friar José Agostinho de Macedo (q.v.), and he soon fell under suspicion with Manique. He became a member of the New Arcadia, a literary society founded in 1790, under the name of Elmano Sadino, but left it three years later. Though including in its ranks most of the poets of the time, the New Arcadia produced little of real merit, and before long its adherents became enemies and

descended to an angry warfare of words. But Bocage's reputation among the general public and with foreign travellers grew year by year. Beckford, the author of *Vathek*, for instance, describes him as "a pale, limber, odd-looking young man, the queerest but perhaps the most original of God's poetical creatures. This strange and versatile character may be said to possess the true wand of enchantment which at the will of its master either animates or enchants." In 1797 enemies of Bocage belonging to the New Arcadia delated him to Manique, who on the pretext afforded by some anti-religious verses, the *Epistola á Maria*, and by his loose life, arrested him when he was about to flee the country and lodged him in the Límoeiro, where he spent his thirty-second birthday. His sufferings induced him to a speedy recantation, and after much importuning of friends, he obtained his transfer in November from the state prison to that of the Inquisition, then a mild tribunal, and shortly afterwards recovered his liberty. He returned to his bohemian life and subsisted by writing empty *Elogios Dramaticos* for the theatres, printing volumes of verses and translating the didactic poems of Delille, Castel and others, some second-rate French plays and Ovid's *Metamorphoses*. These resources and the help of brother Freemasons just enabled him to exist, and a purifying influence came into his life in the shape of a real affection for the two beautiful daughters of D. Antonio Bersane Leite, which drew from him verses of true feeling mixed with regrets for the past. He would have married the younger lady, D. Anna Perpetua (Analia), but excesses had ruined his health. In 1801 his poetical rivalry with Macedo became more acute and personal, and ended by drawing from Bocage a stinging extempore poem, *Pena de Taliso*, which remains a monument to his powers of invective. In 1804 the malady from which he suffered increased, and the approach of death inspired some beautiful sonnets, including one directed to D. Maria (*Marcia*), elder sister of Analia, who visited and consoled him. He became reconciled to his enemies, and breathed his last on the 21st of December 1805. His end recalled that of Camoens, for he expired in poverty on the eve of the French invasion, while the singer of the *Lusiads* just failed to see the occupation of Portugal by the duke of Alva's army. The gulf that divides the life and achievements of these two poets is accounted for, less by difference of talent and temperament than by their environment, and it gives an accurate measure of the decline of Portugal in the two centuries that separate 1580 from 1805.

To Beckford, Bocage was "a powerful genius," and Link was struck by his nervous expression, harmonious versification and the fire of his poetry. He employed every variety of lyric and made his mark in all. His rounds are good, his epigrams witty, his satires rigorous and searching, his odes often full of nobility, but his fame must rest on his sonnets, which almost rival those of Camoens in power, elevation of thought and tender melancholy, though they lack the latter's scholarly refinement of phrasing. So dazzled were contemporary critics by his brilliant and inspired extemporizations that they ignored Bocage's licentiousness, and overlooked the slightness of his creative output and the artificial character of most of his poetry. In 1871 a monument was erected to the poet in the chief square of Setubal, and the centenary of his death was kept there with much circumstance in 1905.

The best editions of his collected works are those of I. F. da Silva, with a biographical and literary study by Rebello da Silva, in 6 vols. (Lisbon, 1853), and of Dr Theophilo Braga, in 8 vols. (Oporto, 1875-1876). See also I. F. da Silva, *Dicionario Bibliographico Portuguez*, vol. vi. pp. 45-53, and vol. xvi. pp. 260-264; Dr T. Braga, *Bocage, sua vida e epoca litteraria* (Oporto, 1902). A striking portrait of Bocage by H. J. da Silva was engraved by Bartolozzi, who spent his last years in Lisbon. (E. Pk.)

BOCAGE (from O. Fr. *boscage*, Late Lat. *boscum*, a wood), a French topographical term applied to several regions of France, the commonest characteristics of which are a granite formation and an undulating or hilly surface, consisting largely of heath or reclaimed land, and dotted with clumps of trees. The most important districts designated by the word are (1) the Bocage of Normandy, which comprises portions of the

departments of Calvados, Manche and Orne; (2) the Bocage of Vendée, situated in the departments of Vendée, Deux-Sèvres, Maine-et-Loire, and Loire-Inférieure.

BOCCACCIO, GIOVANNI (1313-1375), Italian author, whose *Decameron* is one of the classics of literature, was born in 1313, as we know from a letter of Petrarch, in which that poet, who was born in 1304, calls himself the senior of his friend by nine years. The place of his birth is somewhat doubtful—Florence, Paris and Certaldo being all mentioned by various writers as his native city. Boccaccio undoubtedly calls himself a Florentine, but this may refer merely to the Florentine citizenship acquired by his grandfather. The claim of Paris has been supported by Baldelli and Tiraboschi, mainly on the ground that his mother was a lady of good family in that city, where she met Boccaccio's father. There is a good deal in favour of Certaldo, a small town or castle in the valley of the Elsa, 20 m. from Florence, where the family had some property, and where the poet spent much of the latter part of his life. He always signed his name Boccaccio da Certaldo, and named that town as his birthplace in his own epitaph. Petrarch calls his friend Certaldese; and Filippo Villani, a contemporary, distinctly says that Boccaccio was born in Certaldo.

Boccaccio, an illegitimate son, as is put beyond dispute by the fact that a special licence had to be obtained when he desired to become a priest, was brought up with tender care by his father, who seems to have been a merchant of respectable rank. His elementary education he received from Giovanni da Strada, an esteemed teacher of grammar in Florence. But at an early age he was apprenticed to an eminent merchant, with whom he remained for six years, a time entirely lost to him, if we may believe his own statement. For from his tenderest years his soul was attached to that "*alma poësis*," which, on his tombstone, he names as the task and study of his life. In one of his works he relates that, in his seventh year, before he had ever seen a book of poetry or learned the rules of metrical composition, he began to write verse in his childish fashion, and earned for himself amongst his friends the name of "the poet." It is uncertain where Boccaccio passed these six years of bondage; most likely he followed his master to various centres of commerce in Italy and France. We know at least that he was in Naples and Paris for some time, and the youthful impressions received in the latter city, as well as the knowledge of the French language acquired there, were of considerable influence on his later career. Yielding at last to his son's immutable aversion to commerce, the elder Boccaccio permitted him to adopt a course of study somewhat more congenial to the literary tastes of the young man. He was sent to a celebrated professor of canon law, at that time an important field of action both to the student and the practical jurist. According to some accounts—far from authentic, it is true—this professor was Cino da Pistoia, the friend of Dante, and himself a celebrated poet and scholar. But, whoever he may have been, Boccaccio's master was unable to inspire his pupil with scientific ardour. "Again," Boccaccio says, "I lost nearly six years. And so nauseous was this study to my mind, that neither the teaching of my master, nor the authority and command of my father, nor yet the exertions and reproof of my friends, could make me take to it, for my love of poetry was invincible."

About 1333 Boccaccio settled for some years at Naples, apparently sent there by his father to resume his mercantile pursuits, the canon law being finally abandoned. The place, it must be confessed, was little adapted to lead to a practical view of life one in whose heart the love of poetry was firmly rooted. The court of King Robert of Anjou at Naples was frequented by many Italian and French men of letters, the great Petrarch amongst the number. At the latter's public examination in the noble science of poetry by the king, previous to his receiving the laurel crown at Rome, Boccaccio was present,—without, however, making his personal acquaintance at this period. In the atmosphere of this gay court, enlivened and adorned by the wit of men and the beauty of women, Boccaccio lived for several years. We can imagine how the tedious duties

of the market and the counting-house became more and more distasteful to his aspiring nature. We are told that, finding himself by chance on the supposed grave of Virgil, near Naples, Boccaccio on that sacred spot took the firm resolution of devoting himself for ever to poetry. But perhaps another event, which happened some time after, led quite as much as the first-mentioned occurrence to this decisive turning-point in his life. On Easter-eve, 1341, in the church of San Lorenzo, Boccaccio saw for the first time the natural daughter of King Robert, Maria, whom he immortalized as Fiammetta in the noblest creations of his muse. Boccaccio's passion on seeing her was instantaneous, and (if we may accept as genuine the confessions contained in one of her lover's works) was returned with equal ardour on the part of the lady. But not till after much delay did she yield to the amorous demands of the poet, in spite of her honour and her duty as the wife of another. All the information we have with regard to Maria or Fiammetta is derived from the works of Boccaccio himself, and owing to several apparently contradictory statements occurring in these works, the very existence of the lady has been doubted by commentators, who seem to forget that, surrounded by the chattering tongues of a court, and watched perhaps by a jealous husband, Boccaccio had all possible reason to give the appearance of fictitious incongruity to the effusions of his real passion. But there seems no more reason to call into question the main features of the story, or even the identity of the person, than there would be in the case of Petrarch's Laura or of Dante's Beatrice. It has been ingeniously pointed out by Baldelli, that the fact of her descent from King Robert being known only to Maria herself, and through her to Boccaccio, the latter was the more at liberty to refer to this circumstance,—the bold expression of the truth serving in this case to increase the mystery with which the poets of the middle ages loved, or were obliged, to surround the objects of their praise. From Boccaccio's *Ameto* we learn that Maria's mother was, like his own, a French lady, whose husband, according to Baldelli's ingenious conjecture, was of the noble house of Aquino, and therefore of the same family with the celebrated Thomas Aquinas. Maria died, according to his account, long before her lover, who cherished her memory to the end of his life, as we see from a sonnet written shortly before his death.

The first work of Boccaccio, composed by him at Fiammetta's command, was the prose tale, *Filocolo*, describing the romantic love and adventures of Florio and Biancafore, a favourite subject with the knightly minstrels of France, Italy and Germany. The treatment of the story by Boccaccio is not remarkable for originality or beauty, and the narrative is encumbered by classical allusions and allegorical conceits. The style also cannot be held worthy of the future great master of Italian prose. Considering, however, that this prose was in its infancy, and that this was Boccaccio's first attempt at remoulding the unwieldy material at his disposal, it would be unjust to deny that *Filocolo* is a highly interesting work, full of promise and all but articulate power. Another work, written about the same time by Fiammetta's desire and dedicated to her, is the *Teseide*, an epic poem, and indeed the first heroic epic in the Italian language. The name is chosen somewhat inappropriately, as King Theseus plays a secondary part, and the interest of the story centres in the two noble knights, Palemone and Arcio, and their wooing of the beautiful Emelia. The *Teseide* is of particular interest to the student of poetry, because it exhibits the first example of the *ottava rima*, a metre which was adopted by Tasso and Ariosto, and in English by Byron in *Don Juan*. Another link between Boccaccio's epic and English literature is formed by the fact of Chaucer having in the *Knight's Tale* adopted its main features.

Boccaccio's poetry has been severely criticized by his countrymen, and most severely by the author himself. On reading Petrarch's sonnets, Boccaccio resolved in a fit of despair to burn his own attempts, and only the kindly encouragement of his great friend prevented the holocaust. Posterity has justly differed from the author's sweeping self-criticism. It is true, that compared with Dante's grandeur and passion, and with Petrarch's absolute mastership of metre and language, Boccaccio's

poetry seems to be somewhat thrown into shade. His verse is occasionally slipshod, and particularly his epic poetry lacks what in modern parlance is called poetic diction,—the quality, that is, which distinguishes the elevated pathos of the recorder of heroic deeds from the easy grace of the mere *conteur*. This latter feature, so charmingly displayed in Boccaccio's prose, has to some extent proved fatal to his verse. At the same time, his narrative is always fluent and interesting, and his lyrical pieces, particularly the poetic interludes in the *Decameron*, abound with charming gallantry, and frequently rise to lyrical pathos.

About the year 1341 Boccaccio returned to Florence by command of his father, who in his old age desired the assistance and company of his son. Florence, at that time disturbed by civil feuds, and the silent gloom of his father's house could not but appear in an unfavourable light to one accustomed to the gay life of the Neapolitan court. But more than all this, Boccaccio regretted the separation from his beloved Fiammetta. The thought of her at once embittered and consoled his loneliness. Three of his works owe their existence to this period. With all of them Fiammetta is connected; of one of them she alone is the subject. The first work, called *Ameto*, describes the civilizing influence of love, which subdues the ferocious manners of the savage with its gentle power. Fiammetta, although not the heroine of the story, is amongst the nymphs who with their tales of true love soften the mind of the huntsman. *Ameto* is written in prose alternating with verse, specimens of which form occur in old and middle Latin writings. It is more probable, however, that Boccaccio adopted it from that sweetest and purest blossom of mediæval French literature, *Aucassin et Nicolette*, which dates from the 13th century, and was undoubtedly known to him. So pleased was Boccaccio with the idea embodied in the character of *Ameto* that he repeated its essential features in the Cimone of his *Decameron* (Day 5th, tale L). The second work referred to is a poem in fifty chapters, called *L'amosa Visione*. It describes a dream in which the poet, guided by a lady, sees the heroes and lovers of ancient and mediæval times. Boccaccio evidently has tried to imitate the celebrated *Trionfi* of Petrarch, but without much success. There is little original development in the poem, which reads like the *catalogue raisonné* of a picture gallery; but it is remarkable from another point of view. It is perhaps the most astounding instance in literature of ingenuity wasted on trifles; even Edgar Poe, had he known Boccaccio's puzzle, must have confessed himself surpassed. For the whole of the *Amosa Visione* is nothing but an acrostic on a gigantic scale. The poem is written, like the *Divina Commedia*, in *tersa rima*, and the initial letters of all the triplets throughout the work compose three poems of considerable length, in the first of which the whole is dedicated to Boccaccio's lady-love, this time under her real name of Maria. In addition to this, the initial letters of the first, third, fifth, seventh and ninth lines of the dedicatory poem form the name of Maria; so that here we have the acrostic in the second degree. No wonder that thus entrammelled the poet's thought begins to flag and his language to halt. The third important work written by Boccaccio during his stay at Florence, or soon after his return to Naples, is called *L'amosa Fiammetta*; and although written in prose, it contains more real poetry than the elaborate production just referred to. It purports to be Fiammetta's complaint after her lover, following the call of filial duty, had deserted her. Bitterly she deplores her fate, and upbraids her lover with coldness and want of devotion. Jealous fears add to her torture, not altogether unfounded, if we believe the commentators' assertion that the heroine of *Ameto* is in reality the beautiful Lucia, a Florentine lady loved by Boccaccio. Sadly Fiammetta recalls the moments of former bliss, the first meeting, the stolen embrace. Her narrative is indeed our chief source of information for the incidents of this strange love-story. It has been thought unlikely, and indeed impossible, that Boccaccio should thus have become the mouthpiece of a real lady's real passion for himself; but there seems nothing incongruous in the supposition that after a happy reunion the poet should have heard with satisfaction, and surrounded with the halo of ideal art, the story of his lady's sufferings. Moreover, the

language is too full of individual intensity to make the conjecture of an entirely fictitious love affair intrinsically probable. *L'amosa Fiammetta* is a monody of passion sustained even to the verge of dulness, but strikingly real, and therefore artistically valuable.

By the intercession of an influential friend, Boccaccio at last obtained (in 1344) his father's permission to return to Naples, where in the meantime Giovanna, grand-daughter of King Robert, had succeeded to the crown. Being young and beautiful, fond of poetry and of the praise of poets, she received Boccaccio with all the distinction due to his literary fame. For many years she remained his faithful friend, and the poet returned her favour with grateful devotion. Even when the charge of having instigated, or at least connived at, the murder of her husband was but too clearly proved against her, Boccaccio was amongst the few who stood by her, and undertook the hopeless task of clearing her name from the dreadful stain. It was by her desire, no less than by that of Fiammetta, that he composed (between 1344 and 1350) most of the stories of his *Decameron*, which afterwards were collected and placed in the mouths of the Florentine ladies and gentlemen. During this time he also composed the *Filostrato*, a narrative poem, the chief interest of which, for the English reader, lies in its connexion with Chaucer. With a boldness pardonable only in men of genius, Chaucer adopted the main features of the plot, and literally translated parts of Boccaccio's work, without so much as mentioning the name of his Italian source.

In 1350 Boccaccio returned to Florence, owing to the death of his father, who had made him guardian to his younger brother Jacopo. He was received with great distinction, and entered the service of the Republic, being at various times sent on important missions to the margrave of Brandenburg, and to the courts of several popes, both in Avignon and Rome. Boccaccio boasts of the friendly terms on which he had been with the great potentates of Europe, the emperor and pope amongst the number. But he was never a politician in the sense that Dante and Petrarch were. As a man of the world he enjoyed the society of the great, but his interest in the internal commotions of the Florentine state seems to have been very slight. Besides, he never liked Florence, and the expressions used by him regarding his fellow-citizens betray anything but patriotic prejudice. In a Latin eclogue he applies to them the term "Batrachos" (frogs), by which, he adds parenthetically—*Ego intelligo Florentinorum morem; loquacissimi enim sumus, verum in rebus bellicis nihil valeamus*. The only important result of Boccaccio's diplomatic career was his intimacy with Petrarch. The first acquaintance of these two great men dates from the year 1350, when Boccaccio, then just returned to Florence, did all in his power to make the great poet's short stay in that city agreeable. When in the following year the Florentines were anxious to draw men of great reputation to their newly-founded university, it was again Boccaccio who insisted on the claims of Petrarch to the most distinguished position. He himself accepted the mission of inviting his friend to Florence, and of announcing to Petrarch at the same time that the forfeited estates of his family had been restored to him. In this manner an intimate friendship grew up between them to be parted only by death. Common interests and common literary pursuits were the natural basis of their friendship, and both occupy prominent positions in the early history of that great intellectual revival commonly called the Renaissance.

During the 14th century the study of ancient literature was at a low ebb in Italy. The interest of the lay world was engrossed by political struggles, and the treasures of classical history and poetry were at the mercy of monks, too lazy or too ignorant to use, or even to preserve them. Boccaccio himself told that, on asking to see the library of the celebrated monastery of Monte Cassino, he was shown into a dusty room without a door to it. Many of the valuable manuscripts were mutilated; and his guide told him that the monks were in the habit of tearing leaves from the codices to turn them into palsters for children, or amulets for women at the price of four or five *solidi* apiece.

Boccaccio did all in his power to remove by word and example this barbarous indifference. He bought or copied with his own hand numerous valuable manuscripts, and an old writer remarks that if Boccaccio had been a professional copyist, the amount of his work might astonish us. His zealous endeavours for the revival of the all but forgotten Greek language in western Europe are well known. The most celebrated Italian scholars about the beginning of the 15th century were unable to read the Greek characters. Boccaccio deplored the ignorance of his age. He took lessons from Leone Pilato, a learned adventurer of the period, who had lived a long time in Thessaly and, although born in Calabria, pretended to be a Greek. By Boccaccio's advice Leone Pilato was appointed professor of Greek language and literature in the university of Florence, a position which he held for several years, not without great and lasting benefit for the revival of classical learning. Boccaccio was justly proud of having been intimately connected with the foundation of the first chair of Greek in Italy. But he did not forget, in his admiration of classic literature, the great poets of his own country. He never tires in his praise of the sublime Dante, whose works he copied with his own hand. He conjures his friend Petrarch to study the great Florentine, and to defend himself against the charges of wilful ignorance and envy brought against him. A life of Dante, and the commentaries on the first sixteen cantos of the *Inferno*, bear witness to Boccaccio's learning and enthusiasm.

In the chronological enumeration of our author's writings we now come to his most important work, the *Decameron*, a collection of one hundred stories, published in their combined form in 1353, although mostly written at an earlier date. This work marks in a certain sense the rise of Italian prose. It is true that Dante's *Vita Nuova* was written before, but its involved sentences, founded essentially on Latin constructions, cannot be compared with the infinite suppleness and precision of Boccaccio's prose. The *Cento Novelle Antiche*, on the other hand, which also precedes the *Decameron* in date, can hardly be said to be written in artistic language according to definite rules of grammar and style. Boccaccio for the first time speaks a new idiom, flexible and tender, like the character of the nation, and capable of rendering all the shades of feeling, from the coarse laugh of cynicism to the sigh of hopeless love. It is by the name of "Father of Italian Prose" that Boccaccio ought to be chiefly remembered.

Like most progressive movements in art and literature, Boccaccio's remoulding of Italian prose may be described as a "return to nature." It is indeed the nature of the Italian people itself which has become articulate in the *Decameron*; here we find southern grace and elegance, together with that unveiled softness of impulse which is so striking and so amiable a quality of the Italian character. The undesirable complement of the last-mentioned feature, a coarseness and indecency of conception and expression hardly comprehensible to the northern mind, also appears in the *Decameron*, particularly where the life and conversation of the lower classes are the subject of the story. At the same time, these descriptions of low life are so admirable, and the character of popular parlance rendered with such humour, as often to make the frown of moral disgust give way to a smile.

It is not surprising that a style so concise and yet so pliable, so typical and yet so individual, as that of Boccaccio was of enormous influence on the further progress of a prose in a manner created by it. This influence has indeed prevailed down to the present time, to an extent beneficial upon the whole, although frequently fatal to the development of individual writers. Novelists like Giovanni Fiorentino or Franco Sacchetti are completely under the sway of their great model; and Boccaccio's influence may be discerned equally in the plastic fulness of Machiavelli and in the pointed satire of Aretino. Without touching upon the individual merits of Lasca, Bandello and other novelists of the *cinque-cento*, it may be asserted that none of them created a style independent of their great predecessor. One cannot indeed but acquiesce in the authoritative utterance of

the Accademia della Crusca, which holds up the *Decameron* as the standard and model of Italian prose. Even the Della Cruscan writers themselves have been unable to deprive the language wholly of the fresh spontaneity of Boccaccio's manner, which in modern literature we again admire in Manzoni's *Promessi sposi*.

A detailed analysis of a work so well known as the *Decameron* would be unnecessary. The description of the plague of Florence preceding the stories is universally acknowledged to be a masterpiece of epic grandeur and vividness. It ranks with the paintings of similar calamities by Thucydides, Defoe and Manzoni. Like Defoe, Boccaccio had to draw largely on hearsay and his own imagination, it being almost certain that in 1348 he was at Naples, and therefore no eye-witness of the scenes he describes. The stories themselves, a hundred in number, range from the highest pathos to the coarsest licentiousness. A creation like the patient Griselda, which international literature owes to Boccaccio, ought to atone for much that is morally and artistically objectionable in the *Decameron*. It may be said on this head, that his age and his country were not only deeply immoral, but in addition exceedingly outspoken. Moreover, his sources were anything but pure. Most of his improper stories are either anecdotes from real life, or they are taken from the *fabliaux* of mediæval French poets. On comparing the latter class of stories (about one-fifth of the whole *Decameron*) with their French originals, one finds that Boccaccio has never added to, but has sometimes toned down the revolting ingredients. Notwithstanding this, it cannot be denied that the artistic value of the *Decameron* is greatly impaired by descriptions and expressions, the intentional licentiousness of which is but imperfectly veiled by an attempt at humour.

Boccaccio has been accused of plagiarism, particularly by French critics, who correctly state that the subjects of many stories in the *Decameron* are borrowed from their literature. A similar objection might be raised against Chaucer, Shakespeare, Goethe (in *Faust*), and indeed most of the master minds of all nations. Power of invention is not the only nor even the chief criterion of a great poet. He takes his subjects indiscriminately from his own fancy, or from the consciousness of his and other nations. Stories float about in the air, known to all yet realized by few; the poet gathers their *disjecta membra* into an organic whole, and this he inspires and calls into life with the breath of his genius. It is in this sense that Boccaccio is the creator of those innumerable beautiful types and stories, which have since become household words amongst civilized nations. No author can equal him in these contributions to the store of international literature. There are indeed few great poets who have not in some way become indebted to the inexhaustible treasure of Boccaccio's creativeness. One of the greatest masterpieces of German literature, Lessing's *Nathan the Wise*, contains a story from Boccaccio (*Decameron*, Day 1st, tale iii.), and the list of English poets who have drawn from the same source comprises, among many others, the names of Chaucer, Lydgate, Dryden, Keats and Tennyson.

For ten years Boccaccio continued to reside in Florence, leaving the city only occasionally on diplomatic missions or on visits to his friends. His fame in the meantime began to spread far and wide, and his *Decameron*, in particular, was devoured by the fashionable ladies and gentlemen of the age. About 1360 he seems to have retired from the turbulent scenes of Florence to his native Certaldo, the secluded charms of which he describes with rapture. In the following year took place that strange turning-point in Boccaccio's career which is generally described as his conversion. It seems that a Carthusian monk came to him while at Certaldo charged with a posthumous message from another monk of the same order, to the effect that if Boccaccio did not at once abandon his godless ways in life and literature his death would ensue after a short time. It is also mentioned that the revelation to the friar on his deathbed of a secret known only to Boccaccio gave additional import to this alarming information. Boccaccio's impressionable nature was deeply moved. His life had been far from virtuous; in his

writings he had frequently sinned against the rules of morality, and worse still, he had attacked with bitter satire the institutions and servants of holy mother church. Terrified by the approach of immediate death, he resolved to sell his library, abandon literature, and devote the remainder of his life to penance and religious exercise. To this effect he wrote to Petrarch. We possess the poet's answer; it is a masterpiece of writing, and what is more, a proof of tenderest friendship. The message of the monk Petrarch is evidently inclined to treat simply as pious fraud, without, however, actually committing himself to that opinion. "No monk is required to tell thee of the shortness and precariousness of human life. Of the advice received accept what is good; abandon worldly cares, conquer thy passions, and reform thy soul and life of degraded habits. But do not give up the studies which are the true food of a healthy mind." Boccaccio seems to have acted on this valuable advice. His later works, although written in Latin and scientific in character, are by no means of a religious kind. It seems, however, that his entering the church in 1362 is connected with the events just related.

In 1363 Boccaccio went on a visit to Naples to the seneschal Acciajuoli (the same Florentine who had in 1344 persuaded the elder Boccaccio to permit his son's return to Naples), who commissioned him to write the story of his deeds of valour. On his arrival, however, the poet was treated with shameful neglect, and revenged himself by denying the possibility of relating any valorous deeds for want of their existence. This declaration, it must be confessed, came somewhat late, but it was provoked by a silly attack on the poet himself by one of the seneschal's indiscreet friends.

During the next ten years Boccaccio led an unsettled life, residing chiefly at Florence or Certaldo, but frequently leaving his home on visits to Petrarch and other friends, and on various diplomatic errands in the service of the Republic. He seems to have been poor, having spent large sums in the purchase of books, but his independent spirit rejected the numerous splendid offers of hospitality made to him by friends and admirers. During this period he wrote four important Latin works—*De Genealogia Deorum libri XV.*, a compendium of mythological knowledge full of deep learning; *De Montibus, Silvarum, Lacuum, et Marinis nominibus liber*, a treatise on ancient geography; and two historical books—*De Casibus Virorum et Feminarum Illustrium libri IX.*, interesting to the English reader as the original of John Lydgate's *Fall of Princes*; and *De Claris Mulieribus*. To the list of his works ought to be added *Il Ninfale Fiesolano*, a beautiful love-story in verse, and *Il Corbaccio ossia Il Laberinto d'Amore*, a coarse satire on a Florentine widow who had jilted the poet, written about 1355, not to mention many eclogues in Latin and miscellaneous *Rime* in Italian (the latter collected by his biographer Count Baldelli in 1802).

In 1373 we find Boccaccio again settled at Certaldo. Here he was attacked by a terrible disease which brought him to the verge of death, and from the consequences of which he never quite recovered. But sickness could not subdue his intellectual vigour. When the Florentines established a chair for the explanation of the *Divina Commedia* in their university, and offered it to Boccaccio, the senescent poet at once undertook the arduous duty. He delivered his first lecture on the 23rd of October 1373. The commentary on part of the *Inferno*, already alluded to, bears witness of his unabated power of intellect. In 1374 the news of the loss of his dearest friend Petrarch reached Boccaccio, and from this blow he may be said to have never recovered. Almost his dying efforts were devoted to the memory of his friend; urgently he entreated Petrarch's son-in-law to arrange the publication of the deceased poet's Latin epic *Africa*, a work of which the author had been far more proud than of his immortal sonnets to Laura.

In his last will Boccaccio left his library to his father confessor, and after his decease to the convent of Santo Spirito in Florence. His small property he bequeathed to his brother Jacopo. His own natural children had died before him. He himself died on the 21st of December 1375 at Certaldo, and was buried in the

church of SS. Jacopo e Filippo of that town. On his tombstone was engraved the epitaph composed by himself shortly before his death. It is calm and dignified, worthy indeed of a great life with a great purpose. These are the lines—

"Hac sub mole jacent cineres ac ossa Joannis;
Mens sedet ante Deum, meritis ornata laborum
Mortalis vitæ. Genitor Boccaccius illi;
Patria Certaldum; studium fuit alma poesis."

A complete edition of Boccaccio's Italian writings, in 17 vols., was published by Moutier (Florence, 1834). The life of Boccaccio has been written by Tiraboschi, Mazzuoli, Count Baldelli (*Vita di Boccaccio*, Florence, 1806), and others. In English the best biography is Edward Hutton (1909). The first printed edition of the *Decameron* is without date, place or printer's name; but it is believed to belong to the year 1469 or 1470, and to have been printed at Florence. Besides this, Baldelli mentions eleven editions during the 15th century. The entire number of editions by far exceeds a hundred. A curious expurgated edition, authorized by the pope, appeared at Florence, 1573. Here, however, the grossest indecencies remain, the chief alteration being the change of the improper personages from priests and monks into laymen. The best old edition is that of Florence, 1527. Of modern reprints, that by Forster (Florence, 1857) deserves mention. Manni has written a *Storia del Decamerone* (1742), and a German scholar, M. Landau, who published (Vienna, 1869) a valuable investigation of the sources of the *Decameron*, subsequently brought out in 1877 a general study of Boccaccio's life and works. An interesting English translation of the *Decameron* appeared in 1624, under the title *The Model of Mirth, Wit, Eloquence and Conversation*. (F. H.)

BOCCALINI, TRAJANO (1556-1613), Italian satirist, was born at Loretto in 1556. The son of an architect, he himself adopted that profession, and it appears that he commenced late in life to apply to literary pursuits. Pursuing his studies at Rome, he had the honour of teaching Bentivoglio, and acquired the friendship of the cardinals Gaetano and Borghesi, as well as of other distinguished personages. By their influence he obtained various posts, and was even appointed by Gregory XIII. governor of Benevento in the states of the church. Here, however, he seems to have acted imprudently, and he was soon recalled to Rome, where he shortly afterwards composed his most important work, the *Raggugli di Parnaso*, in which Apollo is represented as receiving the complaints of all who present themselves, and distributing justice according to the merits of each particular case. The book is full of light and fantastic satire on the actions and writings of his eminent contemporaries, and some of its happier hits are among the hackneyed felicities of literature. To escape, it is said, from the hostility of those whom his shafts had wounded, he returned to Venice, and there, according to the register in the parochial church of Sta Maria Formosa, died of colic, accompanied with fever, on the 16th of November 1613. It was asserted, indeed, by contemporary writers that he had been beaten to death with sand-bags by a band of Spanish bravados, but the story seems without foundation. At the same time, it is evident from the *Piedra del Paragone*, which appeared after his death in 1615, that whatever the feelings of the Spaniards towards him, he cherished against them feelings of the bitterest hostility. The only government, indeed, which is exempt from his attacks is that of Venice, a city for which he seems to have had a special affection.

The *Raggugli*, first printed in 1612, has frequently been republished. The *Piedra* has been translated into French, German, English and Latin; the English translator was Henry, earl of Monmouth; his version being entitled *The Poetical Touchstone* (London, 1674). Another posthumous publication of Boccacini was his *Commentarii sopra Cornelio Tacito* (Geneva, 1669). Many of his manuscripts are preserved still unprinted.

BOCCHERINI, LUIGI (1743-1805), Italian composer, son of an Italian bass-player, was born at Lucca, and studied at Rome, where he became a fine cellist, and soon began to compose. He returned to Lucca, where for some years he was prominent as a player, and there he produced two oratorios and an opera. He toured in Europe, and in 1768 was received in Paris by Gossec and his circle with great enthusiasm, his instrumental pieces being highly applauded; and from 1769 to 1785 he held the post of "composer and virtuoso" to the king of Spain's brother, the infante Luis, at Madrid. He afterwards became "chamber-composer" to King Frederick William II. of Prussia, till 1797,

when he returned to Spain. He died at Madrid on the 28th of May 1805.

As an admirer of Haydn, and a voluminous writer of instrumental music, chiefly for the violoncello, Boccherini represents the effect of the rapid progress of a new art on a mind too refined to be led into crudeness, too inventive and receptive to neglect any of the new artistic resources within its cognizance, and too superficial to grasp their real meaning. His mastery of the violoncello, and his advanced sense of beauty in instrumental tone-colour, must have made even his earlier works seem to contemporaries at least as novel and mature as any of those experiments at which Haydn, with eight years more of age and experience, was labouring in the development of the true new forms. Most of Boccherini's technical resources proved useless to Haydn, and resemblances occur only in Haydn's earliest works (e.g. most of the slow movements of the quartets in *op.* 3 and in some as late as *op.* 17); whichever derived the characteristics of such movements from the other, the advantage is decidedly with Boccherini. But the progress of music did not lie in the production of novel beauties of instrumental tone in a style in which polyphonic organization was either deliberately abandoned or replaced by a pleasing illusion, while the form in its larger aspects was a mere inorganic amplification of the old suite-forms, which presupposed a genuine polyphonic organization as the vitalizing principle of their otherwise purely decorative nature. The true tendency of the new sonata forms was to make instrumental music dramatic in its variety and contrasts, instead of merely decorative. Haydn from the outset buried himself with the handling of new rhythmic proportions; and if it is hardly an exaggeration to say that the surprising beauty of colour in such a specimen of Boccherini's 125 string-quintets as that in E major (containing the popular minuet) is perhaps more modern and certainly safer in performance than any special effect Haydn ever achieved, it is nevertheless true that even this beauty fails to justify the length and monotony of the work. Where Haydn uses any fraction of the resources of such a style, the ultimate effect is in proportion to a purpose of which Boccherini, with all his genuine admiration of his elder brother in art, could form no conception. Boccherini's works are, however, still indispensable for violoncellists, both in their education and their concert repertoires; and his position in musical history is assured as that of the most original and, next to Tartini, perhaps the greatest writer of music for stringed instruments in the late Italian amplifications of the older quasi-polyphonic sonata or suite-form that survived into the beginning of the 19th century in the works of Nardini. Boccherini may safely be regarded as its last real master. He was wittily characterized by the contemporary violinist Puppo as "the wife of Haydn"; which is very true, if man and woman are two different species; but not as true as e.g. the equally common saying that "Schubert is the wife of Beethoven," and still less true than that "Vittoria is the wife of Palestrina."

His life, with a *Catalogue raisonné*, was published by L. Picquot (1851).

BOCCHUS, king of Mauretania (about 110 B.C.), and father-in-law of Jugurtha. In 108 he vacillated between Jugurtha and the Romans, and joined Jugurtha only on his promising him the third part of his kingdom. The two kings were twice defeated. Bocchus again made overtures to the Romans, and after an interview with Sulla, who was Marius's quaestor at that time, sent ambassadors to Rome. At Rome the hope of an alliance was encouraged, but on condition that Bocchus showed himself deserving of it. After further negotiations with Sulla, he finally agreed to send a message to Jugurtha requesting his presence. Jugurtha fell into the trap and was given up to Sulla. Bocchus concluded a treaty with the Romans, and a portion of Numidia was added to his kingdom. Further to conciliate the Romans and especially Sulla, he sent to the Capitol a group of Victories guarding a device in gold showing Bocchus handing over Jugurtha to Sulla.

See JUGURTHA; also Sallust, *Jugurtha*, 80-120; Plutarch, *Marius*, 8-32; Sulla, 3; A. H. J. Greenidge, *History of Rome* (London, 1904).

His son, Bocchus, was king of Mauretania, jointly with a

younger brother Bogud. As enemies of the senatorial party, their title was recognized by Caesar (49 B.C.). During the African war they invaded Numidia and conquered Cirta, the capital of the kingdom of Juba, who was thus obliged to abandon the idea of joining Metellus Scipio against Caesar. At the end of the war, Caesar bestowed upon Bocchus part of the territory of Massinissa, Juba's ally, which was recovered after Caesar's murder by Massinissa's son Arabion. Dio Cassius says that Bocchus sent his sons to support Sextus Pompeius in Spain, while Bogud fought on the side of Caesar, and there is no doubt that after Caesar's death Bocchus supported Octavian, and Bogud Antony. During Bogud's absence in Spain, his brother seized the whole of Numidia, and was confirmed sole ruler by Octavian. After his death in 33, Numidia was made a Roman province.

Bell. Afric., 25; Dio Cassius xli. 42, xliii. 36, xlviii. 45; Appian, *Bell. Civ.* ii. 96, iv. 54.

BOCHART, SAMUEL (1599-1667), French scholar, was born at Rouen on the 30th of May 1599. He was for many years a pastor of a Protestant church at Caen, and became tutor to Wentworth Dillon, earl of Roscommon. In 1646 he published his *Phaleg and Chanaan* (Caen, 1646 and 1651), the two parts of his *Geographia Sacra*. His *Hierozoicon*, which treats of the animals of Scripture, was printed in London (2 vols., 1663). In 1652 Christina of Sweden invited him to Stockholm, where he studied the Arabian manuscripts in the queen's possession. He was accompanied by Pierre Daniel Huet, afterwards bishop of Avranches. On his return to Caen he was received into the academy of that city. Bochart was a man of profound erudition; he possessed a thorough knowledge of the principal Oriental languages, including Hebrew, Syriac, Chaldaic and Arabic; and at an advanced age he wished to learn Ethiopic. He was so absorbed in his favourite study, that he saw Phoenician and nothing but Phoenician in everything, even in Celtic words, and hence the number of chimerical etymologies which swarm in his works. He died at Caen on the 16th of May 1667.

A complete edition of his works was published at Leiden, under the title of *Sam. Bochart Opera Omnia* (1675, 2 vols. folio; 4th ed., 3 vols., 1712). An *Essay on the Life and Writings of Samuel Bochart*, by W. R. Whittingham, appeared in 1829.

BOCHOLT, a town of Germany, in the Prussian province of Westphalia, near the frontier of Holland, 12 m. by rail north of Wesel. It is a seat of the cotton industry. Pop. (1900) 21,278.

BOCHUM, a town of Germany, in the Prussian province of Westphalia, 11 m. by rail west from Dortmund. Pop. (1905) 118,000. It is a centre of the iron and steel industries, producing principally cast steel, cast iron, iron pipes, wire and wire ropes, and lamps, with tin and zinc works, coal-mining, factories for carpets, calcium carbide and paper-roofing, brickworks and breweries. The Bochumer Verein für Bergbau (mining) und Gusstahl Fabrication (steel manufacture) is one of the principal trusts in this industry, founded in 1854. There are a mining and a metallurgical school.

BÖCKH, PHILIPP AUGUST (1785-1867), German classical scholar and antiquarian, was born in Karlsruhe on the 24th of November 1785. He was sent to the gymnasium of his native place, and remained there until he left for the university of Halle (1803), where he devoted himself to the study of theology. F. A. Wolf was then creating there an enthusiasm for classical studies; Böckh fell under the spell, passed from theology to philology, and became the greatest of all Wolf's scholars. In 1807 he established himself as privat-docent in the university of Heidelberg and was shortly afterwards appointed a professor extraordinary, becoming professor two years later. In 1811 he removed to the new Berlin University, having been appointed professor of eloquence and classical literature. He remained there till his death on the 3rd of August 1867. He was elected a member of the Academy of Sciences of Berlin in 1814, and for a long time acted as its secretary. Many of the speeches contained in his *Kleine Schriften* were delivered in this latter capacity.

Böckh worked out the ideas of Wolf in regard to philology,

and illustrated them by his practice. Discarding the old notion that philology consisted in a minute acquaintance with words and the exercise of the critical art, he regarded it as the entire knowledge of antiquity, historical and philosophical. He divides philology into five parts: first, an inquiry into public acts, with a knowledge of times and places, into civil institutions, and also into law; second, an inquiry into private affairs; third, an exhibition of the religions and arts of the ancient nations; fourth, a history of all their moral and physical speculations and beliefs, and of their literatures; and fifth, a complete explanation of the language. These ideas in regard to philology Böckh set forth in a Latin oration delivered in 1822 (*Gesammelte kleine Schriften*, i.). In his speech at the opening of the congress of German philologists in 1850, he defined philology as the historical construction of the entire life—therefore, of all forms of culture and all the productions of a people in its practical and spiritual tendencies. He allows that such a work is too great for any one man; but the very infinity of subjects is the stimulus to the pursuit of truth, and men strive because they have not attained (ib. ii.). An account of Böckh's division of philology will be found in Freund's *Wie studirt man Philologie?*

From 1806 till his death Böckh's literary activity was unceasing. His principal works were the following:—(1) An edition of Pindar, the first volume of which (1811) contains the text of the Epinician odes; a treatise, *De Metris Pindari*, in three books; and *Notae Criticae*: the second (1819) contains the *Scholiaz*; and part ii. of volume ii. (1821) contains a Latin translation, a commentary, the fragments and indices. It is still the most complete edition of Pindar that we have. But it was especially the treatise on the metres which placed Böckh in the first rank of scholars. This treatise forms an epoch in the treatment of the subject. In it the author threw aside all attempts to determine the Greek metres by mere subjective standards, pointing out at the same time the close connexion between the music and the poetry of the Greeks. He investigated minutely the nature of Greek music as far as it can be ascertained, as well as all the details regarding Greek musical instruments; and he explained the statements of the ancient Greek writers on rhythm. In this manner he laid the foundation for a scientific treatment of Greek metres. (2) *Die Staatshaushaltung der Athener*, 1817 (2d ed. 1851, with a supplementary volume *Urkunden über das Sesswesen des attischen Staats*; 3rd ed. by Fränkel, 1886), translated into English by Sir George Cornewall Lewis (1828) under the title of *The Public Economy of Athens*. In it he investigated a subject of peculiar difficulty with profound learning. He amassed information from the whole range of Greek literature, carefully appraised the value of the information given, and shows throughout every portion of it rare critical ability and insight. A work of a similar kind was his *Metrolologische Untersuchungen über Gewichte, Münzfüsse, und Masse des Alterthums* (1838). (3) Böckh's third great work arose out of his second. In regard to the taxes and revenue of the Athenian state he derived a great deal of his most trustworthy information from inscriptions, many of which are given in his book. It was natural, therefore, that when the Berlin Academy of Sciences projected the plan of a *Corpus Inscriptionum Graecarum*, Böckh should be chosen as the principal editor. This great work (1828–1877) is in four volumes, the third and fourth volumes being edited by J. Franz, E. Curtius, A. Kirchhoff and H. Röhl.

Böckh's activity was continually digressing into widely different fields. He gained for himself a foremost position amongst the investigators of ancient chronology, and his name occupies a place by the side of those of Ideler and Mommsen. His principal works on this subject were: *Zur Geschichte der Mondcyklen der Hellenen* (1855); *Epigraphisch-chronologische Studien* (1856); *Über die vierjährigen Sonnenkreise der Alten* (1863); and several papers which he published in the *Transactions of the Berlin Academy*. Böckh also occupied himself with philosophy. One of his earliest papers was on the Platonic doctrine of the world, *De Platonica corporis mundani fabrica* (1809), followed by *De Platonica Systemate Caelestium globorum*

et de vera Imole Astronomiae Philoicae (1810), to which may be added *Manetho und die Hundsternperiode* (1845). In opposition to Otto Gruppe (1804–1876), he denied that Plato affirmed the diurnal rotation of the earth (*Untersuchungen über das kosmische System des Platon*, 1852), and when in opposition to him Grote published his opinions on the subject (Plato and the Rotation of the Earth) Böckh was ready with his reply. Another of his earlier papers, and one frequently referred to, was *Commentatio Academica de simulatae quae Platonis cum Xenophonis interessisse fertur* (1811). Other philosophical writings were *Commentatio in Platonis qui vulgo fertur Minoem* (1806), and *Philolaos' des Pythagoreers Lehren nebst den Bruchstücken* (1819), in which he endeavoured to show the genuineness of the fragments.

Besides his edition of Pindar, Böckh published an edition of the Antigone of Sophocles (1843) with a poetical translation and essays. An early and important work on the Greek tragedians is his *Graecae Tragoediae Principum . . . num ea quae supersunt ei genuina omnia sint et forma primitiva servata* (1808).

The smaller writings of Böckh began to be collected in his lifetime. Three of the volumes were published before his death, and four after (*Gesammelte kleine Schriften*, 1856–1874). The first two consist of orations delivered in the university or academy of Berlin, or on public occasions. The third, fourth, fifth and sixth contain his contributions to the *Transactions of the Berlin Academy*, and the seventh contains his critiques. Böckh's lectures, delivered from 1809–1865, were published by Bratschek under the title of *Encyclopaedia und Methodologie der philologischen Wissenschaften* (2nd ed., Klusmann, 1886). His philological and scientific theories are set forth in Elze, *Über Philologie als System* (1845), and Reichardt, *Die Gliederung der Philologie entwickelt* (1846). His correspondence with Ottfried Müller appeared at Leipzig in 1833. See Sachse, *Erinnerungen an August Böckh* (1868); Stark, in the *Verhandlungen der Würzburger Philologensammlung* (1868); Max Hoffmann, *August Böckh* (1901); and S. Reiter, in *Neue Jahrbücher für das klassische Altertum* (1902), p. 436.

BÖCKLIN, ARNOLD (1827–1901), Swiss painter, was born at Basel on the 16th of October 1827. His father, Christian Frederick Böcklin (b. 1802), was descended from an old family of Schaffhausen, and engaged in the silk trade. His mother, Ursula Lippe, was a native of the same city. In 1846 he began his studies at the Düsseldorf academy under Schirmer, who recognized in him a student of exceptional promise, and sent him to Antwerp and Brussels, where he copied the works of Flemish and Dutch masters. Böcklin then went to Paris, worked at the Louvre, and painted several landscapes; his "Landscape and Ruin" reveals at the same time a strong feeling for nature and a dramatic conception of scenery. After serving his time in the army he set out for Rome in March 1850, and the sight of the Eternal City was a fresh stimulus to his mind. So, too, was the influence of Italian nature and that of the dead pagan world. At Rome he married (June 20, 1853) Angela Rosa Lorenza Pasucci. In 1856 he returned to Munich, and remained there four years. He then exhibited the "Great Park," one of his earliest works, in which he treated ancient mythology with the stamp of individuality, which was the basis of his reputation. Of this period, too, are his "Nymph and Satyr," "Heroic Landscape" (Diana Hunting), both of 1858, and "Sappho" (1859). These works, which were much discussed, together with Lenbach's recommendation, gained him his appointment as professor at the Weimar academy. He held the office for two years, painting the "Venus and Love," a "Portrait of Lenbach," and a "Saint Catherine." He was again at Rome from 1862 to 1866, and there gave his fancy and his taste for violent colour free play in his "Portrait of Mme Böcklin," now in the Basel gallery, in "An Anchorite in the Wilderness" (1863); a "Roman Tavern," and "Villa on the Sea-shore" (1864); this last, one of his best pictures. He returned to Basel in 1866 to finish his frescoes in the gallery, and to paint, besides several portraits, "The Magdalene with Christ" (1868); "Anacreon's Muse" (1869); and "A Castle and Warriors" (1871). His "Portrait of Myself," with Death playing a violin (1873), was painted after his return again to Munich, where he exhibited his famous "Battle of the Centaurs" (in the Basel gallery); "Landscape with Moorish Horsemen" (in the Lucerne gallery); and "A Farm" (1875). From 1876 to 1885 Böcklin was working at Florence, and painted

a "Pieta," "Ulysses and Calypso," "Prometheus," and the "Sacred Grove." From 1886 to 1892 he settled at Zürich. Of this period are the "Naiads at Play," "A Sea Idyll," and "War." After 1892 Böcklin resided at San Domenico, near Florence. An exhibition of his collected works was held at Basel from the 20th of September to the 24th of October 1897. He died on the 16th of January 1901.

His life has been written by Henri Mendelssohn. See also F. Hermann, *Gazette des Beaux Arts* (Paris, 1893); Max Lehra, *Arnold Böcklin, Ein Leitfaden zum Verständniss seiner Kunst* (Munich, 1897); W. Ritter, *Arnold Böcklin* (Gand, 1895); *Katalog der Böcklin Jubiläums Ausstellung* (Basel, 1897). (H. Fr.)

BOCLAND, BOCKLAND or **BOOKLAND** (from A.S. *booc*, book), an original mode of tenure of land, also called charter-land or deed-land. Boclund was folk-land granted to individuals in private ownership by a document (charter or book) in writing, with the signatures of the king and witenagemot; at first it was rarely, if ever, held by laymen, except for religious purposes. Boclund to a certain extent resembled full ownership in the modern sense, in that the owner could grant it in his lifetime, in the same manner as he had received it, by *booc* or book, and also dispose of it by will. (See also **FOLKLAND**.)

BOCSKAY, STEPHEN (ISTVÁN) (1557-1606), prince of Transylvania, the most eminent member of the ancient Bocsokay family, son of György Bocsokay and Krisztina Sulyok, was born at Kolozsvár, Hungary. As the chief councillor of Prince Zsigmond Báthory, he advised his sovereign to contract an alliance with the emperor instead of holding to the Turk, and rendered important diplomatic services on frequent missions to Prague and Vienna. The enmity towards him of the later Báthory princes of Transylvania, who confiscated his estates, drove him to seek protection at the imperial court (1599); but the attempts of the emperor Rudolph II. to deprive Hungary of her constitution and the Protestants of their religious liberties speedily alienated Bocsokay, especially after the terrible outrages inflicted on the Transylvanians by the imperial generals Basta and Belgiojoso from 1602 to 1604. Bocsokay, to save the independence of Transylvania, assisted the Turks; and in 1605, as a reward for his part in driving Basta out of Transylvania, the Hungarian diet, assembled at Modgyes, elected him prince (1605), on which occasion the Ottoman sultan sent a special embassy to congratulate him and a splendid jewelled crown made in Persia. Bocsokay refused the royal dignity, but made skillful use of the Turkish alliance. To save the Austrian provinces of Hungary, the archduke Matthias, setting aside his semi-lunatic imperial brother Rudolph, thereupon entered into negotiations with Bocsokay, and ultimately the peace of Vienna was concluded (June 23, 1606), which guaranteed all the constitutional and religious rights and privileges of the Hungarians both in Transylvania and imperial Hungary. Bocsokay, at the same time, was acknowledged as prince of Transylvania by the Austrian court, and the right of the Transylvanians to elect their own independent princes in future was officially recognized. The fortress of Tokaj and the counties of Bereg, Szatmár and Ugocsa were at the same time ceded to Bocsokay, with reversion to Austria if he should die childless. Simultaneously, at Zsitvatorok, a peace, confirmatory of the peace of Vienna, was concluded with the Turks. Bocsokay survived this signal and unprecedented triumph only a few months. He is said to have been poisoned (December 20, 1606) by his chancellor, Mihály Kátay, who was hacked to bits by Bocsokay's adherents in the market-place of Kassa.

See *Political Correspondence of Stephen Bocsokay* (Hung.), edited by Károly Szábo (Budapest, 1882); Jenő Thury, *Stephen Bocsokay's Rebellion* (Hung.), Budapest, 1899. (R. N. B.)

BODE, JOHANN ELERT (1747-1826), German astronomer, was born at Hamburg on the 19th of January 1747. Devoted to astronomy from his earliest years, he eagerly observed the heavens at a garret window with a telescope made by himself, and at nineteen began his career with the publication of a short work on the solar eclipse of the 5th of August 1766. This was followed by an elementary treatise on astronomy entitled *Anleitung zur Kenntniss des gestirnten Himmels* (1768, 10th ed.

1844), the success of which led to his being summoned to Berlin in 1772 for the purpose of computing ephemerides on an improved plan. There resulted the foundation by him, in 1774, of the well-known *Astronomisches Jahrbuch*, 51 yearly volumes of which he compiled and issued. He became director of the Berlin observatory in 1786, withdrew from official life in 1825, and died at Berlin on the 23rd of November 1826. His works were highly effective in diffusing throughout Germany a taste for astronomy. Besides those already mentioned he wrote:—*Sammlung astronomischer Tafeln* (3 vols., 1776); *Erläuterung der Sternkunde* (1776, 3rd ed. 1808); *Uranographia* (1801), a collection of 20 star-maps accompanied by a catalogue of 17,240 stars and nebulae. In one of his numerous incidental essays he propounded, in 1776, a theory of the solar constitution similar to that developed in 1795 by Sir William Herschel. He gave currency, moreover, to the empirical rule known as "Bode's Law," which was actually announced by Johann Daniel Titius of Wittenberg in 1772. It is expressed by the statement that the proportionate distances of the several planets from the sun may be represented by adding 4 to each term of the series; 0, 3, 6, 12, 24, &c. The irregularity will be noticed of the first term, which should be 14 instead of 0. (See **SOLAR SYSTEM**.)

See J. F. Encke, *Berlin Abhandlungen* (1827), p. xi.; H. C. Schumacher, *Astr. Nach.* v. 255, 367, (1827); Poggenhoff, *Biog. literarisches Handwörterbuch; Allgemeine deutsche Biographie*, iii. 1.

BODEL, JEHAN (died c. 1210), French *trouvère*, was born at Arras in the second half of the 12th century. Very little is known of his life, but in 1205 he was about to start for the crusade when he was attacked by leprosy. In a touching poem called *Le Congé* (pr. by Méon in *Recueil de fabliaux et contes*, vol. i.), he bade farewell to his friends and patrons, and begged for a nomination to a leper hospital. He wrote *Le Jeu de Saint Nicolas*, one of the earliest miracle plays preserved in French (printed in Monmerqué and Michel's *Théâtre français du moyen âge*, 1839, and for the *Soc. des bibliophiles français*, 1831); the *Chanson des Saisnes* (ed. F. Michel 1839), four *pastourelles* (printed in K. Bartsch's *Allfranz. Romanen und Pastourelles*, Leipzig, 1870); and probably, the eight *fabliaux* attributed to an unknown Jean Bodel. The legend of Saint Nicholas had already formed the subject of the Latin *Ludus Sancti Nicolai* of Hilarius. Bodel placed the scene partly on a field of battle in Africa, where the crusaders perish in a hopeless struggle, and partly in a tavern. The piece, loosely connected by the miracle of Saint Nicholas narrated in the prologue, ends with a wholesale conversion of the African king and his subjects. The dialogue in the tavern scenes is written in thieves' slang, and is very obscure. The *Chanson des Saisnes*, Bodel's authorship of which has been called in question, is a *chanson de geste* belonging to the period of decadence, and is really a *roman d'aventures* based on earlier legends belonging to the Charlemagne cycle. It relates the wars of Charlemagne against the Saxons under Guiteclin de Sassoigne (Witiking or Widukind), with the second revolt of the Saxons and their final submission and conversion. Jehan Bodel makes no allusion to Ogier the Dane and many other personages of the Charlemagne cycle, but he mentions the defeat of Roland at Roncevaux. The romance is based on historical fact, but is overlaid with romantic detail. It really embraces three distinct legends—those of the wars against the Saxons, of Charlemagne's rebellious barons, and of Baudouin and Sebille. The earlier French poems on the subject are lost, but the substance of them is preserved in the Scandinavian versions of the Charlemagne cycle (supposed to have been derived from English sources) known as the *Karlamagnussaga* (ed. Unger, Christiania, 1860) and *Keiser Karl Magnus Krønike* (Romantisk Digtning, ed. C. J. Brandt, Copenhagen, 1877).

See also the article on Jehan Bodel by Paulin Paris in *Hist. litt. de la France*, xx. pp. 605-638; Gaston Paris, *Histoire poétique de Charlemagne* (1865); Leon Gautier, *Les Epées françaises* (revised edition, vol. iii. pp. 650-684), where there is a full analysis of the *Chanson des Saisnes* and a bibliography; H. Meyer, in *Ausgaben und Abhandlungen aus . . . der romanischen Philologie* (Marburg, 1883), pp. 1-76, where its relation to the rest of the Charlemagne cycle is discussed.

BODENBACH (Czech *Podmokly*), a town of Bohemia, Austria, 83 m. N.N.E. of Prague by rail. Pop. (1900) 10,782, almost exclusively German. It is situated on the left bank of the Elbe opposite Tetschen, and is an important railway junction, containing also an Austrian and a Saxon custom-house. Bodenbach, which in the middle of the 19th century had only a few hundred inhabitants, has become a very important industrial centre. Its principal manufactures include cotton and woollen goods, earthenware and crockery, chemicals, chicory, chocolate, sweetmeats and preserves, and beer. It has also a very active transit trade.

BODENSTEDT, FRIEDRICH MARTIN VON (1819-1892), German author, was born at Peine, in Hanover, on the 22nd of April 1819. He studied in Göttingen, Munich and Berlin. His career was determined by his engagement in 1841 as tutor in the family of Prince Gallitzin at Moscow, where he gained a thorough knowledge of Russian. This led to his appointment in 1844 as the head of a public school at Tiflis, in Transcaucasia. He took the opportunity of his proximity to Persia to study Persian literature, and in 1851 published a volume of original poetry in oriental guise under the fanciful title, *Die Lieder des Mirza Schaffy* (English trans. by E. d'Estèrre, 1880). The success of this work can only be compared with that of Edward FitzGerald's *Omar Khayyam*, produced in somewhat similar circumstances, but differed from it in being immediate. It has gone through 160 editions in Germany, and has been translated into almost all literary languages. Nor is this celebrity undeserved, for although Bodenstedt does not attain the poetical elevation of FitzGerald, his view of life is wider, more cheerful and more sane, while the execution is a model of grace. On his return from the East, Bodenstedt engaged for a while in journalism, married the daughter of a Hessian officer (Matilde, the *Editha* of his poems), and was in 1854 appointed professor of Slavonic at Munich. The rich stores of knowledge which Bodenstedt brought back from the East were turned to account in two important books, *Die Väter des Kaukasus und ihre Freiheits-Kämpfe gegen die Russen* (1848), and *Tausend und ein Tag im Orient* (1850). For some time Bodenstedt continued to devote himself to Slavonic subjects, producing translations of Pushkin, Lermontov, Turgeniev, and of the poets of the Ukraines, and writing a tragedy on the false Demetrius, and an epic, *Ada die Lesghierin*, on a Circassian theme. Finding, probably, this vein exhausted, he exchanged his professorship in 1858 for one of Early English literature, and published (1858-1860) a valuable work on the English dramatists contemporary with Shakespeare, with copious translations. In 1862 he produced a standard translation of Shakespeare's sonnets, and between 1866 and 1872 published a complete version of the plays, with the help of many coadjutors. In 1867 he undertook the direction of the court theatre at Meiningen, and was ennobled by the duke. After 1873 he lived successively at Altona, Berlin and Wiesbaden, where he died on the 19th of April 1892. His later works consist of an autobiography (1888), successful translations from Hafiz and Omar Khayyam, and lyrics and dramas which added little to his reputation.

An edition of his collected works in 12 vols. was published at Berlin (1866-1869), and his *Erzählungen und Romane* at Jena (1871-1872). For further biographical details, see Bodenstedt's *Erinnerungen aus meinem Leben* (2 vols., Berlin, 1888-1890); and G. Schenck, *Friedrich von Bodenstedt. Ein Dichterleben in seinen Briefen* (Berlin, 1893).

BODHI VAMSA, a prose poem in elaborate Sanskritized Pali, composed by Upatissa in the reign of Mahinda IV. of Ceylon about A.D. 980. It is an adaptation of a previously existing work in Sinhalese on the same subject, and describes the bringing of a branch of the celebrated Bo or Bodhi tree (i.e. Wisdom Tree, under which the Buddha had attained wisdom) to Ceylon in the 3rd century B.C. The Bodhi Vamsa quotes verses from the Mahāvamsa, but draws a great deal of its material from other sources; and it has occasionally preserved details of the older tradition not found in any other sources known to us.

Edition in Pali for the Pali Text Society by S. Arthur Strong (London, 1891).

BODICHON, BARBARA LETIGH SMITH (1827-1891), English educationalist, was born at Watlington, Norfolk, on the 8th of April 1827, the daughter of Benjamin Smith (1783-1860), long M.P. for Norfolk. She early showed a force of character and catholicity of sympathy that later won her a prominent place among philanthropists and social workers. In 1857 she married an eminent French physician, Dr Eugène Bodichon, and, although wintering many years in Algiers, continued to lead the movements she had initiated in behalf of Englishwomen. In 1860 she published her *Brief Summary of the Laws of England concerning Women*, which had a useful effect in helping forward the passage of the Married Women's Property Act. In 1866, co-operating with Miss Emily Davies, she matured a scheme for the extension of university education to women, and the first small experiment at Hitchin developed into Girton College, to which Mme Bodichon gave liberally of her time and money. With all her public interests she found time for society and her favourite art of painting. She studied under William H. Hunt, and her water-colours, exhibited at the Salon, the Academy and elsewhere, showed great originality and talent, and were admired by Corot and Daubigny. Her London salon included many of the literary and artistic celebrities of her day; she was George Eliot's most intimate friend, and, according to her, the first to recognize the authorship of *Adam Bede*. Her personal appearance is said to be described in that of Romola. Mme Bodichon died at Robertsbridge, Sussex, on the 11th of June 1891.

BODIN, JEAN (1530-1596), French political philosopher, was born at Angers in 1530. Having studied law at Toulouse and lectured there on jurisprudence, he settled in Paris as an advocate, but soon applied himself to literature. In 1555 he published his first work, a translation of Oppian's *Cynegeticon* into Latin verse, with a commentary. The celebrated scholar, Turnebus, complained that some of his emendations had been appropriated without acknowledgment. In 1588, in refutation of the views of the seigneur de Malestroit, comptroller of the mint, who maintained that there had been no rise of prices in France during the three preceding centuries, he published his *Responsio ad Paradoxa Malestroiti (Réponse aux paradoxes de M. Malestroit)*, which the first time explained in a nearly satisfactory manner the revolution of prices which took place in the 16th century. Bodin showed a more rational appreciation than many of his contemporaries of the causes of this revolution, and the relation of the variations in money to the market values of wares in general as well as to the wages of labour. He saw that the amount of money in circulation did not constitute the wealth of the community, and that the prohibition of the export of the precious metals was rendered inoperative by the necessities of trade. This tract, the *Discours sur les causes de l'extrême cherté qui est aujourd'hui en France* (1574), and the disquisition on public revenues in the sixth book of the *République*, entitle Bodin to a distinguished position among the earlier economists.

His learning, genial disposition, and conversational powers won him the favor of Henry III. and of his brother, the duc d'Alençon; and he was appointed king's attorney at Laon in 1576. In this year he married, performed his most brilliant service to his country, and completed his greatest literary work. Elected by the *Sters* of Vermandois to represent it in the states-general of Blois, he contended with skill and boldness in extremely difficult circumstances for freedom of conscience, justice and peace. The nobility and clergy favoured the League, and urged the king to force his subjects to profess the Catholic religion. When Bodin found he could not prevent this resolution being carried, he contrived to get inserted in the petition drawn up by the states the clause "without war," which practically rendered nugatory all its other clauses. While he thus resisted the clergy and nobility he successfully opposed the demand of the king to be allowed to alienate the public lands and royal demesnes, although the chief deputies had been won over to assent. This lost him the favour of the king, who wanted money on any terms. In 1581 he acted as secretary to the duc d'Alençon

when that prince came over to England to seek the hand of Queen Elizabeth. Here he had the pleasure of finding that the *République* was studied at London and Cambridge, although in a barbarous Latin translation. This determined him to translate his work into Latin himself (1586). The latter part of Bodin's life was spent at Laon, which he is said to have persuaded to declare for the League in 1580, and for Henry IV. five years afterwards. He died of the plague in 1596, and was buried in the church of the Carmelites.

With all his breadth and liberality of mind Bodin was a credulous believer in witchcraft, the virtues of numbers and the power of the stars, and in 1580 he published the *Démonomanie des sorciers*, a work which shows that he was not exempt from the prejudices of the age. Himself regarded by most of his contemporaries as a sceptic, and by some as an atheist, he denounced all who dared to disbelieve in sorcery, and urged the burning of witches and wizards. It might, perhaps, have gone hard with him if his counsel had been strictly followed, as he confessed to have had from his thirty-seventh year a friendly demon, who, if properly invoked, touched his right ear when he purposed doing what was wrong, and his left when he meditated doing good.

His chief work, the *Six livres de la République* (Paris, 1576), which passed through several editions in his lifetime, that of 1583 having as an appendix *L'Apologie de René Herpin* (Bodin himself), was the first modern attempt to construct an elaborate system of political science. It is perhaps the most important work of its kind between Aristotle and modern writers. Though he was much indebted to Aristotle he used the material to advantage, adding much from his own experience and historical knowledge. In harmony with the conditions of his age, he approved of absolute governments, though at the same time they must, he thought, be controlled by constitutional laws. He entered into an elaborate defence of individual property against Plato and More, rather perhaps because the scheme of his work required the treatment of that theme than because it was practically urgent in his day, when the excesses of the Anabaptists had produced a strong feeling against communistic doctrines. He was under the general influence of the mercantilist views, and approved of energetic governmental interference in industrial matters, of high taxes on foreign manufactures and low duties on raw materials and articles of food, and attached great importance to a dense population. But he was not a blind follower of the system; he wished for unlimited freedom of trade in many cases; and he was in advance of his more eminent contemporary Montaigne in perceiving that the gain of one nation is not necessarily the loss of another. To the public finances, which he called "the sinews of the state," he devoted much attention, and insisted on the duties of the government in respect to the right adjustment of taxation. In general he deserves the praise of steadily keeping in view the higher aims and interests of society in connexion with the regulation and development of its material life.

Among his other works are *Oratio de instituenda in republica juventute* (1550); *Methodus ad facilem historiarum cognitionem* (1566); *Universale Naturæ Theatrum* (1506, French trans. by Fougerolles, 1597), and the *Colloquium Heptaplomeres de abditis rerum sublimium arcanis*, written in 1588, published first by Guhrauer (1841), and in a complete form by L. Noack (1857). The last is a philosophy of naturalism in the form of a conversation between seven learned men—a Jew, a Mahomedan, a Lutheran, a Zwinglian, a Roman Catholic, an Epicurean and a Theist. The conclusion to which they are represented as coming is that they will live together in charity and toleration, and cease from further disputation as to religion. It is curious that Leibnitz, who originally regarded the *Colloquium* as the work of a professed enemy of Christianity, subsequently described it as a most valuable production (cf. M. Carrière, *Wellenschaunung*, p. 317).

See H. Baudrillart, *J. Bodin et son temps* (Paris, 1853); Ad. Franck, *Réformateurs et publicistes de l'Europe* (Paris, 1864); N. Planchenault, *Études sur Jean Bodin* (Angers, 1858); E. de Barthé-

lemy, *Étude sur J. Bodin* (Paris, 1876); for the political philosophy of Bodin, see P. Janet, *Hist. de la science polit.* (3rd ed., Paris, 1887); Haucke, *B. Studien über d. Begriff d. Souveränität* (Breslau, 1894); A. Bardoux, *Les Légistes et leur influence sur le soc. française*; Fournel, *Bodin précurseur de Montesquieu* (Paris, 1896); for his political economy, J. K. Ingram, *Hist. of Pol. Econ.* (London, 1888); for his ethical teaching, A. Desjardins, *Les Moralistes français du seizième siècle*, ch. v.; and for his historical views, R. Flint's *Philosophy of History in Europe* (ed. 1893), pp. 190 foll.

BODKIN (Early Eng. *boydekin*, a dagger, a word of unknown origin, possibly connected with the Gaelic *biodag*, a short sword), a small, needle-like instrument of steel or bone with a flattened knob at one end, used in needlework. It has one or more slits or eyes, through which cord, tape or ribbon can be passed, for threading through a hem or series of loops. The word is also used of a small piercing instrument for making holes in cloth, &c.

BODLE or **BOODLE** (said to be from Bothwell, the name of a mint-master), a Scottish copper coin worth about one-sixth of an English penny, first issued under Charles II. It survives in the phrase "not to care a bodle."

BODLEY, GEORGE FREDERICK (1827-1907), English architect, was the youngest son of a physician at Brighton, his elder brother, the Rev. W. H. Bodley, becoming a well-known Roman Catholic preacher and a professor at Oscott. He was articled to the famous architect Sir Gilbert Scott, under whose influence he became imbued with the spirit of the Gothic revival, and he gradually became known as the chief exponent of 14th-century English Gothic, and the leading ecclesiastical architect in England. One of his first churches was St Michael and All Angels, Brighton (1855), and among his principal erections may be mentioned All Saints, Cambridge; Eton Mission church, Hackney Wick; Clumber church; Ecclestone church; Hoar Cross church; St Augustine's, Pendlebury; Holy Trinity, Kensington; Chapel Allerton, Leeds; St Faith's, Brentford; Queen's College chapel, Cambridge; Marlborough College chapel; and Burton church. His domestic work included the London School Board offices, the new buildings at Magdalen, Oxford, and Hewell Grange (for Lord Windsor). From 1872 he had for twenty years the partnership of Mr T. Garner, who worked with him. He also designed (with his pupil James Vaughan) the cathedral at Washington, D.C., U.S.A., and cathedrals at San Francisco and in Tasmania; and when Mr Gilbert Scott's design for his new Liverpool cathedral was successful in the competition he collaborated with the young architect in preparing for its erection. Bodley began contributing to the Royal Academy in 1854, and in 1881 was elected A.R.A., becoming R.A. in 1902. In addition to being a most learned master of architecture, he was a beautiful draughtsman, and a connoisseur in art; he published a volume of poems in 1899; and he was a designer of wall-papers and chintzes for Watts & Co., of Baker Street, London; in early life he had been in close alliance with the Pre-Raphaelites, and he did a great deal, like William Morris, to improve public taste in domestic decoration and furniture. He died on the 21st of October 1907, at Water Eaton, Oxford.

BODLEY, SIR THOMAS (1545-1613), English diplomatist and scholar, founder of the Bodleian library, Oxford, was born at Exeter on the 2nd of March 1545. During the reign of Queen Mary, his father, John Bodley, being obliged to leave the kingdom on account of his Protestant principles, went to live at Geneva. In that university, in which Calvin and Beza were then teaching divinity, young Bodley studied for a short time. On the accession of Queen Elizabeth he returned with his father to England, and soon after entered Magdalen College, Oxford. In 1563 he took his B.A. degree, and was admitted a fellow of Merton College. In 1565 he read a Greek lecture in hall, took his M.A. degree the year after, and read natural philosophy in the public schools. In 1569 he was proctor, and for some time after was deputy public orator. Quitting Oxford in 1576, he made the tour of Europe; shortly after his return he became gentleman-usher to Queen Elizabeth; and in 1587, apparently, he married Ann Ball, a widow lady of considerable fortune, the daughter of a Mr Carew of Bristol. In 1584 he entered parliament as member for Portsmouth, and represented St German's in 1586. In 1585 Bodley was entrusted

with a mission to form a league between Frederick II. of Denmark and certain German princes to assist Henry of Navarre. He was next despatched on a secret mission to France; and in 1588 he was sent to the Hague as minister, a post which demanded great diplomatic skill, for it was in the Netherlands that the power of Spain had to be fought. The essential difficulties of his mission were complicated by the intrigues of the queen's ministers at home, and Bodley repeatedly begged that he might be recalled. He was finally permitted to return to England in 1596, but finding his preferment obstructed by the jarring interests of Burleigh and Essex, he retired from public life. He was knighted on the 18th of April 1604. He is, however, remembered specially as the founder of the Bodleian at Oxford, practically the earliest public library in Europe (see LIBRARIES). He determined, he said, "to take his farewell of state employments and to set up his staff at the library door in Oxford." In 1598 his offer to restore the old library was accepted by the university. Bodley not only used his private fortune in his undertaking, but induced many of his friends to make valuable gifts of books. In 1611 he began its permanent endowment, and at his death in London on the 28th of January 1613, the greater part of his fortune was left to it. He was buried in the choir of Merton College chapel where a monument of black and white marble was erected to him.

See Thomas wrote his own life to the year 1609, which, with the first draft of the statutes drawn up for the library, and his letters to the librarian, Thomas James, was published by Thomas Hearne, under the title of *Reliquiae Bodleianae, or Authentic Remains of Sir Thomas Bodley* (London, 1703, 8vo).

BODMER, JOHANN JAKOB (1608-1783), Swiss-German author, was born at Greifensee, near Zürich, on the 19th of July 1608. After first studying theology and then trying a commercial career, he finally found his vocation in letters. In 1725 he was appointed professor of Helvetian history in Zürich, a chair which he held for half a century, and in 1735 became a member of the "Grosser Rat." He published (1721-1723), in conjunction with J. J. Breitinger (1701-1774; and several others, *Die Discourse der Mähren*, a weekly journal after the model of the *Spectator*. Through his prose translation of Milton's *Paradise Lost* (1732) and his successful endeavours to make a knowledge of English literature accessible to Germany, he aroused the hostile criticism of Gottsched (q.v.) and his school, a struggle which ended in the complete discomfiture of the latter. His most important writings are the treatises *Von dem Wunderbaren in der Poesie* (1740) and *Kritische Betrachtungen über die poetischen Gemälde der Dichter* (1741), in which he pleaded for the freedom of the imagination from the restriction imposed upon it by French pseudo-classicism. Bodmer's epics *Die Sündfluth* (1751) and *Nesé* (1751) are weak imitations of Klopstock's *Messias*, and his plays are entirely deficient in dramatic qualities. He did valuable service to German literature by his editions of the Minnesingers and part of the *Nibelungenlied*. He died at Zürich on the 2nd of January 1783.

See T. W. Danzel, *Gottsched und seine Zeit* (Leipzig, 1848); J. Cruzer, *J. C. Gottsched, Bodmer und Breitinger* (Stuttgart, 1884); F. Bräunmayer, *Geschichte der poetischen Theorie und Kritik von den Dichtern der Maler bis auf Lessing* (Leipzig, 1888); *Denkschrift zu Bodmers 200. Geburtstag* (Zürich, 1900).

BODMIN, a market town and municipal borough in the Bodmin parliamentary division of Cornwall, England, the county town, 304 m. W.N.W. of Plymouth, on branches of the Great Western and London & South-Western railways. Pop. (1901) 5353. It lies between two hills in a short valley opening westward upon that of the Camel, at the southern extremity of the high open Bodmin Moor. The large church of St Petrock, mainly perpendicular, has earlier portions, and a late Norman font. East of it there is a ruined Decorated chapel of St Thomas of Canterbury, with a crypt. A tower of Tudor date, in the cemetery, marks the site of a chapel of the gild of the Holy Rood. Part of the buildings of a Franciscan friary, founded c. 1240, are incorporated in the market-house, and the gateway remains in an altered form. At Bodmin are a prison, with civil and naval departments, the county gaol and asylum, the headquarters of the constabulary, and those of the duke of Cornwall's

Light Infantry. Cattle, sheep and horse fairs are held, and there is a considerable agricultural trade. The borough is under a mayor, four aldermen and twelve councillors. Area, 2797 acres.

Traces of Roman occupation have been found in the western part of the parish, belonging to the first century A.D. Possibly tin-mining was carried on here at that period. The grant of a charter by King Edred to the prior and canons of Bodmin (Bomine, Bodman, Bodmyn) in respect of lands in Devonshire appears in an *insperimus* of 1252. To its ecclesiastical associations it owed its importance at the time of the Domesday survey, when St Petrock held the manor of Bodmin, wherein were sixty-eight houses and one market. To successive priors, as meane lords, it also owed its earliest municipal privileges. King John's charter to the prior and convent, dated the 17th of July 1199, contained a clause (subsequently cancelled by Richard II.) by which burgesses were exempt from being impleaded, touching any tenements in their demesne, except before the king and his chief justice. Richard of Cornwall, king of the Romans, confirmed to the burgesses their gild merchant, Edward I. the pesage of tin, and Edward II. a market for tin and wool. Queen Elizabeth in 1563 constituted the town a free borough and the burgesses a body corporate, granting at the same time two fairs and a Saturday market. There are still held also three other fairs whose origin is uncertain. An amended charter granted in 1594 remained in force until 1789, when the corporation became extinct owing to the diminution of the burgesses. By virtue of a new charter of incorporation granted in 1798 and remodelled by the act of 1835, the corporation now consists of a mayor, four aldermen and twelve councillors. The first members for Bodmin were summoned in 1295. Retaining both its members in 1832, losing one in 1868 and the other in 1885, it has now become merged in the south-eastern division of the county. From 1715 to 1837 the assizes were generally held alternately at Launceston and Bodmin; since 1837 they have been held at Bodmin only. A court of probate has also been held at Bodmin since 1773. A festival known as "Bodmin Riding" was formerly celebrated here on the Sunday and Monday following St Thomas's day (July 7). It is thought by some to have been instituted in 1177 to celebrate the recovery of the bones of St Petrock.

See *Victoria County History, Cornwall*; Sir John Maclean, *Parochial and Family History of the Deanery of Trigg Minor, Cornwall* (3 vols., 1873-1879).

BODŌ, a seaport on the north-western coast of Norway, in Nordland amt (county), lat. 67° 17' N. Pop. (1900) 4827. The rock-bound harbour admits large vessels, and there is a brisk trade in fish and eider-down. The neighbouring country has many scenic attractions. Sixty miles inland (E.) rises the great massif of Sulitelma on the Swedish frontier, with its copper mines, broad snow-fields and glaciers. The fjords of the district include the imposing Beierenfjord, the Saltenfjord, and the Skjerstadfjord, at the narrow mouths of which, between islands, a remarkable cataract (Salström) is formed at the turn of the tide. On this fjord is Skjerstad, a large scattered village.

BODONI, GIAMBATTISTA (1740-1813), Italian printer, was born in 1740 at Saluzzo in Piedmont, where his father owned a printing establishment. While yet a boy he began to engrave on wood. He at length went to Rome, and there became a compositor for the press of the Propaganda. He made himself acquainted with the Oriental languages, and thus was enabled to render essential service to the Propaganda press, by restoring and accurately distributing the types of several Oriental alphabets which had fallen into disorder. The infant Don Ferdinand, afterwards duke of Parma, having established, about 1760, a printing-house on the model of those in Paris, Madrid and Turin, Bodoni was placed at the head of this establishment, which he soon rendered the first of the kind in Europe. The beauty of his typography, &c., leaves nothing further to be desired; but the intrinsic value of his editions is seldom equal to their outward splendour. His *Hotter*, however, is a truly magnificent work; and, indeed, his Greek letters are faultless imitations of the best

Greek manuscript. His editions of the Greek, Latin, Italian and French classics are all highly prized for their typographical elegance, and some of them are not less remarkable for their accuracy. Bodoni died at Padua in 1813. In 1818 a magnificent work appeared in two volumes quarto, entitled *Manuale Tipografico*, containing specimens of the vast collection of types which had belonged to him.

See De Lama, *Vita del Cavaliere Giambattista Bodoni* (1816).

BODY-SNATCHING, the secret disinterring of dead bodies in churchyards in order to sell them for the purpose of dissection. Those who practised body-snatching were frequently called resurrectionists or resurrection-men. Previous to the passing of the Anatomy Act 1832 (see **ANATOMY: HISTORY**), no licence was required in Great Britain for opening an anatomical school, and there was no provision for supplying subjects to students for anatomical purposes. Therefore, though body-snatching was a misdemeanour at common law, punishable with fine and imprisonment, it was a sufficiently lucrative business to run the risk of detection. Body-snatching became so prevalent that it was not unusual for the relatives and friends of a deceased person to watch the grave for some time after burial, lest it should be violated. Iron coffins, too, were frequently used for burial, or the graves were protected by a framework of iron bars called *mortsafes*, well-preserved examples of which may still be seen in Greyfriars' churchyard, Edinburgh.

For a detailed history of body-snatching, see *The Diary of a Resurrectionist*, edited by J. B. Bailey (London, 1896), which also contains a full bibliography and the regulations in force in foreign countries for the supply of bodies for anatomical purposes.

BOECE (or **BOVCE**), **HECTOR** (c. 1465 - c. 1536), Scottish historian, was born at Dundee about the year 1465, being descended of a family which for several generations had possessed the barony of Panbride in Forfarshire. He received his early education at Dundee, and completed his course of study in the university of Paris, where he took the degree of B.D. He was appointed regent, or professor, of philosophy in the college of Montaigu; and there he was a contemporary of Erasmus, who in two epistles has spoken of him in the highest terms. When William Elphinstone, bishop of Aberdeen, was laying his plans for the foundation of the university of Aberdeen (King's College) he made Boece his chief adviser; and the latter was persuaded, after receipt of the papal bull erecting the university (1494), to be the first principal. He was in Aberdeen about 1500 when lectures began in the new buildings, and he appears to have been well received by the canons of the cathedral, several of whom he has commemorated as men of learning. It was a part of his duty as principal to read lectures on divinity.

The emoluments of his office were poor, but he also enjoyed the income of a canonry at Aberdeen and of the vicarage of Tullynessle. Under the date of 14th July 1527, we find a "grant to Maister Hector" of an annual pension of £50, to be paid by the sheriff of Aberdeen out of the king's casualties; and on the 26th of July 1529 was issued a "precept for a letter to Mr Hector Boys, professor of theology, of a pension of £50 Scots yearly, until the king promote him to a benefice of 100 marks Scots of yearly value; the said pension to be paid him by the customars of Aberdeen." In 1533 and 1534, one-half of his pension was, however, paid by the king's treasurer, and the other half by the comptroller; and as no payment subsequent to that of Whitsuntide 1534 has been traced in the treasurer's accounts, he is supposed to have obtained the benefice soon after that period. This benefice was the rectory of Tyrie.

In 1528, soon after the publication of his history, Boece received the degree of D.D. at Aberdeen; and on this occasion the magistrates voted him a present of a tun of wine when the new wines should arrive, or, according to his option, the sum of £20 to purchase bonnets. He appears to have survived till the year 1536; for on the 22nd of November in that year, the king presented John Garden to the rectory of Tyrie, vacant by the death of "Mr Hector Boiss." He died at Aberdeen, and was buried before the high altar at King's College, beside the tomb of his patron Bishop Elphinstone.

His earliest publication, *Episcoporum Morthlacensium et Aberdonensium per Hectorem Bodium Vitae*, was printed at the press of Jodocus Badius (Paris, 1522). The notices of the early prelates are of little value, but the portion of the book in which he speaks of Bishop Elphinstone is of enduring merit. Here we likewise find an account of the foundation and constitution of the college, together with some notices of its earliest members. His fame rests chiefly on his *History of Scotland*, published in 1527 under the title *Scotorum Historiae a prima gentis origine cum aliarum et rerum et gentium illustratione non vulgari*. This edition contains seventeen books. Another edition, containing the eighteenth book and a fragment of the nineteenth, was published by Ferrerius, who has added an appendix of thirty-five pages (Paris, 1574).

The composition of the history displays much ability; but Boece's imagination was, however, stronger than his judgment: of the extent of the historian's credulity, his narrative exhibits many unequivocal proofs; and of deliberate invention or distortion of facts not a few, though the latter are less flagrant and intentional than early 17th-century criticism has assumed. He professed to have obtained from the monastery of Icolmkill, through the good offices of the earl of Argyll, and his brother, John Campbell of Lundy, the treasurer, certain original historians of Scotland, and among the rest Veremundus, of whose writings not a single vestige is now to be found. In his dedication to the king he is pleased to state that Veremundus, a Spaniard by birth, was archdeacon of St Andrews, and that he wrote in Latin a history of Scotland from the origin of the nation to the reign of Malcolm III., to whom he inscribed his work. His propensity to the marvellous was at an early period exposed in the following verses by Leland:—

"Hectoris historici tot quot mendacia scripsit
Si via ut numerem, lector amice, tibi,
Me jubens etiam fluctus numerare marinos
Et liquidi stellas connumerare poli."

Boece's *History of Scotland* was translated into Scottish prose by John Bellenden, and into verse by William Stewart. *The Lives of the Bishops* was reprinted for the Bannatyne Club, Edin., 1823, in a limited edition of sixty copies. A commonplace verse-rendering of the *Life of Bishop Elphinstone*, which was written by Alexander Gardyne in 1619, remains in MS. There is no modern edition of the history, though the versions of Bellenden and Stewart have been edited.

BOEHM, SIR JOSEPH EDGAR, Bart. (1834-1890), British sculptor, was born of Hungarian parentage on the 4th of July 1834 at Vienna, where his father was director of the imperial mint. After studying the plastic art in Italy and at Paris, he worked for a few years as a medallist in his native city. After a further period of study in England, he was so successful as an exhibitor at the Exhibition of 1862 that he determined to abandon the execution of coins and medals, and to give his mind to portrait busts and statuettes, chiefly equestrian. The colossal statue of Queen Victoria, executed in marble (1869) for Windsor Castle, and the monument of the duke of Kent in St George's chapel, were his earliest great works, and so entirely to the taste of his royal patrons that he rose rapidly in favour with the court. He was made A.R.A. in 1878, and produced soon afterwards the statue of Carlyle on the Thames embankment at Chelsea. In 1881 he was appointed sculptor in ordinary to the queen, and in the ensuing year became full Academician. On the death of Dean Stanley, Boehm was commissioned to execute his sarcophagus in Westminster Abbey, and his achievement, a recumbent statue, has been pronounced to be one of the best portraits in modern sculpture. Less successful was his monument to General Gordon in St Paul's cathedral. He executed the equestrian statue of the duke of Wellington at Hyde Park Corner, and designed the coinage for the Jubilee of Queen Victoria in 1887. Among his ideal subjects should be noted the "Herdsman and Bull." He died suddenly in his studio at South Kensington on the 12th of December 1890.

BOEHM VON BAWERK, EUGEN (1851-), Austrian economist and statesman, was born at Brünn on the 12th of February 1851. Entering the Austrian department of finance in 1872, he held various posts until 1890, when he became

qualified as a teacher of political economy in the university of Vienna. The following year, however, he transferred his services to the university of Innsbruck, where he became professor in 1884. In 1889 he became councillor in the ministry of finance, and represented the government in the Lower House on all questions of taxation. In 1895 and again in 1897-1898 he was minister of finance. In 1899 he was made a member of the Upper House, and in 1900 again became minister of finance. One of the leaders of the Austrian school of economists, he has made notable criticisms on the theory of value in relation to cost as laid down by the "classical school." His more important works are *Kapital und Kapitalisten* (Innsbruck, 1884-1889), in two parts, translated by W. Smart, viz. *Capital and Interest* (part I, 1890), and *The Positive Theory of Capital* (part II, 1891); *Karl Marx and the Close of his System* (trans. A. M. Macdonald, 1898); *Recent Literature on Interest* (trans. W. A. Scott and S. Feilbogen, 1903).

BOEHME (or **BEHMEN**), **JAKOB** (1575-1624), German mystical writer, whose surname (of which Fechner gives eight German varieties) appears in English literature as Beem, Behmont, &c., and notably Behmen, was born at Altsidenberg, in Upper Lusatia, a straggling hamlet among the hills, some 10 m. S.E. of Görlitz. His father was a well-to-do peasant, and his first employment was that of herd boy on the Landskrone, a hill in the neighbourhood of Görlitz; the only education he received was at the town-school of Seidenberg, a mile from his home. Seidenberg, to this day, is filled with shoemakers, and to a shoemaker Jakob was apprenticed in his fourteenth year (1589), being judged not robust enough for husbandry. Ten years later (1599) we find him settled at Görlitz as master-shoemaker, and married to Katharina, daughter of Hans Kuntzschmann, a thriving butcher in the town. After industriously pursuing his vocation for ten years, he bought (1610) the substantial house, which still preserves his name, close by the bridge, in the Neiss-Vorstadt. Two or three years later he gave up business, and did not resume it as a shoemaker; but for some years before his death he made and sold woollen gloves, regularly visiting Prague fair for this purpose.

Boehme's authorship began in his 37th year (1612) with a treatise, *Aurora, oder die Morgenröthe im Aufgang*, which though unfinished was surreptitiously copied, and eagerly circulated in MS. by Karl von Ender. This raised him at once out of his homely sphere, and made him the centre of a local circle of liberal thinkers, considerably above him in station and culture. The charge of heresy was, however, soon directed against him by Gregorius Richter, then pastor primarius of Görlitz. Feeling ran so high after Richter's pulpit denunciations, that, in July 1613, the municipal council, fearing a disturbance of the peace, made a show of examining Boehme, took possession of his fragmentary quarto, and dismissed the writer with an admonition to meddle no more with such matters. For five years he obeyed this injunction. But in 1618 began a second period of authorship; he poured forth, but did not publish, treatise after treatise, expository and polemical, in the next and the two following years. In 1622 he composed nothing but a few short pieces on true repentance, resignation, &c., which, however, devotionally speaking, are the most precious of all his writings. They were the only pieces offered to the public in his lifetime and with his permission, a fact which is evidence of the essentially religious and practical character of his mind. Their publication at Görlitz, on New Year's day 1624, under the title of *Der Weg zu Christo*, was the signal for renewed clerical hostility. Boehme had by this time entered on the third and most prolific though the shortest period (1623-1624) of his speculation. His labours at the desk were interrupted in May 1624 by a summons to Dresden, where his famous "colloquy" with the Upper Consistorial court was made the occasion of a flattering but transient ovation on the part of a new circle of admirers. Richter died in August 1624, and Boehme did not long survive his pertinacious foe. Seized with a fever when away from home, he was with difficulty conveyed to Görlitz. His wife was at Dresden on business; and during the first week of his malady he was nursed by a

literary friend. He died, after receiving the rites of the church, grudgingly administered by the authorities, on Sunday, the 17th of November.

Boehme always professed that a direct inward opening or illumination was the only source of his speculative power. He pretended to no other revelation. Ecstatic raptures we should not expect, for he was essentially a Protestant mystic. No "thus saith the Lord" was claimed as his warrant, after the manner of Antoinette Boungnon, or Ludowick Muggleton, no spirits or angels held converse with him as with Swedenborg. It is needless to dwell, in the way either of acceptance or rejection, on the very few occasions in which his outward life seemed to him to come into contact with the invisible world. The apparition of the pail of gold to the herd boy on the Landskrone, the visit of the mysterious stranger to the young apprentice, the fascination of the luminous sheen, reflected from a common pewter dish, which first, in 1600, gave an intuitive turn to his meditations, the heavenly music which filled his ears as he lay dying—none of these matters is connected organically with the secret of his special power. The mysteries of which he discoursed were not reported to him: he "beheld" them. He saw the root of all mysteries, the *Ungrund* or *Urgrund*, whence issue all contrasts and discordant principles, hardness and softness, severity and mildness, sweet and bitter, love and sorrow, heaven and hell. These he "saw" in their origin; these he attempted to describe in their issue, and to reconcile in their eternal result. He saw into the being of God; whence the birth or going forth of the divine manifestation. Nature lay unveiled to him, he was at home in the heart of things. "His own book, which he himself was," the microcosm of man, with his threefold life, was patent to his vision. Such was his own account of his qualification. If he failed it was in expression; he confessed himself a poor mouthpiece, though he saw with a sure spiritual eye.

It must not be supposed that the form in which Boehme's pneumatic realism worked itself out in detail was shaped entirely from within. In his writings we trace the influence of Theophr. Bombast von Hohenheim, known as Paracelsus (1493-1541), of Kaspar Schwenkfeld (1490-1561), the first Protestant mystic, and of Valentin Weigel (1533-1588). From the school of Paracelsus came much of his puzzling phraseology,—his *Turba* and *Tinctur* and so forth,—a phraseology embarrassing to himself as well as to his readers. His friends plied him with foreign terms, which he was delighted to receive, interpreting them by an instinct, and using them often in a corrupted form and always in a sense of his own. Thus the word *Idea* called up before him the image of "a very fair, heavenly, and chaste virgin." The title *Aurora*, by which his earliest treatise is best known, was furnished by Dr Balthasar Walther. These, however, were false helps, which only serve to obscure a difficult study, like the *Flagrat* and *Lusbet*, with which his English translator veiled Boehme's own honest *Schreck* and *Lust*. There is danger lest his crude science and his crude philosophical vocabulary conceal the fertility of Boehme's ideas and the transcendent greatness of his religious insight. Few will take the pains to follow him through the interminable account of his seven *Qualgeister*, which remind us of Gnosticism; or even of his three first properties of eternal nature, in which his disciples find Newton's formulæ anticipated, and which certainly bear a marvellous resemblance to the three *Äpoxal* of Schelling's *Theogonische Natur*. Boehme is always greatest when he breaks away from his fancies and his trammels, and allows speech to the voice of his heart. Then he is artless, clear and strong; and no man can help listening to him, whether he dive deep down with the conviction "ohne Gift und Grimm kein Leben," or rise with the belief that "the being of all beings is a wrestling power," or soar with the persuasion that Love "in its height is as high as God." The mystical poet of Silesia, Angelus Silesius, discerned where Boehme's truest power lay when he sang—

"Im Wasser lebt der Fisch, die Pflanze in der Erden,
Der Vogel in der Luft, die Sonn' an Firmament,
Der Salamander muss im Feu' erhalten werden,
Und Gottes Herr ist Jakob Böhme's Element." 12

The three periods of Boehme's authorship constitute three distinct stages in the development of his philosophy. He himself marks a threefold division of his subject-matter:—1. PHILOSOPHIA, *s.e.* the pursuit of the divine *Sophia*, a study of God in himself, this was attempted in the *Aurora*. 2. ASTRONOMIA, *s.e.*, in the largest sense, cosmology, the manifestation of the divine in the structure of the world and of man; hereto belong, with others, *Die drei Principien göttlichen Wesens, Vom dreifachen Leben der Menschen; Von der Menschwerdung Christi; Von der Geburt und Bezeichnung aller Wesen (known as Signatura Rerum)*. 3. THEOLOGIA, *s.e.*, in Scougall's phrase, "the life of God in the soul of man." Of the speculative writings under this head the most important are *Von der Gnadenwahl, Mysticismum Magnum* (a spiritual commentary on Genesis), *Von Christi Testamenten* (the Sacraments).

Although Boehme's philosophy is essentially theological, and his theology essentially philosophical, one would hardly describe him as a philosophical theologian, and, indeed, his position is not one in which either the philosopher or the theologian finds it easy to make himself completely at home. The philosopher finds no trace in Boehme of a conception of God which rests its own validity on an accord with the highest canons of reason or of morals, it is in the actual not in the ideal that Boehme seeks God, whom he discovers as the spring of natural powers and forces, rather than as the goal of advancing thought. The theologian is staggered by a language which breaks the fixed association of theological phrases, and strangely reversing the usual point of view, characteristically pictures God as underneath rather than above. Nature rises out of Him; we sink into Him. The *Ungrund* of the unmanifested Godhead is boldly represented in the English translations of Boehme by the word *Abys*, in a sense altogether unexplained by its Biblical use. In the *Theologia Germanica* this tendency to regard God as the *substantia*, the underlying ground of all things, is accepted as a foundation for piety; the same view, when offered in the colder logic of Spinoza, is sometimes set aside as atheistical. The procession of spiritual forces and natural phenomena out of the *Ungrund* is described by Boehme in terms of a threefold manifestation, commended no doubt by the constitution of the Christian Trinity, but exhibited in a form derived from the school of Paracelsus. From Weigel he learned a purely idealistic explanation of the universe, according to which it is not the resultant of material forces, but the expression of spiritual principles. These two explanations were fused in his mind till they issued forth as equivalent forms of one and the same thought. Further, Schwenkfeld supplied him with the germs of a transcendental exegesis, whereby the Christian Scriptures and the dogmata of Lutheran orthodoxy were opened up in harmony with his new-found views. Thus equipped, Boehme's own genius did the rest. A primary effort of Boehme's philosophy is to show how material powers are substantially one with moral forces. This is the object with which he draws out the dogmatic scheme which dictates the arrangement of his seven *Quellgeister*. Translating Boehme's thought out of the uncouth dialect of material symbols (as to which one doubts sometimes whether he means them as concrete instances, or as pictorial illustrations, or as a mere *memoria technica*), we find that Boehme conceives of the correlation of two triads of forces. Each triad consists of a thesis, an antithesis and a synthesis; and the two are connected by an important link. In the hidden life of the Godhead, which is at once *Nichts* and *Alles*, exists the original triad, *viz.* Attraction, Diffusion, and their resultant, the Agony of the unmanifested Godhead. The transition is made; by an act of will the divine Spirit comes to Light; and immediately the manifested life appears in the triad of Love, Expression, and their resultant, Visible Variety. As the action of contraries and their resultant are explained the relations of soul, body and spirit; of good, evil and free will; of the spheres of the angels, of Lucifer, and of this world. It is a more difficult problem to account on this philosophy for the introduction of evil. Boehme does not resort to dualism, nor has he the smallest sympathy with a pantheistic repudiation of the fact of sin. That the difficulty presses him is clear from the

progressive changes in his attempted solution of the problem. In the *Aurora* nothing save good proceeds from the *Ungrund*, though there is good that abides and good that falls—Christ and Lucifer. In the second stage of his writing the antithesis is directly generated as such; good and its contrary are coincidentally given from the one creative source, as factors of life and movement; while in the third period evil is a direct outcome of the primary principle of divine manifestation—it is the wrath side of God. Corresponding to this change we trace a significant variation in the moral end contemplated by Boehme as the object of this world's life and history. In the first stage the world is created in remedy of a decline; in the second, for the adjustment of a balance of forces; in the third, to exhibit the eternal victory of good over evil, of love over wrath.

Editions of Boehme's works were published by H. Betke (Amsterdam, 1675); by J. G. Gichtel (Amsterdam, 1682-1693, 10 vols.); by K. W. Schiebeler (Leipzig, 1831-1847, 7 vols.). Translations of sundry treatises have been made into Latin (by J. A. Werdenhagen, 1632), Dutch (complete, by W. v. Bayerland, 1634-1641), and French (by Jean Macle, c. 1640, and L. C. de Saint-Martin, 1800-1809). Between 1644 and 1662 all Boehme's works were translated by John Elistone (d. 1652) and John Sparrow, assisted by Durand Hotham and Humphrey Blunden, who paid for the undertaking. At that time regular societies of *Behmenists*, embracing not only the cultivated but the vulgar, existed in England and in Holland. They merged into the Quaker movement, holding already in common with Friends that salvation is nothing short of the very presence and life of Christ in the believer, and only kept apart by an objective doctrine of the sacraments which exposed them to the polemic of Quakers (*e.g.* J. Anderdon). Muggleton led an anthropomorphic reaction against them, and between the two currents they were swept away. The Philadelphian Society at the beginning of the 18th century consisted of cultured mystics, Jane Lead, Portage, Francis Lee, Bromley, &c., who led upon Boehme. William Law (1686-1761) somewhat later returned to the same spring, with the result, however, in those dry times of bringing his own good sense into question rather than of reviving the credit of his author. After Law's death the old English translation was in great part re-edited (4 vols., 1762-1784) as a tribute to his memory, by George Ward and Thomas Langcake, with plates from the designs of D. A. Freber (Brit. Mus. Add. MSS. 5767-5794). This forms what is commonly called Law's translation; to complete it a 5th vol. (12mo, Dublin, 1820) is needed.

See also J. Hamberger, *Die Lehre des deutschen Philosophen J. Boehmes* (1844); Alb. Feip, *J. Boehme der deutsche Philosoph* (1860); von Harless, *J. Boehme und die Alchimisten* (1870, 2nd ed. 1882). For Boehme's life see the *Memoirs* by Abraham von Frankenberg (d. 1652) and others, trans. by F. Okely (1870); La Motte Fouqué, *J. Boehme, sein biographischer Denkstein* (1831); H. A. Fechner, *J. Boehme, sein Leben und seine Schriften* (1857); H. L. Martensen, *J. Boehme, Theosophische Studien* (Copenhagen, 1881); English trans. 1885); J. Claassen, *J. Boehme, sein Leben und seine theosophische Werke* (Gütersloh, 1885); P. Deussen, *J. Boehme, über sein Leben und seine Philosophie* (Kiel, 1897).

BOEOTIA, a district of central Greece, stretching from Phocis and Locris in the W. and N. to Attica and Megaris in the S. between the strait of Euboea and the Corinthian Gulf. This area, amounting in all to 1100 sq. m., naturally falls into two main divisions. In the north the basin of the Cephissus and Lake Copals lies between parallel mountain-walls continuing eastward the line of Parnassus in the extensive ridge of Helicon, the "Mountain of the Muses" (5470 ft.) and the east Locrian range in Mts. Ptoim, Messapium and other smaller peaks. These ranges, which mostly lie close to the seaboard, form by their projecting spurs a narrow defile on the Phocian frontier, near the famous battlefield of Chaeroneia, and shut in Copals closely on the south between Coronea and Haliartus. The north-east barrier was pierced by underground passages (*katastrava*) which carried off the overflow from Copals. The southern portion of the land forms a plateau which slopes to Mt. Cithaeron, the frontier range between Boeotia and Attica. Within this territory the low ridge of Teumessus separates the plain of Ismenus and Dirce, commanded by the citadel of Thebes, from the upland plain of the Asopus, the only Boeotian river that finds the eastern sea. Though the Boeotian climate suffered from the exhalations of Copals, which produced a heavy atmosphere with foggy winters and sultry summers, its rich soil was suited alike for crops, plantations and pasture; the Copals plain, though able to turn into marsh when the choking of the *katastrava*

caused the lake to encroach, being among the most fertile in Greece. The central position of Boeotia between two seas, the strategic strength of its frontiers and the ease of communication within its extensive area were calculated to enhance its political importance. On the other hand the lack of good harbours hindered its maritime development; and the Boeotian nation, although it produced great men like Pindar, Epaminondas, Pelopidas and Plutarch, was proverbially as dull as its native air. But credit should be given to the people for their splendid military qualities: both their cavalry and heavy infantry achieved a glorious record.

In the mythical days Boeotia played a prominent part. Of the two great centres of legends, Thebes with its Cadmean population figures as a military stronghold, and Orchomenus, the home of the Minyae, as an enterprising commercial city. The latter's prosperity is still attested by its archaeological remains (notably the "Treasury of Minyas") and the traces of artificial conduits by which its engineers supplemented the natural outlets. The "Boeotian" population seems to have entered the land from the north at a date probably anterior to the Dorian invasion. With the exception of the Minyae, the original peoples were soon absorbed by these immigrants, and the Boeotians henceforth appear as a homogeneous nation.

In historical times the leading city of Boeotia was Thebes, whose central position and military strength made it a suitable capital. It was the constant ambition of the Thebans to absorb the other townships into a single state, just as Athens had annexed the Attic communities. But the outlying cities successfully resisted this policy, and only allowed the formation of a loose federation which in early times seems to have possessed a merely religious character. While the Boeotians, unlike the Arcadians, generally acted as a united whole against foreign enemies, the constant struggle between the forces of centralization and disruption perhaps went further than any other case to check their development into a really powerful nation. Boeotia hardly figures in history before the late 6th century. Previous to this its people is chiefly known as the producer of a type of geometric pottery similar to the Dipylon ware of Athens. About 510 the resistance of Plataea to the federating policy of Thebes led to the interference of Athens on behalf of the former; on this occasion, and again in 507, the Athenians defeated the Boeotian levy. During the Persian invasion of 480, while some of the cities fought whole-heartedly in the ranks of the patriots, Thebes assisted the invaders. For a time the presidency of the Boeotian League was taken away from Thebes, but in 457 the Spartans reinstated that city as a bulwark against Athenian aggression. Athens retaliated by a sudden advance upon Boeotia, and after the victory of Oenophyta brought under its power the whole country excepting the capital. For ten years the land remained under Athenian control, which was exercised through the newly installed democracies; but in 447 the oligarchic majority raised an insurrection, and after a victory at Coronea regained their freedom and restored the old constitutions. In the Peloponnesian War the Boeotians, embittered by the early conflicts round Plataea, fought zealously against Athens. Though slightly estranged from Sparta after the peace of Nicias, they never abated their enmity against their neighbours. They rendered good service at Syracuse and Arginnsae; but their greatest achievement was the decisive victory at Delium over the flower of the Athenian army (424), in which both their heavy infantry and their cavalry displayed unusual efficiency.

About this time the Boeotian League comprised eleven groups of sovereign cities and associated townships, each of which elected one Boeotarch or minister of war and foreign affairs, contributed sixty delegates to the federal council at Thebes, and supplied a contingent of about a thousand foot and a hundred horse to the federal army. A safeguard against undue encroachment on the part of the central government was provided in the councils of the individual cities, to which all important questions of policy had to be submitted for ratification. These local councils, to which the propertied classes alone were

eligible, were subdivided into four sections, resembling the *prytaneis* of the Athenian council, which took it in turns to take previous cognizance of all new measures.¹

Boeotia took a prominent part in the war of the Corinthian League against Sparta, especially at Halitartus and Coronea (395-394). This change of policy seems due mainly to the national resentment against foreign interference. Yet disaffection against Thebes was now growing rife, and Sparta fostered this feeling by stipulating for the complete independence of all the cities in the peace of Antalcidas (387). In 374 Pelopidas restored the Theban dominion. Boeotian contingents fought in all the campaigns of Epaminondas, and in the later wars against Phocis (356-346); while in the dealings with Philip of Macedon the federal cities appear merely as the tools of Thebes. The federal constitution was also brought into accord with the democratic governments now prevalent throughout the land. The sovereign power was vested in the popular assembly, which elected the Boeotarchs (between seven and twelve in number), and sanctioned all laws. After the battle of Chaeroneia, in which the Boeotian heavy infantry once again distinguished itself, the land never rose again to prosperity. The destruction of Thebes by Alexander (335) seems to have paralysed the political energy of the Boeotians, though it led to an improvement in the federal constitution, by which each city received an equal vote. Henceforth they never pursued an independent policy, but followed the lead of protecting powers. Though the old military training and organization continued, the people proved unable to defend the frontiers, and the land became more than ever the "dancing-ground of Ares." Though enrolled for a short time in the Aetolian League (about 245 B.C.) Boeotia was generally loyal to Macedonia, and supported its later kings against Rome. In return for the excesses of the democracies Rome dissolved the league, which, however, was allowed to revive under Augustus, and merged with the other central Greek federations in the Achaean synd. The death-blow to the country's prosperity was given by the devastations during the first Mithradatic War.

Save for a short period of prosperity under the Frankish rulers of Athens (1205-1310), who repaired the *katavothra* and fostered agriculture, Boeotia long continued in a state of decay, aggravated by occasional barbarian incursions. The first step towards the country's recovery was not until 1805, when the outlets of Copals were again put into working order. Since then the northern plain has been largely reclaimed for agriculture, and the natural riches of the whole land are likely to develop under the influence of the railway to Athens. Boeotia is at present a Nomos with Livadia (the old Turkish capital) for its centre; the other surviving townships are quite unimportant. The population (65,816 in 1907) is largely Albanian.

AUTHORITIES.—Thuc. iv. 76-101; Xenophon, *Hellenica*, iii.-vii., Strabo, pp. 400-412; Pausanias ix.; Theopompus (or Cratippus) in the *Oxyrhynchus Papyri*, vol. v. (London, 1908), No. 842, col. 12. W. M. Leake, *Travels in Northern Greece*, chs. xi.-xix. (London, 1835). H. F. Tozer, *Geography of Greece* (London, 1873), pp. 233-238; W. Rhys Roberts, *The Ancient Boeotians* (Cambridge, 1895); E. A. Freeman, *Federal Government* (ed. 1893, London), ch. iv. § 2; B. W. Head, *Historia Numorum*, pp. 291 sqq. (Oxford, 1887); W. Larfeld, *Sylloge Inscriptionum Boeoticarum* (Berlin, 1883). (See also THEBES.)

BOER, the Dutch form of the Eng. "boor," in its original signification of husbandman (Ger. *Bauer*), a name given to the Dutch farmers of South Africa, and especially to the Dutch population of the Transvaal and Orange River States. (See SOUTH AFRICA and TRANSVAAL.)

BOERHAAVE, HERMANN (1668-1738), Dutch physician and man of science, was born at Voorhout near Leiden on the 31st of December 1668. Entering the university of Leiden he took his degree in philosophy in 1689, with a dissertation *De distinctione mentis a corpore*, in which he attacked the doctrines of Epicurus, Hobbes and Spinoza. He then turned to the study of medicine, in which he graduated in 1693 at Harderwyck in Guelderland. In 1701 he was appointed lecturer on the institutes

¹ Thucydides (v. 38), in speaking of the "four councils of the Boeotians," is referring to the plenary bodies in the various states.

of medicine at Leiden; in his inaugural discourse, *De commendando Hippocratis studio*, he recommended to his pupils that great physician as their model. In 1709 he became professor of botany and medicine, and in that capacity he did good service, not only to his own university, but also to botanical science, by his improvements and additions to the botanic garden of Leiden, and by the publication of numerous works descriptive of new species of plants. In 1714, when he was appointed rector of the university, he succeeded Robert Bidloo (1649-1713) in the chair of practical medicine, and in this capacity he had the merit of introducing the modern system of clinical instruction. Four years later he was appointed also to the chair of chemistry. In 1728 he was elected into the French Academy of Sciences, and two years later into the Royal Society of London. In 1729 declining health obliged him to resign the chairs of chemistry and botany; and he died, after a lingering and painful illness, on the 23rd of September 1738 at Leiden. His genius so raised the fame of the university of Leiden, especially as a school of medicine, that it became a resort of strangers from every part of Europe. All the princes of Europe sent him disciples, who found in this skilful professor not only an indefatigable teacher, but an affectionate guardian. When Peter the Great went to Holland in 1715, to instruct himself in maritime affairs, he also took lessons from Boerhaave. His reputation was not confined to Europe; a Chinese mandarin wrote him a letter directed "To the illustrious Boerhaave, physician in Europe," and it reached him in due course.

His principal works are—*Institutiones medicæ* (Leiden, 1708); *Aphorismi de cognoscendis et curandis morbis* (Leiden, 1709), on which his pupil and assistant, Gerard van Swieten (1700-1772) published a commentary in 5 vols. and *Elementa chemicæ* (Paris, 1724)

BOETHIUS, a sculptor of the Hellenistic age, a native of Carthage (or possibly Chalcedon). His date cannot be accurately fixed, but was probably the 2nd century B.C. He was noted for his representations of children, in dealing with whom earlier Greek art had not been very successful; and especially for a group representing a boy struggling with a goose, of which several copies survive in museums

BOETIUS (or **BOETHIUS**). **ANICIUS MANLIUS SEVERINUS** (c. A.D. 480-524). Roman philosopher and statesman, described by Gibbon as "the last of the Romans whom Cato or Tully could have acknowledged for their countryman." The historians of the day give us but imperfect records or make unsatisfactory allusions. Later chroniclers indulged in the fictitious and the marvellous, and it is almost exclusively from his own books that trustworthy information can be obtained. There is considerable diversity among authorities as to his name. One editor of his *De Consolatione*, Bertius, thinks that he bore the prænomen of Flavius, but there is no authority for this supposition. His father was Flavius Manlius Boetius, and it is probable that the Flavius Boetius, the prætorian prefect who was put to death in A.D. 455 by order of Valentinian III., was his grandfather, but these facts do not prove that he also had the prænomen of Flavius. Many of the earlier editions inserted the name of Torquatius, but it is not found in any of the best manuscripts. The last name is commonly written Boethius, from the idea that it is connected with the Greek *βοηθος*; but the best manuscripts agree in reading Boetius.

His boyhood was spent in Rome during the reign of Odoacer. We know nothing of his early years. A passage in a treatise falsely ascribed to him (*De Disciplina Scholarium*) and a misinterpretation of a passage in Cassiodorus led early scholars to suppose that he spent some eighteen years in Athens pursuing his studies, but there is no foundation for this opinion. His father, consul in 487, seems to have died soon after; for Boetius states that, when he was bereaved of his parent, men of the highest rank took him under their charge (*De Consol. lib. ii. c. 3*), especially the senator Q. Aur. Memmius Symmachus, whose daughter Rusticiana he married. By her he had two sons, Anicius Manlius Severinus Boetius and Q. Aurelius Memmius Symmachus. He became a favourite with Theodoric, the

Ostrogoth, who ruled in Rome from 500, and was one of his intimate friends. Boetius was consul in 510, and his sons, while still young, held the same honour together (522). Boetius regarded it as the height of his good fortune when he witnessed his two sons, consuls at the same time, conveyed from their home to the senate-house amid the enthusiasm of the masses. On that day, he tells us, while his sons occupied the curule chairs in the senate-house, he himself had the honour of pronouncing a panegyric on the monarch. But his good fortune did not last, and he attributes the calamities that came upon him to the ill-will which his bold maintenance of justice had caused, and to his opposition to every oppressive measure. Of this he mentions particular cases. A famine had begun to rage. The prefect of the prætorium was determined to satisfy the soldiers, regardless altogether of the feelings of the provincials. He accordingly issued an edict for a *coemptio*, that is, an order compelling the provincials to sell their corn to the government, whether they would or not. This edict would have utterly ruined Campania. Boetius interfered. The case was brought before the king, and Boetius succeeded in averting the *coemptio* from the Campanians. And he gives as a crowning instance that he exposed himself to the hatred of the informer Cyprianus by preventing the punishment of Albinus, a man of consular rank. He mentions in another place that when at Verona the king was anxious to transfer the accusation of treason brought against Albinus to the whole senate, he defended the senate at great risk. In consequence of the ill-will that Boetius had thus roused, he was accused of treason towards the end of the reign of Theodoric. The charges were that he had conspired against the king, that he was anxious to maintain the integrity of the senate, and to restore Rome to liberty, and that for this purpose he had written to the emperor Justin. Justin had, no doubt, special reasons for wishing to see an end to the reign of Theodoric. Justin was orthodox, Theodoric was an Arian. The orthodox subjects of Theodoric were suspicious of his ruler; and many would gladly have joined in a plot to displace him. The knowledge of this fact may have rendered Theodoric suspicious. But Boetius denied the accusation in unequivocal terms. He did indeed wish the integrity of the senate. He would fain have desired liberty, but all hope of it was gone. The letters addressed by him to Justin were forgeries, and he had not been guilty of any conspiracy. Notwithstanding his innocence he was condemned and sent to Ticinum (Pavia) where he was thrown into prison. It was during his confinement in this prison that he wrote his famous work *De Consolatione Philosophiæ*. His goods were confiscated, and after an imprisonment of considerable duration he was put to death in 524. Procopius relates that Theodoric soon repented of his cruel deed, and that his death, which took place soon after, was hastened by remorse for the crime he had committed against his great counsellor.

Two or three centuries after the death of Boetius writers began to view his death as a martyrdom. Several Christian books were ascribed to him, and there was one especially on the Trinity (see below) which was regarded as proof that he had taken an active part against the heresy of Theodoric. It was therefore for his orthodoxy that Boetius was put to death. And these writers delight to paint with minuteness the horrible tortures to which he was exposed and the marvellous actions which the saint performed at his death. He was locally regarded as a saint, but he was not canonized. The brick tower in Pavia in which he was confined was, and still is, an object of reverence to the country people. Finally, in the year 996, Otho III. ordered the bones of Boetius to be taken out of the place in which they had lain hid, and to be placed in the church of S. Pietro in Ciel d'Oro within a splendid tomb, for which Gerbert, afterwards Pope Silvester II., wrote an inscription. Thence they were subsequently removed to a tomb beneath the high altar of the cathedral. It should be mentioned also that some have given him a decidedly Christian wife, of the name of Elpis, who wrote hymns, two of which are still extant (Daniel, *The. Hymn.* i. p. 156). This is a pure supposition inconsistent with chronology, and based only on a misinterpretation of a passage in the *De Consolatione*.

The contemporaries of Boetius regarded him as a man of profound learning. Priscian the grammarian speaks of him as having attained the summit of honesty and of all sciences. Cassiodorus, *magister officiorum* under Theodoric and the intimate acquaintance of the philosopher, employs language equally strong, and Ennodius, the bishop of Pavia, knows no bounds for his admiration. Theodoric had a profound respect for his scientific abilities. He employed him in setting right the coinage. When he visited Rome with Gunibald, king of the Burgundians, he took him to Boetius, who showed them, amongst other mechanical contrivances, a sun-dial and a water-clock. The foreign monarch was astonished, and, at the request of Theodoric, Boetius had to prepare others of a similar nature, which were sent as presents to Gunibald.

The fame of Boetius increased after his death, and his influence during the middle ages was exceedingly powerful. His circumstances peculiarly favoured this influence. He appeared at a time when contempt for intellectual pursuits had begun to pervade society. In his early years he was seized with a passionate enthusiasm for Greek literature, and this continued through life. Even amidst the cares of the consulship he found time for commenting on the *Categories* of Aristotle. The idea laid hold of him of reviving the spirit of his countrymen by imbuing them with the thoughts of the great Greek writers. He formed the resolution to translate all the works of Aristotle and all the dialogues of Plato, and to reconcile the philosophy of Plato with that of Aristotle. He did not succeed in all that he designed; but he did a great part of his work. He translated into Latin Aristotle's *Analytica Priora et Posteriora*, the *Topica*, and *Elenchi Sophistici*; and he wrote commentaries on Aristotle's *Categories*, on his book *repl' éppéras*, also a commentary on the *Isagoge* of Porphyrius. These works formed to a large extent the source from which the middle ages derived their knowledge of Aristotle. (See Stahr, *Aristoteles bei den Römern*, pp. 196-234.) Boetius wrote also a commentary on the *Topica* of Cicero; and he was also the author of independent works on logic:—*Introductio ad Categoricas Syllogismos*, in one book; *De Syllogismis Categoricis*, in two books; *De Syllogismis Hypotheticis*, in two books; *De Divisione*, in one book; *De Definitione*, in one book; *De Differentiis Topicis*, in four books.

We see from a statement of Cassiodorus that he furnished manuals for the quadrivium of the schools of the middle ages (the "quatuor matheseos disciplinae," as Boetius calls them) on arithmetic, music, geometry and astronomy. The statement of Cassiodorus that he translated Nicomachus is rhetorical. Boetius himself tells us in his preface addressed to his father-in-law Symmachus that he had taken liberties with the text of Nicomachus, that he had abridged the work when necessary, and that he had introduced formulæ and diagrams of his own where he thought them useful for bringing out the meaning. His work on music also is not a translation from Pythagoras, who left no writing behind him. But Boetius belonged to the school of musical writers who based their science on the method of Pythagoras. They thought that it was not sufficient to trust to the ear alone, to determine the principles of music, as did practical musicians like Aristoxenus, but that along with the ear, physical experiments should be employed. The work of Boetius is in five books and is a very complete exposition of the subject. It long remained a text-book of music in the universities of Oxford and Cambridge. It is still very valuable as a help in ascertaining the principles of ancient music, and gives us the opinions of some of the best ancient writers on the art. The manuscripts of the geometry of Boetius differ widely from each other. One editor, Godofredus Friedlein, thinks that there are only two manuscripts which can at all lay claim to contain the work of Boetius. He published the *Ars Geometriae*, in two books, as given in these manuscripts; but critics are generally inclined to doubt the genuineness even of these. Professor Rand, Georgius Ernst and A. P. McKinlay regard the *Ars* as certainly inauthentic, while they accept the *Interpretatio Euclidis* (see works quoted in bibliography).

By far the most important and most famous of the works

of Boetius is his book *De Consolatione Philosophiæ*. Gibbon justly describes it as "a golden volume, not unworthy of the leisure of Plato or Tully, but which claims incomparable merit from the barbarism of the times and the situation of the author." The high reputation it had in medieval times is attested by the numerous translations, commentaries and imitations of it which then appeared. Amongst others Asser, the instructor of Alfred the Great, and Robert Grosseteste, bishop of Lincoln, commented on it. Alfred translated it into Anglo-Saxon. Versions of it appeared in German, French, Italian, Spanish and Greek before the end of the 15th century. Chaucer translated it into English prose before the year 1382; and this translation was published by Caxton at Westminster, 1480. Lydgate followed in the wake of Chaucer. It is said that, after the invention of printing, amongst others Queen Elizabeth translated it, and that the work was well known to Shakespeare. It was the basis of the earliest specimen of Provencal literature.

This famous work consists of five books. Its form is peculiar, and is an imitation of a similar work by Marcellianus Capella, *De Nuptiis Philologiae et Mercurii*. It is alternately in prose and verse. The verse shows great facility of metrical composition, but a considerable portion of it is transferred from the tragedies of Seneca. The first book opens with a few verses, in which Boetius describes how his sorrows had brought him to a premature old age. As he is thus lamenting, a woman appears to him of dignified mien, whom he recognizes as his guardian, Philosophy. She, resolving to apply the remedy for his grief, questions him for that purpose. She finds that he believes that God rules the world, but does not know what he himself is; and this absence of self-knowledge is the cause of his weakness. In the second book Philosophy presents to Boetius Fortune, who is made to state to him the blessings he has enjoyed, and after that proceeds to discuss with him the kind of blessings that fortune can bestow, which are shown to be unsatisfactory and uncertain. In the third book Philosophy promises to lead him to true happiness, which is to be found in God alone, for since God is the highest good, and the highest good is true happiness, God is true happiness. Nor can real evil exist, for since God is all-powerful, and since he does not wish evil, evil must be non-existent. In the fourth book Boetius raises the question, Why, if the governor of the universe is good, do evils exist, and why is virtue often punished and vice rewarded? Philosophy proceeds to show that in fact vice is never unpunished nor virtue unrewarded. From this Philosophy passes into a discussion in regard to the nature of providence and fate, and shows that every fortune is good. The fifth and last book takes up the question of man's free will and God's foreknowledge, and, by an exposition of the nature of God, attempts to show that these doctrines are not subversive of each other; and the conclusion is drawn that God remains a foreknowing spectator of all events, and the ever-present eternity of his vision agrees with the future quality of our actions, dispensing rewards to the good and punishments to the wicked.

Several theological works have been ascribed to Boetius, as has been already mentioned. The *Consolatio* affords conclusive proof that the author was not a practical believer in Christianity. The book contains expressions such as *daemones*, *angelica virtus*, and *purgatoria clementia*, which have been thought to be derived from the Christian faith; but they are used in a heathen sense, and are explained sufficiently by the circumstance that Boetius was an intimate terms with Christians. The writer nowhere finds consolation in any Christian belief, and Christ is never named in the work. It is not impossible, however, that Boetius may have been brought up a Christian, and that in his early years he may have written some Christian books. Peiper thinks that the first three treatises are the productions of the early years of Boetius. The first, *De Sancta Trinitate*, is addressed to Symmachus (Domino Patri Symmacho), and the result of the short discussion, which is of an abstract nature, and deals partly with the ten categories, is that unity is predicated absolutely, or, in regard to the substance of the Deity, trinity is predicated relatively. The second treatise is addressed to John the deacon ("Ad Joannem Diaconum"), and its subject is "Utrum Pater et Filius et Spiritus Sanctus de divinitate substantialiter prædicentur." This treatise is shorter than the first, occupying only two or three pages, and the conclusion of the argument is the same. The third treatise bears the title, *Quomodo substantiæ in eo quod sint bonæ sint cum non sint substantialia bona*. It contains nothing distinctly Christian, and it contains nothing of great value; therefore its authorship is a matter of little consequence. Peiper thinks that, as the best MSS. uniformly assign these treatises to Boetius, they are to be regarded as his; that it is probable that Symmachus and John (who afterwards became Pope) were the men of highest distinction who took charge of him when he lost his father; and that these treatises are the first-fruits of his studies, which he dedicates to his guardians and benefactors. He thinks that the variations in the inscriptions of the fifth treatise which is not found in the best manuscript, are so great that the name of Boetius could

not have originally been in the title. The fourth book is also not found in the best manuscript, and two manuscripts have no inscription. He infers, from these facts, that there is no sure evidence for the authorship of the fourth and fifth treatises. The fifth treatise is *Contra Eutychen et Nestorium*. Both Eutyches and Nestorius are spoken of as living. A council is mentioned, in which a letter was read, expounding the opinion of the Eutychians for the first time. The novelty of the opinion is also alluded to. All these circumstances point to the council of Chalcedon (451). The treatise was therefore written before the birth of Boetius, if it be not a forgery; but there is no reason to suppose that the treatise was not a genuine production of the time to which it professes to belong. The fourth treatise, *De Fide Catholica*, does not contain any distinct chronological data; but the tone and opinions of the treatise produce the impression that it probably belonged to the same period as the treatise against Eutyches and Nestorius. Several inscriptions ascribe both these treatises to Boetius. It will be seen from this statement that Peiper bases his conclusions on grounds far too narrow; and on the whole it is perhaps more probable that Boetius wrote none of the four Christian treatises, particularly as they are not ascribed to him by any of his contemporaries. Three of them express in the strongest language the orthodox faith of the church in opposition to the Arian heresy, and these three put in unmistakable language the procession of the Holy Spirit from both Father and Son. The fourth argues for the orthodox belief of the two natures and one person of Christ. When the desire arose that it should be believed that Boetius perished from his opposition to the heresy of Theodoric, it was natural to ascribe to him works which were in harmony with this supposed fact. The works may really have been written by one Boetius, a bishop of Africa, as Jourdain supposes, or by some Saint Severinus, as Nitzsch conjectures, and the similarity of name may have aided the transference of them to the heathen or neutral Boetius.

Important and, if genuine, decisive evidence upon this point is afforded by a passage in the *Anecdota Halderi*, a fragment contained in a 10th-century MS. (ed. H. Usener, Leipzig, 1877). The fragment gives an extract from a previously unknown letter of Cassiodorus, the important words being "Scriptis (i.e. Boetius) librum de sancta trinitate, et capita quaedam dogmatica, et librum contra Nestorium." Nitzsch, however, held that this was a copyist's gloss, harmonizing with the received Boetius legend, which had been transferred to the text, and did not consider that it outweighed the opposing internal evidence from *De Cons. Phil.*

EDITIONS.—The first collected edition of the works of Boetius was published at Venice in 1492 (Basel, 1570); the last in J. P. Migne's *Patrologia*, lxxii., lxiv. (Paris, 1847). Of the numerous editions of the *De Consolatione* the best are those of Theodoros Obbarius (Jena, 1843) and R. Peiper (Leipzig, 1871). The first contains prolegomena on the life and writings of Boetius, on his religion and philosophy, and on the manuscripts and editions, a critical apparatus, and notes. The text of the second was based on the fullest collation of MSS. up to that time, though a considerable number of MSS. still remained to be collated. In addition to an account of the MSS. used, it gives the Book of Lupus, "De Metris Boetii," the "Vita Boetii" contained in some MSS., "Elogia Boetii," and a short list of the commentators, translators and imitators of the *Consolatio*. It contains also an account of the metres used by Boetius in the tragedies of Seneca. The work also includes the five treatises, four of them Christian, of which mention has been made above. King Alfred's Anglo-Saxon version of the *De Consolatione*, with literal English translation, notes and glossary, was published by S. Fox (1835) and again by W. J. Sedgwick (1900); that of G. Colville (Colville, Coldewell, 1556) was republished by E. B. Bax (1897); translation (mixed prose and verse) by H. R. James (1897). Queen Elizabeth's "Englischings" was reprinted in 1899; on the style, see A. Engelbrecht in *Sitzungsber. der Wiener Akad. der Wissenschaften* (1902), pp. 15-36. The *De Institutione Arithmetica*, *De Institutione Musica*, and the doubtful *Geometria* (for which see G. Ernst, *De Geometricis illis quae sub Boetius nomine nobis tradita sunt quaestiones*, 1903; A. P. McKinlay in *Harvard Classical Studies*, 1907; M. Cantor, *Geschichte der Mathematik*, I., Leipzig, 1894; G. Friedlein, *Gerbert, die Geometrie des Boetius, und die indischen Ziffern*, Erlangen, 1861, ed. by G. Friedlein (Leipzig, 1867); German translation of the *De Musica*, with explanatory notes, by O. Paul (Leipzig, 1872), and on the sources W. Mielke, *De Boethii libri de musica primi fontibus* (Jena, 1899). Commentary on Aristotle's *De Interpretatione* $\tau\omicron\rho\sigma$ $\delta\iota\omicron\rho\mu\epsilon\tau\alpha\varsigma$, ed. C. Meiser (Leipzig, 1877), and on Porphyry's *Isagoge*, ed. S. Brandt (Vienna, 1906).

AUTHORITIES.—On Boetius generally, see J. G. Suttner, *Der letzte Römer* (Eichstädt, 1852); H. Usener, *Anecdota Halderi* (Leipzig, 1877); H. F. Stewart, *Boetius: an Essay* (Edinburgh, 1891); T. Hodgkin, *Italy and her Invaders*, bk. iv, ch. xii. (1893); A. Ebert, *Allgemeine Geschichte der Litt. des Mittelalters*, I. (1892); Teuffel-Schwabe, *Hist. of Roman Literature* (Eng. trans., 1900), § 478; on the date and order of his works, S. Brandt in *Philologus*, liii. pp. 141-154, 234-279, and A. P. McKinlay, as above, with refs. on his "Songs," H. Hüttinger, *Studia in Boetii carmina collata* (Regensburg, 1900); on his style, G. Bednarz, *De univ. oratoris calare Boetius* (Breslau, 1883); on his theological attitude and works,

F. A. B. Nitzsch, *Das System des Boetius und die ihm zugeschriebenen theologischen Schriften* (Berlin, 1860), and art. in Herzog-Hauck's *Realencyclopädie* (1897); C. Jourdain, *De l'Origine des traditions sur le christianisme de Boèce* (1861); Gaston Boissier, "Le Christianisme de Boèce," in *Journal des Savants* (1889), pp. 449-462; A. Hildebrand, *Boetius und seine Stellung zum Christentum* (Regensburg, 1885); G. Schepps, "Zu Pseudo-Boetius de fide catholica," in *Zeitschrift für wissenschaftliche Theologie*, xxviii. (1895).

BOG (from Ir. and Gael. *bogach*, *bog*, soft), a tract of soft, spongy, water-logged ground, composed of vegetation, chiefly mosses, in various stages of decomposition. This vegetable matter when partially decomposed forms the substance known as "peat" (q.v.). When the accumulation of water is rapidly increased by excessive rainfall, there is a danger of a "bog-slide," or "bog-burst," which may obliterate the neighbouring cultivated lands with a deposit of the contents of the bog. Destructive bog-slides have occurred in Ireland, such as that of the Knockageeha Bog, Rathmore, Kerry, in 1896, at Castlerea, Roscommon, 1901, and at Kilmore, Galway, 1909.

There is a French game of cards called "bog," said to be of Italian origin, played with a piquet pack on a table with six divisions, one of which is known by the name of the game and forms the pool. It was fashionable during the Second Empire.

BOGATZKY, KARL HEINRICH VON (1690-1774), German hymn-writer, was born at Jankowice in Lower Silesia on the 7th of September 1690. At first a page at the ducal court of Saxe-Weissenfels, he next studied law and theology at Jena and Halle; but ill-health preventing his preferment he settled at Glanča in Silesia, where he founded an orphanage. After living for a time at Köstritz, and from 1740 to 1745 at the court of Christian Ernst, duke of Saxe-Coburg, at Saalfeld, he made his home at the Waisenhaus (orphanage) at Halle, where he engaged in spiritual work and in composing hymns and sacred songs, until his death on the 15th of June 1774. Bogatzky's chief works are *Güldenes Schatzkästlein der Kinder Gottes* (1718), which has reached more than sixty editions; and *Übung der Gottseligkeit in allerlei geistlichen Liedern* (1750).

See Bogatzky's autobiography—*Lebenslauf von ihm selbst geschrieben* (Halle, 1801; new ed., Berlin, 1872); and Ledderhose, *Das Leben Bogatzky's* (Heidelberg, 1846), also Kelly, *C. H. von Bogatzky's Life and Work* (London, 1899).

BOGHAZ KEUI, a small village in Asia Minor, north-west of Yuzgat in the Angora vilayet, remarkable for the ruins and rock-sculptures in its vicinity. The ruins are those of a ruling city of the oriental type which flourished in the pre-Greek period; and they are generally identified with Pteria (q.v.), a place taken by Croesus after he had crossed the Halys (Herodotus I. 76).

BOGIE, a northern English dialect word of unknown origin, applied to a kind of low truck or "trolley." In railway engineering it is applied to an under-truck, most frequently with four wheels, which is often provided at one end of a locomotive or both ends of a carriage. It is pivoted or swivelled on the main frames, so that it can turn relatively to the body of the vehicle or engine, and thus it enables the wheels readily to follow the curves of the line. It has no connexion with the series of words, such as "bogey" or "bogy," "bogle," "boggle," "bogart" (in Shakespeare "bug," "bugs and goblins"), which are probably connected with the Welsh *bwg*, a spectre; hence the verb to "boggle," properly applied to a horse which shies at supposed spectres, and so meaning to hesitate, dangle.

BOGNOR, a seaside resort in the Chichester parliamentary division of Sussex, England, 66 m. S.S.W. from London by the London, Brighton & South Coast railway. Pop. of urban district (1901) 6180. Besides the parish church there is a Roman Catholic priory and church. The town possesses a pier and promenade, a theatre, assembly rooms, and numerous convalescent homes, including an establishment belonging to the Merchant Taylors' Company. The church of the mother parish of South Bersted is Norman and Early English, and retains a fresco of the 16th century.

BOGÓ, a town of the province of Cebú, island of Cebú, Philippine Islands, on Bogó Bay at the mouth of the Bulac river, in the north-east part of the island. Pop. (1903) 14,915. The

climate is hot but healthy. The surrounding country is fertile, producing sugar, Indian corn, and maguay in abundance; rice, cacao and fruits are also produced. Hats, baskets, cloths and rope are woven and are exported to a limited extent; small quantities of copra are also exported. The fisheries are of considerable local importance. The language is Cebú-Visayan.

BOGODUKHOV, a town of Russia, in the government of Khar'kov, 45 m. by rail N.W. of the city of that name, in 40° 58' N. lat. and 36° 9' E. long., was formerly fortified. Pop. (1860) 10,522; (1897) 11,028. There seems to have been a settlement on this site as early as 1571. In 1709, at the time of the Russo-Swedish War, Bogodukhov was taken by Menshikov and the emperor Alexis. It contains a cathedral, built in 1703. Boots, caps and furred gowns are manufactured, and gardening and tanning are carried on. The trade is principally in grain, cattle and fish.

BOGOMILS, the name of an ancient religious community which had its origin in Bulgaria. It is difficult to ascertain whether the name was taken from the reputed founder of that sect, a certain pope Bogumil or Bogomil, or whether he assumed that name after it had been given to the whole sect. The word is a direct translation into Slavonic of *Massaliani*, the Syrian name of the sect corresponding to the Greek Euchites. The Bogomils are identified with the Massaliani in Slavonic documents of the 13th century. They are also known as *Pantikeni*, i.e. Panicians. It is a complicated task to determine the true character and the tenets of any ancient sect, considering that almost all the information that has reached us has come from the opponents. The heretical literature has to a great extent either perished or been completely changed; but much has also survived in a modified written form or through oral tradition. Concerning the Bogomils something can be gathered from the information collected by Euthymius Zygadenus in the 12th century, and from the polemic *Against the Heretics* written in Slavonic by St. Kozma during the 10th century. The old Slavonic lists of forbidden books of the 15th and 16th centuries also give us a clue to the discovery of this heretical literature and of the means the Bogomils employed to carry on their propaganda. Much may also be learnt from the doctrines of the numerous heretical sects which arose in Russia after the 11th century.

The Bogomils were without doubt the connecting link between the so-called heretical sects of the East and those of the West. They were, moreover, the most active agents in disseminating such teachings in Russia and among all the nations of Europe. They may have found in some places a soil already prepared by more ancient tenets which had been preserved in spite of the persecution of the official Church, and handed down from the period of primitive Christianity. In the 12th and 13th centuries the Bogomils were already known in the West as "Bulgari." In 1207 the *Bulgarorum heresis* is mentioned. In 1223 the Albigenses are declared to be the local *Bougres*, and at the same period mention is made of the "Pope of the Albigenses who resided within the confines of Bulgaria." The Cathars and Patarenes, the Waldenses, the Anabaptists, and in Russia the Strigolniki, Molokani and Dukhoborts, have all at different times been either identified with the Bogomils or closely connected with them.

Doctrine.—From the imperfect and conflicting data which are alone available one positive result can be gathered, viz. that the Bogomils were both Adoptionists and Manicheans. They had accepted the teaching of Paul of Samosata, though at a later period the name of Paul was believed to be that of the Apostle; and they were not quite free from the Dualistic principle of the Gnostics, at a later period too much identified with the teaching of Mani. They rejected the pneumatic Christianity of the orthodox churches and did not accept the docetic teaching of some of the other sects. Taking as our starting-point the teaching of the heretical sects in Russia, notably those of the 14th century, which are a direct continuation of the doctrines held by the Bogomils, we find that they denied the divine birth of Christ, the personal coexistence of the Son with the Father and Holy Ghost, and the validity of sacraments and ceremonies. The miracles performed by Jesus were interpreted in a spiritual sense, not as real material occurrences; the Church was the in-

terior spiritual church in which all held equal share. Baptism was only to be practised on grown men and women. The Bogomils repudiated infant baptism, and considered the baptismal rite to be of a spiritual character neither by water nor by oil but by self-abnegation, prayers and chanting of hymns. Carp Strigolnik, who in the 14th century preached this doctrine in Novgorod, explained that St. Paul had taught that simple-minded men should instruct one another; therefore they elected their "teachers" from among themselves to be their spiritual guides, and had no special priests. Prayers were to be said in private houses, not in separate buildings such as churches. Ordination was conferred by the congregation and not by any specially appointed minister. The congregation were the "elect," and each member could obtain the perfection of Christ and become a Christ or "Chlist." Marriage was not a sacrament. The Bogomils refused to fast on Mondays and Fridays. They rejected monachism. They declared Christ to be the Son of God only through grace like other prophets, and that the bread and wine of the eucharist were not transformed into flesh and blood; that the last judgment would be executed by God and not by Jesus; that the images and the cross were idols and the worship of saints and relics idolatry.

These Paulician doctrines have survived in the great Russian sects, and can be traced back to the teachings and practice of the Bogomils. But in addition to these doctrines of an adoptionist origin, they held the Manichean dualistic conception of the origin of the world. This has been partly preserved in some of their literary remains, and has taken deep root in the beliefs and traditions of the Bulgarians and other nations with whom they had come into close contact. The chief literature of all the heretical sects throughout the ages has been that of apocryphal Biblical narratives, and the popes Jeremiah or Bogumil are directly mentioned as authors of such forbidden books "which no orthodox dare read." Though these writings are mostly the same in origin as are known from the older lists of apocryphal books, they underwent in this case a certain modification at the hands of their Bogomil editors, so as to be used for the propagation of their own specific doctrines. In its most simple and attractive form—one at the same time invested with the authority of the reputed holy author—their account of the creation of the world and of man; the origin of sin and redemption, the history of the Cross, and the disputes between body and soul, right and wrong, heaven and hell, were embodied either in "Historiated Bibles" (Paleya) or in special dialogues held between Christ and his disciples, or between renowned Fathers of the Church who expounded these views in a simple manner adapted to the understanding of the people (Lucidaria). The Bogomils taught that God had two sons, the elder Satanal and the younger Michael. The elder son rebelled against the father and became the evil spirit. After his fall he created the lower heavens and the earth and tried in vain to create man; in the end he had to appeal to God for the Spirit. After creation Adam was allowed to till the ground on condition that he sold himself and his posterity to the owner of the earth. Then Michael was sent in the form of a man; he became identified with Jesus, and was "elected" by God after the baptism in the Jordan. When the Holy Ghost (Michael) appeared in the shape of the dove, Jesus received power to break the covenant in the form of a clay tablet (*hierographon*) held by Satanal from Adam. He had now become the angel Michael in a human form; as such he vanquished Satanal, and deprived him of the termination -*el*=God, in which his power resided. Satanal was thus transformed into Satan. Through his machinations the crucifixion took place, and Satan was the originator of the whole Orthodox community with its churches, vestments, ceremonies, sacraments and fasts, with its monks and priests. This world being the work of Satan, the perfect must eschew any and every excess of its pleasure. But the Bogomils did not go as far as to recommend asceticism. They held the "Lord's Prayer" in high respect as the most

¹ These betray their Gnostic (Marcianite) spirit by the anti-Jewish tone of the oldest MSS. extant, though this prejudice tends to decrease in later MSS.

potent weapon against Satan, and had a number of conjurations against "evil spirits." Each community had its own twelve "apostles," and women could be raised to the rank of "elect." The Bogomils wore garments like mendicant friars and were known as keen missionaries, travelling far and wide to propagate their doctrines. Healing the sick and conjuring the evil spirit, they traversed different countries and spread their apocryphal literature along with some of the books of the Old Testament, deeply influencing the religious spirit of the nations, and preparing them for the Reformation. They sowed the seeds of a rich religious popular literature in the East as well as in the West. The Historiated Bible, the Letter from Heaven, the Wanderings through Heaven and Hell, the numerous Adam and Cross legends, the religious poems of the "Kalčki perehozhie" and other similar productions owe their dissemination to a large extent to the activity of the Bogomils of Bulgaria, and their successors in other lands.

History.—The Bogomil propaganda follows the mountain chains of central Europe, starting from the Balkans and continuing along the Carpathian Mountains, the Alps and the Pyrenees, with ramifications north and south (Germany, England and Spain). In the middle of the 8th century the emperor Constantine Copronymus settled a number of Armenian Paulicians in Thracia. These were noted heretics and were persecuted by the Greek Church with fire and sword. The empress Theodora killed, drowned or hanged no fewer than 100,000. In the 10th century the emperor John Zimisceas, himself of Armenian origin, transplanted no less than 200,000 Armenian Paulicians to Europe and settled them in the neighbourhood of Philippopolis, which henceforth became the centre of a far-reaching propaganda. Settled along the Balkans as a kind of bulwark against the invading Bulgars, the Armenians on the contrary soon fraternized with the newcomers, whom they converted to their own views; even a prince of the Bulgarians adopted their teaching. According to Slavonic documents the founder of this sect was a certain priest Bogumil, who "imbibed the Manichaean teaching and flourished at the time of the Bulgarian emperor Peter" (927-968). According to another source the founder was called Jeremiah (or there was another priest associated with him by the name of Jeremiah). The Slavonic sources are unanimous on the point that his teaching was Manichaean. A Synodikon from the year 1210 adds the names of his pupils or "apostles," Mihail, Todur, Dobri, Stefan, Vasilie and Peter, all thoroughly Slavonic names. Zealous missionaries carried their doctrines far and wide. In 1004, scarcely 15 years after the introduction of Christianity into Russia, we hear of a priest Adrian teaching the same doctrines as the Bogomils. He was imprisoned by Leontie, bishop of Kiev. In 1125 the Church in the south of Russia had to combat another heresiarch named Dmitri. The Church in Bulgaria also tried to extirpate Bogomilism. The popes in Rome whilst leading the Crusade against the Albigenses did not forget their counterpart in the Balkans and recommended the annihilation of the heretics.

The Bogomils spread westwards, and settled first in Servia; but at the end of the 12th century Stephen Nemanya, king of Servia, persecuted them and expelled them from the country. Large numbers took refuge in Bosnia, where they were known under the name of Patarcnes (*q.v.*) or Patareni. From Bosnia their influence extended into Italy (Piedmont). The Hungarians undertook many crusades against the heretics in Bosnia, but towards the close of the 15th century the conquest of that country by the Turks put an end to their persecution. It is alleged that a large number of the Bosnian Paterenes, and especially the nobles, embraced Islam (see BOSNIA AND HERZEGOVINA: *History*). Few or no remnants of Bogomilism have survived in Bosnia. The Ritual in Slavonic written by the Bosnian Radoslavov, and published in vol. xv. of the *Siarine* of the South Slavonic Academy at Agram, shows great resemblance to the Cathar ritual published by Cunitz, 1853. See F. Racki, "Bogomili i Patarnai" in *Rad*, vols. vii., viii. and x. (Agram, 1870); Döllinger, *Beiträge zur Ketsergeschichte d. Mittelalters*, 2 vols. (Munich, 1890).

Under Turkish rule the Bogomils lived unmolested as *Pavlikeni* in their ancient stronghold near Philippopolis, and farther northward. In 1650 the Roman Catholic Church gathered them into its fold. No less than fourteen villages near Nicopolis embraced Catholicism, and a colony of *Pavlikeni* in the village of Cioplea near Bucharest followed the example of their brethren across the Danube.

BIBLIOGRAPHY.—Euthymius Zygadenus, *Narratio de Bogomilis*, ed. Gieseler (Göttingen, 1842); J. C. Wolf, *Historia Bogomilorum* (Wittenberg, 1712); "Slovo svyatago Kozmyi na eretiki," in Kukuljević Sakcinski, *Arhiv zapovjestnik jugoslavensku*, vol. iv. pp. 69-97 (Agram, 1859); C. J. Jireček, *Geschichte d. Bulgaren*, pp. 155, 174-175 (Prague, 1876); Korolev, "Dogmatichesko-to uchenie na Bogomil-tie," in *Periodichsko spisanie*, vols. vii.-viii. pp. 75-106 (Braila, 1873); A. Lombard, *Pauliciens, Bulgares et Bons-hommes* (Geneva, 1879); Episcopul Melchisedek, *Lipovenismul*, pp. 265 sqq. (Bucharest, 1871); B. P. Haudeu, *Cronica den bătrâni*, vol. ii. pp. 247 sqq. (Bucharest, 1879); F. C. Conybeare, *The Key of Truth*, pp. 73 sqq. and specially pp. 138 sqq. (Oxford, 1898); M. Gaster, *Greek-Slavonic Literature*, pp. 17 sqq. (London, 1887); O. Dähnhardt, *Natursgen*, vol. I. pp. 38 sqq. (Leipzig and Berlin, 1907). (M. G.)

BOGORODSK, a town of central Russia, in the government of Moscow, and 38 m. by rail E.N.E. of the city of Moscow, on the Klyazma. It has woollen, cotton and silk mills, chemical factories and dye-works, and is famous for its gold brocade. Pop. (1897) 11,210.

BOGOS (BLENS), a pastoral race of mixed Hamitic descent, occupying the highlands immediately north of Abyssinia, now part of the Italian colony of Eritrea. They were formerly a self-governing community, though subject to Abyssinia. The community is divided into two classes, the *Shumaglieh* or "elders" and *Tigré* or "clients." The latter are serfs of the former, who, however, cannot sell them. The *Tigré* goes with the land, and his master must protect him. In blood-money he is worth another *Tigré* or ninety-three cows, while an elder's life is valued at one hundred and fifty-eight cattle or one of his own caste. The eldest son of a *Shumaglieh* inherits his father's two-edged sword, white cows, lands and slaves, but the house goes to the youngest son. Female chastity is much valued, but women have no rights, inherit nothing, and are classed with the hyaena, the most despised animal throughout Abyssinia. The *Bogo* husband never sees the face or pronounces the name of his mother-in-law, while it is a crime for a wife to utter her husband's or father-in-law's name.

BOGOTÁ, or SANTA FÉ DE BOGOTÁ, the capital of the republic of Colombia, and of the interior department of Cundinamarca, in 4° 6' N. lat. and 78° 30' W. long. Pop. about 125,000. The city is on the eastern margin of a large elevated plateau 8563 ft. above sea-level. The plateau may be described as a great bench or shelf on the western slope of the oriental Cordilleras, about 70 m. long and 30 m. wide, with a low rim on its western margin and backed by a high ridge on the east. The plain forming the plateau is well watered with numerous small lakes and streams. These several small streams, one of which, the San Francisco, passes through the city, unite near the south-western extremity of the plateau and form the Rio Funza, or Bogotá, which finally plunges over the edge at Tequendama in a beautiful, perpendicular fall of about 475 ft. The city is built upon a sloping plain at the base of two high mountains La Gaudalupe and Monserrate, upon whose crests stand two imposing churches. From a broad avenue on the upper side downward to the west slope the streets, through which run streams of cool, fresh water from the mountains above. The north and south streets cross these at right angles, and the blocks thus formed are like great terraces. A number of handsomely-laid-out plazas, or squares, ornamented with gardens and statuary, have been preserved; on these face the principal public buildings and churches. In Plaza Bolívar is a statue of Bolívar by Pietro Tenerani (1789-1866), a pupil of Canova, and in Plaza Santandér is one of General Francisco de Paula Santandér (1792-1840). Facing on Plaza de la Constitución are the capitol and cathedral. The streets are narrow and straight, but as a rule they are clean and well paved. Owing to the prevalence of earthquakes, private houses are usually of one storey only, and are built of sun-dried bricks,

white-washed. But few of the public buildings are imposing in appearance, though good taste in style and decoration are often shown.

The city occupies an area of about $2\frac{1}{2} \times 1\frac{1}{2}$ m. It has street cars, electric light and telephones. Short lines of railway connect it with Facativá (24 m.) on the road to Honda, and with Zipaquirá, where extensive salt mines are worked. A line of railway was also under construction in 1906 to Jirardot, at the head of navigation on the upper Magdalena. Bogotá is an archiepiscopal see, founded in 1561, and is one of the strongholds of medieval clericalism in South America. It has a cathedral, rebuilt in 1814, and some 30 other churches, together with many old conventual buildings now used for secular purposes, their religious communities having been dissolved by Mosquera and their revenues devoted in great measure to education. The capitol, which is occupied by the executive and legislative departments, is an elegant and spacious building, erected since 1875. The interest which Bogotá has always taken in education, and because of which she has been called the "Athens of South America," is shown in the number and character of her institutions of learning—a university, three endowed colleges, a school of chemistry and mineralogy, a national academy, a military school, a public library with some 50,000 volumes, a national observatory, a natural history museum and a botanic garden. The city also possesses a well-equipped mint, little used in recent years. The plain surrounding the city is very fertile, and pastures cattle and produces cereals, vegetables and fruit in abundance. It was the centre of Chibcha civilization before the Spanish conquest and sustained a large population. The climate is mild and temperate, the average annual temperature being about 58° and the rainfall about 43½ in. The geographical location of the city is unfavourable to any great development in commerce and manufactures beyond local needs.

Bogotá was founded in 1538 by Gonzalo Jiménez de Quesada and was named Santa Fé de Bogotá after his birthplace Santa Fé, and after the southern capital of the Chibchas, Bacatá (or Funza). It was made the capital of the viceroyalty of Nueva Granada, and soon became one of the centres of Spanish colonial power and civilization on the South American continent. In 1811 its citizens revolted against Spanish rule and set up a government of their own, but in 1816 the city was occupied by Pablo Morillo (1777-1838), the Spanish general, who subjected it to a ruthless military government until 1819, when Bolívar's victory at Boyacá compelled its evacuation. On the creation of the republic of Colombia, Bogotá became its capital, and when that republic was dissolved into its three constituent parts it remained the capital of Nueva Granada. It has been the scene of many important events in the chequered history of Colombia. (A. J. L.)

BOGRA, or **BAGURA**, a town and district of British India, in the Rajshahi division of eastern Bengal and Assam. The town is situated on the right bank of the river Karatoya. Pop. (1901) 7094. The DISTRICT OF BOGRA, which was first formed in 1821, lies west of the main channel of the Brahmaputra. It contains an area of 1359 sq. m. In 1901 the population (on a reduced area) was 854,533, showing an increase of 11% in the decade. The district stretches out in a level plain, intersected by numerous streams and dotted with patches of jungle. The Karatoya river flows from north to south, dividing it into two portions, possessing very distinct characteristics. The eastern tract consists of rich alluvial soil, well watered, and subject to fertilizing inundations, yielding heavy crops of coarse rice, oil-seeds and jute. The western portion of the district is high-lying and produces the finer qualities of rice. The principal rivers are formed by the different channels of the Brahmaputra, which river here bears the local names of the Konai, the Daokoba and the Jamuna, the last forming a portion of the eastern boundary of the district. Its bed is studded with alluvial islands. The Brahmaputra and its channels, together with three minor streams, the Bangali, Karatoya and Atrai, afford admirable facilities for commerce, and render every part of the district accessible to native cargo boats of large burden. The rivers swarm with fish. The former

production of indigo is extinct, and the industry of silk-spinning is decaying. There is no town with as many as 10,000 inhabitants, trade being conducted at riverside marts. Nor are there any metalled roads. Several lines of railway (the Eastern Bengal, &c.), however, serve the district.

BOGUE, DAVID (1750-1825), British nonconformist divine, was born in the parish of Coldingham, Berwickshire. After a course of study in Edinburgh, he was licensed to preach by the Church of Scotland, but made his way to London (1791), where he taught in schools at Edmonton, Hampstead and Camberwell. He then settled as minister of the Congregational church at Gosport in Hampshire (1777), and to his pastoral duties added the charge of an institution for preparing men for the ministry. It was the age of the new-born missionary enterprise, and Bogue's academy was in a very large measure the seed from which the London Missionary Society took its growth. Bogue himself would have gone to India in 1796 but for the opposition of the East India Company. He also had much to do with founding the British and Foreign Bible Society and the Religious Tract Society, and in conjunction with James Bennet, minister at Romsey, wrote a well-known *History of Dissenters* (3 vols., 1809). Another of his writings was an *Essay on the Divine Authority of the New Testament*. He died at Brighton on the 25th of October 1825.

BOGUS (of uncertain origin, possibly connected with the Fr. *bagasse*, sugar-cane refuse), a slang word, originally used in America of the apparatus employed in counterfeiting coins, and now generally of any sham or spurious transaction.

BOHEA (a word derived from the Wu-i hills in the Fukkien province of China, *b* being substituted for *W* or *V*), a kind of black tea (*q.v.*), or, in the 18th and early 19th centuries, tea generally, as in Pope's line, "So past her time 'twixt reading and bohea." Later the name "bohea" has been applied to an inferior quality of tea grown late in the season.

BOHEMIA¹ (Ger. *Böhmen*, Czech *Čechy*, Lat. *Bohemia*), a kingdom and crownland of Austria, bounded N.E. by Prussian Silesia, S.E. by Moravia and Lower Austria, S. by Upper Austria, S.W. by Bavaria and N.W. by Saxony. It has an area of 20,060 sq. m., or about two-thirds the size of Scotland, and forms the principal province of the Austrian empire. Situated in the geographical centre of the European continent, at about equal distance from all the European seas, enclosed by high mountains, and nevertheless easily accessible through Moravia in the Danubian plain and opened by the valley of the Elbe to the German plain, Bohemia was bound to play a leading part in the cultural development of Europe. It became early the scene of important historical events, the avenue and junction of the migration of peoples; and it forms the borderland between the German and Slavonic worlds.

Geography.—Bohemia has the form of an irregular rhomb, of which the northernmost place, Buchberg, just above Hainspach, is at the same time the farthest north in the whole Austro-Hungarian monarchy. From an orographic point of view, Bohemia constitutes amongst the Austrian provinces a separate massif, bordered on three sides by mountain ranges: on the S.W. by the Böhmerwald or Bohemian Forest; on the N.W. by the Erzgebirge or Ore Mountains; and on the N.E. by the Riesengebirge or Giant Mountains and other ranges of the Sudetes. The Böhmerwald, which, like its parallel range, the

¹ As a guide to the English-speaking reader, the following notes on the pronunciation of Bohemian names are appended. The Czech (Cech) alphabet is the same as the English, with the omission of the letters q, w and x. Certain letters, however, vary in pronunciation, and are distinguished by diacritical marks, a device originated by John Huss. The vowels a, e, i, (y), o, u, are pronounced as in Italian; but *ě* = Eng. *ye* in "yet," and *ů* = Eng. *oo*.

The consonants, b, d, f, k, l, m, n, p, r, v, z, are as in English; g = Eng. g in "gone"; s = Eng. initial a. But *ň* = Span. *ñ* (in *cañon*); *f* = ruh; *š* = sh; *ž* = zh (i.e. the French *j*); k before d = g; v before k, p, a, t = f. Of the other consonants c = Eng. ts; *č* = ch; ch = Germ. ch; j = Eng. y, but is not pronounced before d, m, a. Accents on vowels lengthen them; on d and t they are softening marks. H is always pronounced in Czech. At the end of words and before k and t it = Germ. ch; in other places, as in *bakno* (moorass) its pronunciation is somewhat softer.

Sudetes, has a general direction from S.E. to N.W., is divided by the pass of Neumark into two parts. The northern part (Czech *Cesky Les*) attains in the massif of Czerkov an altitude of 3300 ft., but the southern part (Czech *Šumava*) is at the same time the highest and the most picturesque part of the range, including on the Bohemian side the Osser (4053 ft.) and the Plöckenstein (4513 ft.), although the highest peak, the Arber (4872), is in Bavaria. The beauty of this range of mountains consists in its pure crystalline torrents, in the numerous blue lakes of its valleys, and above all in the magnificent forests of oak and pine with which its sides are covered. The pass of Neumark, called also the pass of Neugelein, has always been the principal approach to Bohemia from Germany. It stretches towards the east, above the small town of Taus (Czech *Domálice*, once called *Tukott*, i.e. the Fortress), and is the place where some of the bloodiest battles in the history of Bohemia were fought. Here in the first half of the 7th century Samo repulsed the invading hordes of the Avars, which threatened the independence of the newly-settled Slavonic inhabitants; here also Wratiaslav II. defeated the German emperor Henry III. in a two-days' battle (August 22 and 23, 1040). It was in the same place that the Hussites gained in 1431 one of their greatest victories against a German army of crusaders, and another similar German army was vanquished here by George of Poděbrad.

The Erzgebirge (Czech *Rudo Hory*), which form the north-west frontier, have an average altitude of 2600 ft., and as their highest point, the Keilberg (4080 ft.). The numerous mining villages, the great number of cultivated areas and the easy passes, traversed by good roads, give those mountains in many places the aspect of a hilly undulating plain. Several of the villages are built very near the summit of the mountains, and one of them, Gottesgab (pop. about 1500), lies at an altitude of 3345 ft., the highest place in Bohemia and central Germany. To the west the Erzgebirge combine through the Elstergebirge with the Fichtelgebirge, which in their turn are united with the Böhmerwald through the plateau of Waldsassen. To the east the Erzgebirge are separated from the Elbsandsteingebirge by the Nollendorf pass, traversed by the ancient military route to Saxony; it was the route followed by Napoleon I. after the battle of Dresden (1813). To the south stretches the "Thermopylae of Bohemia," the scene of the battle of Kulm and Arbesau. A little farther to the east the Elbe escapes into Saxony at the lowest point in Bohemia (alt. 367 ft.). The north-east frontier is formed by the Sudetes, which comprise the Lausitzgebirge (2500 ft.), the Isergebirge (with the highest peak, the Tafelfichte, 3683 ft.), the Jeschkegebirge (3322 ft.), and the Riesengebirge. The Riesengebirge (Czech *Krokosť*) are, after the Alps, among the highest mountains of central Europe, and attain in the Schneekoppe an altitude of 5264 ft. The last groups of the Sudetes in Bohemia are the Heuscheuergebirge (2532 ft.) and the Adlergebirge (3664 ft.). The fourth side of the rhomb is formed by the so-called Bohemian-Moravian Hills, a plateau or broad series of low hills, composed of primitive rocks, and attaining in some places an altitude of 2500 ft.

The interior of Bohemia has sometimes been compared to a deep basin; but for the most part it is an undulating plateau, over 1000 ft. high, formed by a succession of terraces, which gradually slope down from south to north. Its lowest-lying points are not in the middle but in the north, in the valley of the Elbe, and the country can be divided into two parts by a line passing through Hohenmauth-Prague-Komotau. The part lying to the south of this line can be designated as highland, and only the part north of it as lowland. The mountain-ranges of the interior of Bohemia are the Brdywald (2798 ft.) in the middle; the Tepler Gebirge (2657 ft.), the Karlsbader Gebirge (3057 ft.) and the Kaiserwald (3238 ft.), in the north-west part; while the northern corner is occupied by the Mittelgebirge (2739 ft.), a volcanic massif, stretching on both sides of the Elbe.

Bohemia belongs to the watershed of the Elbe, which rises within the territory and receives on the right the Iser and the Pölsen, and on the left the Adler; the Eger with its affluent the Tepl; the Biela and the Moldau. But the principal river of

Bohemia, from every point of view, is the Moldau (Czech *Vltava*), not the Elbe. A glance at the hydrographic structure of Bohemia, which is of such a striking regularity, shows us that the Moldau is the main stem, while the Elbe and the other rivers are only lateral branches; moreover, the Elbe below Melnik, the point of its confluence with the Moldau, follows the general direction of the Moldau. Besides, the Moldau is the principal commercial artery of the country, being navigable below Budweis, while the Upper-Elbe is not navigable; its basin (11,800 sq. m.) is twice as great as that of the Elbe, and its width and depth are also greater. It has a length of 270 m., 47 m. longer than the Upper-Elbe, but it runs through a deep and narrow valley, in which there is neither road nor railway, extending from above Budweis to about 15 m. south of Prague. The Moldau receives on the right the Lužniza and the Sazawa and on the left the Wottawa and the Beraun. The Beraun is formed by the union of the Mies with the Radbusa, Angel and Uslawa, and is the third most important river of the country. There are only a few lakes, which are mostly found at high altitudes.

Climate.—Bohemia has a continental, generally healthy climate, which varies much in different parts of the country. It is mildest in the centre, where, e.g. at Prague, the mean annual temperature is 48.5° F. The rainfall varies also according to the districts, the rainy season being the summer. Thus the mean annual rainfall in the interior of Bohemia is 18 in., in the Riesengebirge 40 in., while in the Böhmerwald it reaches 60 to 70 in.

Agriculture.—Favoured with a suitable climate and inhabited by a thriving rural population, Bohemia is very highly developed in the matter of agriculture. Over 50% of the whole area is under cultivation and the soil is in many parts very fertile, the best-known regions being the "Golden Road" round Königgrätz, the "Paradise" round Teplitz, and the "Garden of Bohemia" round Leitmeritz. The principal products are oats, rye, barley and wheat, but since the competition of Hungarian wheat large tracts of land have been converted to the cultivation of beetroot. The potato crop, which forms the staple food of the people, is great; the Saaz district is celebrated for hops, and the flax is also of a good quality. Fruit, especially plums, is very abundant and constitutes a great article of export. The forests cover 29.01% of the total area; meadows, 10.05, pastures 5.05, and gardens 1.35%. Cattle-rearing is not so well developed as agriculture, but great flocks of geese are reared, especially in the south, and bee-cultivation constitutes another important industry. Pisciculture has been for centuries successfully pursued by the Bohemian peasants, and the attempts recently made for the rearing of silkworms have met with fair success.

Minerals.—Except salt, which is entirely absent, almost every useful metal and mineral is to be found. First in importance, both in quantity and in value, come lignite and coal. Some of the richest lignite fields in Europe are found in the north-east corner of Bohemia round Brüx, Dux, Falkenau, Ossegg and Teplitz. Coal is mined round Kladno, Buschtěhrad, Pilsen, Schlan, Rakonitz, Nürschan and Radnitz, the last-named place containing the oldest coal mines of Bohemia (17th century). Iron ores are found at Krušnáhora and Nučic, and the principal foundries are round Kladno and Königshof. Owing to the improvements in refining, Bohemia has become an important centre of the iron industry. Silver is extracted at Pfibram and Joachimsthal, but the silver mines near Kuttenberg, famous in the middle ages, are now abandoned. Lead is extracted at Pfibram, tin at Graupen in the Erzgebirge, the only place in Austria where this metal is found. Antimony is extracted at Millestchau near Tabor; uranium and radium near Joachimsthal; graphite near Krumau and Budweis; porcelain-earth near Carlsbad. Other minerals found in various places of Bohemia are copper, sulphur, cobalt, alum, nickel, arsenic and various sorts of precious stone, like the Bohemian garnet (pyrope), and building stone. A large amount of peat is collected, especially in the south-west of Bohemia, as well as a great quantity of asphalt.

Bohemia possesses over two hundred mineral springs, but only a few are used for medicinal purposes. Among them are

some of the most celebrated mineral springs in the world, such as Carlsbad, Marienbad, Franzensbad, Teplitz-Schönau and Eilin. Other springs of importance are Püllna, Sedlitz and Seidschitz near Brüx; Giesahübl near Carlsbad; Liebwärda, Königswart, Sangerberg, Neudorf, Tetschen, Johannisbad, situated at the foot of the Schneekoppe, &c.

Manufactures and Commerce.—From an industrial point of view, Bohemia takes the first rank amongst the Austrian provinces, and at the same time is one of the greatest manufacturing centres of Europe. Rich as the country is in coal and iron, and in water supplies which can be transformed into motive power, the inhabitants were not slow to utilize these advantages, so that the industry of Bohemia made enormous strides during the last half of the 19th century. The glass industry was introduced from Venice in the 13th century and soon attained a vast importance; the factories are in the neighbourhood of the mountains, where minerals, and especially silica and fuel, are plentiful. The finest product, the crystal-glass, is made round Haida and Steinschönau. The very extensive porcelain industry is concentrated in and around Carlsbad. The textile industry stands in the front rank and is mostly concentrated in the north-east corner of Bohemia, round Reichenberg, and in the valley of the Lower Elbe. The cloth manufacture is located at Reichenberg; Rumburg and Trautenuau are the centre of the linen industry; woollen yarns are made at Aussig and Asch. Lace, which is pursued as a home-industry in the Erzgebirge region, has its principal centre at Weipert, while Strakonitz has the speciality of the manufacture of red fezes (Turkish caps). The metallurgic industries, favoured by the abundance of coal and iron, are concentrated round the mines. Industrial and agricultural machinery are manufactured at Reichenberg, Pilsen and Prague, and at the last-named place is also to be found a great establishment for the production of railway rolling-stock. Sugar refining is another industry, which, although of recent date, has had a very great development, and the breweries produce a beer which is appreciated all over the world. Other important branches of industry are:—the manufacture of chemicals at Prague and Aussig; pencils at Budweis; musical instruments at Gmülitz and Schönbach; paper, leather, dyeing and calico-printing. Hand-in-hand with the industrial activity of the country goes its commercial development, which is stimulated by an extensive railway system, good roads and navigable rivers. The centre of the railway system, which had in 1808 a length of some 3500 m., or 30% of the total length of the Austrian railways, is Prague; and through the Elbe Bohemia has easy access to the sea for its export trade.

Population and Administration.—Bohemia had in 1900 a population of 6,318,280, which corresponds to 315 inhabitants per square mile. As regards numbers, it occupies the second place amongst the Austrian provinces, coming after Galicia, and as regards density of population it stands third, Silesia and Lower Austria, which contains Vienna, standing higher. In 1800 the population was a little over 3,000,000. According to nationality, about 35% are Germans and 65% Czechs. The Czechs occupy the middle of the country, as well as its south and south-east region, while the Germans are concentrated near its borders, especially in the north and west, and are also found all over the country in the large towns. Besides, there are numerous German-speaking enclaves situated in purely Czech districts; on the other hand, the Czechs have shown a tendency to invade the purely German mining and manufacturing districts. Notwithstanding its rich natural resources and its great industrial development, Bohemia sends out a steady flow of emigrants, who either settle in the other provinces of the monarchy, in Germany and in Russia, or cross the Atlantic to America. To the Roman Catholic Church belong 96% of the total population; Bohemia is divided into the archbishopric of Prague, and the three bishoprics of Budweis, Königgrätz and Leitmeritz.

Education is well advanced, and Bohemia has the lowest proportion of illiterates amongst the Austrian provinces. At the head of the educational establishments stand the two universities at Prague, one German and the other Czech.

Bohemia sends 130 deputies to the Reichsrath at Vienna; the local diet, of which belong *ex officio* the archbishop, the three bishops, and the two rectors of the universities, consists of 242 members. For administrative purposes Bohemia is divided into ninety-four districts and two autonomous municipalities, Prague (pop. 204,478), the capital, and Reichenberg (34,304). Other important towns are Pilsen (68,202), Budweis (39,360), Aussig (37,255), Schönau (24,110), Eger (23,605), Warnsdorf (21,150), Brüx (21,525), Gablons (21,086), Asch (18,675), Kladno (18,600), Pardubitz (17,029), Saaz (16,168), Komotau (15,925), Kolin (15,025), Kuttnerberg (14,790), Trautenuau (14,777), Carlsbad (14,640), Pflibram (13,576), Jungbunzlau (13,479), Leitmeritz (13,075), Chrudim (13,017), Dux (11,921), Bodenbach (10,782), Tabor (10,692), Böhmisch-Leipa (10,674), Rumburg (10,382), Weipert (10,037).

See F. Umlauf, *Die Länder Österreich-Ungarns in Wort und Bild*, (15 vols., Vienna, 1881-1889), vol. vii.; Miklowec, *Altösterreich und Denkwürdigkeiten Böhmens* (2 vols., Prague, 1859-1864); F. Rivnák, *Reisehandbuch für das Königreich Böhmen* (Prague, 1882), very useful for its numerous and detailed historical notes. (O. Bz.)

HISTORY

The country derives its name from the Boii, a Celtic tribe which in the earliest historical period inhabited part of the land. According to very ancient traditions accepted by the modern historians of Bohemia, the Boii, whose capital was called Boiohemum, were weakened by continual warfare with neighbouring tribes, and finally subdued by the Teutonic tribe of the Marcomanni (about 12 A.C.). The Marcomanni were afterwards expelled by other Teutonic tribes, and eventually Bohemia was conquered by Slavic tribes, of whom the Čechi (see ЧЕЧЫ) were the most important. The date of the arrival of the Čechi in Bohemia is very uncertain, and the scanty references to the country in classical and Byzantine writers are rather misleading than otherwise. Recent archaeological Slav research has proved the existence of Slavic inhabitants in Bohemia as far back as the beginning of the Christian era. The Čechi appear to have become the masters of the country in the 5th century. The first of their rulers mentioned in history is Samo, who is stated to have defeated the Avars, a Turanian tribe which had for a time obtained the overlordship over Bohemia. Samo also defeated the Franks in a great battle that took place at Wogatisburg (630), probably near the site of the present town of Eger. After the death of Samo the history of Bohemia again becomes absolutely obscure for about 130 years. The next events that are recorded by the oldest chroniclers, such as Cosmas, refer to the foundation of a Bohemian principality by Krok (or Crocus) and his daughter Libussa. The latter is said to have married Přemysl, a peasant who was found ploughing his field—a legend that is common in most Slavic countries. Beginning with this semi-mythic ruler, the ancient chroniclers have constructed a continuous list of Přemyslide princes. Neither the deeds attributed to these princes nor the dates of their reigns can be considered as historical.

From the time of the introduction of Christianity into Bohemia the history of the country becomes less obscure. The first attempts to introduce Christianity undoubtedly came from Germany. They met with little success, as innate distrust of the Germans naturally rendered the Bohemians unfavourable to a creed which reached them from the realm of their western neighbours. Matters were different when Christianity approached them from Moravia, where its doctrine had been taught by Cyrilus and Methodius—Greek monks from Thessalonica. About the year 873 the Bohemian prince Bofivoj was baptized by Methodius, and the Bohemians now rapidly adopted the Christian faith. Of the rulers of Bohemia the most famous at this period was Wenceslas, surnamed the Holy, who in 935 was murdered by his brother Boleslav, and who was afterwards canonized by the Church of Rome. As Wenceslas had been an ally of Germany, his murder resulted in a war with that country, in which, as far as we can judge by the scanty records of the time,

Boleslav, the brother and successor of Wenceslas, was on the whole successful. During the reigns of Boleslav and his son,

Boleslav II., Bohemia extended its frontiers in several directions. Boleslav II. indeed established his rule not only over Bohemia and Moravia, but also over a large part of Silesia, and over that part of Poland which is now the Austrian province of Galicia. Like most Slavic states at this and even a later period, the great Bohemian empire of Boleslav II. did not endure long. Boleslav III., son of Boleslav II., lost all his foreign possessions to Boleslav the Great, king of Poland. During his reign Bohemia was involved in constant civil war, caused by the dissensions between Boleslav III. and his brothers Jaromir and Ulrick. Though the prince succeeded in expelling his brothers from the country, his cruelty induced the Bohemians to dethrone him and to choose as their ruler the Polish prince

Vladivoj, brother of Boleslav the Great, and son of the Bohemian princess Dubravka (Dobrawa). Vladivoj attempted to strengthen his hold over Bohemia by securing the aid of Germany. He consented not only to continue to pay the tribute which the Germans had already obtained from several previous rulers of Bohemia, but also to become a vassal of the German empire and to receive the German title of duke. This state continued when after the death of Vladivoj the Premyslide dynasty was restored. The Premyslide prince **Břetislav I.** (1037-1055) restored the former power of Bohemia, and again added Moravia, Silesia and a considerable part of Poland to the Bohemian dominions. To obviate the incessant struggles which had endangered the land at every vacancy of the throne, Břetislav, with the consent of the nobles, decreed that the oldest member of the house of Premysl should be the ruler of Bohemia. Břetislav was therefore succeeded first by his eldest son Spitiřhřev, and then by his second son **Vratislav**.

In 1088 Vratislav obtained the title of king from the emperor **Henry IV.**, whom he had assisted in the struggle with the papal see which is known as the contest about investitures. Though the title of king was only conferred on Vratislav personally, the German king, Conrad III., conferred on the Bohemian prince Sobeslav (1125-1140) the title of hereditary cupbearer of the Empire, thus granting a certain influence on the election of the emperors to Bohemia, which hitherto had only obligations towards the Empire but no part in its government. In 1156 the emperor Frederick I. Barbarossa ceded Upper Lusatia to the Bohemian prince Vladislav II., and conferred on him the title of king on condition of his taking part in Frederick's Italian campaigns. It was intended that that title should henceforth be hereditary, but it again fell into abeyance during the struggles between the Premyslide princes which followed the abdication of Vladislav in 1173.

The consequences of these constant internal struggles were twofold; the German influence became stronger, and the power of the sovereign declined, as the nobility on whose support the competitors for the crown were obliged to rely constantly obtained new privileges. In 1197 Premysl Ottakar became undisputed ruler of Bohemia, and he was crowned as king in the following year. The royal title of the Bohemian sovereigns was continued uninterruptedly from that date. Wenceslas I. (1230-1253) succeeded his father as king of Bohemia without opposition. The last years of his reign were troubled by internal discord. Wenceslas's son, Premysl Ottakar II., who

Ottakar II. under the sovereignty of his father ruled Moravia, became for a time the chief leader of the malcontents. A reconciliation between son and father, however, took place before the latter's death. Premysl Ottakar II. was one of the greatest of Bohemia's kings. He had during the lifetime of his father obtained possession of the archduchies of Austria, and, about the time of his accession to the Bohemian throne, the nobility of Styria also recognized him as their ruler. These extensions of his dominions involved Premysl Ottakar II. in repeated wars with Hungary. In 1260 he decisively defeated Bela, king of Hungary, in the great battle of Kressenbrunn.

After this victory Ottakar's power rose to its greatest height. He now obtained possession of Carinthia, Istria and parts of northern Italy. His possessions extended from the Giant Mountains in Bohemia to the Adriatic, and included almost all the parts of the present Hababurg empire west of the Leitha. His contemporaries called Ottakar "the man of gold" because of his great wealth, or "the man of iron" because of his military power. From political rather than racial causes Ottakar favoured the immigration of Germans into his dominions. He hoped to find in the German townsmen a counterpoise to the overwhelming power of the Bohemian nobility. In 1273 Rudolph, count of Habsburg, was elected king of the Romans. It is very probable that the German crown had previously been offered to Ottakar, but that he had refused it. Several causes, among others his Slavic nationality, which was likely to render him obnoxious to the Germans, contributed to his decision. As Rudolph immediately claimed as vacant fiefs of the Empire most of the lands held by Ottakar, war was inevitable. Ottakar was deserted by many of his new subjects, and even by part of the Bohemian nobility. He was therefore unable to resist the German king, and was obliged to surrender to him all his lands except Bohemia and Moravia, and to recognize Rudolph as his overlord. New dissensions between the two sovereigns broke out almost immediately. In 1278 Ottakar invaded the Austrian duchies, now under the rule of Rudolph, but was defeated and killed at the battle of Durnkrut on the Marchfeld.

Ottakar's son, Wenceslas II., was only seven years of age at the death of his father, and Otto of Brandenburg, a nephew of Ottakar, for a time governed Bohemia as guardian of the young sovereign. Otto's rule was very unpopular, **Wenceslas II.** an insurrection broke out against him, and Bohemia

was for a time in a state of complete anarchy. The country was at last pacified through the intervention of Rudolph of Habsburg, and at the age of twelve Wenceslas became nominal ruler of the country. All power was, however, in the hands of Zavis of Falkenstein, one of the great Bohemian nobles, who had married the king's mother, Kunegunda. The power of Zavis at last became invidious to the king, by whose order he was beheaded in 1290. Wenceslas, though only nineteen years of age, henceforth governed Bohemia himself, and his short reign was a period of great happiness for the country. Poland also accepted the rule of Wenceslas and the Hungarian crown was offered to him. Towards the end of his reign Wenceslas became involved in war with Albert, archduke of Austria, afterwards king of the Romans. While preparing to invade Austria Wenceslas died suddenly (1305). His son and successor, Wenceslas III., was then only sixteen years of age, and he only ruled over Bohemia for one year. While planning a warlike expedition against Poland, on which country the Bohemian sovereigns now again maintained their claim, he was murdered by unknown assassins (1306). With him ended the rule of the Premyslide dynasty over Bohemia.

Albert, king of the Romans, declared that Bohemia was a vacant fief of the Empire, and, mainly by intimidation, induced the Bohemians to elect his son Rudolph as their sovereign; but Rudolph died after a reign of only one year. Though the Habsburg princes at this period already claimed a hereditary right to the Bohemian throne, the Bohemians determined to maintain their right of electing their sovereign, and they chose Henry, duke of Carinthia, who had married a daughter of King Wenceslas II. Henry soon became unpopular, as he was accused of unduly favouring the German settlers in Bohemia. It was decided to depose him, and the choice of the Bohemians now fell on John of Luxemburg, son of Henry, king of the Romans. The Luxemburg dynasty henceforth ruled over Bohemia up to the time of its extinction at the death of Sigismund (1437). Though King John, by his marriage to the princess Elizabeth, a daughter of Wenceslas II., became more closely connected with Bohemia, he does not appear to have felt much interest in that country. Most of his life was spent in other lands, his campaigns ranging from Italy in the south to Lithuania in the north. It became

John of Luxemburg

proverbial "that nothing could be done in the world without the help of God and of the king of Bohemia." The policy of John was founded on a close alliance with France, the country for which he felt most sympathy. Fighting as an ally of France he fell at the battle of Crécy (1346).

He was succeeded as king of Bohemia by his son Charles, whom the German electors had previously elected as their sovereign at Rense (1346). Charles proved one of the greatest rulers of Bohemia, where his memory is still revered. Prague was his favourite residence, and by the foundation of the *nové město* (new town) he greatly enlarged the city, which now had three times its former extent, and soon also trebled its population. He also added greatly to the importance of the city by founding the famous university of Prague. Charles succeeded in re-establishing order in Bohemia. The country had been in a very disturbed state in consequence of feuds that were incessant during the reign of John, who had almost always been absent from Bohemia. Charles also attempted to codify the obscure and contradictory laws of Bohemia; but this attempt failed through the resistance of the powerful nobility of the country. During the reign of Charles, the first symptoms of that movement in favour of church reform that afterwards acquired a world-wide importance, appeared in Bohemia. As Charles has often been accused of undue subserviency to the Church of Rome, it should be mentioned that he granted his protection to several priests who favoured the cause of church reform. In his foreign policy Charles differed from his father. The relations with France gradually became colder, and at the end of his reign Charles favoured an alliance with England; he died in 1378 at the age of sixty-two, prematurely exhausted by arduous work.

Charles was succeeded by his son Wenceslas, who was then seventeen years of age. His reign marks the decline of the rule of the house of Luxemburg over Bohemia. He was a weak and incapable sovereign, but the very exaggerated accusations against him, which are found principally in the works of older historians, are mainly due to the fact that the king and to a larger extent his queen, Sophia, for a time furthered the cause of church reform, thus incurring the displeasure of Romanist writers. During the earlier part of the reign of Wenceslas a continual struggle took place between the king and the powerful Bohemian nobles, who indeed twice imprisoned their sovereign. Wenceslas also became involved in a dispute with the archbishop, which resulted in the death of the famous John of Nepomuk.

The later part of the reign of Wenceslas is a record of incipient religious conflict. The hold of the Church of Rome on Bohemia had already been weakened during the reign of King Charles by attacks on the immorality of the clergy, which proceeded from pious priests such as Milíč and Waldhauser. The church schism, during which the rival pontiffs assailed each other with all the wild threats and oburgations of medieval theological strife, necessarily alienated the Bohemians to a yet greater extent. Almost the whole Bohemian nation therefore espoused the cause of Huss (*q.v.*). Wenceslas on the occasion of these disputes displayed the weakness and irresolution that always characterized him, but Queen Sophia openly favoured the cause of Huss, who for some time was her confessor. Huss was tried before the council of Constance (*q.v.*), to which he had proceeded with a letter of safe conduct given by Wenceslas's brother Sigismund, king of the Romans. He was declared a heretic and burnt on the 6th of July 1415. The inevitable and immediate result of this event was the outbreak of civil war in Bohemia, where Huss was greatly revered by the large majority of the population. The nobles of Bohemia and Moravia met at Prague on the 2nd of September 1415, and sent to the council the famed *Protestatio Bohemorum*, in which they strongly protested against the execution of Huss, "a good, just and catholic man who had for many years been favourably known in the Kingdom by his life, conduct and fame, and who had been convicted of no offence." They further declared that all who affirmed that heresy existed

in Bohemia were "liars, vile traitors and calumniators of Bohemia and Moravia, the worst of all heretics, full of all evil, sons of the devil." They finally stated "that they would defend the law of our Lord Jesus Christ and its pious, humble and steadfast preachers at the cost of their blood, scorning all fear and all human decrees that might be contrary to them."¹ This protest was a declaration of war against the Roman church, and marks the beginning of the Hussite wars. The council, indeed, summoned the nobles before its tribunal, but they refused to appear. A large number of the nobles and knights who had met at Prague formed a confederacy and declared that they consented to freedom of preaching the word of God on their estates, that they declined to recognize the authority of the council of Constance, but would obey the Bohemian bishops and a future pope lawfully elected. Meanwhile they declared the university of Prague the supreme authority in all matters of religion. The members of the confederacy attempted, though unsuccessfully, to induce King Wenceslas to become their leader. The Romanist nobles, who were not numerous, but some of whom owned vast estates, now also formed a confederacy, pledging themselves to support the pope and the council. After the closing of the council in 1418, Sigismund, who—Wenceslas being childless—was heir to the Bohemian throne, sent a letter to his brother, which was practically a manifesto addressed to the Bohemian people. He threatened with the severest penalties all who should continue to resist the authority of Rome. Wenceslas maintained the vacillating attitude that was characteristic of his whole reign, though Queen Sophia still extended her protection to the reformers. By doing this, indeed, she incurred the wrath of the Church to so great an extent that an act of accusation against her was drawn up at the council of Constance. Intimidated by his brother, Wenceslas now attempted to stem the current of religious enthusiasm. Immediately after the death of Huss many priests who refused to administer communion in the two kinds—now the principal tenet of the adherents of Huss—had been expelled from their parishes. Wenceslas decreed that they should be reinstated, and it was only after some hesitation that he even permitted that religious services according to the Utraquist doctrine should be held in three of the churches of Prague. Some of the more advanced reformers left Prague and formed the party known as the Taborites, from the town of Tabor which became their centre. Troubles soon broke out at Prague. When on the 30th of July 1419, the Hussite priest, John of Zelivo, was leading a procession through the streets of Prague, stones were thrown at him and his followers from the town hall of the "new town." The Hussites, led by John Žižka (*q.v.*), stormed the town-hall and threw the magistrates from its windows. On receiving the news of these riots King Wenceslas was immediately seized by an attack of apoplexy; a second fit on the 16th of August ended his life.

The news of the death of the king caused renewed rioting in Prague and many other Bohemian cities, from which many Germans, mostly adherents of the Church of Rome, were expelled. Finally a temporary truce was concluded, and, early in the following year, Sigismund, who now claimed the Bohemian crown as successor of his brother, arrived at Kutna Hora (Kuttenberg). Pope Martin V. on the 1st of March 1420 proclaimed a crusade against Bohemia, and crusaders from all parts of Europe joined Sigismund's army. "On the 30th day of June the Hungarian king, Sigismund, with a large army consisting of men of various countries, as well as of Bohemians, occupied the castle of Prague, determined to conquer the city, which they considered a heretical community because they used the sacred chalice and accepted other evangelical truths."² But the attempt of the crusaders to conquer Prague failed, and after an attack by them on the Vitkov (now Žizkov) hill had been repulsed by the desperate bravery of the Taborites, led by Žižka, Sigismund determined to abandon

¹ *Protestatio Bohemorum*, frequently printed in English and German, as well as in the Latin original.

² Laurence of Bézova's (contemporary) *Kronika Husitiská*.

the siege of Prague. An attempt of Sigismund to relieve the besieged garrison of the Vyšehrad fortress on the outskirts of Prague also failed, as he was again entirely defeated at the battle of the Vyšehrad (November 1, 1420).

Royal authority now ceased in Bohemia. At a meeting of the diet at Caslav (June 1, 1421) Sigismund was deposed. It was decided that a Polish prince should be chosen as sovereign, and that meanwhile a provisional government, composed of twenty men belonging to the various parties, should be established. In 1422 Sigismund again invaded Bohemia, but was decisively defeated by Žižka at Nemečský Brod (Deutschbrod). The Polish prince, Sigismund Korybutovič, now arrived in Bohemia, and was recognized as regent by the large majority of the inhabitants; but through the influence of the papal see

he was recalled by the rulers of Poland after a stay of only a few months. After his departure, civil war between the moderate Hussites (Calixtines or Utraquists) and the advanced Taborite party broke out for the first time, though there had previously been isolated disturbances between them. The return of Prince Korybutovič and the menace of a German invasion soon reunited the Bohemians, who gained a decisive victory over the Germans at Aussig in 1426. Shortly afterwards Korybutovič, who had taken part in this great victory, incurred the dislike of the extreme Hussites, and was obliged to leave Bohemia. All hope of establishing an independent Slav dynasty in Bohemia thus came to an end. In 1427 several German princes undertook a new crusade against the Hussites. With the German and other invaders were 1000 English archers, bodyguard to Henry Beaufort, bishop of Winchester, who took part in the crusade as papal legate. The crusaders were seized by a sudden panic, both at Mies (Střibro) and at Tachau, as soon as they approached the Hussites, and they fled hurriedly across the mountains into Bavaria. Though internal disturbances again broke out, the Bohemians after this success assumed the offensive, and repeatedly invaded Hungary and the German states.

The impossibility of conquering Bohemia had now become obvious, and it was resolved that a council should meet at Basel (q.v.) to examine the demands of the Hussites. The Germans, however, influenced by Sigismund, determined to make a last attempt to subdue Bohemia by armed force. The Bohemians, as usual united in the moment of peril, defeated the Germans at Domažlice (Taus) on the 1st of August 1431, after a very short fight. In the course of the same year negotiations began at Basel, the Hussites being represented by a numerous embassy under the leadership of Prokop the Great. The negotiations proceeded very slowly, and in 1433 the Bohemians returned to their own country, accompanied, however, by envoys of the council. Dissensions had meanwhile again broken out in Bohemia, and they were now of a political rather than a religious nature. The more aristocratic Hussites raised an armed force which was known as "the army of the nobles." The Taborites also collected their men, who formed "the army of the towns." The two armies met at Lipan, near Kolin, on the 30th of May 1434. The Taborites were defeated, and the two Prokops and most of their other leaders perished on the battlefield. The victory of the moderate party paved the way to a reconciliation with Sigismund and the Church of Rome. The Bohemians

recognized Sigismund as their sovereign, but obtained considerable concessions with regard to religious matters. These concessions, which were formulated in the so-called Compacts, granted to the Bohemians the right of communion in both kinds, and of preaching the gospel freely, and also to a certain extent limited the power of the clergy to acquire worldly goods.

After the Compacts had been formally recognized at Iglau in Moravia, Sigismund proceeded to Prague and was accepted as king. He died in the following year (1437) and was succeeded by his son-in-law, Albert of Austria, whom the estates chose as their king. Albert died after he had reigned over Bohemia less than two years. Though it was known that Albert's widow Elizabeth would shortly give birth to a child, the question as to

the succession to the throne again arose; for it was only in 1627 that the question whether the Bohemian crown was elective or hereditary was decided for ever. The nobles formed two parties, one of which, the national one, had George of Poděbrad (q.v.) as its leader. Ulrich of Rosenberg George of Poděbrad was the leader of the Roman or Austrian division of the nobility. The two parties finally came to an agreement known as the "Letter of Peace" (*list mírný*). Those who signed it pledged themselves to recognise the Compacts, and to support as archbishop of Prague, John of Rokycan, who had been chosen by the estates in accordance with an agreement made simultaneously with the Compacts, but whom the Church of Rome refused to recognize. On the other hand, the national party abandoned the candidature to the throne of Prince Casimir of Poland, thus paving the way to the eventual succession of Albert's heir. On the 22nd of February 1440 Queen Elizabeth gave birth to a son, who received the name of Ladislas. The Bohemians formally acknowledged him as their king, though only after their crown had been declined by Albert, duke of Bavaria. Ladislas remained in Austria under the guardianship of his uncle Frederick, duke of Styria, afterwards the emperor Frederick III., and Bohemia, still without regular government, continued to be the scene of constant conflicts between the rival parties of the nobility. In 1446 a general meeting of the estates of Bohemia together with those of Moravia, Silesia and Lusatia—and so-called "lands of the Bohemian crown"—took place. This meeting has exceptional importance for the constitutional history of Bohemia. It was decreed that at the meeting of the estates their members should be divided into three bodies—known as *curiæ*—representing the nobles, the knights and the towns. These *curiæ* were to deliberate separately and only to meet for a final decision. An attempt made at this meeting to appoint a regent was unsuccessful. The negotiations with the papal see continued meanwhile, but led to no result, as the members of the Roman party used their influence at the papal court for the purpose of dissuading it from granting any concessions to their countrymen. Shortly after the termination of the diet of 1446 George of Poděbrad therefore determined to appeal to the fortune of war. He assembled a considerable army at Kutna Hora and marched on Prague (1448). He occupied the town almost without resistance and assumed the regency over the kingdom. The diet in 1451 recognized his title, which was also sanctioned by the emperor Frederick III., guardian of the young king. Poděbrad was none the less opposed, almost from the first, by the Romanists, who even concluded an alliance against him with their extreme opponents, Kolda of Zampach and the other remaining Taborites. In October 1453 Ladislas arrived in Bohemia and was crowned king at Prague; but he died somewhat suddenly on the 23rd of November 1457. George of Poděbrad has from the first frequently been accused of having poisoned him, but historical research has proved that this accusation is entirely unfounded. The Bohemian throne was now again vacant, for, when electing Ladislas the estates had reaffirmed the elective character of the monarchy. Though there were several foreign candidates, the estates unanimously elected George of Poděbrad, who had now for some time administered the country. Though the Romanist lords, whom Poděbrad had for a time won over, also voted for him, the election was considered a great victory of the national party and was welcomed with enthusiasm by the citizens of Prague.

During the earlier and more prosperous part of his reign the policy of King George was founded on a firm alliance with Matthias Corvinus, king of Hungary, through whose influence he was crowned by the Romanist bishop of Waitzen. The reign of King George, whose principal supporters were the men of the smaller nobility and of the towns, was at first very prosperous. After a certain time, however, some of the Romanist nobles became hostile to the king, and, partly through their influence, he became involved in a protracted struggle with the papal see. It was in consequence of this struggle that some of George's far-reaching plans—he endeavoured for a time to obtain the supremacy over Germany—failed. After the negotiations

with Rome had proved unsuccessful George assembled the estates at Prague in 1452 and declared that he would to his death remain true to the communion in both kinds, and that he was ready to risk his life and his crown in the defence of his faith. The Romanist party in Bohemia became yet more embittered against the king, and at a meeting at Zelena Hora (Grünberg) in 1465 many nobles of the Roman religion joined in a confederacy against him. In the following year Pope Paul II. granted his moral support to the confederates by pronouncing sentence of excommunication against George of Poděbrad and by releasing all Bohemians from their oath of allegiance to him. It was also through papal influence that King Matthias of Hungary, deserting his former ally, supported the lords of the league of Zelena Hora. Desultory warfare broke out between the two parties, in which George was at first successful; but fortune changed when the king of Hungary invaded Moravia and obtained possession of Brunn, the capital of the country. At a meeting of the Catholic nobles of Bohemia and Moravia at Olmütz in Moravia, Matthias was proclaimed king of Bohemia (May 3, 1469). In the following year George obtained some successes over his rival, but his death in 1471 for a time put a stop to the war. George of Poděbrad, the only Hussite king of Bohemia, has always, with Charles IV., been the ruler of Bohemia whose memory has most endeared itself to his countrymen.

George of Poděbrad had undoubtedly during the more prosperous part of his reign intended to found a national dynasty. In later years, however, hope of obtaining aid from Poland in his struggle against King Matthias induced him to offer the succession to the Bohemian throne to Vladislav (Wladislaus, Ladislaus), son of Casimir, king of Poland. No formal agreement was made, and at the death of George many Bohemian nobles supported the claim of Matthias of Hungary, who had already been proclaimed king of Bohemia. Protracted negotiations ensued, but they ended by the election of Prince Vladislav of Poland at Kutna Hora, the 27th of May 1471. This election was a victory of the national party, and may be considered as evidence of the strong anti-clerical feeling which then prevailed in Bohemia; for Matthias was an unconditional adherent of Rome, while the Polish envoys who represented Vladislav promised that he would maintain the Compacts. At the beginning of his reign the new king was involved in a struggle with Matthias of Hungary, who maintained his claim to the Bohemian throne. Prolonged desultory warfare continued up to 1478, when a treaty concluded at Olmütz secured Bohemia to Vladislav; Matthias was to retain the so-called "lands of the Bohemian crown"—Moravia, Silesia and Lusatia—during his lifetime, and they were to be restored to Bohemia after his death. Though Vladislav was faithful to his promise of maintaining the Compacts, and did not attempt to prevent the Bohemians from receiving the communion in both kinds, yet his policy was on the whole a reactionary one, both as regards matters of state and the religious controversies. The king appointed as government officials at Prague men of that section of the Utraquist party that was nearest to Rome, while a severe persecution of the extreme Hussites known as the Bohemian Brethren took place (see HUSSITES). Serious riots took place at Prague, and the more advanced Hussites stormed the three town halls of the city. The nobles of the same faith also formed a league to guard themselves against the menaced reaction. A meeting of all the estates at Kutna Hora in 1485, however, for a time restored peace. Both parties agreed to respect the religious views of their opponents and to abstain from all violence, and the Compacts were again confirmed.

As regards matters of state the reign of Vladislav is marked by a decrease of the royal prerogative, while the power of the nobility attained an unprecedented height, at the expense, not only of the royal power, but also of the rights of the townsmen and peasants. A decree of 1487 practically established serfdom in Bohemia, where it had hitherto been almost unknown. It is impossible to exaggerate the importance of this measure for the future of Bohemia. The rulers of the country were henceforth unable to rely on that numerous sturdy and independent

peasantry of which the armies of Žižka and the Prokops had mainly consisted. Various enactments belonging to this reign also curtailed the rights of the Bohemian townsmen. A decree known as the "regulations of King Vladislav" codified these changes. It enumerated all the rights of the nobles and knights, but entirely ignored those of the towns. It was tacitly assumed that the townsmen had no inherent rights, but only such privileges as might be granted them by their sovereign with the consent of the nobles and knights. Civil discord was the inevitable consequence of these enactments. Several meetings of the diet took place at which the towns were not represented. The latter in 1513 formed a confederacy to defend their rights, and chose Prince Bartholomew of Münsterberg—a grandson of King George—as their leader.

Vladislav was elected king of Hungary in 1490 and many of the events of his later life belong to the history of Hungary. He married in 1502 Anna de Candale, who was connected with the royal family of France. He had two children by her, Anna, who afterwards married the archduke Ferdinand of Austria, and Louis. Vladislav died in Hungary in 1516. His successor was his son Louis, who had already been crowned as king of Bohemia at the age of three. According to the instructions of Vladislav, Sigismund, king of Poland, and the emperor Maximilian I. were to act as guardians of the young king. The Bohemian estates recognized this decision, but they refused to allow the guardians any right of interference in the affairs of Bohemia. The great Bohemian nobles, and in particular the supreme burgrave, Zdeněk Leo, lord of Rožmítal, ruled the country almost without control. The beginning of the nominal reign of King Louis is marked by an event which had great importance for the constitutional development of Bohemia. At a meeting of the estates in 1517 known as the diet of St Wenceslas—as the members first assembled on the 28th of September, the anniversary of that saint—they came to terms and settled the questions which had been the causes of discord. The citizens renounced certain privileges which they had hitherto claimed, while the two other estates recognized their municipal autonomy and tacitly sanctioned their presence at the meetings of the diet, to which they had already been informally readmitted since 1508. At the first sitting of this diet, on the 24th of October, it was declared that the three estates had agreed henceforth "to live together in friendly intercourse, as became men belonging to the same country and race." In 1522 Louis arrived in Bohemia from Hungary, of which country he had also been elected king. On his arrival at Prague he dismissed all the Bohemian state officials, including the powerful Leo of Rožmítal. He appointed Charles of Münsterberg, a cousin of Prince Bartholomew and also a grandson of King George, as regent of Bohemia during his absences, and John of Wartenberg as burgrave. The new officials appear to have supported the more advanced Hussite party, while Rožmítal and the members of the town council of Prague who had acted in concert with him had been the allies of the Romanists and those Utraquists who were nearest to the Church of Rome. The new officials thus incurred the displeasure of King Louis, who was at that moment seeking the aid of the pope in his warfare with Turkey. The king therefore reinstated Leo of Rožmítal in his offices in 1525. Shortly afterwards Rožmítal became involved in a feud with the lords of Rosenberg; the feud became a civil war, in which most of the nobles and cities of Bohemia took sides. Meanwhile Louis, who had returned to Hungary, opened his campaign against the Turks. He requested aid from his Bohemian subjects, and this was granted by the Rosenberg faction, while Rožmítal and his party purposely delayed sending any forces to Hungary. There were, therefore, but few Bohemian troops at the battle of Mohács (August 29, 1526) at which Louis was decisively defeated and perished.

The death of Louis found Bohemia in a state of great disorder, almost of anarchy. The two last kings had mainly resided in Hungary, and in spite of the temporary agreement obtained at the diet of St Wenceslas, the Bohemians had not succeeded in establishing a strong indigenous government which might have

taken the place of the absentee monarchs. Archduke Ferdinand of Austria—afterwards the emperor Ferdinand I.—laid claim to the Bohemian throne as husband of Anna, daughter of King Vladislav. King Sigismund of Poland, the dukes Louis and William of Bavaria, several other German princes, as well as several Bohemian noblemen, of whom Leo of Rožmál was the most important, were also candidates. The diet resolved to entrust the election to twenty-four of their members, chosen in equal number from the three estates. These electors, on the 23rd of October (1526), chose Ferdinand of Habsburg as their king. This date is memorable, as it marks the permanent accession of the Habsburg dynasty to the Bohemian throne, though the Austrian archdukes Rudolph and Albert had previously been rulers of Bohemia for short periods. Though Ferdinand fully shared that devotion to Rome which is traditional in the Habsburg dynasty, he showed great moderation in religious matters, particularly at the beginning of his reign. His principal object was to establish the hereditary right of his dynasty to the Bohemian throne, and this object he pursued with characteristic obstinacy. When a great fire broke out at Prague in 1541, which destroyed all the state documents, Ferdinand obtained the consent of the estates to the substitution of a charter stating that he had been recognized as king in consequence of the hereditary rights of his wife Anna, in the place of the former one, which had stated that he had become king by election. This caused great dissatisfaction and was one of the principal causes of the troubles that broke out shortly afterwards. Ferdinand had in 1531, mainly through the influence of his brother the emperor Charles V., been elected king of the Romans and heir to the Empire. He henceforth took a large part in the politics of Germany, particularly after he had in 1547 concluded a treaty of peace with Turkey, which assured the safety of the eastern frontiers of his dominions. Charles V. about the same time concluded his war with France, and the brothers determined to adopt a firmer policy towards the Protestants of Germany, whose power had recently greatly increased. The latter had, about the time of the recognition of Ferdinand as king of the Romans, and partly in consequence of that event, formed at Schmalkalden a league, of which John Frederick, elector of Saxony, and Philip, landgrave of Hesse, were the leaders. War broke out in Germany in the summer of 1546, and Charles relied on the aid of his brother, while the German Protestants on the other hand appealed to their Bohemian co-religionists for aid.

Since the beginning of the Reformation in Germany the views of the Bohemian reformers had undergone a considerable change. Some of the more advanced Utraquists differed but little from the German Lutherans, while the Bohemian Brethren, who at this moment greatly increased in influence through the accession of several powerful nobles, strongly sympathized with the Protestants of Germany. Ferdinand's task of raising a Bohemian army in support of his brother was therefore a difficult one. He again employed his usual tortuous policy. He persuaded the estates to vote a general levy of the forces of the country under the somewhat disingenuous pretext that Bohemia was menaced by the Turks; for at that period no armed force could be raised in Bohemia without the consent of the estates of the realm. Ferdinand fixed the town of Kaaden on the Saxon frontier as the spot where the troops were to meet, but on his arrival there he found that many cities and nobles—particularly those who belonged to the community of the Bohemian Brethren—had sent no men. Of the soldiers who arrived many were Protestants who sympathized with their German co-religionists. The Bohemian army refused to cross the Saxon frontier, and towards the end of the year 1546 Ferdinand was obliged to disband his Bohemian forces. Early in the following year he again called on his Bohemian subjects to furnish an army in aid of his brother. Only a few of the Romanists and more retrograde Utraquists obeyed his order. The large majority of Bohemians, on the other hand, considered the moment opportune for recovering the ancient liberties of Bohemia, on which Ferdinand had encroached

in various ways by claiming hereditary right to the crown and by curtailing the old privileges of the land. The estates met at Prague in March 1547, without awaiting a royal summons—undoubtedly an unconstitutional proceeding. The assembly, in which the influence of the representatives of the town of Prague and of the knights and nobles who belonged to the Bohemian Brotherhood was predominant, had a very revolutionary character. This became yet more marked when the news of the elector of Saxony's victory at Rochlitz reached Prague. The estates demanded the re-establishment of the elective character of the Bohemian kingdom, the recognition of religious liberty for all, and various enactments limiting the royal prerogative. It was decided to entrust the management of state affairs to a committee of twelve members chosen in equal number from the three estates. Of the members of the committee chosen by the knights and nobles four belonged to the Bohemian Brotherhood. The committee decided to equip an armed force, the command of which was conferred on Kaspar Pflug of Rabenstein (d. 1576). According to his instructions he was merely to march to the Saxon frontier, and there await further orders from the estates; there seems, however, little doubt that he was secretly instructed to afford aid to the German Protestants. Pflug marched to Joachimsthal on the frontier, but refused to enter Saxon territory without a special command of the estates.

Meanwhile the great victory of the imperialists at Mühlberg had for a time crushed German Protestantism. The Bohemians were in a very difficult position. They had seriously offended their sovereign and yet afforded no aid to the German Protestants. The army of Pflug hastily dispersed, and the estates still assembled at Prague endeavoured to propitiate Ferdinand. They sent envoys to the camp of the king who, with his brother Charles, was then besieging Wittenberg. Ferdinand received the envoys better than they had perhaps expected. He indeed always maintained his plan of making Bohemia a hereditary kingdom under Habsburg rule, and of curtailing as far as possible its ancient constitution, but he did not wish to drive to despair a still warlike people. Ferdinand demanded that the Bohemians should renounce all alliances with the German Protestants, and declared that he would make his will known after his arrival in Prague. He arrived there on the 20th of July, with a large force of Spanish and Walloon mercenaries, and occupied the city almost without resistance. Ferdinand treated the nobles and knights with great forbearance, and contented himself with the confiscation of the estates of some of those who had been most compromised. On the other hand he dealt very severely with the towns—Prague in particular. He declared that their ancient privileges should be revised—a measure that practically signified a broad confiscation of lands that belonged to the municipalities. Ferdinand also forced the townsmen to accept the control of state officials who were to be called town-judges and in Prague town-captains. These royal representatives were given almost unlimited control over municipal affairs. The Bohemian Brethren were also severely persecuted, and their bishop Augusta was imprisoned for many years.

Ferdinand's policy here was as able as it always was. The peasantry had ceased to be dangerous since the establishment of serfdom; the power of the cities was now thoroughly undermined. Ferdinand had only to deal with the nobles and knights, and he hoped that the influence of his court, and yet more that of the Jesuits, whom he established in Bohemia about this time, would gradually render them amenable to the royal will. If we consider the customs of his time Ferdinand cannot be considered as having acted with cruelty in the moment of his success. Only four of the principal leaders of the revolt—two knights, and two citizens of Prague—were sentenced to death. They were decapitated on the square outside the Hradčany palace where the estates met on that day (August 22). This diet therefore became known as the "Krvavý sněm" (bloody diet). In one of the last years of his life (1562) Ferdinand succeeded in obtaining the coronation of his eldest son Maximilian as king of Bohemia, thus ensuring to him the succession to the Bohemian throne. As Ferdinand I. acceded to the Hungarian throne at

the same time as to that of Bohemia, and as he also became king of the Romans and after the death of Charles V. emperor, many events of his life do not belong to the history of Bohemia. He died in 1564.

Maximilian succeeded his father as king of Bohemia without any opposition. Circumstances were greatly in his favour; he

had in his youth mainly been educated by Protestant tutors, and for a time openly avowed strong sympathy for the party of church reform. This fact, which became known in Bohemia, secured for him the support of the Bohemian church reformers, while the Romanists and retrograde Utraquists were traditionally on the side of the house of Habsburg. The reign of Maximilian did not fulfil the hopes that met it. Though he published new decrees against the Bohemian Brethren, he generally refused to sanction any measures against the Protestants, in spite of the advice of the Jesuits, who were gradually obtaining great influence in Bohemia. He did nothing, however, to satisfy the expectations of the partisans of church reform, and indeed after a time he again to assist at the functions of the Roman church, from which he had long absented himself. Indifference, perhaps founded on religious scepticism, characterized the king during the many ecclesiastical disputes that played so large a part in his reign. In 1567 Maximilian, who had also succeeded his father as king of Hungary and emperor, visited the Bohemians for the first time since his accession to the throne. Like most princes of the Habsburg dynasty, he was constantly confronted at this period by the difficulty of raising funds for warfare against the Turks. When he asked the Bohemians to grant him supplies for this purpose, they immediately retorted by bringing forward their demands with regard to matters of religion. Their principal demand appears somewhat strange in the light of the events of the past. The estates expressed the wish that the celebrated Compacts should cease to form part of the laws of the country. These enactments had indeed granted freedom of worship to the most moderate Utraquists—men who, except that they claimed the right to receive the communion in both kinds, hardly differed in their faith from the Roman church. On the other hand Ferdinand I. had used the Compacts as an instrument which justified him in oppressing the Bohemian Brethren, and the advanced Utraquists, whose teaching now differed but little from that of Luther. He had argued that all those who professed doctrines differing from the Church of Rome more widely than did the retrograde Utraquists, were outside the pale of religious toleration. Maximilian, indifferent as usual to matters of religious controversy, consented to the abolition of the Compacts, and these enactments, which had once been sacred to the Bohemian people, perished unregretted by all parties. The Romanists had always hated them, believing them not to be in accord with the general custom of the papal church, while the Lutherans and Bohemian Brethren considered their suppression a guarantee of their own liberty of worship.

In 1575 Maximilian, who had long been absent from Bohemia, returned there, as the estates refused to grant subsidies to an absentee monarch. The sittings of the diet that met in 1575 were very prolonged. The king maintained a vacillating attitude, influenced now by the threats of the Bohemians, now by the advice of the papal nuncio, who had followed him to Prague. The latter strongly represented to him how great would be the difficulties that he would encounter in his other dominions, should he make concessions to the Protestants of Bohemia. The principal demand of the Bohemians was that the "Confession of Augsburg"—a summary of Luther's teaching—should be recognized in Bohemia. They further renewed the demand, which they had already expressed at the diet of 1567, that the estates should have the right of appointing the members of the consistory—the ecclesiastical body which ruled the Utraquist church; for since the death of John of Rokycan that church had had no archbishop. After long deliberations and the king's final refusal to recognize the confession of Augsburg, the majority of the diet, consisting of members of the Bohemian brotherhood and advanced Utra-

quists, drew up a profession of faith that became known as the *Confessio Bohemica*. It was in most points identical with the Augsburg confession, but differed from it with regard to the doctrine of the sacrament of the Lord's Supper. Here the Bohemian profession agreed with the views of Calvin rather than with those of Luther. This is undoubtedly due to the influence of the Bohemian Brethren. The *Confessio Bohemica* was presented to Maximilian, who verbally expressed his approval, but would not consent to this being made public, and also refused his consent to the inclusion of the *Confessio* among the charters of the kingdom. Maximilian rejected the demand of the Bohemian estates, that they and not the king should in future appoint the members of the consistory. He finally, however, consented to exempt the Lutherans and advanced Utraquists from the jurisdiction of the consistory, and allowed them to choose fifteen defenders—five of whom were to belong to each of the estates—who were to have supreme control over the Lutheran church. These defenders were to appoint for each district a superintendent (moderator), who was to maintain order and discipline among the clergy. As the Bohemian Brotherhood had never recognized the consistory, that body now lost whatever influence it had still possessed. It became, indeed, subservient to the Romanist archbishopric of Prague, which had been re-established by Ferdinand I. Its members henceforth were men who on almost all points agreed with Rome, and sometimes even men who had joined the Roman church, but continued by order of their superiors to remain members of the consistory, where it was thought that their influence might be useful to their new creed.

The results of the diet of 1575 were on the whole favourable to the estates, and they seem to have taken this view, for almost immediately afterwards they recognized Maximilian's eldest son Rudolph as his successor and consented to his being crowned king of Bohemia. Maximilian died in the following year, and Rudolph succeeded him without any opposition. The events of the last years of the reign of Rudolph have the greatest importance for Bohemian history, but the earlier part of his reign requires little notice. As Rudolph had been educated in Spain it was at first thought that he would treat the Bohemian church reformers with great severity. The new sovereign, however, showed with regard to the unceasing religious controversy the same apathy and indifference with which he also met matters of state. He had been from his early youth subject to fits of melancholia, and during several short periods was actually insane. Rudolph was a great patron of the arts, and he greatly contributed to the embellishment of Prague, which, as it was his favourite residence, became the centre of the vast Habsburg dominions. In 1600 the mental condition of Rudolph became so seriously impaired that the princes of the house of Habsburg thought it necessary to consider the future of the state, particularly as Rudolph had no legitimate descendants. Matthias, the eldest of his brothers, came to Prague and pointed out to Rudolph the necessity of appointing a coadjutor, should he be incapacitated from fulfilling his royal duties, and also of making arrangements concerning the succession to the throne. These suggestions were indignantly repelled by Rudolph, whose anger was greatly increased by a letter of Pope Clement VIII. The pope in a forcible though formally courteous manner pointed out to him the evil results which his neglect of his royal duties would entail on his subjects, and called on him to appoint one of the Habsburg princes his successor both to the imperial crown and to the thrones of Bohemia and Hungary. It is probable that the fear that the pope might make good the threats contained in this letter induced Rudolph, who had hitherto been indifferent to matters of religion, to become more subservient to the Roman church. The papal nuncio at Prague, in particular, appears for a time to have obtained great influence over the king. Under this influence, Rudolph in 1602 issued a decree which renewed obsolete enactments against the Bohemian Brethren that had been published by King Vladislav in 1508. The royal decree was purposely worded in an obscure manner. It referred to the Compacts that had

Admission of the "Compacts."

Rudolph.

been abolished, and was liable to an interpretation excluding from tolerance all but the Romanists and the retrograde Utraquists. It appeared therefore as a menace to the Lutherans—and all the more advanced Utraquists had now embraced that creed—as well as to the Bohemian Brethren. The estates of Bohemia met at Prague in January 1603. The discussions were very stormy. Budovec of Budova, a nobleman belonging to the community of the Bohemian Brethren, became the leader of all those who were opposed to the Church of Rome. He vigorously attacked the royal decree, which he declared to be contrary to the promises made by King Maximilian. He, however, advised the estates to vote the supplies that King Rudolph had demanded. Immediately after this vote had been passed, the diet was closed by order of the king. Though the royal power was at that period very weak in Bohemia, the open partisanship of the king encouraged the Romanist nobles, who were not numerous, but among whom were some owners of large estates, to attempt to re-establish the Roman creed on their territories. Some of these nobles committed great cruelties while attempting to obtain these forcible conversions.

Strife again broke out between Rudolph and his treacherous younger brother Matthias, who used the religious and political controversies of the time for the purpose of supplanting his brother. The formal cause of the rupture between the two princes was Rudolph's refusal to sanction a treaty of peace with Turkey, which Matthias had concluded as his brother's representative in Hungary. The Hungarians accepted Matthias as their ruler, and when his forces entered Moravia the estates of that country had, by Charles, lord of Zerotin, also renounced the allegiance of Rudolph. Matthias then invaded Bohemia, and invited the estates of the kingdom to meet him at Čáslav (Česlau). In consequence of a sudden revolution of feeling for which it is difficult to account, the Bohemians declined the overtures of Matthias. The estates met at Prague in March 1608, and, though again submitting their demands concerning ecclesiastical matters to Rudolph, authorized him to levy troops for the defence of Bohemia. The forces of Matthias had meanwhile entered Bohemia and had arrived at Libeň, a small town near Prague now incorporated with that city. Here Matthias, probably disappointed by the refusal of the Bohemians to join his standard, came to an understanding with his brother (June 25, 1608). Rudolph formally ceded to Matthias the government of Hungary, Moravia, and Upper and Lower Austria, but retained his rights as king of Bohemia.

Soon after the conclusion of this temporary settlement, the estates of Bohemia again brought their demands before their king. Rudolph had declined to discuss all religious

*Diet of 1609.
Demand for religious liberty.*

matters during the time that the troops of his brother occupied part of Bohemia. The diet that met on the 20th of January 1609 is one of the most important in the history of Bohemia. Here, as so frequently in the 17th century, the religious controversies were largely influenced by personal enmities. Rudolph never forgave the treachery of his brother, and was secretly negotiating (at the time when he again appeared as champion of Catholicism) with Christian of Anhalt, the leader of the German Protestants. This was known to the court of Spain, and the Bohemians also knew that the king could therefore rely on no aid from that quarter. They were therefore not intimidated when Rudolph, vacillating as ever, suddenly assumed a most truculent attitude. The estates had at their meeting in March of the previous year drawn up a document consisting of twenty-five so-called Articles, which formulated their demands with regard to matters of religion. The king now demanded that this document, which he considered illegal, should be delivered up to him for destruction. The "articles" expressed the wish that the *Confessio Bohemica* should be recognized as one of the fundamental laws of the kingdom, and that complete religious liberty should be granted to all classes. They further demanded that the Protestants—as it now became customary to call jointly the Utraquists, Lutherans and Bohemian Brethren—and the Roman Catholics should have an equal right to hold all the

offices of state, and that the power of the Jesuits to acquire land should be limited. They finally asked for redress of several grievances caused by the misuse of Rudolph. This document had remained in the hands of Budova, who refused to deliver it to the king. The estates then chose twelve of their number—among whom was Count Henry Matthias Thurn—who were to negotiate with the king and his councillors. Protracted discussions ensued, and the king finally stated, on the 31st of March, that he could grant no concessions in matters of religion. On the following day the estates met under the leadership of Budova. They decided to arm for the defence of their rights, and when the king immediately afterwards dissolved the diet, it was resolved to meet again after a month, even without a royal summons. When they returned to Prague, Adam of Sternberg, the burgrave, again informed Budova that the king would grant no concessions in ecclesiastical matters. Bohemia appeared to be on the verge of a revolution. It is unnecessary to record the frequent and contradictory resolutions of the king, influenced now by the extreme Romanists, now by those of his councillors who favoured a peaceful solution. Finally—on the 9th of July 1609—Rudolph signed the famed "Letter of Majesty" which gave satisfaction to all the legitimate demands of the Bohemian Protestants. In the "Letter of Majesty" Rudolph recognized the *Confessio Bohemica*. He further granted to the Protestant estates the control over the university of Prague, and authorized them to elect the members of the Utraquist consistory. They were further empowered to elect "defenders" chosen in equal number from the estates of the nobles, knights and citizens, who were to superintend the execution of the enactments of the Letter of Majesty and generally to uphold the rights of the Protestants. On the same day the Romanist and the Protestant members of the diet also signed an agreement by which they guaranteed to each other full liberty of religious worship and declared that this liberty should be extended to all classes of the population.

In 1611 the peace of Bohemia was again disturbed by the invasion of the archduke Leopold of Austria, bishop of Passau, who probably acted in conformance with his cousin Matthias. King Rudolph. Leopold succeeded in obtaining possession of part of the town of Prague, but his army was defeated by the troops which the Bohemian estates had hurriedly raised, and he was obliged to leave Bohemia. Matthias considered his hereditary rights menaced by the raid of Leopold and again occupied Bohemia. Mainly at his instigation the estates now formally deposed Rudolph, who survived his dethronement only a few months, and died on the 20th of January 1612. Though Matthias had allied himself with the Bohemian Protestants during his prolonged struggle against his brother, he now adopted that policy favourable to the Church of Rome which is traditional of the Habsburg dynasty. His relations with the Bohemian Protestants, therefore, soon became strained. In 1613 Matthias convoked a general diet, i.e. one that besides the Bohemian representatives included also the representatives of the "lands of the Bohemian crown." At the meeting of this diet the question of nationality, which through the constant religious controversies had receded to the background, again became predominant. Former enactments enforcing the use of the national language were reaffirmed, and it was decreed that Bohemian should be the "authorized" (i.e. official) language of the country.

As Matthias was childless, the question as to the succession to the Bohemian throne again arose. The king wished to secure the succession to his cousin Ferdinand, duke of Styria. Ferdinand was known as a fanatical adherent of the Church of Rome and as a cruel persecutor of the Protestants of Styria. None the less the state officials of Bohemia, by not very scrupulous means, succeeded in persuading the estates to accept Ferdinand as heir to the throne and to consent to his coronation, which took place at Prague on the 17th of June 1617. No doubt through the influence of Ferdinand, the policy of Matthias henceforth assumed a yet more pronouncedly ultramontane character. The king's councillors, all adherents of the Church of Rome,

openly expressed their hope that the Catholic Church would soon recover its ancient hold over Bohemia. On the other hand the Bohemian Protestants, led by Count Thurn, one of the few nobles who had refused to vote for the recognition of Ferdinand as heir to the throne, did not wish to defer what they considered an inevitable conflict. It appeared to them more advantageous to encounter the weak Matthias than his younger and more fanatical successor. A comparatively unimportant incident precipitated matters. In December 1617, the archbishop of Prague and the abbot of Břevnov (Braunau) ordered the suppression of the Protestant religious services in churches that had been built on their domains. This was a direct infringement of the agreement concluded by the Romanist and Utraquist estates on the day on which King Rudolph had signed the Letter of Majesty. The defenders took immediate action, by inviting all Protestant members of the diet to meet at Prague. They assembled there on 21st of May 1618, and decided to proceed in full armour to the Hradčany palace to bring their complaints to the knowledge of the councillors of Matthias. On the following day, Thurn, Wezclas of Ruppe, Ulrich of Kinsky, and other members of the more advanced party held a secret meeting, at which it was decided to put to death the most influential of Matthias's councillors. On the 23rd the representatives of the Protestants of Bohemia proceeded to the Hradčany. Violent accusations were brought forward, particularly against Martinic and Slavata, the king's most trusted councillors, who were accused of having advised him to oppose the wishes of the Bohemians. Finally these two councillors, together with Fabricius, secretary of the royal council, were thrown from the windows of the Hradčany into the moat below—an event known in history as the Defenestration of Prague. Both Martinic and Slavata were but little injured, and succeeded in escaping from Prague. The Bohemians immediately established a provisional government consisting of thirty "directors," ten of whom were chosen by each of the estates. They also proceeded to raise an armed force, the command of which was given to Count Thurn. Hostilities with Austria began in July, when an imperial force entered Bohemia. The troops of Matthias were, however, soon repulsed by the Bohemians, and in November Thurn's army entered Austria, but was soon obliged to retire to Bohemia because of the lateness of the season.

In the following March the Bohemian crown became vacant by the death of Matthias. On the 31st of July the Bohemian estates pronounced the formal deposition of Ferdinand, and on the 26th of August they elected as their king Frederick, elector palatine. The new king and his queen, Elizabeth of England, arrived in Bohemia in October, and were crowned somewhat later at St. Vitus's cathedral in Prague. Warfare with Austria continued during this year—1619. Thurn occupied Moravia, which now threw in its lot with Bohemia, and he even advanced on Vienna, but was soon obliged to retreat. In the following year events took a fatal turn for Bohemia. The powerful duke Maximilian of Bavaria joined his forces to those of Ferdinand, who had become Matthias's successor as emperor, and who was determined to reconquer Bohemia. Ferdinand also received aid from Spain, Poland and several Italian states. Even the Lutheran elector of Saxony espoused his cause. A large imperialist army, under the command of the duke of Bavaria, Tilly and Bouquoy, entered Bohemia in September 1620. After several skirmishes, in all of which the Bohemians were defeated, the imperial forces arrived at the outskirts of Prague on the evening of the 7th of November. On the following morning they attacked the Bohemian army, which occupied a slightly fortified position on the plateau known as the "Bila Hora" (White Hill). The Bohemians were defeated after a struggle of only a few hours, and on the evening of battle the imperialists already occupied the port of Prague, situated on the left bank of the Vitava (Moldau). King Frederick, who had lost all courage, hurriedly left Prague on the following morning.

Bohemia itself, as well as the lands of the Bohemian crown, now submitted to Ferdinand almost without resistance. The

battle of the White Hill marks an epoch in the history of Bohemia. The execution of the principal leaders of the national movement (June 21, 1621) was followed by a system of wholesale confiscation of the lands of all who had in any way participated in the national movement. Almost the entire ancient nobility of Bohemia was driven into exile, and adventurers from all countries, mostly men who had served in the imperial army, shared the spoils. Gradually all those who refused to recognize the creed of the Roman church were expelled from Bohemia, and by the use of terrible cruelty Catholicism was entirely re-established in the country. In 1627 Ferdinand published a decree, which formally suppressed the ancient free constitution of Bohemia, though a semblance of representative government was left to the country. The new constitution proclaimed the heredity of the Bohemian crown in the house of Habsburg. It added a new "estate," that of the clergy, to the three already existing. This estate, which was to take precedence of all the others, consisted of the Roman archbishop of Prague and of all the ecclesiastics who were endowed with landed estates. The diet was deprived of all legislative power, which was exclusively vested in the sovereign. At its meetings the diet was to discuss such matters only as were laid before it by the representatives of the king. The estates continued to have the right of voting taxes, but they were specially forbidden to attach any conditions to the grants of money which they made to their sovereign. It was finally decreed that the German language should have equal right with the Bohemian one in all the government offices and law-courts of the kingdom. This had indeed become a necessity, since, in consequence of the vast confiscations, the greatest part of the land was in the hands of foreigners to whom the national language was unknown. Though these enactments still left some autonomy to Bohemia, the country gradually lost all individuality. Its history from this moment to the beginning of the 19th century is but a part of the history of Austria (*q.v.*).

Bohemia was the theatre of hostilities during a large part of the Thirty Years' War, which had begun in its capital. In 1631 the Saxons for a time occupied a large part of Bohemia, and even attempted to re-establish Protestantism. During the later period of the Thirty Years' War Bohemia was frequently pillaged by Swedish troops, and the taking of part of Prague by the Swedish general Königsmark in 1648 was the last event of the great war. The attempts of the Swedish envoys to obtain a certain amount of toleration for the Bohemian Protestants proved fruitless, as the imperial representatives were inflexible on this point. At the beginning of the 18th century the possibility of the extinction of the male line of the house of Habsburg arose. The estates of Bohemia, at a meeting that took place at Prague on the 16th of October 1720, sanctioned the female succession to the Bohemian throne and recognized the so-called Pragmatic Sanction which proclaimed the indivisibility of the Habsburg realm. The archduchess Maria Theresa, in whose favour these enactments were made, none the less met with great opposition on the death of her father the emperor Charles VI. Charles, elector of Bavaria, raised claims to the Bohemian throne and invaded the country with a large army of Bavarian, French and Saxon troops. He occupied Prague, and a large part of the nobles and knights of Bohemia took the oath of allegiance to him (December 19, 1741). The fortune of war, however, changed shortly afterwards. Maria Theresa recovered Bohemia and the other lands that had been under the rule of the house of Habsburg. During the reign of Maria Theresa, and to a greater extent during that of her son Joseph II., many changes in the internal administration of the Habsburg realm took place which all tended to limit yet further the autonomy of Bohemia. A decree of 1749 abolished the separate law-courts that still existed in Bohemia, and a few years later an Austro-Bohemian chancellor was appointed who was to have the control of the administration of Bohemia, as well as of the German domains of the house of Habsburg. The power of the royal officials who constituted the executive government of

Bohemia under Austrian domination.

Bohemia was greatly curtailed, and though the chief representative of the sovereign in Prague continued to bear the ancient title of supreme burgrave, he was instructed to conform in all matters to the orders of the central government of Vienna. Yet more extreme measures tending to centralization were introduced by the emperor Joseph, who refused to be crowned at Prague as king of Bohemia. The powers of the Bohemian diet and of the royal officials at Prague were yet further limited, and the German language was introduced into all the upper schools of Bohemia. Some of the reforms introduced by Joseph were, incidentally and contrary to the wishes of their originator, favourable to the Bohemian nationality. Thus the greater liberty which he granted to the press enabled the Bohemians to publish a newspaper in the national language. After the death of Joseph in 1790 the Bohemian estates, whose meetings had been suspended during his reign, again assembled, but they at first made but scanty attempts to reassert their former rights. During the long Napoleonic wars, in which the house of Habsburg was almost continuously engaged, Bohemia continued in its previous lethargic state. In 1804 a merely formal change in the constitutional position of Bohemia took place when Francis I. assumed the hereditary title of emperor of Austria. It was stated in an imperial decree that the new title of the sovereign should in no way prejudice the ancient rights of Bohemia and that the sovereigns would continue to be crowned as kings of Bohemia.

After the re-establishment of European peace in 1815 the long-suppressed national aspirations of Bohemia began to revive. The national movement, however, at first only found expression in the revival of Bohemian literature.

The arbitrary and absolutist government of Prince Metternich rendered all political action impossible in the lands ruled by the house of Habsburg. In spite of this pressure the estates of Bohemia began in 1845 to assume an attitude of opposition to the government of Vienna. They affirmed their right of voting the taxes of the country—a right that was due to them according to the constitution of 1627. To obtain the support of the wider classes of the population, they determined in 1847 to propose at their session of the following year that the towns should have a more extensive representation at the diet, that the control of the estates over the finances of the country should be made more stringent, and that the Bohemian language should be introduced into all the higher schools of the country. The revolutionary outbreak of 1848 prevented this meeting of the estates. When the news of the February revolution in Paris reached Prague the excitement there was very great. On the 11th of March a vast public meeting voted a petition to the government of Vienna which demanded that the Bohemian language should enjoy equal rights with the German in all the government offices of the country, that a general diet comprising all the Bohemian lands, but elected on an extensive suffrage, should be convoked, and that numerous liberal reforms should be introduced. The deputation which presented these demands in Vienna received a somewhat equivocal answer. In reply, however, to a second deputation, the emperor Ferdinand declared on the 8th of April that equality of rights would be secured to both nationalities in Bohemia, that the question of the reunion of Moravia and Silesia to Bohemia should be left to a general meeting of representatives of all parts of Austria, and that a new meeting of the estates of Bohemia, which would include representatives of the principal towns, would shortly be convoked. This assembly, which was to have had full powers to create a new constitution, and which would have established complete autonomy, never met, though the election of its members took place on the 17th of May. In consequence of the general national movement which is so characteristic of the year 1848, it was decided to hold at Prague a "Slavic congress" to which Slavs of all parts of the Austrian empire, as well as those belonging to other countries, were invited. The deliberations were interrupted by the serious riots that broke out in the streets of Prague on the 12th of June. They were suppressed after prolonged fighting and considerable bloodshed. The Austrian commander, Prince Windischgrätz,

Revival of national aspirations.

Collapse in 1848.

bombarded the city, which finally capitulated unconditionally. The nationalist and liberal movement in Bohemia was thus suddenly checked, though the Bohemians took part in the Austrian constituent assembly that met at Vienna, and afterwards at Kroměříž (Kremsier).

By the end of the year 1849 all constitutional government had ceased in Bohemia, as in all parts of the Habsburg empire. The reaction that now ensued was felt more severely than in any other part of the monarchy; for not only were all attempts to obtain self-government and liberty ruthlessly suppressed, but a determined attempt was made to exterminate the national language. The German language was again exclusively used in all schools and government offices, all Bohemian newspapers were suppressed, and even the society of the Bohemian museum—a society composed of Bohemian noblemen and scholars—was for a time only allowed to hold its meetings under the supervision of the police.

The events of the Italian campaign of 1859 rendered the continuation of absolutism in the Austrian empire impossible. It was attempted to establish a constitutional system which, while maintaining to a certain extent the unity of the empire, should yet recognize the ancient constitutional rights of some of the countries united under the rule of the house of Habsburg. A decree published on the 20th of October 1860 established diets with limited powers. The composition of these parliamentary assemblies was to a certain extent modelled on that of the ancient diets of Bohemia and other parts of the empire. This decree was favourably received in Bohemia, but the hopes which it raised in the country fell when a new imperial decree appeared on the 26th of February 1861. This established a central parliament at Vienna with very extensive powers, and introduced an electoral system which was grossly partial to the Germans. The Bohemians indeed consented to send their representatives to Vienna, but they left the parliament in 1863, stating that the assembly had encroached on the power which constitutionally belonged to the diet of Prague. Two years later the central parliament of Vienna was suspended, and in the following year—1866—the Austro-Prussian war caused a complete change in the constitutional position of Bohemia. The congress of Vienna in 1815 had declared that that country should form part of the newly formed Germanic Confederation; this was done without consulting the estates of the country, as had been customary even after the battle of the White Hill on the occasion of serious constitutional changes. The treaty with Prussia, signed at Prague on the 23rd of August 1866, excluded from Germany all lands ruled by the house of Habsburg. As a natural consequence German influence declined in the Austrian empire, and in Bohemia in particular. While Hungary now obtained complete independence, the new constitution of 1867, which applied only to the German and Slavic parts of the Habsburg empire, maintained the system of centralization and attempted to maintain the waning German influence. The Bohemians energetically opposed this new constitution and refused to send representatives to Vienna.

In 1871 it appeared probable for a moment that the wishes of the Bohemians, who desired that their ancient constitution should be re-established in a modernized form, would be realized. The new Austrian prime minister, Count Karl Hohenwart, took office with the firm intention of accomplishing an agreement between Bohemia and the other parts of the Habsburg empire. Prolonged negotiations ensued, and an attempt was made to establish a constitutional system which, while satisfying the claims of the Bohemians, would yet have firmly connected them with the other lands ruled by the house of Habsburg. An imperial message addressed to the diet of Prague (September 14, 1871) stated that the sovereign "in consideration of the former constitutional position of Bohemia and remembering the power and glory which its crown had given to his ancestors, and the constant fidelity of its population, gladly recognized the rights of the kingdom of Bohemia, and was willing to confirm this assurance by taking the coronation oath." Various influences

Austrian constitutional changes.

Renewed struggles of Bohemian nationalism.

caused the failure of this attempt to reconcile Bohemia with Austria. In 1873 a government with a pronounced German tendency took office in Vienna, and the Bohemians for a time again refused to attend the parliamentary assemblies of Vienna and Prague. In 1879 Count Eduard Taaffe became Austrian prime minister, and he succeeded in persuading the representatives of Bohemia to take part in the deliberations of the parliament of Vienna. They did so, after stating that they took this step without prejudice to their view that Bohemia with Moravia and Silesia constituted a separate state under the rule of the same sovereign as Austria and Hungary. The government of Count Taaffe, in recognition of this concession by the Bohemians, consented to remove some of the grossest anomalies connected with the electoral system of Bohemia, which had hitherto been grossly partial to the German minority of the population. The government of Count Taaffe also consented to the foundation of a Bohemian university at Prague, which greatly contributed to the intellectual development of the country. On the fall of the government of Count Taaffe, Prince Alfred Windischgrätz became prime minister. The policy of his short-lived government was hostile to Bohemia and he was soon replaced by Count Badeni.

Badeni again attempted to conciliate Bohemia. He did not indeed consider it feasible to reopen the question of its autonomy, but he endeavoured to remedy some of the most serious grievances of the country. In the beginning of 1897 Count Badeni issued a decree which stated that after a certain date all government officials who wished to be employed in Bohemia would have to prove a certain knowledge of the Bohemian as well as of the German language. This decree met with violent opposition on the part of the German inhabitants of Austria, and caused the fall of Count Badeni's cabinet at the end of the year 1897. After a brief interval he was succeeded by Count Thun and then by Count Clary, whose government repealed the decrees that had to a certain extent granted equal rights to the Bohemian language. In consequence troubles broke out in Prague, and were severely repressed by the Austrian authorities. During the subsequent ministries of Körber and Gautsch the Bohemians continued to oppose the central government of Vienna, and to assert their national rights.

See generally Count Lützw. *Bohemia, a Historical Sketch* (London, 1896). The valuable collection of historical documents entitled *Facta Rerum Bohemicarum*, published at Prague in the latter part of the 19th century, has superseded earlier ones such as Freherus (*Marquard Freher*), *Rerum Bohemicarum Antiqui Scriptores*. Similarly, the earlier historical works of Pufendorf, Fels and De Florjy are superseded by František Palacký's *Geschichte von Böhmen* (Prague, 1845-1867), which, however, ends with the year 1526. Renck, Gaudely and others have dealt with the history of Bohemia posterior to the year 1526. Professor Adolf Bachmann published (vol. i. in 1899, vol. ii. 1905) a *Geschichte Böhmens* up to 1526, which has a strongly marked German tendency. Of French works Professor Ernest Denis's *Jean Hus, et la guerre des Hussites* (Paris, 1878), *Fin de l'indépendance bohème* (2 vols., 1890), and *La Bohème depuis la Montagne Blanche* (2 vols., 1903), give a continuous account of Bohemian history from the beginning of the 15th century. (L.)

LITERATURE

The earliest records of the Bohemian or Čech language are very ancient, though the so-called MSS. of *Zelena Hora* (Grüneberg) and *Kralodvur* (Königinhof) are almost certainly forgeries of the early part of the 19th century. The earliest genuine documents of the Bohemian language comprise several hymns and legends; of the latter the legend of St Catherine and that of St Dorothy have the greatest value. Several ancient epic fragments have also been preserved, such as the *Alexandreis* and *Tandarias a Floribella*. These and other early Bohemian writings have been printed since the revival of Bohemian literature in the 19th century. Of considerable historical value is the rhymed chronicle generally though wrongly known as the *chronicle of Dalimil*. The author, who probably lived during the reign of King John (1310-1346), records the events of Bohemian history from the earliest period to the reign of King Henry of Carinthia, the immediate predecessor of John. A

strong feeling of racial antipathy to the Germans pervades the chronicle.

It is undoubtedly to be attributed to the high intellectual level which Bohemia attained in the 14th century that at that period we already find writers on religious and philosophical subjects who used the national language. *Old Czech Literature*. Of the most important is Thomas of Štýtný (c. 1331-1401). Of his works, which contain many ideas similar to those of his contemporary Wycliffe, those entitled *O obecných věcech Křesťanských* (on general Christian matters) and *Besední rebí* (in a rough translation "learned entertainments") have most value. Štýtný and some of his contemporaries whose Bohemian writings have perished are known as the forerunners of Huss. Huss, like many of his contemporaries in Bohemia, wrote both in Bohemian and in Latin. Of the Bohemian writings of Huss, who contributed greatly to the development of his native language, the most important is his *Výklad víry, desatera Božského prikázání, a pater* (exposition of the creed, the ten commandments and the Lord's Prayer) written in 1412. Of his numerous other Bohemian works we may mention the *Postilla* (collection of sermons), the treatise *O páněm cestě pravé k spasení* (the true road to salvation) and *O svolokuspectvi* (on simony), and a large collection of letters; those written in prison are very touching.

The years that followed the death of Huss formed in Bohemia a period of incessant theological strife. The anti-Roman or Hussite movement was largely a democratic one, and it is therefore natural that the national language rather than Latin should have been used in the writings that belong to this period. Unfortunately in consequence of the systematic destruction of all Bohemian writings which took place through the agency of the Jesuits, after the battle of the White Hill (1620), a large part of this controversial literature has perished. Thus the writings of the members of the extreme Hussite party, the so-called Taborites, have been entirely destroyed. Of the writings of the more moderate Hussites, known as the Calixtines or Utraquists, some have been preserved. Such are the books entitled *Of the Great Torment of the Holy Church* and *Lives of the Priests of Tabor*, written in a sense violently hostile to that community. A Bohemian work by Archbishop John of Rokycan has also been preserved; it is entitled *Postilla* and is similar though inferior to the work of Huss that bears the same name.

A quite independent religious writer who belongs to the period of the Hussite wars is Peter Chelický (born in the last years of the 14th century, died 1460), who may be called the Tolstoy of the 15th. His dominant ideas were horror of bloodshed and the determination to accept unresistingly all, even unjust, decrees of the worldly authorities. Though a strenuous enemy of the Church of Rome, Chelický joined none of the Hussite parties. His masterpiece is the *Střeví* (the net of faith). Among his other works his *Postilla* and polemical writings in the form of letters to Archbishop John of Rokycan and Bishop Nicolas of Pelhřimov deserve mention.

▲ The Hussite period is rather poor in historical works written in the language of the country. We should, however, mention some chroniclers who were contemporaries and sometimes eye-witnesses of the events of the Hussite wars. Their writings have been collected and published by František Palacký under the title of *Staré české letopisy*.

In the 16th century when Bohemia was in a state of comparative tranquillity, the native literature was largely developed. Besides the writers of the community of the Bohemian Brethren, we meet at this period with three historians of merit. Of these far the best-known is Wencelas Hajek of Libočan. The year of his birth is uncertain, but we read of him as a priest in 1524; he died in 1553. His great work *Kronika česká* was dedicated to the emperor Ferdinand I., king of Bohemia, and appeared under the auspices of government officials. It has therefore a strong dynastic and Romanist tendency, and its circulation was permitted even at the time when most Bohemian books were prohibited and many totally destroyed. Hajek's book was translated into several languages and frequently quoted. We

find such second-hand quotations even in the works of many writers who had probably never heard of Hájek. His book is, however, inaccurate and grossly partial. Very little known on the other hand are the works of Bartoš, surnamed "pisák" (the writer), as he was for many years employed as secretary by the city of Prague, and those of Sixt of Ottersdorf. The work of Bartoš (or Bartholomew) entitled the *Chronicle of Prague* has great historical value. He describes the troubles that befell Prague and Bohemia generally during the reign of the weak and absentee sovereign King Louis. The year of the birth of Bartoš is uncertain, but it is known that he died in 1539. The somewhat later work of Sixt of Ottersdorf (1500-1583) deals with a short but very important episode in the history of Bohemia. It is entitled *Memorials of the Troubled Years 1546 and 1547*. The book describes the unsuccessful rising of the Bohemians against Ferdinand I. of Austria. Sixt took a considerable part in this movement, a fact that greatly enhances the value of his book.

Though the life of Chelčický, who has already been mentioned, was an isolated one, he is undoubtedly the indirect founder of the community of the "Bohemian Brethren," who greatly influenced Bohemian literature. Almost all their historical and theological works were written in the national language, which through their influence became far more refined and polished. Before referring to some of the writings of members of the community we should mention the famed translation of the Scriptures known as the *Bible of Kralice*. It was the joint work of several divines of the brotherhood, and was first printed at Kralice in Moravia in 1593. Brother Gregory, surnamed the patriarch of the brotherhood, has left a large number of writings dealing mainly with theological matters. Most important are the *Letters to Archbishop Rokycan* and the book *On good and evil priests*. After the death of Brother Gregory in 1480 discord broke out in the community, and it resulted in very great literary activity. Brothers Lucas, Blahoslav and Jaffet, as well as Augusta, a bishop of the community, have left us numerous controversial works. Very interesting is the account of the captivity of Bishop Augusta, written by his companion the young priest Jan Bilek. We have evidence that numerous historical works written by members of the brotherhood existed, but most of them perished in the 17th century when nearly all anti-Roman books written in Bohemia were destroyed. Thus only fragments of Blahoslav's *History of the Unity* (i.e. the brotherhood) have been preserved. One of the historians of the brotherhood, Wenceslas Brezan, wrote a *History of the House of Rosenberg*, of which only the biographies of William and Peter of Rosenberg have been preserved. The greatest writer of the brotherhood is John Amos Komenský or Comenius (1592-1670). Of his many works written in his native language the most important is his *Labyrinth of the World*, an allegorical tale which is perhaps the most famous work written in Bohemian.¹ Many of the numerous devotional and educational writings of Comenius,—his works number 142,—are also written in his native tongue.

The year 1620, which witnessed the downfall of Bohemian independence, also marks the beginning of a period of decline of the national tongue, which indeed later, in the 18th century, was almost extinct as a written language. Yet we must notice besides Comenius two other writers, both historians, whose works belong to a date later than 1620. Of these one was an adherent of the nationalist, the other of the imperialist party. Paul Skála ze Zhoře (1582-c. 1640) was an official in the service of the "winter king" Frederick of the Palatinate. He for a time followed his sovereign into exile, and spent the last years of his life at Freiberg in Saxony. It was at this period of his life, after his political activity had ceased, that he wrote his historical works. His first work was a short book which is a mere series of chronological tables. Somewhat later he undertook a vast work entitled *Histoire církevní* (history of the church). In spite of its title the book, which consists of ten enormous MS. volumes,

¹ This work has been translated into English by Count Litzow for the "Temple Classics."

deals as much with political as with ecclesiastical matters. The most valuable part, that dealing with events of 1602 to 1623, of which Skála writes as a contemporary and often as an eye-witness, has been edited and published by Prof. Tietztrunk. A contemporary and a political opponent of Skála was William Count Slavata (1572-1652). He was a faithful servant of the house of Habsburg, and one of the government officials who were thrown from the windows of the Hradčany palace in 1618, at the beginning of the Bohemian uprising. In 1637 Slavata published his *Paměti* (memoirs) which deal exclusively with the events of the years 1618 and 1619, in which he had played so great a part. During the leisure of the last years of his long life Slavata composed a vast work entitled *Historické Spisovani* (historical works). It consists of fourteen large MS. volumes, two of which contain the previously-written memoirs. These two volumes have recently been edited and published by Dr. Jos. Jirůček.

After the deaths of Skála, Slavata and Comenius, no works of any importance were written in the Bohemian language for a considerable period, and the new Austrian government endeavoured in every way to discourage the use of that language. A change took place when the romantic movement started at the beginning of the 19th century. The early revival of the Bohemian language was very modest, and at first almost exclusively translations from foreign languages were published. The first writer who again drew attention to the then almost forgotten Bohemian language was Joseph Dobrovský (1753-1829). His works, which include a grammar of the Bohemian language and a history of Bohemian literature, were mostly written in German or Latin, and his only Bohemian works are some essays which he contributed to the early numbers of the *Časopis Musea Království Českého* (Journal of the Bohemian Museum) and a collection of letters.

It is, however, to four men belonging to a time somewhat subsequent to that of Dobrovský that the revival of the language and literature of Bohemia is mainly due. They are Jungmann, Kolar, Šafařík and Palacký. Joseph Jungmann (1773-1847) published early in life numerous Bohemian translations of German and English writers. His most important works are his *Dejepis literatury české* (history of Bohemian literature), and his monumental German and Bohemian dictionary, which largely contributed to the development of the Bohemian language. John Kolar (1793-1852) was the greatest poet of the Bohemian revival, and it is only in quite recent days that Bohemian poetry has risen to a higher level. Kolar's principal poem is the *Slavj dcera* (daughter of Slavia), a personification of the Slavic race. Its principal importance at the present time consists rather in the part it played in the revival of Bohemian literature than in its artistic value. Kolar's other works are mostly philological studies. Paul Joseph Šafařík (1795-1861) was a very fruitful writer. His *Starožitnosti Slovanské* (Slavic antiquities), an attempt to record the then almost unknown history and literature of the early Slavs, has still considerable value. Francis Palacký (1798-1876) is undoubtedly the greatest of Bohemian historians. Among his many works his history of Bohemia from the earliest period to the year 1526 is the most important.

Other Bohemian writers whose work belongs mainly to the earlier part of the 19th century are the poets Francis Ladislav Čelakovský, author of the *Růže stolistá* (the hundred-leaved rose), Erben, Macha, Tyl, to mention but a few of the most famous writers. The talented writer Karel Havlíček, the founder of Bohemian journalism, deserves special notice.

During the latter part of the 19th century, and particularly after the foundation of the national university in 1882, Bohemian literature has developed to an extent that few perhaps foresaw. Of older writers Božena Němcová, whose *Babůlka* has been translated into many languages, and Benes Třebízský, author of many historical novels, should be named. John Neruda (1834-1897) was a very fruitful and talented writer both of poetry and of prose. Perhaps the most valuable of his many works is his philosophical epic entitled *Kosmické básně* (cosmic poems). Julius Zeyer (1841-1901), also wrote much both in prose and in verse. His epic poem entitled *Výhled*, which

19th-century revival

celebrates the ancient glory of the acropolis of Prague, has great value, and of his many novels *Jan Maria Plojhar* has had the greatest success. Of later Bohemian poets the best are Adolf Heyduk, Svatopluk Cech and Jaroslav Vrchlický (b. 1853). Of Svatopluk Cech's many poems, which are all inspired by national enthusiasm, *Václav s Michalovic*, *Lesetinsky Konar* (the smith of Lesetin) and *Basna otroka* (the songs of a slave) are the most notable. While Vrchlický (pseudonym of Emil Frida) has no less strong patriotic feelings, he has been more catholic in the choice of the subjects of his many works, both in poetry and in prose. Of his many collections of lyric poems *Rot na jih* (a year in the south), *Poutě k Eldoradu* (pilgrimages to Eldorado) and *Sonety Samotara* (sonnets of a recluse) have particular value. Vrchlický is also a very brilliant dramatist. Bohemian novelists have become very numerous. Mention should be made of Alois Jirásek, also a distinguished dramatic author; Jacob Arbes, whose *Romanella* have great merit; and Václav Hladík, whose Evzen Voldan is a very striking representation of the life of modern Prague. Like so many Bohemian authors, Hladík also is a copious dramatic author.

Bohemia has been very fruitful in historic writers. Wencelas Tomek (1818-1905) left many historical works, of which his *Dejepis města Prahy* (history of the town of Prague) is the most important. Jaroslav Goll (b. 1846) is the author of many historical works, especially on the community of the Bohemian Brethren. Professor Joseph Kalousek has written much on the early history of Bohemia, and is also the author of a very valuable study of the ancient constitution (*Státní právo*) of Bohemia. Dr Anton Rezek is the author of important historical studies, many of which appeared in the *Journal of the Bohemian Museum* and in the *Cesky Casopis Historický* (Bohemian Historical Review), which he founded in 1895 jointly with Professor Jaroslav Goll. More recently Dr Václav Flajšhans has published some excellent studies on the life and writings of John Huss, and Professors Fic and Niederle have published learned archaeological studies on the earliest period of Bohemian history.

See Count Litzow, *A History of Bohemian Literature* (London, 1899); W. R. Morfill, *Slavonic Literature* (1883); A. N. Pypin and V. D. Spasovitz, *History of Slavonic Literature* (written in Russian, translated into German by Tranquill Pech, *Gesch. der slav. Literaturen*, 2 vols., Leipzig, 1880-1884). There are modern histories of Bohemian literature written in the national language by Dr Karel Tieftrunk, Dr Václav Flajšhans and Mr Jaroslav Vlaek. (L.)

BOHEMUND, the name of a series of princes of Antioch, afterwards counts of Tripoli. Their connexion is shown in the following table:—

Robert Guiscard = (1) Alberida; (2) Sicelgaeta.

Bohemund I. = Constance, daughter of Philip I. of France.

Bohemund II. = Alice, daughter of Baldwin II. of Jerusalem.

(1) Raymund = Constance = (2) Raynald of Châtillon.

Bohemund III. = (2) Orgueilleuse.

Bohemund IV. = (1) Plaisance.

(2) Melisinda, daughter of Amalric II.

Bohemund V. = (1) Alice, widow of Hugh of Cyprus.

= (2) Luciana, daughter of count of Segni.

Henry I. = Plaisance

Bohemund VI. = Sibylla,

of Cyprus

sister of Leo III.

Hugh II.

of Armenia.

Bohemund VII. — o.s.p.

BOHEMUND I. (c. A.D. 1058-1111), prince of Otranto and afterwards of Antioch, whose first name was Marc, was the eldest son of Robert Guiscard, *dus Apuliae et Calabriae*, by an early marriage contracted before 1059. He served under his father in the great attack on the East Roman empire (1080-1085), and commanded the Normans during Guiscard's absence (1082-1084), penetrating into Thessaly as far as Larissa, but being repulsed by Alexius Comnenus. This early hostility to Alexius had a great influence in determining the course of his

future career, and thereby helped to determine the history of the First Crusade, of which Bohemund may be regarded as the leader. On the death of Guiscard in 1085, his younger son Roger, born "in the purple" of a Lombard princess Sicelgaeta, succeeded to the duchy of Apulia and Calabria, and a war arose between Bohemund (whom his father had destined for the throne of Constantinople) and Duke Roger. The war was finally composed by the mediation of Urban II. and the award of Otranto and other possessions to Bohemund. In 1096 Bohemund, along with his uncle the great count of Sicily, was attacking Amalfi, which had revolted against Duke Roger, when bands of crusaders began to pass, on their way through Italy to Constantinople. The zeal of the crusader came upon Bohemund: it is possible, too, that he saw in the First Crusade a chance of realizing his father's policy (which was also an old Norse instinct) of the *Drang nach Osten*, and hoped from the first to carve for himself an eastern principality. He gathered a fine Norman army (perhaps the finest division in the crusading host), at the head of which he crossed the Adriatic, and penetrated to Constantinople along the route he had tried to follow in 1082-1084. He was careful to observe a "correct" attitude towards Alexius, and when he arrived at Constantinople in April 1097 he did homage to the emperor. He may have negotiated with Alexius about a principality at Antioch; if he did so, he had little encouragement. From Constantinople to Antioch Bohemund was the real leader of the First Crusade; and it says much for his leading that the First Crusade succeeded in crossing Asia Minor, which the Crusades of 1101, 1147 and 1189 failed to accomplish. A *politique*, Bohemund was resolved to engineer the enthusiasm of the crusaders to his own ends; and when his nephew Tancred left the main army at Heraclea, and attempted to establish a footing in Cilicia, the movement may have been already intended as a preparation for Bohemund's eastern principality. Bohemund was the first to get into position before Antioch (October 1097), and he took a great part in the siege, beating off the Mahomedan attempts at relief from the east, and connecting the besiegers on the west with the port of St Simeon and the Italian ships which lay there. The capture of Antioch was due to his connexion with Firuz, one of the commanders in the city; but he would not bring matters to an issue until the possession of the city was assured him (May 1098), under the terror of the approach of Kerbogha with a great army of relief, and with a reservation in favour of Alexius, if Alexius should fulfil his promise to aid the crusaders. But Bohemund was not secure in the possession of Antioch, even after its surrender and the defeat of Kerbogha; he had to make good his claims against Raymund of Toulouse, who championed the rights of Alexius. He obtained full possession in January 1099, and stayed in the neighbourhood of Antioch to secure his position, while the other crusaders moved southward to the capture of Jerusalem. He came to Jerusalem at Christmas 1099, and had Dagobert of Pisa elected as patriarch, perhaps in order to check the growth of a strong Lotharingian power in the city. It might seem in 1100 that Bohemund was destined to found a great principality in Antioch, which would dwarf Jerusalem; he

had a fine territory, a good strategical position and a strong army. But he had to face two great forces—the East Roman empire, which claimed the whole of his territories and was supported in its claim by Raymund of Toulouse, and the strong Mahomedan principalities in the north-east of Syria. Against these two forces he failed. In 1100 he was captured by Danishmend of Sivas, and he languished in prison till 1103. Tancred took his place; but meanwhile Raymund established himself with the aid of Alexius in Tripoli, and was able to check the

expansion of Antioch to the south. Ransomed in 1103 by the generosity of an Armenian prince, Bohemund made it his first object to attack the neighbouring Mahomedan powers in order to gain supplies. But in heading an attack on Harran, in 1104, he was severely defeated at Balich, near Rakka on the Euphrates. The defeat was decisive; it made impossible the great eastern principality which Bohemund had contemplated. It was followed by a Greek attack on Cilicia; and despairing of his own resources, Bohemund returned to Europe for reinforcements in order to defend his position. His attractive personality won him the hand of Constance, the daughter of the French king, Philip I., and he collected a large army. Dazzled by his success, he resolved to use his army not to defend Antioch against the Greeks, but to attack Alexius. He did so; but Alexius, aided by the Venetians, proved too strong, and Bohemund had to submit to a humiliating peace (1108), by which he became the vassal of Alexius, consented to receive his pay, with the title of *Sebastos*, and promised to cede disputed territories and to admit a Greek patriarch into Antioch. Henceforth Bohemund was a broken man. He died without returning to the East, and was buried at Canossa in Apulia, in 1111.

LITERATURE.—The anonymous *Gesta Francorum* (edited by H. Hagenmeyer) is written by one of Bohemund's followers; and the *Alexiad* of Anna Comnena is a primary authority for the whole of his life. His career is discussed by B. von Köger, *Bohemund und Tancred* (Tübingen, 1862); while L. von Heinemann, *Geschichte der Normannen in Sicilien und Unteritalien* (Leipzig, 1894), and R. Röhrich, *Geschichte des ersten Kreuzzuges* (Innsbruck, 1901), and *Geschichte des Königreichs Jerusalem* (Innsbruck, 1898), may also be consulted for his history.

BOHEMUND II. (1108-1131), son of the great Bohemund by his marriage with Constance of France, was born in 1108, the year of his father's defeat at Durazzo. In 1126 he came from Apulia to Antioch (which, since the fall of Roger, the successor of Tancred, in 1119, had been under the regency of Baldwin II.); and in 1127 he married Alice, the younger daughter of Baldwin. After some trouble with Joscelin of Edessa, and after joining with Baldwin II. in an attack on Damascus (1127), he was defeated and slain on his northern frontier by a Mahomedan army from Aleppo (1131). He had shown that he had his father's courage: if time had sufficed, he might have shown that he had the other qualities of the first Bohemund.

BOHEMUND III. was the son of Constance, daughter of Bohemund II., by her first husband, Raymund of Antioch. He succeeded his mother in the principality of Antioch in 1163, and first appears prominently in 1164, as regent of the kingdom of Jerusalem during the expedition of Amalric I. to Egypt. During the absence of Amalric, he was defeated and captured by Nureddin (August 1164) at Harenc, to the east of Antioch. He was at once ransomed by his brother-in-law, the emperor Manuel, and went to Constantinople, whence he returned with a Greek patriarch. In 1180 he deserted his second wife, the princess Orgueilleuse, for a certain Sibylla, and he was in consequence excommunicated. By Orgueilleuse he had had two sons, Raymund and Bohemund (the future Bohemund IV.), whose relations and actions determined the rest of his life. Raymund married Alice, a daughter of the Armenian prince Rhupen (Rupin), brother of Leo of Armenia, and died in 1197, leaving behind him a son, Raymund Rhupen. Bohemund, the younger brother of Raymund, had succeeded the last count of Tripoli in the possession of that county, 1187; and the problem which occupied the last years of Bohemund III. was to determine whether his grandson, Raymund Rhupen, or his younger son, Bohemund, should succeed him in Antioch. Leo of Armenia was naturally the champion of his great-nephew, Raymund Rhupen; indeed he had already claimed Antioch in his own right, before the marriage of his niece to Raymund, in 1194, when he had captured Bohemund III. at Gastin, and attempted without success to force him to cede Antioch.¹ Bohemund the younger, however, prosecuted his claim with vigour, and even evicted his father from Antioch about 1199; but he was ousted by Leo (now king of Armenia by

¹ During the captivity of Bohemund III. the patriarch of Antioch helped to found a commune, which persisted, with its mayor and *jurats*, during the 13th century.

the grace of the emperor, Henry VI.), and Bohemund III. died in possession of his principality (1201).

BOHEMUND IV., younger son of Bohemund III. by his second wife Orgueilleuse, became count of Tripoli in 1187, and succeeded his father in the principality of Antioch, to the exclusion of Raymund Rhupen, in 1201. But the dispute lasted for many years (Leo of Armenia continuing to champion the cause of his great-nephew), and long occupied the attention of Innocent III. Bohemund IV. enjoyed the support of the Templars (who, like the Knights of St John, had estates in Tripoli) and of the Greek inhabitants of Antioch, to whom he granted their own patriarch in 1207, while Leo appealed (1210-1211) both to Innocent III. and the emperor Otto IV., and was supported by the Hospitallers. In 1216 Leo captured Antioch, and established Raymund Rhupen as its prince; but he lost it again in less than four years, and it was once more in the possession of Bohemund IV. when Leo died in 1220. Raymund Rhupen died in 1221; and after the event Bohemund reigned in Antioch and Tripoli till his death, proving himself a determined enemy of the Hospitallers, and thereby incurring excommunication in 1230. He first joined, and then deserted, the emperor Frederick II., during the crusade of 1228-29; and he was excluded from the operation of the treaty of 1229. When he died in 1233, he had just concluded peace with the Hospitallers, and Gregory IX. had released him from the excommunication of 1230.

BOHEMUND V., son of Bohemund IV. by his wife Plaisance (daughter of Hugh of Gibelet), succeeded his father in 1233. He was prince of Antioch and count of Tripoli, like his father; and like him he enjoyed the alliance of the Templars and experienced the hostility of Armenia, which was not appeased till 1251, when the mediation of St Louis, and the marriage of the future Bohemund VI. to the sister of the Armenian king, finally brought peace. By his first marriage in 1225 with Alice, the widow of Hugh I. of Cyprus, Bohemund V. connected the history of Antioch for a time with that of Cyprus. He died in 1251. He had resided chiefly at Tripoli, and under him Antioch was left to be governed by its baillif and commune.

BOHEMUND VI. was the son of Bohemund V. by Luciana, a daughter of the count of Segni, nephew of Innocent III. Born in 1237, Bohemund VI. succeeded his father in 1251, and was knighted by St Louis in 1252. His sister Plaisance had married in 1250 Henry I. of Cyprus, the son of Hugh I.; and the Cypriot connexion of Antioch, originally formed by the marriage of Bohemund V. and Alice, the widow of Hugh I., was thus maintained. In 1252 Bohemund VI. established himself in Antioch, leaving Tripoli to itself, and in 1257 he procured the recognition of his nephew, Hugh II., the son of Henry I. by Plaisance, as king of Jerusalem. He allied himself to the Mongols against the advance of the Egyptian sultan; but in 1268 he lost Antioch to Bibars, and when he died in 1275 he was only count of Tripoli.

BOHEMUND VII., son of Bohemund VI. by Sibylla, sister of Leo III. of Armenia, succeeded to the county of Tripoli in 1275, with his mother as regent. In his short and troubled reign he had trouble with the Templars who were established in Tripoli; and in the very year of his death (1287) he lost Laodicea to the sultan of Egypt. He died without issue; and as, within two years of his death, Tripoli was captured, the county of Tripoli may be said to have become extinct with him.

LITERATURE.—The history of the Bohemunds is the history of the principality of Antioch, and, after Bohemund IV., of the county of Tripoli also. For Antioch, we possess its *Assises* (Venice, 1876); and two articles on its history have appeared in the *Revue de l'Orient Latin* (Paris, 1893, fol.), both by E. Rey ("Resumé chronologique de l'histoire des princes d'Antioche," vol. iv., and "Les dignitaires de la principauté d'Antioche," vol. viii.). R. Röhrich, *Geschichte des Königreichs Jerusalem* (Innsbruck, 1898), gives practically all that is known about the history of Antioch and Tripoli. (E. B.L.)

BÖHMER, JOHANN FRIEDRICH (1795-1863), German historian, son of Karl Ludwig Böhmer (d. 1817), was born at Frankfort-on-Main on the 22nd of April 1795. Educated at the universities of Heidelberg and Göttingen, he showed an interest in art and visited Italy; but returning to Frankfort he turned his attention to the study of history, and became

secretary of the *Gesellschaft für ältere deutsche Geschichtskunde*. He was also archivist and then librarian of the city of Frankfurt. Böhmer had a great dislike of Prussia and the Protestant faith, and a corresponding affection for Austria and the Roman Catholic Church, to which, however, he did not belong. His critical sense was, perhaps, somewhat warped; but his researches are of great value to students. He died unmarried, at Frankfurt, on the 22nd of October 1863. Böhmer's historical work was chiefly concerned with collecting and tabulating charters and other imperial documents of the middle ages. First appeared an abstract, the *Regesta chronologico-diplomatica regum atque imperatorum Romanorum 911-1313* (Frankfort, 1831), which was followed by the *Regesta chronologico-diplomatica Karolorum. Die Urkunden sämtlicher Karolinger in kurzen Auszügen* (Frankfort, 1833), and a series of *Regesta imperii*. For the period 1314-1347 (Frankfort, 1839) the *Regesta* was followed by three, and for the period 1246-1313 (Frankfort, 1844) by two supplementary volumes. The remaining period of the *Regesta*, as edited by Böhmer, is 1198-1254 (Stuttgart, 1849). These collections contain introductions and explanatory passages by the author. Very valuable also is the *Fomes rerum Germanicarum* (Stuttgart, 1843-1868), a collection of original authorities for German history during the 13th and 14th centuries. The fourth and last volume of this work was edited by A. Huber after the author's death. Other collections edited by Böhmer are: *Die Reichsgesetze 900-1400* (Frankfort, 1832); *Wieltzbachische Regesten von der Erwerbung des Herzogtums Bayern bis zu 1340* (Stuttgart, 1854); and *Codez diplomatique Moeno-Francofurtanus. Urkundenbuch der Reichsstadt Frankfurt* (Frankfort, 1836; new edition by F. Law, 1901). Other volumes and editions of the *Regesta imperii*, edited by J. Ficker, E. Mühlbacher, E. Winkelmann and others, are largely based on Böhmer's work. Böhmer left a great amount of unpublished material, and after his death two other works were published from his papers: *Acta imperii selecta*, edited by J. Ficker (Innsbruck, 1870); and *Regesta archiepiscoporum Magnanimesium*, edited by C. Will (Innsbruck, 1877-1886).

See J. Janssen, *J. F. Böhmers Leben, Briefe und kleinere Schriften* (Freiburg, 1868).

BOHN, HENRY GEORGE (1796-1884), British publisher, son of a German bookbinder settled in England, was born in London on the 4th of January 1796. In 1831 he started as a dealer in rare books and "remainders." In 1841 he issued his "Guinea" Catalogue of books, a monumental work containing 23,208 items. Bohn was noted for his book auction sales: one held in 1848 lasted four days, the catalogue comprising twenty folio pages. Printed on this catalogue was the information: "Dinner at 2 o'clock, dessert at 4, tea at 5, and supper at 10." The name of Bohn is principally remembered by the important *Libraries* which he inaugurated: these were begun in 1846 and comprised editions of standard works and translations, dealing with history, science, classics, theology and archaeology, consisting in all of 766 volumes. One of Bohn's most useful and laborious undertakings was his revision (6 vols. 1864) of *The Bibliographer's Manual of English Literature* (1834) of W. T. Lowndes. The plan includes bibliographical and critical notices, particulars of prices, &c., and a considerable addition to the original work. It had been one of Bohn's ambitions to found a great publishing house, but, finding that his sons had no taste for the trade, he sold the *Libraries* in 1864 to Messrs. Bell and Daldy, afterwards G. Bell & Sons. Bohn was a man of wide culture and many interests. He himself made considerable contributions to his *Libraries*: he collected pictures, china and ivories, and was a famous rose-grower. He died at Twickenham on the 22nd of August 1884.

BÖHTLINGK, OTTO VON (1815-1904) German Sanskrit scholar, was born on the 30th of May (11th of June O.S.) 1815 at St Petersburg. Having studied (1833-1835) Oriental languages, particularly Arabic, Persian and Sanskrit, at the university of St Petersburg, he continued his studies in Germany, first in Berlin and then (1839-1842) in Bonn. Returning to St Petersburg in 1842, he was attached to the Royal Academy of Sciences, and was elected an ordinary member of that society in 1855.

In 1860 he was made "Russian state councillor," and later "privy councillor" with a title of nobility. In 1868 he settled at Jena, and in 1885 removed to Leipzig, where he resided until his death there on the 1st of April 1904. Böhlingk was one of the most distinguished scholars of the 19th century, and his works are of pre-eminent value in the field of Indian and comparative philology. His first great work was an edition of Panini's *Acht Bücher grammatischer Regeln* (Bonn, 1839-1840), which was in reality a criticism of Franz Bopp's philological methods. This book Böhlingk again took up forty-seven years later, when he republished it with a complete translation under the title *Paninis Grammatik mit Übersetzung* (Leipzig, 1887). The earlier edition was followed by *Vopadevas Grammatik* (St Petersburg, 1847); *Über die Sprache der Jakuten* (St Petersburg, 1851); *Indische Sprüche* (2nd ed. in 3 parts, St Petersburg, 1870-1873, to which an index was published by Blau, Leipzig, 1893); a critical examination and translation of *Chhandogya-upanishad* (St Petersburg, 1886) and a translation of *Brikadaronyako-upanishad* (St Petersburg, 1886). In addition to these he published several smaller treatises, notably one on the Sanskrit accents, *Über den Accent im Sanskrit* (1843). But his magnum opus is his great Sanskrit dictionary, *Sanskrit-Wörterbuch* (7 vols., St Petersburg, 1853-1875; new ed. 7 vols., St Petersburg, 1879-1886), which with the assistance of his two friends, Rudolf Roth (1821-1895) and Albrecht Weber (b. 1825), was completed in twenty-three years.

BOHUN, the name of a family which plays an important part in English history during the 13th and 14th centuries; it was taken from a village situated in the Cotentin between Coutances and the estuary of the Vire. The Bohuns came into England at, or shortly after, the Norman Conquest; but their early history there is obscure. The founder of their greatness was Humphrey III., who in the latter years of Henry I., makes his appearance as a *dapifer*, or steward, in the royal household. He married the daughter of Milo of Gloucester, and played an ambiguous part in Stephen's reign, siding at first with the king and afterwards with the empress. Humphrey III. lived until 1187, but his history is uneventful. He remained loyal to Henry II. through all changes, and fought in 1173 at Farnham against the rebels of East Anglia. Outliving his eldest son, Humphrey IV., he was succeeded in the family estates by his grandson Henry. Henry was connected with the royal house of Scotland through his mother Margaret, a sister of William the Lion; an alliance which no doubt assisted him to obtain the earldom of Hereford from John (1199). The lands of the family lay chiefly on the Welsh Marches, and from this date the Bohuns take a foremost place among the Marcher barons. Henry de Bohun figures with the earls of Clare and Gloucester among the twenty-five barons who were elected by their fellows to enforce the terms of the Great Charter. In the subsequent civil war he fought on the side of Louis, and was captured at the battle of Lincoln (1217). He took the cross in the same year and died on his pilgrimage (June 1, 1220). Humphrey V., his son and heir, returned to the path of loyalty, and was permitted, some time before 1239, to inherit the earldom of Essex from his maternal uncle, William de Mandeville. But in 1258 this Humphrey fell away, like his father, from the royal to the baronial cause. He served as a nominee of the opposition on the committee of twenty-four which was appointed, in the Oxford parliament of that year, to reform the administration. It was only the alliance of Montfort with Llewelyn of North Wales that brought the earl of Hereford back to his allegiance. Humphrey V. headed the first secession of the Welsh Marchers from the party of the opposition (1263), and was amongst the captives whom the Montfortians took at Lewes. The earl's son and namesake was on the victorious side, and shared in the defeat of Evesham, which he did not long survive. Humphrey V. was, therefore, naturally selected as one of the twelve arbitrators to draw up the ban of Kenilworth (1266), by which the disinherited rebels were allowed to make their peace. Dying in 1275, he was succeeded by his grandson Humphrey VII. This Bohun lives in history as one of the recalcitrant barons of the year 1297, who extorted from Edward I. the *Confirmatio Cartarum*.

The motives of the earl's defiance were not altogether disinterested. He had suffered twice from the chicanery of Edward's lawyers; in 1284 when a dispute between himself and the royal favourite, John Giffard, was decided in the latter's favour; and again in 1292 when he was punished with temporary imprisonment and sequestration for a technical, and apparently unwitting, contempt of the king's court. In company, therefore, with the earl of Norfolk he refused to render foreign service in Gascony, on the plea that they were only bound to serve with the king, who was himself bound for Flanders. Their attitude brought to a head the general discontent which Edward had excited by his arbitrary taxation; and Edward was obliged to make a surrender on all the subjects of complaint. At Falkirk (1298) Humphrey VII. redeemed his character for loyalty. His son, Humphrey VIII., who succeeded him in the same year, was allowed to marry one of the king's daughters, Eleanor, the widowed countess of Holland (1302). This close connexion with the royal house did not prevent him, as it did not prevent Earl Thomas of Lancaster, from joining the opposition to the feeble Edward II. In 1310 Humphrey VIII. figured among the Lords Ordainers; though, with more patriotism than some of his fellow-commissioners, he afterwards followed the king to Bannockburn. He was taken captive in the battle, but exchanged for the wife of Robert Bruce. Subsequently he returned to the cause of his order, and fell on the side of Earl Thomas at the field of Boroughbridge (1322). With him, as with his father, the politics of the Marches had been the main consideration; his final change of side was due to jealousy of the younger Despenser, whose lordship of Glamorgan was too great for the comfort of the Bohuns in Brecon. With the death of Humphrey VIII. the fortunes of the family enter on a more peaceful stage. Earl John (d. 1335) was inconspicuous; Humphrey IX. (d. 1361) merely distinguished himself as a captain in the Breton campaigns of the Hundred Years' War, winning the victories of Morlaix (1342) and La Roche Derrien (1347). His nephew and heir, Humphrey X., who inherited the earldom of Northampton from his father, was territorially the most important representative of the Bohuns. But the male line was extinguished by his death (1373). The three earldoms and the broad lands of the Bohuns were divided between two co-heiresses. Both married members of the royal house. The elder, Eleanor, was given in 1374 to Thomas of Woodstock, seventh son of Edward III.; the younger, Mary, to Henry, earl of Derby, son of John of Gaunt and afterwards Henry IV., in 1380 or 1381. From these two marriages sprang the houses of Lancaster and Stafford.

See J. E. Doyle's *Official Baronage of England* (1886), the *Complete Peerage* of G. E. C. (okayne), (1887-1898); T. F. Tout's "Wales and the March during the Barons' War," in *Owens College Historical Essays*, pp. 87-136 (1902); J. E. Morris' *Welsh Wars of King Edward I.*, ch. vi., viii. (1901). (H. W. C. D.)

BOIARDO, MATTEO MARIA, COUNT (1434-1494), Italian poet, who came of a noble and illustrious house established at Ferrara, but originally from Reggio, was born at Scandiano, one of the seigniorial estates of his family, near Reggio di Modena, about the year 1434, according to Tiraboschi, or 1420 according to Mazzuchelli. At an early age he entered the university of Ferrara, where he acquired a good knowledge of Greek and Latin, and even of the Oriental languages, and was in due time admitted doctor in philosophy and in law. At the court of Ferrara, where he enjoyed the favour of Duke Borso d'Este and his successor Hercules, he was entrusted with several honourable employments, and in particular was named governor of Reggio, an appointment which he held in the year 1478. Three years afterwards he was elected captain of Modena, and reappointed governor of the town and citadel of Reggio, where he died in the year 1494, though in what month is uncertain.

Almost all Boiardo's works, and especially his great poem of the *Orlando Innamorato*, were composed for the amusement of Duke Hercules and his court, though not written within its precincts. His practice, it is said, was to retire to Scandiano or some other of his estates, and there to devote himself to composition; and Castelvetro, Vallianieri, Mazzuchelli and Tira-

boschi all unite in stating that he took care to insert in the descriptions of his poem those of the agreeable environs of his chateau, and that the greater part of the names of his heroes, as Mandricardo, Gradasse, Scapitant, Agramant and others, were merely the names of some of his peasants, which, from their uncouthness, appeared to him proper to be given to Saracen warriors. Be this as it may, the *Orlando Innamorato* deserves to be considered as one of the most important poems in Italian literature, since it forms the first example of the romantic epic worthy to serve as a model, and, as such, undoubtedly produced Ariosto's *Orlando Furioso*. Gravina and Mazzuchelli have said, and succeeding writers have repeated on their authority, that Boiardo proposed to himself as his model the *Iliad* of Homer; that Paris is besieged like the city of Troy; that Angelica holds the place of Helen; and that, in short, the one poem is a sort of reflex image of the other. In point of fact, however, the subject-matter of the poem is derived from the *Fabulous Chronicle* of the pseudo-Turpin; though, with the exception of the names of Charlemagne, Roland, Oliver, and some other principal warriors, who necessarily figure as important characters in the various scenes, there is little resemblance between the detailed plot of the one and that of the other. The poem, which Boiardo did not live to finish, was printed at Scandiano the year after his death, under the superintendence of his son Count Camillo. The title of the book is without date; but a Latin letter from Antonia Caraffa di Reggio, prefixed to the poem, is dated the kalends of June 1495. A second edition, also without date, but which must have been printed before the year 1500, appeared at Venice; and the poem was twice reprinted there during the first twenty years of the 16th century. These editions are the more curious and valuable since they contain nothing but the text of the author, which is comprised in three books, divided into cantos, the third book being incomplete. But Niccolò degli Agostini, an indifferent poet, had the courage to continue the work commenced by Boiardo, adding to it three books, which were printed at Venice in 1526-1531, in 4to; and since that time no edition of the *Orlando* has been printed without the continuation of Agostini, wretched as it unquestionably is. Boiardo's poem suffers from the incurable defect of a laboured and heavy style. His story is skillfully constructed, the characters are well drawn and sustained throughout; many of the incidents show a power and fertility of imagination not inferior to that of Ariosto, but the perfect workmanship indispensable for a great work of art is wanting. The poem in its original shape was not popular, and has been completely superseded by the *Rifacimento* of Francesco Berni (q.v.).

The other works of Boiardo are—(1) *Il Timone*, a comedy, Scandiano, 1500, 4to; (2) *Sonnetti e Canzoni*, Reggio, 1499, 4to; (3) *Carmen Bucolicum*, Reggio, 1500, 4to; (4) *Cinque Capitoli in terza rima*, Venice, 1523 or 1533; (5) *Apulejo dell'Asino d'Oro*, Venice, 1516, 1518; (6) *Asino d'Oro de Luciano tradotto in volgare*, Venice, 1523, 8vo; (7) *Erodoto Alicarnasseo storico, tradotto di Greco in Lingua Italiana*, Venice, 1533 and 1538, 8vo; (8) *Rerum Italicarum Scriptores*.

See Panizzi's *Boiardo* (q.v.), 1830-1831.

BOIE, HEINRICH CHRISTIAN (1744-1806), German author, was born at Meldorf in the then Danish province of Schleswig-Holstein on the 19th of July 1744. After studying law at Jena, he went in 1769 to Göttingen, where he became one of the leading spirits in the Göttingen "Dichterbund" or "Hain." Boie's poetical talent was not great, but his thorough knowledge of literature, his excellent taste and sound judgment, made him an ideal person to awake the poetical genius of others. Together with F. W. Gotter (q.v.) he founded in 1770 the Göttingen *Musenalmannach*, which he directed and edited until 1775, when, in conjunction with C. W. von Dohm (1751-1820), he brought out *Das deutsche Museum*, which became one of the best literary periodicals of the day. In 1776 Boie became secretary to the commander-in-chief at Hanover, and in 1781 was appointed administrator of the province of Süderdithmarschen in Holstein. He died at Meldorf on the 3rd of March 1806.

See K. Weinhold, *Heinrich Christian Boie* (Halle, 1868).

BOIELDIEU, FRANÇOIS ADRIEN (1775-1834), French composer of comic opera, was born at Rouen on the 15th of December 1775. He received his first musical education from M. Broche, the cathedral organist, who appears to have treated him very harshly. He began composing songs and chamber music at a very early age—his first opera, *La Fille coupable* (the libretto by his father), and his second opera, *Rosalie et Myne*, being produced on the stage of Rouen in 1795. Not satisfied with his local success he went to Paris in 1795. His scores were submitted to Cherubini, Méhul and others, but with little approbation. Grand opera was the order of the day. Boieldieu had to fall back on his talent as a pianoforte-player for a livelihood. Success came at last from an unexpected source, P. J. Garat, a fashionable singer of the period, admired Boieldieu's touch on the piano, and made him his accompanist. In the drawing-rooms of the Directoire Garat sang the charming songs and ballads with which the young composer supplied him. Thus Boieldieu's reputation gradually extended to wider circles. In 1796 *Les Deux lettres* was produced, and in 1797 *La Pomme d'or* appeared for the first time on a Paris stage, and was well received. Several other operas followed in rapid succession, of which only *Le Calife de Bagdad* (1800) has escaped oblivion. After the enormous success of this work, Boieldieu felt the want of a thorough musical training and took lessons from Cherubini, the influence of that great master being clearly discernible in the higher artistic finish of his pupil's later compositions. In 1801 Boieldieu, to escape the domestic troubles caused by his marriage with Clotilde Aug. Mafeuroy, a celebrated ballet-dancer of the Paris opera, took flight and went to Russia, where he was received with open arms by the emperor Alexander. During his prolonged stay at St Petersburg he composed a number of operas. He also set to music the choruses of Racine's *Athalie*, one of his few attempts at the tragic style of dramatic writing. In 1811 he returned to his own country, where the following year witnessed the production of one of his finest works, *Jean de Paris*, in which he depicted with much felicity the charming coquetry of the queen of Navarre, the chivalrous *serve* of the king, the officious pedantry of the seneschal, and the amorous tenderness of the page. He succeeded Méhul as professor of composition at the Conservatoire in 1817. *Le Chapeau rouge* was produced with great success in 1818. Boieldieu's second and greatest masterpiece was his *Dame blanche* (1825). The libretto, written by Scribe, was partly suggested by Walter Scott's *Monastery*, and several original Scottish tunes cleverly introduced by the composer add to the melodious charm and local colour of the work. On the death of his wife in 1825, Boieldieu married a singer. His own death was due to a violent attack of pulmonary disease. He vainly tried to escape the rapid progress of the illness by travel in Italy and the south of France, but returned to Paris only to die on the 8th of October 1834.

Lives of Boieldieu have been written by Pougin (Paris, 1875); J. A. Refervaille (Rouen, 1896); Hequet (Paris, 1864); Emile Duval (Geneva, 1883). See also Adolphe Charles Adam, *Derniers souvenirs d'un musicien*.

BOIGNE, BENOÎT DE, COMTE (1751-1830), the first of the French military adventurers in India, was born at Chambéry in Savoy on the 8th of March 1751, being the son of a fur merchant. He joined the Irish Brigade in France in 1768, and subsequently he entered the Russian service and was captured by the Turks. Hearing of the wealth of India, he made his way to that country, and after serving for a short time in the East India Company, he resigned and joined Mahadji Sindhia in 1784 for the purpose of training his troops in the European methods of war. In the battles of Lalot and Chaksana Boigne and his two battalions proved their worth by holding the field when the rest of the Mahratta army was defeated by the Rajputs. In the battle of Agra (1788) he restored the Mahratta fortunes, and made Mahadji Sindhia undisputed master of Hindostan. This success led to his being given the command of a brigade of ten battalions of infantry, with which he won the victories of Patan and Merta in 1790. In consequence Boigne was allowed

to raise two further brigades of disciplined infantry, and made commander-in-chief of Sindhia's army. In the battle of Lakhairi (1793) he defeated Holkar's army. On the death of Mahadji Sindhia in 1794, Boigne could have made himself master of Hindostan had he wished it, but he remained loyal to Daulat Rao Sindhia. In 1795 his health began to fail, and he resigned his command, and in the following year returned to Europe with a fortune of £400,000. He lived in retirement during the lifetime of Napoleon, but was greatly honoured by Louis XVIII. He died on the 21st of June 1830.

See H. Compton, *European Military Adventurers of Hindustan* (1892).

BOII (perhaps = "the terrible"), a Celtic people, whose original home was Gallia Transalpina. They were known to the Romans, at least by name, in the time of Plautus, as is shown by the contemptuous reference in the *Capitoli* (888). At an early date they split up into two main groups, one of which made its way into Italy, the other into Germany. Some, however, appear to have stayed behind, since, during the Second Punic War, Magalus, a Boian prince, offered to show Hannibal the way into Italy after he had crossed the Pyrenees (Liv. xxi. 29). The first group of immigrants is said to have crossed the Pennine Alps (Great St Bernard) into the valley of the Po. Finding the district already occupied, they proceeded over the river, drove out the Etruscans and Umbrians, and established themselves as far as the Apennines in the modern Romagna. According to Cato (in Pliny, *Nat. Hist.* iii. 116) they comprised as many as 112 different tribes, and from the remains discovered in the tombs at Hallstatt, La Tène and other places, they appear to have been fairly civilized. Several wars took place between them and the Romans. In 283 they were defeated, together with the Etruscans, at the Vadimionian lake; in 224, after the battle of Telamon in Etruria, they were forced to submit. But they still cherished a hatred of the Romans, and during the Second Punic War (218), irritated by the foundation of the Roman colonies of Cremona and Placentia, they rendered valuable assistance to Hannibal. They continued the struggle against Rome from 201 to 191, when they were finally subdued by P. Cornelius Scipio Nasica, and deprived of nearly half their territory. According to Strabo (v. p. 213) the Boii were driven back across the Alps and settled on the land of their kinsmen, the Taurisci, on the Danube, adjoining Vindelicia and Raetia. Most authorities, however, assume that there had been a settlement of the Boii on the Danube from very early times, in part of the modern Bohemia (anc. *Boiohemum*, "land of the Boii"). About 60 B.C. some of the Boii migrated to Noricum and Pannonia, when 32,000 of them joined the expedition of the Helvetians into Gaul, and shared their defeat near Bibracte (58). They were subsequently allowed by Caesar to settle in the territory of the Aedui between the Loire and the Allier. Their chief town was Gorgobina (site uncertain). Those who remained on the Danube were exterminated by the Dacian king, Boerebista, and the district they had occupied was afterwards called the "desert of the Boii" (Strabo vii. p. 292). In A.D. 69 a Boian named Mariccus stirred up a fanatical revolt, but was soon defeated and put to death. Some remnants of the Boii are mentioned as dwelling near Bordeaux; but Mommsen inclines to the opinion that the three groups (in Bordeaux, Bohemia and the Po districts) were not really scattered branches of one and the same stock, but that they are instances of a mere similarity of name.

The Boii, as we know them, belonged almost certainly to the Early Iron age. They probably used long iron swords for dealing cutting blows, and from the size of the handles they must have been a race of large men (cf. Polybius ii. 30). For their ethnological affinities and especially their possible connexion with the Homeric Achaeans see W. Ridgeway's *Early Age of Greece* (vol. i., 1901).

See L. Contzen, *Die Wanderungen der Kellen* (Leipzig, 1861); A. Desjardins, *Géographie historique de la Gaule romaine*, ii. (1876-1893); T. R. Holmes, *Caesar's Conquest of Gaul* (1899), pp. 426-428; T. Mommsen, *Hist. of Rome*, ii. (Eng. trans. 5 vols., 1894), p. 373 note; M. Ihm in Pauly-Wissowa's *Realencyclopädie*, iii. pt. 1 (1897); A. Holder, *Alt-celtischer Sprachschatz*.

BOIL, in medicine, a progressive local inflammation of the skin, taking the form of a hard suppurating tumour, with a core of dead tissue, resulting from infection by a microbe, *Staphylococcus pyogenes*, and commonly occurring in young persons whose blood is disordered, or as a complication in certain diseases. Treatment proceeds on the lines of bringing the mischief out, assisting the evacuation of the boil by the lancet, and clearing the system. In the English Bible, and also in popular medical terminology, "boil" is used of various forms of ulcerous affection. The boils which were one of the plagues in Egypt were apparently the bubonic plague. The terms Aleppo boil (or button), Delhi boil, Oriental boil, Biskra button; &c., have been given to a tropical epidemic, characterized by ulcers on the face, due to a diplococcus parasite.

BOILEAU-DESPRÉAUX, NICOLAS (1636-1711), French poet and critic, was born on the 1st of November 1636 in the rue de Jérusalem, Paris. The same Despréaux was derived from a small property at Crosne near Villeneuve Saint-Georges. He was the fifteenth child of Gilles Boileau, a clerk in the parlement. Two of his brothers attained some distinction: Gilles Boileau (1631-1669), the author of a translation of Epictetus; and Jacques Boileau, who became a canon of the Sainte-Chapelle, and made valuable contributions to church history. His mother died when he was two years old; and Nicolas Boileau, who had a delicate constitution, seems to have suffered something from want of care. Sainte-Beuve puts down his somewhat hard and unsympathetic outlook quite as much to the uninspiring circumstances of these days as to the general character of his time. He cannot be said to have been early disenchanted, for he never seems to have had any illusions; he grew up with a single passion, "the hatred of stupid books." He was educated at the Collège de Beauvais, and was then sent to study theology at the Sorbonne. He exchanged theology for law, however, and was called to the bar on the 4th of December 1656. From the profession of law, after a short trial, he recoiled in disgust, complaining bitterly of the amount of chicanery which passed under the name of law and justice. His father died in 1657, leaving him a small fortune, and thenceforward he devoted himself to letters.

Such of his early poems as have been preserved hardly contain the promise of what he ultimately became. The first piece in which his peculiar powers were displayed was the first satire (1660), in imitation of the third satire of Juvenal; it embodied the farewell of a poet to the city of Paris. This was quickly followed by eight others, and the number was at a later period increased to twelve. A twofold interest attaches to the satires. In the first place the author skillfully parodies and attacks writers who at the time were placed in the very first rank, such as Jean Chapelain, the abbé Charles Cotin, Philippe Quinault and Georges de Scudéry; he openly raised the standard of revolt against the older poets. But in the second place he showed both by precept and practice what were the poetical capabilities of the French language. Prose in the hands of such writers as Descartes and Pascal had proved itself a flexible and powerful instrument of expression, with a distinct mechanism and form. But except with Malherbe, there had been no attempt to fashion French versification according to rule or method. In Boileau for the first time appeared terseness and vigour of expression, with perfect regularity of verse structure. His admiration for Molière found expression in the stanzas addressed to him (1663), and in the second satire (1664). In 1664 he composed his prose *Dialogue des héros de roman*, a satire on the elaborate romances of the time, which may be said to have once for all abolished the lucubrations of La Calprenède, Mlle de Scudéry and their fellows. Though fairly widely read in manuscript, the book was not published till 1713, out of regard, it is said, for Mlle de Scudéry. To these early days belong the reunions at the *Mouton Blanc* and the *Pomme du Pin*, where Boileau, Molière, Racine, Chapelain and Antoine Furetière met to discuss literary questions. To Molière and Racine he proved a constant friend, and supported their interests on many occasions.

In 1666, prompted by the publication of two unauthorized editions, he published *Satires du Sieur D. . .*, containing

seven satires and the *Discours au roi*. From 1669 onwards appeared his epistles, graver in tone than the satires, maturer in thought, more exquisite and polished in style. The *Épîtres* gained for him the favour of Louis XIV., who desired his presence at court. The king asked him which he thought his best verses. Whereupon Boileau diplomatically selected as his "least bad" some still unprinted lines in honour of the grand monarch and proceeded to recite them. He received forthwith a pension of 2000 livres. In 1674 his two masterpieces, *L'Art poétique* and *Le Lutrin*, were published with some earlier works as the *Œuvres diverses du sieur D. . .* The first, in imitation of the *Ars Poetica* of Horace, lays down the code for all future French verse, and may be said to fill in French literature a parallel place to that held by its prototype in Latin. On English literature the maxims of Boileau, through the translation revised by Dryden, and through the magnificent imitation of them in Pope's *Essay on Criticism*, have exercised no slight influence. Boileau does not merely lay down rules for the language of poetry, but analyses carefully the various kinds of verse composition, and enunciates the principles peculiar to each. Of the four books of *L'Art poétique*, the first and last consist of general precepts, inculcating mainly the great rule of *bon sens*; the second treats of the pastoral, the elegy, the ode, the epigram and satire; and the third of tragic and epic poetry. Though the rules laid down are of value, their tendency is rather to hamper and render too mechanical the efforts of poetry. Boileau himself, a great, though by no means infallible critic in verse, cannot be considered a great poet. He rendered the utmost service in destroying the exaggerated reputations of the mediocrities of his time, but his judgment was sometimes at fault. The *Lutrin*, a mock heroic poem, of which four cantos appeared in 1674, furnished Alexander Pope with a model for the *Rape of the Lock*, but the English poem is superior in richness of imagination and subtlety of invention. The fifth and sixth cantos, afterwards added by Boileau, rather detract from the beauty of the poem; the last canto in particular is quite unworthy of his genius. In 1674 appeared also his translation of Longinus *On the Sublime*, to which were added in 1693 certain critical reflections, chiefly directed against the theory of the superiority of the moderns over the ancients as advanced by Charles Perrault.

Boileau was made historiographer to the king in 1677. From this time the amount of his production diminished. To this period of his life belong the satire, *Sur les femmes*, the ode, *Sur la prise de Namur*, the epistles, *A mes vers* and *Sur l'amour de Dieu*, and the satire *Sur l'honneur*. The satires had raised up a crowd of enemies against Boileau. The 10th satire, on women, provoked an *Apologie des femmes* from Charles Perrault. Antoine Arnauld in the year of his death wrote a letter in defence of Boileau, but when at the desire of his friends he submitted his reply to Bossuet, the bishop pronounced all satire to be incompatible with the spirit of Christianity, and the 10th satire to be subversive of morality. The friends of Arnauld had declared that it was inconsistent with the dignity of a churchman to write on any subject so trivial as poetry. The epistle, *Sur l'amour de Dieu*, was a triumphant vindication on the part of Boileau of the dignity of his art. It was not until the 15th of April 1684 that he was admitted to the Academy, and then only by the king's wish. In 1687 he retired to a country-house he had bought at Auteuil, which Racine, because of the numerous guests, calls his *hôtellerie d'Auteuil*. In 1705 he sold his house and returned to Paris, where he lived with his confessor in the cloisters of Notre Dame. In the 12th satire, *Sur l'équivoque*, he attacked the Jesuits in verses which Sainte-Beuve called a recapitulation of the *Lettres provinciales* of Pascal. This was written about 1705. He then gave his attention to the arrangement of a complete and definitive edition of his works. But the Jesuit fathers obtained from Louis XIV. the withdrawal of the privilege already granted for the publication, and demanded the suppression of the 12th satire. These annoyances are said to have hastened his death, which took place on the 13th of March 1711.

Boileau was a man of warm and kindly feelings, honest.

outspoken and benevolent. Many anecdotes are told of his frankness of speech at court, and of his generous actions. He holds a well-defined place in French literature, as the first who reduced its versification to rule, and taught the value of workmanship for its own sake. His influence on English literature, through Pope and his contemporaries, was not less strong, though less durable. After much undue depreciation Boileau's critical work has been rehabilitated by recent writers, perhaps to the extent of some exaggeration in the other direction. It has been shown that in spite of undue harshness in individual cases most of his criticisms have been substantially adopted by his successors.

Numerous editions of Boileau's works were published during his lifetime. The last of these, *Œuvres diverses* (1701), known as the "favourite" edition of the poet, was reprinted with variants and notes by Alphonse Pauly (2 vols., 1894). The critical text of his works was established by Berniat Saint-Prix, *Œuvres de Boileau* (4 vols., 1830-1837), who made use of some 350 editions. This text, edited with notes by Paul Chéron, with the *Boleana* of 1740, and an essay by Sainte-Beuve, was reprinted by Garnier frères (1860). See also Sainte-Beuve, *Causeries du samedi*, vol. vi.; F. Brunetière, "L'Esthétique de Boileau" (*Revue des Deux Mondes*, June 1889), and an exhaustive article by the same critic in *La Grande encyclopédie*; G. Lanson, *Boileau* (1892), in the series of *Grands écrivains français*.

BOILER, a vessel in which water or other liquid is heated to the boiling point; specifically, the apparatus by which steam is produced from water, as one step in the process whereby the potential energy of coal or other fuel is converted into mechanical work by means of the steam-engine. Boilers of the latter kind must all possess certain essential features, whilst of other qualities that are desirable some may not be altogether compatible with the special conditions under which the boilers are to be worked. Amongst the essentials are a receptacle capable of containing the water and the steam produced by its evaporation, and strong enough continuously to withstand with safety the highest pressure of steam for which the boiler is intended. Another essential is a furnace for burning the fuel, and a further one is the provision of a sufficiency of heating surface for the transmission of the heat produced by the combustion of the fuel to the water which is required to be evaporated. Desirable qualities are that the arrangements of the furnaces should be such that a reasonably perfect combustion of the fuel should be possible, and that the heating surfaces should be capable of transmitting a large proportion of the heat produced to the water so as to obtain a high evaporative efficiency. Further, the design generally should be compact, not too heavy or costly, and such that the cleaning necessary to maintain the evaporative efficiency can be easily effected. It should also be such that the cost of upkeep will be small, and that only an average amount of skill and attention will be required under working conditions. It is for providing these qualities in different degrees according to the special requirements of various circumstances that the very different designs of the various types of boilers have been evolved.

Classes of Boilers.—Boilers generally may be divided into two distinct classes, one comprising those which are generally called "tank" boilers, containing relatively large quantities of water, and the other those which are generally called "water-tube" boilers, in which the water is mainly contained in numerous comparatively small tubes. There are, however, some types of boiler which combine to some extent the properties of both these classes. Each class has its representatives amongst both land and marine boilers. In "tank" boilers the outer shell is wholly or partially cylindrical, this form being one in which the necessary strength can be obtained without the use of a large number of stays. The boilers are generally internally fired, the furnace plates being surrounded with water and forming the most efficient portion of the heating surfaces. On leaving the furnace the products of combustion are led into a chamber and thence through flues or through numerous small tubes which serve to transmit some of the heat of combustion to the water contained in the boiler. In "water-tube" boilers the fire is usually placed under a collection of tubes containing water and forming the major portion of the heating surface of the boiler. Both the fire and the tubes are enclosed in an outer casing of brickwork or other fire-resisting substance. In some forms of water-tube

boiler the fire is entirely surrounded by water-tubes and the casing is in no part exposed to the direct action of the fire. In "tank" boilers generally no difficulty is experienced in keeping all the heating surfaces in close contact with water, but in "water-tube" boilers special provision has to be made in the design for maintaining the circulation of water through the tubes. (For "flash" boilers see **MOTOR VEHICLES**, and for domestic hot-water boilers **HEATING**.)

Tank Boilers.—Of large stationary boilers the forms most commonly used are those known as the "Lancashire" boiler, and its modification the "Galloway" boiler. These boilers are made from 26 to 30 ft. long, with diameters from 6½ to 8 ft., and have two cylindrical furnace flues which in the "Lancashire" boiler extend for its whole length (see fig. 3). The working pressure is about 60 lb per sq. in. in the older boilers, from 100 lb to 120 lb per sq. in. in those supplying steam to compound engines, and from 150 to 170 lb where triple expansion engines are used. In some cases they have been constructed for a pressure of 200 lb per sq. in. The furnace flues are usually made in sections from 3 to 3½ ft. long. Each section consists of one plate bent into a cylindrical form, the longitudinal joint being welded, and is flanged at both ends, the various pieces being joined together by an "Adamson" joint (fig. 1). It will be seen that these joints do not expose either rivets or double thickness of plate to the action of the fire; they further serve as stiffening rings to prevent collapse of the flue. In most of these boilers the heating surface is increased by fitting in the furnace flues a number of "Galloway" tubes. These are conical tubes, made with a flange at each end, by means of which they are connected to the furnace plate. They are so proportioned that the diameter of the large end of the tube is slightly greater than that of the flange of the small end; this enables them to be readily removed and replaced if necessary. These tubes not only add to the heating surface, but they stiffen the flue, promote circulation of the water in the boiler, and by mixing up the flue gases improve the evaporative efficiency.



FIG. 1.—Adamson Joint.

In the "Galloway" boiler the two furnaces extend only for about 9 or 10 ft. into the boiler, and lead into a large chamber or flue in which a number of "Galloway" tubes are fitted, and which extends from the furnace end to the end of the boiler. A cross section of this flue showing the distribution of the Galloway tubes is shown in fig. 2. When boilers less than about 6½ ft. in diameter are needed, a somewhat similar type to the Lancashire boiler is used containing only one furnace. This is called a "Cornish" boiler.

In all three types of boiler the brickwork is constructed to form one central flue passing along the bottom of the boiler and two side flues extending up the side nearly to the water-level. A cross section of the brickwork is shown in fig. 2. The usual arrangement is for the flue gases to be divided as they leave the internal flue; one-half returns along each side flue to the front of the boiler, and the whole then passes downwards into the central flue, travelling under the bottom of the boiler until the gases again reach the back end, where they pass into the chimney. In a few cases the arrangement is reversed, the gases first passing along the bottom flue and returning along the side flues. This latter arrangement, whilst promoting a more rapid circulation of water, has the disadvantage of requiring two dampers, and it is not suitable for those cases in which heavy deposits form on the bottoms of the boilers.

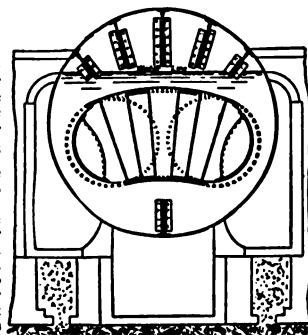

FIG. 2.—Galloway Boiler: Section beyond the Bridge.

Where floor space is limited and also for small installations, other forms of cylindrical boilers are used, most of them being of the vertical type. That most commonly used is the simple vertical boiler, with a plain vertical fire-box, and an internal smoke stack traversing the steam space. The fire-box is made slightly tapering in diameter, the space between it and the shell being filled with water. In all but the small sizes cross tubes are generally fitted. These are made about 9 in. in diameter of ½-in. plate flanged at each end to enable them to be riveted to the fire-box plates. They are usually fitted with a slight inclination to facilitate water circulation.

and a hand-hole closed by a suitable door is provided in the outer shell opposite to each tube for cleaning purposes. A boiler of this kind is illustrated in fig. 4. This form is often used on board ship for auxiliary purposes. Where more heating surface is required than can be obtained in the cross-tube boiler other types of vertical

made from plates originally rolled of a uniform thickness, made into a cylindrical form with a welded longitudinal joint and then corrugated, the only difference between them being in the shapes of the corrugations. In the other three types the plates from which the furnaces are made are rolled with ribs or thickened portions at

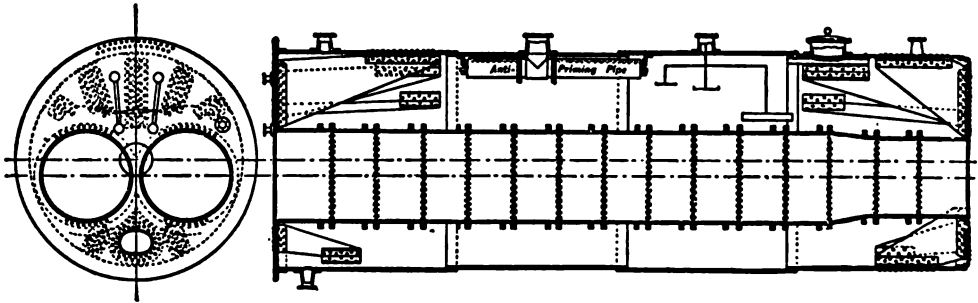

FIG. 3.—Lancashire Boiler (Messrs Tinker, Ltd.).

boiler are employed. For instance, in the "Tyne" boiler (fig. 5) the furnace is hemispherical, and the products of combustion are led into an upper combustion chamber traversed by four or more inclined water-tubes of about 9 in. diameter and by several vertical water-tubes of less diameter. In the "Victoria" boiler made by Messrs Clarke, Chapman & Co., and illustrated in fig. 6, the furnace is hemispherical; the furnace gases are led to an internal combustion chamber, and thence through numerous horizontal smoke-tubes to a smoke-box placed on the side of the boiler. In the somewhat similar boiler known as the "Cochran," the combustion chamber is made with a "dry" back. Instead of a water space at the back of the chamber, doors lined with firebrick are fitted. These give easy access to the tube ends.

distances of 9 in. These furnaces are stronger to resist collapse than plain furnaces of the same thickness, and accommodate themselves more readily to changes of temperature.

There are two distinct types of connexion between the furnaces and the combustion chambers. In one, shown in fig. 8, the furnace is flanged at the crown portion for riveting to the tube plate, and the lower part of the furnace is riveted to the "wrapper" or side plate of the combustion chamber. In the other type, shown in fig. 7, and known generally as the "Gourlay back end," the end of the furnace is contracted into an oval conical form, and is then flanged outwards round the whole of its circumference. The tube plate is made to extend to the bottom of the combustion chamber, and the

access to the tube ends.

The cylindrical multitubular re-

turn tube boiler is in

almost universal use in

merchant steamers. It is made in

various sizes ranging up to 17 ft.

in diameter, the usual working

pressure being from 160 to 200 lb

per sq. in., although in some

few cases pressures of 265 lb per

sq. in. are in use. These boilers

are of two types, double- and

single-ended. In single-ended

boilers, which are those most generally

used, the furnaces are fitted at

one end only and vary in number

from one in the smallest boiler

to four in the largest. Three furnaces

are the most usual practice. Each furnace

generally has its own separate combustion

chamber. In four furnace boilers, however,

one chamber is sometimes made com-

mon to the two middle furnaces, and

sometimes one chamber is fitted to

each pair of side furnaces. In double-ended

boilers furnaces are fitted at each end.

In some cases each furnace has a separate

combustion chamber, but more usually

one chamber is made to serve for

two furnaces, one at each end of

the boiler. The two types of boilers

are shown in figs. 7 and 8, which

illustrate boilers made by Messrs

D. Rowan & Co. of Glasgow, and

which may be taken as representing

good modern practice. The furnaces

used in the smaller sizes are

often of the plain cylindrical type,

the thickness of plate varying from

$\frac{1}{4}$ in. up to $\frac{1}{2}$ in. according to the

diameter of the furnace and the

working pressure. Occasionally

furnaces with "Adamson" joints

similar to those used in Lancashire

boilers are employed, but for large

furnaces corrugated or ribbed furnaces

are usually adopted. Sketches of the sections of these are shown

in fig. 9. The sections of the Morrison, Fox and Deighton types are

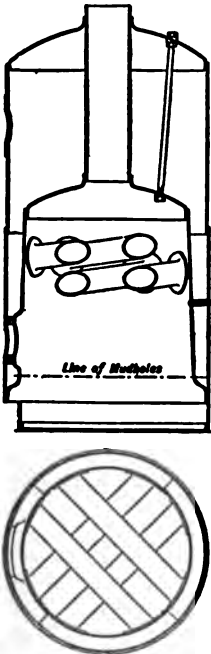

FIG. 4.—Simple Vertical Boiler.

furnaces and for high pressures corrugated or ribbed furnaces are usually adopted. Sketches of the sections of these are shown in fig. 9. The sections of the Morrison, Fox and Deighton types are

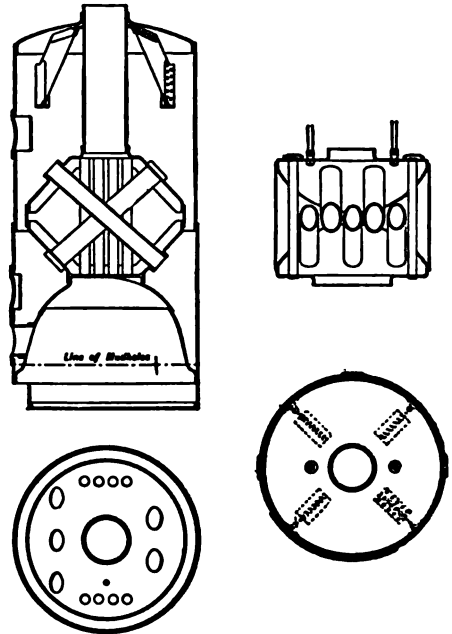

FIG. 5.—Vertical Boiler with Water-tubes (the "Tyne," by Messrs Clarke, Chapman & Co.).

furnace is riveted to the tube plate. The advantage of the Gourlay back end is that in case of accident to the furnace it can be removed from the boiler and be replaced by one of the same design without disturbing the end plates, which is not possible with the other design.

The Gourlay back end, however, is not so stiff as the other, and more longitudinal stays are required in the boiler.

The flat sides and backs of the combustion chambers are stayed either to one another or to the shell of the boiler by numerous screw

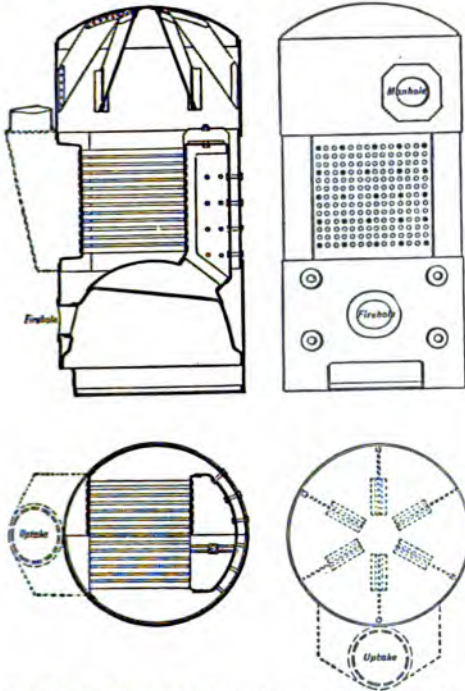

FIG. 6.—Vertical Boiler with internal combustion chamber (the "Victoria," by Messrs Clarke, Chapman & Co.).

stays which are screwed through the two plates they connect, and which are nearly always fitted with nuts inside the combustion chambers. The tops of the chambers are usually stayed by strong girders resting upon the tube plates and chamber back plates. In

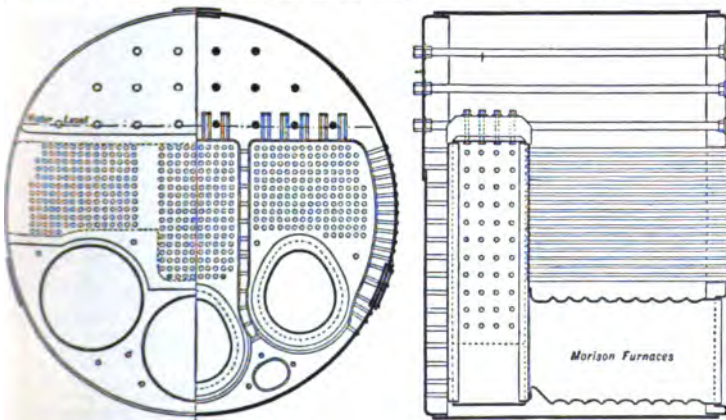

FIG. 7.—Single-ended Marine Boiler.

In a few cases, however, they are stayed by vertical stays attached to T bars riveted to the boiler shell. A few boilers are made in which the chamber tops are strengthened by heavy transverse girder

plates. The end plates of the boiler in the steam space and below the combustion chambers are stayed by longitudinal stays passing through the whole length of the boiler and secured by double nuts at each end. The tube plates are strengthened by stay tubes screwed into them.

Where natural or chimney draught is used the tubes are generally made 3 or 3½ in. outside diameter and are rarely more than 7 ft. long, but where "forced" draught is employed they are usually made 2½ in. diameter and 8 to 8½ ft. long. A clear space of 1½ in. between the tubes is almost always arranged for, irrespective of size of tubes.

Stay tubes are screwed at both ends, the threads of the two ends being continuous so that they can be screwed into both tube plates;

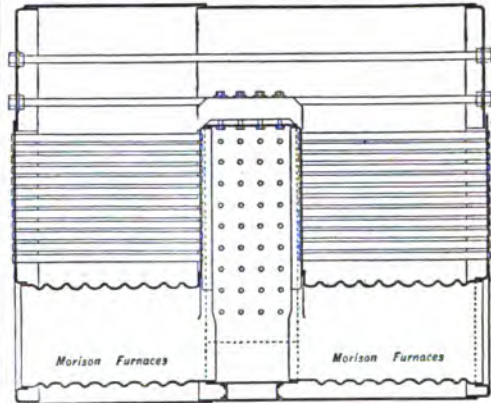

FIG. 8.—Double-ended Marine Boiler.

occasionally nuts are fitted to the front ends. The stay tubes are expanded into the plates and then beaded over.

The locomotive boiler consists of a cylindrical barrel attached to a portion containing the fire-box, which is nearly rectangular both in horizontal and vertical section. The fire-box sides are stayed to the fire-box shell by numerous stays about 1 in. in diameter, usually pitched 4 in. apart both vertically and horizontally. The top of the fire-box in small boilers is stayed by means of girder stays running longitudinally and supported at the ends upon the tube plate and the opposite fire-box plate. In some boilers the girders are partly supported by slings from the crown of the boiler. In larger boilers the crown of the boiler above the fire-box is made flat and the fire-box crown is supported by vertical stays connecting it with the shell crown. Provision is

generally made for the expansion of the tube plate, which is of copper, by allowing the two or three cross rows of stays nearest the tube plate to have freedom of motion upwards but not downwards. The ordinary tubes are usually 1½ in. diameter. The fire-bars are generally, though not always, made to slope downwards away from the fire door, and just below the lowest tubes a fire-bridge or baffle is fitted, extending about half-way from the tube plate to the fire-door side of the fire-box. In some cases water-tubes are fitted, extending right across the fire-box. In a boiler for the London & South-Western Railway Co., having a grate area of 31.5 sq. ft. and a total heating surface of 2727 sq. ft., there are 112 water-tubes each 2½ in. diameter. These are arranged in two clusters, each containing 56, one set being placed above the fire-bridge, and the other set nearer the fire-door end of the boiler. The water-tubes are of seamless steel fire-box side plates. In way

of these tubes the outer shell side plates are supported by stay bars passing right through the water-tubes. The usual

pressure of locomotive boilers is about 175 lb to 200 lb per sq. in.

A good example of an express locomotive boiler is shown in fig. 10. In this case the grate area is 30.9 sq. ft. and the heating surface

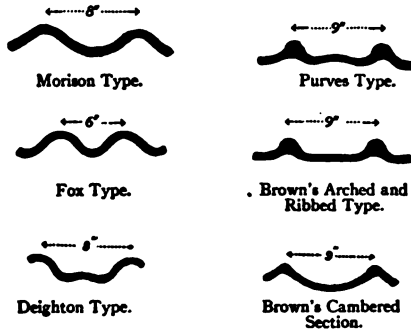

Fig. 9.

2500 sq. ft. The barrel is 5 ft. 6 in. diameter, 16 ft. long between tube plates. The fire-box crown is stayed by vertical stays extending to the shell crown, except for the three rows of stays nearest the tube plates. These are supported by cross girders resting upon brackets secured to the outer shell.

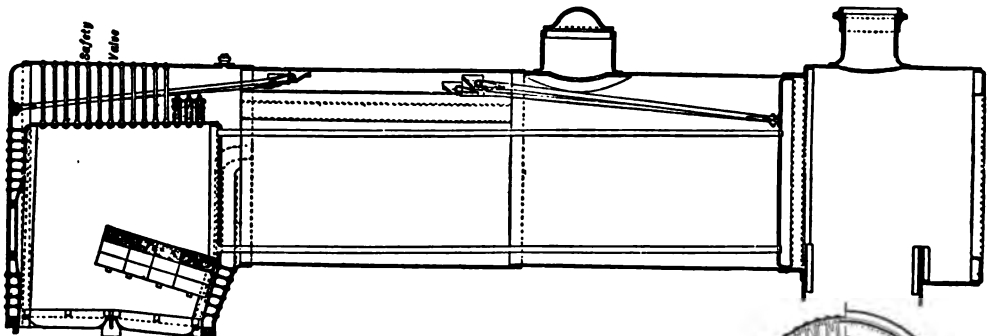

Fig. 10.—Express Locomotive Boiler, with widened fire-box (Great Northern Railway, England).

Water-Tube Boilers.—The "Babcock & Wilcox" boiler, as fitted for land purposes, and illustrated in fig. 11, consists of a horizontal cylinder forming a steam chest, having dished ends and two specially constructed cross-boxes riveted to the bottom. Under the cylinder is placed a sloping nest of tubes, under the upper end of which is the fire. The sides and back of the boiler are enclosed in brickwork up to the height of the centre of the horizontal cylinder and the front is fitted with an iron casing lined with brick at the lower part. Suitable brickwork baffles are arranged between the tubes themselves, and between the nests of tubes and the cylinder, to ensure a proper circulation of the products of combustion, which are made to pass between the tubes three times. The nest of tubes consists of several separate elements, each formed by a front and back header made of wrought steel of sinuous form connected by a number of tubes. The upper ends of the front headers are connected by short tubes to the front cross-box of the horizontal cylinder, the lower ends being closed. The upper ends of the back headers are connected by longer pipes to the back cross-box, and their lower ends by short pipes to a horizontal mud drum to which a blow-off cock and pipe are attached. The headers are furnished with holes on two opposite sides; those on one side form the means of connexion between the headers and tubes, and the others allow access for fixing the tubes in position and cleaning. The outer holes are oval, and closed by special fittings shown in fig. 18, the watertightness of the joints being secured by the outer cover plates. The holes being oval, the inside fitting can be placed in position from outside, and it is so made as to cover the opening and prevent any great outrush of steam or water should the bolt break. Any desired working pressure can be provided for in these boilers; in some special cases it rises as high as 500 lb per sq. in., but a more

usual pressure is 180 lb. Like all water-tube boilers, they require to be frequently cleaned if impure feed-water is used, but the straightness of their tubes enables their condition to be ascertained at any time when the boiler is out of use, and any accumulation of scale to be removed. The superheaters, which are frequently fitted, consist of two cross-boxes or headers placed transversely under the cylindrical drum and connected by numerous C shaped tubes. They are situated between the tubes and the steam-chest, and are exposed to the heat of the furnace gases after their first passage across the tubes. The steam is taken by an internal pipe passing through the bottom of the drum into the upper cross-box, then through the C tubes into the lower box, and thence to the steam pipe. When steam is being raised, the superheater is flooded with water, which is drained out through a blow-off pipe before communication is opened with the steam-pipe. In large boilers of this type, two steam-chests are placed side by side connected together by two cross steam pipes and by the mud drum. Each, however, has its own separate feed supply. The largest boiler made has two steam chests 4½ ft. diameter by 25½ ft. long a grate surface of 85 sq. ft., and a total heating surface of 6182 sq. ft.

Another type of water-tube boiler in use for stationary purposes is the "Stirling" (fig. 12). This boiler consists of four or five horizontal drums, of which the three upper form the steam-space, and the one or two lower contain water. The lower drums, where two are fitted, are connected to each other at about the middle of their height by horizontal tubes, and to the upper drums by numerous nearly vertical tubes which form the major portion of the heating surfaces. The central upper drum is at a slightly higher level than the others, and communicates with that nearest the back of the boiler by a set of curved tubes entirely above the water-level, and with the front drum by two sets—the upper one being above and the lower below the water-level. The whole boiler is enclosed in brickwork, into which the supporting

columns and girders are built. Brickwork baffles compel the furnace gases to take specified courses among the tubes. It will be seen that the space between the boiler front and the tubes form a large combustion chamber into which all the furnace gases must pass before they enter the spaces between the tubes; in this chamber a baffle-bridge is sometimes built. Another chamber is formed between the first and second sets of tubes. The feed-water enters the back upper drum, and must pass down the third set of tubes into the lower drum before it reaches the other parts of the boiler. Thus the coldest water is always where the temperature of the furnace gases is lowest; and as the current through the lower drum is slight, the solid matters separated from the feed-water while its temperature is being raised have an opportunity of settling to the bottom of this drum, where the heating is not great and where therefore their presence will not be injurious. When superheaters are required, they are made of two drums connected by numerous small tubes, and are somewhat similar in construction to the boiler proper. The superheater is placed between the first and second sets of tubes, where it is exposed to the furnace gases before too much heat has been taken from them. Arrangements are provided for flooding the superheater while steam is being raised, and for draining it before the steam is passed through it.

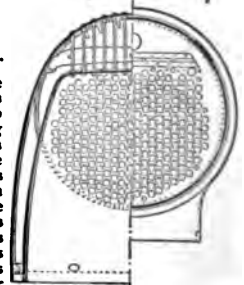

A somewhat similar boiler is made by Messrs. Clarke, Chapman & Co., and is known as the "Woodson" boiler (fig. 13). It consists of three upper drums placed side by side connected together by numerous short tubes, some above and some below the water-level, and of three smaller lower drums also connected by short cross tubes. The upper and lower drums are

and except in the case of the upper and lower ones at the front of the boiler, each connects the upper end of one tube with the lower end of the next tube of the element. The boxes at the back of the boiler are all close-ended, but those at the front are provided with a small oval hole, opposite to each tube end, closed by an internal door with bolt and cross-bar; the purpose of these openings is to permit the inside of the tubes to be examined and cleaned. The lower front box of each element of the boiler proper is connected to a horizontal cross-tube of square section, called a "feed-collector," which extends the whole width of the boiler. When the boiler is not in use, any element can be readily disconnected and a spare one inserted. The lower part of the steam-chest is connected to the feed-collector by vertical pipes at each end of the boiler, and prolongations of these pipes below the level of the feed-collector form closed pockets for the collection of sediment. The tubes are made of seamless steel. They are generally about $\frac{4}{8}$ in. in external diameter; the two lower rows are $\frac{1}{4}$ in. thick, the next two rows $\frac{1}{8}$ in., and the remainder about $\frac{1}{8}$ in. The construction of the economizer is similar to that of the boiler proper, but the tubes are shorter and smaller, being generally about $2\frac{1}{2}$ in. in diameter. The lower boxes of the economizer elements are connected to a horizontal feed pipe which is kept supplied with water by a feed-pumping engine, and the upper boxes are connected to another horizontal pipe from which the heated feed-water is taken into the steam-chest. Both the boiler proper and the economizer are enclosed in a casing which is formed of two thicknesses of thin iron separated by non-conducting material and lined with firebrick at the part between the fire-bar level and the lower rows of tubes. Along the front of the boiler, above the level of the firing-doors, there is a small tube having several nozzles directed across the fire-grate, and supplied with compressed air at a pressure of about 10 lb per sq. in. In this way not only is additional air supplied, but the gases issuing from

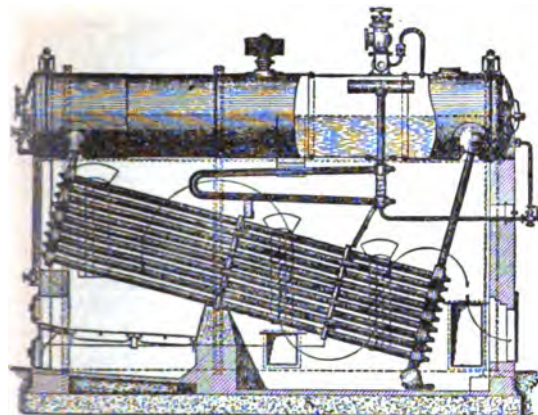

FIG. 11.—Babcock & Wilcox Water-tube Boiler fitted with Superheaters.

connected by numerous nearly vertical straight tubes. The whole is enclosed in firebrick casing. The design permits of the insides of all the tubes being readily inspected, and also of any tube being taken out and renewed without displacing any other part of the boiler.

The earliest form of water-tube boiler which came into general use is the British navy is the Belleville. Two views of this boiler are shown in fig. 14. It is composed of two parts, the boiler proper and the "economizer." Each of these consists of several sets of elements placed side by side; those of the boiler proper are situated immediately over the fire, and those of the

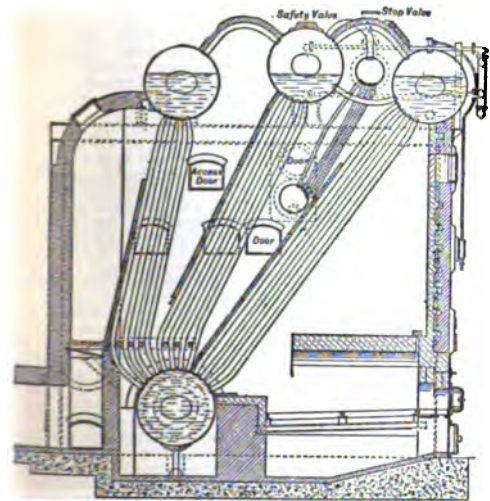

FIG. 12.—Stirling Water-tube Boiler.

economizer in the uptake above the boiler, the intervening space being designed to act as a combustion chamber. Each element is constructed of a number of straight tubes connected at their ends by means of screwed joints to junction-boxes which are made of malleable cast iron. These are arranged vertically over one another,

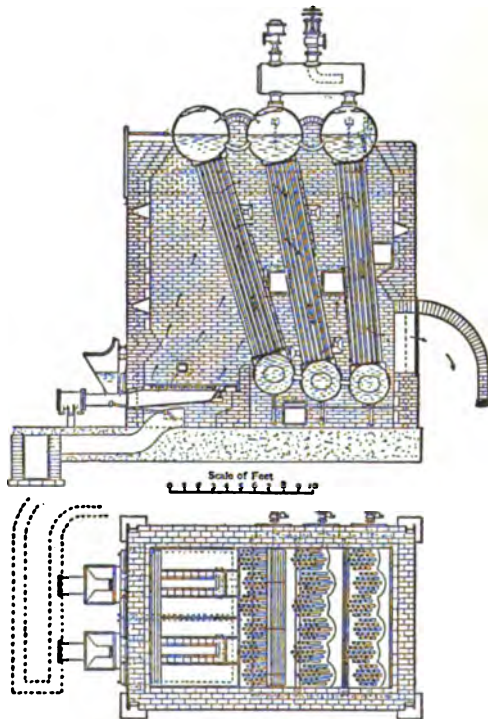

FIG. 13.—Woodson Boiler (Messrs Clarke, Chapman & Co.).

the fire are stirred up and mixed, their combustion being thereby facilitated before they pass into the spaces between the tubes. A similar air-tube is provided for the space between the

boiler proper and the economizer. Any water suspended in the steam is separated in a special separator fitted in the main steam-pipe, and the steam is further dried by passing through a reducing-valve, which ensures a steady pressure on the engine side of the valve, notwithstanding fluctuations of pressure in the boiler. The boiler pressure is usually maintained at about 50 lb per sq. in. in excess of that at which the engines are working, the excess forming a reservoir of energy to provide for irregular firing or feeding.

Another type of large-tube boiler which has been used in the British and in other navies is the "Niclauss" shown in fig. 15. It is also in use on land in several electric-light installations. It consists of a horizontal steam-chest under which is placed a number of elements arranged side by side over the fire, the whole being enclosed in an iron casing lined with firebrick where it is exposed to the direct action of the fire. Each element consists of a header of rectangular cross-section, fitted with two rows of inclined close-ended tubes, which slope downwards towards the back of the boiler with an inclination of 6° to the horizontal. The headers are usually of malleable cast iron with diaphragms cast in them, but sometimes steel has been employed, the bottoms being closed by a riveted steel plate, and the diaphragms being made of the same material. The headers are

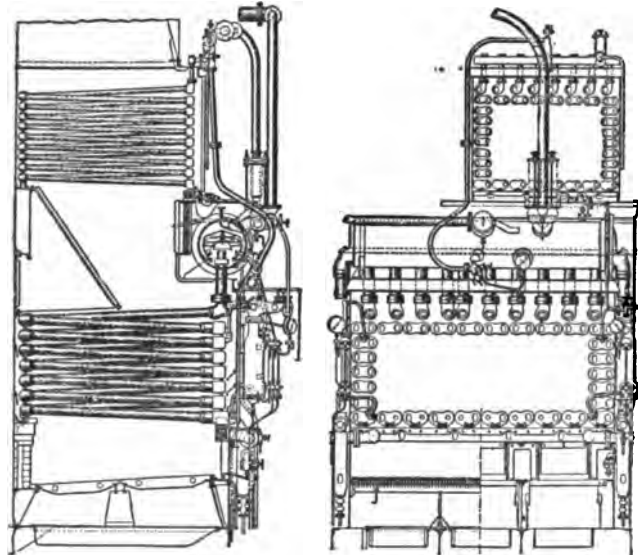

FIG. 14.—Belleville Boiler.

bolted to socket-pieces which are riveted to the bottom of the steam-chest, so that any element may be easily removed. The tube-holes are accurately bored, at an angle to suit the inclination of the tubes, through both the front and back of the headers and through the diaphragm, those in the header walls being slightly conical. The tubes themselves, which are made of seamless steel, are of peculiar construction. The lower or back ends are reduced in diameter and screwed and fitted with cap-nuts which entirely close them. The front ends are thickened by being upset, and the parts where they fit into the header walls and in the diaphragm are carefully turned to gauge. The upper and lower parts of the tubes between these fitting portions are then cut away, the side portions only being retained, and the end is termed a "lanterne." A small water-circulating tube of thin sheet steel, fitted inside each generating tube, is open at the lower end, and at the other is secured to a smaller "lanterne," which, however, only extends from the front of the header to the diaphragm. This smaller "lanterne" closes the front end of the generating tube. The whole arrangement is such that when the tubes are in place only the small inner circulating tubes communicate with the space between the front of the header and the diaphragm, while the annular spaces in the generating tubes around the water-circulating tubes communicate only with the space between the diaphragm and the back of the header. The steam formed in the tubes escapes from them into this back space, through which it rises into the steam-chest, whilst the space in the front of the header always contains a down-current of water supplying the inner circulating tubes. The tubes are maintained in position by cross-bars, each secured by one stud-bolt screwed into the header

front wall, and each serving to fix two tubes. The products of combustion ascend directly from the fire amongst the tubes, and the combustion is rendered more complete by the introduction of jets of high-pressure air immediately over the fire, as in the "Belleville" boiler.

The "Dürr" boiler, in use in several vessels in the German navy, and in a few vessels of the British navy, in some respects resembles the "Niclauss." The separate headers of the latter, however, are replaced by one large water-chamber formed of steel plates with welded joints, and instead of the tubes being secured by "lantes" to two plates they are secured to the inner plate only by conical joints, the holes in the outer plate being closed by small round doors fitted from the inside. In fixing the tubes each is separately forced into its position by means of a small portable hydraulic jack. The lower ends of the caps are closed by cap-nuts made of a special heat-resisting alloy of copper and manganese. Circulation is provided for by a diaphragm in the water-chamber and by inner tubes as in the Niclauss boiler. Baffle plates are fitted amongst the tubes to ensure a circulation of the furnace gases amongst them. Above the main set of tubes is a smaller set arranged horizontally, and connected directly to the steam receiver. These are fitted with internal tubes, and an internal diaphragm is provided so that steam from the chest circulates through these tubes on its way to the stop-valves. This supplementary set of tubes is intended to serve as a superheater, but the amount of surface is not sufficient to obtain more than a very small amount of superheat.

The Yarrow boiler (fig. 16) is largely in use in the British and also in several other navies. It consists of a large cylindrical steam chest and two lower water-chambers, connected by numerous straight tubes. In the boilers for large vessels all the tubes are of 1½ in. external diameter, but in the large express boilers the two rows nearest to the fire on each side are of 1½ in. and the remainder of 1 in. diameter. They are arranged with their centres forming equilateral triangles, and are spaced so that they can be cleaned externally both from the front of the boiler and also cross-ways in two directions. In some boilers the lower part of the steam-chest is connected with the water-chambers by large pipes outside the casings with the view of improving the circulation.

The largest size of single-ended large tube boiler in use has a steam drum 4 ft. 2 in. diameter, a grate area of 73.5 sq. ft. and 3750 sq. ft. of heating surface, but much larger double-ended boilers have been made, these being fired from both ends.

In most of the boilers made, access to the inside is obtained by manholes in the steam-chest and water-chamber ends, but in the smaller sizes fitted in torpedo boats the water-chambers are too small for this, and they are each arranged in two parts connected by a bolted joint, which makes all the tube ends accessible.

The Babcock & Wilcox marine boiler (fig. 17) is much used in the American and British navies, and it has also been used in several yachts and merchant steamers. It consists of a horizontal cylindrical steam-chest placed transversely over a group of elements, beneath which is the fire, the whole being enclosed in an iron casing lined with firebrick. Each element consists of a front and back header connected by numerous water-tubes which have a considerable inclination to facilitate the circulation. The upper ends of the front headers are situated immediately under the steam-chest and are connected to it by short nipples; by a similar means they are connected at the bottom to a pipe of square section which extends across the width of the boiler. Additional connexions are made by nearly vertical tubes between this cross-pipe and the bottom of the steam-chest. The back headers are each connected at their upper ends by means of two long horizontal tubes with the steam-chest, the bottom ends of the headers being closed. The headers are made of wrought steel, and except the outer pairs, which are flat on the outer portions, they are sinuous on both sides, the sinuosities fitting into one another. The tubes are of two sizes, the two lower rows and the return tubes between the back headers and steam-chest being 3½ in. outside diameter, and the remaining tubes 1½ in. The small tubes are arranged in groups of two or four to nearly all the sinuosities of the headers, the purpose of this arrangement being to give opportunities for the furnace gases to become well mixed together, and to ensure their contact with the heating surfaces. Access for securing the tubes in the headers is provided by a hole formed on the outer side of the tubes in the headers, and where they are grouped in fours, and by one larger hole opposite each group of two tubes. The larger holes are oval, and are closed by fittings similar to those used in the land boiler (fig. 18). The smaller holes are conical, with the larger diameter on the inside,

and are closed by special conical fittings: the conical portion and bolt are one forging, and the nut is close-ended. In case of the breakage of the bolt, the fitting would be retained in place by the steam-pressure. A set of firebrick baffles is placed so as to cover rather more than half of the spaces between the upper of the two bottom rows of large tubes, and another set of baffles covers about two-thirds of the spaces between the upper small tubes. Vertical baffles are also built between the smaller tubes, as shown in the longitudinal section. These baffles compel the products of combustion to circulate among the tubes in the direction shown by the arrows. Experience has shown that this arrangement gives a better evaporative efficiency than where the furnace gases are allowed to pass un baffled straight up between the tubes. The boilers are usually fitted in pairs placed back to back, and one side of each is always made accessible. On this side the casing is provided with

the water-level. The two inner rows of tubes, which are bent to the form shown in the figure, also form a water-wall for the larger portion of the length of the boiler, and thus compel the products of combustion to pass in a definite course amongst all the tubes. In the Blechynden and White-Foster boilers there are also three chambers connected by bent tubes, the curvature being so arranged that in the former boiler any of the tubes can be taken out of the boiler through small doors provided in the upper part of the steam-chest, and in the White-Foster boiler they can be taken out through the manhole in the end of the steam-chest.

In the Reed boiler the tubes are longer and more curved than in the Normand boiler, and there are no "water-walls," the products of combustion passing from the fire-grate amongst all the tubes direct to the chimney. The special feature of the boiler is that

each tube, instead of being expanded into the tube plate, is fitted at each end with specially designed screw and nut connections to enable them to be quickly taken out and replaced if necessary. At their lower ends the tubes are reduced in diameter to enable smaller chambers to be used than would otherwise be necessary. Provision is made for access to the lower tube ends by means of numerous doors in the water-chambers. Access to the top ends is obtained in the steam-chest.

Messrs John I. Thornycroft & Co. make two forms of express boiler. One called the Thornycroft boiler consists of three chambers connected by tubes which are straight for the major portion of their length but bent at each end to enable them to enter the steam- and water-chambers normally. The outer rows of tubes form "water-walls" at their lower parts, but permit the passage of the gases between them at their upper ends. Similarly the inner rows form "water-walls" at their upper parts, but are open at the lower ends. The products of combustion are thus compelled to pass over the whole of the heating surfaces. The fire-rows of tubes in this boiler are made 1½ in. outside diameter and the remainder are made 1¼ in. diameter. Large outside circulating pipes are provided at the front end of the boiler.

In the other type of boiler, known as the Thornycroft-Schuls boiler (fig. 20), there are four chambers, and the fire-grates are arranged in two separate portions. The two outermost rows of tubes on each side are arranged to form water-walls at their lower part, and permit the gases to pass between them at the upper part. The rows nearest the fires are arranged similarly to those in the Thornycroft boiler. Circulation in the outer sets of tubes is arranged for by outer circulating pipes of large diameter connecting the steam- and water-chambers. For the middle water-chamber several nearly vertical downcomers are provided in the centre of the boiler. Boilers of this type are extensively used in the British and German navies.

Material of Boilers.—In ordinary land boilers and in marine boilers of all types the plates and stays are almost invariably made of mild steel. For the shell plates and for long stays, a quality having a tensile strength ranging from 28 to 32 tons per sq. in. is usually employed, and for furnaces and flues, for plates which have to be flanged, and for short-screwed stays, a somewhat softer steel with a strength ranging from 26 to 30 tons per sq. in. is used. The tubes of ordinary land and marine boilers are usually made of lap-welded wrought iron. In water-tube boilers for naval purposes seamless steel tubes are invariably used. In locomotive boilers the shells are generally of mild steel, the fire-box plates of copper (in America of steel), the fire-box side stays of copper or special bronze, and other stays of steel. The tubes are usually of brass with a composition either of two parts by weight of copper to one of zinc or 70% copper, 30% zinc; sometimes, however, copper tubes and occasionally steel tubes are used. Where water tubes are used they are made of seamless steel.

Boiler Accessories.—All boilers must be provided with certain mountings and accessories. The water-level in them must be kept above the highest part of the heating surfaces. In some

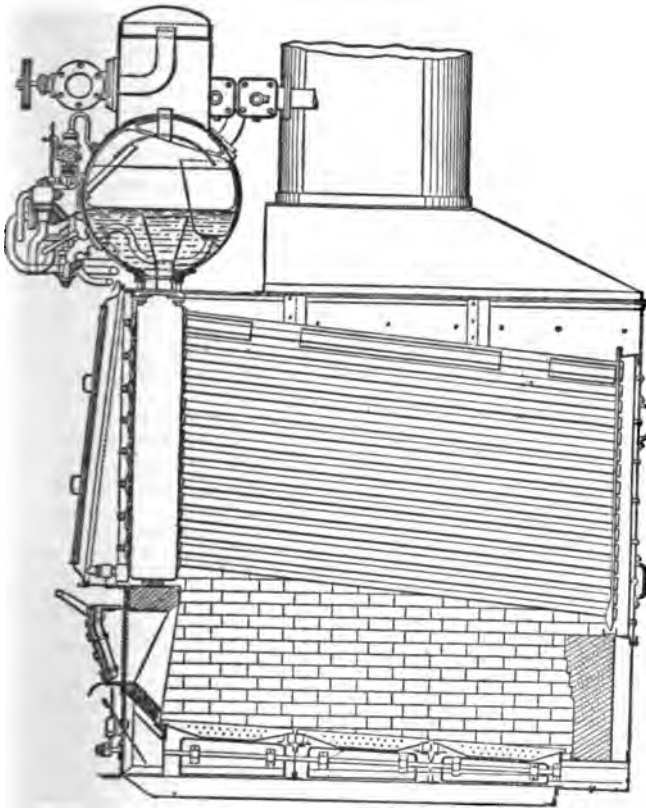

FIG. 15.—Niclausse Boiler—transverse section.

numerous small doors, through any of which a steam jet can be inserted for the purpose of sweeping the tubes.

A class of water-tube boilers largely in use in torpedo-boat destroyers and cruisers, where the maximum of power is required in proportion to the total weight of the installation, is generally known as express boilers. In these the tubes are made of smaller diameter than those used in the boilers already described, and the boilers are designed to admit of a high rate of combustion of fuel obtained by a high degree of "forced draught." Of these express boilers the Yarrow is of similar construction to the large tube Yarrow boiler already described, with the exception that the tubes are smaller in diameter and much more closely arranged.

In the Normand boiler (fig. 19) there are three chambers, as in the Yarrow, connected together by a large number of bent tubes which form the heating surface, and also connected at each end by large outside circulating tubes. The two outer rows of heating tubes on each side are arranged to touch one another for nearly their whole length so as to form a "water-wall" for the protection of the outer casing. They enter the steam-chest at about

boiler proper and the economizer. Any water suspended in the steam is separated in a special separator fitted in the main steam-pipe, and the steam is further dried by passing through a reducing-valve, which ensures a steady pressure on the engine side of the valve, notwithstanding fluctuations of pressure in the boiler. The boiler pressure is usually maintained at about 50 lb per sq. in. in excess of that at which the engines are working, the excess forming a reservoir of energy to provide for irregular firing or feeding.

Another type of large-tube boiler which has been used in the British and in other navies is the "Niclausse," shown in fig. 15. It is also in use on land in several electric-light installations. It consists of a horizontal steam-chest under which is placed a number of elements arranged side by side over the fire, the whole being enclosed in an iron casing lined with firebrick where it is exposed to the direct action of the fire. Each element consists of a header of rectangular cross-section, fitted with two rows of inclined close-ended tubes, which slope downwards towards the back of the boiler with an inclination of 6° to the horizontal. The headers are usually of malleable cast iron with diaphragms cast in them, but sometimes steel has been employed, the bottoms being closed by a riveted steel plate, and the diaphragms being made of the same material. The headers are

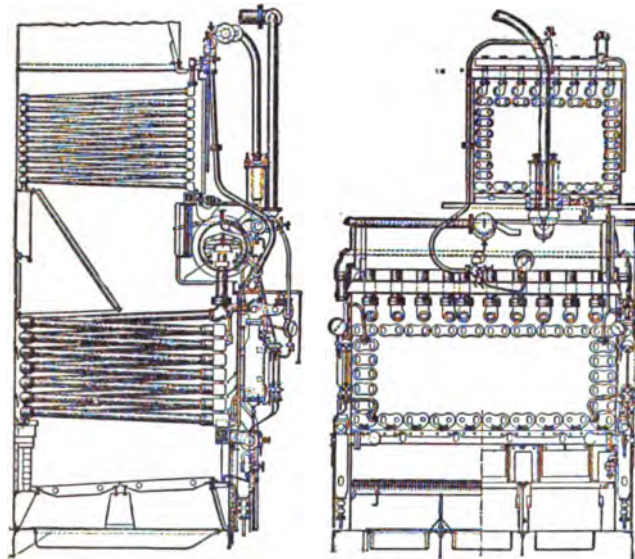

FIG. 14.—Belleville Boiler.

bolted to socket-pieces which are riveted to the bottom of the steam-chest, so that any element may be easily removed. The tube-holes are accurately bored, at an angle to suit the inclination of the tubes, through both the front and back of the headers and through the diaphragm, those in the header walls being slightly conical. The tubes themselves, which are made of seamless steel, are of peculiar construction. The lower or back ends are reduced in diameter and screwed and fitted with cap-nuts which entirely close them. The front ends are thickened by being upset, and the parts where they fit into the header walls and in the diaphragm are carefully turned to gauge. The upper and lower parts of the tubes between these fitting portions are then cut away, the side portions only being retained, and the end is termed a "lanterne." A small water-circulating tube of thin sheet steel, fitted inside each generating tube, is open at the lower end, and at the other is secured to a smaller "lanterne," which, however, only extends from the front of the header to the diaphragm. This smaller "lanterne" closes the front end of the generating tube. The whole arrangement is such that when the tubes are in place only the small inner circulating tubes communicate with the space between the front of the header and the diaphragm, while the annular spaces in the generating tubes around the water-circulating tubes communicate only with the space between the diaphragm and the back of the header. The steam formed in the tubes escapes from them into this back space, through which it rises into the steam-chest, whilst the space in the front of the header always contains a down-current of water supplying the inner circulating tubes. The tubes are maintained in position by cross-bars, each secured by one stud-bolt screwed into the header

front wall, and each serving to fix two tubes. The products of combustion ascend directly from the fire amongst the tubes, and the combustion is rendered more complete by the introduction of jets of high-pressure air immediately over the fire, as in the "Belleville" boiler.

The "Dürr" boiler, in use in several vessels in the German navy, and in a few vessels of the British navy, in some respects resembles the "Niclausse." The separate headers of the latter, however, are replaced by one large water-chamber formed of steel plates with welded joints, and instead of the tubes being secured by "lanternes" to two plates they are secured to the inner plate only by conical joints, the holes in the outer plate being closed by small round doors fitted from the inside. In fixing the tubes each is separately forced into its position by means of a small portable hydraulic jack.

The lower ends of the caps are closed by cap-nuts made of a special heat-resisting alloy of copper and manganese. Circulation is provided for by a diaphragm in the water-chamber and by inner tubes as in the Niclausse boiler. Baffle plates are fitted amongst the tubes to ensure a circulation of the furnace gases amongst them. Above the main set of tubes is a smaller set arranged horizontally, and connected directly to the steam receiver. These are fitted with internal tubes, and an internal diaphragm is provided so that steam from the chest circulates through these tubes on its way to the stop-valves. This supplementary set of tubes is intended to serve as a superheater, but the amount of surface is not sufficient to obtain more than a very small amount of superheat.

The Yarrow boiler (fig. 16) is largely in use in the British and also in several other navies. It consists of a large cylindrical steam chest and two lower water-chambers, connected by numerous straight tubes. In the boilers for large vessels all the tubes are of 1½ in. external diameter, but in the large express boilers the two rows nearest to the fire on each side are of 1½ in. and the remainder of 1 in. diameter. They are arranged with their centres forming equilateral triangles, and are spaced so that they can be cleaned externally both from the front of the boiler and also cross-ways in two directions. In some boilers the lower part of the steam-chest is connected with the water-chambers by large pipes outside the casings with the view of improving the circulation.

The largest size of single-ended large tube boiler in use has a steam drum 4 ft. 2 in. diameter, a grate area of 73.5 sq. ft. and 3750 sq. ft. of heating surface, but much larger double-ended boilers have been made, these being fired from both ends.

In most of the boilers made, access to the inside is obtained by manholes in the steam-chest and water-chamber ends, but in the smaller sizes fitted in torpedo boats the water-chambers are too small for this, and they are each arranged in two parts connected by a bolted joint, which makes all the tube ends accessible.

The Babcock & Wilcox marine boiler (fig. 17) is much used in the American and British navies, and it has also been used in several yachts and merchant steamers. It consists of a horizontal cylindrical

which is the fire, the whole being enclosed in an iron casing lined with firebrick. Each element consists of a front and back header connected by numerous water-tubes which have a considerable inclination to facilitate the circulation. The upper ends of the front headers are situated immediately under the steam-chest and are connected to it by short nipples; by a similar means they are connected at the bottom to a pipe of square section which extends across the width of the boiler. Additional connexions are made by nearly vertical tubes between this cross-pipe and the bottom of the steam-chest. The back headers are each connected at their upper ends by means of two long horizontal tubes with the steam-chest, the bottom ends of the headers being closed. The headers are made of wrought steel, and except the outer pairs, which are flat on the outer portions, they are sinuous on both sides, the sinuosities fitting into one another. The tubes are of two sizes, the two lower rows and the return tubes between the back headers and steam-chest being 3½ in. outside diameter, and the remaining tubes 1½ in. The small tubes are arranged in groups of two or four to nearly all of the sinuosities of the headers, the purpose of this arrangement being to give opportunities for the furnace gases to become well mixed together, and to ensure their contact with the heating surfaces. Access for securing the tubes in the headers is provided by a hole formed on the other side of the header opposite each of the tubes, where they are grouped in fours, and by one larger hole opposite each group of two tubes. The larger holes are oval, and are closed by fittings similar to those used in the land boiler (fig. 18). The smaller holes are conical, with the larger diameter on the inside,

and are closed by special conical fittings: the conical portion and bolt are one forging, and the nut is close-ended. In case of the breakage of the bolt, the fitting would be retained in place by the steam-pressure. A set of firebrick baffles is placed so as to cover rather more than half of the spaces between the upper of the two bottom rows of large tubes, and another set of baffles covers about two-thirds of the spaces between the upper small tubes. Vertical baffles are also built between the smaller tubes, as shown in the longitudinal section. These baffles compel the products of combustion to circulate among the tubes in the direction shown by the arrows. Experience has shown that this arrangement gives a better evaporative efficiency than where the furnace gases are allowed to pass un baffled straight up between the tubes. The boilers are usually fitted in pairs placed back to back, and one side of each is always made accessible. On this side the casing is provided with

the water-level. The two inner rows of tubes, which are bent to the form shown in the figure, also form a water-wall for the larger portion of the length of the boiler, and thus compel the products of combustion to pass in a definite course amongst all the tubes. In the Blechynden and White-Foster boilers there are also three chambers connected by bent tubes, the curvature being so arranged that in the former boiler any of the tubes can be taken out of the boiler through small doors provided in the upper part of the steam-chest, and in the White-Foster boiler they can be taken out through the manhole in the end of the steam-chest.

In the Reed boiler the tubes are longer and more curved than in the Normand boiler, and there are no "water-walls," the products of combustion passing from the fire-grate amongst all the tubes direct to the chimney. The special feature of the Reed boiler is that each tube, instead of being expanded into the tube plate, is fitted at each end with specially designed screw and nut connexions to enable them to be quickly taken out and replaced if necessary. At their lower ends the tubes are reduced in diameter to enable smaller chambers to be used than would otherwise be necessary. Provision is made for access to the lower tube ends by means of numerous doors in the water-chambers. Access to the top ends is obtained in the steam-chest.

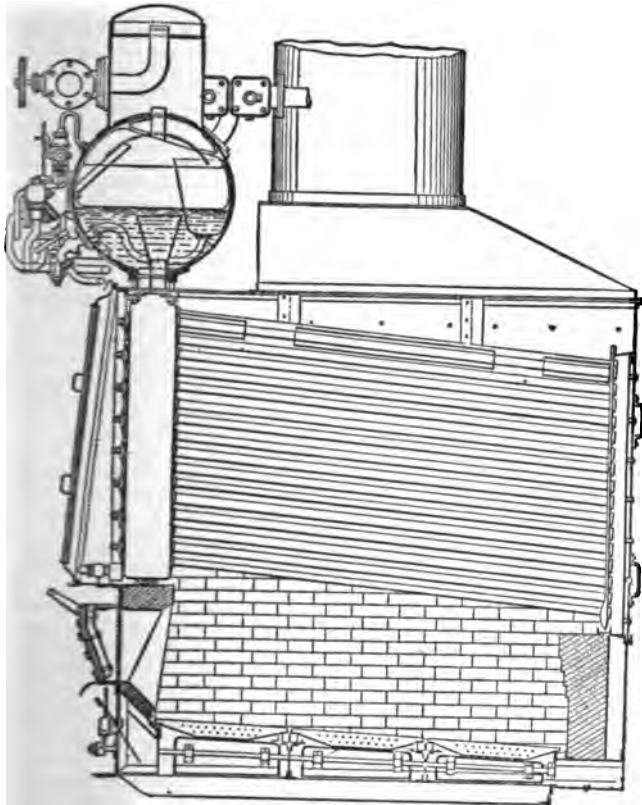

FIG. 15.—Niclausse Boiler—transverse section.

numerous small doors, through any of which a steam jet can be inserted for the purpose of sweeping the tubes.

A class of water-tube boilers largely in use in torpedo-boat destroyers and cruisers, where the maximum of power is required in proportion to the total weight of the installation, is generally known as express boilers. In these the tubes are made of smaller diameter than those used in the boilers already described, and the boilers are designed to admit of a high rate of combustion of fuel obtained by a high degree of "forced draught." Of these express boilers the Yarrow is of similar construction to the large tube Yarrow boiler already described, with the exception that the tubes are smaller in diameter and much more closely arranged.

In the Normand boiler (fig. 19) there are three chambers, as in the Yarrow, connected together by a large number of bent tubes which form the heating surface, and also connected at each end by large outside circulating tubes. The two outer rows of heating tubes on each side are arranged to touch one another for nearly their whole length so as to form a "water-wall" for the protection of the outer casing. They enter the steam-chest at about

Messrs John I. Thornycroft & Co. make two forms of express boiler. One called the Thornycroft boiler consists of three chambers connected by tubes which are straight for the major portion of their length but bent at each end to enable them to enter the steam- and water-chambers normally. The outer rows of tubes form "water-walls" at their lower parts, but permit the passage of the gases between them at their upper ends. Similarly the inner rows form "water-walls" at their upper parts, but are open at the lower ends. The products of combustion are thus compelled to pass over the whole of the heating surfaces. The fire-rows of tubes in this boiler are made 1 1/2 in. outside diameter and the remainder are made 1 1/4 in. diameter. Large outside circulating pipes are provided at the front end of the boiler.

In the other type of boiler, known as the Thornycroft-Schulz boiler (fig. 20), there are four chambers, and the fire-grates are arranged in two separate portions. The two outermost rows of tubes on each side are arranged to form water-walls at their lower part, and permit the gases to pass between them at the upper part. The rows nearest the fires are arranged similarly to those in the Thornycroft boiler. Circulation in the outer sets of tubes is arranged for by outer circulating pipes of large diameter connecting the steam- and water-chambers. For the middle water-chamber several nearly vertical down-comers are provided in the centre of the boiler. Boilers of this type are extensively used in the British and German navies.

Material of Boilers.—In ordinary land boilers and in marine boilers of all types the plates and stays are almost invariably made of mild steel. For the shell plates and for long stays, a quality having a tensile strength ranging from 28 to 32 tons per sq. in. is usually employed, and for furnaces and flues, for plates which have to be flanged, and for short-screwed stays, a somewhat softer steel with a strength ranging from 26 to 30 tons per sq. in. is used. The tubes of ordinary land and marine boilers are usually made of lap-welded wrought iron. In water-tube boilers for naval purposes seamless steel tubes are invariably used. In locomotive boilers the shells are generally of mild steel, the fire-box plates of copper (in America of steel), the fire-box side stays of copper or special bronze, and other stays of steel. The tubes are usually of brass with a composition either of two parts by weight of copper to one of zinc or 70% copper, 30% zinc; sometimes, however, copper tubes and occasionally steel tubes are used. Where water tubes are used they are made of seamless steel.

Boiler Accessories.—All boilers must be provided with certain mountings and accessories. The water-level in them must be kept above the highest part of the heating surfaces. In some

land boilers, and in some of the water-tube boilers used on shipboard, the feeding is automatically regulated by mechanism actuated by a float, but in these cases means of regulating the feed-supply by hand are also provided. In most boilers hand regulation only is relied upon. The actual level of water in the boiler is ascertained by a glass water-gauge, which consists of a glass tube and three cocks, two communicating directly with the boiler, one above and one below the desired water-level, and the third acting as a blow-out for cleaning the gauge and for testing its working. Three small try-cocks are also fitted, one just at, one above, and one below the proper water-level. The feeding of the boiler is sometimes performed by a pump driven from the main engine, sometimes by an independent steam-pump, and sometimes by means of an injector. The feed-water is admitted by a "check-valve," the lift of which is regulated by a screw and

two bolts, secured to cross-bars or "dogs" outside the boiler. It is important in making these doors that they should fit the holes so accurately that the jointing material cannot be forced out of its proper position. In the few cases where doors are fitted outside a boiler, so that the steam-pressure tends to open them, they are always secured by several bolts so that the breakage of one bolt will not allow the door to be forced off.

Water-softening.—Seeing that the impurities contained in the feed-water are not evaporated in the steam they become concentrated in the boiler water. Most of them become precipitated in the boiler either in the form of mud or else as scale which forms on the heating surfaces. Some of the mud and such of the impurities as remain soluble may be removed by means of the blow-off cocks, but the scale can only be removed by periodical cleaning. Incrustations on the heating surface not only lessen the efficiency of the boiler by obstructing the transmission of heat through the plates and tubes, but if excessive they become a source of considerable danger by permitting the plates to become overheated and thereby weakened. When the feed-water is very impure, therefore, the boilers used are those which permit of very easy cleaning, such as the Lancashire, Galloway and Cornish types, to the exclusion of multitubular or water-tube boilers in which thorough cleaning is more difficult. In other cases, however, the feed-water is purified by passing it through some type of "softener" before pumping it into the boiler. Most of the impurities in ordinary feed-water are either lime or magnesia salts, which although soluble in cold water are much less so in hot water. In the "softener" measured quantities of feed-water and of some chemical reagents are thoroughly mixed and at the same time the temperature is raised either by exhaust steam or by other means. Most of the impurity is thus precipitated, and some of the remainder is converted into more soluble salts which remain in solution in the boiler until blown out. The water is filtered before being pumped into the boiler. The quantity and kind of chemical employed is determined according to the nature and amount of the impurity in the "hard" feed-water.

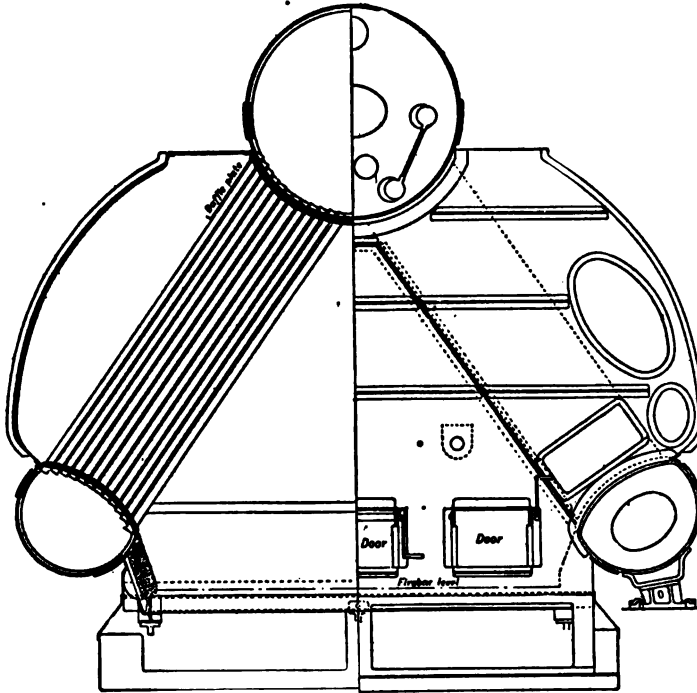

FIG. 16.—Yarrow Water-tube Boiler.

hand-wheel, and which when the feed-pump is not working is kept on its seating by the boiler pressure.

Every boiler is in addition supplied with a steam-gauge to indicate the steam-pressure, with a stop-valve for regulating the admission of steam to the steam-pipes, and with one or two safety-valves. These last in stationary boilers usually consist of valves kept in their seats against the steam-pressure in the boiler by levers carrying weights, but in marine and locomotive boilers the valves are kept closed by means of steel springs. One at least of the safety-valves is fitted with easing gear by which it can be lifted at any time for blowing off the steam. Blow-out cocks are fitted for emptying the boiler.

Openings must always be made in boilers for access for cleaning and examination. When these are large enough to allow a man to enter the boiler they are termed man-holes. They are usually made oval, as this shape permits the doors by which they are closed to be placed on the inside so that the pressure upon them tends to keep them shut. The doors are held in place by one or

where the work required is very intermittent, "thermal storage" is employed. Above the boiler a large cylindrical storage vessel is placed, having sufficient capacity to contain enough feed-water to supply the boiler throughout the periods when the maximum output is required. The upper part of this storage vessel is always in free communication with the steam space of the boiler, and from the lower part of it the feed-water may be run into the boiler when required. The feed-water is delivered into the upper part of the vessel, and arrangements are made by which before it falls to the bottom of the chamber it runs over very extended surfaces exposed to the steam, its temperature being thus raised to that of the steam. At times when less than the normal supply of steam is required for the engine more than the average quantity of feed-water is pumped into the chamber, and the excess accumulates with its temperature raised to the evaporation point. When an extra supply of steam is required, the feed-pump is stopped and the boiler is fed with the hot water stored in the chamber. Besides the "storage" effect, it is found that many

of the impurities of the feed become deposited in the chamber, where they are comparatively harmless and from which they are readily removable.

Oil Separators.—When the steam from the engines is condensed and used as feed-water, as is the case with marine boilers, much difficulty is often experienced with the oil which passes

metallic contact between the zinc and the boiler-plate. The function of the zinc is to set up galvanic action; it plays the part of the negative metal, and is dissolved while the metal of the shell is kept electro-positive. Care must always be taken that the fragments which break off the zinc as it wastes away cannot fall upon the heating surfaces of the boiler.

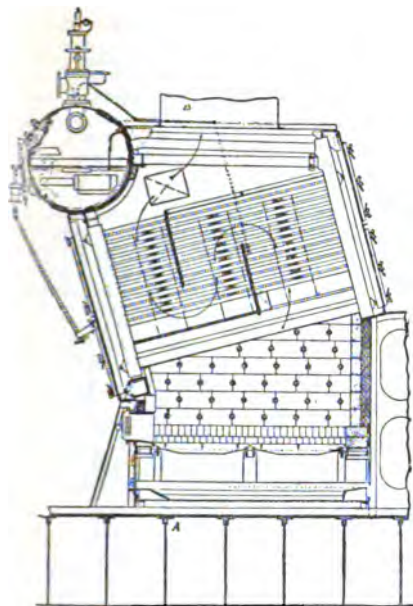

Longitudinal section.

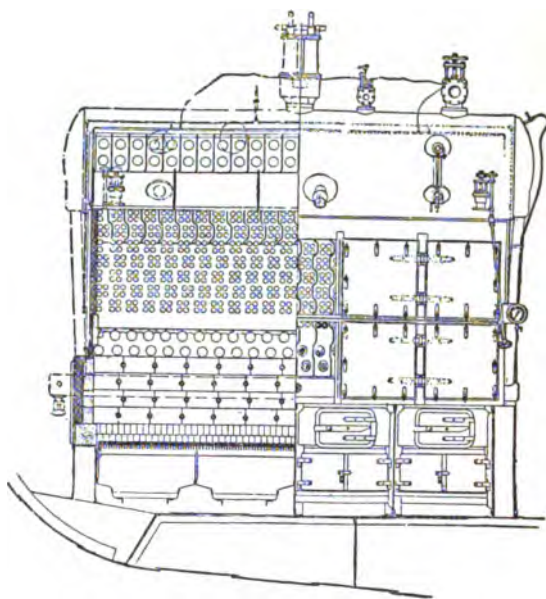

Section at AB—Front elevation.

FIG. 17.—Babcock & Wilcox Water-tube Boiler (marine type).

over with the steam. Feed-filters are employed to stop the coarser particles of the oil, but some of the oil becomes "emulsified" or suspended in the water in such extremely minute particles that they pass through the finest filtering materials. On the evaporation of the water in the boiler, this oil is left as a thin film upon the heating surfaces, and by preventing the actual contact of water with the plates has been the cause of serious trouble. An attempt has been made to overcome the emulsion difficulty by uniformly mixing with the water a small quantity of solution of lime. On the water being raised in temperature the lime is precipitated, and the minute particles separated apparently attract the small globules of oil and become aggregated in sufficient size to deposit themselves in quiet parts of the boiler, whence they can be occasionally removed either by blowing out or by cleaning. Much, however, still remains to be done before the oil difficulty will be thoroughly removed.

Corrosion.—When chemicals of any kind are used to soften or purify feed-water it is essential that neither they nor the products they form should have a corrosive effect upon the boiler-plates, &c. Much of the corrosion which occasionally occurs has been traced to the action of the oxygen of the air which enters the boiler in solution in the feed-water, and the best practice now provides for the delivery of the feed into the boiler at such positions that the air evolved from it as it becomes heated passes direct to the steam space without having an opportunity of becoming disengaged upon the under water surfaces of the boiler.

Where corrosion is feared it is usual to fit zinc slabs in the water spaces of the boiler. Experience shows that it is better to make them of rolled rather than of cast zinc, and to secure them on studs which can be kept bright, so as to ensure a direct

Evaporators.—In marine boilers the waste of water which occurs from leakages in the cycle of the evaporation in the boiler, use in the engine, condensation in the condenser and return to the boiler as feed-water, is made up by fresh water distilled from sea-water in "evaporators." Of these there are many forms with different provisions for cleaning the coils, but they are all identical in principle. They are fed with sea-water, and means are provided for blowing out the brine produced in them when some of the water is evaporated. The heat required for the evaporation is obtained from live steam from the boilers, which is admitted into coils of copper pipe. The water condensed in these coils is returned direct to the feed-water, and the steam evaporated from the sea-water is led either into the low-pressure receiver of the steam-engine or into the condenser.

Efficiency of Boilers.—The useful work obtained from any boiler depends upon many considerations. For a high efficiency, that is, a large amount of steam produced in proportion to the amount of fuel consumed, different conditions have to be fulfilled from those required where a large output of steam from a given plant is of more importance than economy of fuel. For a high efficiency, completeness of combustion of fuel must be combined with sufficient heating surface to absorb so much of the heat

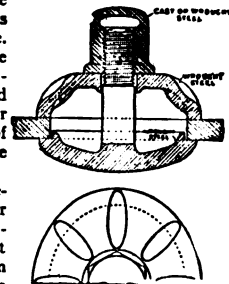

FIG. 18.—Handhole Fittings.

produced as will reduce the temperature of the funnel gases to nearly that of steam. Completeness of combustion can only be obtained by admitting considerably more air to the fire than is theoretically necessary fully to oxidize the combustible portions of the fuel, and by providing sufficient time and opportunity for a thorough mixture of the air and furnace gases to take place before the temperature is lowered to that critical point below which combustion will not take place. It is generally considered that the amount of excess air required is nearly equal to that theoretically necessary; experience, however, tends to show that much less than this is really required if proper means are provided for ensuring an early complete mixture of the gases. Different means are needed to effect this with different kinds of coal, those necessary for properly burning Welsh coal being altogether unsuitable for use with North Country or Scottish coal. As all the excess air has to be raised to the same temperature as that of the really burnt gases, it follows that an excess of air passing through the fire lowers the temperature in the fire and flues, and therefore lessens the heat transmission; and as it leaves the boiler at a high temperature it carries off some of the heat produced. A reduction of the amount of air, therefore, may, by increasing the fire temperature

purposes, although "natural" draught is the more common, many boiler installations are fitted with "forced" draught arrangements. Two distinct systems are used. In that known as the "closed stokehold" the stokehold compartment of the vessel is so closed that the only exit for air from it is through the fires. Air is driven into the stokehold by means of fans which are made so that they can maintain an air pressure in the stokehold above that of the outside atmosphere. This is the system almost universally adopted in war vessels, and it is used also in some fast passenger ships. The air pressure usually adopted in large vessels is that corresponding to a height of from 1 to 1½ in. of water, whilst so much as 4 in. is sometimes used in torpedo-boats and similar craft. This is, of course, in addition to the chimney-draught due to the height of the funnel. In the closed ashpit or Howden system, the stokehold is open, and fans drive the air round a number of tubes, situated in the uptake, through which the products of combustion pass on their way to the chimney. The air thus becomes heated, and part of it is then delivered into the ashpit below the fire and part into a casing round the furnace front from which it enters the furnace above the fire. In locomotive boilers the draught is produced by the blast or the exhaust steam. With natural draught a

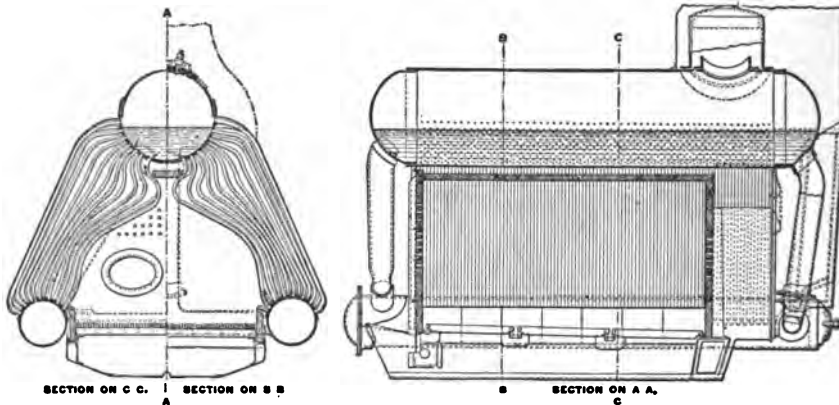

FIG. 19.—Normand Boiler.

and lessening the chimney waste, actually increase the efficiency even if at the same time it is accompanied by a slight incompleteness of combustion.

Mechanical Stoking.—Most boilers are hand-fired, a system involving much labour and frequent openings of the furnace doors, whereby large quantities of cold air are admitted above the fires. Many systems of mechanical stoking have been tried, but none has been found free from objections. That most usually employed is known as the "chain-grate" stoker. In this system, which is illustrated in fig. 13 (Woodeson boiler), the grate consists of a wide endless chain formed of short cast-iron bars; this passes over suitable drums at the front and back of the boiler, by the slow rotation of which the grate travels very slowly from front to back. The coal, which is broken small, is fed from a hopper over the whole width of the grate, the thickness of the fire being regulated by a door which can be raised or lowered as desired. Thus the volatile portions of the coal are distilled at the front of the fire, and pass over the incandescent fuel at the back end. The speed of travel is so regulated that by the time the remaining parts of the fuel reach the back end the combustion is nearly complete. It will be seen that the fire becomes thinner towards the back, and too much air is prevented from entering the thin portion by means of vanes actuated from the front of the boiler.

Draught.—In most boilers the draught necessary for combustion is "natural," i.e. produced by a chimney. For marine

combustion of about 15 to 20 lb. of coal per sq. ft. of grate area per hour can be obtained. With forced draught much greater rates can be maintained, ranging from 20 lb to 35 lb in the larger vessels with a moderate air pressure, to as much as 70 and even 80 lb per sq. ft. in the express types of boiler used in torpedo boats and similar craft.

Performance of Boilers.—The makers of several types of boilers have published particulars regarding the efficiency of the boilers they construct, but naturally these results have been obtained under the most favourable circumstances which may not always represent the conditions of ordinary working. The following table of actual results of marine boiler trials, made at the instance of the British admiralty, is particularly useful because the trials were made with great care under working conditions, the whole of the coal being weighed and the feed-water measured throughout the trials by skilled observers. The various trials can be compared amongst themselves as South Welsh coal of excellent quality was used in all cases.

In experimental tests such as those above referred to, many conditions have to be taken into account, the principal being the duration of the trial. It is essential that the condition of the boiler at the conclusion of the test should be precisely the same as at the commencement, both as regards the quantity of unconsumed coals on the fire-grate and the quantity of water and the steam-pressure in the boiler. The longer the period over which the observations are taken the less is the influence of errors

in the estimation of these particulars. Further, in order properly to represent working conditions, the rate of combustion of the fuel throughout the trial must be the same as that intended to be used in ordinary working, and the duration of the test must be sufficient to include proportionately as much cleaning of fires as would occur under the normal working conditions. The tests should always be made with the kind of coal intended to be generally used, and the records should include a test of the calorific value of a sample of the fuel carefully selected so as fairly

be conveniently treated together, because similar materials and methods are employed in each, notwithstanding that many points of divergence in practice generally relegate them to separate departments. The materials used are chiefly iron and steel. The methods mostly adopted are those involved in the working of plates and rolled sections, which vastly predominate over the bars and rods used chiefly in the smithy. But there are numerous differences in methods of construction. Flanging occupied a large place in boilermaking, for end-plates, tube-plates, furnace

TRIALS OF VARIOUS TYPES OF MARINE BOILERS

Description of Boiler.	Grate Area sq. ft.	Heating Surface sq. ft.	Duration of Trial Hours.	Coal burned per sq. ft. of Grate per Hour.	Air Pressure in Stoker-hold—Inches of Water.	Chimney Draught—Inches of Water.	Water Evaporated per sq. ft. of Coal.		Water evaporated per sq. ft. of Heating Surface.	Thermal Units per lb of Coal.	Efficiency of Boiler %.
							Actual.	From and at 212° F.			
Ordinary cylindrical single-ended; 3 furnaces; 135 lb working pressure; closed stoker-hold system ¹	81	2308	25	14.2	Nil	0.36	8.56	10.26	4.26	14,267	69.7
			24	13.9	"	0.50	8.84	10.33	4.32	14,697	68.0
			9	30.3	0.81	0.39	7.93	9.27	8.46	14,686	61.4
Ordinary cylindrical single-ended; 3 furnaces; 210 lb working pressure; closed ashpit, Howden system ²	63.2	2876 in boiler, 766 in air heaters	8½	29.1	0.65	0.32	8.84	10.34	9.05	14,512	68.4
			13	20.6	In Ash-pit 1.53	0.58	11.30	12.33	5.14	14,475	82.3
			8	12.8	Nil	0.20	8.41	10.15	3.75	14,580	66.9
Niclausse water-tube; 160 lb working pressure	46	1322	8	12.8	Nil	0.20	8.41	10.15	3.75	14,580	66.9
			8	21.9	"	0.20	8.01	9.40	6.11	14,760	62.1
			37	20.2	"	0.29	7.62	9.00	5.44	14,600	60.5
Niclausse water-tube; 250 lb working pressure	34	990	9	14.0	0.10	0.23	8.77	10.50	4.17	14,640	69.8
			9	22.0	0.27	0.23	7.68	9.06	5.74	14,540	60.4
			90	15.4	Nil	Not ascertained	7.61	9.08	4.00	14,630	59.9
Babcock water-tube; 3½ in. tubes; 260 lb working pressure	36	1010	9	13.0	"	0.20	9.31	11.02	4.30	14,590	73.2
			9	20.0	0.18	0.20	8.58	10.11	6.13	14,590	67.0
			90	14.5	Nil	Not ascertained	8.09	9.53	4.18	14,590	63.1
Babcock water-tube; 1½ in. tubes; 270 lb working pressure ³	62	2167	28	18.4	"	0.45	8.94	10.61	4.61	14,520	70.7
			24	19.2	"	0.47	8.93	10.59	4.82	14,390	71.1
			12	20.5	"	0.42	9.42	11.04	5.41	14,080	75.8
Belleville water-tube with economizers; 330 lb working pressure	44	910 in boiler, 447 in economizer; 1357 total 2896	7	28.9	0.50	Not ascertained	8.54	9.88	6.91	14,390	66.3
			30	19.9	Nil	0.38	10.11	12.00	6.01	14,530	79.9
			29	27.1	0.66	0.23	9.96	11.67	8.05	14,630	77.1
Yarrow water-tube; 1½ in. tubes; 250 lb working pressure	56	2896	24	15.8	Nil	0.36	9.65	11.46	4.94	14,697	77.2
			24	17.4	"	0.39	9.33	11.00	5.30	14,803	71.8
			11	19.8	"	0.43	9.39	11.03	6.38	14,578	73.3
Durr water-tube; 250 lb working pressure	71	2671 in boiler, 140 in super-heater; 2811 total	8	27.2	"	0.39	8.28	9.79	7.78	14,611	65.0
			26	16.9	"	0.31	9.57	11.45	3.12	14,750	75.0
			26	18.2	"	0.31	9.37	11.33	3.30	14,500	75.7
Durr water-tube; 250 lb working pressure	71	2811 total	25	21.3	"	0.31	8.83	10.45	3.63	13,500	75.2
			30	35.4	0.53	0.26	8.82	10.59	6.04	14,430	70.9
			8	41.9	0.86	0.31	8.24	9.94	6.69	14,500	66.3
Durr water-tube; 250 lb working pressure	71	2811 total	8	33.7	0.31	0.30	8.39	9.93	5.47	14,680	65.4
			8	39.8	0.82	0.24	8.85	10.43	6.81	14,530	69.3
			26	16.1	Nil	0.39	7.95	9.59	3.24	14,500	63.8
Durr water-tube; 250 lb working pressure	71	2811 total	26	17.7	"	0.30	7.06	9.28	3.43	14,520	61.7
			7	31.8	"	0.31	7.62	9.08	4.05	14,650	60.3
			8	31.8	0.70	0.36	7.72	9.29	6.59	14,570	62.7
Durr water-tube; 250 lb working pressure	71	2811 total	8	26.7	0.33	0.35	7.86	9.26	5.30	14,320	63.1
			8	34.6	1.11	0.20	8.02	9.53	7.02	14,230	64.8
			22	34.8	0.73	0.16	6.84	8.06	6.02	14,430	54.0
Durr water-tube; 250 lb working pressure	71	2811 total	24	29.9	0.35	0.12	7.62	9.00	5.75	14,240	61.2
			20	19.9	Nil	0.21	7.30	8.33	3.66	14,240	58.6

¹ In the first three trials no retarders were used in the tubes. In the last trial retarders were used.

² In this trial retarders were used in the tubes.

³ The first four trials were made with horizontal baffles above the tubes; the last two trials with the baffling described in the text.

to represent the bulk of the coal used during the trial. The periodic records taken are the weights of the fuel used and of the ashes, &c., produced, the temperature and quantity of the feed-water, the steam pressure maintained, and the wetness of the steam produced. This last should be ascertained from samples taken from the steam pipe at a position where the full pressure is maintained. In order to reduce to a common standard observations taken under different conditions of feed temperatures and steam pressures, the results are calculated to an equivalent evaporation at the atmospheric pressure from a feed temperature of 212° F. (J. T. M.I.)

BOILER MAKING

The practice of the boiler, bridge and girder shops may here

flues, &c., but is scarcely represented in bridge and girder work. Plates are bent to cylindrical shapes in boilermaking, for shells and furnaces, but not in girder work. Welding is much more common in the first than in the second, furnace flues being always welded and stand pipes frequently. In boiler work holes are generally drilled through the seams of adjacent plates. In bridge work each plate or bar is usually drilled or punched apart from its fellows. Boilers, again, being subject to high temperatures and pressures, must be constructed with provisions to ensure some elasticity and freedom of movement under varying temperatures to prevent fractures or grooving, and must be made of materials that combine high ductility with strength when heated to furnace temperatures. Flanging of certain parts, judicious staying, limitation of the length of the tubes,

the forms of which are inherently weak, provide for the first; the selection of steel or iron of high percentage elongation, and the imposition of temper, or bending tests, both hot and cold, provide for the second.

The following are the leading features of present-day methods. It might be hastily supposed that, because plates, angles, tees, channels and joint sections are rolled ready for use, little work could be left for the plater and boilermaker. But actually so much is involved that subdivisions of tasks are numerous; the operations of templet-making, rolling, planing, punching and shearing, bending,

quent stress, with liability to produce fracture. But it has been found that, when a shorn edge is planed and a punched hole enlarged by reaming, no harm results, provided not less than about $\frac{1}{8}$ in. is removed. A great advance was therefore made when specifications first insisted on the removal of the rough edges before the parts were united.

In the work of riveting another evil long existed. When holes are punched it is practically impossible to ensure the exact coincidence of holes in different plates which have to be brought together for the purpose of riveting. From this followed the use of the drift,—a tapered rod driven forcibly by hammer blows through correspond-

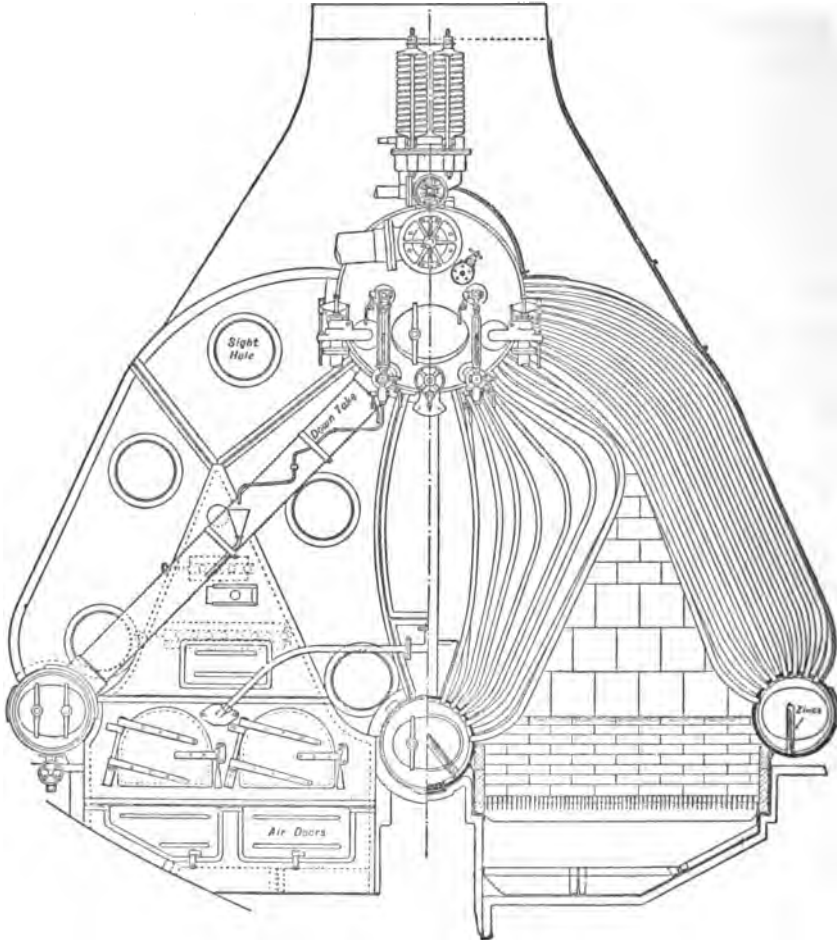

FIG. 20.—Thornycroft-Schulz Water-tube Boiler.

welding and forging, flanging, drilling, riveting, caulking, and tubing require the labours of several groups of machine attendants, and of gangs of unskilled labourers or helpers. Some operations also have to be done at a red or white heat, others cold. To the first belong flanging and welding, to the latter generally all the other operations. Heating is necessary for the rolling of tubes of small diameter; bending is done cold or hot according to circumstances.

The fact that some kinds of treatment, as shearing and punching, flanging and bending, are of a very violent character explains why practice has changed radically in regard to the method of performing these operations in cases where safety is a cardinal matter. Shearing and punching are both severely destructive operations performed on cold metal; both leave jagged edges and, as experience has proved, very minute cracks, the tendency of which is to extend under subse-

ing holes in adjacent plates, by which violent treatment the holes were forcibly drawn into alignment. This drifting stressed the plates, setting up permanent strains and enlarging incipient cracks, and many boiler explosions have been clearly traceable to the abuse of this tool. Then, next, specifications insisted that all holes should be enlarged by reaming *after* the plates were in place. But even that did not prove a safeguard, because it often happened that the metal reamed was nearly all removed from one side of a hole, so leaving the other side just as the punch had torn it. Ultimately came the era of drilling rivet-holes, to which there is no exception now in high-class boiler work. For average girder and bridge work the practice of punching and reaming is still in use, because the conditions of service are not so severe as are those in steam boilers.

Flanging signifies the turning or bending over of the edges of a

plate to afford a means of union to other plates. Examples occur in the back-end-plates of Lancashire and Cornish boilers, the front and back plates of marine boilers, the fire-boxes of locomotive boilers, the crowns of vertical boilers, the ends of conical cross-tubes, and the Adamson seams of furnace flues. This practice has superseded the older system of effecting union by means of rings forming two sides of a rectangular section (angle iron rings). These were a fruitful source of grooving and explosions in steam boilers, because their sharp angular form lacked elasticity; hence the reason for the substitution of a flange turned with a large radius, which afforded the elasticity necessary to counteract the effects of changes in temperature. In girder work where such conditions do not exist, the method of union with angles is of course retained. In the early days of flanging the process was performed in detail by a skilled workman (the angle ironsmith), and it is still so done in small establishments. A length of edge of about 10 in. or a foot is heated, and bent by hammering around the edge of a block of iron of suitable shape. Then another "heat" is taken and flanged, and so on, until the work is complete. But in modern boiler shops little hand work is ever done; instead, plates 4 ft., 6 ft., or 8 ft. in diameter, and fire-box plates for locomotive boilers, have their entire flanges bent at a single squeeze between massive dies in a hydraulic press. In the case of the ends of marine boilers which are too large for such treatment, a special form of press bends the edges over in successive heats. The flanges of Adamson seams are rolled over in a special machine. A length of flue is rotated on a table, while the flange is turned over within a minute between revolving rollers. There is another advantage in the adoption of machine-flanging, besides the enormous saving of time, namely, that the material suffers far less injury than it does in hand-flanging.

These differences in practice would not have assumed such magnitude but for the introduction of mild steel in place of malleable iron. Iron suffers less from overheating and irregular heating than does steel. Steel possesses higher ductility, but it is also more liable to develop cracks if subjected to improper treatment. All this and much more is writ large in the early testing of steel, and is reflected in present-day practice.

A feature peculiar to the boiler and plating shops is the enormous number of rivet holes which have to be made, and of rivets to be inserted. These requirements are reflected in machine design. To punch or drill holes singly is too slow a process in the best practice, and so machines are made for producing many holes simultaneously. Brades thus, the different sections of boilers are drilled in machines of different types, some for shells, some for furnaces, some peculiar to the shells or furnaces of one type of boilers, others to those of another type only. And generally now these machines not only drill, but can also be adjusted to drill to exact pitch, the necessity thus being avoided of marking out the holes as guides to the drills.

Hand-riveting has mostly been displaced by hydraulic and pneumatic machines, with resulting great saving in cost, and the advantage of more trustworthy and uniform results. For boiler work, machines are mostly of fixed type; for bridge and girder work they are portable, being slung from chains and provided with pressure water or compressed air by systems of flexible pipes.

Welding fills a large place in boiler work, but it is that of the edges of plates chiefly, predominating over that of the bars and rods of the smithy. The edges to be united are thin and long, so that short lengths have to be done in succession at successive "heats." Much of this is hand work, and "gluts" or insertion pieces are generally preferred to overlapping joints. But in large shops, steam-driven power hammers are used for closing the welds. Parts that are commonly welded are the furnace flues, the conical cross-tubes and angle rings.

Another aspect of the work of these departments is the immense proportions of the modern machine tools used. This development is due in great degree to the substitution of steel for iron. The steel shell-plates of the largest boilers are $1\frac{1}{2}$ in. thick, and these have to be bent into cylindrical forms. In the old days of iron boilers the capacity of rolls never exceeded about $\frac{1}{2}$ in. plate. Often, alternatively to rolling, these thick plates are bent by squeezing them in successive sections between huge blocks operated by hydraulic pressure acting on toggle levers. And other machines besides the rolls are made more massive than formerly to deal with the immense plates of modern marine boilers.

The boiler and plating shops have been affected by the general tendency to specialize manufactures. Firms have fallen into the practice of restricting their range of product, with increase in volume. The time has gone past when a single shop could turn out several classes of boilers, and undertake any bridge and girder work as well. One reason is to be found in the diminution of hand work and the growth of the machine tool. Almost every distinct operation on every section of a boiler or bridge may now be accomplished by one of several highly specialized machines. Repetitive operations are provided for them, and by a system of templating. If twenty or fifty similar boilers are made in a year, each plate, hole, flange or stay will be exactly like every similar one in the set. Dimensions of plates will be marked from a sample or templet plate, and holes will be marked similarly; or in many cases they are not marked at all, but pitched and drilled at once by self-acting mechanism embodied in drilling machines specially designed for one set of

operations on one kind of plate. Hundreds of bracing bars for bridges and girders will be cut off all alike, and drilled or punched from a templet bar, so that they are ready to take their place in bridge or girder without any adjustments or fitting. (J. G. H.)

BOILING TO DEATH, a punishment once common both in England and on the continent. The only extant legislative notice of it in England occurs in an act passed in 1531 during the reign of Henry VIII, providing that convicted poisoners should be boiled to death; it is, however, frequently mentioned earlier as a punishment for coining. The *Chronicles of the Grey Friars* (published by the Camden Society, 1852) have an account of boiling for poisoning at Smithfield in the year 1522, the man being fastened to a chain and lowered into boiling water several times until he died. The preamble of the statute of Henry VIII. (which made poisoning treason) in 1531 recites that one Richard Roose (or Coke), a cook, by putting poison in some food intended for the household of the bishop of Rochester and for the poor of the parish of Lambeth, killed a man and woman. He was found guilty of treason and sentenced to be boiled to death without benefit of clergy. He was publicly boiled at Smithfield. In the same year a maid-servant for poisoning her mistress was boiled at King's Lynn. In 1542 Margaret Davy, a servant, for poisoning her employer, was boiled at Smithfield. In the reign of Edward VI., in 1547, the act was repealed.

See also W. Andrews, *Old Time Punishments* (Hull, 1890); *Notes and Queries*, vol. i. (1862), vol. ix. (1867); Du Cange (s.v. *Caldaris decoquere*).

BOIS BRÛLÉS, or **BRÛLÉS** (a French translation of their Indian name SICHANGU), a sub-tribe of North American Dakota Indians (Teton river division). The name is most frequently associated with the half-breeds in Manitoba, who in 1869 came into temporary prominence in connexion with Riel's Rebellion (see RED RIVER); at that time they had lost all tribal purity, and were alternatively called *Métis* (half-castes); the majority being descendants of French-Canadians.

BOISÉ, a city and the county-seat of Ada county, Idaho, U.S.A., and the capital of the state, situated on the N. side of the Boise river, in the S.W. part of the state, at an altitude of about 2700 ft. Pop. (1880) 1890; (1900) 5957; (1910) 17,358. It is served by the Oregon Short Line railway, being the terminus of a branch connecting with the main line at Nampa, about 20 m. W.; and by electric lines connecting with Caldwell and Nampa. The principal buildings are the state capitol, the United States assay office; a Carnegie library, a natatorium, and the Federal building, containing the post office, the United States circuit and district court rooms, and a U.S. land office. Boisé is the seat of the state school for the deaf and blind (1906), and just outside the city limits are the state soldiers' home and the state penitentiary. About 2 m. from the city are Federal barracks. Hot water (175° F.) from artesian wells near the city is utilized for the natatorium and to heat many residences and public buildings. The Boisé valley is an excellent country for raising apples, prunes and other fruits. The manufactured products of the city are such as are demanded by a mining country, principally lumber, flour and machine-shop products. Boisé is the trade centre of the surrounding fruit-growing, agricultural and mining country, and is an important wool market. The oldest settlement in the vicinity was made by the Hudson's Bay Fur Company on the west side of the Boise river, before 1860; the present city, chartered in 1864, dates from 1863. After 1900 the city grew very rapidly, principally owing to the great irrigation schemes in southern Idaho; the water for the immense Boisé-Payette irrigation system is taken from the Boise, 8 m. above the city. (See IDAHO.)

BOISGOBEY, FORTUNÉ DU (1824-1891), French writer of fiction, whose real surname was Castille, was born at Granville (Manche) on the 11th of September 1824. He served in the army pay department in Algeria from 1844 to 1848, and extended his travels to the East. He made his literary début in the *Petit Journal* with a story entitled *Deux comédiens* (1868). With *Le Forçat colonel* (1872) he became one of the most popular feuilleton writers. His police stories, though not so convincing

as those of Émile Gaboriau, with whom his name is generally associated, had a great circulation, and many of them have been translated into English. Among his stories may be mentioned: *Les Mystères du nouveau Paris* (1876), *Le Demi-Monde sous la Terreur* (1877), *Les Nuits de Constantinople* (1882), *La Cri du sang* (1885), *La Main froide* (1889). Boisgobey died on the 26th of February 1891.

BOISGUILBERT, PIERRE LE PESANT, SIEUR DE (1676-1714), French economist, was born at Rouen of an ancient noble family of Normandy, allied to that of Corneille. He received his classical education in Rouen, entered the magistracy and became judge at Montivilliers, near Havre. In 1690 he became president of the *bailliage* of Rouen, a post which he retained almost until his death, leaving it to his son. In these two situations he made a close study of local economic conditions, personally supervising the cultivation of his lands, and entering into relations with the principal merchants of Rouen. He was thus led to consider the misery of the people under the burden of taxation. In 1695 he published his principal work, *Le Détail de la France, la cause de la diminution de ses biens, et la facilité du remède*. . . . In it he drew a picture of the general ruin of all classes of Frenchmen, caused by the bad economic régime. In opposition to Colbert's views he held that the wealth of a country consists, not in the abundance of money which it possesses but in what it produces and exchanges. The remedy for the evils of the time was not so much the reduction as the equalization of the imposts, which would allow the poor to consume more, raise the production and add to the general wealth. He demanded the reform of the *taille*, the suppression of internal customs duties and greater freedom of trade. In his *Faculum de la France*, published in 1705 or 1706, he gave a more concise résumé of his ideas. But his proposal to substitute for all aides and customs duties a single capitation tax of a tenth of the revenue of all property was naturally opposed by the farmers of taxes and found little support. Indeed his work, written in a diffuse and inelegant style, passed almost unnoticed. Saint Simon relates that he once asked a hearing of the comte de Pontchartrain, saying that he would at first believe him mad, then become interested, and then see he was right. Pontchartrain bluntly told him that he did think him mad, and turned his back on him. With Michel de Chamillart, whom he had known as intendant of Rouen (1689-1690), he had no better success. Upon the disgrace of Vauban, whose *Dîme royale* had much in common with Boisguilbert's plan, Boisguilbert violently attacked the controller in a pamphlet, *Supplément au détail de la France*. The book was seized and condemned, and its author exiled to Auvergne, though soon allowed to return. At last in 1710 the controller-general, Nicolas Desmarests, established a new impost, the "tenth" (*dixième*), which had some analogy with the project of Boisguilbert. Instead of replacing the former imposts, however, Desmarests simply added his *dixième* to them; the experiment was naturally disastrous, and the idea was abandoned.

In 1712 appeared a *Testament politique de M. de Vauban*, which is simply Boisguilbert's *Détail de la France*. Vauban's *Dîme royale* was formerly wrongly attributed to him. Boisguilbert's works were collected by Daire in the first volume of the *Collection des grands économistes*. His letters are in the *Correspondance des contributeurs généraux*, vol. ii., published by M. de Boislisle.

BOISROBERT, FRANÇOIS LE METEL DE (1592-1662), French poet, was born at Caen in 1592. He was trained for the law, and practised for some time at the bar at Rouen. About 1622 he went to Paris, and by the next year had established a footing at court, for he had a share in the ballet of the *Bacchanales* performed at the Louvre in February. He accompanied an embassy to England in 1625, and in 1630 visited Rome, where he won the favour of Urban VIII. by his wit. He took orders, and was made a canon of Rouen. He had been introduced to Richelieu in 1623, and by his humour and his talent as a raconteur soon made himself indispensable to the cardinal. Boisrobert became one of the five poets who carried out Richelieu's dramatic ideas. He had a passion for play, and was a friend of Ninon de l'Enclos; and his enemies found ready weapons against him

in the undisguised looseness of his life. He was more than once disgraced, but never for long, although in his later years he was compelled to give more attention to his duties as a priest. It was Boisrobert who suggested to Richelieu the plan of the Academy, and he was one of its earliest and most active members. Rich as he was through the benefices conferred on him by his patron, he was liberal to men of letters. After the death of Richelieu, he attached himself to Mazarin, whom he served faithfully throughout the Fronde. He died on the 30th of March 1662. He wrote a number of comedies, to one of which, *La Belle Plaideuse*, Molière's *L'Avare* is said to owe something; and also some volumes of verse. The licentious *Contes*, published under the name of his brother D'Ouville, are often attributed to him.

BOISSARD, JEAN JACQUES (1528-1602), French antiquary and Latin poet, was born at Besançon. He studied at Louvain; but, disgusted by the severity of his master, he secretly left that seminary, and after traversing a great part of Germany reached Italy, where he remained several years and was often reduced to great straits. His residence in Italy developed in his mind a taste for antiquities, and he soon formed a collection of the most curious monuments from Rome and its vicinity. He then visited the islands of the Archipelago, with the intention of travelling through Greece, but a severe illness obliged him to return to Rome. Here he resumed his favourite pursuits with great ardour, and having completed his collection, returned to his native country; but not being permitted to profess publicly the Protestant religion, which he had embraced some time before, he withdrew to Metz, where he died on the 30th of October 1602. His most important works are: *Poemata* (1574); *Emblemata* (1584); *Icones Virorum Illustrum* (1597); *Vitae et Icones Sultanorum Turcicorum*, &c. (1597); *Theatrum Vitae Humanae* (1596); *Romanae Urbis Topographia* (1597-1602), now very rare; *De Divinatione et Magicis Praestigis* (1605); *Habitus Variarum Orbis Gentium* (1582), ornamented with seventy illuminated figures.

BOISSIER, MARIE LOUIS ANTOINE GASTON (1823-1908), French classical scholar, and secretary of the French Academy, was born at Nîmes on the 15th of August 1823. The Roman monuments of his native town very early attracted Gaston Boissier to the study of ancient history. He made epigraphy his particular theme, and at the age of twenty-three became a professor of rhetoric at Angoulême, where he lived and worked for ten years without further ambition. A travelling inspector of the university, however, happened to hear him lecture, and Boissier was called to Paris to be professor at the Lycée Charlemagne. He began his literary career by a thesis on the poet Attius (1857) and a study on the life and work of M. Terentius Varro (1861). In 1861 he was made professor of Latin oratory at the Collège de France, and he became an active contributor to the *Revue des deux mondes*. In 1865 he published *Cicéron et ses amis* (Eng. trans. by A. D. Jones, 1897), which has enjoyed a success such as rarely falls to the lot of a work of erudition. In studying the manners of ancient Rome, Boissier had learned to re-create its society and to reproduce its characteristics with exquisite vivacity. In 1874 he published *La Religion romaine d'Auguste aux Antonins* (2 vols.), in which he analysed the great religious movement of antiquity that preceded the acceptance of Christianity. In *L'Opposition sous les Césars* (1875) he drew a remarkable picture of the political decadence of Rome under the early successors of Augustus. By this time Boissier had drawn to himself the universal respect of scholars and men of letters, and on the death of H. J. G. Patin, the author of *Études sur les tragiques grecs*, in 1876, he was elected a member of the French Academy, of which he was appointed perpetual secretary in 1895.

His later works include *Promenades archéologiques: Rome et Pompéi* (1880; second series, 1886); *L'Afrique romaine, promenades archéologiques* (1901); *La Fin du paganisme* (2 vols., 1897); *Le Conjurateur de Catilina* (1905); *Tacite* (1903, Eng. trans. by W. G. Hutchison, 1906). He was a representative example of the French talent for lucidity and elegance applied

with entire seriousness to weighty matters of literature. Though he devoted himself mainly to his great theme, the reconstruction of the elements of Roman society, he also wrote monographs on *Madame de Sévigné* (1887) and *Saint-Simon* (1892). He died in June 1908.

BOISSONADE DE FONTARABIE, JEAN FRANÇOIS (1774-1857), French classical scholar, was born at Paris on the 12th of August 1774. In 1792 he entered the public service during the administration of General Dumouriez. Driven from it in 1795, he was restored by Lucien Bonaparte, during whose time of office he served as secretary to the prefecture of the Upper Marne. He then definitely resigned public employment and devoted himself to the study of Greek. In 1809 he was appointed deputy professor of Greek at the faculty of letters at Paris, and titular professor in 1813 on the death of P. H. Larcher. In 1828 he succeeded J. B. Gail in the chair of Greek at the Collège de France. He also held the offices of librarian of the Bibliothèque du Roi, and of perpetual secretary of the Académie des Inscriptions. He died on the 8th of September 1857. Boissonade chiefly devoted his attention to late Greek literature: Philostratus, *Heracles* (1806) and *Epistolae* (1842); Marius, *Vita Jacchi* (1814); Tiberius Rhetor, *De Figuris* (1815); Nicetas Eugenianus, *Drosilla et Charicles* (1819); Herodian, *Partitiones* (1819); Aristænetus, *Epistolae* (1822); Eunapius, *Vitae Sophistarum* (1822); Babrius, *Fables* (1844); Tzetzes, *Allegorice Iliades* (1851); and a *Collection of Greek Poets* in 24 vols. The *Anecdota Graeca* (1829-1833) and *Anecdota Nova* (1844) are important for Byzantine history and the Greek grammarians.

A selection of his papers was published by F. Colinaucq, *Critique littéraire sous le premier Empire* (1863), vol. i. of which contains a complete list of his works, and a "Notice Historique sur Monsieur B.," by Naudet.

BOISSY D'ANGLAS, FRANÇOIS ANTOINE DE (1756-1828), French statesman, received a careful education and busied himself at first with literature. He had been a member of several provincial academies before coming to Paris, where he purchased a position as advocate to the parlement. In 1789 he was elected by the third estate of the *sénéchaussée* of Annonay as deputy to the states-general. He was one of those who induced the states-general to proclaim itself a National Assembly on the 17th of June 1789; approved, in several speeches, of the capture of the Bastille and of the taking of the royal family to Paris (October 1789); demanded that strict measures be taken against the royalists who were intriguing in the south of France, and published some pamphlets on finance. During the Legislative Assembly he was *procureur-syndic* for the directory of the department of Ardeche. Elected to the Convention, he sat in the centre, "*le Marais*," voting in the trial of Louis XVI. for his detention until deportation should be judged expedient for the state. He was then sent on a mission to Lyons to investigate the frauds in connexion with the supplies of the army of the Alps. During the Terror he was one of those deputies of the centre who supported Robespierre; but he was gained over by the members of the Mountain hostile to Robespierre, and his support, along with that of some other leaders of the *Marais*, made possible the 9th Thermidor. He was then elected a member of the Committee of Public Safety and charged with the superintendence of the provisioning of Paris. He presented the report supporting the decree of the 3rd Ventose of the year III. which established liberty of worship. In the critical days of Germinal and of Prairial of the year III. he showed great courage. On the 12th Germinal he was in the tribune, reading a report on the food supplies, when the hall of the Convention was invaded by the rioters, and when they withdrew he quietly continued where he had been interrupted. On the 1st Prairial he presided over the Convention, and remained unmoved by the insults and menaces of the insurgents. When the head of the deputy, Jean Féraud, was presented to him on the end of a pike, he saluted it impassively. He was reporter of the committee which drew up the constitution of the year III., and his report shows keen apprehension of a return of the Reign of Terror, and presents reactionary measures as precautions against the re-establishment of "tyranny

and anarchy." This report, the proposal that he made (August 27, 1795) to lessen the severity of the revolutionary laws, and the eulogies he received from several Paris sections suspected of disloyalty to the republic, resulted in his being obliged to justify himself (October 15, 1795). As a member of the Council of the Five Hundred he became more and more suspected of royalism. He presented a measure in favour of full liberty for the press, which at that time was almost unanimously reactionary, protested against the outlawry of returned *émigrés*, spoke in favour of the deported priests and attacked the Directory. Accordingly he was proscribed on the 18th Fructidor, and lived in England until the Consulate. In 1801 he was made a member of the Tribunate, and in 1805 a senator. In 1814 he voted for Napoleon's abdication, which won for him a seat in the chamber of peers; but during the Hundred Days he served Napoleon, and in consequence, on the second Restoration, was for a short while excluded. In the chamber he still sought to obtain liberty for the press—a theme upon which he published a volume of his speeches (Paris, 1817). He was a member of the Institute from its foundation, and in 1816, at the reorganization, became a member of the Académie des Inscriptions et Belles-Lettres. He published in 1819-1821 a two-volume *Essai sur la vie et les opinions de M. de Malesherbes*.

See F. A. Aulard, *Les Orateurs de la Révolution* (2nd ed., 1906); L. Sciout, *Le Directoire* (4 vols., 1895); and the "Notice sur la vie et les œuvres de M. Boissy d'Anglas" in the *Mémoires de l'Académie des Inscriptions*, ix. (R. A. V.)

BOITO, ARRIGO (1842-), Italian poet and musical composer, was born at Padua on the 24th of February 1842. He studied music at the Milan Conservatoire, but even in those early days he devoted as much of his time to literature as to music, forecasting the divided allegiance which was to be the chief characteristic of his life's history. While at the Conservatoire he wrote and composed, in collaboration with Franco Faccio, a cantata, *Le Sorelle d'Italia*, which was performed with success. On completing his studies Boito travelled for some years, and after his return to Italy settled down in Milan, dividing his time between journalism and music. In 1866 he fought under Garibaldi, and in 1868 conducted the first performance of his opera *Mefistofele* at the Scala theatre, Milan. The work failed completely, and was withdrawn after a second performance. It was revived in 1875 at Bologna in a much altered and abbreviated form, when its success was beyond question. It was performed in London in 1880 with success, but in spite of frequent revivals has never succeeded in firmly establishing itself in popular favour. Boito treated the Faust legend in a spirit far more nearly akin to the conception of Goethe than is found in Gounod's *Faust*, but, in spite of many isolated beauties, his opera lacks cohesion and dramatic interest. His energies were afterwards chiefly devoted to the composition of libretti, of which the principal are *Otello* and *Falstaff*, set to music by Verdi; *La Gioconda*, set by Ponchielli; *Amléo*, set by Faccio; and *Ero e Leandro*, set by Bottesini and Mancinelli. These works display a rare knowledge of the requirements of dramatic poetry, together with uncommon literary value. Boito also published a book of poems and a novel, *L'Alfieri Meno*. The degree of doctor of music was conferred upon him in 1893 by the university of Cambridge.

BOIVIN, FRANÇOIS DE, Baron de Villars (d. 1618), French chronicler, entered the service of Charles, Marshal Brissac, as secretary, and accompanied him to Piedmont in 1550 when the marshal went to take command of the French troops in the war with Spain. Remaining in this service he was sent after the defeat of the French at St Quentin in 1557 to assure the French king Henry II. of the support of Brissac. He took part in the negotiations which led to the treaty of Cateau-Cambrésis in April 1559, but was unable to prevent Henry II. from ceding the conquests made by Brissac. Boivin wrote *Mémoires sur les guerres démantées tant dans le Piémont qu'au Montserrat et duche de Milan par Charles de Cossé, comte de Brissac* (Paris, 1607), which, in spite of some drawbacks, is valuable as the testimony of an eye-witness of the war. An edition, carefully revised,

appears in the *Mémoires relatifs à l'histoire de France*, tome x., edited by J. F. Michaud and J. J. F. Poujoulat (Paris, 1850). He also wrote *Instruction sur les affaires d'État* (Lyons, 1610).

See J. Lelong, *Bibliothèque historique de la France* (Paris, 1768-1778).

BOKENAM, OSBERN (1393?-1447?), English author, was born, by his own account, on the 6th of October 1393. Dr Horstmann suggests that he may have been a native of Bokeham, now Bookham, in Surrey, and derived his name from the place. In a concluding note to his *Lives of the Saints* he is described as "a Suffolke man, frere Austyn of Stoke Clare." He travelled in Italy on at least two occasions, and in 1445 was a pilgrim to Santiago de Compostela. He wrote a series of thirteen legends of holy maidens and women. These are written chiefly in seven- and eight-lined stanzas, and nine of them are preceded by prologues. Bokenam was a follower of Chaucer and Lydgate, and doubtless had in mind Chaucer's *Legend of Good Women*. His chief, but by no means his only, source was the *Legenda Aurea* of Jacobus de Voragine, archbishop of Genoa, whom he cites as "Januence." The first of the legends, *Vita Scae Margaretae, virginis et martiris*, was written for his friend, Thomas Burgh, a Cambridge monk; others are dedicated to pious ladies who desired the history of their name-saints. The Arundel MS. 327 (British Museum) is a unique copy of Bokenam's work; it was finished, according to the concluding note, in 1447, and presented by the scribe, Thomas Burgh, to a convent unnamed "that the nuns may remember him and his sister, Dame Betrice Burgh." The poems were edited (1835) for the Roxburghe Club with the title *Lyrys of Seyntys* . . ., and by Dr Carl Horstmann as *Osbern Bokenams Legendens* (Heilbronn, 1883), in E. Këlbling's *Allengl. Bibliothek*, vol. i. Both editions include a dialogue written in Latin and English taken from Dugdale's *Monasticum Anglicanum* (ed. 1846, vol. vi. p. 1600); "this dialogue betwixt a Secular asking and a Frere answeringe at the grave of Dame Johan of Acres sheweth the lyncal descent of the lordis of the honoure of Clare fro . . . MCCXLVIII to . . . MCCCLVI" Bokenam wrote, as he tells us, plainly, in the Suffolk speech. He explains his lack of decoration on the plea that the finest flowers had been already plucked by Chaucer, Gower and Lydgate.

BOKHARA, or **BUKHARA** (the common central Asian pronunciation is Bukhārā), a state of central Asia, under the protection of Russia. It lies on the right bank of the middle Oxus, between 37° and 41° N., and between 62° and 72° E., and is bounded by the Russian governments of Syr-darya, Samarkand and Ferghana on the N., the Pamirs on the E., Afghanistan on the S., and the Transcaspiian territory and Khiva on the W. Its south-eastern frontier on the Pamirs is undetermined except where it touches the Russian dominions. Including the khanates of Karateghin and Darvaz the area is about 85,000 sq. m. The western portion of the state is a plain watered by the Zarafshan and by countless irrigation canals drawn from it. It has in the east the Karnap-chul steppe, covered with grass in early summer, and in the north an intrusion of the Kara-kum sand desert. Land suitable for cultivation is found only in oases, where it is watered by irrigation canals, but these oases are very fertile. The middle portion of the state is occupied by high plateaus, about 4000 ft. in altitude, sloping from the Tian-shan, and intersected by numerous rivers, flowing towards the Oxus. This region, very fertile in the valleys and enjoying a cooler and damper climate than the lower plains, is densely populated, and agriculture and cattle-breeding are carried on extensively. Here are the towns of Karshi, Kitab, Shaar, Chirakchi and Guzar or Huzar. The Hissar range, a westward continuation of the Alai Mountains, separates the Zarafshan from the tributaries of the Oxus—the Surkhan, Kafirnihan and Vakhsh. Its length is about 200 m., and its passes, 1000 to 3000 ft. below the surrounding peaks, reach altitudes of 12,000 to 14,000 ft. and are extremely difficult. Numbers of rivers pierce or flow in wild gorges between its spurs. Its southern foot-hills, covered with loess, make the fertile valleys of Hissar and the Vakhsh. The climate is so dry, and the rains are so scarce, that an absence of forests and Alpine

meadows is characteristic of the ridge; but when heavy rain falls simultaneously with the melting of the snows in the mountains, the watercourses become filled with furious torrents, which create great havoc. The main glaciers (12) are on the north slope, but none creeps below 10,000 to 12,000 ft. The Peter the Great range, or Periokh-tau, in Karateghin, south of the valley of the Vakhsh, runs west-south-west to east-north-east for about 130 m., and is higher than the Hissar range. From the meridian of Garm or Harm it rises above the snowline, attaining at least 18,000 ft. in the Sary-kaudal peak, and 20,000 ft. farther east where it joins the snow-clad Darvaz range, and where the group Sandal, adorned with several glaciers, rises to 24,000 or 25,000 ft. Only three passes, very difficult, are known across it.

Darvaz, a small vassal state of Bokhara, is situated on the Panj, where it makes its sharp bend westwards, and is emphatically a mountainous region, agriculture being possible only in the lower parts of the valleys. The population, about 35,000, consists chiefly of Moslem Tajiks, and the closely-related Galchas, and its chief town is Kala-i-khumb on the Panj, at an altitude of 4370 ft.

The chief river of Bokhara is the Oxus or Amu-darya, which separates it from Afghanistan on the south, and then flows along its south-west border. It is navigated from the mouth of the Surkhan, and steamboats ply on it up to Karki near the Afghan frontier. The next largest river, the Zarafshan, 660 m. long, the water of which is largely utilized for irrigation, is lost in the sands 20 m. before reaching the Oxus. The Kasha-darya, which flows westwards out of the glaciers of Hazret-sultan (west of the Hissar range), supplies the Shahri-sabs (properly Shaar-sabiz) oasis with water, but is lost in the desert to the west of Karshi.

The climate of Bokhara is extreme. In the lowlands a very hot summer is followed by a short but cold winter, during which a frost of -20° Fahr. may set in, and the Oxus may freeze for a fortnight. In the highlands this hot and dry summer is followed by four months of winter; and, finally, in the regions above 8000 ft. there is a great development of snowfields and glaciers, the passes are buried under snow, and the short summer is rainy. The lowlands are sometimes visited by terrible sand-storms from the west, which exhaust men and kill the cotton trees. Malaria is widely prevalent, and in some years, after a wet spring, assumes a malignant character.

The population is estimated at 1,250,000. The dominant race is the Uzbeqs, who are fanatical Moslem Sunnites, scorn work, despise their Iranian subjects, and maintain their old division into tribes or clans. The nomad Turkomans and the nomad Kirghiz are also of Turkish origin; while the Sarts, who constitute the bulk of the population in the towns, are a mixture of Turks with Iranians. The great bulk of the population in the country is composed of Iranian Tajiks, who differ but very little from Sarts. Besides these there are Afghans, Persians, Jews, Arabs and Armenians. Much of the trade is in the hands of a colony of Hindus from Shikarpur. Nearly 20% of the population are nomads and about 15% semi-nomads.

On the irrigated lowlands rice, wheat and other cereals are cultivated, and exported to the highlands. Cotton is widely grown and exported. Silk is largely produced, and tobacco, wine, flax, hemp and fruits are cultivated. Cattle-breeding is vigorously prosecuted in Hissar and the highlands generally. Cotton, silks, woollen cloth, and felt are manufactured, also boots, saddles, cutlery and weapons, pottery and various oils. Salt, as also some iron and copper, and small quantities of gold are extracted. Trade has been greatly promoted by the building of the Transcaspiian railway across the country (from Charjuj on the Oxus to Kati-kurgan) in 1886-1888. The exports to Russia consist of raw cotton and silk, lamb-skins, fruits and carpets, and the imports of manufactured goods and sugar. The imports from India are cottons, tea, shawls and indigo. There are very few roads; goods are transported on camels, or on horses and donkeys in the hilly tracts.

Bokhara has for ages been looked upon as the centre of Mussulman erudition in central Asia. About one-fourth of the

population is said to be able to read and write. The primary schools are numerous in the capital, as well as in the other cities, and even exist in villages, and *madrasas* or theological seminaries for higher courses of study are comparatively plentiful. The *madras* or priests enjoy very great influence, but the people are very superstitious, believing in witchcraft, omens, spirits and the evil eye. Women occupy a low position in the social scale, though slavery has been abolished at the instance of Russia. The emir of Bokhara is an autocratic ruler, his power being limited only by the traditional custom (*shariat*) of the Mussulmans. He maintains an army of some 11,000 men, but is subject to Russian control, being in fact a vassal of that empire.

History.—Bokhara was known to the ancients under the name of Sogdiana. It was too far removed to the east ever to be brought under the dominion of Rome, but it has shared deeply in all the various and bloody revolutions of Asia. The foundation of the capital is ascribed to Efrafiab, the great Persian hero. After the conquests of Alexander the Great Sogdiana formed part of the empire of the Seleucidae, and shared the fortunes of the rather better-known Bactria. Somewhat later the nomad Yue-chi began to move into the valley of the Oxus from the east, and gradually became a settled territorial power in Bactria and Sogdiana, and the dominions of their king, Kadphises I. (who is believed to have come to the throne about A.D. 45), extended from Bokhara to the Indus. The district, however, was reconquered by Persia under the Sassanian dynasty, and we hear of Nestorian Christians at Samarkand, at any rate in the 6th century. Islam was introduced shortly after the Arab conquest of Persia (640-642) and speedily became the dominant faith. In the early centuries of Mahomedan rule Sogdiana was one of the most celebrated and flourishing districts of central Asia. It was called Sughd, and contained the two great cities of Samarkand and Bokhara, of which the former was generally the seat of government, while the latter had a high reputation as a seat of religion and learning. During the early middle ages this region was also known as Ma wara 'l Nahr or Ma-vera-un-nahr, the meaning of which is given in the alternative classical title of Transoxiana. Malik Shah, third of the Seljuk dynasty of Persia, passed the Oxus about the end of the 11th century, and subdued the whole country watered by that river and the Jaxartes. In 1216 Bokhara was again subdued by Mahomed Shah Khwarizm, but his conquest was wrested from him by Jenghis Khan in 1220. The country was wasted by the fury of this savage conqueror, but recovered something of its former prosperity under Ogdai Khan, his son, whose disposition was humane and benevolent. His posterity kept possession till 1369, when Timur or Tamerlane bore down everything before him, and established his capital at Samarkand, which with Bokhara remained for a time its former splendour. Babar, the fifth in descent from Timur, was originally prince of Ferghana, but conquered Samarkand and northern India, where he founded the Mogul (Mughal) empire. His descendants ruled in the country until about 1500, when it was overrun by the Uzbek Tatars, under Abulkhair or Ebulkhair Khan, the founder of the Shaibani dynasty, with which the history of Bokhara properly commences. The most remarkable representative of this family was Abdullah Khan (1556-1598), who greatly extended the limits of his kingdom by the conquest of Badakshan, Herat and Meshhed, and increased its prosperity by the public works which he authorized. Before the close of the century, however, the dynasty was extinct, and Bokhara was at once desolated by a Kirghiz invasion and distracted by a disputed succession. At length, in 1598, Baki Mehemet Khan, of the Astrakhan branch of the Timur family, mounted the throne, and thus introduced the dynasty of the Ashtarkhanides. The principal event of his reign was the defeat he inflicted on Shah Abbas of Persia in the neighbourhood of Balkh. His brother Vali Mehemet, who succeeded in 1605, soon alienated his subjects, and was supplanted by his nephew Imamkuli. After a highly prosperous reign this prince resigned in favour of his brother, Nazr Mehemet, under whom the country was greatly troubled by the rebellion of his sons, who continued to quarrel with each

other after their father's death. Meanwhile the district of Khiva, previously subject to Bokhara, was made an independent khanate by Abdul-Gazi Bahadur Khan; and in the reign of Subhankuli, who ascended the throne in 1680, the political power of Bokhara was still further lessened, though it continued to enjoy the unbounded respect of the Sunnite Mahomedans. Subhankuli died in 1702, and a war of succession broke out between his two sons, who were supported by the rivalry of two Uzbek tribes. After five years the contest terminated in favour of Obeidullah, who was little better than a puppet in the hands of Rehim Bi Atalik, his vizier. The invasion of Nadir Shah of Persia came to complete the degradation of the land; and in 1740 the feeble king, Abu 'l-Faiz, paid homage to the conqueror, and was soon after murdered and supplanted by his vizier. The time of the Ashtarkhanides had been for the most part a time of dissolution and decay; fanaticism and imbecility went hand in hand. On its fall (1785) the throne was seized by the Manghit family in the person of Mir Ma'sum, who pretended to the most extravagant sanctity, and proved by his military career that he had no small amount of ability. He turned his attention to the encroachments of the Afghans, and in 1781 reconquered the greater part of what had been lost to the south of the Oxus. Dying in 1802 he was succeeded by Sald, who in bigotry and fanaticism was a true son of his father. In 1806 Nasrullah mounted the throne, and began with the murder of his brother a reign of continued oppression and cruelty. Meanwhile Bokhara became an object of rivalry to Russia and England, and envoys were sent by both nations to cultivate the favour of the emir, who treated the Russians with arrogance and the English with contempt. Two emissaries of the British government, Colonel C. Stoddart and Captain A. Conolly, were thrown by Nasrullah into prison, where they were put to death in 1842. In 1862-1864 Arminius Vambéry made in the disguise of a dervish a memorable journey through this fanatical state. At this time the Russian armies were gradually advancing, and at last they appeared in Khokand; but the new emir, Mozaffer-eddin, instead of attempting to expiate the insults of his predecessor, sent a letter to General M. G. Chernayev summoning him to evacuate the country, and threatening to raise all the faithful against him. In 1866 the Russians invaded the territory of Bokhara proper, and a decisive battle was fought on the 20th of May at Irdjar on the left bank of the Jaxartes. The Bokharians were defeated; but after a period of reluctant peace they forced the emir to renew the war. In 1868 the Russians entered Samarkand (May 14), and the emir was constrained to submit to the terms of the conqueror, becoming henceforward only a Russian puppet.

See Khanikov's *Bokhara*, translated by De Bode (1845); Vambéry, *Travels in Central Asia* (1864); *Sketches of Central Asia* (1868), and *History of Bokhara* (1873); Fedchenko's "Sketch of the Zarafshan Valley" in *Journ. R. Geogr. Soc.* (1870); Hellwald, *Die Russen in Central Asien* (1873); Lipsky, *Upper Bokhara*, in Russian (1902); Skrine and Ross, *The Heart of Asia* (1899); Lord Ronaldshay, *Outskirts of Empire in Asia* (1904); and Le Strange, *The Lands of the Eastern Caliphate* (1905). (P. A. K.; C. E.)

BOKHARA (*Bokhara-i-Sherif*), capital of the state of Bokhara, on the left bank of the Zarafshan, and on the irrigation canal of Shahri-rud, situated in a fertile plain. It is 8 m. from the Bokhara station of the Transcaspian railway, 162 m. by rail W. of Samarkand, in 39° 47' N. lat. and 64° 27' E. long. The city is surrounded by a stone wall 28 ft. high and 8 m. long, with semicircular towers and eleven gates of little value as a defence. The present city was begun in A.D. 830 on the site of an older city, was destroyed by Jenghis Khan in 1220, and rebuilt subsequently. The water-supply is very unhealthy. The city has no less than 360 mosques. Nearly 10,000 pupils are said to receive their education in its 140 *madrasas* or theological colleges; primary schools are kept at most mosques. Some of these buildings exhibit very fine architecture. The most notable of the mosques is the Mir-Arab, built in the 16th century, with its beautiful lecture halls; the chief mosque of the emir is the Mejid-kalyan, or Kok-humbaz, close by which stands a brick minaret, 203 ft. high, from the top of which state criminals used to be thrown until 1871. Of the numerous squares the Raghistan

is the principal. It has on one side the citadel; erected on an artificially made eminence 45 ft. high, surrounded by a wall 1 m. long, and containing the palace of the emir, the houses of the chief functionaries, the prison and the water-cisterns. The houses are mostly one-storeyed, built of unburned bricks, and have flat roofs.

Bokhara has for ages been a centre of learning and religious life. The mysticism which took hold on Persia in the middle ages spread also to Bokhara, and later, when the Mongol invasions of the 13th century laid waste Samarkand and other Moslem cities, Bokhara, remaining independent, continued to be a chief seat of Islamic learning. The *madrasas* libraries, some of which were very rich, have been scattered and lost, or confiscated by the emirs, or have perished in conflagrations. But there are still treasures of literature concealed in private libraries, and Afghan, Persian, Armenian and Turkish bibliophiles still repair to Bokhara to buy rare books. Bokhara is, in fact, the principal book-market of central Asia. The population is supposed by Russian travellers not to exceed 50,000 or 60,000, but is otherwise estimated at 75,000 to 100,000. Amongst them is a large and ancient colony of Jews. Bokhara is the most important trading town in central Asia. In the city bazaars are made or sold silk stuffs, metal (especially copper) wares, Kara-kul (*i.e.* astrakhan) lamb-skins and carpets.

New Bokhara, or *Kagan*, a Russian town near the railway station, 8 m. from Bokhara itself, is rapidly growing, on a territory ceded by the emir. Pop. 2000. (P. A. K.)

BOKSBURG, a town of the Transvaal, 14 m. E. of Johannesburg by rail. Pop. of the municipality (1904) 14,757, of whom 4175 were whites. It is the headquarters of the Witwatersrand coal mining industry. The collieries extend from Boksburg eastward to Springs, 11 m. distant. Brakpan, the largest colliery in South Africa, lies midway between the places named.

BOLAN PASS, an important pass on the Baluch frontier, connecting Jacobabad and Sibi with Quetta, which has always occupied an important place in the history of British campaigns in Afghanistan. Since the treaty of Gandamak, which was signed at the close of the first phase of the Afghan War in 1879, the Bolan route has been brought directly under British control, and it was selected for the first alignment of the Sind-Pishin railway from the plains to the plateau. From Sibi the line runs south-west, skirting the hills to Rindli, and originally followed the course of the Bolan stream to its head on the plateau. The destructive action of floods, however, led to the abandonment of this alignment, and the railway now follows the Mashkaf valley (which debouches into the plains close to Sibi), and is carried from near the head of the Mashkaf to a junction with the Bolan at Mach. An alternative route from Sibi to Quetta was found in the Harnai valley to the N.E. of Sibi, the line starting in exactly the opposite direction to that of the Bolan and entering the hills at Nari. The Harnai route, although longer, is the one adopted for all ordinary traffic, the Bolan loop being reserved for emergencies. At the Khundilani gorge of the Bolan route conglomerate cliffs enclose the valley rising to a height of 800 ft., and at Sir-i-Bolan the passage between the limestone rocks hardly admits of three persons riding abreast. The temperature of the pass in summer is very high, whereas in winter, near its head, the cold is extreme, and the ice-cold wind rushing down the narrow outlet becomes destructive to life. Since 1877, when the Quetta agency was founded, the freedom of the pass from plundering bands of Baluch marauders (chiefly Marris) has been secured, and it is now as safe as any pass in Scotland. (T. H. H.)*

BOLAS (plural of Span. *bola*, ball), a South American Indian weapon of war and the chase, consisting of balls of stone attached to the ends of a rope of twisted or braided hide or hemp. Charles Darwin thus describes them in his *Voyage of the Beagle*: "The *bolas*, or balls, are of two kinds: the simplest, which is used chiefly for catching ostriches, consists of two round stones, covered with leather, and united by a thin, plaited thong, about 8 ft. long. The other kind differs only in having three balls united by thongs to a common centre. The Gaucho (native of

Spanish descent) holds the smallest of the three in his hand, and whirls the other two around his head; then, taking aim, sends them like chain shot revolving through the air. The balls no sooner strike any object, than, winding round it, they cross each other and become firmly hitched." *Bolas* have been used for centuries in the South American pampas and even the forest regions of the Rio Grande. F. Ratzel (*History of Mankind*) supposes them to be a form of lasso. The Eskimos use a somewhat similar weapon to kill birds. *Bolas perdidas* (*i.e.* lost) are stones attached to a very short thong, or, in some cases, having none at all.

BOLBEC, a town of northern France, in the department of Seine-Inférieure, on the Bolbec, 19 m. E.N.E. of Havre by rail. Pop. (1906) 10,959. Bolbec is important for its cotton spinning and weaving, and carries on the dyeing and printing of the fabric, and the manufacture of sugar. There are a chamber of commerce and a board of trade-arbitration. The town was enthusiastic in the cause of the Reformed Religion in the 16th century, and still contains many Protestants. It was burned almost to the ground in 1765.

BOLE (Gr. *βῶλος*, "a clod of earth"), a clay-like substance of red, brown or yellow colour, consisting essentially of hydrous aluminium silicate, with more or less iron. Most bole differs from ordinary clay in not being plastic, but in dropping to pieces when placed in water, thus behaving rather like fuller's-earth. Bole was formerly in great repute medicinally, the most famous kind being the Lemnian Earth (*γῆ Λήμνια*), from the Isle of Lemnos in the Greek Archipelago. The earth was dug with much ceremony only once a year, and having been mixed with goats' blood was made into little cakes or balls, which were stamped by the priests, whence they became known as *Terra sigillata* ("sealed earth"). Large quantities of bole occur as red partings between the successive lava flows of the Tertiary volcanic series in the north of Ireland and the west of Scotland. Here it seems to have resulted from the decomposition of the basalt and kindred rocks by meteoric agencies, during periods of volcanic repose. In Antrim the bole is associated with lithomarge, bauxite and pisolitic iron-ore. Bole occurs in like manner between the great sheets of the Deccan traps in India; and a similar substance is also found interbedded with some of the doleritic lavas of Etna.

In the sense of stem or trunk of a tree, "bole" is from the O. Norwegian *bolr*, cf. Ger. *Bohle*, plank. It is probably connected with the large number of words, such as "boll," "ball," "bowl," &c., which stand for a round object.

BOLESLAUS I., called "The Great," king of Poland (d. 1025), was the son of Mieszko, first Christian prince of Poland, and the Bohemian princess Dobrawa, or Bona, whose chaplain, Jordan, converted the court from paganism to Catholicism. He succeeded his father in 992. A born warrior, he speedily raised the little struggling Polish principality on the Vistula to the rank of a great power. In 996 he gained a seaboard by seizing Pomerania, and subsequently took advantage of the troubles in Bohemia to occupy Cracow, previously a Czech city. Like his contemporaries, Stephen of Hungary and Canute of Denmark, Boleslaus recognized from the first the essential superiority of Christianity over every other form of religion, and he deserves with them the name of "Great" because he deliberately associated himself with the new faith. Thus despite an inordinate love of adventure, which makes him appear rather a wandering chieftain than an established ruler, he was essentially a man of insight and progress. He showed great sagacity in receiving the fugitive Adalbert, bishop of Prague, and when the saint suffered martyrdom at the hands of the pagan Slavs (April 23, 997), Boleslaus purchased his relics and solemnly laid them in the church of Gnesen, founded by his father, which now became the metropolitan see of Poland. It was at Gnesen that Boleslaus in the year 1000 entertained Otto III. so magnificently that the emperor, declaring such a man too worthy to be merely *princeps*, conferred upon him the royal crown, though twenty-five years later, in the last year of his life, Boleslaus thought it necessary to crown himself king a second time. On the death of Otto, Boleslaus invaded Germany, penetrated to the Elbe, occupying Stralsund and

Meissen on his way, and extended his dominions to the Elster and the Saale. He also occupied Bohemia, till driven out by the emperor Henry IV. in 1004. The German war was terminated in 1018 by the peace of Bautzen, greatly to the advantage of Boleslaus, who retained Lusatia. He then turned his arms against Jaroslav, grand duke of Kiev, whom he routed on the banks of the Bug, then the boundary between Russia and Poland. For ten months Boleslaus remained at Kiev, whence he addressed triumphant letters to the emperors of the East and West. At his death in 1025 he left Poland one of the mightiest states of Europe, extending from the Bug to the Elbe, and from the Baltic to the Danube, and possessing besides the overlordship of Russia. But his greatest achievement was the establishment in Poland of a native church, the first step towards political independence.

See J. N. Pawlowski, *St Adalbert* (Danzig, 1860); *Chronica Nestoris* (Vienna, 1860); Heinrich R. von Zeissberg, *Die Kriege Kaiser Heinrichs II. mit Herzog Boleslaw I.* (Vienna, 1868).

BOLESLAUS II., called "The Bold," king of Poland (1039-1081), eldest son of Casimir I., succeeded his father in 1058. The domestic order and tranquillity of the kingdom had been restored by his painstaking father, but Poland had shrunk territorially since the age of his grandfather Boleslaus I., and it was the aim of Boleslaus II. to restore her dignity and importance. The nearest enemy was Bohemia, to whom Poland had lately been compelled to pay tribute for her oldest possession, Silesia. But Boleslaus's first Bohemian war proved unsuccessful, and was terminated by the marriage of his sister Swatawa with the Czech king Wratyslaus II. On the other hand Boleslaus's ally, the fugitive Magyar prince Bela, succeeded with Polish assistance in winning the crown of Hungary. In the East Boleslaus was more successful. In 1069 he succeeded in placing Izausla on the throne of Kiev, thereby confirming Poland's overlordship over Russia and enabling Boleslaus to chastise his other enemies, Bohemia among them, with the co-operation of his Russian auxiliaries. But Wratyslaus of Bohemia speedily appealed to the emperor for help, and a war between Poland and the Empire was only prevented by the sudden rupture of Henry IV. with the Holy See and the momentous events which led to the humiliating surrender of the emperor at Canossa. There is nothing to show that Boleslaus took any part in this struggle, though at this time he was on the best of terms with Gregory VII. and there was some talk of sending papal legates to restore order in the Polish Church. On the 26th of December 1076 Boleslaus encircled his own brows with the royal diadem, a striking proof that the Polish kings did not even yet consider their title quite secure. A second successful expedition to Kiev to reinstate his protégé Izausla, is Boleslaus's last recorded exploit. Almost immediately afterwards (1079) we find him an exile in Hungary, where he died about 1081. The cause of this sudden eclipse was the cruel vengeance he took on the *milites*, or noble order, who, emulating the example of their brethren in Bohemia, were already attempting to curb the royal power. The churchmen headed by Stanislaus Szczepanowski, bishop of Cracow, took the side of the nobles, whose grievances seem to have been real. Boleslaus in his fury slew the saintly bishop, but so general was the popular indignation that he had to fly his kingdom.

See M. Maksymilian Gumplowicz, *Zur Geschichte Polens im Mittelalter* (Innsbruck, 1898); W. P. Auzenstein, *Der Konflikt des polnischen Königs Boleslaw II. mit dem Bischof Stanislaus* (Thorn, 1895).

BOLESLAUS III., king of Poland (1086-1139), the son of Wladislaus I. and Judith of Bohemia, was born on the 23rd of December 1086 and succeeded his father in 1102. His earlier years were troubled continually by the intrigues of his natural half-brother Zbigniew, who till he was imprisoned and blinded involved Boleslaus in frequent contests with Bohemia and the emperor Henry V. The first of the German wars began in 1109, when Henry, materially assisted by the Bohemians, invaded Silesia. It was mainly a war of sieges, Henry sitting down before Lubusz, Glogau and Breslau, all of which he failed to take. The Poles avoided an encounter in the open field, but harried the Germans so successfully around Breslau that the plain was covered

with corpses, which Henry had to leave to the dogs on his disastrous retreat; hence the scene of the action was known as "the field of dogs." The chief political result of this disaster was the complete independence of Poland for the next quarter of a century. It was during this respite that Boleslaus devoted himself to the main business of his life—the subjugation of Pomerania (*i.e.* the maritime province) with the view of gaining access to the sea. Pomerania, protected on the south by virgin forests and almost impenetrable morasses, was in those days inhabited by a valiant and savage Slavonic race akin to the Wends, who clung to paganism with unconquerable obstinacy. The possession of a seaboard enabled them to maintain fleets and build relatively large towns such as Stettin and Kolberg, whilst they ravaged at will the territories of their southern neighbours the Poles. In self-defence Boleslaus was obliged to subdue them. The struggle began in 1109, when Boleslaus inflicted a terrible defeat on the Pomeranians at Nackel which compelled their temporary submission. In 1120-1124 the rebellion of his vassal Prince Warceclus of Stettin again brought Boleslaus into the country, but the resistance was as stout as ever, and only after 18,000 of his followers had fallen and 8000 more had been expatriated did Warceclus submit to his conqueror. The obstinacy of the resistance convinced Boleslaus that Pomerania must be christianized before it could be completely subdued; and this important work was partially accomplished by St Otto, bishop of Bamberg, an old friend of Boleslaus's father, who knew the Slavonic languages. In 1124 the southern portions of the land were converted by St Otto, but it was only under the threat of extermination if they persisted in their evil ways that the people of Stettin accepted the faith in the following year. In 1128, at the council of Usedom, St Otto appointed his disciple Boniface bishop of Julin, the first Pomeranian diocese, and the foundation of a better order of things was laid. In his later years Boleslaus waged an unsuccessful war with Hungary and Bohemia, and was forced to claim the mediation of the emperor Lothair, to whom he did homage for Pomerania and Rügen at the diet of Merseburg in 1135. He died in 1139.

See Gallus, *Chronicon*, ed. Finkal (Cracow, 1899); Maksymilian Gumplowicz, *Zur Geschichte Polens im Mittelalter* (Innsbruck, 1898).

BOLETUS, a well-marked genus of fungi (order *Polyporaceae*), characterized by the central stem, the cap or pileus, the soft, fleshy tissue, and the vertical, closely-packed tubes or pores which cover the under surface of the pileus and are easily detachable. The species all grow on the ground, in woods or under trees, in the early autumn. They are brown, red or yellow in colour; the pores also vary in colour from pure white to brown, red, yellow or green, and are from one or two lines to nearly an inch long. A few are poisonous; several are good for eating. One of the greatest favourites for the table is *Boletus edulis*, recognized by its brown cap and white pores which become green when old. It is the *cepis* of the continental European markets. There are forty-nine British species of *Boletus*.

BOLEYN (or **BULLEN**), ANNE (c. 1507-1536), queen of Henry VIII. of England, daughter of Sir Thomas Boleyn, afterwards earl of Wiltshire and Ormonde, and of Elizabeth, daughter of Thomas Howard, earl of Surrey, afterwards duke of Norfolk, was born, according to Camden, in 1507, but her birth has been ascribed, though not conclusively, to an earlier date (to 1502 or 1501) by some later writers.¹ In 1514 she accompanied Mary Tudor to France on the marriage of the princess to Louis XII., remained there after the king's death, and became one of the women in waiting to Queen Claude, wife of Francis I. She returned in 1521 or 1522 to England, where she had many admirers and suitors. Among the former was the poet Sir Thomas Wyatt,² and among the latter, Henry Percy, heir of the earl of Northumberland, a marriage with whom, however, was stopped by the king and another match provided for her in the

¹ See *Anno Boleyn*, by P. Friedman; *The Early Life of Anne Boleyn*, by J. H. Round; and J. Cairdner in *Eng. Hist. Review*, viii. 83, 299, and x. 104.

² According to the *Chronicle of King Henry VIII.*, tr. by M. A. S. Hume, p. 66, she was his mistress.

person of Sir James Butler. Anne Boleyn, however, remained unmarried, and a series of grants and favours bestowed by Henry on her father between 1522 and 1525 have been taken, though very doubtfully, as a symptom of the king's affections. Unlike her sister Mary, who had fallen a victim to Henry's solicitations,¹ Anne had no intention of being the king's mistress; she meant to be his queen, and her conduct seems to have been governed entirely by motives of ambition. The exact period of the beginning of Anne's relations with Henry is not known. They have been surmised as originating as early as 1523; but there is nothing to prove that Henry's passion was anterior to the proceedings taken for the divorce in May 1527, the celebrated love letters being undated. Her name is first openly connected with the king's as a possible wife in the event of Catherine's divorce, in a letter of Mendoza, the imperial ambassador, to Charles V. of the 16th of August 1527,² during the absence in France of Wolsey, who, not blinded by passion like Henry, naturally opposed the undesirable alliance, and was negotiating a marriage with Renée, daughter of Louis XII. Henry meanwhile, however, had sent William Knight, his secretary, on a separate mission to Rome to obtain facilities for his marriage with Anne; and on the cardinal's return in August he found her installed as the king's companion and proposed successor to Catherine of Aragon. After the king's final separation from his wife in July 1531, Anne's position was still more marked, and in 1532 she accompanied Henry on the visit to Francis I., while Catherine was left at home neglected and practically a prisoner. Soon after their return Anne was found to be pregnant, and in consequence Henry married her about the 25th of January 1533³ (the exact date is unknown), their union not being made public till the following Easter. Subsequently, on the 23rd of May, their marriage was declared valid and that with Catherine null, and in June Anne was crowned with great state in Westminster Abbey. Anne Boleyn had now reached the zenith of her hopes. A weak, giddy woman of no stability of character, her success turned her head and caused her to behave with insolence and impropriety, in strong contrast with Catherine's quiet dignity under her misfortunes. She, and not the king, probably was the author of the petty persecutions inflicted upon Catherine and upon the princess Mary, and her jealousy of the latter showed itself in spiteful malice. Mary was to be forced into the position of a humble attendant upon Anne's infant, and her ears were to be boxed if she proved recalcitrant. She urged that both should be brought to trial under the new statute of succession passed in 1534, which declared her own children the lawful heirs to the throne. She was reported as saying that when the king gave opportunity by leaving England, she would put Mary to death even if she were burnt or flayed alive for it.⁴ She incurred the remonstrances of the privy council and alienated her own friends and relations. Her uncle, the duke of Norfolk, whom she was reported to have treated "worse than a dog," reviled her, calling her a "grande putaine." But her day of triumph was destined to be even shorter than that of her predecessor. There were soon signs that Henry's affection, which had before been a genuine passion, had cooled or ceased. He resented her arrogance, and a few months after the marriage he gave her cause for jealousy, and disputes arose. A strange and mysterious fate had prepared for Anne the same domestic griefs that had vexed and ruined Catherine and caused her abandonment. In September 1533 the birth of a daughter, afterwards Queen Elizabeth, instead of the long-hoped-for son, was a heavy disappointment; next year

¹ Of this there is no direct proof, but the statement rests upon contemporary belief and chiefly upon the extraordinary terms of the dispensation granted to Henry to marry Anne Boleyn, which included the suspension of all canons relating to impediments created by "affinity rising *ex illicito coitu* in any degree even in the first." Froude rejects the whole story, *Divorce of Catherine of Aragon*, p. 54; and see Friedman's *Anne Boleyn*, ii. 323.

² *Cal. of St. Pap. England and Spain*, iii. pt. ii. p. 327.

³ According to Cranmer, *Letters and Papers of Henry VIII.* vi. p. 300, the only authority; and Cranmer himself only knew of it a fortnight after. The marriage was commonly antedated to the 14th of November 1532.

⁴ *Cal. of St. Pap. England and Spain*, v. 198.

there was a miscarriage, and on the 29th of January 1536, the day of Catherine's funeral, she gave birth to a dead male child.

On the 1st of May following the king suddenly broke up a tournament at Greenwich, leaving the company in bewilderment and consternation. The cause was soon known. Inquiries had been made on reports of the queen's ill-conduct, and several of her reputed lovers had been arrested. On the 2nd Anne herself was committed to the Tower on a charge of adultery with various persons, including her own brother, Lord Rochford. On the 12th Sir Francis Weston, Henry Norris, William Brereton and Mark Smeaton were declared guilty of high treason, while Anne herself and Lord Rochford were condemned unanimously by an assembly of twenty-six peers on the 15th. Her uncle, the duke of Norfolk, presided as lord steward, and gave sentence, weeping, that his niece was to be burned or beheaded as pleased the king. Her former lover, the earl of Northumberland, left the court seized with sudden illness. Her father, who was excused attendance, had, however, been present at the trial of the other offenders, and had there declared his conviction of his daughter's guilt. On the 16th, hoping probably to save herself by these means, she informed Cranmer of a certain supposed impediment to her marriage with the king—according to some accounts a previous marriage with Northumberland, though the latter solemnly and positively denied it—which was never disclosed, but which, having been considered by the archbishop and a committee of ecclesiastical lawyers, was pronounced, on the 17th, sufficient to invalidate her marriage. The same day all her reputed lovers were executed; and on the 19th she herself suffered death on Tower Green, her head being struck off with a sword by the executioner of Calais brought to England for the purpose.⁵ She had regarded the prospect of death with courage and almost with levity, laughing heartily as she put her hands about her "little neck" and recalled the skill of the executioner. "I have seen many men" (wrote Sir William Kingston, governor of the Tower) "and also women executed, and all they have been in great sorrow, and to my knowledge this lady has much joy and pleasure in death." On the following day Henry was betrothed to Jane Seymour.

Amidst the vituperations of the adherents of the papacy and the later Elizabethan eulogies, and in the absence of the records on which her sentence was pronounced, Anne Boleyn's guilt remains unproved. To Sir William Kingston she protested her entire innocence, and on the scaffold while expressing her submission she made no confession.⁶ Smeaton alone of her supposed lovers made a full confession, and it is possible that his statement was drawn from him by threats of torture or hopes of pardon. Norris, according to one account,⁷ also confessed, but subsequently declared that he had been betrayed into making his statement. The others were all said to have "confessed in a manner" on the scaffold, but much weight cannot be placed on these general confessions, which were, according to the custom of the time, a declaration of submission to the king's will and of general repentance rather than acknowledgment of the special crime "I pray God save the king," Anne herself is reported to have said on the scaffold, "and send him long to reign over you, for a gentler nor a more merciful prince was there never; and to me he was ever a good, a gentle and sovereign lord." A principal witness for the charge of incest was Rochford's own wife, a woman of infamous character, afterwards executed for complicity in the intrigues of Catherine Howard. The discovery of Anne's misdeeds coincided in an extraordinary manner with Henry's disappointment in not obtaining by her a male heir, while the king's despotic power and the universal unpopularity of Anne both tended to hinder the administration of pure justice. Nevertheless, though unproved, Anne's guilt is more than probable. It is almost incredible that two grand

⁵ *Letters and Papers of Henry VIII.* x. pp. 374, 381, 385.

⁶ According to the most trustworthy accounts, but see *Letters and Papers*, x. p. 382. The well-known letter to Henry VIII. attributed to her is now recognized as an Elizabethan forgery.

⁷ *Archæologia*, xxiii. 64.

juries, a petty jury, and a tribunal consisting of nearly all the lay peers of England, with the evidence before them which we do not now possess, should have all unanimously passed a sentence of guilt contrary to the facts and their convictions, and that such a sentence should have been supported by Anne's own father and uncle. Every year since her marriage Anne had given birth to a child, and Henry had no reason to despair of more; while, if Henry's state of health was such as was reported, the desire for children, which Anne shared with him, may be urged as an argument for her guilt. Sir Francis Weston in a letter to his family almost acknowledges his guilt in praying for pardon, especially for offences against his wife;¹ Anne's own conduct and character almost prepare us for some catastrophe. Whether innocent or guilty, however, her fate caused no regrets and her misfortunes did not raise a single champion or defender. The sordid incidents of her rise, and the insolence with which she used her triumph, had alienated all hearts from the unhappy woman. Among the people she had always been intensely disliked; the love of justice, and the fear of trade losses imminent upon a breach with Charles V., combined to render her unpopular. She appealed to the king's less refined instincts, and Henry's deterioration of character may be dated from his connexion with her. She is described as "not one of the handsomest women in the world; she is of a middling stature, swarthy complexion, long neck, wide mouth, bosom not much raised, and in fact has nothing but the English king's great appetite, and her eyes which are black and beautiful, and take great effect."² Cranmer admired her—"sitting in her hair" (*i.e.* with her hair falling over her shoulders, which seems to have been her custom on great occasions), "upon a horse litter, richly apparelled," at her coronation.³

BIBLIOGRAPHY.—Art. in the *Dict. of Nat. Biography* and authorities cited; *Henry VIII.* by A. F. Pollard (1905); *Anne Boleyn*, by P. Freeman (1884); *The Early Life of Anne Boleyn*, by J. L. Russell (1888); *The Divorce of Catherine of Aragon*, by J. A. Froude (1891); "Der Ursprung der Ehescheidung Heinrichs VIII.," and "Der Sturz des Cardinals Wolsey," by W. Busch (*Historisches Taschenbuch*, vi. Folge viii. 273 and ix. 41, 1889 and 1890); *Lives*, by Miss E. O. Benger (1821); and Miss A. Strickland, *Lives of the Queens of England* (1851), vol. ii.; *Notices of Historic Persons Buried in the Towers of London*, by D. C. Bell (1877); *The Wives of Henry VIII.* by M. A. S. Hume (1905); *Excerpta Historica*, by N. H. Nicolas (1831), p. 260; *Spanish Chronicle of Henry VIII.* tr. by M. A. S. Hume (1889); *Records of the Reformation*, by N. Pocock (1870); *Harleian Miscellany* (1808), iii. 47 (the love letters); *Archæologia*, xiii. 64 (memorial of G. Constantyne); *Eng. Hist. Rev.* v. 54, viii. 53, 299, x. 104; *State Trials*, i. 410; *History of Henry VIII.* by Lord Herbert of Cheshire; E. Hall's *Chronicle: Original Letters*, ed. by Sir H. Ellis, i. ser. ii. 37, 53 et seq., ii. ser. ii. 10; *Extracts from the Life of Queen Anne Boleyn*, by G. Wyat (1817); *The Negotiations of Thomas Wolsey*, by Sir W. Cavendish (1641, rep. Harleian Misc. 1810 v.); C. Wrothesley's *Chronicle* (Camden Soc., 1875-1877); *Notes and Queries*, 8 ser., viii. 141, 189, 313, 350; *Il Successo de la Morte de la Regina de Inghilterra* (1536); *The Manner of the Tryumph of Calveys and Bullen, and the Noble Tryumphants Coronacion of Queen Anne* (1533, rep. 1884); *State Papers Henry VIII.*; *Letters and Papers of Henry VIII.*, by Brewer and Gardiner, esp. the prefaces; *Cal. of State Pap. England and Spain, Venetian and Foreign* (1558-1559), p. 525 (an account full of obvious errors); *Cotton MSS.* (Brit. Mus.), Otho C. 10; "Baga de secretis" in Rep. ii. App. ii. of Dep. Keeper of Public Records, p. 242; "Römische Dokumente," v., M. S. Ehesch (*Görres-gesellschaft*, Bd. ii., 1893). See also articles on CATHERINE OF ARAGON and HENRY VIII. (P. C. Y.)

BOLGARI, or **BOLGARY**, a ruined town of Russia, in the government of Kazan, 4 m. from the left bank of the Volga, in 55° N. lat. It is generally considered to have been the capital of the Bulgarians when they were established in that part of Europe (5th to 15th century). Ruins of the old walls and towers still survive, as well as numerous *kurgans* or burial-mounds, with inscriptions, some in Arabic (1222-1341), others in Armenian (years 557, 984 and 986), and yet others in Turkic. Upon being opened these tombs were found to contain weapons, implements, utensils, and silver and copper coins, bearing inscriptions,

¹ *Letters and Papers*, x. 358.

² "Sawto Diaries," October 31, 1532, in *Cal. of St. Pap. Venetian*, iv. p. 365.

³ *Original Letters*, ed. by Sir H. Ellis, i. ser. ii. 37, and *Cal. of St. Pap. Venetian*, iv. 351, 418.

some in ordinary Arabic, others in Kufic (a kind of epigraphic Arabic). These and other antiquities collected here (1722) are preserved in museums at Kazan, Moscow and St Petersburg. The ruins, which were practically discovered in the reign of Peter the Great, were visited and described by Pallas, Humboldt and others. The city of Bolgari was destroyed by the Mongols in 1238, and again by Tamerlane early in the following century, after which it served as the capital of the Khans (sovereign princes) of the Golden Horde of Mongols, and finally, in the second half of the 15th century it became a part of the principality of Kazan, and so eventually of Russia. The Arab geographer Ibn Haukal states that in his time, near the end of the 10th century, it was a place of 10,000 inhabitants.

See Ibn Fadlan, *Nachrichten über die Wolga Bulgaren* (Ger. trans. by Frähn, St Petersburg, 1832).

BOLI, the chief town of a sanjak of the Kastamuni vilayet in Asia Minor, altitude 2500 ft., situated in a rich plain watered by the Boli Su, a tributary of the Filyyas Chai (*Bilcaeus*). Pop. (1894) 10,796 (Moslems, 9642; Greeks, 758; Armenians, 306). Cotton and leather are manufactured; the country around is fertile, and in the neighbourhood are large forests of oak, beech, elm, chestnut and pine, the timber of which is partly used locally and partly exported to Constantinople. Three miles east of Boli, at Eskihissar, are the ruins of *Bithynium*, the birthplace of Antinous, also called *Antinoopolis*, and in Byzantine times *Claudiopolis*. In and around Boli are numerous marbles with Greek inscriptions, chiefly sepulchral, and architectural fragments. At Ilija, south of the town, are warm springs much prized for their medicinal properties.

BOLINGBROKE, HENRY ST JOHN, Viscount (1678-1751), English statesman and writer, son of Sir Henry St John, Bart. (afterwards 1st Viscount St John, a member of a younger branch of the family of the earls of Bolingbroke and barons St John of Bletso), and of Lady Mary Rich, daughter of the 2nd earl of Warwick, was baptized on the 10th of October 1678, and was educated at Eton. He travelled abroad during 1698 and 1699 and acquired an exceptional knowledge of French. The dissipation and extravagance of his youth exceeded all limits and surprised his contemporaries. He spent weeks in riotous orgies and outdrank the most experienced drunkards. An informant of Goldsmith saw him once "run naked through the park in a state of intoxication." Throughout his career he desired, says Swift, his intimate friend, to be thought the Alcibiades or Petronius of his age, and to mix licentious orgies with the highest political responsibilities.⁴ In 1700 he married Frances, daughter of Sir Henry Winchcombe, Bart., of Bucklebury, Berkshire, but matrimony while improving his fortune did not redeem his morals.

He was returned to parliament in 1701 for the family borough of Wootton Bassett in Wiltshire. He declared himself a Tory, attached himself to Harley (afterwards Lord Oxford), then speaker, whom he now addressed as "dear master," and distinguished himself by his eloquence in debate, eclipsing his school-fellow, Walpole, and gaining an extraordinary ascendancy over the House of Commons. In May he had charge of the bill for securing the Protestant succession; he took part in the impeachment of the Whig lords for their conduct concerning the Partition treaties, and opposed the oath abjuring the Pretender. In March 1702 he was chosen commissioner for taking the public accounts. After Anne's accession he supported the bills in 1702 and 1704 against occasional conformity, and took a leading part in the disputes which arose between the two Houses. In 1704 St John took office with Harley as secretary at war, thus being brought into intimate relations with Marlborough, by whom he was treated with paternal partiality. In 1708 he quitted office with Harley on the failure of the latter's intrigue, and retired to the country till 1710, when he became a privy councillor and secretary of state in Harley's new ministry, representing Berkshire in parliament. He supported the bill for requiring a real property qualification for a seat in parliament. In 1711 he founded the

⁴ Swift's *Inquiry into the Behaviour of the Queen's Last Ministry*; Mrs Delany's *Correspondence*, 2 ser., iii. 168.

Brothers' Club, a society of Tory politicians and men of letters, and the same year witnessed the failure of the two expeditions to the West Indies and to Canada promoted by him. In 1712 he was the author of the bill taxing newspapers. But the great business of the new government was the making of the peace with France. The refusal of the Whigs to grant terms in 1706, and again in 1709 when Louis XIV. offered to yield every point for which the allies professed to be fighting, showed that the war was not being continued for English national interests, and the ministry were supported by the queen, the parliament and the people in their design to terminate hostilities. But various obstacles arose from the diversity of aims among the allies; and St John was induced, contrary to the most solemn obligations, to enter into separate and secret negotiations with France for the security of English interests. In May 1712 St John ordered the duke of Ormonde, who had succeeded Marlborough in the command, to refrain from any further engagement. These instructions were communicated to the French, though not to the allies, Louis putting Dunkirk as security into possession of England, and the shameful spectacle was witnessed of the desertion by the English troops of their allies almost on the battlefield. Subsequently St John received the congratulations of the French minister, Torcy, on the occasion of the French victory over Prince Eugene at Denain.

In August St John, who had on the 7th of July been created Viscount Bolingbroke and Baron St John of Lydiard Tregoze, went to France to conduct negotiations, and signed an armistice between England and France for four months on the 10th. Finally the treaty of Utrecht was signed on the 31st of March 1713 by all the allies except the emperor. The first production of Addison's *Cato* was made by the Whigs the occasion of a great demonstration of indignation against the peace, and by Bolingbroke for presenting the actor Booth with a purse of fifty guineas for "defending the cause of liberty against a perpetual dictator" (Marlborough). In the terms granted to England there was perhaps little to criticize. But the manner of the peacemaking, which had been carried on by a series of underhand conspiracies with the enemy instead of by open conferences with the allies, and was characterized throughout by a violation of the most solemn international assurances, left a deep and lasting stain upon the national honour and credit; and not less dishonourable was the abandonment of the Catalans by the treaty. For all this Bolingbroke must be held primarily responsible. In June his commercial treaty with France, establishing free trade with that country, was rejected. Meanwhile the friendship between Bolingbroke and Harley, which formed the basis of the whole Tory administration, had been gradually dissolved. In March 1711, by Guiscard's attempt on his life, Harley got the wound which had been intended for St John, with all the credit. In May Harley obtained the earldom of Oxford and was made lord treasurer, while in July St John was greatly disappointed at receiving only his viscounty instead of the earldom lately extinct in his family, and at being passed over for the Garter. In September 1713 Swift came to London, and made a last but vain attempt to reconcile his two friends. But now a further cause of difference had arisen. The queen's health was visibly breaking, and the Tory ministers could only look forward to their own downfall on the accession of the elector of Hanover. Both Oxford¹ and Bolingbroke had maintained for some time secret communications with James, and promised their help in restoring him at the queen's death. The aims of the former, prudent, procrastinating and vacillating by nature, never extended probably beyond the propitiation of his Tory followers; and it is difficult to imagine that Bolingbroke could have really advocated the Pretender's recall, whose divine right he repudiated and whose religion and principles he despised. Nevertheless, whatever his chief motive may have been, whether to displace Oxford as leader of the party, to strengthen his position and that of the faction in order to dictate terms to the future king, or to reinstate James, Bolingbroke, yielding to his more impetuous and adventurous disposition, went much further

¹ *Berwick's Mem.* (Petitot), vol. lvi. 219.

than Oxford. It is possible to suppose a connexion between his zeal for making peace with France and a desire to forward the Pretender's interests or win support from the Jacobites.² During his diplomatic mission to France he had incurred blame for remaining at the opera while the Pretender was present,³ and according to the Mackintosh transcripts he had several secret interviews with him. Regular communications were kept up subsequently. In March 1714 Herville, the French envoy in London, sent to Torcy, the French foreign minister in Paris, the substance of two long conversations with Bolingbroke in which the latter advised patience till after the accession of George, when a great reaction was to be expected in favour of the Pretender. At the same time he spoke of the treachery of Marlborough and Berwick, and of one other, presumably Oxford, whom he refused to name, all of whom were in communication with Hanover.⁴ Both Oxford and Bolingbroke warned James that he could have little chance of success unless he changed his religion, but the latter's refusal (March 13) does not appear to have stopped the communications. Bolingbroke gradually superseded Oxford in the leadership. Lady Masham, the queen's favourite, quarrelled with Oxford and identified herself with Bolingbroke's interests. The harsh treatment of the Hanoverian demands was inspired by him, and won favour with the queen, while Oxford's influence declined; and by his support of the Schism Bill in May 1714, a violent Tory measure forbidding all education by dissenters by making an episcopal licence obligatory for schoolmasters, he probably intended to compel Oxford to give up the game. Finally, a charge of corruption brought by Oxford in July against Bolingbroke and Lady Masham, in connexion with the commercial treaty with Spain, failed, and the lord treasurer was dismissed or retired on the 27th of July.

Bolingbroke was now supreme, and everything appeared tending inevitably to a Jacobite restoration. The Jacobite Sir William Windham had been made chancellor of the exchequer, important military posts were placed in the hands of the faction, and a new ministry of Jacobites was projected. But now the queen's sudden death on the 1st of August, and the appointment of Shrewsbury to the lord treasurer'ship, instantly changed the whole scene and ruined Bolingbroke. "The earl of Oxford was removed on Tuesday," he wrote to Swift on the 3rd of August, "the queen died on Sunday! What a world is this and how does fortune banter us!" According to Herville, the French envoy, Bolingbroke declared to him that in six weeks he could have secured everything. Nevertheless the exact nature of his projects remains obscure. It is probable that his statement in his letter to Windham that "none of us had any very settled resolution" is true, though his declaration in the *Patriot King* that "there were no designs on foot . . . to place the crown on the head of the Pretender" is a palpable falsehood. His great object was doubtless to gain supreme power and to keep it by any means, and by any betrayal that the circumstances demanded; and it is not without significance perhaps that on the very day of Oxford's dismissal he gave a dinner to the Whig leaders, and on the day preceding the queen's death ordered overtures to be made to the elector.⁵

On the accession of George I. the illuminations and bonfire at Lord Bolingbroke's house in Golden Square were "particularly fine and remarkable,"⁶ but he was immediately dismissed from office. He retired to Bucklebury and is said to have now written the answer to the *Secret History of the White Staff* accusing him of Jacobitism. In March 1715 he in vain attempted to defend the late ministry in the new parliament; and on the announcement of Walpole's intended attack upon the authors of the treaty of Utrecht he fled in disguise (March 28, 1715) to Paris, where he was well received, after having addressed a letter to Lord Lansdowne from Dover protesting his innocence

² *Hist. MSS. Comm., Portland MSS.* v. 235.

³ *Stuart MSS.* (Roxburghe Club), ii. 383.

⁴ *Hist. MSS. Comm., MSS. of H. M. the King, Stuart Papers*, i. p. xlviii.

⁵ *Sichel's Bolingbrokes*, i. 340; *Lockhart Papers*, i. 460; *Macpherson*, ii. 529.

⁶ *Wentworth Papers*, 408.

and challenging "the most inveterate of his enemies to produce any instance of his criminal correspondence." Bolingbroke in July entirely identified himself with the interests of the Pretender, whose secretary he became, and on the 10th of September he was attainted. But his counsel was neglected for that of ignorant refugees and Irish priests. The expedition of 1715 was resolved upon against his advice. He drew up James's declaration, but the assurances he had inserted concerning the security of the Church of England were cancelled by the priests. He remained at Paris, and endeavoured to establish relations with the regent. On the return of James, as the result of petty intrigues and jealousies, Bolingbroke was dismissed from his office. He now renounced all further efforts on the Pretender's behalf.¹ Replying to Mary of Modena, who had sent a message deprecating his ill-will, he wished his arm might rot off if he ever used pen or sword in their service again!²

He now turned to the English government in hopes of pardon. In March 1716 he declared his final abandonment of the Pretender and promised to use his influence to secure the withdrawal of his friends; but he refused to betray any secrets or any individuals. He wrote his *Reflections upon Exile*, and in 1717 his letter to Sir W. Windham in explanation of his position, generally considered one of his finest compositions, but not published till 1753 after his death. The same year he formed a liaison with Marie Claire Deschamps de Marilly, widow of the marquis de Villette, whom he married in 1720 after the death in 1718 of Lady Bolingbroke, whom he had treated with cruel neglect. He bought and resided at the estate of La Source near Orleans, studied philosophy, criticized the chronology of the Bible, and was visited amongst others by Voltaire, who expressed unbounded admiration for his learning and politeness. In 1723, through the medium of the king's mistress, the duchess of Kendal, he at last received his pardon, returned to London in June or July, and placed his services at the disposal of Walpole, by whom, however, his offers to procure the accession of several Tories to the administration were received very coldly. During the following winter he made himself useful in France in gaining information for the government. In 1725 an act was passed enabling him to hold real estate but without power of alienating it.³ But this had been effected in consequence of a peremptory order of the king, against Walpole's wishes, who succeeded in maintaining his exclusion from the House of Lords. He now bought an estate at Dawley, near Uxbridge, where he renewed his intimacy with Pope, Swift and Voltaire, took part in Pope's literary squabbles, and wrote the philosophy for the *Essay on Man*. On the first occasion which offered itself, that of Pulteney's rupture with Walpole in 1726, he endeavoured to organize an opposition in conjunction with the former and Windham; and in 1727 began his celebrated series of letters to the *Craftsman*, attacking the Walpoles, signed an "Occasional Writer." He gained over the duchess of Kendal with a bribe of £11,000 from his wife's estates, and with Walpole's approval obtained an audience with George. His success was imminent, and it was thought his appointment as chief minister was assured. In Walpole's own words, "as St John had the duchess entirely on his side I need not add what must or might in time have been the consequence," and he prepared for his dismissal. But once more Bolingbroke's "fortune turned rotten at the very moment it grew ripe,"⁴ and his projects and hopes were ruined by the king's death in June.⁵ Further papers from his pen signed "John Trot" appeared in the *Craftsman* in 1728, and in 1730 followed *Remarks on the History of England by Humphrey Oldcastle*, attacking the Walpoles' policy. The assault on the govern-

ment prompted by Bolingbroke was continued in the House of Commons by Windham, and great efforts were made to establish the alliance between the Tories and the Opposition Whigs. The Excise Bill in 1733 and the Septennial Bill in the following year offered opportunities for further attacks on the government, which Bolingbroke supported by a new series of papers in the *Craftsman* styled "A Dissertation on Parties"; but the whole movement collapsed after the new elections, which returned Walpole to power in 1735 with a large majority.

Bolingbroke retired baffled and disappointed from the fray to France in June, residing principally at the château of Argeville near Fontainebleau. He now wrote his *Letters on the Study of History* (printed privately before his death and published in 1752), and the *True Use of Retirement*. In 1738 he visited England, became one of the leading friends and advisers of Frederick, prince of Wales, who now headed the opposition, and wrote for the occasion *The Patriot King*, which together with a previous essay, *The Spirit of Patriotism*, and *The State of Parties at the Accession of George I.*, were entrusted to Pope and not published. Having failed, however, to obtain any share in politics, he returned to France in 1739, and subsequently sold Dawley. In 1742 and 1743 he again visited England and quarrelled with Warburton. In 1744 he settled finally at Battersea with his friend Hugh Hume, 3rd earl of Marchmont, and was present at Pope's death in May. The discovery that the poet had printed secretly 1500 copies of *The Patriot King* caused him to publish a correct version in 1749, and stirred up a further altercation with Warburton, who defended his friend against Bolingbroke's bitter aspersions, the latter, whose conduct was generally reprehended, publishing a *Familiar Epistle to the most Impudent Man Living*. In 1744 he had been very busy assisting in the negotiations for the establishment of the new "broad bottom" administration, and showed no sympathy for the Jacobite expedition in 1745. He recommended the tutor for Prince George, afterwards George III. About 1749 he wrote the *Present State of the Nation*, an unfinished pamphlet. Lord Chesterfield records the last words heard from him: "God who placed me here will do what He pleases with me hereafter and He knows best what to do." He died on the 12th of December 1751, his wife having predeceased him in 1750. They were both buried in the parish church at Battersea, where a monument with medallions and inscriptions composed by Bolingbroke was erected to their memory.

The writings and career of Bolingbroke make a far weaker impression upon posterity than they made on contemporaries. His genius and character were superficial; his abilities were exercised upon ephemeral objects, and not inspired by lasting or universal ideas. Bute and George III. indeed derived their political ideas from *The Patriot King*, but the influence which he is said to have exercised upon Voltaire, Gibbon and Burke is very problematical. Burke wrote his *Vindication of Natural Society* in imitation of Bolingbroke's style, but in refutation of his principles; and in the *Reflections on the French Revolution* he exclaims, "Who now reads Bolingbroke, who ever read him through?" Burke denies that Bolingbroke's words left "any permanent impression on his mind." Bolingbroke's conversation, described by Lord Chesterfield as "such a flowing happiness of expression that even his most familiar conversations if taken down in writing would have borne the press without the least correction," his delightful companionship, his wit, good looks, and social qualities which charmed during his lifetime and made firm friendships with men of the most opposite character, can now only be faintly imagined. His most brilliant gift was his eloquence, which according to Swift was acknowledged by men of all factions to be unrivalled. None of his great orations has survived, a loss regretted by Pitt more than that of the missing books of Livy and Tacitus, and no art perishes more completely with its possessor than that of oratory. His political works, in which the expression is often splendidly eloquent, spirited and dignified, are for the most part exceedingly rhetorical in style, while his philosophical essays were undertaken with the chief object of displaying his eloquence, and no characteristic renders

¹ Hist. MSS. Comm., *Stuart Papers*, i. 500; Berwick's *Mem. (Pretor)*, vol. lxxvi. 262.

² *Come's Walpole*, i. 200; *Stuart Papers*, ii. 511, and also 446, 460.

³ Hist. MSS. Comm., *Onslow MSS.* 513.

⁴ Bolingbroke to Swift, June 24th, 1727. He adds, "to hanker after a court is below either you or me."

⁵ *Sichel's Bolingbroke*, ii. 267; *Stanhope*, ii. 163; Hist. MSS. Comm., *Onslow MSS.* 516, 8th Rep. Pt. III. App. p. 3. This remarkable incident is discredited by H. Walpole in *Letters* (ed. 1903), iii. 269; but he was not always well informed concerning his father's career.

writings less readable for posterity. They are both deficient in solidity and in permanent interest. The first deals with mere party questions without sincerity and without depth; and the second, composed as an amusement in retirement without any serious preparation, in their attacks on metaphysics and theology and in their feeble deism present no originality and carry no conviction. Both kinds reflect in their Voltairian superficiality Bolingbroke's manner of life, which was throughout uninspired by any great ideas or principles and thoroughly false and superficial. Though a libertine and a free-thinker, he had championed the most bigoted and tyrannical high-church measures. His diplomacy had been subordinated to party necessities. He had supported by turns and simultaneously Jacobite and Hanoverian interests. He had only conceived the idea of *The Patriot King* in the person of the worthless Frederick in order to stir up sedition, while his eulogies on retirement and study were pronounced from an enforced exile. He only attacked party government because he was excluded from it, and only railed at corruption because it was the corruption of his antagonists and not his own. His public life presents none of those acts of devotion and self-sacrifice which often redeem a career characterized by errors, follies and even crimes.

One may deplore his unfortunate history and wasted genius, but it is impossible to regret his exclusion from the government of England. He was succeeded in the title as 2nd Viscount Bolingbroke, according to the special remainder, by his nephew Frederick, 3rd Viscount St John (a title granted to Bolingbroke's father in 1716), from whom the title has descended.

BIBLIOGRAPHY.—Bolingbroke's collected works, including his chief political writings already mentioned and his philosophical essays *Concerning the Nature, Extent and Reality of Human Knowledge, On the Folly and Presumption of Philosophers, On the Rise and Progress of Monachism, and On Authority in Matters of Religion*, were first published in Mallet's faulty edition in 1754.—according to Johnson's well-known denunciation, "the blunderbus charged against religion and morality,"—and subsequently in 1778, 1809 and 1841. *A Collection of Political Tracts* by Bolingbroke was published in 1748. His *Letters* were published by G. Parke in 1798, and by Grimoard, *Lettres historiques, politiques, philosophiques, &c.*, in 1808; for others see Pope's and Swift's *Correspondence*; W. Coxe's *Walpole*; Phillimore's *Life of Lyttelton*; *Hardwicke State Papers*, vol. ii.; *Marchmont Papers*, ed. by Sir G. H. Rose (1831); *Letters to Lord Chancellor Hardwicke in Add. MSS. Brit. Museum* (see Index, 1894-1899), mostly transcribed by W. Sichel; *Hist. MSS. Comm.*, *MSS. of Marquis of Bath, Duke of Portland at Welbeck*; while a further collection of his letters relating to the treaty of Utrecht is in the British Museum. For his attempts at verse see Walpole's *Royal and Noble Authors* (1806), iv. 209 et seq. See also bibliography of his works in Sichel, ii. 456, 249.

A life of Bolingbroke appeared in his lifetime about 1740, entitled *Authentic Memoirs* (in the Grenville Library, Brit. Mus.), which recounted his escapades; other contemporary accounts were published in 1752 and 1754, and a life by Goldsmith in 1770. Of the more modern biographies may be noted that in the *Dict. of Nat. Biog.* by Sir Leslie Stephen, 1897; by C. de Remusat in *L'Angleterre au 18me siècle* (1856), vol. i.; by T. Macknight (1863); by J. Churton Collins (1886); by A. Hassall (1889); and by Walter Sichel (1901-1902), elaborate and brilliant, but unduly eulogistic. (P. C. Y.)

BOLIVAR, SIMON (1783-1830), the hero of South American independence, was born in the city of Caracas, Venezuela, on the 24th of July 1783. His father was Juan Vicente Bolivar y Ponte, and his mother Maria Concepcion Palacios y Sojo, both descended from noble families in Venezuela. Bolivar was sent to Europe to prosecute his studies, and resided at Madrid for several years. Having completed his education, he spent some time in travelling, chiefly in the south of Europe, and visited Paris, where he was an eye-witness of some of the last scenes of the Revolution. Returning to Madrid, he married, in 1801, the daughter of Don N. Toro, uncle of the marquis of Toro in Caracas, and embarked with her for Venezuela, intending, it is said, to devote himself to the improvement of his large estate. But the premature death of his young wife, who fell a victim to yellow fever, drove him again to Europe. Returning home in 1809 he passed through the United States, where, for the first time, he had an opportunity of observing the working of free institutions; and soon after his arrival in Venezuela he appears to have identified himself with the cause of independence which had already agitated the Spanish colonies for some years. Being one

of the promoters of the insurrection at Caracas in April 1810, he received a colonel's commission from the revolutionary junta, and was associated with Louis Lopez Mendez in a mission to the court of Great Britain. Venezuela declared its independence on the 5th of July 1811, and in the following year the war commenced in earnest by the advance of Monteverde with the Spanish troops. Bolivar was entrusted with the command of the important post of Puerto Cabello, but not being supported he had to evacuate the place; and owing to the inaction of Miranda the Spaniards recovered their hold over the country.

Like others of the revolutionists Bolivar took to flight, and succeeded in reaching Curaçao in safety. He did not, however, remain long in retirement, but in September 1812, hearing of important movements in New Granada, repaired to Cartagena, where he received a commission to operate against the Spanish troops on the Magdalena river. In this expedition he proved eminently successful, driving the Spaniards from post to post, until arriving at the confines of Venezuela he boldly determined to enter that province and try conclusions with General Monteverde himself. His troops did not number more than 500 men; but, in spite of many discouragements, he forced his way to Merida and Truxillo, towns of some importance in the west of Venezuela, and succeeded in raising the population to his support. Forming his increased forces into two divisions, he committed the charge of one to his colleague Rivas, and pushing on for Caracas the capital, issued his decree of "war to the death." A decisive battle ensued at Lastoguanes, where the Spanish troops under Monteverde sustained a crushing defeat. Caracas was entered in triumph on the 4th of August 1813, and Monteverde took refuge in Puerto Cabello. General Mariño effected the liberation of the eastern district of Venezuela, and the patriots obtained entire possession of the country in January 1814. This success was, however, of very brief duration. The royalists, effectually roused by the reverses they had sustained, concentrated all their means, and a number of sanguinary encounters ensued. Bolivar was eventually defeated by Boves near Cura, in the plains of La Puerta, and compelled to embark for Cumana with the shattered remains of his forces. Caracas was retaken by the Spaniards in July; and before the end of the year 1814 the royalists were again the undisputed masters of Venezuela. From Cumana Bolivar repaired to Cartagena, and thence to Tunja, where the revolutionary congress of New Granada was sitting. Here, notwithstanding his misfortunes and the efforts of his personal enemies, he was received and treated with great consideration. The congress appointed him to conduct an expedition against Santa Fé de Bogota, where Don Cundinamarca had refused to acknowledge the new coalition of the provinces. In December 1814 he appeared before Bogota with a force of 2000 men, and obliged the recalcitrant leaders to capitulate, a service for which he received the thanks of congress. In the meanwhile Santa Martha had fallen into the hands of the royalists, and Bolivar was ordered to the relief of the place. In this, however, he was not successful, General Morillo having landed an overwhelming Spanish force. Hopeless of the attempt he resigned his commission and embarked for Kingston, Jamaica, in May 1814. While residing there an attempt was made upon his life by a hired assassin, who, in mistake, murdered his secretary.

From Kingston Bolivar went to Aux Cayes in Haiti, where he was furnished with a small force by President Pétion. An expedition was organized, and landed on the mainland in May 1816, but proved a failure. Nothing daunted, however, he obtained reinforcements at Aux Cayes, and in December landed first in Margarita, and then at Barcelona. Here a provisional government was formed, and troops were assembled to resist Morillo, who was then advancing at the head of a strong division. The hostile forces encountered each other on the 16th of February 1817, when a desperate conflict ensued, which lasted during that and the two following days, and ended in the defeat of the royalists. Morillo retired in disorder, and being met on his retreat by J. A. Páez with his *llaneros*, suffered an additional and more complete overthrow. Being now recognized as commander-in-chief, Bolivar

proceeded in his career of victory, and before the close of the year had fixed his headquarters at Angostura on the Orinoco. At the opening of the congress which assembled in that city on the 15th February 1819 he submitted an elaborate exposition of his views on government, and concluded by surrendering his authority into the hands of congress. Being, however, required to resume his power, and retain it until the independence of the country had been completely established, he reorganized his troops, and set out from Angostura, in order to cross the Cordilleras, effect a junction with General Santander, who commanded the republican force in New Granada, and bring their united forces into action against the common enemy. This bold and original design was crowned with complete success. In July 1819 he entered Tunja, after a sharp action on the adjoining heights; and on the 7th of August he gained the victory of Boyaca, which gave him immediate possession of Bogota and all New Granada.

His return to Angostura was a sort of national festival. He was hailed as the deliverer and father of his country, and all manner of distinctions and congratulations were heaped upon him. Availing himself of the favourable moment, he obtained the enactment of the fundamental law of the 17th of December 1819, by which the republics of Venezuela and New Granada were henceforth to be united in a single state, under his presidency, by the title of the Republic of Colombia. The seat of government was also transferred provisionally to Rosario de Cucuta, on the frontier of the two provinces, and Bolivar again took the field. Being now at the head of the most numerous and best appointed army the republicans had yet assembled, he gained important advantages over the Spaniards under Morillo, and on the 25th of November 1820 concluded at Truxillo an armistice of six months, probably in the hope that the Spaniards would come to terms, and that the further effusion of blood might be spared. If such were his views, however, they were disappointed. Morillo was recalled, and General Torre assumed the command. The armistice was allowed to expire, and a renewal of the contest became inevitable. Bolivar therefore resolved, if possible, to strike a decisive blow; and this accordingly he did at Carabobo, where, encountering Torre, he so completely routed the Spaniards that the shattered remains of their army were forced to take refuge in Puerto Cabello, where two years after they surrendered to Paez. The battle of Carabobo may be considered as having put an end to the war in Venezuela. On the 20th of June 1821 Bolivar entered Caracas, and by the close of the year the Spaniards were driven from every part of the province except Puerto Cabello. The next step was to secure, by permanent political institutions, the independence which had been so dearly purchased; and, accordingly, on the 30th of August 1821 the constitution of Colombia was adopted with general approbation, Bolivar himself being president, and Santander vice-president.

There was, however, more work for him to do. The Spaniards, though expelled from Colombia, still held possession of the neighbouring provinces of Ecuador and Peru; and Bolivar determined to complete the liberation of the whole country. Placing himself at the head of the army, he marched on Quito in Ecuador. A severe battle was fought at Pichincha, where, by the prowess of his colleague Sucre, the Spaniards were routed, and Quito was entered by the republicans in June 1822. Bolivar then marched upon Lima, which the royalists evacuated at his approach; and entering the capital in triumph, he was invested with absolute power as dictator, and authorized to call into action all the resources of the country. Owing, however, to the intrigues of the republican factions in Peru he was forced to withdraw to Truxillo, leaving the capital to the mercy of the Spaniards under Canterac, by whom it was immediately occupied. But this misfortune proved only temporary. By June 1824 the liberating army was completely organized; and taking the field soon after, it routed the vanguard of the enemy. Improving his advantage, Bolivar pressed forward, and on the 6th of August defeated Canterac on the plains of Junin, after which he returned to Lima, leaving Sucre to follow the royalists in

their retreat to Upper Peru—an exploit which the latter executed with equal ability and success, gaining a decisive victory at Ayacucho, and thus completing the dispersion of the Spanish force. The possessions of the Spaniards in Peru were now confined to the castles of Callao, which Rodil maintained for upwards of a year, in spite of all the means that could be employed for their reduction. In June 1825 Bolivar visited Upper Peru, which, having detached itself from the government of Buenos Aires, was formed into a separate state, called Bolivia, in honour of the liberator. The first congress of the new republic assembled in August 1825, when Bolivar was declared perpetual protector, and requested to prepare for it a constitution of government.

His care was now directed to the administration of the affairs of the freed provinces. His endeavours to satisfy his countrymen in this respect did not always meet with encouragement, and sometimes exposed him to slander. In December 1824 Bolivar convoked a constituent congress for the February following; but this body, taking into consideration the unsettled state of the country, thought it proper to invest him with dictatorial power for another year. His project of a constitution for Bolivia was presented to the congress of that state on the 25th of May 1826, accompanied with an address, in which he embodied his opinions respecting the form of government which he conceived most expedient for the newly established republics. This code, however, did not give satisfaction. Its most extraordinary feature consisted in the provision for lodging the executive authority in the hands of a president for life, without responsibility and with power to nominate his successor, a proposal which alarmed the friends of liberty, and excited lively apprehensions amongst the republicans of Buenos Aires and Chile; whilst in Peru, Bolivar was accused of a design to unite into one state Colombia, Peru and Bolivia, and to render himself perpetual dictator of the confederacy.

In the meanwhile the affairs of Colombia had taken a turn which demanded the presence of Bolivar in his own country. During his absence Santander had administered the government of the state ably and uprightly, and its independence had been recognized by other countries. But Paez, who commanded in Venezuela, having been accused of arbitrary conduct in the enrolment of the citizens of Caracas in the militia, refused obedience to the summons of the senate, and placed himself in a state of open rebellion against the government, being encouraged by a disaffected party in the northern departments who desired separation from the rest of the republic.

Accordingly, having entrusted the government to a council nominated by himself, with Santa Cruz at its head, Bolivar set out from Lima in September 1826, and hastening to Bogota, arrived there on the 14th of November. He immediately assumed the extraordinary powers which by the constitution the president was authorized to exercise in case of rebellion. After a short stay in the capital he pressed forward to stop the effusion of blood in Venezuela, where matters had gone much farther than he could have contemplated. On the 31st of December he reached Puerto Cabello, and the following day he issued a decree offering a general amnesty. He had then a friendly meeting with Paez and soon after entered Caracas, where he fixed his headquarters, in order to check the northern departments, which had been the principal theatre of the disturbances. In the meanwhile Bolivar and Santander were re-elected to the respective offices of president and vice-president, and by law they should have qualified as such in January 1827. In February, however, Bolivar formally resigned the presidency of the republic, at the same time expressing a determination to refute the imputations of ambition which had been so freely cast upon him, by retiring into private life, and spending the remainder of his days on his patrimonial estate. Santander combated this proposal, urging him to resume his station as constitutional president, and declaring his own conviction that the troubles and agitations of the country could only be appeased by the authority and personal influence of the liberator himself. This view being confirmed by a resolution of congress, although it was not a unanimous

one, Bolivar decided to resume his functions, and he repaired to Bogota to take the oaths. Before his arrival, however, he issued simultaneously three separate decrees—one granting a general amnesty, another convoking a national convention at Ocaña, and a third for establishing constitutional order throughout Colombia. His arrival was accelerated by the occurrence of events in Peru and the southern departments which struck at the very foundation of his power. Not long after his departure from Lima, the Bolivian code had been adopted as the constitution of Peru, and Bolivar had been declared president for life on the 9th of December 1826, the anniversary of the battle of Ayacucho. At this time the Colombian auxiliary army was cantoned in Peru, and the third division, stationed at Lima, consisting of veteran troops under Lara and Sands, became distrustful of Bolivar's designs on the freedom of the republic. Accordingly, in about six weeks after the adoption of Bolivar's new constitution, a counter-revolution in the government of Peru was effected by this body of dissatisfied veterans, and the Peruvians, availing themselves of the opportunity, abjured the Bolivian code, deposed the council appointed by the liberator, and proceeded to organize a provisional government for themselves. After this bloodless revolution the third division embarked at Callao on the 17th of March 1827, and landed in the southern department of Colombia in the following month. Intelligence of these events reached Bolivar while in the north of Colombia, and he lost no time in preparing to march against the refractory troops, who formerly had placed such implicit confidence in him. But he was spared the necessity of coming to blows, for the leaders, finding the government in the hands of the national executive, had peaceably submitted to General Ovando. In the meanwhile Bolivar had accepted the presidency, and resumed the functions belonging to his official position. But although Colombia was, to all external appearance, restored to tranquillity, the nation was divided into two parties. Bolivar had, no doubt, regained the personal confidence of the officers and soldiers of the third division; but the republican party, with Santander at their head, continued to regard with undisguised apprehension his ascendancy over the army, suspecting him of a desire to imitate the career of Napoleon. In the meanwhile all parties looked anxiously to the convention of Ocaña, which was to assemble in March 1828, for a decided expression of the national will. The republicans hoped that the issue of its deliberations would be favourable to their views; whilst the military, on the other hand, did not conceal their conviction that a stronger and more permanent form of government was essential to the public welfare. The latter view seems to have prevailed. In virtue of a decree, dated Bogota, the 27th of August 1828, Bolivar assumed the supreme power in Colombia, and continued to exercise it until his death, which took place at San Pedro, near Santa Marta, on the 17th of December 1830.

Bolivar spent nine-tenths of a splendid patrimony in the service of his country; and although he had for a considerable period unlimited control over the revenues of three countries—Colombia, Peru and Bolivia—he died without a shilling of public money in his possession. He achieved the independence of three states, and called forth a new spirit in the southern portion of the New World. He purified the administration of justice; he encouraged the arts and sciences; he fostered national interests, and he induced other countries to recognize that independence which was in a great measure the fruit of his own exertions. His remains were removed in 1842 to Caracas, where a monument was erected to his memory; a statue was put up in Bogota in 1846; in 1858 the Peruvians followed the example by erecting an equestrian statue of the liberator in Lima; and in 1884 a statue was erected in Central Park, New York.

Twenty-two volumes of official documents bearing on Bolivar's career were officially published at Caracas in 1826-1833. There are lives by Larrazabal (New York, 1866); Rojas (Madrid, 1883); and Ducoudray-Holstein (Paris, 1831). Two volumes of his correspondence were published in New York in 1866.

BOLIVAR, till 1908 a department of Colombia, bounded N. and W. by the Caribbean Sea, E. by the departments of Magdalena and Santander, S. by Antioquia and S.W. by Cauca.

It has an area of 27,028 sq. m., composed in great part of low, alluvial plains, densely wooded, but slightly cultivated and unsuited for north European labour. The population, estimated at 323,097 in 1899, is composed largely of mixed races; in some localities the inhabitants of mixed race are estimated to constitute four-fifths of the population. The capital, Cartagena on the Caribbean coast, was once the principal commercial entrepôt of Colombia. Other important towns are Barranquilla and Mompox (8000), on the Magdalena river, and Corozal (9000) and Loricá (10,596 in 1902), near the western coast.

BOLIVAR, an inland state of Venezuela, lying S. of the Orinoco and Apure, with the Yuruari territory on the E., the Caroni river forming the boundary, and the Amazonas territory and Brazil on the S. Frequent political changes in Venezuela have led to various modifications in the size and outlines of this state, which comprises large areas of uninhabited territory. It is a country of extensive plains (*llanos*) covered in the rainy season with nutritious grass which disappears completely in the dry season, and of great forests and numerous rivers. Its population was given in 1894 as 135,232, but its area has been largely reduced since then. The capital is Ciudad Bolívar, formerly called Angostura, which is situated on the right bank of the Orinoco about 240 m. above its mouth; pop. 11,686. Vessels of light draught easily ascend the Orinoco to this point, and a considerable trade is carried on, the exports being cocoa, sugar, cotton, hides, jerked beef and various forest products.

BOLIVIA, an inland republic of South America, once a part of the Spanish vice-royalty of Peru and known as the province of Charcas, or Upper Peru. It is the third largest political division of the continent, and extends, approximately, from 9° 44' to 22° 50' S. lat., and from 58° to 70° W. long. It is bounded N. and E. by Brazil, S. by Paraguay and Argentina, and W. by Chile and Peru. Estimates of area vary widely and have been considerably confused by repeated losses of territory in boundary disputes with neighbouring states, and no figures can be given which may not be changed to some extent by further revisions. Official estimates are 640,226 and 703,633 sq. m., but Supan (*Die Bevölkerung der Erde*, 1904) places it at 515,156 sq. m.

Boundaries.—The boundary line between Bolivia and Brazil has its origin in the limits between the Spanish and Portuguese colonies determined by the treaties of Madrid and San Ildefonso (1750 and 1777), which were modified by the treaties of 1867 and 1903. Beginning at the outlet of Bahía Negra into the Paraguay river, lat. 28° 08' 35" S., the line ascends the latter to a point on the west bank 9 kilometres below Fort Coimbra, thence inland 4 kilometres to a point in lat. 19° 45' 36" S. and long. 58° 04' 12.7" W., whence it follows an irregular course N. and E. of N. to Lakes Mandioré, Gaiba or Gabiba, and Uberaba, then up the San Matias river and N. along the Sierra Ricardo Franco to the headwaters of the Rio Verde, a tributary of the Guaporé. This part of the boundary was turned inland from the Paraguay to include, within Brazilian jurisdiction, Fort Coimbra, Corumbá and other settlements on the west bank, and was modified in 1903 by the recession of about 1158 sq. m. to Bolivia to provide better commercial facilities on the Paraguay. The line follows the Verde, Guaporé, Mamoré and Madeira rivers down to the mouth of the Abuna, in about lat. 9° 44' S., as determined by the treaty of 1903. This is a part of the original colonial frontier, which extended down the Madeira to a point midway between the Beni and the Amazon, and then ran due W. to the Javary. The treaty of 1867 changed this starting-point to the mouth of the Beni, in lat. 10° 20' S., and designated a straight line to the source of the Javary as the frontier, which gave to Brazil a large area of territory; but when the valuable rubber forests of the upper Purús became known the Brazilians invaded them and demanded another modification of the boundary line. This was finally settled in 1903 by the treaty of Petropolis, which provided that the line should ascend the Abuna river to lat. 10° 20' S., thence along that parallel W. to the Rapirán river which is followed to its principal source, thence due W. to the Ituxy river which is followed W. to its source, thence to the

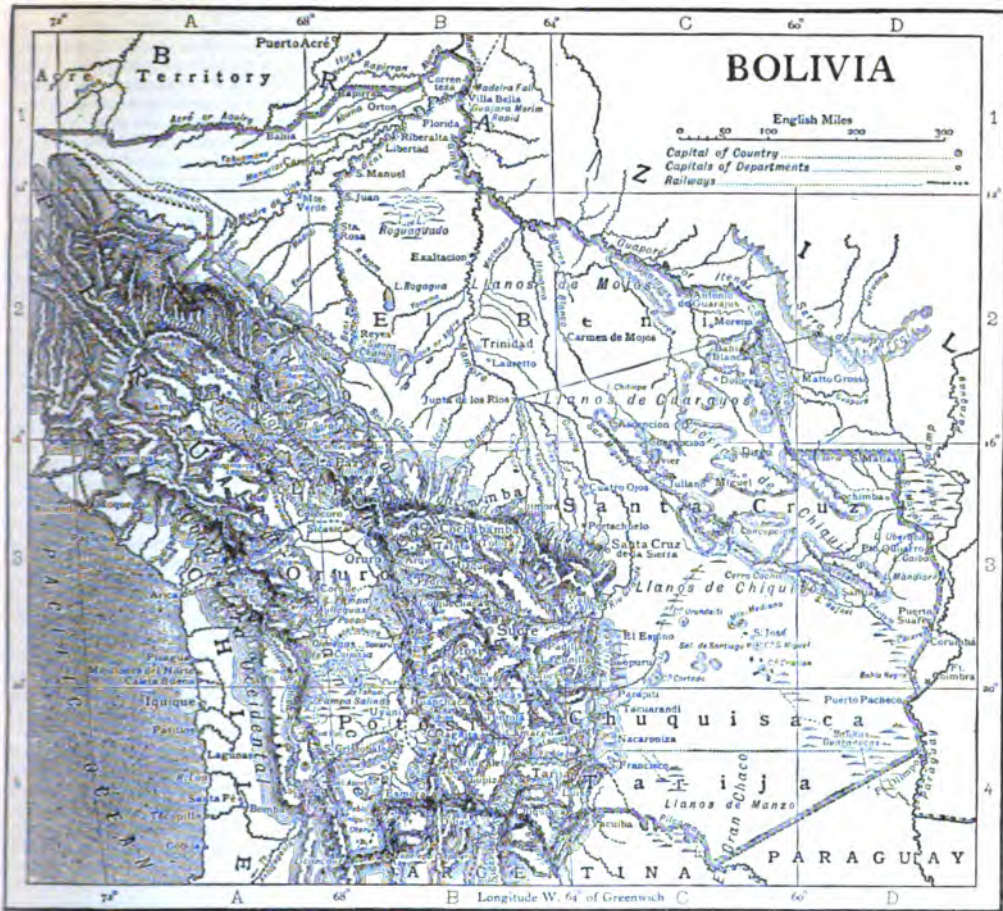

source of Bahia Creek which is followed to the Acré or Aquiry river, thence up the latter to its source, whence if east of the 69th meridian it runs direct to the 11th parallel which will form the boundary line to the Peruvian frontier. This frontier gave about 60,000 sq. m. of territory to Brazil, for which the latter gave an indemnity of £2,000,000 and about 1158 sq. m. of territory on the Matto Grosso frontier. The boundary with Paraguay is unsettled, but an unratified treaty of the 23rd of November 1894 provides that the line shall start from a point on the Paraguay river 3 m. north of Fort Olimpo and run south-west in a straight line to an intersection with the Pilcomayo in long. $61^{\circ} 28' W.$, where it unites with the Argentine boundary. The boundary with Chile was greatly modified by the results of the war of 1879-83, as determined by the treaties of 1884, 1886 and 1895, Bolivia losing her department of the littoral on the Pacific and all access to the coast except by the grace of the conqueror. Provisions were made in 1895 for the cession of the port of Mejillones del Norte and a right of way across the province of Tarapacá, but Peru protested, and negotiations followed for the cession of Cobija, in the province of Antofagasta. These negotiations proved fruitless, and in 1904 Bolivia accepted a pecuniary indemnity in lieu of territory. The new boundary line starts from the summit of the Saperli (or Zapalegui), where the

Argentine, Bolivian and Chilean boundaries converge, and runs west to Licancaur, thence north to the most southern source of Lake Ascotán which it follows to and across this lake in the direction of the Oyahua volcano, and thence in a straight line to the Tua volcano, on the frontier of the province of Tarapacá. From this point the line follows the summits of the Cordillera Silillica north to the Cerro Paquiza, on the Tacna frontier, and to the Nevado Pomarape, near the frontier of Peru. Thence it continues north to an intersection with the Desaguadero, in about $16^{\circ} 45' S. lat.$, follows that river to the Winamarca lagoon and Lake Titicaca, and crosses the latter diagonally to Huaicho on the north shore. From this point the line crosses the Cordillera Real through the valley of the San Juan del Oro to Suches Lake, follows the Cololo and Apolobamba ranges to the headwaters of the Sina river, and thence down that stream to the Inambari. Thence the line either follows the latter to its confluence with the Madre de Dios, or the water-parting between that river and the Tambopata or Pando, to the valley of the Madre de Dios, from which point it runs due north to $12^{\circ} 40' S. lat.$, and north-west to the new Brazilian frontier. The N.W. angle on the map represents the Bolivian claim until the settlement of 1909, which gave the territory to Peru.

Physiography.—Roughly calculated, two-fifths of the total area

of Bolivia is comprised within the Andean cordilleras which cross its south-west corner and project east toward the Brazilian highlands in the form of a great obtuse angle. The cordilleras, divided into two great parallel chains, with flanking ranges and spurs to the east, reach their greatest breadth at this point and form the *massif* of the Andean system. It is made up of a number of parallel ranges enclosing great elevated plateaus broken by transverse ranges and deep ravines. North-east of Lake Titicaca there is a confused mass or knot (the Nudo de Apolobamba) of lofty intersecting ridges which include some of the highest peaks in South America. Below this mountainous area the ranges open out and enclose extensive plateaus. The western range, the Cordillera Occidental, a part of the boundary between Bolivia and the northern provinces of Chile, closely follows the coast outline and forms the western rampart of the great Bolivian tableland or *alta-planicie*, which extends from the Vilcanota knot in Peru, south to the Serranía de Lipez on the Argentine frontier, is 500 m. long, and about 80 m. broad, and contains about 40,000 sq. m. The northern part of this plateau is commonly called the *puna*; the southern part, the "desert of Lipez," in character and appearance is part of the great Puna de Atacama. This plateau has an average elevation of about 12,650 ft. near Lake Titicaca, but descends about 1000 ft. toward its southern extremity. It is a great lacustrine basin where once existed an inland sea having an outlet to the east through the La Paz gorge. The plateau is bleak and inhospitable in the north, barren and arid toward the south, containing great saline depressions covered with water in the rainy season, and broken by ridges and peaks, the highest being the Cerro de Taha, 17,454 ft. Overlooking the plateau from the west are the snow-clad peaks of Pomarape (20,505 ft.), Parinacota (20,918 ft.), Sajama (21,047), Huallatiri (21,654), Lirima (19,128), and the three volcanic peaks, Oyahu (19,226), San Pedro y Pablo (19,423) and Licancaur (19,685). The eastern rampart of this great plateau is formed by the Cordillera Oriental, which extends north-west into Peru under the name of Carabaya, and south to the frontier in broken ranges, one of which trends south-east in the vicinity of Sucre. The main part of this great range, known as the Cordillera Real, and one of the most imposing mountain masses of the world, extends from the Peruvian border south-east to the 18th parallel and exhibits a series of snow-crowned peaks, notably the triple-crested Illampu or Sorata (21,490 ft.), Illimani (Conway, 21,204), Cacaaca (20,571) and Chacacomani (21,434). Of the ranges extending south from the Cordillera Real and branching out between the 18th and 19th parallels, the more prominent are the Frailes which forms the eastern rampart of the great central plateau and which is celebrated for its mineral deposits, the Chichas which runs south from the vicinity of Potosí to the Argentine frontier, and the Livichuco which turns south-east and forms the watershed between the Cachimayo and Pilcomayo. The more prominent peaks in and between these ranges are the Asanaque (16,857), Michaga (17,389), Cuzco (19,930), Potosí (15,381), Chorolque (18,480) and Tulumá (15,584). At the southern extremity of the great plateau is the transverse Serranía de Lipez, the culminating crest of which stands 16,404 ft. above sea-level. The eastern rampart of the Bolivian highlands comprises two distinct chains—the Sierra de Cochabamba on the north-east and the Sierra de Misiones on the east. Between these and the Cordillera Oriental is an apparently confused mass of broken, intersecting ranges, which on closer examination are found to conform more or less closely to the two outside ranges. These have been deeply cut by rivers, especially on the north-east, where the rainfall is heavier. The region enclosed by these ranges is extremely rugged in character, but it is esteemed highly for its fertile valleys and its fine climate, and is called the "Bolivian Switzerland." Lying wholly within the tropics, these mountain masses form one of the most interesting as well as one of the most imposing and difficult regions of the world. At their feet and in their lower valleys the heat is intense and the vegetation is tropical. Above these are cool, temperate slopes and valleys, and high above these, bleak, wind-swept passes and snowclad

peaks. West of the Cordillera Oriental, where special conditions prevail, a great desert plateau stretches entirely across one corner of the republic. Apart from the Andean system there is a group of low, broken, gneiss ranges stretching along the east side of Bolivia among the upper affluents of the Mamoré and Guaporé, which appear to belong to the older Brazilian orographic system, from which they have been separated by the erosive action of water. They are known as the Sierras de Chiquitos, and are geologically interesting because of their proximity to the eastern projection of the Andes. Their culminating point is Cerro Cochii, 3894 ft. above sea-level, but for the most part they are but little more than ranges of low wooded hills, having in general a north-west and south-east direction between the 15th and 19th parallels.

The popular conception of Bolivia is that of an extremely rugged mountainous country, although fully three-fifths of it, including the Chiquitos region, is composed of low alluvial plains, great swamps and flooded bottomlands, and gently undulating forest regions. In the extreme south are the Bolivian Chaco and the llanos (open grassy plains) of Manzo, while above these in eastern Chuquisaca and southern Santa Cruz are extensive swamps and low-lying plains, subject to periodical inundations and of little value for agricultural and pastoral purposes. There are considerable areas in this part of Bolivia, however, which lie above the floods and afford rich grazing lands. The great drawback to this region is defective drainage; the streams have too sluggish a current to carry off the water in the rainy season. Between the Chiquitos sierras and the Andes are the Llanos de Chiquitos, which have a higher general elevation and a more diversified surface. North of this elevation, which formed the southern shore of the ancient Mojos Lake, are the llanos of Guarayos and Mojos, occupying an extensive region traversed by the Guaporé, San Miguel, Guapay, Mamoré, Yacuma, Beni and Madre de Dios rivers and their numerous tributaries. It was once covered by the great Mojos Lake, and still contains large undrained areas, like that of Lake Rojoagua (or Roguaguado). It contains rich agricultural districts and extensive open plains where cattle-raising has been successfully followed since the days of the Jesuit missions in that region. The lower slopes of the Andes, especially toward the north-west, where the country is traversed by the Beni and Madre de Dios, are covered with heavy forests. This is one of the richest districts of Bolivia and is capable of sustaining a large population.

The river-systems of Bolivia fall naturally into three distinct regions—the Amazon, La Plata and Central Plateau. The first includes the rivers flowing directly and indirectly into the Madeira, one of the great tributaries of the Amazon, together with some small tributaries of the Acaré and Purús in the north, all of which form a drainage basin covering more than one-half of the republic. The two principal rivers of this system are the Mamoré and Beni, which unite in lat. 10° 20' S. to form the Madeira. The Mamoré, the upper part of which is called the Chimoré, rises on the north-east slopes of the Sierra de Cochabamba a little south of the 17th parallel, and follows a northerly serpentine course to its confluence with the Beni, the greater part of which course is between the 65th and 66th meridians. The river has a length of about 600 m., fully three-fourths of which, from Chimoré (925 ft. above sea level) to the rapids near its mouth, passes across a level plain and is navigable. The principal Bolivian tributary of the Mamoré, the Guapay or Grande, which is larger and longer than the former above their confluence and should be considered the main stream, rises in the Cordillera Oriental east of Lake Pampa Aullagas, and flows east to the north extremity of the Sierra de Misiones, where it emerges upon the Bolivian lowlands. Turning to the north in a magnificent curve, it passes around the south-east extremity of the Sierra de Cochabamba, skirts the Llanos de Chiquitos, and, turning to the north-west, unites with the Mamoré at Junta de los Ríos in about 15° 20' S. lat. and 64° 40' W. long. It has a tortuous course of over 700 m., which is described as not navigable. The principal tributaries of the Guapay are the Mizque, Piray or Sará and Yapacani, the last rising on the east slopes of the

Cordillera Real, flowing east by Cochabamba to the sierras of that name where it breaks through with a great bend to the north. The other large Bolivian tributaries of the Mamoré, all rising on the north-east flanks of the Andes, are the Chaparé, Sécure, Manique or Aperé and Yacuma, the last draining a region of lakes and swamps north of the Sierra Chamaya. The Beni and its great affluent, the Madre de Dios, though of smaller volume and extent than the Mamoré, are of much greater economic importance, owing to their navigability, the fertility of the region they drain, and the great forests along their banks. North of the Beni, the Abuna flows into the Madeira. Several of its south tributaries belong to Bolivia. The Guaporé, or Iteaz, an affluent of the Mamoré, is the third large river of the Bolivian drainage basin, but it rises in Brazil, on the south slopes of the Sierra dos Parecis, where it flows in a great bend to the south and then west of north to the Bolivian frontier in 14° S. lat. From this point to its junction with the Mamoré, a little north of the 12th parallel, it flows in a north-westerly direction and forms the boundary line between the two republics. Its Brazilian tributaries are comparatively unimportant, but from Bolivia it receives the Baures and the San Miguel, both rising in the Sierras de Chiquitos and flowing north-west across the llanos to the Guaporé. The Baures has one large tributary, the Blanco, and the Itonama (San Miguel) has its origin in Lake Concepción, lying among the west ranges of the Chiquitos mountains 952 ft. above sea-level.

The south-east drainage basin, which is smaller and economically less important than that of the Madeira, discharges into the Paraguay and extends from the Sierras de Chiquitos south to the Argentine frontier, and from the Cordillera Oriental east to the Paraguay. It possesses only one large river in Bolivia, the Pilcomayo, which rises on the east slopes of the Cordillera Oriental opposite the south end of Lake Pampa Aullaguas and flows east and south-east through the sierra region to the Bolivian Chaco. It flows through a nearly level country with so sluggish a current that its channels are greatly obstructed. Nothing definite is known of its tributaries in the Chaco, but in the sierra region it possesses a number of small tributaries, the largest of which are the Cachimayo, Mataca and Playas or Camblaya, the latter formed by the Cotagaita and San Juan. The Bermejo, which is an Argentine river, receives one large tributary from the Bolivian uplands, the Tarija or Rio Grande, which drains a small district south-east of the Santa Victoria sierra. The Bolivian tributaries of the upper Paraguay are small and unimportant. The Otquis, the most southern of the group, is formed by the San Rafael and Tucabaca, which drain both slopes of the Cerro Cochii range; but is lost in some great marshes 50 m. from the Paraguay. Another considerable stream of this region, which is lost in the great marshy districts of the Bolivian plain, is the Parapiti, which rises on the eastern slopes of the Sierra de Misiones and flows north-east through a low plain for about 150 m. until lost.

The third drainage basin is that of the great central plateau, or *alta-planicie*. This is one of the most elevated lacustrine basins in the world, and though it once drained eastward, now has no surface outlet. Lake Titicaca receives the waters of several short streams from the neighbouring heights and discharges through the Desaguadero, a sluggish river flowing south for 184 m. with a gradually diminishing depth to Lake Pampa Aullaguas or Poopo. The Desaguadero is navigable for small craft, and has two or three small tributaries from the west. Two small streams empty into Lake Pampa Aullaguas, which has a small outlet in the Lacadahuiria flowing west for 60 m. to the Cenogas de (salt-swamps of) Coipasa. The drainage of this extensive district seems to be wholly absorbed by the dry soil of the desert and by evaporation. In the extreme south the Rio Grande de Lipéz is absorbed in the same way.

Few of the Bolivian lakes are at all well known. The great lacustrine basin between the Beni and the Mamoré contains several lakes and lagoons, two of them of large size. These are Lake Rogagua whose waters find their way into the Beni through Rio Negro, and the Roguaguado lagoon and marshes which

cover a large area of territory near the Mamoré. The latter has an elevation little, if any, above the level of the Mamoré, which apparently drains this region, and its area has been estimated at about 580 sq. m. Lake Concepción, in the Chiquitos mountains, belongs to this same hydrographic area. In the south-east there are several large shallow lakes whose character and size change with the season. They fill slight depressions and are caused by defective drainage. Near the Paraguay there are several of these lakes, partly caused by obstructed outlets, such as Bahia Negra, Cáceres, Mandioré, Gaiba and Uberaba, some of them of sufficient depth to be navigable by small craft. Above the latter are the great Xarayes swamps, sometimes described as a lake. This region, like that of the north, is subject to periodical inundations in the summer months (November-March or even May), when extensive areas of level country are flooded and traffic is possible only by the use of boats. The two principal lakes of the plateau region are Titicaca and Pampa Aullaguas or Poopo. The former lies near the north end of the great Bolivian *alta-planicie*, 12,644 ft. above sea-level, being one of the most elevated lakes of the world. It is indented with numerous bays and coves; its greatest length is 138 m., and its greatest breadth 69 m. According to a survey made by Dr M. Neveau-Lemaire (*La Géographie*, ix. p. 409, Paris, 1904), its water surface, excluding islands and peninsulas, is 1969 sq. m., and its greatest depth is 892 ft. The level of the lake rises about 5 in. in summer; the loss in winter is even greater. The lake belongs to both Bolivia and Peru, and is navigated by steamers running between Bolivian ports and the Peruvian railway port of Puno. The outlet of the lake is through the Desaguadero river. It has several islands, the largest of which bears the same name and contains highly interesting archaeological monuments of a prehistoric civilization usually attributed to the Incas. Lake Pampa Aullaguas or Poopo is about 180 m. south-east of Titicaca, and is fed principally by its outflow. It lies 505 ft. below the level of Titicaca, which gives an average fall for the Desaguadero of very nearly 2½ ft. per mile. The Pampa Aullaguas has an estimated area of 386 sq. m., and has one large inhabited island. The lake is shallow and the district about it is sparsely populated. Its outlet is through the Lacadahuiria river into the Coipasa swamp, and it is estimated that the outflow is much less than the inflow, showing a considerable loss by evaporation and earth absorption.

Having no sea-coast, Bolivia has no seaport except what may be granted in usufruct by Chile.

Geology.—The eastern ranges of the Bolivian Andes are formed of Palaeozoic rocks with granitic and other intrusions; the Western Cordillera consists chiefly of Jurassic and Cretaceous beds, together with the lavas and ashes of the great volcanoes; while the intervening plateau is covered by freshwater and terrestrial deposits through which rise ridges of Palaeozoic rock and of a series of red sandstones and gypsiferous marls of somewhat uncertain age (probably, in part at least, Cretaceous). The Palaeozoic beds have yielded fossils of Cambrian, Ordovician, Devonian and Carboniferous age. In southern Bolivia Cambrian and Ordovician beds form the greater part of the eastern Andes, but farther north the Devonian and Carboniferous are extensively developed, especially in the north-eastern ranges. The hills, known as the Chiquitos, which rise from the plains of eastern Bolivia, are composed of ancient sedimentary rocks of unknown age. The Palaeozoic beds are directly overlaid by a series of red sandstones and gypsiferous marls, similar to the *formacion petrolifera* of Argentina and Brazil. At the base there is frequently a conglomerate or tuff of porphyritic rocks. Marine fossils found by Gustav Steinmann in the middle of the series are said to indicate an age not earlier than the Jurassic, and Steinmann refers them to the Lower Cretaceous. It is, however, not improbable that the series may represent more than one geological system. No later marine deposits have been found either in the eastern Andes or in the plains of Bolivia, but freshwater beds of Tertiary and later date occupy a wide area. The recent deposits, which cover so large a part of the depression between the Eastern and the Western Cordillera, appear to be partly of torrential origin, like the talus-fans at the foot of mountain ranges in other dry regions; but Lakes Titicaca and Pampa Aullaguas (Poopo) were undoubtedly at one time rather more extensive than they are to-day. The volcanoes of Bolivia lie almost entirely in the Western Cordillera—the great summits of the eastern range, such as Illimani and Sorata, being formed of Palaeozoic rocks with granitic and other intrusions. The gold, silver and tin of Bolivia occur chiefly in the Palaeozoic rocks of the eastern ranges. The copper belongs mostly to the red sandstone series.

Climate.—Bolivia lies wholly within the torrid zone, and variations in temperature are therefore due to elevation, mountain barriers and prevailing winds. The country possesses every gradation of temperature, from that of the tropical lowlands to the Arctic cold of the snow-capped peaks directly above. The vertical arrangement of climatic zones is modified to some extent (less than in Argentina) by varying rainfall conditions, which are governed by the high mountain ranges crossing one after another of the republic, and also by the prevailing winds. The trade winds give to S. Bolivia a wet and dry season similar to that of N. Argentina. Farther north, and east of the Cordillera Oriental, rains fall throughout the year, though the summer months (November–March) are usually described as the rainy season. On the west side of the Cordillera, which extracts the moisture from the prevailing easterly winds, the elevated plateaus receive a limited rainfall in the north, which diminishes toward the south until the surface becomes absolutely barren. Brief and violent rain-storms sometimes sweep the northern plateau, but these are not frequent and occur during a short season only. Cyclonic wind storms are frequent in these high altitudes.

Bolivia has a wide range of temperature between places of the same latitude. The natives designate the Bolivian climatic zones as *seas, valle or medio yungas, cabecera de valle, puna* and *puna brava*. The *yungas* comprises all the lowlands and the mountain valleys to an elevation of 5,000 ft. The temperature is tropical, winter unknown and the atmosphere is exceedingly humid. The mean temperature, according to official estimates, is 70° F., but this probably represents the average between the higher elevations and the low country. The *valle* zone includes the deep valleys from 5,000 to 10,000 ft., has a warm climate with moderate variations in temperature, but is no cold weather, is sub-tropical in character and productions, and is sometimes described as a region of perpetual summer. The *cabecera de valle*, as the name indicates, includes the heads of the mountain valleys above the *valle* zone, with elevations ranging from 10,000 to 11,000 ft.; its climate is temperate, is divided into regular seasons, and is favourable to the production of cereals and vegetables. The *puna*, which lies between 11,000 and 12,500 ft., includes the high central plateau of Bolivia. It has but two seasons, a cold winter and autumn and winter. The air is cold and dry, and the summer season is too short for the production of anything but potatoes and barley. The mean temperature is officially estimated at 54° F. The *puna brava* extends from 12,500 ft. up to the snow line (about 17,500 ft.), and covers a bleak, inhospitable territory, inhabited only by shepherds and miners. Above this is the region of eternal snow, an Arctic zone within the tropics. In general, the sub-tropical (*valle*) and temperate (*cabecera de valle*) regions of Bolivia are healthy and agreeable, have a plentiful rainfall, moderate temperature in the shade, and varied and abundant productions. There is a high rate of mortality among the natives, due to sanitary habits and diet, and not to the climate. In the tropical *seas* the ground is covered with decaying vegetation, and malaria fevers are common. There are localities in the open country on exposed elevations where healthy conditions prevail, but the latter part of this region is considered unhealthy. The prevailing winds are easterly, bringing moisture across Brazil from the Atlantic; eastern Bolivia is also exposed to hot, oppressive winds from the north, and to violent cold winds (*surasos*) from the Argentine plains, which have been known to cause a fall of temperature of 36° within 24 hours. According to the *Sinópsis Estadística y Geográfica de la República de Bolivia* (La Paz, 1903), the average mean temperature for the annual rainfall in eastern Bolivia are as follows: 10° S. lat., 8° F. and 31.5 in. rainfall; 15° S. lat., 86° F. and 30.7 in. rainfall; 20° S. lat., 81° F. and 30 in. rainfall; and 25° S. lat., 76.8° F. and 3 in. rainfall.

Fauna.—The indigenous fauna of Bolivia corresponds closely that of the neighbouring districts of Argentina, Brazil and Peru. Numerous species of monkeys inhabit the forests of the tropical region, together with the puma, jaguar, wildcat, coati, bear, or *onca*, sloth, ant-bear, paca (*Coelogenys paca*) and capybara. A rare species of bear, the *Ursus ornatus* (spectacled bear) found among the wooded Andean foothills. The chinchilla (*laniger*), also found in northern Argentina and Chile, inhabits the colder plateau regions and is prized for its fur. The plateaus of the viscachas (*Lagidium cuvieri*) and the widely distributed South American otter (*Lutra paraguayensis*) are also noted for their skins. The peccary, which prefers a partially open country, ranges from the Chaco to the densely wooded districts of the north. There are two or three species of deer, the most common being the large marsh deer of the Chaco; but the deer are not numerous. The armadillo, opossum, ferret and skunk

are widely distributed. The amphibia are well represented throughout the lower tropical districts. Alligators are found in the tributaries of the Paraguay and their lagoons, lizards and turtles are numerous, and the batrachians are represented by several species. Snakes are also numerous, including rattlesnakes and the great boa-constrictors of the Amazon region.

The most interesting of all the Bolivian animals, however, are the guanaco (*Auchenia huanaco*) and its congeners, the llama (*A. lama*), alpaca (*A. pacos*) and vicuña (*A. vicugna*), belonging to the Camelidae, with the structure and habits of the African camel, but smaller, having no hump, and inhabiting a mountainous and not a level sandy region. They are able to go without food and drink for long periods, and inhabit the arid and semi-arid plateaus of the Andes and the steppes of Patagonia. The guanaco is supposed to be the original type, is the largest of the four, and has the greatest range from Peru to Tierra del Fuego. The llama and alpaca were domesticated long before the discovery of America, but the guanaco and vicuña are found in a wild state only. The llama is used as a pack animal in Bolivia and Peru, and its coarse wool is used in the making of garments for the natives. The alpaca is highly prized for its fine wool, which is a staple export from Bolivia, but the animal is reared with difficulty and the product cannot be largely increased. The vicuña also is celebrated for its wool, which the natives weave into beautiful and costly ponchos (blanket cloaks) and other wearing apparel. The guanaco is hunted for its skin, which, when dressed, makes an attractive rug or robe. The slaughter of the guanaco and vicuña is rapidly diminishing their number. The rearing of llamas and alpacas is a recognized industry in the Bolivian highlands and is wholly in the hands of the Indians, who alone seem to understand the habits and peculiarities of these interesting animals.

Of birds and insects the genera and species are very numerous and interesting. The high sierras are frequented by condors and eagles of the largest size, and the whole country by the common vulture, while the American ostrich (*Rhea americana*) and a species of large stork (the *bata* or *jabura*, *Megascia americana*; maximum height, 8 ft.; spread of wings, 8 ft. 6 in.) inhabit the tropical plains and valleys. Waterfowl are numerous and the forests of the warm valleys are filled with song-birds and birds of beautiful plumage. Many species of humming-birds are found even far up in the mountains, and great numbers of parrots, araras and toucans, beautiful of feather but harsh of voice, enliven the forests of the lowlands.

Like other South American states, Bolivia benefited greatly from the introduction of European animals. Horses, cattle, sheep, goats, swine and poultry were introduced, and are now sources of food and wealth to a large part of the population. Mules are used to a large extent as pack animals, but they are imported from Argentina. Silkworms have been bred with success in some departments, and the cochineal insect is found wherever the conditions are favourable for the cactus.

Flora.—Owing to the diversities in altitude the flora of Bolivia represents every climatic zone, from the scanty Arctic vegetation of the lofty Cordilleras to the luxuriant tropical forests of the Amazon basin. Between these extremes the diversity in vegetable life is as great as that of climate and soil. The flora of Bolivia has been studied less than the flora of the neighbouring republics, however, because of the inaccessibility of these inland regions. Among the more important productions, the potato, coca (*Oxalis tuberosa*), quinoa (*Chenopodium quinoa*) and some coarse grasses characterize the puna region, while barley, an exotic, is widely grown for fodder. Indian corn was cultivated in the temperate and warm regions long before the advent of Europeans, who introduced wheat, rye, oats, beans, peas and the fruits and vegetables of the Old World, for each of which a favourable soil and climate was easily found. In the sub-tropical and tropical zones the indigenous plants are the sweet potato, cassava (*Manihot utilissima* and *M. aipi*), peanuts, pineapple, guava, chirimoya (*Annona cherimolia*), pawpaw (*Carica papaya*), ipecacuanha (*Cephaelis*), sarsaparilla, vanilla, false jalap (*Mirabilis jalapa*), copaiba, tolu (*Myrcosylon tolimiferum*),

rubber-producing trees, dyewoods, cotton and a great number of beautiful hardwoods, such as jacarandá, mahogany, rosewood, quebracho, oco, cedar, walnut, &c. Among the fruits many of the most common are exotics, as the orange, lemon, lime, fig, date, grape, &c., while others, as the banana, cajú or cashew (*Ancardium occidentale*) and aguacate avocado or alligator pear, have a disputed origin. Coca, one of the most important plants of the country, is cultivated on the eastern slopes of the Andes at an altitude of 5000 to 6000 ft., where the temperature is uniform and frosts are unknown. Quina or calisaya is a natural product of the eastern Andes, and is found at an altitude of 3000 to 9000 ft. above sea-level. The calisaya trees of Bolivia rank among the best, and their bark forms an important item in her foreign trade. The destructive methods of collecting the bark are steadily diminishing the natural sources of supply, and experiments in cinchona cultivation were undertaken during the last quarter of the 19th century, with fair prospects of success. The most important of the indigenous forest products, however, is rubber, derived principally from the *Hevea guayanensis* (var. *brasilensis*), growing along the river courses in the *yungas* regions of the north, though *manicoba* rubber is also obtained from *Mesquit Glaziovii* on the drier uplands. Among the exotics, sugar-cane, rice and tobacco are cultivated in the warm districts.

Population.—The population of Bolivia is composed of Indians, Caucasians of European origin, and a mixture of the two races, generally described as *mestizos*. There is also a very small percentage of Africans, descendants of the negro slaves introduced in colonial times. A roughly-taken census of 1900 gives the total population as 1,816,271, including the Litoral department, now belonging to Chile (49,820), and estimates the number of wild Indians of the forest regions at 91,000. Of this total, 50.7% were classed as Indians, 12.8% as whites, 26.8% as *mestizos*, 0.3% as negroes, and 9.4% as unknown. In 1904 an official estimate made the population 2,181,415, also including the Litoral (59,784), but of course all census returns and estimates in such a country are subject to many allowances. The Indian population (920,860) is largely composed of the so-called civilized tribes of the Andes, which once formed part of the nationality ruled by the Incas, and of those of the Mojos and Chiquitos regions, which were organized into industrial communities by the Jesuits in the 17th century. The former, which are chiefly Aymará south of the latitude of Lake Titicaca, attained a considerable degree of civilization before the discovery of America and have been in closer contact with Europeans than the other tribes of Bolivia. It is doubtful, however, whether their condition has been improved under these influences. The Mojos and Chiquitos tribes, also, have been less prosperous since the expulsion of the Jesuits, but they have remained together in organized communities, and have followed the industries and preserved the religion taught them as well as circumstances permitted. Both these groups of Indians are peaceable and industrious, and form an important labouring element. They are addicted to the excessive use of *chicha* (a native beer made from Indian corn), and have little or no ambition to improve their condition, but this may be attributed in part to their profound ignorance and to the state of peonage in which they are held. Inhabiting the southern part of the Bolivian plain are the Chiriguano, a detached tribe of the Guarani race which drifted westward to the vicinity of the Andes long ago. They are of a superior physical and mental type, and have made noteworthy progress toward civilization. They are agriculturists and stock-raisers and have the reputation of being peaceable and industrious. The remaining native tribes under the supervision of the state have made little progress, and their number is said to be decreasing (notwithstanding the favourable climatic conditions under which most of them live) because of unsanitary and intemperate habits, and for other causes not well understood, one being the custom

noticed by early travellers among some of the tribes of the La Plata region of avoiding the rearing of children. (See Southey's *History of Brasil*, iii. pp. 402, 673.) Of the wild Indians very little is known in regard to either numbers or customs.

The white population (231,088) is descended in great part from the early Spanish adventurers who entered the country in search of mineral wealth. To these have been added a small number of Spanish Americans from neighbouring republics and some Portuguese Americans from Brazil. There has been no direct immigration from Europe, though Europeans of various nationalities have found their way into the country and settled there as miners or traders. The percentage of whites therefore does not increase as in Argentina and Brazil, and cannot until means are found to promote European immigration.

The *mestizos* (486,018) are less numerous than the Indians, but outnumber the whites by more than two to one. It has been said of the *mestizos* elsewhere that they inherit the vices of both races and the virtues of neither. Yet, with a decreasing Indian population, and with a white population wanting in energy, barely able to hold its own and comprising only one-eighth of the total, the future of Bolivia mainly depends on them. As a rule they are ignorant, unprogressive and apathetic, intensely superstitious, cruel and intemperate, though individual strong characters have been produced. It may be that education and experience will develop the *mestizos* into a vigorous progressive nationality, but the first century of self-government can hardly be said to have given much promise of such a result.

Divisions and Towns.—The republic is divided into eight departments and one territory, and these are subdivided into 54 provinces, 415 cantons, 232 vice-cantons, 18 missions and one colony. The names, areas and populations of the departments, with their capitals, according to the census of 1900, to which corrections must be made on account of the loss of territory to Brazil in 1903, are as follows:—

Department.	Area sq. m. from Official Sources.	Population 1900. ¹	Capitals.	Population 1900.
La Paz	53,777	445,616	La Paz	54,713
El Beni	102,111	32,180	Trinidad	2,556
Oruro	19,127	86,081	Oruro	13,575
Cochabamba	23,328	328,163	Cochabamba	21,886
Santa Cruz	141,368	209,592	Santa Cruz de la Sierra	15,874
Potosí	48,801	325,615	Potosí	20,910
Chuquisaca	26,418	204,434	Sucre	20,967
Tarija	33,036	102,887	Tarija	6,980
Nat. Territory	192,260	31,883		
	640,226	1,766,451		

The total area according to Gotha computations, with corrections for loss of territory to Brazil in 1903, is 515,156 sq. m.

There are no populous towns other than the provincial capitals above enumerated. Four of these capitals—Sucre or Chuquisaca, La Paz, Cochabamba and Oruro—have served as the national capital, and Sucre was chosen, but after the revolution of 1808 the capital was at La Paz, which is the commercial metropolis and is more accessible than Sucre. Among the smaller towns prominent because of an industry or commercial position, may be mentioned the Huanchaca mining centre of Pulacayo (pop. 6512), where 3000 men are employed in the mines and surface works of this great silver mining company; Uyuni (pop. 1587), the junction of the Pulacayo branch with the Antofagasta and Oruro railway, and also the converging point for several important highways and projected railways; and Tupiza (pop. 1644), a commercial and mining centre near the Argentine frontier, and the terminus of the Argentine railway extension into Bolivia. All these towns are in the department of Potosí. Viacha (pop. 1670), a small station on the railway from Guaqui to Alto de La Paz, 14 m. from the latter, is the starting point of an important projected railway to Oruro. In the department of Cochabamba,

¹ The figures for population include a 5% addition for omissions, sundry corrections and the estimated number of wild Indians.

Tarata (4681) and Totorá (3501) are two important trading centres, and in the department of Santa Cruz, Ascensión (pop. 4784) is a large mission station in the Chiquitos hills.

Communications.—Under a treaty with Brazil in 1903 and with Chile in 1904 (ratified 1905) provisions were made for railway construction in Bolivia to bring this isolated region into more effective communication with the outside world. Brazil agreed to construct a railway around the falls of the Madeira (about 180 m. long) to give north-eastern Bolivia access to the Amazon, and paid down £2,000,000 in cash which Bolivia was to expend on railway construction within her own territory. Chile also agreed to construct a railway from Arica to La Paz, 295 m. (the Bolivian section becoming the property of Bolivia fifteen years after completion), and to pay the interest (not over 5%) which Bolivia might guarantee on the capital invested in certain interior railways if constructed within thirty years, providing these interest payments should not exceed £100,000 a year, nor exceed £1,600,000 in the aggregate. Argentina had already undertaken to extend her northern railway from Jujuy to the Bolivian frontier town of Tupiza, and the Peruvian Corporation had constructed for the Bolivian government a short line (54 m. long) from Guasqui, on Lake Titicaca, to Alto de La Paz, which is connected with the city of La Paz, 1493 ft. below, by an electric line 5 m. long. This line gives La Paz access to the Peruvian port of Mollendo, 496 m. distant, and promises in time to give it railway communication with Cuzco. Rivalry for the control of her trade, therefore, promises to give Bolivia the railways needed for the development of her resources. Up to 1903 the only railways in Bolivia were the Antofagasta and Oruro line, with a total length of 574 m., of which 350 m. are within Bolivian territory, a private branch of that line (26 m. long) running to the Pulacayo mines, and the line (54 m. long) from Guasqui to Alto de La Paz—a total of only 430 m. As a result of her war with Chile in 1878–81, the railways (282 m. long) of her Litoral department passed under Chilean control. Lines were in 1907 projected from La Paz to the navigable waters of the Beni, from La Paz to Cochabamba, from Viacha to Oruro, from Uyuni to Potosí and Sucre, from Uyuni to Tupiza, and from Arica to La Paz via Corocoro. The central northern line of the Argentine government was completed to the Bolivian frontier in 1908, and this line was designed to extend to Tupiza. The undertaking of the Arica-La Paz line by the Chilean government, also, was an important step towards the improvement of the economic situation in Bolivia. Both these lines offer the country new outlets for its products.

Public highways have been constructed between the large cities and to some points on the frontiers, and subsidized stage coaches are run on some of them. The roads are rough and at times almost impassable, however, and the river crossings difficult and dangerous. The large cities are connected with one another by telegraph lines and are in communication with the outside world through Argentina, Chile and Peru. Telegraph service dates from 1880, and in 1904 there were 3115 m. in operation, of which 1036 belonged to the state and 1179 to private corporations. The latter includes the lines belonging to the Antofagasta and Oruro railway, which are partly within Chilean territory. Bolivia is a member of the International Postal Union, and has parcel and money order conventions with some foreign countries. Special agreements have been made, also, with Argentina, Chile and Peru for the transmission of the Bolivian foreign mails.

The loss of her maritime department has left Bolivia with no other ports than those of Lake Titicaca (especially Guasqui, or Huasqui, which trades with the Peruvian port of Puno), and those of the Madeira and Paraguay rivers and their affluents. As none of these can be reached without transhipment in foreign territory, the cost of transport is increased, and her neighbours are enabled to exclude Bolivia from direct commercial intercourse with other nations. An exception formerly existed at Puerto Acrí, on the Acrí river, to which ocean-going steamers could ascend from Pará, but Brazil first closed the Purús and Acrí rivers to foreign vessels seeking this port, and then under a treaty of 1903 acquired possession of the port and adjacent

territory. Since then Bolivia's outlet to the Amazon is restricted to the Madeira river, the navigation of which is interrupted by a series of falls before Bolivian territory is reached. The Bolivian port of entry for this trade, Villa Bella, is situated above the falls of the Madeira at the confluence of the Beni and Mamoré, and is reached from the lower river by a long and costly portage. It is also shut off from the navigable rivers above by the falls of the Beni and Mamoré. The railway to be built by Brazil will remedy this unfavourable situation, will afford a better outlet for north-eastern Bolivia, and should promote a more rapid development of that region, which is covered with an admirable system of navigable rivers above the falls of the Beni and Mamoré. Connected with the upper Paraguay are Puerto Pacheco on Bahía Negra, Puerto Suarez (about 1600 m. from Buenos Aires by river), on Lake Cáceres, through which passes the bulk of Bolivian trade in that direction, and Puerto Quijarro, on Lake Gaiba, a projected port said to be more accessible than any other in this region. Whenever the trade of southern Bolivia becomes important enough to warrant the expense of opening a navigable channel in the Pilcomayo, direct river communication with Buenos Aires and Montevideo will be possible.

Industries.—Stock-raising was one of the earliest industries of the country after that of mining. Horses, formerly successfully raised in certain parts of the north, have not flourished there since the introduction of a *peste* from Brazil, but some are now raised in La Paz and other departments of the temperate region. The Jesuit founders of the Mojos missions took cattle with them when they entered that region to labour among the Indians, with the result that the Mojos and Chiquitos llanos were soon well stocked, and have since afforded an unailing supply of beef for the neighbouring inland markets. Their inaccessibility and the costs of transportation have prevented a development of the industry and a consequent improvement in stock, but the persistency of the industry under conditions so unfavourable is evidence that the soil and climate are suited to its requirements. Farther south the llanos of Chuquisaca and Tarija also sustain large herds of cattle on the more elevated districts, and on the well-watered plains of the Chaco. There are small districts in La Paz, Potosí and Cochabamba, also, where cattle are raised. Apart from the cattle driven into the mining districts for consumption, a number of *saladeros* are employed in preparing (usually salting and sun-drying) beef for the home markets. The hides are exported. Goats are raised in the warm and temperate regions, and sheep for their wool in the latter. On the higher and colder plateaus much attention is given to the breeding of llamas and alpacas. Another industry of a different character is that of breeding the fur-bearing chinchilla (*C. laniger*), which is a native of the higher plateaus. The Bolivian government has prohibited the exportation of the live animals and is encouraging their production.

The agricultural resources of the republic are varied and of great value, but their development has been slow and hesitating. The cultivation of cereals, fruits and vegetables in the temperate and warm valleys of the Andes followed closely the mining settlements. Sugar-cane also was introduced at an early date, but as the demand for sugar was limited the product was devoted chiefly to the manufacture of rum, which is the principal object of cane cultivation in Bolivia to-day. The climatic conditions are highly favourable for this product in eastern Bolivia, but it is heavily taxed and is restricted to a small home market. Rice is another exotic grown in the tropical districts of eastern Bolivia, but the quantity produced is far from sufficient to meet local requirements. Tobacco of a fair quality is produced in the warm regions of the east, including the *ynagas* valleys of La Paz and Cochabamba; cacao of a superior grade is grown in the department of Beni, where large orchards were planted at the missions, and also in the warm Andean valleys of La Paz and Cochabamba; and coffee of the best flavour is grown in some of the warmer districts of the eastern Andes. The two indigenous products which receive most attention, perhaps, are those of quinoa and coca. Quinoa is grown in large quantities, and is a staple article of food among the natives. Coca is highly

esteemed by the natives, who masticate the leaf, and is also an article of export for medicinal purposes. It is extensively cultivated in the departments of Cochabamba and La Paz, especially in the province of Yungas.

In the exploitation of her forest products, however, are to be found the industries that yield the greatest immediate profit to Bolivia. The most prominent and profitable of these is that of rubber-collecting, which was begun in Bolivia between 1880 and 1890, and which reached a registered annual output of nearly 350 metric tons just before Bolivia's best rubber forests were transferred to Brazil in 1903. There still remain extensive areas of forest on the Beni and Madre de Dios in which the rubber-producing *Hevea* is to be found. Although representing less value in the aggregate, the collecting of cinchona bark is one of the oldest forest industries of Bolivia, which is said still to have large areas of virgin forest to draw upon. The Bolivian product is of the best because of the high percentage of quinine sulphate which it yields. The industry is destructive in method, and the area of cinchona forests is steadily diminishing. Many other Bolivian plants are commercially valuable, and organized industry and trade in them will certainly be profitable.

The industrial activities of the Bolivian people are still of a very primitive character. An act was passed in 1894 authorizing the government to offer premiums and grant advantageous concessions for the development of manufacturing industries, especially in sugar production, but conditions have not been favourable and the results have been disappointing. Spinning and weaving are carried on among the people as a household occupation, and fabrics are made of an exceptionally substantial character. It is not uncommon to see the natives busily twirling their rude spindles as they follow their troops of pack animals over rough mountain roads, and the yarn produced is woven into cloth in their own houses on rough Spanish looms of colonial patterns. Not only is coarse cloth for their own garments made in this manner from the fleece of the llama, but cotton and woollen goods of a serviceable character are manufactured, and still finer fabrics are woven from the wool of the alpaca and vicuña, sometimes mixed with silk or lamb's wool. The Indian women are expert weavers, and their handiwork often commands high prices. In the Mojos and Chiquitos districts the natives were taught by the Jesuit missionaries to weave an excellent cotton cloth, and the industry still exists. Cashmere, baize, waterproof *ponchos* of fine wool and silk, and many other fabrics are made by the Indians of the Andean departments. They are skilled in the use of dyes, and the Indian women pride themselves on a large number of finely-woven, brilliantly-coloured petticoats. Tanning and saddlery are carried on by the natives with primitive methods, but with excellent results. They are skilful in the preparation of lap robes and rugs from the skins of the alpaca and vicuña. The home markets are supplied, by native industry, with cigars and cigarettes, soap, candles, hats, gloves, starch, cheese and pottery. Sugar is still made in the old way, and there is a small production of wine and silk in certain districts. No country is better supplied with water power, and electric lighting and electric power plants have been established at La Paz.

Commerce.—The foreign trade of Bolivia is comparatively unimportant, but the statistical returns are incomplete and unsatisfactory; the imports of 1904 aggregated only £1,734,551 in value, and the exports only £1,851,758. The imports consisted of cottons, woollens, live-stock, provisions, hardware and machinery, wines, spirits and clothing. The principal exports were (in 1903) silver and its ores (£636,743), tin and its ores (£1,039,298), copper ores (£157,609), bismuth (£16,354), other minerals (£20,948), rubber (£260,559), coca (£28,907), and cinchona (£9197)—total exports, £2,453,638. These figures, however, do not correctly represent the aggregates of Bolivian trade, as her imports and exports passing through Antofagasta, Arica and Mollendo are to a large extent credited to Chile and Peru. The import trade of Bolivia is restricted by the poverty of the people. The geographical position limits the exports to mineral, forest and some pastoral products, owing to cost of transportation and the tariffs of neighbouring countries.

Government.—The government of Bolivia is a "unitarian" or centralized republic, representative in form, but autocratic in some important particulars. The constitution in force (1908) was adopted on the 28th of October 1880, and is a model in form and profession. The executive branch of the government is presided over by a president and two vice-presidents, who are elected by direct popular vote for a period of four years, and are not eligible for re-election for the next succeeding term. The president is assisted by a cabinet of five ministers of state, viz.: foreign relations and worship; finance and industry; interior and fomento; justice and public instruction; war and colonization. Every executive act must be countersigned by a minister of state, who is held responsible for its character and enforcement, and may be prosecuted before the supreme court for its illegality and effects. The legislative branch is represented by a national congress of two houses—a Senate and Chamber of Deputies. The Senate is composed of 16 members, two from each department, who are elected by direct popular vote for a period of six years, one-third retiring every two years. The Chamber of Deputies is composed of 72 members, who are elected for a period of four years, one-half retiring every two years. In impeachment trials the Chamber prosecutes and the Senate sits as a court, as in the United States. One of the duties of the Chamber is to elect the justices of the supreme court. Congress meets annually and its sessions are for sixty days, which may be extended to ninety days. The chambers have separate and concurrent powers defined by the constitution. The right of suffrage is exercised by all male citizens, twenty-one years of age, or over, if single, and eighteen years, or over, if married, who can read and write, and own real estate or have an income of 200 bolivianos a year, said income not to be compensation for services as a servant. The electoral body is therefore small, and is under the control of a political oligarchy which practically rules the country, no matter which party is in power.

The Bolivian judiciary consists of a national supreme court, eight superior district courts, lower district courts, and *jugados de instrucción* for the investigation and preparation of cases. The *corregidores* and *alcaldes* also exercise the functions of a justice of the peace in the cantons and rural districts. The supreme court is composed of seven justices elected by the Chamber of Deputies from lists of three names for each seat sent in by the Senate. A justice can be removed only by impeachment proceedings before the Senate.

The supreme administration in each department is vested in a prefect appointed by and responsible solely to the president. As the prefect has the appointment of subordinate department officials, including the *alcaldes*, the authority of the national executive reaches every hamlet in the republic, and may easily become autocratic. There are no legislative assemblies in the departments, and their government rests with the national executive and congress. Subordinate to the prefects are the sub-prefects in the provinces, the *corregidores* in the cantons and the *alcaldes* in the rural districts—all appointed officials. The national territory adjacent to Brazil and Peru is governed by two *delegados nacionales*, appointees of the president. The department capitals are provided with municipal councils which have jurisdiction over certain local affairs, and over the construction and maintenance of some of the highways.

Army.—The military forces of the republic in 1905 included 2890 regulars and an enrolled force of 80,000 men, divided into a first reserve of 30,000, a second reserve of 40,000, and 10,000 territorial guards. The enrolled force is, however, both unorganized and unarmed. The strength of the army is fixed in each year's budget. That for 1903 consisted of 2933 officers and men, of which 275 were commissioned and 558 non-commissioned officers, 181 musicians, and only 1906 rank and file. A conscription law of 1894 provides for a compulsory military service between the ages of twenty-one and fifty years, with two years' actual service in the regulars for those between twenty-one and twenty-five, but the law is practically a dead letter. There is a military school with 60 cadets, and an arsenal at La Paz.

Education.—Although Bolivia has a free and compulsory school system, education and the provision for education have made little progress. Only a small percentage of the people can read and write. Although Spanish is the language of the dominant minority, Quichua, Aymará and Guarani are the languages of the natives, who form a majority of the population. A considerable percentage of the Indians do not understand Spanish at all, and they even resist every effort to force it upon them. Even the *cholos* (mestizos) are more familiar with the native idioms than with Spanish, as is the case in some parts of Argentina and Paraguay. According to official estimates for 1901, the total number of primary schools in the republic was 733, with 938 teachers and 41,587 pupils—the total cost of their maintenance being estimated at 585,365 bolivianos, or only 14.07 bolivianos per pupil (about £1:4:6). The school enrolment was only one in 43.7 of population, compared with one in 10 for Argentina. The schools are largely under the control of the municipalities, though nearly half of them are maintained by the national government, by the Church and by private means. There were in the same year 13 institutions of secondary and 14 of superior instruction. The latter include so-called universities at Sucre (Chuquisaca), La Paz, Cochabamba, Tarija, Potosi, Santa Cruz and Oruro—all of which give instruction in law, the first three in medicine and the first four in theology. The university at Sucre, which dates from colonial times, and that at La Paz, are the only ones on the list sufficiently well equipped to merit the title. Secondary instruction is under the control of the universities, and public instruction in general is under the direction of a cabinet minister. All educational matters, however, are practically under the supervision of the Church. The total appropriation for educational purposes in 1901 was 756,943 bolivianos, or £66,232:6s. There are a military academy at La Paz, an agricultural school at Umala in the department of La Paz, a mining and civil engineering school at Oruro, commercial schools at Sucre and Trinidad, and several mission schools under the direction of religious orders.

Religion.—The constitution of Bolivia, art. 2, defines the attitude of the republic toward the Church in the following words:—"The state recognizes and supports the Roman Apostolic Catholic religion, the public exercise of any other worship being prohibited, except in the colonies where it is tolerated." This toleration is tacitly extended to resident foreigners belonging to other religious sects. The census of 1900 enumerated the Roman Catholic population at 1,609,365, and that of other creeds at 24,245, which gives the former 985 and the latter 15 in every thousand. The domesticated Indians profess the Roman Catholic faith, but it is tinged with the superstitions of their ancestors. They hold the clergy in great fear and reverence, however, and are deeply influenced by the forms and ceremonies of the church, which have changed little since the first Spanish settlements. Bolivia is divided into an archbishopric and three bishoprics. The first includes the departments of Chuquisaca, Oruro, Potosi, Tarija and the Chilean province of Antofagasta, with its seat at Sucre, and is known as the archbishopric of La Plata. The sees of the three bishoprics are La Paz, Cochabamba and Santa Cruz. Mission work among the Indians is entrusted to the *Propaganda Fide*, which has five colleges and a large number of missions, and receives a small subvention from the state. It is estimated that these missions have charge of fully 20,000 Indians. The annual appropriation for the Church is about £17,150. The religious orders, which have never been suppressed in Bolivia, maintain several convents.

Finance.—No itemized returns of receipts and expenditures are ever published, and the estimates presented to congress by the cabinet ministers furnish the only source from which information can be drawn. The expenditures are not large, and taxation is not considered heavy. The estimated revenues and expenditures for 1904 and 1905 at 21 pence per boliviano, were as follows: 1904, revenue £632,773:15s., expenditure £748,571:10s.; 1905, revenue £693,763:17:6, expenditure £828,937:19:9. The revenues are derived principally from duties and fees on imports, excise taxes on spirits, wines, tobacco

and sugar, general, mining taxes and export duties on minerals (except silver), export duties on rubber and coca, taxes on the profits of stock companies, fees for licences and patents, stamp taxes, and postal and telegraph revenues. Nominally, the import duties are moderate, so much so that Bolivia is sometimes called a "free-trade country," but this is a misnomer, for in addition to the schedule rates of 10 to 40% *ad valorem* on imports, there are a consular fee of 1% for the registration of invoices exceeding 200 bolivianos, a consumption tax of 10 centavos per quintal (46 kilogrammes), fees for visiting certificates to accompany merchandise in transit, special "octroi" taxes on certain kinds of merchandise controlled by monopolies (spirits, tobacco, &c.), and the import and consumption taxes levied by the departments and municipalities. The expenditures are chiefly for official salaries, subsidies, public works, church and mission support, justice, public instruction, military expenses, and interest on the public debt. The appropriations for 1905 were as follows: war, 2,081,119 bolivianos; finance and industry, 1,462,259; government and fomento, 2,021,428; justice and public instruction, 1,878,941.

The acknowledged public debt of the country is comparatively small. At the close of the war with Chile there was an indemnity debt due to citizens of that republic of 6,550,830 bolivianos, which had been nearly liquidated in 1904 when Chile took over the unpaid balance. This was Bolivia's only foreign debt. In 1905 her internal debt, including 1,998,500 bolivianos of treasury bills, amounted to 6,243,270 bolivianos (£546,186). The government in 1903 authorized the issue of treasury notes for the department of Beni and the National Territory to the amount of one million bolivianos (£87,500), for the redemption of which 20% of the customs receipts of the two districts is set apart. The paper currency of the republic consists of bank-notes issued by four private banks, and is therefore no part of the public debt. The amount in circulation on the 30th of June 1903 was officially estimated at 9,144,254 bolivianos (£800,122), issued on a par with silver. The coinage of the country is of silver, nickel and copper. The silver coins are of the denominations of 1 boliviano, or 100 centavos, 50, 30, 10 and 5 centavos, and the issue of these coins from the Potosi mint is said to be about 1,500,000 bolivianos a year. The silver mining companies are required by law to send to the mint 20% of their product. The silver boliviano, however, is rarely seen in circulation because of the cheaper paper currency. To check the exportation of silver coin, the fractional denominations have been slightly debased. The nickel coins are of 5 and 10 centavos, and the copper 1 and 2 centavos.

The departmental revenues, which are derived from excise and land taxes, mining grants, tithes, inheritance taxes, tolls, stamp taxes, subsidies from the national treasury and other small taxes, were estimated at 2,296,172 bolivianos in 1903, and the expenditures at 2,295,791 bolivianos. The expenditures were chiefly for justice, police, public works, public instruction and the Church. The municipal revenues aggregated 2,317,670 bolivianos in 1902, and the expenditures 61,510 bolivianos in excess of that sum. These revenues are derived from a lighting tax, leases and ground rents, cemetery fees, consumption and market taxes, licences, tolls, taxes on hides and skins, personal and various minor taxes. There is a multiplication of taxes in trade which recalls the old colonial *alcabala* tax, and it serves to restrict commerce and augment the cost of goods in much the same way, if not to the same degree.

AUTHORITIES.—M. V. Ballivián, *Apuntes sobre la industria de goma elástica, &c.* (La Paz, 1896); *Noticia Política, Geográfica, Industrial, y Estadística de Bolivia* (La Paz, 1900); *Breves Indicaciones para el Emigrante y el Viajero a Bolivia* (La Paz, 1898); *Monografías de la Industria Minera en Bolivia*, three parts (La Paz, 1899-1900); *Relaciones Geográficas de Bolivia existentes en el Archivo de la Oficina Nacional de Inmigración, &c.* (La Paz, 1898); M. V. Ballivián and Eduardo Idiaquez, *Diccionario Geográfico de la República de Bolivia* (La Paz, 1900); André Bresson, *Sept années d'explorations, de voyages et de séjours dans l'Amérique australe* (Paris, 1886); Enrique Bolland, *Exploraciones practicadas en el Alto Paraguay y en la Laguna Gardo* (Buenos Aires, 1901); G. E. Church, *The Route to Bolivia via the River Amazon* (London, 1877);

G. E. Church, "Bolivia by the Rio de la Plata Route," *Geogr. Jour.* vii pp. 64-73 (London, 1902); C. B. Cisneros and R. E. Garcia, *Geografía Comercial de la América del Sur* (Lima, 1898); Sir W. M. Conway, *Climbing and Exploration in the Bolivian Andes* (London, 1903); M. Dalence, *Bosquejo estadístico de Bolivia* (Chuquisaca, 1878); J. L. Moreno, *Nociones de geografía de Bolivia* (Sucre, 1889); Edward D. Mathews, *Up the Amazon and Madeira Rivers, through Bolivia and Peru* (London, 1879); Carlos Matzenauer, *Bolivia in historischer, geographischer und cultureller Hinsicht* (Vienna, 1897); M. F. Soldan, *Narracion de Guerra de Chile contra Peru y Bolivia* (La Paz, 1884); C. M. Pepper, *Panama to Patagonia* (Chicago, 1906); A. Petrocokino, *Along the Andes, in Bolivia, Peru, and Ecuador* (London, 1903); Comte C. d'Ursel, *Sud Amérique: Séjours et voyages en Brésil, en Bolivie, &c.* (Paris, 1879); Charles Wiener, *Perou et Bolivie* (Paris, 1880); *Bolivia, Geographical Sketch, Natural Resources, &c.*, Intern. Bur. of the American Republics (Washington, 1904); *Boletín de la Oficina Nacional de Inmigración, Estadística y Propaganda Geográfica* (La Paz); *Sinopsis estadística y geográfica de la República de Bolivia* (3 vols., La Paz, 1902-1904); G. de Crequi-Montfort, "Exploration en Bolivie," in *La Géographie*, ix, pp. 79-86 (Paris, 1904); M. Neveu-Lemaire, "Le Titicaca et le Poopo," &c., in *La Géographie*, ix, pp. 409-439 (Paris, 1904); *British Foreign Office Diplomatic and Consular Reports* (London); *United States Consular Reports*; Stanford's *Compendium of Geography and Travel*, vol. I, *South and Central America* (London, 1904). For Geology see A. d'Orbigny, *Voyage dans l'Amérique méridionale*, vol. iii, pt. 8 (Paris, 1842); D. Forbes, "On the Geology of Bolivia and Peru," *Quart. Journ. Geol. Soc.* vol. xvii. (London, 1861), pp. 7-62, pls. I-8; A. Ulrich, "Palaeozoische Versteinerungen aus Bolivien," *Neues Jahrb. f. Min.* Band viii. (1893), pp. 5-116, pls. i-v.; C. Steinmann, &c., "Geologie des südöstlichen Boliviens," *Centralb. f. Min., Jahrg.* (1904), pp. 1-4. (A. J. L.)

HISTORY

The country now forming the republic of Bolivia, named after the great liberator Simon Bolivar (q.v.), was in early days simply a portion of the empire of the Incas of Peru (q.v.). After the conquest of Peru by the Spaniards in the 16th century the natives were subjected to much tyranny and oppression, though it must in fairness be said that much of it was carried out in defiance of the efforts and the wishes of the Spanish home government, whose legislative efforts to protect the Indians from serfdom and ill-usage met with scant respect at the hands of the distant settlers and mine-owners, who bid defiance to the humane and protective regulations of the council of the Indies, and treated the unhappy natives little better than beasts of burden. The statement, moreover, that some eight millions of Indians perished through forced labour in the mines is a gross exaggeration. The annual diminution in the number of the Indian population was undoubtedly very great, but it was due far more to the result of European epidemics and to indulgence in alcohol than to hard work. The abortive insurrection of 1780-82, led by the Inca Tupac Amará, was never a general rising, and was directed rather against Creole tyranny than against Spanish rule. The heavy losses sustained by the Indians during that outbreak, and their dislike and distrust of the colonial Spaniard, account for the comparative indifference with which they viewed the rise and progress of the 1814 colonial revolt against Spain, which gave the South American states their independence.

We are only concerned here with the War of Independence so far as it affected Upper Peru, the Bolivia of later days. When the patriots of Buenos Aires had succeeded in liberating from the dominion of Spain the interior provinces of the Rio de la Plata, they turned their arms against their enemies who held Upper Peru. An almost uninterrupted warfare followed, from July 1809 till August 1825, with alternate successes on the side of the Spanish or royalist and the South American or patriot forces,—the scene of action lying chiefly between the Argentine provinces of Salta and Jujuy and the shores of Lake Titicaca. The first movement of the war was the successful invasion of Upper Peru by the army of Buenos Aires, under General Balcarce, which, after twice defeating the Spanish troops, was able to celebrate the first anniversary of independence near Lake Titicaca, in May 1811. Soon, however, the patriot army, owing to the dissolute conduct and negligence of its leaders, became disorganized, and was attacked and defeated, in June 1811, by the Spanish army under General Goyeneche, and driven back into Jujuy. Four years of warfare,

in which victory was alternately with the Spaniards and the patriots, was terminated in 1815 by the total rout of the latter in a battle which took place between Potosi and Oruro. To this succeeded a revolt of the Indians of the southern provinces of Peru, and the object being the independence of the whole country, it was joined by numerous Creoles. This insurrection was, however, speedily put down by the royalists. In 1816 the Spanish general Laserna, having been appointed commander-in-chief of Upper Peru, made an attempt to invade the Argentine provinces, intending to march on Buenos Aires, but he was completely foiled in this by the activity of the irregular gaucho troops of Salta and Jujuy, and was forced to retire. During this time and in the six succeeding years a guerrilla warfare was maintained by the patriots of Upper Peru, who had taken refuge in the mountains, chiefly of the province of Yungas, and who frequently harassed the royalist troops. In June 1823 the expedition of General Santa Cruz, prepared with great zeal and activity at Lima, marched in two divisions upon Upper Peru, and in the following months of July and August the whole country between La Paz and Oruro was occupied by his forces; but later, the indecision and want of judgment displayed by Santa Cruz allowed a retreat to be made before a smaller royalist army, and a severe storm converted their retreat into a precipitate flight, only a remnant of the expedition again reaching Lima. In 1824, after the great battle of Ayacucho in Lower Peru, General Sucre, whose valour had contributed so much to the patriot success of that day, marched with a part of the victorious army into Upper Peru. On the news of the victory a universal rising of the patriots took place, and before Sucre had reached Oruro and Puno, in February 1825, La Paz was already in their possession, and the royalist garrisons of several towns had gone over to their side. The Spanish general Olafeta, with a diminished army of 2000 men, was confined to the province of Potosi, where he held out till March 1825, when he was mortally wounded in an action with some of his own revolted troops.

General Sucre was now invested with the supreme command in Upper Peru, until the requisite measures could be taken to establish in that country a regular and constitutional government. Deputies from the various provinces to the number of fifty-four were assembled at Chuquisaca, the capital, to decide upon the question proposed to them on the part of the government of the Argentine provinces, whether they would or would not remain separate from that country. In August 1825 they decided this question, declaring it to be the national will that Upper Peru should in future constitute a distinct and independent nation. This assembly continued their session, although the primary object of their meeting had thus been accomplished, and afterwards gave the name of Bolivia to the country,—issuing at the same time a formal declaration of independence.

Bolivia
a nation.

The first general assembly of deputies of Bolivia dissolved itself on the 6th of October 1825, and a new congress was summoned and formally installed at Chuquisaca on the 25th of May 1826, to take into consideration the constitution prepared by Bolivar for the new republic. A favourable report was made to that body by a committee appointed to examine it, on which it was approved by the congress, and declared to be the constitution of the republic; and as such, it was sworn to by the people. General Sucre was chosen president for life, according to the constitution, but only accepted the appointment for the space of two years, and on the express condition that 2000 Colombian troops should be permitted to remain with him.

The independence of the country, so dearly bought, did not, however, secure for it a peaceful future. Repeated risings occurred, till in the end of 1827 General Sucre and his Colombian troops were driven from La Paz. A new congress was formed at Chuquisaca in April 1828, which modified the constitution given by Bolivar, and chose Marshal Santa Cruz for president; but only a year later a revolution, led by General Blanco, threw the country into disorder and for a time overturned the government. Quiet being again restored in 1831, Santa Cruz promulgated the code of laws which bore his name, and brought the

financial affairs of the country into some order; he also concluded a treaty of commerce with Peru, and for several years Bolivia remained in peace. In 1835, when a struggle for the chief power had made two factions in the neighbouring republic of Peru, Santa Cruz was induced to take a part in the contest; he marched into that country, and after defeating General Gamarra, the leader of one of the opposing parties, completed the pacification of Peru in the spring of 1836, named himself its protector, and had in view a confederation of the two countries. At this juncture the government of Chile interfered actively, and espousing the cause of Gamarra, sent troops into Peru. Three years of fighting ensued till in a battle at Jungay in June 1839 Santa Cruz was defeated and exiled, Gamarra became president of Peru, and General Velasco provisional chief in Bolivia. The Santa Cruz party, however, remained strong in Bolivia, and soon revolted successfully against the new head of the government, ultimately installing General Ballivian in the chief power. Taking advantage of the disturbed condition of Bolivia, Gamarra made an attempt to annex the rich province of La Paz, invading it in August 1841 and besieging the capital; but in a battle with Ballivian his army was totally routed, and Gamarra himself was killed. The Bolivian general was now in turn to invade Peru, when Chile again interfered to prevent him. Ballivian remained in the presidency till 1848, when he retired to Valparaiso, and in the end of that year General Belzu, after leading a successful military revolution, took the chief power, and during his presidency endeavoured to promote agriculture, industry and trade. General Jorge Cordova succeeded him, but had not been long in office when a new revolt in September 1857, originating with the garrison of Oruro, spread over the land, and compelled him to quit the country. His place was taken by Dr José Maria Linares, the originator of the revolution, who, taking into his own hands all the powers of government, and acting with the greatest severity, caused himself to be proclaimed dictator in March 1858. Fresh disturbances led to the deposition of Linares in 1861, when Dr Maria de Acha was chosen president. In 1862 a treaty of peace and commerce with the United States was ratified, and in the following year a similar treaty was concluded with Belgium; but new causes of disagreement with Chile had arisen in the discovery of rich beds of guano on the eastern coast-land of the desert of Atacama, which threatened warfare, and were only set at rest by the treaty of August 1866, in which the 24th parallel of latitude was adopted as the boundary between the two republics. A new military revolution, led by Maria Melgarejo, broke out in 1865, and in February of that year the troops of President Acha were defeated in a battle near Potosi, when Melgarejo took the dominion of the country. After defeating two revolutions, in 1865 and 1866, the new president declared a political amnesty, and in 1869, after imposing a revised constitution on the country, he became its dictator.

In January 1871 President Melgarejo was in his turn deposed and driven from the country by a revolution headed by Colonel Augustin Morales. The latter, becoming president, was himself murdered in November 1872 and was succeeded by Colonel Adolfo Ballivian, who died in 1874. Under this president Bolivia entered upon a secret agreement with Peru which was destined to have grave consequences for both countries. To understand the reasons that urged Bolivia to take this step it is necessary to go back to the above-mentioned treaty of 1866 between Chile and Bolivia. By this instrument Bolivia, besides conceding the 24th parallel as the boundary of Chilean territory, agreed that Chile should have a half share of the customs and full facilities for trading on the coast that lay between the 23rd and 24th parallels, Chile at that time being largely interested in the trade of that region. It was also agreed that Chile should be allowed to mine and export the products of this district without tax or hindrance on the part of Bolivia. In 1870, in further consideration of the sum of \$10,000, Bolivia granted to an Anglo-Chilean company the right of working certain nitrate deposits north of the 24th parallel. The great wealth which was passing into Chilean hands owing to these

*Recent
History.*

compacts created no little discontent in Bolivia, nor was Peru any better pleased with the hold that Chilean capital was establishing in the rich district of Tarapacá. On 6th February 1873 Bolivia entered upon a secret agreement with Peru, the ostensible object of which was the preservation of their territorial integrity and their mutual defence against exterior aggression. There can be no doubt that the aggression contemplated as possible by both countries was a further encroachment on the part of Chile.

Upon the death of Adolfo Ballivian, immediately after the conclusion of this treaty with Peru, Dr Tomas Frias succeeded to the presidency. He signed yet another treaty with Chile, by which the latter agreed to withdraw her claim to half the duties levied in Bolivian ports on condition that all Chilean industries established in Bolivian territory should be free from duty for twenty-five years. This treaty was never ratified, and four years later General Hilarión Daza, who had succeeded Dr Frias as president in 1876, demanded as the price of Bolivia's consent that a tax of 10 cents per quintal should be paid on all nitrates exported from the country, further declaring that, unless this levy was paid, nitrates in the hands of the exporters would be seized by the Bolivian government. As an answer to these demands, and in order to protect the property of Chilean subjects, the Chilean fleet was sent to blockade the ports of Antofagasta, Cobija and Tocapilla. On the 14th February 1879 the Chilean colonel Sotomayor occupied Antofagasta, and on 1st March, a fortnight later, the Bolivian government declared war.

An offer on the part of Peru to act as mediator met with no favour from Chile. The existence of the secret treaty, well known to the Chilean government, rendered the intervention of Peru more than questionable, and the law passed by the latter in 1875, which practically created a monopoly of the Tarapacá nitrate beds to the serious prejudice of Chilean enterprise, offered no guarantee of her good faith. Chile replied by curtly demanding the annulment of the secret treaty and an assurance of Peruvian neutrality. Both demands being refused, she declared war upon Peru.

The superiority of the Chileans at sea, though checked for some time by the heroic gallantry of the Peruvians, soon enabled them to land a sufficient number of troops to meet the allied forces which had concentrated at Arica and other points in the south. The Bolivian ports were already in Chilean hands, and a sea attack upon Pisagua surprised and routed the troops under the Peruvian general Buendia and opened the way into the southern territory of Peru. General Daza, who should have co-operated with Buendia, turned back, on receiving news of the Peruvian defeat, and led the Bolivian troops to Tacna in a hasty and somewhat disorderly retreat. The fall of San Francisco followed, and Iquique, which was evacuated by the allies without a struggle, was occupied. Severe fighting took place before Tarapacá surrendered, but the end of 1879 saw the Chileans in complete possession of the province.

Meanwhile a double revolution took place in Peru and Bolivia. In the former country General Prado was deposed and Colonel Pierola proclaimed dictator. The Bolivians followed the example of their allies. The troops at Tacna, indignant at the inglorious part they had been condemned to play by the incompetence or cowardice of their president, deprived him of their command and elected Colonel Camacho to lead them. At the same time a revolution in La Paz proclaimed General Narciso Campero president, and he was elected to that post in the following June by the ordinary procedure of the constitution. During 1880 the war was chiefly maintained at sea between Chile and Peru, Bolivia taking little or no part in the struggle. In January of 1881 were fought the battles of Chorillos and Miraflores, attended by heavy slaughter and savage excesses on the part of the Chilean troops. They were followed almost immediately by the surrender of Lima and Callao, which left the Chileans practically masters of Peru. In the interior, however, where the Peruvian admiral Montero had formed a provisional government, the war still lingered, and in September 1882 a conference took place between the latter and President Campero, at which it was decided that they should hold out for better terms. But the Peruvians

wearied of the useless struggle. On the 20th of October 1883 they concluded a treaty of peace with Chile; the troops at Arequipa, under Admiral Montero, surrendered that town, and Montero himself, coldly received in Bolivia, whither he had fled for refuge, withdrew from the country to Europe. On the 9th of November the Chilean army of occupation was concentrated at Arequipa, while what remained of the Bolivian army lay at Oruro. Negotiations were opened, and on 11th December a peace was signed between Chile and Bolivia. By this treaty Bolivia ceded to Chile the whole of its sea-coast, including the port of Cobija.

On the 18th of May 1895 a treaty was signed at Santiago between Chile and Bolivia, "with a view to strengthening the bonds of friendship which unite the two countries," and, "in accord with the higher necessity that the future development and commercial prosperity of Bolivia require her free access to the sea." By this treaty Chile declared that if, in consequence of the plebiscite (to take place under the treaty of Ancon with Peru), or by virtue of direct arrangement, she should "acquire dominion and permanent sovereignty over the territories of Tacna and Arica, she undertakes to transfer them to Bolivia in the same form and to the same extent as she may acquire them"; the republic of Bolivia paying as an indemnity for that transfer \$5,000,000 silver. If this session should be effected, Chile should advance her own frontier north of Camerones to Vitor, from the sea up to the frontier which actually separates that district from Bolivia. Chile also pledged herself to use her utmost endeavour, either separately or jointly with Bolivia, to obtain possession of Tacna and Arica. If she failed, she bound herself to cede to Bolivia the roadstead (*caleta*) of Vitor, or another analogous one, and \$5,000,000 silver. Supplementary protocols to this treaty stipulated that the port to be ceded must "fully satisfy the present and future requirements" of the commerce of Bolivia.

On the 23rd of May 1895 further treaties of peace and commerce were signed with Chile, but the provisions with regard to the cession of a seaport to Bolivia still remained unfulfilled. During those ten years of recovery on the part of Bolivia from the effects of the war, the presidency was held by Dr Pacheco, who succeeded Campero, and held office for the full term; by Dr Aniceto Arce, who held it until 1892, and by Dr Mariano Baptista, his successor. In 1896 Dr Severo Alonso became president, and during his tenure of office diplomatic relations were resumed with Great Britain, Señor Aramay being sent to London as minister plenipotentiary in July 1897. As an outcome of his mission an extradition treaty was concluded with Great Britain in March 1898.

In December an attempt was made to pass a law creating Sucre the perpetual capital of the republic. Until this Sucre had taken its turn with La Paz, Cochabamba and Oruro. La Paz rose in open revolt. On the 17th of January of the following year a battle was fought some 40 m. from La Paz between the insurgents and the government forces, in which the latter were defeated with the loss of a colonel and forty-three men. Colonel Pando, the insurgent leader, having gained a strong following, marched upon Oruro, and entered that town on 11th April 1899, after completely defeating the government troops. Dr Severo Alonso took refuge in Chilean territory; and Colonel Pando formed a provisional government. He had no difficulty in obtaining his election to the presidency without opposition. He entered upon office on the 26th of October, and proved himself to be a strong and capable chief magistrate. He had to deal with two difficult settlements as to boundaries with Chile and Brazil, and to take steps for improving the means of communication in the country, by this means reviving its mining and other industries. The dispute with Brazil over the rich Acrc rubber-producing territory was accentuated by the majority of those engaged in the rubber industry being Brazilians, who resented the attempts of Bolivian officials to exercise authority in the district. This led to a declaration of independence on the part of the state of Acrc, and the despatch of a body of Bolivian troops in 1900 to restore order. There was no desire, however,

on the part of President Pando to involve himself in hostilities with Brazil, and in a spirit of concession the dispute was settled amicably by diplomatic means, and a treaty signed in November 1903. A new boundary line was drawn, and a portion of the Acrc province ceded to Brazil in consideration of a cash indemnity of \$10,000,000.

The long-standing dispute with Chile with regard to its occupation of the former Bolivian provinces of Tacna and Arica under the Parto de Tregua of the 4th of April 1884 was more difficult to arrange satisfactorily. In 1895 there had been some prospect of Chile conceding an outlet on the sea in exchange for a recognition of the Chilean ownership of Tacna and Arica. The discovery, however, of secret negotiations between Bolivia and Argentina caused Chile to change its conciliatory attitude. Bolivia was in no position to venture upon hostilities or to compel the Chileans to make concessions, and the final settlement of the boundary dispute between Argentina and Chile deprived the Bolivians of the hope of obtaining the support of the Argentines. President Pando and his successor, Ismail Montes, who became president in 1904, saw that it was necessary to yield, and to make the best terms they could. A treaty was accordingly ratified in 1905, which was in many ways advantageous to Bolivia, though the republic was compelled to cede to Chile the maritime provinces occupied by the latter power since the war of 1881, and to do without a seaport. The government of Chile undertook to construct a railway at its own cost from Arica to the Bolivian capital, La Paz, and to give the Bolivians free transit through Chilean territory to certain towns on the coast. Chile further agreed to pay Bolivia a cash indemnity and lend certain pecuniary assistance to the construction of other railways necessary for the opening out of the country.

See C. Wiener, *Bolivia et Pérou* (Paris, 1880); E. Mossbach, *Bolivia* (Leipzig, 1875); Theodore Child, *The South American Republics* (New York, 1891); Vicente de Ballvian y Rizas, *Archives Boliviano. Colección de documentos relativos a la historia de Bolivia* (Paris, 1872); Ramon Sotomayor Valdes, *Estudio historico de Bolivia bajo la administracion del General don José Maria Achá con una introduccion que contiene el compendio de la Guerra de la independencia i de los gobiernos de dicha Republica hasta 1861* (Santiago de Chile, 1874). (W. Hd.; C. E.)

BOLKHOV, a town of Russia, in the government of Orel, and 35 m. N. of the city of Orel. Pop. (1897) 20,703. It is prettily situated amongst orchards and possesses a cathedral. There is a lively trade in hemp, hemp-seed oil, hemp goods and cattle, and there are hemp-mills, soap-works and tanneries. The much-venerated monastery, Optina Pustyn, is close by.

BOLL, a botanical term for a fruit-pod, particularly of the cotton plant. The word is in O. Eng. *bolla*, which is also represented in "bowl," a round vessel for liquids, a variant due to "bowl," ball, which is from the Fr. *boule*. "Boll" is also used, chiefly in Scotland and the north of England, as a measure of weight for flour=140 lb, and of capacity for grain: 16 pecks = 1 boll.

BOLLANDISTS, the Belgian Jesuits who publish the *Acta Sanctorum*, the great collection of biographies and legends of the saints, arranged by days, in the order of the calendar. The original idea was conceived by a Jesuit father, Heribert Rosweyde (see HAGIOLOGY), and was explained by him in a sort of prospectus, which he issued in 1607 under the title of *Fasti sanctorum quorum vitæ in Belgicis Bibliothecis manuscriptæ*. His intention was to publish in eighteen volumes the lives of the saints compiled from the MSS., at the same time adding sober notes. At the time of his death (1629) he had collected a large amount of material, but had not been able actually to begin the work. A Jesuit father, John Bolland, was appointed to carry on the project, and was sent to Antwerp. He continued to amass material, and extended the scope of the work. In 1643 the two volumes for January appeared. The three volumes for February appeared in 1658, the three for March in 1668, the three for April in 1675, and so on. In 1635 Henschenius (Godfried Henschen) was associated with Bolland, and collaborated in the work until 1681. From 1659 to 1714 Papebroch (Daniel van Papenbroeck) collaborated. This was the most brilliant period in the history of the

Acta Sanctorum. The freedom of Papebroch's criticism made him many enemies, and he had often to defend himself against their attacks. The work was continued—with some inequalities, but always in the same spirit—until the suppression of the Society of Jesus in 1773. The last volume published was vol. iii. of October, which appeared in 1770.

On the dispersion of the Jesuits the Bollandists were authorized to continue their work, and remained at Antwerp until 1778, when they were transferred to Brussels, to the monastery of canons regular of Coudenberg. Here they published vol. iv. of October in 1780, and vol. v. of October in 1786, when the monastery of Coudenberg was suppressed. In 1788 the work of the Bollandists ceased. The remains of their library were acquired by the Premonstratensians of Tongerlo, who endeavoured to continue the work, and in their abbey vol. vi. of October appeared in 1794.

After the re-establishment of the Society of Jesus in Belgium the work was again taken up in 1837, at the suggestion of the Académie Royale of Belgium and with the support of the Belgian government, and the Bollandists were installed at the college of St Michael in Brussels. In 1845 appeared vol. vii. of October, the first of the new series, which reached vol. xiii. of October in 1883. In this series the Jesuit fathers Joseph van der Moere, Joseph van Hecke, Benjamin Bossue, Victor and Remi de Buck, Ant. Tinnebroeck, Edu. Carpentier and Henr. Matagne collaborated. Father John Martinov of Theazan was entrusted with the editing of the *Annus Graeco-Slavicus*, which appeared in the beginning of vol. xi. of October in 1864.

In 1882 the activities of the Bollandists were exerted in a new direction, with a view to bringing the work more into line with the progress of historical methods. A quarterly review was established under the title of *Analecta Bollandiana* by the Jesuit fathers C. de Smedt, G. van Hooff and J. de Backer. This reached its 25th volume in 1906, and was edited by the Bollandists de Smedt, F. van Ontroy, H. Delehaye, A. Porcelet and P. Peeters. This review contains studies in preparation for the continuation and remoulding of the *Acta Sanctorum*, unedited texts, dissertations, and, since 1892, a *Bulletin des publications hagiographiques*, containing criticisms of recent works on hagiographic questions. In addition to this review, the Bollandists undertook the analysis of the hagiographic MSS. in the principal libraries. Besides numerous library catalogues published in the *Analecta* (e.g. those of Chartres, Namur, Ghent, Messina, Venice, etc.), separate volumes were devoted to the Latin MSS. in the Bibliothèque Royale at Brussels (2 vols., 1886-1889), to the Latin and Greek MSS. in the Bibliothèque Nationale at Paris (5 vols., 1889-1896), to the Greek MSS. in the Vatican (1899), and to the Latin MSS. in the libraries of Rome (1905 seq.). They also prepared inventories of the hagiographic texts hitherto published, and of these there have appeared the *Bibliotheca hagiographica graeca* (1895), the *Bibliotheca hagiographica latina* (1899) and the *Bibliotheca hagiographica Orientalis*. These indispensable works delayed the publication of the principal collection, but tended to give it a more solid basis and a strictly scientific stamp. In 1887 appeared vol. i. for November; in 1894, vol. ii., preceded by the *Martyrologium Hieronymianum* by J. B. de Rossi and the abbé Louis Duchesne; in 1902, the *Prophylaeum ad Acta Sanctorum Novembris*, comprising the *Synaxarium ecclesiae Constantinopolitanae*.

There are three editions of the *Acta Sanctorum*: the original edition (Antwerp, Tongerlo and Brussels, 63 vols., 1643-1902); the Venice edition, stopping at vol. v. of September (1734-1770); and the Paris edition, stopping at vol. xiii. of October (61 vols., 1863-1883). In addition to these, there is a volume of tables, edited by the abbé Rigollot.

See *Acta Sanctorum apologetica libri . . . vindicata* (Antwerp, 1755): L. P. Gachard, *Mémoires historiques sur les Bollandistes* (Brussels, 1835); van Hecke, "De ratione operis Bollandiani" (*Acta Sanctorum Octobris*, vii.); and Cardinale J. B. Pitra, *Études sur la collection des Actes des Saints* (Paris, 1880). (H. DE.)

BOLOGNA, GIOVANNI DA (1524-1608) [Ital. for his real name, **JUAN BOLOGNE** or **BOULLONGNE**], French sculptor, was born at Douai in 1524. His early training as a sculptor was conducted at

Antwerp, but at the age of twenty-five he went to Italy and he settled in 1553 in Florence, where his best works still remain. His two most celebrated productions are the single bronze figure of Mercury, poised on one foot, resting on the head of a zephyr, as if in the act of springing into the air (in the Bargello gallery), and the marble group known as the Rape of the Sabinas, which was executed for Francesco de' Medici and received this name, Lanzi informs us, after it was finished. It is now in the Loggia de Lanzi of the ducal piazza. Giovanni was also employed at Genoa, where he executed various excellent works, chiefly in bronze. Most of his pieces are characterized by great spirit and elegance. His great fountain at Bologna (1563-1567) is remarkable for beauty of proportion. Noteworthy also are his two fountains in the Boboli gardens, one completed in 1576 and the other in 1585. He also cast the fine bronze equestrian statue of Cosimo de' Medici at Florence and the very richly decorated west door of Pisa cathedral. One of Bologna's best works, a group of two nude figures fighting, is now lost. A fine copy in lead was at one time in the front quadrangle of Brasenose College, Oxford. In 1881 it was sold for old lead by the principal and fellows of the college, and was melted down by the plumber who bought it.

See *La Via et l'œuvre de Jean Bologne, par Abel Desjardins, d'après les manuscrits—recueillis par Fouques de Vagnonville* (1883, numerous illustrations; list of works).

BOLOGNA, a city and archiepiscopal see of Emilia, Italy, the capital of the province of Bologna, and headquarters of the VI. army corps. It is situated at the edge of the plain of Emilia, 180 ft. above sea-level at the base of the Apennines, 82 m. due N. of Florence by rail, 63 m. by road and 50 m. direct, and 134 m. S.E. of Milan by rail. Pop. (1901) town, 102,122; commune, 153,501. The more or less rectangular Roman city, orientated on the points of the compass, with its streets arranged at right angles, can be easily distinguished from the outer city, which received its fortifications in 1206 (see G. Gozzadini, *Studi archeologico-topografici sulla città di Bologna*, Bologna, 1868). The streets leading to the gates of the latter radiate from the outskirts, and not from the centre, of the former. Some of the oldest churches, however, lie outside the limits of the Roman city (of which no buildings remain above ground) such as S. Stefano, S. Giovanni in Monte and SS. Vitale ed Agricola. The first consists of a group of no less than seven different buildings, of different dates; the earliest of which, the former cathedral of SS. Pietro e Paolo, was constructed about the middle of the 4th century, in part with the débris of Roman buildings; while S. Sepolcro, a circular church with ornamentation in brick and an imitation of *opus reticulatum*, should probably be attributed to the 6th or 7th centuries. The present cathedral (S. Pietro), erected in 910, is now almost entirely in the baroque style. The largest church in the town, however, is that of S. Petronio, the patron saint of Bologna, which was begun in 1390; only the nave and aisles as far as the transepts were, however, completed, but even this is a fine fragment, in the Gothic style, measuring 384 ft. long, and 157 wide, whereas the projected length of the whole (a cruciform basilica) was over 700 ft., with a breadth across the transepts of 460 ft., and a dome 500 ft. high over the crossing (see F. Cavazza in *Rassegna d'Arte*, 1905, 261). The church of S. Domenico, which contains the body of the saint, who died here in 1221, is unfinished externally, while the interior was remodelled in the 18th century. There are many other churches of interest, among them S. Francesco, perhaps the finest mediæval building in Bologna, begun in 1246 and finished in 1260; it has a fine brick campanile of the end of the 14th century. It was restored to sacred uses in 1887, and has been carefully liberated from later alterations (U. Berti in *Rassegna d'Arte*, 1901, 55). The church of Corpus Domini has fine 15th-century terra cotta on the façade (F. Malaguzzi Valeri in *Archivio Storico dell'Arte*, ser. ii. vol. ii. (Rome, 1896), 72). The centre of the town is formed by the Piazza Vittorio Emanuele (formerly Piazza Maggiore), and the Piazza del Nettuno, which lie at right angles to one another. Here are the church of S. Petronio, the massive Palazzo Comunale, dating from 1245, the Palazzo dei Podesta, completed in the same year, and the

fine bronze statue of Neptune by Giovanni da Bologna (Jean Bologno of Douai).

The famous university of Bologna was founded in the 11th century (its foundation by Theodosius the Great in A.D. 425 is legendary), and acquired a European reputation as a school of jurisprudence under Pepo, the first known teacher at Bologna of Roman law (about 1076), and his successor Irnerius and their followers the glossators. The students numbered between three and five thousand in the 12th to the 15th century, and in 1262, it is said, nearly ten thousand (among them were both Dante and Petrarch). Anatomy was taught here in the 14th century. But despite its fame, the university, though an autonomous corporation, does not seem to have had any fixed residence: the professors lectured in their own houses, or later in rooms hired or lent by the civic authorities. It was only in 1520 that the professors of law were given apartments in a building belonging to the church of S. Petronio; and in 1562, by order of Pius IV., the university itself was constructed close by, by Carlo Borromeo, then cardinal legate. The reason of this measure was no doubt partly disciplinary, Bologna itself having in 1506 passed under the dominion of the papacy. Shortly after this, in 1564, Tasso was a student there, and was tried for writing a satirical poem. One of the most famous professors was Marcello Malpighi, a great anatomist of the 17th century. The building has served as the communal library since 1838. Its courtyard contains the arms of those students who were elected as representatives of their respective nations or faculties. The university has since 1503 been established in the (16th century) Palazzo Poggi. Between 1815 and 1848 the number of students sank to about a hundred in some years, chiefly owing to the political persecutions of the government: in 1850 the number had risen to 355. It now possesses four faculties and is attended by some 1700 students. Among its professors women have more than once been numbered.

The Museo Civico is one of the most important museums in Italy, containing especially fine collections of antiquities from Bologna and its neighbourhood. The picture gallery is equally important in its way, affording a survey both of the earlier Bolognese paintings and of the works of the Bolognese eclectics of the 16th and 17th centuries, the Caracci, Guido Reni, Domenichino, Guercino, &c. The primitive masters are not of great excellence, but the works of the masters of the 15th century, especially those of Francesco Francia (1450-1517) and Lorenzo Costa di Ferrara (1460-1535), are of considerable merit. The great treasure of the collection is, however, Raphael's S. Cecilia, painted for the church of S. Giovanni in Monte, about 1515.

The two leaning towers, the Torre Asinelli and the Torre Garisenda, dating from 1100 and 1110 respectively, are among the most remarkable structures in Bologna: they are square brick towers, the former being 320 ft. in height and 4 ft. out of the perpendicular, the latter (unfinished) 163 ft. high and 10 ft. out of the perpendicular. The town contains many fine private palaces, dating from the 13th century onwards. The streets are as a rule arcaded, and this characteristic has been preserved in modern additions, which have on the whole been made with considerable taste, as have also the numerous restorations of mediæval buildings. A fine view may be had from the Madonna di S. Luca, on the south-west of the town (938 ft.).

Among the specialities of Bologna may be noted the *salami* or *mortadella* (Bologna sausage), *tortellini* (a kind of macaroni) and liqueurs.

Bologna is an important railway centre, just as the ancient Bononia was a meeting-point of important roads. Here the main line from Milan divides, one portion going on parallel to the line of the ancient Via Aemilia (which it has followed from Faenza downwards) to Rimini, Ancona and Brindisi, and the other through the Apennines to Florence and thence to Rome. Another line runs to Ferrara and Padua, another (eventually to be prolonged to Verona) to S. Felice sul Panaro, and a third to Budrio and Portomaggiore (a station on the line from Ferrara to Ravenna). Steam tramways run to Vignola, Pieve di Cento and Malalbergo.

Bologna was only for a short while subject to the Lombards, remaining generally under the rule of the exarchate of Ravenna, until this in 756 was given by Pippin to the papacy. It was sacked by the Hungarians in 902, but otherwise its history is little known, and it is uncertain when it acquired its freedom and its motto *Libertas*. But the first "constitution" of the commune of Bologna dates from about 1123, and at that time we find it a free and independent city. From the 12th to the 14th century it was very frequently at war, and strongly supported the Guelph cause against Frederick II. and against the neighbouring cities of Romagna and Emilia; indeed, in 1249 the Bolognese took Enzo, the emperor's son, prisoner, and kept him in confinement for the rest of his life. But the struggles between Guelphs and Ghibellines in Bologna itself soon followed, and the commune was so weakened that in 1337 Taddeo de' Pepoli made himself master of the town, and in 1350 his son sold it to Giovanni Visconti of Milan. Ten years later it was given to the papacy, but soon revolted and recovered its liberty. In 1401 Giovanni Bentivoglio made himself lord of Bologna, but was killed in a rebellion of 1402. It then returned to the Visconti, and after various struggles with the papacy was again secured in 1438 by the Bentivoglio, who held it till 1506, when Pope Julius II. drove them out, and brought Bologna once more under the papacy, under the sway of which it remained (except in the Napoleonic period between 1796 and 1815 and during the revolutions of 1821 and 1831) until in 1860 it became part of the kingdom of Italy.

Among the most illustrious natives of Bologna may be noted Luigi Galvani (1737-1798), the discoverer of galvanism, and Prospero Lambertini (Pope Benedict XIV.).

See C. Ricci, *Guida di Bologna* (3rd ed., Bologna, 1900). (T. As.)

BOLSENA (anc. *Volsinii*), a town of the province of Rome, Italy, 12 m. W.S.W. of Orvieto by road, situated on the north-east bank of the lake of Bolsena. Pop. (1901) 3286. The town is dominated by a picturesque mediæval castle, and contains the church of S. Christina (martyred by drowning in the lake, according to the legend, in 278) which dates from the 11th century and contains some frescoes, perhaps of the school of Giotto. It has a fine Renaissance façade, constructed about 1500 by Cardinal Giovanni de' Medici (afterwards Pope Leo X.), and some good terra cottas by the Della Robbia. Beneath the church are catacombs, with the tomb of the saint, discovered in 1880 (E. Stevenson in *Notizie degli Scavi*, 1880, 262; G. B. de Rossi in *Bullettino d'Archeologia Cristiana*, 1880, 109). At one of the altars in this crypt occurred the miracle of Bolsena in 1263. A Bohemian priest, sceptical of the doctrine of transubstantiation, was convinced of its truth by the appearance of drops of blood on the host he was consecrating. In commemoration of this Pope Urban IV. instituted the festival of Corpus Christi, and ordered the erection of the cathedral of Orvieto. The miracle forms the subject of a celebrated fresco by Raphael in the Vatican.

The Lake of Bolsena (anc. *Lacus Volsiniensis*), 1000 ft. above sea-level, 71 sq. m. in area, and 480 ft. deep, is almost circular, and was the central point of a large volcanic district, though it is probably not itself an extinct crater. Its sides show fine basaltic formation in places. It abounds in fish, but its banks are somewhat deserted and not free from malaria. It contains two islands, Bisentina and Martana, the former containing a church constructed by Vignola, the latter remains of the castle where Amalasuatha, the daughter of Theodoric, was imprisoned and strangled. (T. As.)

BOLSOVER, an urban district in the north-eastern parliamentary division of Derbyshire, England, 5½ m. E. of Chesterfield, on branch lines of the Midland and the Great Central railways. Pop. (1901) 6844. It lies at a considerable height on a sharp slope above a stream tributary to the river Rother. The castle round which the town grew up was founded

¹ According to the theory now generally adopted, the Etruscan Volsinii occupied the site of Orvieto, which was hence called *Urbs vetus* in late classical and mediæval times, while the Roman Volsinii was transferred to Bolœna (see VOLSINII).

shortly after the Conquest by William Peveril, but the existing building, a fine castellated residence, was erected on its site in 1613. The town itself was fortified, and traces of early works remain. The church of St Mary is of Norman and later date; it contains some interesting early stone-carving, and monuments to the family of Cavendish, who acquired the castle in the 16th century. Coal-mining and quarrying are carried on in the neighbourhood of Bolsover.

BOLSWARD, a town in the province of Friesland, Holland, 6½ m. W.N.W. of Sneek. A steam-tramway connects it with Sneek, Makkum, Harlingen and Franeker. Pop. (1900) 6517. The Great church, or St Martin's (1446-1466) is a large building containing some good carving, a fine organ and the tombs of many Frisian nobles. The so-called Small church, dating from about 1280, also contains fine carving and tombstones; and is the remnant of a Franciscan convent which once existed here. Bolsward also possesses a beautiful renaissance town-hall (1614-1618) and various educational and charitable institutions, including a music and a drawing school. It has an active trade in agricultural produce, and some spinning-mills and tile and pottery works. The town is mentioned in 725, when it was situated on the Middle Sea. When this receded, a canal was cut to the Zuider Zee, and in 1422 it was made a Hansa town.

The medieval constitution of Bolsward, though in its government by eight *scabini*, with judicial, and four councillors with administrative functions, it followed the ordinary type of Dutch cities, was in some ways peculiar. The family of Jongema had certain hereditary rights in the administration, which, though not mentioned in the town charter of 1455, were defined in that of 1464. According to this the head of the family sat for two years with the *scabini* and the third year with the councillors, and had the right to administer an oath to one of each body. More singular was the influential position assigned, in civic legislation and administration, to the clergy, to whom in conjunction with the councillors, there was even, in certain cases, an appeal from the judgment of the *scabini*.

See C. Hegel, *Städte u. Gilden der germanischen Völker im Mittelalter* (Leipzig, 1891).

BOLT, an O. Eng. word (compare Ger. *Bols*, an arrow), for a "quarrel" or cross-bow shaft, or the pin which fastened a door. From the swift flight of an arrow comes the verb "to bolt," as applied to a horse, &c., and such expressions as "bolt upright," meaning straight upright; also the American use of "bolt" for refusing to support a candidate nominated by one's own party. In the sense of a straight pin for a fastening, the word has come to mean various sorts of appliances. From the sense of "fastening together" is derived the use of the word "bolt" as a definite length (in a roll) of a fabric (40 ft. of canvas, &c.).

From another "bolt" or "boul't," to sift (through O. Fr. *buleter*, from the Med. Lat. *buretare* or *buletare*), come such expressions as in Shakespeare's *Winter's Tale*, "The fann'd snow, That's bolted by the northern blasts twice o'er," or such a figurative use as in Burke's "The report of the committee was examined and sifted and bolted to the bran." From this sense comes that of moot, or discuss, as in Milton's *Comus*, "I hate when vice can bolt her arguments."

BOLTON, DUKES OF. The title of duke of Bolton was held in the family of Powlett or Paulet from 1689 to 1794. Charles Powlett, the 1st duke (c. 1625-1690), who became 6th marquis of Winchester on his father's death in 1675, had been member of parliament for Winchester and then for Hampshire from 1660 to 1675. Having supported the claim of William and Mary to the English throne in 1688, he was restored to the privy council and to the office of lord-lieutenant of Hampshire, and was created duke of Bolton in April 1689. An eccentric man, hostile to Halifax and afterwards to Marlborough, he is said to have travelled during 1687 with four coaches and 100 horsemen, sleeping during the day and giving entertainments at night. He died in February 1690, and was succeeded by his elder son, Charles, 2nd duke of Bolton (1661-1722), who had also been a member of parliament for Hampshire and a supporter of William of Orange. He was lord-lieutenant of Hampshire and of Dorset,

a commissioner to arrange the union of England and Scotland, and was twice a lord justice of the kingdom. He was also lord chamberlain of the royal household; governor of the Isle of Wight; and for two short periods was lord-lieutenant of Ireland. His third wife was Henrietta (d. 1730), a natural daughter of James, duke of Monmouth. According to Swift this duke was "a great booby." His eldest son, Charles, 3rd duke of Bolton (1685-1754), was a member of parliament from 1705 to 1717, when he was made a peer as Baron Pawlet of Basing. He filled many of the public offices which had been held by his father, and also attained high rank in the British army. Having displeased Sir Robert Walpole he was deprived of several of his offices in 1733; but some of them were afterwards restored to him, and he raised a regiment for service against the Jacobites in 1745. He was a famous gallant, and married for his second wife the singer, Lavinia Fenton (d. 1760), a lady who had previously been his mistress. He died in August 1754, and was succeeded as 4th duke by his brother Harry (c. 1690-1750), who had been a member of parliament for forty years, and who followed the late duke as lord-lieutenant of Hampshire. The 4th duke's son, Charles (c. 1718-1765), who became 5th duke in October 1759, committed suicide in London in July 1765, and was succeeded by his brother Harry (c. 1719-1794), an admiral in the navy, on whose death without sons, in December 1794, the dukedom became extinct. The other family titles descended to a kinsman, George Paulet (1722-1800), who thus became 12th marquis of Winchester. In 1778 Thomas Orde (1746-1807) married Jean Mary (d. 1814), a natural daughter of the 5th duke of Bolton, and this lady inherited Bolton Castle and other properties on the death of the 6th duke. Having taken the additional name of Powlett, Orde was created Baron Bolton in 1797, and the barony has descended to his heirs.

BOLTON (or **BOULTON**), **EDMUND** (1575?-1633?), English historian and poet, was born by his own account in 1575. He was brought up a Roman Catholic, and was educated at Trinity Hall, Cambridge, afterwards residing in London at the Inner Temple. In 1600 he contributed to *England's Helicon*. He was a retainer of the duke of Buckingham, and through his influence he secured a small place at the court of James I. Bolton formulated a scheme for the establishment of an English academy, but the project fell through after the death of the king, who had regarded it favourably. He wrote a *Life of King Henry II. for Speed's Chronicle*, but his Catholic sympathies betrayed themselves in his treatment of Thomas Becket, and a life by Dr John Barcham was substituted (Wood, *Ath. Oxon.* ed. Bliss, iii. 36). The most important of his numerous works are *Hypercritica* (1618?), a short critical treatise valuable for its notices of contemporary authors, reprinted in Joseph Haslewood's *Ancient Critical Essays* (vol. ii., 1815); *Nero Caesar, or Monarchia Depraved* (1624), with special note of British affairs. Bolton was still living in 1633, but the date of his death is unknown.

BOLTON (**BOLTON-LE-MOORS**), a municipal, county and parliamentary borough of Lancashire, England, 196 m. N.W. by N. from London and 11 m. N.W. from Manchester. Pop. (1891) 146,487; (1901) 168,215. Area, 15,279 acres. It has stations on the London & North-Western and the Lancashire & Yorkshire railways, with running powers for the Midland railway. It is divided by the Croal, a small tributary of the Irwell, into Great and Little Bolton, and as the full name implies, is surrounded by high moorland. Although of early origin, its appearance, like that of other great manufacturing towns of the vicinity, is wholly modern. It owes not a little to the attractions of its site. The only remnants of antiquity are two houses of the 16th century in Little Bolton, of which one is a specially good example of Tudor work. The site of the church of St Peter has long been occupied by a parish church (there was one in the 12th century, if not earlier), but the existing building dates only from 1870. There may also be mentioned a large number of other places of worship, a town hall with fine classical façade and tower, market hall, museums of natural history and of art and industry, an exchange, assembly rooms, and various benevolent institutions. Several free libraries are maintained. Lever's grammar school,

founded in 1641, had Robert Ainsworth, the Latin lexicographer, and John Lemprière, author of the classical dictionary, among its masters. There are municipal technical schools. A large public park, opened in 1866, was laid out as a relief work for unemployed operatives during the cotton famine of the earlier part of the decade. On the moors to the north-west, and including Rivington Pike (1192 ft.), is another public park, and there are various smaller pleasure grounds. A large number of cotton mills furnish the chief source of industry; printing, dyeing and bleaching of cotton and calico, spinning and weaving machine making, iron and steel works, and collieries in the neighbourhood, are also important. The speciality, however, is fine spinning, a process assisted by the damp climate. The parliamentary borough, created in 1832 and returning two members, falls within the Westboughton division of the county. Before 1838, when Bolton was incorporated, the town was governed by a borough-reve and two constables appointed at the annual court-leet. The county borough was created in 1888. The corporation consists of a mayor, 24 aldermen and 72 councillors.

The earliest form of the name is Bodleton or Bothelton, and the most important of the later forms are Bodeltown, Botheltunle-Moors, Bowelton, Boltune, Bolton-super-Moras, Bolton-in-yemoors, Bolton-le-Moors. The manor was granted by William I. to Roger de Poitou, and passed through the families of Ferrers and Pilkington to the Harringtons of Hornby Castle, who lost it with their other estates for their adherence to Richard III. In 1485 Henry VII. granted it to the first earl of Derby. The manor is now held by different lords, but the earls of Derby still have a fourth part. The manor of Little Bolton seems to have been, at least from Henry III.'s reign, distinct from that of Great Bolton, and was held till the 17th century by the Botheltons or Boltons.

From early days Bolton was famous for its woollen manufactures. In Richard I.'s reign an aulneger, whose duty it was to measure and stamp all bundles of woollen goods, was appointed, and it is clear, therefore, that the place was already a centre of the woollen cloth trade. In 1337 the industry received an impulse from the settlement of a party of Flemish clothiers, and extended so greatly that when it was found necessary in 1566 to appoint by act of parliament deputies to assist the aulnegers, Bolton is named as one of the places where these deputies were to be employed. Leland in his *Itinerary* (1558) recorded the fact that Bolton made cottons, which were in reality woollen goods. Real cotton goods were not made in Lancashire till 1641, when Bolton is named as the chief seat of the manufacture of fustians, vermilions and dimities. After the revocation of the edict of Nantes the settlement of some French refugees further stimulated this industry. It was here that velvets were first made about 1756, by Jeremiah Clarke, and muslins and cotton quiltings in 1763. The cotton trade received an astonishing impetus from the inventions of Sir Richard Arkwright (1770), and Samuel Crompton (1780), both of whom were born in the parish. Soon after the introduction of machinery, spinning factories were erected, and the first built in Bolton is said to have been set up in 1780. The number rapidly increased, and in 1851 there were 66 cotton mills with 860,000 throstle spindles at work. The cognate industry of bleaching has been carried on since early in the 18th century, and large ironworks grew up in the latter half of the 19th century. In 1791 a canal was constructed from Manchester to Bolton, and by an act of parliament (1792) Bolton Moor was enclosed.

During the Civil War Bolton sided with the parliament, and in February 1643 and March 1644 the royalist forces assaulted the town, but were on both occasions repulsed. On the 28th of May 1644, however, it was attacked by Prince Rupert and Lord Derby, and stormed with great slaughter. On the 15th of October 1651 Lord Derby, who had been taken prisoner after the battle of Worcester, was brought here and executed the same day.

Up to the beginning of the 19th century the market day was Monday, but the customary Saturday market gradually superseded this old chartered market. In 1251 William de Ferrers

obtained from the crown a charter for a weekly market and a yearly fair, but gradually this annual fair was replaced by four others chiefly for horses and cattle. The New Year and Whitsuntide Show fairs only arose during the 19th century.

BOLTON ABBEY, a village in the West Riding of Yorkshire, England, 22 m. N.W. from Leeds and 5½ from Ilkley by the Midland railway. It takes its name, inaccurately, from the great foundation of Bolton Priory, the ruins of which are among the most exquisitely situated in England. They stand near the right bank of the upper Wharfe, the valley of which is beautifully wooded and closely enclosed by hills. The earliest part of the church is of transitional Norman date; the nave, which is perfect, is Early English and Decorated. The transepts and choir are ruined, and the remains of domestic buildings are slight. The manor of Bolton Abbey with the rest of the district of Craven was granted by William the Conqueror to Robert de Romili, who evidently held it in 1086, although there is no mention made of it in the Domesday survey. William de Meschines and Cicely de Romili, his wife, heiress of Robert, founded and endowed a priory at Embasay or Emmesay, near Skipton, in 1120, but it was moved here in 1151 by their daughter, Alice de Romili, wife of William FitzDuncan, who gave the manor to the monks in exchange for other lands. After the dissolution of the monasteries the manor was sold in 1542 to Henry Clifford, 2nd earl of Cumberland, whose descendants, the dukes of Devonshire, now hold it.

See J. D. Whitaker, LL.D. F.S.A., *History of the District of Craven* (ed. Morant, 1878); Dugdale's *Monasticon Anglicanum*.

BOLZANO, BERNHARD (1781-1848), Austrian priest and philosopher, was born at Prague on the 5th of October 1781. He distinguished himself at an early age, and on his ordination to the priesthood (1805) was appointed professor of the philosophy of religion in Prague University. His lectures, in which he endeavoured to show that Catholic theology is in complete harmony with reason, were received with eager interest by the younger generation of thinkers. But his views met with much opposition; and it was only through the protection of the archbishop, Prince Salm-Salm, that he was enabled to retain his chair. In 1820 he was accused of being connected with some of the students' revolutionary societies, and was compelled to resign. Several doctrines extracted from his works were condemned at Rome, and he was suspended from his priestly functions, spending the rest of his life in literary work. He died at Prague on the 18th of December 1848. The most important of his numerous works are the *Wissenschaftslehre, oder Versuch einer neuen Darstellung der Logik*, advocating a scientific method in the study of logic (4 vols., Sulzbach, 1837); the *Lehrbuch der Religionswissenschaft* (4 vols., Sulzbach, 1834), a philosophic representation of all the dogmas of Roman Catholic theology; and *Athanasia, oder Gründe für die Unsterblichkeit der Seele* (2nd ed., Mainz, 1838). In philosophy he followed Reinhard in ethics and the monadology of Leibnitz, though he was also influenced by Kant.

See *Lebensbeschreibung des Dr. Bolzano* (an autobiography, 1836); *Wissnaupt, Skizzen aus dem Leben Dr. Bolzanos* (1850); Palágy, *Kani und Bolzano* (Halle, 1902).

BOMA (properly *M'boma*), a port on the north bank of the river Congo about 60 m. from its mouth, the administrative capital of Belgian Congo. Pop. about 5000. It was one of the places at which the European traders on the west coast of Africa established stations in the 16th and 17th centuries. It became the entrepôt for the commerce of the lower Congo and a well-known mart for slaves. The trade was chiefly in the hands of Dutch merchants, but British, French and Portuguese firms also had factories there. No European power exercised sovereignty, though shadowy claims were from time to time put forward by Portugal (see *AFRICA*, § 5). In 1884 the natives of Boma granted a protectorate of their country to the International Association of the Congo.

See H. M. Stanley, *The Congo and the Founding of its Free State* (London, 1885).

BOMB, a term formerly used for an explosive shell (see **AMMUNITION**) fired by artillery. The word is derived from the

Gr. *βουβος*, a hammering, buzzing noise, cf. "bombard" (q.v.). At the present day it is most frequently used of a shattering or incendiary grenade, or of an explosive vessel actuated by clock-work or trip mechanism, employed to destroy life or property. In naval warfare, before the introduction of the shell gun, explosive projectiles were carried principally by special vessels known as bomb-vessels, bombards or, colloquially, bombs.

In geology, the name "bomb" is given to certain masses of lava which have been hurled forth from a volcanic vent by explosive action. In shape they are spheroidal, ellipsoidal or discoidal; in structure they may be solid, hollow or more or less cavernous; whilst in size they vary from that of a walnut to masses weighing several tons. It is generally held that the form is partly due to rotation of the mass during its aerial flight, and in some cases the bomb becomes twisted by a gyratory movement. According, however, to Dr H. J. Johnston-Lavis, many of the so-called bombs of Vesuvius are not projectiles, but merely globular masses formed in a stream of lava; and in like manner Professor J. D. Dana showed that what were regarded as bombs in Hawaii are in many cases merely lava-balls that have not been hurled through the air. Certain masses of pumice ejected from Vulcano have been called by Johnston-Lavis "bread-crust bombs," since they present a coating of obsidian which has been bent and cracked in a way suggestive of the crust of a roll. It is probable that here the acid magna was expelled in a very viscous condition, and the crust which formed on cooling was burst by the steam from the occluded water. Some of the bombs thrown out during recent eruptions of Etna consist of white granular quartz, encased in a black scoriaceous crust, the quartz representing an altered sandstone. The bombs of granular olivine, found in some of the tuffs in the Eifel, are represented in most geological collections (see VOLCANO).

BOMBARD (derived through Med. Lat. and Fr. forms from Gr. *βουβέω*, to make a humming noise), a term applied in the middle ages to a sort of cannon, used chiefly in sieges, and throwing heavy stone balls; hence the later use as a verb (see BOMBARDMENT). The name, in various forms, was also given to a mediæval musical instrument ("bombard," "bumhart," "pumhart," "pommer"), the forerunner of the bass oboe or *schalmey*. At the present day a small primitive oboe called *bombarde*, with eight holes but no keys, is used among the Breton peasants.

BOMBARDIER, originally an artilleryman in charge of a bombard; now a non-commissioned officer in the artillery of the British army, ranking below a corporal.

BOMBARDMENT, an attack by artillery fire directed against fortifications, troops in position or towns and buildings. In its strict sense the term is only applied to the bombardment of defenceless or undefended objects, houses, public buildings, &c., the object of the assailant being to dishearten his opponent, and specially to force the civil population and authorities of a besieged place to persuade the military commandant to capitulate before the actual defences of the place have been reduced to impotence. It is, therefore, obvious that mere bombardment can only achieve its object when the amount of suffering inflicted upon non-combatants is sufficient to break down their resolution, and when the commandant permits himself to be influenced or coerced by the sufferers. A threat of bombardment will sometimes induce a place to surrender, but instances of its fulfilment being followed by success are rare; and, in general, with a determined commandant, bombardments fail of their object. Further, an intentionally terrific fire at a large target, unlike the slow, steady and minutely accurate "artillery attacks" directed upon the fortifications, requires the expenditure of large quantities of ammunition, and wears out the guns of the attack. Bombardments are, however, frequently resorted to in order to test the temper of the garrison and the civil population, a notable instance being that of Strassburg in 1870. The term is often loosely employed to describe artillery attacks upon forts or fortified positions in preparation for assaults by infantry.

BOMBARDON, or BASS TUBA, the name given to the bass and contrabass of the brass wind in military bands, called in the orchestra bass tuba.

The name of bombardon is unquestionably derived from *bombardone*, the Italian for contrabass pommer (bombard), which, before the invention of the fagotto, formed the bass of mediæval orchestras; it is also used for a bass reed stop of 16 ft. tone on the organ. The bombardon was the very first bass wind-instrument fitted with valves, and it was at first known as the *corno basso*, *claricor* or *bass horn* (not to be confounded with the bass horn with keys, which on being perfected became the ophicleide). The name was attached more to the position of the wind instruments as bass than to the individual instrument. The original corno basso was a brass instrument of narrow bore with the pistons set horizontally. The valve-ophicleide in F of German make had a wider bore and three vertical pistons, but it was only a "half instrument," measuring about 12 ft. A Kalkbrenner, in his life of W. Wieprecht (1882), states that in the Jäger military bands of Prussia the corno basso (keyed bass horn) was introduced as bass in 1829, and the bombardon (or valve-ophicleide) in 1831; in the Guards these instruments were superseded in 1835 by the bass tuba invented by Wieprecht and J. G. Moritz.

The modern bombardon is made in two forms: the upright model, used in stationary band music; and the circular model, known as the helicon, worn round the body with the large bell resting on the left shoulder, after the style of the Roman *cornu* (see HORN), which is a more convenient way of carrying this heavy instrument when marching. The bombardon, and the euphonium, of which it is the bass, are the outcome of the application of valves to the bugle family whereby the saxhorns were also produced. The radical difference between the saxhorns and the tubas (including the bombardon) is that the latter have a sufficiently wide conical bore to allow of the production of fundamental sounds in a rich, full quality of immense power. This difference, first recognized in Germany and Austria, has given rise in those countries to the classification of the brass wind as "half" and "whole" instruments (*Halbe* and *Ganze Instrumente*). When the brass wind instruments with conical bore and cup-shaped mouthpiece first came into use, it was a well-understood principle that the tube of each instrument must theoretically be made twice as long as an organ pipe giving the same note; for example, the French horn sounding the 8 ft. C of an 8 ft. organ pipe, must have a tube 16 ft. long; C then becomes the second harmonic of the series for the 16 ft. tube, the first or fundamental being unobtainable. After the introduction of pistons, instrument-makers experimenting with the bugle, which has a conical bore of very wide diameter in proportion to the length, found that baritone and bass instruments constructed on the same principle gave out the fundamental full and clear. A new era in the construction of brass wind instruments was thus inaugurated, and now that the proportions of the bugle have been adopted, the tubes of the tubas are made just half the length of those of the older instruments, corresponding to the length of the organ pipe of the same pitch, so that a euphonium sounding 8 ft. C no longer needs to be 16 ft. long but only 8 ft. The older instruments, such as the saxhorns, with narrow bore, have therefore been denominated "half instruments," because only half the length of the instrument is of practical utility, while the tubas with wide bore are styled "whole instruments."¹ Bombardons are made in E flat and F of the 16 ft. octave, corresponding to the orchestral bass tuba, double bass in strings, and pedal clarinet and contrafagotto in the wood wind. The bombardon in B flat or C, an octave lower than the euphonium, corresponds to the contrabass tuba in the orchestra.

¹See Dr E. Schafhäutl's article on Musical Instruments, section 4 of *Bericht der Beurtheilungscommission bei der Allg. deutschen Industrie-Ausstellung, 1854* (Munich, 1855), pp. 169-170; also Friedr. Zamminer, *Die Musik und die Musikinstrumente in ihrer Beziehung zu den Gesetzen der Akustik* (Giessen, 1855), p. 313.

The bombardons possess a chromatic compass of $3\frac{1}{2}$ to 4 octaves. The harmonic series consists of the harmonics from the 1st to the 8th.

BOMBARDON IN E FLAT.



For the bombardon in F, one tone higher.

HARMONIC SERIES OF THE CONTRABASS BOMBARDON IN C.

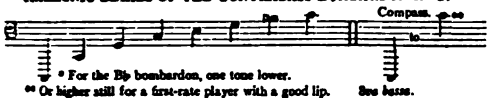

For the Eb bombardon, one tone lower.

Or higher still for a first-rate player with a good lip.

The lowest notes produced by the valves are very difficult to obtain, for the lips seldom have sufficient power to set in vibration a column of air of such immense length, at a rate of vibration slow enough to synchronize with that of notes of such deep pitch.¹ Even when they are played, the lowest valve notes can hardly be heard unless doubled an octave higher by another bombardon.

Bombardons are generally treated as non-transposing instruments, the music being written as sounded, except in France and Belgium, where transposition is usual. The intervening notes are obtained by means of pistons or valves, which, on being depressed, either admit the wind into additional lengths of tubing to lower the pitch, or cut off a length in order to raise it. Bombardons usually have three or four pistons lowering the pitch of the instrument respectively 1, 1, 1 and 2½ tones (in Belgium, 1, ½, 2 and 3 tones). The valve system, disposal of the tubing and shape and position of the bell differ considerably in the various models of well-known makers. In Germany and Austria² what is known as the cylinder action is largely used; for the piston or pump is substituted a four-way brass cock operated by means of a key and a series of cranks.

In order to obtain a complete chromatic scale throughout the compass, there must be, as on the slide-trombone, seven different positions or lengths of tubing available, each having its harmonic series. These different lengths are obtained on the bombardon by means of a combination of pistons: the simultaneous use of Nos. 2 and 3 lowers the pitch two tones; of Nos. 1, 2 and 3, three tones; of Nos. 1, 2, 3, 4, five and a half tones. A combination of pistons, however, fails to give the interval with an absolutely correct intonation, since the length of tubing thrown open is not of the theoretical length required to produce it. Many ingenious contrivances have been invented from time to time to remedy this inherent defect of the valve system, such as the six-valve independent system of Adolphe Sax; the Besson compensating system *transpositiv*; the Boosey automatic compensating piston invented by D. J. Buckley; and W. Mahillon's automatic regulating pistons. More recently the Besson euharmonic valve system, with its independent tuning slides and three pistons, and Rudall, Carte & Company's new (Kluisman's patent) bore, conical throughout the open tube and additional lengths, have produced instruments which leave nothing to be desired as to intonation. (See VALVES and TUBA.) (K. S.)

BOMBAY CITY, the capital of Bombay Presidency, and the chief seaport of western India, situated in 18° 55' N. and 72° 54' E. The city stands on an island of the same name, which forms one of a group now connected by causeways with the mainland. The area is 22 sq. m.; and the population of the town and island (1901) 776,006 (estimate in 1906, 977,822). Bombay is the second most populous city in the Indian empire, having fallen behind Calcutta at the census of 1901. Its position on the side of India nearest to Europe, its advantages as a port and a railway centre, and its monopoly of the cotton industry, are counteracted by the fact that the region which it serves cannot vie with the valley of the Ganges in point of fertility and has no great waterway like the Ganges or Brahmaputra. Nevertheless Bombay pushes Calcutta hard for supremacy in point of population and commercial prosperity.

The Bombay Island, or, as it ought to be more correctly called, the Bombay Peninsula, stands out from a coast ennobled by lofty hills, and its harbour is studded by rocky islands and precipices, whose peaks rise to a great height. The approach

from the sea discloses one of the finest panoramas in the world, — the only European analogy being the Bay of Naples. The island consists of a plain about 11 m. long by 3 broad, flanked by two parallel lines of low hills. A neck of land stretching towards the south-west forms the harbour on its eastern side, sheltering it from the force of the open sea, and enclosing an expanse of water from 5 to 7 m. wide. At the south-west of the island, Back Bay, a shallow basin rather more than 2 m. in breadth, runs inland for about 3 m. between the extreme points of the two ranges of hills. On a slightly raised strip of land between the head of Back Bay and the harbour is situated the fort, the nucleus of the city of Bombay. From this point the land slopes westward towards the central plain, a low-lying tract, which before the construction of the embankment known as the Hornby Vellard, used at high tide to be submerged by the sea. The town itself consists of well-built and unusually handsome native bazaars, and of spacious streets devoted to European commerce. In the native bazaar the houses rise three or four storeys in height, with elaborately carved pillars and front work. Some of the European hotels and commercial buildings are on the American scale, and have no rival in any other city of India. The Taj Mahal hotel, which was built by the Tata family in 1904, is the most palatial and modern hotel in India. The private houses of the European residents lie apart alike from the native and from the mercantile quarters of the town. As a rule, each is built in a large garden or compound; and although the style of architecture is less imposing than that of the stately residences in Calcutta, it is well suited to the climate, and has a beauty and comfort of its own. The favourite suburb is Malabar hill, a high ridge running out into the sea, and terraced to the top by handsome houses, which command one of the finest views, of its kind, in the world. Of recent years wealthy natives have been competing with Europeans for the possession of this desirable quarter. To the right of this ridge, looking towards the sea, runs another suburb known as Breach Candy, built close upon the beach and within the refreshing sound of the waves. To the left of Malabar hill lies Back Bay, with a promontory on its farther shore, which marks the site of the old Bombay Fort; its walls are demolished, and the area is chiefly devoted to mercantile buildings. Farther round the island, beyond the fort, is Mazagon Bay, commanding the harbour, and the centre of maritime activity. The defences of the port, remodelled and armed with the latest guns, consist of batteries on the islands in the harbour, in addition to which there are three large batteries on the mainland. There is also a torpedo-boat detachment stationed in the harbour.

No city in the world has a finer water-front than Bombay. The great line of public offices along the esplanade and facing Back Bay, which are in the Gothic style mixed with Saracenic, are not individually distinguished for architectural merit, but they have a cumulative effect of great dignity. The other most notable buildings in the city are the Victoria terminus of the Great Indian Peninsula railway and the Taj Mahal hotel. Towards the northern end of Malabar hill lie the Parsee Towers of Silence, where the Parsees expose their dead till the flesh is devoured by vultures, and then cast the bones into a well where they crumble into dust. The foundation-stone of a museum was laid by the prince of Wales in 1905.

Local Government.—The port of Bombay (including docks and warehouses) is managed by a port trust, the members of which are nominated by the government from among the commercial community. The municipal government of the city was framed by an act of the Bombay legislative council passed in 1888. The governing body consists of a municipal corporation and a town council. The corporation is composed of 72 members, of whom 16 are nominated by the government. Of the remainder, 36 are elected by the ratepayers, 16 by the justices of the peace, 2 by the senate of the university, and 2 by the chamber of commerce. The council, which forms the standing committee of the corporation, consists of 12 members, of whom 4 are nominated by the government and the rest elected by the corporation. The members of the corporation include Europeans,

¹ V. C. Mahillon, *Éléments d'acoustique musicale et instrumentale* (Bruxelles, 1874), p. 153.

² The bombardon is used in the military bands of Austria, but in those of Germany it has been superseded by a bass tuba differing slightly in form and construction from the bombardons and bass tubas used in England, France, Belgium and Austria.

Hindus, Mahomedans and Parsees. The Bombay University was constituted in 1857 as an examining body, on the model of the university of London. The chief educational institutions in Bombay City are the government Elphinstone College, two missionary colleges (Wilson and St Xavier), the Grant medical college, the government law school, the Sir Jamssetjee Jeejeebhoy school of art, and the Victoria Jubilee technical institute.

Docks.—The dockyard, originally built in 1736, has a sea-face of nearly 700 yds. and an area of about 200 acres. There are five graving docks, three of which together make one large dock 648 ft. long, while the other two make a single dock 582 ft. long. There are also four building slips opposite the Apollo Bandar (landing-place) on the south-east side of the enclosure. The dockyard is lighted by electricity, so that work can be carried on by night as well as day. Bombay is the only important place near the sea in India where the rise of the tide is sufficient to permit docks on the largest scale. The highest spring tides here reach 17 ft., but the average is 14 ft. Prince's dock, of which the foundation-stone was laid by the prince of Wales in 1875, was opened in 1879, and is 1460 ft. long by 1000 ft. broad, with a water area of 30 acres; while the Victoria dock, which was completed and opened in 1887-1888, has a water area of 25 acres. South of the Victoria dock, the foundation-stone of the Alexandra dock, the largest in India, was laid by the prince of Wales in 1905.

Cotton Mills.—The milling industry is, next to the docks, the chief feature of Bombay's commercial success. The staple manufacture is cotton-spinning, but in addition to this there are flour mills and workshops to supply local needs. The number of factories increased from fifty-three in 1881 to eighty-three in 1890, and that decade saw the influx of a great industrial population from the surrounding districts; but the decade 1891-1901 witnessed at least a temporary set-back owing to the ravages caused by plague and the effects of over-production. In addition to the actual mortality it inflicted, the plague caused an exodus of the population from the island, disorganized the labour at the docks and in the mills, and swallowed up large sums which were spent by the municipality on plague operations and sanitary improvements. After 1901, however, both population and trade began to revive again. In 1901 there were 131,796 persons employed in the cotton industry.

Population.—Owing to its central position between East and West and to the diversity of races in India, no city in the world can show a greater variety of type than Bombay. The Mahratta race is the dominant element next to the European rulers, but in addition to them are a great and influential section of Parsee merchants, Arab traders from the Gulf, Afghans and Sikhs from northern India, Bengalis, Rajputs, Chinese, Japanese, Malays, negroes, Tibetans, Sinhalese and Siamese. Bombay is the great port and meeting-place of the Eastern world. Out of the large sections of its population, Hindu, Mahomedan, Parsee, Jain and Christian, the Parsees are one of the smallest and yet the most influential. They number only some 46,000 all told, but most of the great business houses are owned by Parsee millionaires and most of the large charities are founded by them.

History.—The name of the island and city of Bombay is derived from Mumba (a form of Parvati), the goddess of the Kolis, a race of husbandmen and fishermen who were the earliest known inhabitants, having occupied the island probably about the beginning of the Christian era. Bombay originally consisted of seven islands (the *Heptanesia* of Ptolemy) and formed an outlying portion of the dominions of successive dynasties dominant in western India: Satavahanas, Mauryas, Chalukyas and Rashtrakutas. In the Maurya and Chalukya period (450-750) the city of Puri on Elephanta Island was the principal place in Bombay harbour. The first town built on Bombay Island was Mahikavati (Mahim), founded by King Bhima, probably a member of the house of the Yadavas of Deogiri, as a result of Ala-ud-din Khilji's raid into the Deccan in 1294. It remained under Hindu rule until 1348, when it was captured by a Mahomedan force from Gujarat; and the islands remained part of the province (later kingdom) of Gujarat till 1534, when they were ceded by Sultan Bahadur to the Portuguese.

The island did not prosper under Portuguese rule. By the system known as *aforamento* the lands were gradually parcelled out into a number of fiefs granted, under the crown of Portugal, to individuals or to religious corporations in return for military service or equivalent quit-rents: The northern districts were divided among the Franciscans and Jesuits, who built a number of churches, some of which still survive. The intolerance of their rule did not favour the growth of the settlement, which in 1661, when it was transferred to the British, had a population of only 10,000. The English had, however, long recognised its value as a naval base, and it was for this reason that they fought the battle of Swally (1614-1615), attempted to capture the place in 1626, and that the Surat Council urged the purchase of Bombay from the Portuguese. In 1654 the directors of the Company drew Cromwell's attention to this suggestion, laying stress on the excellence of its harbour and its safety from attack by land. It finally became the property of the British in 1661 as part of the dowry of the infanta Catherine of Portugal on her marriage to Charles II., but was not actually occupied by the British until 1665, when they experienced much difficulty in overcoming the opposition of the Portuguese, and especially of the religious orders, to the cession. In 1668 it was transferred by the crown to the East India Company, who placed it under the factory of Surat.

The real foundation of the modern city dates from this time, and was the work of Gerald Aungier (or Angier), brother of Francis Aungier, 3rd Lord Aungier of Longford and 1st earl of Longford in Ireland (d. 1700), who succeeded Sir George Oxenden as president of Surat in 1669 and died in 1677. At this time Bombay was threatened by the Mahrattas from inland, by the Malabar pirates and the Dutch from the sea, and was cut off from the mainland by the Portuguese, who still occupied the island of Salsette and had established a customs-barrier in the channel between Bombay and the shore. In spite of the niggardly policy of the court of directors, who refused to incur the expense of employing skilled engineers, Aungier succeeded in fortifying the town and shore; he also raised a force of militia and regulars, the latter mainly Germans (as more trustworthy than the ruffians collected in London by the Company's crimps). In 1672 Aungier transferred his headquarters to Bombay, and after frightening off an imposing Dutch fleet, which in 1670 attempted to surprise the island, set to work to organize the settlement anew. To this task he brought a mind singularly enlightened and a sincere belief in the best traditions of English liberty. In its fiscal policy, in its religious intolerance, and in its cruel and contemptuous treatment of the natives, Portuguese rule had been alike oppressive. Aungier altered all this. With the consent of "a general assembly of the chief representatives of the people" he commuted the burdensome land tax for a fixed money payment; he protected all castes in the celebration of their religious ceremonies; and he forbade any compulsion of natives to carry burdens against their will. The result was that the population of Bombay increased rapidly; a special quarter was set apart for the banya, or capitalist, class of Hindus; while Parsees and Armenians flocked to a city where they were secure of freedom alike for their trade and their religion. Within eight years the population had grown from 10,000 to 60,000. The immediate result of this concentration of people in a spot so unwholesome was the prevalence of disease, produced by the appalling sanitary conditions. This, too, Aungier set himself to remedy. In 1675 he initiated the works for draining the foul tidal swamps; and, failing the consent of the Company to the erection of a regular hospital, he turned the law court into an infirmary. He also set up three courts of justice: a tribunal for petty causes under a factor with native assessors, a court of appeal under the deputy governor and members of council, and a court-martial. A regular police force was also established and a gaol built in the Bazaar.¹

During this period, however, the position of Bombay was sufficiently precarious. The Malabar pirates, though the city itself was too strong for them, were a constant menace to its

¹ Hunter, *Hist. of British India*, ii. pp. 212, &c.

trade; and it required all the genius of Aungier to maintain the settlement, isolated as it was between the rival powers of the Mahrattas and the Mogul empire. After his death, on the 30th of June 1677, its situation became even more precarious. Even under Aungier the Siddi admirals of the Moguls had asserted their right to use Bombay harbour as winter quarters for their fleet, though they had failed to secure it as a base against the Mahrattas. Under his weak successor (Rolt, 1677-1682), the English waters, the value of which had now been proved, became the battle-ground between the rival navies, and for some years Bombay lay at the mercy of both. The Company's rule, moreover, was exposed to another danger. The niggardly policy of the board of directors, more intent on peaceful dividends than on warlike rule, could not but be galling to soldiers of fortune. A mutiny at Bombay in 1674 had only been suppressed by the execution of the ringleader; and in 1683 a more formidable movement took place under Richard Keigwin, a naval officer who had been appointed governor of St Helena in reward for the part played by him in the capture of the island from the Dutch in 1673. Keigwin, elected governor of Bombay by popular vote, issued a proclamation in the king's name, citing the "intolerable extortions, oppressions and exactions" of the Company, and declaring his government under the immediate authority of the crown. He ruled with moderation, reformed the system of taxation, obtained notable concessions from the Mahrattas, and increased the trade of the port by the admission of "interlopers." But he failed to extend the rebellion beyond Bombay; and when a letter arrived, under the royal sign manual, ordering him to surrender the fort to Sir John Child, appointed admiral and captain-general of the Company's forces, he obeyed.¹

Meanwhile the Company had decided to consider Bombay as "an independent settlement, and the seat of the power and trade of the English in the East Indies." But a variety of causes set back the development of the city, notably the prevalence of plague and cholera due to the siting up of the creeks that divided its component islands; and it was not till after the amalgamation of the old and new companies in 1708 that the governor's seat was transferred from Surat to Bombay. In 1718 the city wall was completed; settlers began to stream in, especially from distracted Gujarat; and a series of wise administrative reforms increased this tendency until in 1744 the population, which in 1718 had sunk to 16,000, had risen to 70,000. Meanwhile the Mahratta conquest of Bassein and Salsette (1737-1739) had put a stop to the hostility of the Portuguese, and a treaty of alliance with the Siddis (1733) had secured a base of supplies on the mainland. The French wars of 1744-1748 and 1756-1763 led to a further strengthening of the fortifications; and the influx of settlers from the mainland made the questions of supplies and of the protection of trade from piracy more pressing. The former was in part settled by the acquisition of Baskot (1755) as a result of an alliance with the peshwa, the latter by the successful expedition under Watson and Clive against Vijayadrag (1756). During this period, too, the importance of Bombay as a naval base, long since recognized, was increased by the building of a dock (1750), a second being added in 1762. The year 1770 saw the beginning of the cotton trade with China, the result of a famine in that country, the Chinese government having issued an edict commanding more land to be used for growing grain. This, too, was a period of searching reforms in the administration and the planning and building of the city; the result being a further immense growth of its population, which in 1780 was 113,000. This was still further increased by the famine of 1803, which drove large numbers of people from Konkan and the Deccan to seek employment in Bombay. A great fire broke out in the fort in the same year and caused enormous loss; but it enabled the government to open wider thoroughfares in the more congested parts, and greatly stimulated the tendency of the natives to build their houses and

shops outside the walls of the fort in what are now some of the busiest parts of the city.

The British victory over the Mahrattas and the annexation of the Deccan opened a new period of unrestricted development for Bombay. At this time, too (1819), its fortunes were vigorously fostered by Mountstuart Elphinstone, and in 1838 the population had risen to 236,000. But in the next fifty years it more than doubled itself, the figures for 1891 being 821,000. This great leap was due to the influence of railways, of which the first line was completed in 1853, the opening of the Suez Canal, and the foundation of cotton factories. In 1866-1867 the tide of prosperity was interrupted by a financial crisis, due to the fall in the price of cotton on the termination of the American war. Bombay, however, soon recovered herself, and in 1891 was more prosperous than ever before; but during the ensuing decade great havoc was played by plague (*q.v.*) with both her population and her trade. In addition to a decline of 6% in the population, the exports also declined by 7%, whereas Calcutta's exports rose during the same period by 38%.

See S. M. Edwardes, *The Rise of Bombay* (1902); James Douglas, *Bombay and Western India* (1893); G. W. Forrest, *Cities of India* (1903); Sir William Hunter, *History of British India* (London, 1900); *Imp. Gasetteer of India* (Oxford, 1908), s.v. "Bombay City."

BOMBAY FURNITURE. "Bombay blackwood furniture" is a term applied to a rather extensive class of articles manufactured in the city of Bombay and in the towns of Surat and Ahmedabad in India. The wood used is Shisham or blackwood (*Dalbergia*), a hard-grained dark-coloured timber which with proper treatment assumes a beautiful natural polish. Much of the so-called Bombay furniture is clumsy and inelegant in form, defects which it is suggested by experts, like Sir George Birdwood, it owes to the circumstance that the original models were Dutch. Some of the smaller articles, such as flower stands, small tables, and ornamental stands, are, however, of exceedingly graceful contour, and good examples are highly prized by collectors. The carving at its best is lace-like in character, and apart from its inherent beauty is attractive on account of the ingenuity shown by the worker in adapting his design in detail to the purpose of the article he is fashioning. The workmen who manufacture the most artistic Bombay furniture are a special class with inherited traditions. Often a man knows only one design, which has been transmitted to him by his father, who in his turn had had it from his father before him. In recent years under European auspices efforts have been made with a certain measure of success to modernize the industry by introducing portions of the native work into furniture of Western design. In the main, however, the conventional patterns are still adhered to. "Bombay boxes" are inlaid in geometrical patterns on wood. The inlaying materials consist of the wire, sandal wood, sapan wood, ebony, ivory and stag's horns, and the effect produced by the combination of minute pieces of these various substances is altogether peculiar and distinctive.

BOMBAY PRESIDENCY, a province or presidency of British India, consisting partly of British districts, and partly of native states under the administration of a governor. This territory extends from 13° 53' to 28° 45' N., and from 66° 40' to 76° 30' E., and is bounded on the N. by Baluchistan, the Punjab and Rajputana; on the E. by Indore, the Central Provinces and Hyderabad; on the S. by Madras and Mysore; and on the W. by the Arabian Sea. Within these limits lie the Portuguese settlements of Diu, Damaun and Goa, and the native state of Baroda which has direct relations with the government of India; while politically Bombay includes the settlement of Aden. The total area, including Sind but excluding Aden, is 188,745 sq. m., of which 122,984 sq. m. are under British and 65,761 under native rule. The total population (1901) is 25,468,209, of which 18,515,587 are resident in British territory and 6,908,622 in native states. The province is divided into four commissioner-ships and twenty-six districts. The four divisions are the northern or Gujarat, the central or Deccan, the southern or Carnatic, and Sind. The twenty-six districts are: Bombay City, Ahmedabad, Broach, Kaira, Panch Mahals, Surat, Thana,

¹ See Hunter, *op. cit.* ii. 208, &c. He received a full pardon, was appointed later to the command of a frigate in the royal navy, and fell while leading the assault on St Christopher's (June 21, 1694).

Ahmednagar, Khandesh (partitioned into two districts in 1906), Nasik, Poona, Satara, Sholapur, Belgaum, Bijapur, Dharwar, Kanara, Kolaba, Ratnagiri, Karachi, Hyderabad, Shikarpur, Thar and Parkar, and Upper Sind Frontier. The native states comprise in all 353 separate units, which are administered either by political agents or by the collectors of the districts in which the smaller states are situated. The chief groups of states are North Gujarat, comprising Cutch, Kathiawar agency, Palanpur agency, Mahi Kantha agency, Rewa Kantha agency and Cambay; South Gujarat, comprising Dharampur, Bansda and Sachin; North Konkan, Nasik and Khandesh, comprising Khandesh political agency, Surgana and Jawhar; South Konkan and Dharwar, comprising Janjira, Sawantwari and Savanur; the Deccan Satara Jagirs, comprising Akalkot, Bhor, Aundh, Phaltan, Jath and Daphlapur; the southern Mahratta states, comprising Kolhapur and other states, and Khairpur in Sind. The native states under the supervision of the government of Bombay are divided, historically and geographically, into two main groups. The northern or Gujarat group includes the territories of the gaekwar of Baroda, with the smaller states which form the administrative divisions of Cutch, Palanpur, Rewa Kantha, and Mahi Kantha. These territories, with the exception of Cutch, have an historical connexion, as being the allies or tributaries of the gaekwar in 1805, when final engagements were included between that prince and the British government. The southern or Mahratta group includes Kolhapur, Akalkot, Sawantwari, and the Satara and southern Mahratta Jagirs, and has an historical bond of union in the friendship they showed to the British in their final struggle with the power of the peshwa in 1818. The remaining territories may conveniently be divided into a small cluster of independent zamindaris, situated in the wild and hilly tracts at the northern extremity of the Sahyadri range, and certain principalities which, from their history or geographical position, are to some extent isolated from the rest of the presidency.

Physical Aspects.—The Bombay Presidency consists of a long strip of land along the Indian Ocean from the south of the Punjab to the north of Mysore. The coast is rock-bound and difficult of access; and though it contains several bays forming fair-weather ports for vessels engaged in the coasting trade, Bombay, Karachi-in-Sind, Marmagoa and Karwar alone have harbours sufficiently land-locked to protect shipping during the prevalence of the south-west monsoon. The coast-line is regular and little broken, save by the Gulfs of Cambay and Cutch, between which lies the peninsula of Kathiawar.

Speaking generally, a range of hills, known as the Western Ghats, runs down the coast, at places rising in splendid bluffs and precipices from the water's edge, at others retreating inland, and leaving a flat fertile strip of 5 to 50 m. between their base and the sea. In the north of the presidency on the right bank of the Indus, the Hala mountains, a continuation of the great Suleiman range, separate British India from the dominions of the khan of Kalat. Leaving Sind, and passing by the ridges of low sandhills,—the leading feature of the desert east of the Indus,—and the isolated hills of Cutch and Kathiawar, which form geologically the western extremity of the Aravalli range, the first extensive mountain range is that separating Gujarat from the states of central India. The rugged and mountainous country south of the Tapti forms the northern extremity of the Sahyadri or Western Ghats. This great range of hills, sometimes overhanging the ocean, and generally running parallel to it at a distance nowhere exceeding 50 m., with an average elevation of about 1800 ft., contains individual peaks rising to more than double that height. They stretch southwards for upwards of 500 m., with a breadth of 10 to 20 m. The western declivity is abrupt, the land at the base of the hills being but slightly raised above the level of the sea. As is usually the case with the trap formation, they descend to the plains in terraces with abrupt fronts. The landward slope is in many places very gentle, the crest of the range being sometimes but slightly raised above the level of the plateau of the Deccan. Their best-known elevation is Mahabaleswar, 4500 ft. high, a

fine plateau, 37 m. from Poona, covered with rich vegetation, and used by the Bombay government as its summer retreat and sanitarium. In the neighbourhood of the Sahyadri hills, particularly towards the northern extremity of the range, the country is rugged and broken, containing isolated peaks, masses of rock and spurs, which, running eastward, form watersheds for the great rivers of the Deccan. The Satpura hills separate the valley of the Tapti from the valley of the Nerbudda, and the district of Khandesh from the territories of Indore. The Satmala or Ajanta hills, which are rather the northern slope of the plateau than a distinct range of hills, separate Khandesh from the Nizam's Dominions.

The more level parts of Bombay consist of five well-demarcated tracts—Sind, Gujarat, the Konkan, the Deccan, and the Carnatic. Sind, or the lower valley of the Indus, is very flat, with *Plains:* but scanty vegetation, and depending for productiveness entirely on irrigation. Gujarat, except on its northern parts, consists of rich, highly cultivated alluvial plains, watered by the Tapti and Nerbudda, but not much subject to inundation. The Konkan lies between the Western Ghats and the sea. It is a rugged and difficult country, intersected by creeks, and abounding in isolated peaks and detached ranges of hills. The plains of the Deccan and Khandesh are watered by large rivers, but as the rainfall is uncertain, they are generally, during the greater part of the year, bleak and devoid of vegetation. The Carnatic plain, or the country south of the river Kistna, consists of extensive tracts of black or cotton soil in a high state of cultivation.

The chief river of western India is the Indus, which enters the presidency from the north of Sind and flowing south in a tortuous course, falls into the Arabian Sea by several *Rivers.* mouths, such as the Ghizri creek, Khudi creek, Pitiani creek, Sisa creek, Hajamro creek, Vatho creek, Mall creek, Wari creek, Bhiitara creek, Sir creek and Khori creek. In the dry season the bed varies at different places from 480 to 1600 yds. The flood season begins in March and continues till September, the average depth of the river rising from 9 to 24 ft., and the velocity of the current increasing from 3 to 7 m. an hour. Next to the Indus comes the Nerbudda. Rising in the Central Provinces, and traversing the dominions of Holkar, the Nerbudda enters the presidency at the north-western extremity of the Khandesh district, flows eastward, and after a course of 700 m. from its source, falls into the Gulf of Cambay, forming near its mouth the alluvial plain of Broach, one of the richest districts of Bombay. For about 100 m. from the sea the Nerbudda is at all seasons navigable by small boats, and during the rains by vessels of from 30 to 50 tons burden. The Tapti enters the presidency a few miles south of the town of Burhanpur, a station on the Great Indian Peninsula railway, flows eastward through the district of Khandesh, the native state of Rewa Kantha and the district of Surat, and falls into the Gulf of Cambay, a few miles west of the town of Surat. The Tapti drains about 250 m. of country, and is, in a commercial point of view, the most useful of the Gujarat rivers. Besides these there are many minor streams. The Banas and the Saraswati take their rise in the Aravalli hills, and flowing eastward through the native state of Palanpur, fall into the Rann of Cutch. The Sabarmati and the Mahi rise in the Mahi Kantha hills, and flowing southwards, drain the districts of Northern Gujarat, and fall into the sea near the head of the Gulf of Cambay. The streams which, rising in the Sahyadri range, or Western Ghats, flow westward into the Arabian Sea, are of little importance. During the rains they are formidable torrents, but with the return of the fair weather they dwindle away, and during the hot season, with a few exceptions, they almost dry up. Clear and rapid as they descend the hills, on reaching the lowlands of the Konkan they become muddy and brackish creeks. The Kanarese rivers have a larger body of water and a more regular flow than the streams of the Konkan. One of them, the Sharavati, forcing its way through the western ridge of the Ghats, plunges from the high to the low country by a succession of falls, the principal of which is 890 ft. in height. The Sahyadri, or Western Ghats, also throw off to the eastward

the two principal rivers of the Madras Presidency, the Godavari and the Krishna. These rivers collect countless tributary streams, some of them of considerable size, and drain the entire plain of the Deccan as they pass eastward towards the Bay of Bengal.

The Manchar Lake is situated on the right bank of the Indus. During inundations it attains a length of 20 m., and a breadth of 10, covering a total area estimated at 180 sq. m.

But the most peculiar lacustrine feature of the presidency is the Rumm or Lake of Cutch, which, according to the season of the year, is a salt marsh, an inland lake, or an arm of the sea with an area of 8000 sq. m. It forms the western boundary of the province of Gujarat, and when flooded during the rains unites the Gulfs of Cutch and Cambay, and converts the territory of Cutch into an island.

Geology.—South of Gujarat nearly the whole of Bombay is covered by the horizontal lava flows of the Deccan Trap series, and these flows spread over the greater part of the Kathiawar peninsula and extend into Cutch. In Cutch and Kathiawar they are underlaid by Jurassic and Neocomian beds. The Jurassic beds are marine and contain numerous Ammonites, but the beds which are referred to the Neocomian include a series of sandstones and shales with remains of plants. Several of the plants are identical with forms which occur in the upper portion of the Gondwana system. Tertiary limestones, sandstones and shales overlie the Deccan Trap in Cutch, but the greatest development of deposits of this age is to be met with on the western side of the Indus (see SIND). The plain of Sind and of eastern Gujarat is covered by alluvium and wind-blown sand.

Climate.—Great varieties of climate are met with in the presidency. In its extreme dryness and heat, combined with the aridity of a sandy soil, Upper Sind resembles the sultry deserts of Africa. The mean maximum temperature at Hyderabad, in Lower Sind, during the six hottest months of the year, is 98° F. in the shade, and the water of the Indus reaches blood heat; in Upper Sind it is even hotter, and the thermometer has been known to register 130° in the shade. In Cutch and in Gujarat the heat, though less, is still very great. The Konkan is hot and moist, the fall of rain during the monsoon sometimes approaching 300 in. The table-land of the Deccan above the Ghats, on the contrary, has an agreeable climate except in the hot months, as has also the southern Mahratta country; and in the hills of Mahabaleshwar, Singarh, and other detached heights, Europeans may go out at all hours with impunity. Bombay Island itself, though in general cooled by the sea breeze, is oppressively hot during May and October. The south-west monsoon generally sets in about the first week in June, and pours down volumes of rain along the coast. From June to October travelling is difficult and unpleasant, except in Sind, where the monsoon rains exert little influence.

Forests.—Bombay Presidency possesses two great classes of forests—those of the hills and those of the alluvial plains. The hill forests are scattered over a wide area, extending from 23° to 14° N. lat. Most of them lie among the Sahyadri hills or Western Ghats. The alluvial forests lie in Sind, on or close to the banks of the Indus, and extend over an area of 550 sq. m. The principal timber trees in the forests are—teak; blackwood of two varieties (*Dalbergia Siss* and *Dalbergia latifolia*), *Dalbergia sissoensis*, *Pterocarpus Marsupium*, *Terminalia glabra*, *Acacia arabica*, *Acacia Catechu*, *Nasuclea cordifolia*, *Nasuclea parvifolia*, *Biddia spinosa*, *Hardwickia binata*, *Juga zylacarpa*, *Populus euphratica*, and *Tamarindus indica*. The forests contain many trees which, on account of their fruits, nuts or berries, are valuable, irrespective of the quality of their timber. Among these are the mango (*Mangifera indica*); the jack (*Artocarpus integrifolia*), *Zizyphus Jujuba*, *Aegle Marmelos*, *Terminalia Cheula*, *Calophyllum Inophyllum*, *Bassia latifolia* and *Pongamia glabra*. The jungle tribes collect gum from several varieties of trees, and in Sind the Forest Department derives a small revenue from lac. The palms of the presidency consist of cocoa-nut, date, palmyra and areca catechu.

Population.—The census of 1901 gave a total of 25,468,209, out of which the chief religions furnished the following numbers:—

Hindu	19,916,438
Mahomedan	4,567,295
Jain	535,950
Zoroastrian	78,552
Christian	216,118

In Sind Islam has been the predominant religion from the earliest Arab conquest in the 8th century. In Gujarat the predominant religion is Hinduism, though petty Mahomedan kingdoms have left their influence in many parts of the province. The Deccan is the home of the Mahrattas, who constitute 30% of the population. The Konkan is notable for various Christian castes, owing their origin to Portuguese rule; while in the Carnatic, Lingayatism, a Hindu reformation movement of the 12th century, has been embraced by 45% of the population. The Mahrattas are the dominating race next to the Europeans and number (1901) 3,650,000, composed of 1,900,000 Kunbis, 350,000 Konkanis, and 1,400,000 Mahrattas not otherwise specified.

Languages.—The chief languages of the presidency are Sindhi in Sind, Cutchi in Cutch, Gujarati and Hindustani in Gujarat, Mahratti in Thana and the central division, Gujarati and Mahratti in Khandesh, and Mahratti and Kanarese in the southern division. There are also Bhil (120,000) and Gipsy (30,000) dialects.

Agriculture.—The staple crops are as follows:—Joar (*Sorghum vulgare*) and bajra (*Eolcus spicatus*) are the staple food grains in the Deccan and Khandesh. Rice is the chief product of the Konkan. Wheat, generally grown in the northern part of the Presidency, but specially in Sind and Gujarat, is exported to Europe in large quantities from Karachi, and on a smaller scale from Bombay. Barley is principally grown in the northern parts of the presidency. Nachani (*Eleusine coracana*) and kodra (*Paspalum scrobiculatum*), inferior grains grown on the hill-sides, furnish food to the Kolis, Bhils, Waralis, and other aboriginal tribes. Of the pulses the most important are gram (*Cicer arisinum*), tur (*Cajanus indicus*), kulti (*Dolichos biflorus*), and mug (*Phaseolus Mungo*). Principal oil-seeds: til (*Sesamum orientale*), mustard, castor-oil, safflower and linseed. Of fibres the most important are cotton, Deccan hemp (*Hibiscus cannabinus*), and sunn or tag (*Crotalaria juncea*). Much has been done to improve the cotton of the presidency. American varieties have been introduced with much advantage in the Dharwar collectorate and other parts of the southern Mahratta country. In Khandesh the indigenous plant from which one of the lowest classes of cotton in the Bombay market takes its name has been almost entirely superseded by the superior Hinganghat variety. Miscellaneous crops: sugar-cane, requiring a rich soil and a perennial water-supply, and only grown in favoured localities, red pepper, potatoes, turmeric and tobacco.

Manufactures.—The chief feature of the modern industrial life of Bombay is the great development in the growth and manufacture of cotton. Large steam mills have rapidly sprung up in Bombay City, Ahmedabad and Khandesh. In 1905 there were 432 factories in the presidency, of which by far the greater number were engaged in the preparation and manufacture of cotton. The industry is centred in Bombay City and Island, which contains nearly two-thirds of the mills. During the decade 1891-1901 the mill industry passed through a period of depression due to widespread plague and famine, but on the whole there has been a marked expansion of the trade as well as a great improvement in the class of goods produced. In addition to the mills there are (1901) 178,000 hand-loom weavers in the province, who still have a position of their own in the manipulation of designs woven into the cloth. Silk goods are manufactured in Ahmedabad, Surat, Yeola, Nasik, Thana and Bombay, the material being often decorated with printed or woven designs; but owing to the competition of European goods most branches of the industry are declining. The custom of investing savings in gold and silver ornaments gives employment to many goldsmiths; the metal is usually supplied by the customer, and

the goldsmith charges for his labour. Ahmedabad and Surat are famous for their carved wood-work. Many of the houses in Ahmedabad are covered with elaborate wood-carving, and excellent examples exist in Broach, Baroda, Surat, Nasik and Yeola. Salt is made in large quantities in the government works at Kharaghoda and Udu in Ahmedabad, whence it is exported by rail to Gujarat and central India. There is one brewery at Dapuri near Poona.

Railways and Irrigation.—The province is well supplied with railways, all of which, with one exception, concentrate at Bombay City. The exception is the North-Western line, which enters Sind from the Punjab and finds its natural terminus at Karachi. The other chief lines are the Great Indian Peninsula, Indian Midland, Bombay, Baroda & Central India, Rajputana-Malwa & Southern Mahratta systems. In 1905 the total length of railway under the Bombay government open for traffic was 7980 m. These figures do not include the railway system in Sind. With the exception of Sind, the water-supply of the Bombay Presidency does not lend itself to the construction of large irrigation works.

Army.—Under Lord Kitchener's re-arrangement of the Indian army in 1904 the old Bombay command was abolished and its place was taken by the Western army corps under a lieutenant-general. The army corps was divided into three divisions under major-generals. The 4th division, with headquarters at Quetta, comprises the troops in the Quetta and Sind districts. The 5th division, with headquarters at Mhow, consists of three brigades, located at Nasirabad, Jubbulpore and Jhansi, and includes the previous Mhow, Deesa, Nagpur, Nerbudda and Bundelkhand districts/ with the Bombay district north of the Tapti. The 6th division, with headquarters at Poona, consists of three brigades, located at Bombay, Ahmednagar and Aden. It comprises the previous Poona district, Bombay district south of the Tapti, Belgaum district north of the Tungabhadra, and Dharwar and Aurungabad districts.

Education.—The university of Bombay, established in 1857, is a body corporate, consisting of a chancellor, vice-chancellor and fellows. The governor of Bombay is *ex officio* chancellor. The education department is under a director of public instruction, who is responsible for the administration of the department in accordance with the general educational policy of the state. The native states have generally adopted the government system. Baroda and the Kathiawar states employ their own inspectors. In 1905 the total number of educational institutions was 10,194 with 593,431 pupils. There are ten art colleges, of which two are managed by government, three by native states, and five are under private management. According to the census of 1901, out of a population of 25½ millions nearly 24 millions were illiterate.

Administration.—The government of Bombay is administered by a governor in council consisting of the governor as president and two ordinary members. The governor is appointed from England; the council is appointed by the crown, and selected from the Indian civil service. These are the executive members of government. For making laws there is a legislative council, consisting of the governor and his executive council, with certain other persons, not fewer than eight or more than twenty, at least half of them being non-officials. Each of the members of the executive council has in his charge one or two departments of the government; and each department has a secretary, an under-secretary, and an assistant secretary, with a numerous staff of clerks. The political administration of the native states is under the superintendence of British agents placed at the principal native courts; their position varies in different states according to the relations in which the principalities stand with the paramount power. The administration of justice throughout the presidency is conducted by a high court at Bombay, consisting of a chief justice and seven puisne judges, along with district and assistant judges throughout the districts of the presidency. The administration of the districts is carried on by collectors, assistant collectors, and a varying number of supernumerary assistants.

History.—In the earliest times of which any record remains the greater part of the west coast of India was occupied by Dravidian tribes, living under their kings in fortified villages, carrying on the simpler arts of life, and holding a faith in which the propitiation of spirits and demons played the chief part. There is evidence, however, that so early as 1000 B.C. an export trade existed to the Red Sea by way of East Africa, and before 750 B.C. a similar trade had sprung up with Babylon by way of the Persian Gulf. It was by this latter route that the traders brought back to India the Brahmī alphabet, the art of brick-making and the legend of the Flood. Later still the settlement of Brahmans along the west coast had already Aryanized the country in religion, and to some extent in language, before the Persian conquest of the Indus valley at the close of the 6th century B.C. The Persian dominion did not long survive; and the march of Alexander the Great down the Indus paved the way for Chandragupta and the Maurya empire. Under this empire Ujjain was the seat of a viceroy, a prince of the imperial house, who ruled over Kathiawar, Malwa and Gujarat. On the death of Asoka in 231 B.C. the empire of the Mauryas broke up, and their heritage in the west fell to the Andhra dynasty of the Satavahanas of Paithan on the Godavari, a Dravidian family whose dominion by 200 B.C. stretched across the peninsula from the deltas of the Godavari and Kistna to Nasik and the Western Ghats. About A.D. 210, however, their power in the west seems to have died out, and their place was taken by the foreign dynasty of the Kahaharatas, the Saka satraps of Surashtra (Kathiawar), who in 120 had mastered Ujjain and Gujarat and had built up a rival kingdom to the north. Since about A.D. 40 the coast cities had been much enriched by trade with the Roman empire, which both the Satavahanas and the satraps did much to encourage; but after the fall of Palmyra (273) and the extinction of the main Kahaharata dynasty (c. 300) this commerce fell into decay. The history of the century and a half that follows is very obscure; short-lived Saka dynasties succeeded one another until, about 388, the country was conquered by the Guptas of Magadha, who kept a precarious tenure of it till about 470, when their empire was destroyed by the White Huns, or Ephthalites (q.v.), who, after breaking the power of Persia and assailing the Kushan kingdom of Kabul, poured into India, conquered Sind, and established their dominion as far south as the Nerbudda.

Under the Hun tyranny, which lasted till the overthrow of the White Huns on the Oxus by the Turks (c. 565), native dynasties had survived, or new ones had established themselves. In Kathiawar a chief named Bhatraka, probably of foreign origin, had established himself at Valabhi (Wala) on the ruins of the Gupta power (c. 500), and founded a dynasty which lasted until it was overthrown by Arab invaders from Sind in 770.¹ The northern Konkan was held by the Mauryas of Puri near Bombay, the southerly coast by the Kadambas of Vanavasi, while in the southern Deccan Chalukyas and Rashtrakutas struggled for the mastery. A new power, too, appeared from the north: the Gurjaras (ancestors, it is supposed, of the Gujar caste), who had probably entered India with the White Huns, established their power over Gujarat and (c. 600) overran north-eastern Kathiawar, made the raja of Valabhi their tributary, and established a branch at Broach (585-740). During the short-lived empire of Harsha (d. 647 or 648), Malwa, Gujarat and Kathiawar were subject to his sway; but the southern boundary of his kingdom was the Nerbudda, south of which the Chalukyas in the 7th century, having overcome the Rashtrakutas and other rivals, had absorbed the smaller kingdoms into their empire. In 710-711 (92 A.H.) the Arabs invaded India, and in 712 conquered and established themselves in Sind; they did not, however, attempt any serious attack on the Gurjara and Chalukya empires, confining themselves to more or less serious raids. In 770 they destroyed the city of Valabhi and, as already mentioned, brought its dynasty to an end. Meanwhile the Chalukyas, after successfully struggling with the Pallavas (whose capital was taken by Vikramaditya II., c. 740), had in their turn succumbed to their ancient rivals the Rashtrakutas, who succeeded

¹ V. A. Smith, *Early History of India*, p. 295.

to the bulk of their dominions, including Gujarat, where they had set up a branch line. For some two centuries (c. 750-950) there was a balance of power between the Gurjaras and Rashtrakutas, neither kingdom being strong enough to encroach on the other to any extent. The Rashtrakutas were, moreover, debarred from large schemes of conquest by dissensions with the branch dynasty which they had set up in Gujarat and by the constant threat of attack by the Chalukyas from Mysore. Nevertheless their power and magnificence (they were notable builders and patrons of literature) greatly impressed the Arabs, by whom the king was known as Balharā (*i.e.* *Vallhara*, "well-beloved"), a title borrowed from the preceding dynasty. Under them the Konkan and the coast farther south were governed by chiefs of the Silahara family, whose rule is mainly notable for the revival of trade with the Persian Gulf and, doubtless as a result of this, the arrival in 775 on the west coast of a number of Parsee refugees, who found, in a country where three religions were already equally honoured, the toleration denied to them in Mussulman Persia. But in the 10th century the Rashtrakuta power began to break up; in 961 Mularaja Solanki (Chalukya) conquered the kingdom of Anhilvada (Anhilvara) in Gujarat, where his dynasty reigned till 1242; and twelve years later the Chalukyas once more overthrew the Rashtrakutas in the Deccan, establishing their capital at Kalyani, while a branch line was set up in southern Gujarat. Farther south the Silaharas, however, continued to rule the coast, and succeeded in maintaining their independence until after the final fall of the Chalukyas in 1192. The cause of the downfall of the dynasty, splendid and enlightened as any of its predecessors, was the system of governing by means of great feudatories, which also proved fatal to the Solanki rajas of Anhilvada. From 1143 onward the power of the latter had been overshadowed by that of the Vaghela chiefs of Dholka, and during the same period the Deccan had been rapidly lapsing into absolute anarchy, amid which rival chiefs struggled for the supreme power. In the end the Yadavas of Devagiri (Daulatabad) prevailed, and in 1192 established a short-lived empire to which the Dholka princes were ultimately forced to become tributary.

But meanwhile a new power had appeared, which was destined to establish the Mussulman domination in western and southern India. In 1023 Mahmud of Ghazni had already invaded Gujarat with a large army, destroyed the national Hindu idol of Somnath, and carried away an immense booty. Mahommed Ghorī also invaded Gujarat, and left a garrison in its capital. But it was not till after the Mussulman power was firmly established in northern India that the Mahomedan sovereigns of Delhi attempted the conquest of the south. In 1294 the emperor Ala-ud-din first invaded the Deccan; and in 1297 he conquered Gujarat. In 1312 the Mahomedan arms were triumphant through the Mahratta country; and seven years later the whole of Malabar fell a prey to the invaders. In the middle of the 14th century the weakness of the Delhi sovereigns tempted the governors of provinces to revolt against their distant master, and to form independent kingdoms. In this way the Bahmani kingdom was established in the Deccan, and embraced a part of the Bombay presidency. Ahmednagar and Gujarat also became the seats of a new kingdom. In 1573 Akbar conquered Gujarat and reannexed it to the empire; in 1599 he effected the reconquest of Khandesh, and in 1600 that of Ahmednagar. From this time the country was never tranquil, and Ahmednagar became the focus of constant rebellions. During the latter part of the 17th century the Mahrattas rose into power, and almost every part of the country now comprising the presidency of Bombay fell under their sway. In 1498 the Portuguese came first to Calicut, their earliest possession in the presidency being the island of Anjidiv. After their victory at Diu over the Egyptian fleet their mastery of the Indian Ocean was undisputed, and they proceeded to establish themselves on the coast. They captured Goa in 1510, Malacca in 1511, and Ormuz in 1515. They next took advantage of the decay of the kingdom of Gujarat to occupy Chaul (1531), Bassein with its dependencies, including Bombay (1534), Diu (1535) and Daman (1559). But the inherent

vices of their intolerant system undermined their power, even before their Dutch and English rivals appeared on the scene.

The first English settlement in the Bombay presidency was in 1618, when the East India Company established a factory at Surat, protected by a charter obtained from the emperor Jahangir. In 1626 the Dutch and English made an unsuccessful attempt to gain possession of the island of Bombay, and in 1653 proposals were suggested for its purchase from the Portuguese. In 1661 it was ceded to the English crown, as part of the dowry of the infanta Catherine of Portugal on her marriage with Charles II. So lightly was the acquisition esteemed in England, and so unsuccessful was the administration of the crown officers, that in 1668 Bombay was transferred to the East India Company for an annual payment of £10. At the time of the transfer, powers for its defence and for the administration of justice were also conferred; a European regiment was enrolled; and the fortifications erected proved sufficient to deter the Dutch from their intended attack in 1673 (see BOMBAY CITY: *History*). In 1687 Bombay was placed at the head of all the Company's possessions in India; but in 1753 the government of Bombay became subordinate to that of Calcutta. The first collision of the English with the Mahratta power was in 1774 and resulted in 1782 in the treaty of Salbai, by which Salsette was ceded to the British, while Broach was handed over to Sindhia. More important were the results of the second Mahratta war, which ended in 1803. Surat had already been annexed in 1800; the East India Company now received the districts of Broach, Kaira, &c.

In 1803 the Bombay presidency included only Salsette, the islands of the harbour (since 1774), Surat and Bankot (since 1756); but between this date and 1827 the framework of the presidency took its present shape. The Gujarat districts were taken over by the Bombay government in 1805 and enlarged in 1818; and the first measures for the settlement of Kathiawar and Mahi Kantha were taken between 1807 and 1820. Baji Rao, the last of the peshwas, who had attempted to shake off the British yoke, was defeated, captured and pensioned (1817-1818), and large portions of his dominions (Poona, Ahmednagar, Nasik, Sholapur, Belgaum, Kaladgi, Dharwar, &c.) were included in the presidency, the settlement of which was completed by Mountstuart Elphinstone, governor from 1819 to 1827. His policy was to rule as far as possible on native lines, avoiding all changes for which the population was not yet ripe; but the grosser abuses of the old régime were stopped, the country was pacified, the laws were codified, and courts and schools were established. The period that followed is notable mainly for the enlargement of the presidency through the lapse of certain native states, by the addition of Aden (1839) and Sind (1843), and the lease of the Panch Mahals from Sindhia (1853). The establishment of an orderly administration, one outcome of which was a general fall of prices that made the unwonted regularity of the collection of taxes doubly unwelcome, naturally excited a certain amount of misgiving and resentment; but on the whole the population was prosperous and contented, and under Lord Elphinstone (1853-1860) the presidency passed through the crisis of the Mutiny without any general rising. Outbreaks among the troops at Karachi, Ahmedabad and Kolhapur were quickly put down, two regiments being disbanded, and the rebellions in Gujarat, among the Bhils, and in the southern Mahratta country were local and isolated. Under Sir Bartle Frere (1862-1867) agricultural prosperity reached its highest point, as a result of the American Civil War and the consequent enormous demand for Indian cotton in Europe. The money thus poured into the country produced an epidemic of speculation known as the "Share Mania" (1864-1865), which ended in a commercial crisis and the failure of the bank of Bombay (1866). But the peasantry gained on the whole more than they lost, and the trade of Bombay was not permanently injured. Sir Bartle Frere encouraged the completion of the great trunk lines of railways, and with the funds obtained by the demolition of the town walls (1862) he began the magnificent series of public buildings that now adorn Bombay.

During recent times the entire history of Bombay has been sadly affected by plague and famine. Bubonic plague, of a fatal and contagious nature, first broke out in Bombay City in September 1896, and, despite all the efforts of the government, quickly spread to the surrounding country. Down to the end of October 1902 over 531,000 deaths had taken place due to plague. In 1903-1904 there were 426,387 cases with 316,523 deaths, and 1904-1905 there were 285,897 cases with 212,948 deaths. The great cities of Bombay, Karachi and Poona suffered most severely. A few districts in Gujarat almost entirely escaped; but the mortality was very heavy in Satara, Thana, Surat, Poona, Kolaba, and in the native states of Cutch, Baroda, Kolhapur and Palanpur. The only sanitary measure that can be said to have been successful was complete migration, which could only be adopted in villages and smaller towns. Inoculation was extensively tried in some cases. Segregation was the one general method of fighting the disease; but, unfortunately, it was misunderstood by the people and led to some deplorable outbreaks. In Poona, during 1897, two European officials were assassinated; the editor of a prominent native paper was sentenced to imprisonment for sedition; and two leaders of the Brahman community were placed in confinement. At Bombay, in March 1898, a riot begun by Mahomedan weavers was not suppressed until several Europeans had been fatally injured. In Nasik district, in January 1898, the native chairman of the plague committee was brutally murdered by a mob. But on the whole the people submitted with characteristic docility to the sanitary regulations of the government. Bombay, like the Central Provinces, suffered from famine twice within three years. The failure of the monsoon of 1896 caused widespread distress throughout the Deccan, over an area of 46,000 sq. m., with a population of 7 millions. The largest number of persons on relief was 301,056 in September 1897; and the total expenditure on famine relief was Rs. 1,28,000,000. The measures adopted were signally successful, both in saving life and in mitigating distress. In 1899 the monsoon again failed in Gujarat, where famine hitherto had been almost unknown; and the winter rains failed in the Deccan, so that distress gradually spread over almost the entire presidency. The worst feature was a virulent outbreak of cholera in Gujarat, especially in the native states. In April 1900 the total number of persons in receipt of relief was 1,281,159 in British districts, 566,671 in native states, and 71,734 in Baroda. For 1900-1901 the total expenditure on famine relief was nearly 3 crores (say, £2,000,000 sterling); and a continuance of drought necessitated an estimate of 1 crore in the budget of the following year. The Bombay government exhausted its balances in 1897, and was subsequently dependent on grants from the government of India.

See Sir James Campbell, *Gazetteer of Bombay* (26 vols., 1896); S. M. Edwardes, *The Rise of Bombay* (1902); James Douglas, *Bombay and Western India* (1893); and Sir William Lee-Warner, *The Presidency of Bombay* (Society of Arts, 1904); *The Imperial Gazetteer of India* (Oxford, 1908); and for the early history, V. A. Smith, *The Early History of India* (2nd ed., Oxford, 1908).

BOMBAZINE, or **BOMBASINE**, a stuff originally made of silk or silk and wool, and now also made of cotton and wool or of wool alone. Good bombazine is made with a silk warp and a worsted weft. It is twilled or corded and used for dress-material. Black bombazine has been used largely for mourning, but the material has gone out of fashion. The word is derived from the obsolete French *bombasin*, applied originally to silk but afterwards to "tree-silk" or cotton. Bombazine is said to have been made in England in Queen Elizabeth's reign, and early in the 19th century it was largely made at Norwich.

BOMBELLES, **MARC MARIE**, **MARQUIS DE** (1744-1822), French diplomatist and ecclesiastic, was the son of the comte de Bombelles, tutor and guardian of the duke of Orleans. He was born at Bitsch in Lorraine, and served in the army through the Seven Years' War. In 1765 he entered the diplomatic service, and after several diplomatic missions became ambassador of France to Portugal in 1786, being charged to win over that country to the Family Compact; but the madness of the queen

and then the death of the king prevented his success. He was transferred to Vienna early in 1789, but the Revolution cut short his diplomatic career, and he was deprived of his post in September 1790. He remained attached to Louis XVI., and was employed on secret missions to other sovereigns, to gain their aid for Louis. In 1792 he emigrated, and after Valmy lived in retirement in Switzerland. In 1804, after the death of his wife, he withdrew to the monastery of Brunn in Austria, and became bishop of Oberglogau in Prussia. In 1815 he returned to France, and became bishop of Amiens (1819). He died in Paris in 1822.

His son, **LOUIS PHILIPPE**, comte de Bombelles (1780-1843), born at Regensburg, passed his life in the diplomatic service of Austria. In 1814 he became Austrian ambassador to Denmark, and in 1816 filled a similar position at Dresden. (E. Ea.)

BOMBERG, **DANIEL**, a famous Christian printer of Hebrew books. His chief activity was in Venice between 1516 and 1549 (the year of his death). Bomberg introduced a new era in Hebrew typography. Among other great enterprises, he published the *editio princeps* (1516-1517) of the rabbinical Bible (Hebrew text with rabbinical commentaries, &c.). He also produced the first complete edition of the Talmud (1520-1523).

BONA, **JOHN** (1609-1674), Italian cardinal and author, was born at Mondovi in Piedmont, on the 10th of October 1609. In 1624 he joined the Congregation of Feuillants and was successively elected prior of Asti, abbot of Mondovi and general of his order. He was created cardinal in 1669 by Clement IX., and during the conclave, which followed that pope's death, was regarded as a possible candidate for the papacy. He died on the 27th of October 1674. Bona's writings are mainly concerned with liturgical and devotional subjects. Of the numerous editions of his works, the best are those of Paris (1677), Lurin (1747) and Antwerp (1777). Stores of interesting rubrical information, interspersed with verses and prayers, are to be found in the *De Libris Liturgicis* and the *Divina Psalmodia*; recent advances in liturgical studies, however, have somewhat lessened their value. The *De Discretione Spirituum* treats of certain higher phases of mysticism; the *Via Compendii ad Deum* was well translated in 1876 by Henry Collins, O. Cist., under the title of *An Easy Way to God*. Sir Roger L'Estrange's translation (*The Guide to Heaven*, 1680) of the *Manuductio ad Coelum* was reprinted in 1898, and a new edition of the *Principia Vitae Christianae*, ed. by D. O'Connor, appeared in 1906. The devotional treatise *De Sacrificio Missae* is the classical work in its field (new edition by Ildephonus Cummins, 1903).

The chief source for the life of Bona is the biography by the Cistercian abbot Bertolotti (Asti, 1677); the best modern study is by A. Ighina (Mondovi, 1874).

BONA (Bône), a seaport of Algeria, in 36° 53' N., 7° 46' E., on a bay of the Mediterranean, chief town of an arrondissement in the department of Constantine, 220 m. by rail W. of Tunis, and 136 m. N.E. of Constantine. The town, which is situated at the foot of the wooded heights of Edugh, is surrounded with a modern rampart erected outside the old Arab wall, the compass of which was found too small for its growth. Much of the old town has been demolished, and its general character now is that of a flourishing French city. The streets are wide and well laid out, but some are very steep. Through the centre of the town runs a broad tree-lined promenade, the Cours Jérôme-Bertagna, formerly the Cours National, in which are the principal buildings—theatre, banks, hotels. At its southern end, by the quay, is a bronze statue of Thiers, and at the northern end, the cathedral of St Augustine, a large church built in quasi-Byzantine style. In it is preserved a relic supposed to be the right arm of St Augustine, brought from Pavia in 1842. The Grand Mosque, built out of ruins of the ancient Hippo, occupies one side of the chief square, the Place d'Armes. There are barracks with accommodation for 3000 men, and civil and military hospitals. The Kasbah (citadel) stands on a hill at the north-east of the town. The inner harbour, covering 25 acres, is surrounded by fine quays at which vessels drawing 22 ft. can be moored. Beyond is a spacious outer harbour, built 1857-1868 and enlarged in

1905-1907. Bona is in direct steamship communication with Marseilles, and is the centre of a large commerce, ranking after Algiers and Oran alone in Algeria. It imports general merchandise and manufactures, and exports phosphates, iron, zinc, barley, sheep, wool, cork, esparto, &c. There are manufactories of native garments, tapestry and leather. The marshes at the mouths of the Seybuse and Bujema rivers, which enter the sea to the south of Bona, have been drained by a system of canals, to the improvement of the sanitary condition of the town, which has the further advantage of an abundant water supply obtained from the Edugh hills. There are cork woods and marble quarries in the vicinity, and the valley of the Seybuse and the neighbouring plains are rich in agricultural produce. The population of the town of Bona in 1906 was 36,004, of the commune 42,934, of the arrondissement, which includes La Calle (q.v.) and 11 other communes, 77,803.

Bona is identified with the ancient *Aphrodisium*, the seaport of *Hippo Regius* or *Ubbo*, but it derives its name from the latter city, the ruins of which, consisting of large cisterns, now restored, and fragments of walls, are about a mile to the south of the town. In the first three centuries of the Christian era Hippo was one of the richest cities in Roman Africa; but its chief title to fame is derived from its connexion with St Augustine, who lived here as priest and bishop for thirty-five years. Hippo was captured by the Vandals under Genseric in 431, after a siege of fourteen months, during which Augustine died. Only the cathedral, together with Augustine's library and MSS., escaped the general destruction. The town was partially restored by Belisarius, and again sacked by the Arabs in the 7th century. On the top of the hill on which Hippo stood, a large basilica, with chancel towards the west, dedicated to St Augustine, was opened in 1900. An altar surmounted by a bronze statue of the saint has also been erected among the ruins. The place was named Hippo Regius (Royal) by the Romans because it was a favourite residence of the Numidian kings. Bona (Arabic *annaba*, "the city of jubbe trees"), which has passed through many vicissitudes, was built by the Arabs, and was for centuries a possession of the rulers of Tunis, who built the Kasbah in 1300. From the beginning of the 14th to the middle of the 15th century it was frequented by Italians and Spaniards, and in the 16th it was held for some time by Charles V., who strengthened its citadel. Thereafter it was held in turn by Genoese, Tunisians and Algerines. From the time of Louis XIV. to the Revolution, the French *Compagnie d'Afrique* maintained a very active trade with the port. The town was occupied by the French for a few months in 1830 and recaptured in 1832, when Captains Armandy and Yusuf with a small force of marines seized the Kasbah and held it for some months until help arrived. From that time the history of Bona is one of industrial development, greatly stimulated since 1883 by the discovery of the phosphate beds at Tebessa.

BONA DEA, the "good goddess," an old Roman deity of fruitfulness, both in the earth and in women. She was identified with Fauna, and by later syncretism also with Ops and Maia—the latter no doubt because the dedication-day of her temple on the Aventine was 1st May (Ovid, *Fasti*, v. 149 foll.). This temple was cared for, and the cult attended, by women only, and the same was the case at a second celebration at the beginning of December in the house of a magistrate with *imperium*, which became famous owing to the profanation of these mysteries by P. Clodius in 62 B.C., and the political consequences of his act. Wine and myrtle were tabooed in the cult of this deity, and myths grew up to explain these features of the cult, of which an account may be read in W. W. Fowler's *Roman Festivals*, pp. 103 foll. Herbs with healing properties were kept in her temple, and also snakes, the usual symbol of the medicinal art. Her victim was a *porca*, as in the cults of other deities of fertility, and was called *damium*, and we are told that the goddess herself was known as Damia and her priestess as *damiatrix*. These names are almost certainly Greek; Damia is found worshipped at several places in Greece, and also at Tarentum, where there was a festival called *Dameia*. It is thus highly probable that on the cult of the original Roman goddess was engrafted the Greek

one of Damia, perhaps after the conquest of Tarentum (272 B.C.). It is no longer possible to distinguish clearly the Greek and Roman elements in this curious cult, though it is itself quite intelligible as that of an Earth-goddess with mysteries attached. See also Pauly-Wissowa, *Realencyclopädie*. (W. W. F.)

BONA FIDE (Lat. "in good faith"), in law, a term implying the absence of all fraud or unfair dealing or acting. It is usually employed in conjunction with a noun, e.g. "bona fide purchaser," one who has purchased property from its legal owner, to whom he has paid the consideration, and from whom he has taken a legal conveyance, without having any notice of any trust affecting the property; "bona fide holder" of a bill of exchange, one who has taken a bill complete and regular on the face of it, before it was overdue, and in good faith and for value, and without notice of any defect in the title of the person who negotiated it to him; "bona fide traveller" under the licensing acts, one whose lodging-place during the preceding night is at least 3 m. distant from the place where he demands to be supplied with liquor, such distance being calculated by the nearest public thoroughfare.

BONALD, LOUIS GABRIEL AMBROISE, VICOMTE DE (1754-1840), French philosopher and politician, was born at Le Monna, near Millau in Aveyron, on the 2nd of October 1754. Disliking the principles of the Revolution, he emigrated in 1791, joined the army of the prince of Condé, and soon afterwards settled at Heidelberg. There he wrote his first important work, the highly conservative *Théorie du pouvoir politique et religieux* (3 vols., 1796; new ed., Paris, 1854, 2 vols.), which was condemned by the Directory. Returning to France he found himself an object of suspicion, and was obliged to live in retirement. In 1806 he was associated with Chateaubriand and Fiévée in the conduct of the *Mercur de France*, and two years later was appointed councillor of the Imperial University which he had often attacked. After the restoration he was a member of the council of public instruction, and from 1815 to 1822 sat in the chamber as deputy. His speeches were on the extreme conservative side; he even advocated a literary censorship. In 1822 he was made minister of state, and presided over the censorship commission. In the following year he was made a peer, a dignity which he lost through refusing to take the oath in 1830. From 1816 he had been a member of the Academy. He took no part in public affairs after 1830, but retired to his seat at Le Monna, where he died on the 23rd of November 1840.

Bonald was one of the leading writers of the theocratic or traditionalist school, which included de Maistre, Lamennais, Ballanche and d'Eckstein. His writings are mainly on social and political philosophy, and are based ultimately on one great principle, the divine origin of language. In his own words, "L'homme pense sa parole avant de parler sa pensée"; the first language contained the essence of all truth. From this he deduces the existence of God, the divine origin and consequent supreme authority of the Holy Scriptures, and the infallibility of the church. While this thought lies at the root of all his speculations there is a formula of constant application. All relations may be stated as the triad of cause, means and effect, which he sees repeated throughout nature. Thus, in the universe, he finds the first cause as mover, movement as the means, and bodies as the result; in the state, power as the cause, ministers as the means, and subjects as the effects; in the family, the same relation is exemplified by father, mother and children. These three terms bear specific relations to one another; the first is to the second as the second to the third. Thus, in the great triad of the religious world—God, the Mediator, and Man—God is to the God-Man as the God-Man is to Man. On this basis he constructed a system of political absolutism which lacks two things only—well-grounded premises instead of baseless hypotheses, and the acquiescence of those who were to be subjected to it.

Bonald's style is remarkably fine; ornate, but pure and vigorous. Many fruitful thoughts are scattered among his works, but his system scarcely deserves the name of a philosophy. In abstract thought he was a mere dilettante, and his strength

lay in the vigour and sincerity of his statements rather than in cogency of reasoning.

He had four sons. Of these, VICTOR DE BONALD (1780-1871) followed his father in his exile, was rector of the academy of Montpellier after the restoration, but lost his post during the Hundred Days. Regaining it at the second restoration, he resigned finally in 1830. He wrote *Des vrais principes opposés aux erreurs du XIX^e siècle* (1833), *Moïse et les glogues modernes* (1835), and a life of his father. LOUIS JACQUES MAURICE (1787-1870), cardinal (1841), was condemned by the council of state for a pastoral letter attacking Dupin the elder's *Manuel de droit ecclésiastique*. In 1848 he held a memorial service "for those who fell gloriously in defence of civil and religious liberty." In 1851 he nevertheless advocated in the senate the maintenance of the temporal power of Rome by force of arms. HENRI (d. 1846) was a contributor to legitimist journals; and RENÉ was interim prefect of Aveyron in 1817.

Besides the *Théorie* above mentioned, the vicomte de Bonald published *Essai analytique sur les lois naturelles de l'ordre social* (1800); *Législation primitive* (1802); *Du divorce considéré au XIX^e siècle* (1801); *Recherches philosophiques sur les premiers objets de connaissances morales* (2 vols., 1818); *Mélanges littéraires et politiques, démonstration philosophique du principe constitutif de la société* (1819, 1852). The first collected edition appeared in 12 vols., 1817-1819; the latest is that of the Abbé Migne (3 vols., 1859).

See *Notice sur M. le Vicomte de Bonald* (1841, ed. Avignon, 1853), (by his son Victor); *Damiron, Phil. en France au XIX^e siècle*; *Windelband, History of Philosophy* (trans. J. H. Tufts, 1893); *E. Faguet in Rev. des deux mondes* (April 15, 1889).

BONAPARTE, the name of a family made famous by Napoleon I. (q.v.), emperor of the French. The French form Bonaparte was not commonly used, even by Napoleon, until after the spring of 1796. The original name was Buonaparte, which was borne in the early middle ages by several distinct families in Italy. One of these, which settled at Florence before the year 1100, divided in the 13th century into the two branches of San Miniato and Sarzana. A member of this latter, Francesco Buonaparte, emigrated in the middle of the 16th century to Corsica, where his descendants continued to occupy themselves with the affairs of law and the magistracy.

CARLO BUONAPARTE [Charles Marie de Bonaparte] (1746-1785), the father of Napoleon I., took his degree in law at the university of Pisa, and after the conquest of Corsica by the French became assessor to the royal court of Ajaccio and the neighbouring districts. His restless and dissatisfied nature led him to press or intrigue for other posts, and to embark in risky business enterprises which compromised the fortune of his family for many years to come. In 1764 he married Letizia Ramolino, a beautiful and high-spirited girl, aged fourteen, descended from a well-connected family domiciled in Corsica since the middle of the 15th century. The first two children, born in 1765 and 1767, died in infancy; Joseph (see below), the first son who survived, was born in 1768, and Napoleon in 1769. The latter was born in the midst of the troubles consequent on the French conquest, Letizia having recently accompanied her husband in several journeys and escapes. Her firm and courageous disposition showed itself at that trying time and throughout the whole of her singularly varied career. Simple and frugal in her tastes, and devout in thought and manner of life, she helped to bind her children to the life of Corsica, while her husband, a schemer by nature and a Voltairian by conviction, pointed the way to careers in France, the opening up of which moulded the fortunes of the family and the destinies of Europe. He died of cancer in the stomach at Montpellier in 1785.

Letizia lived to witness the glory and the downfall of her great son, surviving Napoleon I. by sixteen years. She never accommodated herself to the part she was called on to play during the Empire, and, though endowed with immense wealth and distinguished by the title of *Madame Mère*, lived mainly in retirement, and in the exercise of a strict domestic economy which her early privations had made a second nature to her, but which rendered her very unpopular in France and was displeasing to Napoleon. After the events of 1814 she joined the

emperor in the island of Elba and was privy to his plans of escape, returning to Paris during the Hundred Days. After the final downfall of Waterloo, she took up her residence at Rome, where Pope Pius VII. treated her with great kindness and consideration, and protected her from the suspicious attentions of the powers of the Grand Alliance. In 1818 she addressed a pathetic letter to the powers assembled at the congress of Aix, petitioning for Napoleon's release, on the ground that his mortal illness had removed any possibility of his ever again becoming a menace to the world's peace. The letter remained unanswered, the powers having reason to believe that it was a mere political move, and that its terms had been previously concerted with Napoleon. Henceforth, saddened by the death of Napoleon, of her daughters Pauline and Elisa, and of several grandchildren, she lived a life of mournful seclusion. In 1820 she was crippled by a serious fall, and was all but blind before her death in 1836.

For the Bonaparte family in general, and Carlo and Letizia, see *Storia genealogica della famiglia Bonaparte, della sua origine fino all'estinzione del ramo già esistente nella città di S. Miniato, scritto da un Somministrato* (D. Morali) (Florence, 1846); F. de Stefani, *La stirpe di Bonaparte; precede per una introduzione* (L. Beretta) (Venice, 1857); L. Ambrosini and A. Huard, *La Famille impériale. Histoire de la famille Bonaparte depuis son origine jusqu'en 1860* (Paris, 1860); C. Leynardier, *Histoire de la famille Bonaparte de l'an 1050 à l'an 1868 (continuée jusqu'en 1866 par de la Brugère)* (Paris, 1866); A. Klein-schmidt, *Die Eltern und Geschwister Napoleons I.* (Berlin, 1876); D. A. Bingham, *The Marriages of the Bonapartes* (2 vols., London, 1881); F. Masson, *Napoléon et sa famille* (4 vols., Paris, 1897-1900); A. Chuquet, *La Jeunesse de Napoléon* (3 vols., Paris, 1897-1899); T. Nascia, *Mémoires sur l'enfance et la jeunesse de Napoléon jusqu'à l'âge de vingt-trois ans; précédés d'une notice historique sur son père*; Baron H. Larrey, *Madame Mère* (2 vols., Paris, 1892); Clara Tschudi, *Napoleons Mutter: aus dem Norwegischen übersetzt von H. von Lenk* (Leipzig, 1901).

The brothers and sisters of Napoleon I., taken in order of age, are the following:—

I. JOSEPH (1768-1844), was born at Corte in Corsica on the 7th of January 1768. He was educated at the college at Autun in France, returned to Corsica in 1784, shortly after the death of his father, and thereafter studied law at the university of Pisa. He became a barrister at Bastia in June 1788, and was soon elected a councillor of the municipality of Ajaccio. Like his brothers, Napoleon and Lucien, he embraced the French or democratic side, and on the victory of the Paolist party fled with his family from Corsica and sought refuge in France. After spending a short time in Paris, where he was disgusted with the excesses of the Jacobins, he settled at Marseilles and married Mlle Julie Clary, daughter of a merchant of that town. The Bonapartes moved from place to place, mainly with the view of concerting measures for the recovery of Corsica. Joseph took part in these efforts and went on a mission to Genoa in 1795. In 1796 he accompanied his brother Napoleon in the early part of the Italian campaign, and had some part in the negotiations with Sardinia which led to the armistice of Cherasco (April 28), the news of which he bore to the French government. Later he proceeded to Leghorn, took part in the French expedition for the recovery of Corsica, and, along with the commissioner of the French Republic, Miot de Melito, helped in the reorganization of that island. In March 1797 he was appointed by the Directory, minister to the court of Parma, and early in the summer he proceeded to Rome in the same capacity. Discords arose between the Vatican and the French Republic, and it is clear that Napoleon and the French Directory ordered Joseph to encourage revolutionary movements in Rome. On the 28th of December 1797 a disturbance took place opposite the French embassy, which led to the death of the French general, Léonard Duphot. Joseph at once left Rome, which soon became a republic. Repairing to Paris, he entered on parliamentary life, becoming one of the members for Corsica in the Council of Five Hundred. He made no mark in the chamber and retired in 1799.

Before the *coup d'état* of Brumaire he helped Napoleon in making overtures to Sieyès and Moreau, but otherwise did little. Thereafter he refused to enter the ministry, but became a member

Napoleon's
brothers
and
sisters:
1. Joseph
Bonaparte.

of the council of state and of the *Corps Législatif*, where his advice on the state of public opinion was frequently useful. He had a hand in the negotiations for the Concordat, but, according to Lucien Bonaparte, looked on that measure as "ill-advised and retrograde." His services in the diplomatic sphere were more important. At Mortfontaine, his country-house, he concluded with the envoy of the United States a convention which bears that name (1800). He also presided over the negotiations which led to the treaty of Lunéville with Austria (February 9, 1801); and he and Maret represented France in the lengthy discussions with the British envoy, Lord Cornwallis, which resulted in the signature of the treaty of Amiens (March 25, 1802). This diplomatic triumph in its turn led to the consolidation of Napoleon's power as First Consul for life (August 1, 1802) with the chief voice in the selection of his successor. On this question the brothers disagreed. As neither Joseph nor Napoleon had a male heir, the eldest brother, whose ideas of primogeniture were very strict, claimed to be recognized as heir, while Napoleon wished to recognize the son of Louis Bonaparte. On the proclamation of the French empire (May 1804) the friction became acute. Napoleon offered to make Joseph king of Lombardy if he would waive all claim of succession to the French throne, but met with a firm refusal.

Meanwhile Joseph had striven earnestly, but in vain, to avert a rupture with England, which came about in May 1803. In 1805 he acted as chief of the French government while Napoleon was campaigning in Germany. Early in 1806 he proceeded to Naples with a French force in order to expel the Bourbon dynasty from southern Italy, Napoleon adding the promise that the Neapolitan crown would be for Joseph if he chose to accept it. The conquest of the mainland was speedily effected, though Gaëta, Reggio and the rock of Scylla held out for some months. The Bourbon court retired to Sicily, where it had the protection of a British force. By the decree of the 30th of March 1806 Napoleon proclaimed Joseph king of Naples, but allowed him to keep intact his claims to the throne of France. In several letters he enjoined his brother to greater firmness in his administration: "These peoples in Italy, and in general all nations, if they do not find their masters, are disposed to rebellion and mutiny." The memoirs of Count Miot de Melito, whom Joseph appointed minister of war, show how great were the difficulties with which the new monarch had to contend—an almost bankrupt treasury, a fickle and degraded populace, Bourbon intrigues and plots, and frequent attacks by the British from Sicily. General Stuart's victory at Maida (July 3) shook Joseph's throne to its base; but the surrender of Gaëta soon enabled Massena to march southwards and subdue Calabria. During his brief reign at Naples, Joseph effected many improvements; he abolished the relics of feudalism, reformed the monastic orders, reorganized the judicial, financial and educational systems, and initiated several public works. In everything he showed his desire to carry out the aims which he expressed to his consort in April 1806: "Justice demands that I should make this people as happy as the scourge of war will permit."

From these well-meant, but not always successful, efforts he was suddenly called away by Napoleon to take the crown of Spain (May 1808). There his difficulties were far greater. Despite the benevolent intentions announced to the Spaniards in his proclamation dated Bayonne, 23rd of June 1808, all reconciliation between them and the French was impossible after Napoleon's treatment of their *de facto* king, Ferdinand VII. For the varying fortunes of King Joseph in Spain and in the eventful years of the Peninsular War, see SPAIN and PENINSULAR WAR. His sovereignty was little more than titular. Compelled to leave Madrid hastily in August 1808, owing to the Spanish success at Baylen, he was reinstated by Napoleon at the close of the year; and he was thereafter kept in a subordinate position which led him on four occasions to offer to abdicate. The emperor took no notice of these offers, and ordered him to govern with more energy. Between February and May 1810 the emperor placed the northern and north-eastern provinces under the command of French generals as military districts, virtually

independent of Joseph's authority. Again the king protested, but in vain. As his trusted adviser, Miot de Melito, observed in his memoirs, Joseph tried to be constitutional king of Spain, whereas after the experience of the years 1808-1809 he could only succeed in the Peninsula by becoming "the mere instrument of a military power." "Bearing a title which was only an oppressive burden, the king had in reality ceased to exist as a monarch, and barely retained some semblance of authority over a small part of the French army as a general. Reduced by the exhausted state of his treasury to the last extremity he at length seriously thought of departure." Joseph took this step in April 1811, and proceeded to Paris in order to extort better terms, or offer his abdication; but he had to return with a monthly subsidy of 500,000 francs and the promise that the army of the centre (the smallest of the five French armies) should be under his control. Late in that year Napoleon united Catalonia to France. Wellington's victory at Salamanca (July 22, 1812) compelled Joseph to leave his capital; and despite the retirement of the British in the autumn of that year, Joseph's authority never fully recovered from that blow. The end of his nominal rule came in the next year, when Wellington utterly overthrew the chief French army, commanded by King Joseph and Marshal Jourdan, at Vittoria (June 21, 1813). The king fled from Spain, was disgraced by Napoleon, and received the order to retire incognito to Mortfontaine. The emperor wrote to the minister of war (July 11, 1813):—"His [Joseph's] behaviour has never ceased bringing misfortune upon my army; it is time to make an end of it."

Napoleon was equally dissatisfied with his brother's conduct as lieutenant-general of France, while he himself was conducting the campaign of 1814 in the east of France. On the 30th of March, Joseph empowered Marmont to make a truce with the assailants of Paris if they should be in overpowering strength. On the surrender of the capital Joseph at once retired. The part which he played during the Hundred Days (1815) was also insignificant. It is strange that, four days after Waterloo, Napoleon should have urged him to inspire the Chamber of Deputies with a view to a national resistance (*Lettres nouvelles de Napoléon*). In point of fact Joseph did little beyond seeking to further the emperor's plans of escape to America. After the surrender of his brother to the captain of H.M.S. "Bellerophon" at Rochefort, Joseph went to the United States. Settling in Bordentown, New Jersey, he adopted the title of comte de Survilliers, and sought to promote plans for the rescue of his brother from St Helena. In 1830 he pleaded, but unsuccessfully, for the recognition of the claims of the duke of Reichstadt (king of Rome) to the French throne. He afterwards visited England, and for a time resided at Genoa and Florence. In the latter city, the cradle of his race, he died on the 28th of July 1844. In person he somewhat resembled Napoleon, but utterly lacked his strength and energy. He was fitted for an embassy or judgeship, but was too mild, supine and luxurious for the tasks thrust upon him by his brother. Yet his correspondence and memoirs prove that he retained for Napoleon warm feelings of affection.

Of the many works dealing with Joseph Bonaparte we may cite Baron A. du Casse, *Mémoires et correspondance politique et militaire du roi Joseph* (10 vols., Paris, 1854), and *Les Rois frères de Napoléon* (1893); J. S. C. Abbott, *History of Joseph Bonaparte* (New York, 1809); G. Bertin, *Joseph Bonaparte in America: Joseph Bonaparte jugé par ses contemporains* (anon.); the *Mémoires of Count Miot de Melito* (translation, edited by General Fleischmann, 2 vols., 1881); R. M. Johnston, *The Napoleonic Empire in Southern Italy* (2 vols., with an excellent bibliography, London, 1904); *Correspondence of Napoleon with Joseph Bonaparte* (2 vols., New York, 1856); Baron A. du Casse, *Histoire des . . . traités de Mortfontaine, de Lunéville et d'Amiens*, &c. (1855-1857); F. Masson, *Napoléon et sa famille* (4 vols., Paris, 1889-1900).

II. LUCIEN (1775-1840), prince of Canino, was born at Ajaccio on the 21st of May 1775. He followed his elder brothers to the schools of Autun and Brienne. At that time he wished to enter the French army, but, being debarred by defective sight, was destined for the church, and with this aim in view went to the seminary at Aix in Provence (1786). His excitable and volatile disposition agreed ill with the

J. Lucien
Bonaparte.

discipline of the place, and on the outbreak of the Revolution in 1789 he eagerly espoused the democratic and anti-clerical movement then sweeping over France. On returning to Corsica he became the leading speaker in the Jacobin club at Ajaccio. Pushing even Napoleon to more decided action, Lucien urged his brothers to break with Paoli, the leader of the more conservative party, which sought to ally itself with England as against the regicidal republic of France. He headed a Corsican deputation which went to France in order to denounce Paoli and to solicit aid for the democrats; but, on the Paolists gaining the upper hand, the Bonapartes left the island and joined Lucien at Toulon. In the south of France he worked hard for the Jacobinical cause, and figured as "Brutus" in the Jacobin club of the small town of St Maximin (then renamed Marathon). There on the 4th of May 1794 he married Mlle Catherine Boyer, though he was a minor and had not the consent of his family—an act which brought him into a state almost approaching disgrace and penury. The *coup d'état* of Thermidor (July 28, 1794) compelled the young disciple of Robespierre hurriedly to leave St Maximin, and to accept a small post at St Chamans. There he was arrested and imprisoned for a time until Napoleon's influence procured his release, and further gained for him a post as commissioner in the French army campaigning in Germany. Lucien soon conceived a dislike for a duty which opened up no vista for his powers of oratory and political intrigue, and repaired to Corsica. In the hope of being elected a deputy of the island, he refused an appointment offered by Napoleon in the army of Egypt in 1798. His hopes were fulfilled, and in 1798 he entered the Council of Five Hundred at Paris. There his vivacious eloquence brought him into prominence, and he was president of that body on the eventful day of the 19th of Brumaire (November 10) 1799, when Napoleon overthrew the national councils of France at the palace of St Cloud. The refusal of Lucien to put the vote of outlawry, for which the majority of the council clamoured, his opportune closing of the sitting, and his appeal to the soldiers outside to disperse *les représentants du poignard*, turned the scale in favour of his brother.

By a strange irony this event, the chief event of Lucien's life, was fatal to the cause of democracy of which he had been the most eager exponent. In one of his earlier letters to his brother Joseph, Lucien stated that he had detected in Napoleon "an ambition not altogether egotistic but which surpassed his love for the general weal; . . . in case of a counter-revolution he would try to ride on the crest of events." Napoleon having by his help triumphed over parliamentary institutions in France, Lucien's suspicion of his brother became a dominant feeling; and the relations between them became strained during the period of the consulate (1799-1804). He accepted office as minister of the interior, but was soon deprived of it owing to political and personal differences with the First Consul. In order to soften the blow, Napoleon appointed him ambassador to the court of Madrid (November 1800). There again Lucien displeased his brother. France and Spain were then about to partition Portugal, and the Spanish forces were beginning to invade that land, when the court of Lisbon succeeded, owing (it is said) to the free use of bribes, in inducing Godoy, the Spanish minister, and Lucien Bonaparte to sign the preliminaries of peace on the 6th of June 1801 at Badajoz. The First Consul, finding his plans of seizing Lisbon frustrated, remonstrated with his brother, who thereupon resigned his post, and returned to Paris, there taking part in the opposition which the Tribunal offered to some of Napoleon's schemes. Lucien's next proceeding completed the breach between the two brothers. His wife had died in 1800; he became enamoured of a Mme Joubertou in the early summer of 1802, made her his mistress, and finally, despite the express prohibition of the First Consul, secretly married her at his residence of Plessis (on October 23, 1803). At that time Napoleon was pressing Lucien for important reasons of state to marry the widow of the king of Etruria, and on hearing of his brother's action he ordered him to leave French territory. Lucien departed for Italy with his wife and infant son, after annoying Napoleon by bestowing on her publicly the

name of Bonaparte. He also charged Joseph never to try to reconcile Napoleon to him.

For some years he lived in Italy, chiefly at Rome, showing marked hostility to the emperor. In December 1807 the latter sought to come to an arrangement by which Lucien would take his place as a French prince, provided that he would annul his marriage. This step Lucien refused to take; and after residing for some time at his estate of Canino, from which he took the papal title of prince of Canino, he left for America. Captured by a British ship, he was taken to Malta and thence to England, where he resided under some measure of surveillance up to the peace of 1814. Returning to Rome, he offered Napoleon his help during the Hundred Days (1815), stood by his side at the "Champ de Mai" at Paris, and was the last to defend his prerogatives at the time of his second abdication. He spent the rest of his life in Italy, and died at Rome on the 29th of June 1840. His family comprised four sons and six daughters. He wrote an epic, *Charlemagne, ou l'Église déléguée* (2 vols., 1814), also *La Vérité sur les Cent Jours* and *Mémoires*, which were not completed.

For sources see T. Jung, *Lucien Bonaparte et ses mémoires* (3 vols., Paris, 1882-1883); an anonymous work, *Le Prince Lucien Bonaparte et sa famille* (Paris, 1888); F. Masson, *Napoleon et sa famille* (4 vols., Paris, 1897-1900), and H. Houssaye, "1815" (3 vols., Paris, 1899-1905).

III. MARIANNE ELISA (1777-1820) was born at Ajaccio on the 3rd of January 1777. Owing to the efforts of her brothers she entered the establishment of St Cyr near Paris as a "king's scholar." On its disruption by the revolutionists in 1792 Napoleon took charge of her and brought her back to Ajaccio. She shared the fortunes of the family in the south of France, and on the 5th of May 1797 married Felix Bacciochi, a well-connected Corsican. In 1805, after the foundation of the French empire, Napoleon bestowed upon her the principality of Piombino and shortly afterwards Lucca; in 1808 her importunities gained for her the grand duchy of Tuscany. Bacciochi being almost a nullity, her pride and ability had a great influence on the administration and on Italian affairs in general. Her relations with Napoleon were frequently strained; and in 1813-1814 she abetted Murat in his enterprises (see MURAT). After her brother's fall she retired, with the title of countess of Compignano, first to Bologna and afterwards to Santo Andrea near Trieste, where she died on the 6th of August 1820.

See J. Turquan, *Les Sœurs de Napoléon* (Paris, 1896); P. Mar-mothan, *Elisa Bonaparte* (Paris, 1898); E. Rodocanachi, *Elisa Bonaparte en Italie* (Paris, 1900); F. Masson, *Napoleon et sa famille* (4 vols., Paris, 1897-1900).

IV. LOUIS (1778-1846) was born at Ajaccio on the 2nd of September 1778. His elder brother Napoleon supervised his education with much care, gaining for him scholarships to the royal military schools of France, and during the time when the elder brother was a lieutenant in garrison at Auxonne Louis shared his scanty fare. In 1795 Napoleon procured for him admission to the military school at Châlons, and wrote thus of the boy:—"I am very pleased with Louis; he fulfils my hopes; intelligence, warmth, good health, talent, good address, kindness—he possesses all these qualities." Louis went through the Italian campaign of 1796-97 with Napoleon and acted as his aide-de-camp in Egypt in 1798-99. In 1802 the First Consul married him to Hortense Beauharnais, a forced union which led to most deplorable results. In 1804 Louis was raised to the rank of general, and entered the council of state in order to perfect his knowledge of administrative affairs. In the next year he became governor of Paris and undertook various military and administrative duties.

After the victory of Austerlitz (December 2, 1805) Napoleon began to plan the formation of a ring of states surrounding, and in close alliance with, the French empire. He destined Louis for the throne of Holland, and proclaimed him king of that country on the 6th of June 1806. From the first the emperor reproached him with being too easy with his subjects and with courting popularity too much. The increasing rigour of the continental

system brought the two brothers to an open rupture. Their relations were embittered by a violent jealousy which Louis conceived against his wife. In 1808 the emperor offered Louis the throne of Spain then vacant; but on Louis refusing to accept it the honour went to Joseph. The dispute between Louis and the emperor continued. In the latter part of 1809 Napoleon virtually resolved to annex Holland, in order to stop the trade which the Dutch secretly carried on with England. At the close of the year Louis went to Paris, partly in order to procure a divorce from Hortense and partly to gain better terms for Holland. He failed in both respects. In January 1810 Napoleon annexed the island of Walcheren, alleging that Louis had not done his share in defending the interests of France at the time of the British Walcheren expedition (1809). The French troops also occupied Breda and Bergen-op-Zoom. Louis gave way on all the points in dispute; but his acquiescence only postponed the crisis. After the collapse of negotiations with Great Britain in the spring of 1810, the emperor again pressed Louis hard, and finally sent French troops against the Dutch capital. Thereupon Louis, despairing of offering resistance, fled from his kingdom and finally settled at Töplitz in Bohemia. On the 9th of July 1810 Napoleon annexed Holland to the French empire. Louis spent the rest of his life separated from his wife, and in 1815 gained the custody of his elder son. He lived chiefly at Rome, concerning himself with literary and philosophic studies and with the fortunes of his sons. Their devotion to the national and democratic cause in Italy in 1830-1831 gave him much pleasure, which was overclouded by the death of the elder, Napoleon Louis, in the spring campaign of 1831 in the Romagna. The failure of his other son, Charles Louis Napoleon (afterwards Napoleon III.), to wrest the French crown from Louis Philippe by the attempts at Strasburg and Boulogne also caused him much disappointment. He died on the 25th of July 1846 and was buried at St. Leu. Under more favourable conditions Louis would have gained a name for kindness and philanthropy, proofs of which did indeed appear during his reign in Holland and gained him the esteem of his subjects; but his morbid sensitiveness served to embitter his relations both of a domestic and of a political nature and to sour his own disposition. His literary works are unimportant. His sons were Napoleon Charles (1802-1807), Napoleon Louis (1804-1831), and Charles Louis Napoleon (1808-1873), afterwards emperor of the French as NAPOLEON III. (q.v.).

The chief works on the life and reign of Louis are le comte de Saint-Leu, *Documents historiques et réflexions sur le gouvernement de la Hollande* 3 vols., 2nd ed., Paris, 1820; F. Rocquain, *Napoléon I^{er} et le Roi Louis, d'après les documents conservés aux archives nationales* (Paris, 1873); Baron A. du Casse, *Les Rois frères de Napoléon* (Paris, 1883); A. Garnier, *La Cour de Hollande sous le règne de Louis Bonaparte, par un auditeur* (Paris and Amsterdam, 1823); T. Jorissen, *Napoléon I^{er} et le roi de Hollande (1806-1813) d'après des documents authentiques et inédits* (Paris and The Hague, 1868); V. Loonjers, *Louis Bonaparte, Koning van Holland* (Amsterdam, 1888); L. Wichers, *De Regeering van Koning Lodewijk Napoléon (1806-1810)* (Utrecht, 1892); F. Masson, *Napoléon et sa famille* 4 vols., Paris, 1897-1900).

V. MARIE PAULINE (1780-1825), the gayest and most beautiful member of the family, was born at Ajaccio on the 2. *Paris*. 20th of October 1780. At seventeen years of age she married General Leclerc, a staff officer of Napoleon, and accompanied him to St Domingo, where he died of yellow fever in 1802. Returning to Paris she espoused Prince Camillo Borghese (August 23, 1803) and went to reside with him in Rome. She soon tired of him, returned to Paris and gratified her whims in ways that caused some scandal. In 1806 she received the title of duchess of Guastalla. Her offhand treatment of the new empress, Marie Louise, in 1810 led to her removal from court. Nevertheless in 1814 she repaired with "Madame Mère" to Elba, and is said to have expressed a wish to share Napoleon's exile in St Helena. She died in 1825 of cancer. Canova's statue of her as Venus reclining on a couch is well known.

See J. Turquan, *Les Sœurs de Napoléon: les princesses Élise, Pauline et Caroline* (Paris, 1896); F. Masson, *Napoléon et sa famille* 4 vols., Paris, 1897-1900).

VI. MARIA ANNUNCIATA CAROLINE (1782-1839) was born at Ajaccio on the 25th of March 1782. Early in 1800 she married Joachim Murat, whose interests she afterwards advanced with all the power of her ambitious and intriguing nature. He became governor of Paris, marshal of France (1804), grand duke of Berg and of Cleves (1806), lieutenant of the emperor in Spain (1808), and early in the summer of that year king of Naples. The distance of this capital from Paris displeased Caroline; her relations with Napoleon became strained, and she associated herself with the equivocal movements of her husband in 1814-1815. Before his tragic end at Pizzo on the 13th of October 1815, she had retired to Austrian territory and was placed under some measure of restraint. Finally she lived at Trieste with her sister Elisa. She died on the 18th of May 1839.

See J. Turquan, *Caroline Murat, reine de Naples* (Paris, 1899); F. Masson, *Napoléon et sa famille* (4 vols., Paris, 1897-1900). See also under MURAT, JOACHIM.

VII. JÉRÔME (1784-1860) was born at Ajaccio on the 15th of November 1784; he shared the fortunes of the family in the early years of the French Revolution, was then educated at Jully and was called to the side of his brother, then First Consul of France, in 1800. Many stories are told illustrating his impetuous but affectionate nature. While in the Consular Guard he fought a duel with the younger brother of General Davout and was wounded. Soon afterwards he was transferred to the navy and cruised in the West Indies, until, when blockaded by a British cruiser, he left his ship and travelled through the United States. At Baltimore he fell in love with Miss Elizabeth Patterson, and, though a minor, married her. This disregard of discipline and of the laws of France greatly annoyed Napoleon; and when in 1805 Jerome brought his wife to Europe, the emperor ordered her to be excluded from his states. Jerome vainly sought to bend his brother's will in an interview at Alexandria. In May 1805 he received command of a small squadron in the Mediterranean, while his wife proceeded to Camberwell, where she gave birth to a son. In November Jerome sailed in a squadron commanded by Admiral Willaumes, which was to ravage the West Indies; but it was scattered by a storm. After damaging British commerce in the North Atlantic, Jerome reached France with his ship in safety in August 1806. Napoleon made him a prince of France, and gave him command of a division of South Germans in the campaign of 1806. After Jena, Jerome received the surrender of several Prussian towns. An imperial decree having annulled the Patterson marriage, the emperor united Jerome to the princess Catherine of Württemberg; and in pursuance of the terms of the treaty of Tilsit (July 7, 1807) raised him to the throne of the new kingdom of Westphalia. There Jerome, though frequently rebuked by the emperor, displayed his fondness for luxury, indulged in numerous amours and ran deeply into debt. In some respects his kingdom benefited by the connexion with France. Feudalism was abolished; the *Code Napoléon* was introduced; the Jews were freed from repressive laws; and education received some impulse in its higher departments. But the unpopularity of Jerome's rule was shown by the part taken by the peasants in the abortive rising headed by Baron Wilhelm von Dörnberg and other Westphalian officers in April 1809. Despite heavy taxation, the state debt increased greatly; and the sending of a contingent to Russia in 1812 brought the state to the verge of bankruptcy. In the early part of that campaign Jerome was entrusted with an important movement which might have brought the southern Russian army into grave danger; on his failure (which was probably due to his lack of energy) the emperor promptly subjected him to the control of Marshal Davout, and Jerome returned to Cassel. In 1813, on the fall of the Napoleonic régime in Germany, Jerome retired to France, and in 1814 spent some time in Switzerland and at Trieste. Returning to France in 1815, he commanded a division of the French left wing at Waterloo and attacked Hougomont with great pertinacity. On Napoleon's second abdication Jerome proceeded to Württemberg, was threatened with arrest

Caroline Murat.

J. Jerome Bonaparte.

unless he gave up his wife and child, and was kept under surveillance at Goppingen; finally he was allowed to proceed to Augsburg, and thereafter resided at Trieste, or in Italy or Switzerland. His consort died in 1835. He returned to France in 1847, and after the rise of Louis Napoleon to power, became successively governor of the Invalides, marshal of France and president of the senate. He died on the 24th of June 1860. His children were Jerome Napoleon (see XIV.), Mathilde (see XII.) and Napoleon Joseph Charles Paul (born in 1822); the last was afterwards known as Prince Napoleon (see XI. below) and finally became the heir to the fortunes of the Napoleonic dynasty.

The chief works relating to Jerome Bonaparte are: Baron Albert du Case, *Mémoires et correspondance du roi Jérôme et de la reine Catherine* (7 vols., Paris, 1861-1866) and *Les Rois frères de Napoléon* (1883); M. M. Kaisenberg, *König Jerome Napoleon*; W. T. R. Saffell, *The Bonaparte-Patterson Marriage*; August von Schlossberger, *Briefwechsel de Königin Katharina und des Königs Jerome von Westfalen mit König Friedrich von Württemberg* (Stuttgart, 1886-1887), supplemented by du Case in *Corresp. inédite de la reine Catherine de Westphalie* (Paris, 1888-1893); A. Martinet, *Jérôme Napoléon, roi de Westphalie* (Paris, 1902); P. W. Sergeant, *The Burlesque Napoleon* (1905); F. Masson, *Napoléon et sa famille* (4 vols., Paris, 1897-1900). (J. H. R.)

The fortunes of the Bonaparte family may be further followed under the later biographies of its leading members, mainly descendants of Lucien (II. above) and Jerome (VII. above).

VIII. CHARLES LUCIEN JULES LAURENT (1803-1857), prince of Canino, son of Lucien Bonaparte, was a scientist rather than a politician. He married his cousin, Zénaïde Bonaparte, daughter of Joseph, in 1822. At the age of twenty-two

he began the publication of an *American Ornithology & Charles* (4 vols., Philadelphia, 1825-1833), which established his scientific reputation. A series of other works in zoology followed: *Iconographia della fauna Italica* (3 vols., Rome, 1832-1841), *Catálogo metodico degli uccelli europei* (1 vol., Bologna, 1842), *Catálogo metodico dei pesci europei* (1 vol., Naples, 1845, 4to), *Catálogo metodico dei mammiferi europei* (1 vol., Milan, 1845), *Telachorum tabula analytica* (Neuchâtel, 1838). He was elected honorary member of the academy of Upsala in 1833, of that of Berlin in 1843, and correspondent of the Institute of France in 1844. Towards 1847 he took part in the political agitation in Italy, and presided over scientific congresses; notably at Venice, where he declared himself in favour of the independence of Italy and the expulsion of the Austrians. He entered the Junto of Rome in 1848 and was elected deputy by Viterbo to the national assembly. The failure of the revolution forced him to leave Italy in July 1849. He gained Holland, then France, where he turned again to science. His principal works were, *Conspectus systematis ornithologiae, mastozologiae, erpetologiae et amphibiae*, *Ichthyologiae* (Leiden, 1850), *Tableau des oiseaux-mouches* (Paris, 1854), *Ornithologie fossile* (Paris, 1858). Eight children survived him: Joseph Lucien Charles Napoleon, prince of Canino (1824-1865), who died without heirs; Lucien Louis Joseph Napoleon, born in 1828, who took holy orders in 1853 and became a cardinal in 1868; Julie Charlotte Zénaïde Pauline Laetitia Désirée Bartholomé, who married the marquis of Roccagiovine; Charlotte Honorine Josephine, who married Count Primoli; Marie Désirée Eugénie Josephine Philomène, who married the count Campello; Auguste Amélie Maximilienne Jacqueline, who married Count Gabrielli; Napoleon Charles Grégoire Jacques Philippe, born in 1839, who married the princess Ruspoli, by whom he had two daughters; and Bathilde Aloyse Leonie, who married the comte de Cambacérès. The branch is now extinct.

IX. LOUIS LUCIEN (1813-1891), son of Lucien Bonaparte, was born at Thorn Grove, Worcestershire, England, on the 4th of January 1813. He passed his youth in England, not going to France until 1848, when, after the revolution, he was elected deputy for Corsica on the 28th of November 1848; his election having been invalidated, he was returned as deputy for the Seine in June 1849. He sat in the right of the Legislative Assembly, but had no direct part in the *coup d'état* of his cousin on the 2nd of December 1851. Napoleon III. named him senator and prince, but he took hardly any part in

politics during the Second Empire, and after the proclamation of the Third Republic in 1870 he withdrew to England. There he busied himself with philology, and published notably some works on the Basque language: *Grammaire basque, Remarques sur plusieurs assertions concernant la langue basque* (1876), *Observations sur le basque Fontarabie* (1878). He died on the 3rd of November 1891, leaving no children.

X. PIERRE NAPOLEON (1815-1881), son of Lucien Bonaparte, was born at Rome on the 12th of September 1815. He began his life of adventure at the age of fifteen, joining the insurrectionary bands in the Romagna (1830-1831); was then in the United States, where he went to join his uncle Joseph, and in Colombia with General Santander (1832). Returning to Rome he was taken prisoner by order of the pope (1835-1836). He finally took refuge in England. At the revolution of 1848 he returned to France and was elected deputy for Corsica to the Constituent Assembly. He declared himself an out-and-out republican and voted even with the socialists. He pronounced himself in favour of the national workshops and against the *loi Falloux*. His attitude contributed greatly to give popular confidence to his cousin Louis Napoleon (Napoleon III.), of whose *coup d'état* on the 2nd of December 1851 he disapproved; but he was soon reconciled to the emperor, and accepted the title of prince. The republicans at once abandoned him. From that time on he led a debauched life, and lost all political importance. He turned to literature and published some mediocre poems. In January 1870 a violent incident brought him again into prominence. As the result of a controversy with Paschal Grousset, the latter sent him two journalists to provoke him to a duel. Pierre Bonaparte took them personally to account, and during a violent discussion he drew his revolver and killed one of them, Victor Noir. This crime greatly excited the republican press, which demanded his trial. The High Court acquitted him, and criticism then fell upon the government. Pierre Bonaparte died in obscurity at Versailles on the 7th of April 1881. He had married the daughter of a Paris working-man, Justine Eleanor Ruffin, by whom he had, before his marriage, two children: (1) Roland Napoleon, born on the 10th of May 1858, who entered the army, was excluded from it in 1886, and then devoted himself to geography and scientific explorations; (2) Jeanne, wife of the marquis de Vence.

XI. NAPOLEON JOSEPH CHARLES PAUL, commonly known as Prince Napoleon, or by the sobriquet of "Plon-Plon,"¹ (1822-1891), was the second son of Jerome Bonaparte, king of Westphalia, by his wife Catherine, princess of Württemberg, and was born at Trieste on the 9th of September 1822. He soon rendered himself popular by his advanced democratic ideas, which he expressed on all possible occasions. After the French revolution of 1848 he was elected to the National Assembly as a representative of Corsica, and (his elder brother, Jerome Napoleon Charles, dying in 1847) assumed the name of Jerome. Notwithstanding his ostensible opposition to the *coup d'état* of 1851, he was designated, upon the establishment of the Empire, as successor to the throne if Napoleon III. should die childless, and received a liberal dotation, but was allowed no share in public affairs. Privately he professed himself the representative of the Napoleonic tradition in its democratic aspect, and associated mainly with men of advanced political opinions. At court he represented the Liberal party against the empress Eugénie. In 1854 he took part in the Crimean campaign as general of division. His conduct at the battle of the Alma occasioned imputations upon his personal courage, but they seem to have been entirely groundless. Returning to France he undertook the chief direction of the National Exhibition of 1855, in which he manifested great capacity. In 1858 he was appointed minister for the Colonies and Algeria, and his administration aroused great hopes, but his activity was diverted into a different channel by his sudden marriage

¹ Derived, it is supposed, from the nickname "Plomb-plomb," or "Craint-plomb" (fear-lead), given him by his soldiers in the Crimea.

Descendants of Jerome:
II. Prince Napoleon (Plon-Plon).

9. Louis Lucien.

in January 1859 with the princess Marie Clotilde of Savoy, daughter of Victor Emmanuel, a prelude to the war for the liberation of Italy. In this war Prince Napoleon commanded the French corps that occupied Tuscany, and it was expected that he would become ruler of the principality, but he refused to exert any pressure upon the inhabitants, who preferred union with the Italian kingdom. The next few years were chiefly distinguished by remarkable speeches which displayed the prince in the unexpected character of a great orator. Unfortunately his indiscretion equalled his eloquence: one speech (1861) sent him to America to avoid a duel with the duke d'Aumale; another (1865), in which he justly but intemperately protested against the Mexican expedition, cost him all his official dignities. Nevertheless he was influential in effecting the reform by which in 1869 it was sought to reconcile the Empire with Liberal principles. The fatal war of 1870 was resolved upon during his absence in Norway, and was strongly condemned by him. After the first disasters he undertook an ineffectual mission to Italy to implore the aid of his father-in-law; and after the fall of the Empire lived in comparative retirement until in 1879 the death of Napoleon III.'s son, the Prince Imperial (see XIII. below), made him direct heir to the Napoleonic succession. His part as imperial pretender was unfortunate and inglorious: his democratic opinions were unacceptable to the imperial party, and before his death he was virtually deposed in favour of his son Prince Napoleon Victor, who, supported by Paul de Cassagnac and others, openly declared himself a candidate for the throne in 1884. He died at Rome on the 17th of March 1891. In the character of his intellect, as in personal appearance, he bore an extraordinary resemblance to the first Napoleon, possessing the same marvellous lucidity of insight, and the same gift of infallibly distinguishing the essential from the non-essential. He was a warm friend of literature and art; and in a private station would have achieved high distinction as a man of letters.

His eldest son, Prince Napoleon Victor Jérôme Frédéric (b. 1861), became at his death the recognized head of the French Bonapartist party. The second son, Prince Louis Napoleon, an officer in the Russian army, showed a steadier disposition, and was more favoured in some monarchist quarters; in 1906 he was made governor of the Caucasus.

XII. MATHILDE LETITIA WILHELMINE (1820-1904), daughter of Jerome, and sister of Prince Napoleon (XI.), was born at Trieste on the 20th of May 1820; after being almost betrothed to her cousin Louis Napoleon, in 1840 she was married to Prince Anatole Demidov. His conduct, however, led to a separation within five years, and the tsar Nicholas compelled him to make Princess Mathilde a handsome allowance. After the election of Louis Napoleon to the presidency of the republic she took up her residence in Paris, and did the honours of the *Élysée* till his marriage. She continued to live in Paris, having great influence as a friend and patron of men of art and letters, till her death on the 2nd of January 1904.

XIII. NAPOLEON EUGENE LOUIS JEAN JOSEPH (1856-1879), Prince Imperial, only son of the emperor Napoleon III. and the

empress Eugénie, was born at Paris on the 16th of March 1856. He was a delicate boy, but when the war of 1870 broke out his mother sent him to the army, to win popularity for him, and the government journals vaunted his bravery. After the first defeats he had to flee from France with the empress, and settled in England at Chislehurst, completing his military education at Woolwich. On the death of his father on the 9th of January 1873 the Imperialists proclaimed him Napoleon IV., and he became the official Pretender. He was naturally inactive, but he was influenced by his mother on the one hand, and by the Bonapartist leaders in France on the other. They thought that he should win his crown by military prestige, and he was persuaded to attach himself as a volunteer to the English expedition to Zululand in February 1879. It was a blunder to have allowed him to go, and the blunder ended in a tragedy, for while out on a reconnaissance with a few troopers they were surprised by Zulus,

and the Prince Imperial was killed (June 1, 1879). His body was brought back to England, and buried at Chislehurst.

XIV. THE BONAPARTES OF BALTIMORE are a branch of the family settled in America, descended from Jerome Bonaparte (VII.) by his union with Elizabeth (b. 1785), daughter of William Patterson, a Baltimore merchant, probably descended from the Robert Paterson who was the original of Sir Walter Scott's "Old Mortality." The marriage took place at Baltimore on the 24th of December 1803, but it was greatly disliked by Napoleon, who refused to recognize its legality. However, it was valid according to American law, and Pope Pius VII. refused to declare it void. Nevertheless Jerome was forced by his brother to separate himself from his wife, whom he had brought to Europe, and after a stay in England Madame Patterson, or Madame Bonaparte, as she was usually called, returned to Baltimore. She died in 1870. Jerome's only child by this marriage was Jerome Napoleon Bonaparte (1805-1870), who was born in England, but resided chiefly in Baltimore, and is said to have shown a marked resemblance to his uncle, the great emperor. He was on good terms with Jerome, who for some time made him a large allowance, and father and son occasionally met. His elder son, also called Jerome Napoleon Bonaparte (1832-1893), entered the French army, with which he served in the Crimea and in Italy.

Charles Joseph Bonaparte (b. 1851), younger son of the first Jerome Napoleon Bonaparte, and a grandson of Jerome, king of Westphalia, attained a distinguished place in American politics. Born at Baltimore on the 9th of June 1851 and educated at Harvard University, he became a lawyer in 1874 and has been president of the National Municipal League and has filled other public positions. He was secretary of the navy in President Roosevelt's cabinet from July 1905 to December 1906, and then attorney-general of the United States until March 1909.

BONAR, HORATIUS (1808-1889), Scottish Presbyterian divine, was born in Edinburgh on the 19th of December 1808, and educated at the high school and university of his native city. After a term of mission work at Leith, he was appointed parish minister of Kelso in 1837, and at the Disruption of 1843 became minister of the newly formed Free Church, where he remained till 1866, when he went to the Chalmers memorial church, Edinburgh. He had in 1853 received the D.D. degree from Aberdeen University, and in 1883 he was moderator of the general assembly of his church. He died on the 31st of July 1889. Bonar was a prolific writer of religious literature, and edited several journals, including the *Christian Treasury*, the *Presbyterian Review* and the *Quarterly Journal of Prophecy*; but his best work was done in hymnology, and he published three series of *Hymns of Faith and Hope* between 1857 and 1866 (new ed., 1886). Nearly every modern hymnal contains perhaps a score of his hymns, including "Go, labour on," "I heard the voice of Jesus say," "Here, O my Lord, I see Thee face to face," "When the weary, seeking rest."

See *Horatius Bonar, D.D., a Memorial* (1889).

BONAVENTURA, SAINT (JOHN OF FIDANZA), Franciscan theologian, was born in 1221 at Bagnarea in Tuscany. He was destined by his mother for the church, and is said to have received his cognomen of Bonaventura from St Francis of Assisi, who performed on him a miraculous cure. He entered the Franciscan order in 1243, and studied at Paris possibly under Alexander of Hales, and certainly under Alexander's successor, John of Rochelle, to whose chair he succeeded in 1253. Three years earlier his fame had gained for him permission to read upon the *Sentences*, and in 1255 he received the degree of doctor. So high was his reputation that in the following year he was elected general of his order. It was by his orders that Roger Bacon was interdicted from lecturing at Oxford, and compelled to put himself under the surveillance of the order at Paris. He was instrumental in procuring the election of Gregory X., who rewarded him with the titles of cardinal and bishop of Albano, and insisted on his presence at the great council of Lyons in the year 1274. At this meeting he died.

Bonaventura's character seems not unworthy of the eulogistic title, "Doctor Seraphicus," bestowed on him by his

contemporaries, and of the place assigned to him by Dante in his *Paradiso*. He was formally canonized in 1482 by Sixtus IV., and ranked as sixth among the great doctors of the church by Sixtus V. in 1587. His works, as arranged in the Lyons edition (7 vols., folio), consist of expositions and sermons, filling the first three volumes; of a commentary on the *Sentences* of Lombardus, in two volumes, celebrated among mediæval theologians as incomparably the best exposition of the third part; and of minor treatises filling the remaining two volumes, and including a life of St. Francis. The smaller works are the most important, and of them the best are the famous *Itinerarium Mentis ad Deum*, *Breviloquium*, *De Reductione Artium ad Theologiam*, *Soliloquium*, and *De septem itineribus æternitatis*, in which most of what is individual in his teaching is contained.

In philosophy Bonaventura presents a marked contrast to his great contemporaries, Thomas Aquinas and Roger Bacon. While these may be taken as representing respectively physical science yet in its infancy, and Aristotelian scholasticism in its most perfect form, he brings before us the mystical and Platonizing mode of speculation which had already to some extent found expression in Hugo and Richard of St. Victor, and in Bernard of Clairvaux. To him the purely intellectual element, though never absent, is of inferior interest when compared with the living power of the affections or the heart. He rejects the authority of Aristotle, to whose influence he ascribes much of the heretical tendency of the age, and some of whose cardinal doctrines—such as the eternity of the world—he combats vigorously. But the Platonism he received was Plato as understood by St. Augustine, and as he had been handed down by the Alexandrian school and the author of the mystical works passing under the name of Dionysius the Areopagite. Bonaventura accepts as Platonic the theory that ideas do not exist *in rerum natura*, but as thoughts of the divine mind, according to which actual things were formed; and this conception has no slight influence upon his philosophy. Like all the great scholastic doctors he starts with the discussion of the relations between reason and faith. All the sciences are but the handmaids of theology; reason can discover some of the moral truths which form the groundwork of the Christian system, but others it can only receive and apprehend through divine illumination. In order to obtain this illumination the soul must employ the proper means, which are prayer, the exercise of the virtues, whereby it is rendered fit to accept the divine light, and meditation which may rise even to ecstatic union with God. The supreme end of life is such union, union in contemplation or intellect and in intense absorbing love; but it cannot be entirely reached in this life, and remains as a hope for futurity. The mind in contemplating God has three distinct aspects, stages or grades—the senses, giving empirical knowledge of what is without and discerning the traces (*vestigia*) of the divine in the world; the reason, which examines the soul itself, the image of the divine Being; and lastly, pure intellect (*intelligentia*), which, in a transcendent act, grasps the Being of the divine cause. To these three correspond the three kinds of theology—theology *symbolica*, *theologia propria* and *theologia mystica*. Each stage is subdivided, for in contemplating the outer world we may use the senses or the imagination; we may rise to a knowledge of God *per vestigia* or *in vestigiis*. In the first case the three great properties of physical bodies—weight, number, measure,—in the second the division of created things into the classes of those that have merely physical existence, those that have life, and those that have thought, irresistibly lead us to conclude the power, wisdom and goodness of the Triune God. So in the second stage we may ascend to the knowledge of God, *per imaginem*, by reason, or *in imagine*, by the pure understanding (*intellectus*); in the one case the triple division—memory, understanding and will,—in the other the Christian virtues—faith, hope and charity,—leading again to the conception of a Trinity of divine qualities—eternity, truth and goodness. In the last stage we have first *intelligentia*, pure intellect, contemplating the essential being of God, and finding itself compelled by necessity of thought to hold absolute being as the first notion,

for non-being cannot be conceived apart from being, of which it is but the privation. To this notion of absolute being, which is perfect and the greatest of all, objective existence must be ascribed. In its last and highest form of activity the mind rests in the contemplation of the infinite goodness of God, which is apprehended by means of the highest faculty, the *apex mentis* or *synderesis*. This spark of the divine illumination is common to all forms of mysticism, but Bonaventura adds to it peculiarly Christian elements. The complete yielding up of mind and heart to God is unattainable without divine grace, and nothing renders us so fit to receive this gift as the meditative and ascetic life of the cloister. The monastic life is the best means of grace.

Bonaventura, however, is not merely a meditative thinker, whose works may form good manuals of devotion; he is a dogmatic theologian of high rank, and on all the disputed questions of scholastic thought, such as universals, matter, the principle of individualism, or the *intellectus agens*, he gives weighty and well-reasoned decisions. He agrees with Albertus Magnus in regarding theology as a practical science; its truths, according to his view, are peculiarly adapted to influence the affections. He discusses very carefully the nature and meaning of the divine attributes; considers universals to be the ideal forms pre-existing in the divine mind according to which things were shaped; holds matter to be pure potentiality which receives individual being and determinateness from the formative power of God, acting according to the ideas; and finally maintains that the *intellectus agens* has no separate existence. On these and on many other points of scholastic philosophy the Seraphic Doctor exhibits a combination of subtlety and moderation which makes his works peculiarly valuable.

EDITIONS.—7 vols. Rome, 1588-1596; 7 vols. Lyons, 1668; 13 vols. Venice, 1751 ff.; by A. C. Feltzer, 15 vols. Paris, 1863 ff.; 10 vols. Rome, 1882-1892. K. J. Hehle edited the *Breviloquium* and the *Itin. Mentis* (3rd ed., Tübingen, 1862); two volumes of selections were issued by A. J. in 1853-1856.

LITERATURE.—W. A. Hollenberg, *Studien zu Bonaventura* (1862); F. Nitzsch, art. in Herzog-Hauck, *Realencycl. für prot. Theol.*, where a list of monographs is given, to which add one by De Chénavés (1899). (R. Ab.; X.)

BONCHAMPS, CHARLES MELCHIOR ARTUS, MARQUIS DE (c. 1760-1793), Vendéan leader, was born at Jouveteil, Anjou. He gained his first military experience in the American War of Independence, and on his return to France was made a captain of grenadiers in the French army. He was a staunch upholder of the monarchy, and at the outbreak of the French Revolution resigned his command and retired to his château at St. Florent. In the spring of 1793 he was chosen leader by the insurgents of the Vendée, and to his counsels may be attributed in great measure the success of the peasants' arms. He was present at the taking of Bressuire, Thouars and Fontenay, at which last place he was wounded; but dissensions among their leaders weakened the insurgents, and at the bloody battle of Cholet (October 1793) the Vendéans sustained a severe defeat and Bonchamps was mortally wounded. He died the next day. It is said that his last act was the pardoning of five thousand republican prisoners, whom his troops had sworn to kill in revenge for his death. A statue of him by David d'Angers stands in the church of St. Florent.

BOND, SIR EDWARD AUGUSTUS (1815-1898), English librarian, was born at Hanwell on the 31st of December 1815, the son of a schoolmaster. He was educated at Merchant Taylors' school, and in 1832 obtained a post in the public record office. In 1838 he became an assistant in the manuscript department of the British Museum, where he attracted the notice of his chief, Sir Frederick Madden, the most eminent palæographer of his day, and in 1852 he was made Egerton librarian. In 1856 he became assistant keeper of MSS., and in 1867 was promoted to the post of keeper. His work in reorganizing the manuscript department was of lasting value, and to him is due the classified catalogue of MSS., and the improved efficiency and punctuality of publication of the department. In 1878 he was appointed principal librarian. Under his supervision were erected the new buildings of the

"White Wing," which provide accommodation for prints, drawings, manuscripts and newspapers, and the purchase of the Stowe MSS. was concluded while he remained in office. He founded, in conjunction with Sir E. Maunde Thompson, the Palaeographical Society, and first made classical palaeography an exact science. He was made LL.D. of Cambridge in 1879, created C.B. in 1885, and K.C.B. the day before his death on the 2nd of January 1898. He was the editor of four volumes of facsimiles of Anglo-Saxon charters from 679 to the Conquest, *The Speeches in the Trial of Warren Hastings* (1859-1861), and a number of other interesting historic documents.

BOND, in English law, an obligation by deed. Its design is to secure that the obligor, *i.e.* the person giving the bond, will either pay a sum of money, or do or refrain from doing some act; and for this purpose the obligor binds himself in a penalty to the obligee, with a condition added that, if the obligor pays the sum secured—which is usually half the penalty—or does or refrains from doing the specified act, the bond shall be void: otherwise it shall remain in full force. This condition is known as the *defeasance* because it defeats or undoes the bond. The form of a common money bond runs as follows:—

Know All Men by these presents that I, A. B. (name, address and description of obligor), am bound to C. D. (name, address and description of obligee) in the sum of £[2000] to be paid to the said (obligee), his executors, administrators or assigns or to his or their attorney, or attorneys, for which payment I bind myself by these presents. Sealed with my seal. Dated this _____ day of _____ 19____

The condition of the above-written bond is such that if the above A. B., his heirs, executors or administrators, shall on the day of _____ pay to the above-named C. D., his heirs, executors, administrators or assigns the sum of £[1000], with interest for the same from the date of the above-written bond at the rate of _____ per cent per annum without any deduction, then the above-written bond shall be void: otherwise the bond shall remain in full force.

Signed, sealed and delivered
by the above-named A. B.
in the presence of (witness)

Recitals are frequently added to explain the circumstances under which the bond is given.

If the condition is not performed, *i.e.* if the obligor does not pay the money by the day stipulated, or do or refrain from doing the act provided for, the bond becomes forfeit or absolute at law, and charges the obligor and his estate (see *Conveyancing Act 1881, s. 50*). In old days, when a bond was forfeit, the whole penalty was recoverable at law and payment *post diem* could not be pleaded to an action on it, but the court of chancery early interposed to prevent oppression. It held the penalty of a bond to be the form, not the substance of it, a pledge merely to secure repayment of the sum *bona fide* advanced, and would not permit a man to take more than in conscience he ought, *i.e.* in case of a common money bond, his principal, interest and expenses. This equitable relief received statutory recognition by an act of 1705, which provided that, in case of a common money bond, payment of the lesser sum with interest and costs shall be taken in full satisfaction of the bond. An obligee of a common money bond can, since the date of the Judicature Act, obtain summary judgment under O. xiv. (R.S.C. 1883) by specially endorsing his writ under O. iii. R. 6.

Bonds were, however, and still are given to secure performance of a variety of matters other than the payment of a sum of money at a fixed date. They may be given and are given, for instance,

¹ This word, meaning "that which binds," is a phonetic variant of "band," and is derived from the Teutonic root seen in *bindan*, to bind; it must be distinguished from the obsolete "bond," meaning originally a householder. In the laws of Canute this word is used as equal to the Old English *ceorl* (see *CHURL*), and as the *ceorl's* position became less free after the Norman Conquest, the "bond" approximated to the "villein," and still later to the "serf." The word is in Old English *banda*, and appears in "husband" (*q.v.*), and is derived from the root of the verb *bān*, to dwell, to have a house, the Latin *colere*, and thus in origin is cognate with German *Bauer* and English "boor." The transition in meaning to the idea of serfdom, and hence to slavery, is due to an early confusion with "bond," from "bind." The same wrong connexion appears in the transition of meaning in *bondage*, "properly" tenure in villeinage, but now used as synonymous with "slavery." A trace of the early meaning still survives in "bondager" (*q.v.*).

to guarantee the fidelity of a clerk, of a rent collector, or of a person in an office of public trust, or to secure that an intended husband will settle a sum on his wife in the event of her surviving him, or that a building contract shall be carried out, or that a rival business shall not be carried on by the obligor except within certain limits of time and space. The same object can often be attained—and more conveniently attained—by a covenant than by bond, and covenants have in the practice of conveyancers largely superseded bonds, but there are cases where security by bond is still preferable to security by covenant. Thus under a bond to secure an annuity, if the obligor makes default, judgment may be entered for the penalty and stand as security for the future payments without the necessity of bringing a fresh action for each payment. In cases of bonds with special conditions, such as those instanced above, the remedy of the obligee for breach of the condition is prescribed by an act of 1696, the procedure under which is preserved by the Judicature Act (O. xiii. R. 1, O. xiii. R. 14). The obligee assigns the particular breaches of which he complains, damages in respect of such breaches are assessed, and, on payment into court by the obligor of the amount of such damages, the court enters a stay of execution. A difficulty which has much exercised and still exercises the courts is to determine, in these cases of special conditions, whether the sum for which the bond is given is a true penalty or only liquidated damages. There is nothing to prevent the parties to a bond from agreeing the damages for a breach, and if they have done so, the court will not interfere, as it will in the case of a penalty. The leading case on the subject is *Kemble v. Farren* (1829; 6 Bing. 148).

Bonds given to secure the doing of anything which is contrary to the policy of the law are void. Such, for instance, is a bond given to a woman for future cohabitation (as distinguished from past cohabitation), or a marriage brokerage bond, that is, a bond given to procure a marriage between parties. (See the matrimonial agency case, *Hermann v. Charlesworth*, 1905, 2 K.B. 123). It was not without design that Shakespeare laid the scene of Shylock's suit on Antonio's bond in a Venetian court; the bond would have had short shrift in an English court.

Post Obit Bonds.—A post obit bond is one given by an expectant heir or legatee, payable on or after the death of the person from whom the obligor has expectations. Such a bond, if the obligee has exacted unconscionable terms, may be set aside.

Bottomry Bonds.—A bottomry bond is a contract of hypothecation by which the owner of a ship, or the master as his agent, borrows money for the use of the ship to meet some emergency, *e.g.* necessary repairs, and pledges the ship (or keel or bottom of the ship, *pariem pro toto*) as security for repayment. If the ship safely accomplishes her voyage, the obligee gets his money back with the agreed interest: if the ship is totally lost, he loses it altogether.

Lloyd's Bonds.—Lloyd's bonds are instruments under the seal of a railway company, admitting the indebtedness of the company to the obligee to a specified amount for work done or goods supplied, with a covenant to pay him such amount with interest on a future day. They are a device by which railway companies were enabled to increase their indebtedness without technically violating their charter. The name is derived from the counsel who settled the form of the bond.

Debenture Bonds.—Debenture bonds are bonds secured only by the covenant of the company without any floating or fixed charge on the assets. (See *DEBENTURES AND DEBENTURE STOCK*.)

Recognition.—A recognition differs from a bond in being entered into before a court of record and thereby becoming an obligation of record.

Heritable bond is a Scots law term, meaning a bond for money, joined with a conveyance of land, and held by a creditor as security for his debt.

For goods "in bond" see *BONDED WAREHOUSE*. (E. MA.)

BONDAGER, a word meaning generally a servant, but specially used in the south of Scotland and Northumberland as the term for a female outworker whom a married farm-labourer, living in a cottage attached to the farm, undertakes as a condition of his tenancy to supply for field-labour, sometimes also to board and lodge. The origin of the system was a dearth of field-labour.

BONDE, GUSTAF, COUNT (1620-1667), Swedish statesman. He is remarkable for being the persistent advocate of a pacific policy at a time when war on the slightest provocation was the watchword of every Swedish politician. Even the popular

Polish adventure of Charles X. was strenuously opposed by Bonde, though when once it was decided upon he materially assisted the king to find the means for carrying it on. He was also in favour of strict economy coupled with the recovery of the royal domains which had fallen into the hands of the nobles, though his natural partiality for his fellow-peers came out clearly enough when in 1655 he was appointed a member of Charles X.'s land-recovery commission. In 1659 he succeeded Herman Fleming as lord high treasurer, and was one of the council of regency appointed to govern Sweden during the minority of Charles XI. In 1661 he presented to the senate a plan which aimed at rendering Sweden altogether independent of foreign subsidies, by a policy of peace, economy and trade-development, and by further recovery of alienated estates. His budget in the following year, framed on the same principles, subsequently served as an invaluable guide to Charles XI. Bonde's extraordinary tenacity of purpose enabled him for some years to carry out his programme, despite the opposition of the majority of the senate and his co-regents, who preferred the more adventurous methods of the chancellor Magnus de la Gardie, ultimately so ruinous to Sweden. But the ambition of the oligarchs, and the fear and jealousy of innumerable monopolists who rose in arms against his policy of economy, proved at last too strong for Bonde, while the costly and useless expedition against Bremen in 1665, undertaken contrary to his advice, completed the ruin of the finances. In his later years Bonde's powers of resistance were weakened by sickness and mortification at the triumph of reckless extravagance, and he practically retired from the government some time before his death.

See Martin Veibull, *Sveriges Storhetskild* (Stockholm, 1881).

BONDED WAREHOUSE, a warehouse established by the state, or by private enterprise, in which goods liable to duty are lodged until the duty upon them has been paid. Previous to the establishment of bonded warehouses in England the payment of duties on imported goods had to be made at the time of importation, or a bond with security for future payment given to the revenue authorities. The inconveniences of this system were many; it was not always possible for the importer to find sureties, and he had often to make an immediate sale of the goods, in order to raise the duty, frequently selling when the market was depressed and prices low; the duty, having to be paid in a lump sum, raised the price of the goods by the amount of the interest on the capital required to pay the duty; competition was stifled from the fact that large capital was required for the importation of the more heavily taxed articles; there was also the difficulty of granting an exact equivalent drawback to the exporter, on goods which had already paid duty. To obviate these difficulties and to put a check upon frauds on the revenue, Sir Robert Walpole proposed in his "excise scheme" of 1733, the system of warehousing, so far as concerned tobacco and wine. The proposal, however, was very unpopular, and it was not till 1803 that the system was actually adopted. By an act of that year imported goods were to be placed in warehouses approved by the customs authorities, and importers were to give "bonds" for payment of duties when the goods were removed. It was from this that the warehouses received the name of "bonded" or "bonding." The Customs Consolidation Act 1853 dispensed with the giving of bonds, and laid down various provisions for securing the payment of customs duties on goods warehoused. These provisions are contained in the Customs Consolidation Act 1876, and the amending statutes, the Customs and Inland Revenue Act 1880, and the Revenue Act 1883. The warehouses are known as "king's warehouses," and by s. 284 of the act of 1876 are defined as "any place provided by the crown or approved by the commissioners of customs, for the deposit of goods for security thereof, and the duties due thereon." By s. 12 of the same act the treasury may appoint warehousing ports or places, and the commissioners of customs may from time to time approve and appoint warehouses in such ports or places where goods may be warehoused or kept, and fix the amount of rent payable in respect of the goods. The proprietor or occupier of every warehouse so approved

(except existing warehouses of special security in respect of which security by bond has hitherto been dispensed with), or some one on his behalf, must, before any goods be warehoused therein, give security by bond, or such other security as the commissioners may approve of, for the payment of the full duties chargeable on any goods warehoused therein, or for the due exportation thereof (s. 13). All goods deposited in a warehouse, without payment of duty on the first importation, upon being entered for home consumption, are chargeable with existing duties on like goods under any customs acts in force at the time of passing such entry (s. 19). The act also prescribes various rules for the unshipping, landing, examination, warehousing and custody of goods, and the penalties on breach. The system of warehousing has proved of great advantage both to importers and purchasers, as the payment of duty is deferred until the goods are required, while the title-deeds, or warrants, are transferable by endorsement.

While the goods are in the warehouse ("in bond") the owner may subject them to various processes necessary to fit them for the market, such as the repacking and mixing of tea, the racking, vatting, mixing and bottling of wines and spirits, the roasting of coffee, the manufacture of certain kinds of tobacco, &c., and certain specific allowances are made in respect of waste arising from such processes or from leakage, evaporation and the like.

BONDU, a French protectorate in West Africa, dependent on the colony of Senegal. Bondu lies between the Faleme river and the upper course of the Gambia, that is between 13° and 15° N., and 12° and 13° W. The country is an elevated plateau, with hills in the southern and central parts. These are generally unproductive, and covered with stunted wood; but the lower country is fertile, and finely clothed with the baobab, the tamarind and various valuable fruit-trees. Bondu is traversed by torrents, which flow rapidly during the rains but are empty in the dry season, such streams being known in this part of West Africa as *marigots*. The inhabitants are mostly Fula, though the trade is largely in the hands of Mandingos. The religion and laws of the country are Mahomedan, though the precepts of that faith are not very rigorously observed. Mungo Park, the first European traveller to visit the country, passed through Bondu in 1795, and had to submit to many exactions from the reigning prince. The royal residence was then at Fattedonda; but when Major W. Gray, a British officer who attempted to solve the Niger problem, visited Bondu in 1818 it had been removed to Bulibani, a small town, with about 3000 population, surrounded by a strong clay wall. In August 1845 the king of Bondu signed a treaty recognizing French sovereignty over his country. The treaty was disregarded by the natives, but in 1858 Bondu came definitely under French control. The country has since enjoyed considerable prosperity (see *SENEGAL*).

See A. Rançon, *Le Bondou: étude de géographie et d'histoire soudaniennes de 1681 à nos jours* (Bordeaux, 1894).

BONE, HENRY (1755-1834), English enamel painter, was born at Truro. He was much employed by London jewellers for small designs in enamel, before his merits as an artist were well known to the public. In 1800 the beauty of his pieces attracted the notice of the Royal Academy, of which he was then admitted as an associate; in 1811 he was made an academician. Up to 1831 he executed many beautiful miniature pieces of much larger size than had been attempted before in England; among these his eighty-five portraits of the time of Queen Elizabeth, of different sizes, from 5 by 4 to 13 by 8 in. are most admired. They were disposed of by public sale after his death. His Bacchus and Ariadne, after Titian, painted on a plate, brought the great price of 2000 guineas.

BONE (a word common in various forms to Teutonic languages, in many of which it is confined to the shank of the leg, as in the German *Bein*), the hard tissue constituting the framework of the animal skeleton. For anatomy see *SKELTON* and *CONNECTIVE TISSUES*.

BONE DISEASES AND INJURIES.—The more specific diseases affecting the bones of the human body are treated under separate

headings; in this article *inflammation of bone and fractures* are dealt with.

Ostitis (*ὀστέων*, bone), or inflammation of bone, may be acute or chronic. *Acute ostitis* is one of the most serious diseases which can be met with in young people. It is due to the *osteitis* cultivation of virulent germs in the delicate growing tissue of the bone and in the marrow. Another name for it is *septic osteomyelitis*, which has the advantage of expressing the cause as well as the exact seat (*μυελός*, marrow) of the inflammation. The name of the micro-organism causing the inflammation is *Staphylococcus pyogenes aureus*, which means that the germs collect in clusters like grapes, that they are of the virulent pus-producing kind, and that they have a yellow tinge. As a rule, the germs find their way to the bone by the blood-stream, which they have entered through the membrane lining the mouth or gullet, or some other part of the alimentary canal. In the pre-antiseptic days they often entered the sawn bone during the amputation of a limb, and were not infrequently the cause of blood-poisoning and death. When the individual is well and strong, and there has been no hurt, strain or accident to lower the power of resistance of the bone, the staphylococci may circulate harmlessly in the blood, until they are gradually eaten up by the white corpuscles; but if a bone has been injured it offers a likely and attractive focus to the wandering germs.

The disease is infective. That is to say, the micro-organisms having begun to germinate in the damaged bone find their way by the blood-stream into other tissues, and developing after their kind, are apt to cause blood-poisoning. Should a surgeon prick his finger whilst operating on a case of septic osteomyelitis his blood also might be poisoned, and he would run the risk of losing his finger, his hand, or even his life. The starting-point of the disease is the delicate growing tissue recently deposited between the main part of the shaft of the bone (diaphysis) and the cartilaginous end. And it often happens that the earliest complaint of pain is just above or below the knee; just above the ankle, the elbow or the wrist. It the surgeon is prompt in operating he may find the disease limited to that spot. In the case of infants, the germs are very apt to make their way into the neighbouring joint, giving rise to the very serious disease known as *acute arthritis of infants*.

Probably the first sign of there being anything amiss with the limb will be a complaint of aches or pains near a joint; and these pains are apt to be mis-called rheumatic. Perhaps they occur during convalescence from scarlet or typhoid fever, or after exposure to injury, or to wet or cold, or after unusual fatigue. The part becomes swollen, hot, red and excessively tender; the tenderness, however, is not in the skin but in the bone, and in the engorged membrane around it, the periosteum. The temperature may run up to 104°, and may be associated with convulsions or shiverings. The patient's nights are disturbed, and very likely he has violent delirium. If the case is allowed to drift on, abscess forms, and death may ensue from septic pneumonia, or pericarditis, or from some other form of blood-poisoning.

As soon as the disease is recognized an incision should be made down to the bone, and the affected area should be scraped out, and disinfected with a solution of corrosive sublimate. A considerable area of the bone may be found stripped bare by sub-periosteal abscess, and necrosis is likely to ensue. Perhaps the shaft of the bone will have to be opened up in the chief part of its length in order that it may be cleared of germs and pus. The surgeon is more apt to err on the side of doing too little in these serious cases than too much. It may be that the whole of that piece of bone (diaphysis) which lies between the joint-ends is found loose in a large abscess cavity, and in some cases immediate amputation of the limb may be found necessary in order to save life; in other cases, amputation may be called for later because of long-continued suppuration and grave constitutional disturbance. Several bones may be affected at the same time, and large pieces of them may be killed outright (*multiple necrosis*) by inflammatory engorgement and devastating abscess.

Septic ostitis may be confounded with erysipelas and rheuma-

tism, but the central thickening and tenderness should suffice to distinguish it.

Chronic ostitis and *periostitis* denote long-continued and increased vascular supply. This may be due to injury, syphilis or rheumatism. The disease is found chiefly in the shafts of the bones. There is a dull pain in the bone, which is worse at night, and the inflamed piece of bone is thickened and tender. The lump thus formed is called a *hard node*, and its outline shows clearly by X-rays. The affected limb should be rested and kept elevated. Leeches and fomentations may ease the pain, and iodide of potassium is the most useful medicine.

Chronic inflammation of tuberculous origin affects the soft, cancellated tissue of such bones as the vertebrae, and the bones of the hands and feet, as well as the spongy ends of the long bones. In tuberculous ostitis the presence of the bacilli in the spongy tissue causes an escape of colourless corpuscles from the blood, which, collecting around the bacilli, form a small greyish white heap, a *tubercle*. These tubercles may be present in large numbers at the expense of the living tissue, and a *rarefying ostitis* is thus produced. Later the tubercles break down and form tuberculous abscesses, which slowly, and almost painlessly, find escape upon the surface. They should not be allowed to open spontaneously, however, as the wounds are then likely to become infected with pus-producing germs, and fuel being added to the fire, as it were, destruction advances with increased rapidity. The treatment for these tuberculous foci is to place the limb or the part at absolute rest upon a splint, to give plenty of fresh air to the patient, and to prescribe cod-liver oil and iron. And when it is seen that in spite of the adoption of these measures the tuberculous abscess is advancing towards the surface, the surgeon should cut down upon the part, scrape out the foci, and disinfect with some strong antiseptic lotion. Consideration should also be given to the treatment by injection of tuberculin.

Caries (rottenness, decay) is the name given to tuberculous disease of bone when the tubercles are running together and are breaking down the cancellous tissue. In short, caries generally means tuberculous ostitis, though syphilitic ulceration of bone has also received the same name.

Fractures.—A bone may be broken at the part where it is struck (fracture from direct violence), or it may break in consequence of a strain applied to it (fracture from indirect violence), or the fracture may be due to muscular action as when a violent cough causes a rib to break. In the first case the fracture is generally transverse and in the second more or less oblique. The fully developed bone is broken fairly across; the soft bones of young people may simply be bent—*green stick* or *willow fracture*. Fractures are either *simple* or *compound*. A simple fracture is analogous to the subcutaneous laceration in the soft parts, and a compound one to an open wound in the soft parts. The wound of the soft parts in the compound fracture may be due either to the force which caused the fracture, as in the case of a cart-wheel going over a limb, first wounding the soft parts and then fracturing the bone, or to the sharp point of the fractured bone coming out through the skin. In either case there is a communication between the external air and injured bone, and the probability arises of the germs of suppurating finding their way to the seat of fracture. This greatly increases the risks of the case, for septic inflammation and suppuration may lead to delayed union, to death of large pieces of the bone (necrosis), and to osteomyelitis and to blood-poisoning. In the treatment of a fracture, every care should be taken to prevent any sharp fragment coming near the skin. Careless handling has often been the means of a simple fracture being converted into a compound one.

In most cases of fracture *crepitus* can be made out; this is the feeling elicited when two rough osseous surfaces are rubbed together. When a bone is merely bent there is, of course, no crepitus. It is also absent in fractures in which the broken extremities are driven into one another (impacted fracture). In order to get firm bony union it is necessary to secure accurate apposition of the fragments. Putting the broken ends together is termed "setting the fracture," and the needful amount of rest is obtained by the use of splints. As a rule, it is also advisable to

fix with the splint the joint above or below the fracture. In cases in which a splintering of the bone into a joint has taken place, more especially in those cases in which tendons have been injured, there may be a good deal of effusion into the joint and the tendon sheaths, and this may be organized into fibrous tissue leading to permanent stiffness. This is particularly apt to occur in old people. Care must be taken in such instances by gentle exercises, and by passive movement during the process of cure, to keep the joint and tendons free. To take a common example,—in fracture close to the wrist joint, it is necessary to arrange the splint so that the patient can move his fingers and thumb, and the splint must be taken off every day, in order that the wrist and fingers may be gently bent, straightened and exercised.

The treatment of fractures has undergone considerable improvement of late years. Simple fractures are not kept so long at rest in splints, but are constantly "taken down" in order that massage and movements of the limb may be resorted to. This, of course, is done with the utmost gentleness, and with the result that swelling, pain and other evidences of the serious injury quickly disappear, whilst a more rapid and complete recovery is ensured. Stiff hands and feet after fracture are much less frequently met with. By the aid of the X-rays it is now easy for the surgeon to assure himself that fractured surfaces have been well adjusted and are in close apposition. But if they are not in a satisfactory position, and it be found impracticable to assure their close adjustment by ordinary methods, the surgeon now, without undue loss of time, cuts down upon the broken ends and fixes them together by a strong wire suture, which remains permanently in the tissues. If the fracture be associated with an open wound of the part (compound fracture), and the broken ends are found incapable of easy adjustment, immediate wiring together of the fragments is now considered to be a necessary part of the primary treatment. The French surgeon, Just Lucas-Championnière, has done more than any one else to show the advantage of discreet movements, of massage and of exercises in the treatment of fractures.

Special Fracture in Young People.—The long bones of children and growing persons consist of a shaft with cartilaginous ends in which bone is developed. As the result of injury, the end of the bone may become detached, a variety of fracture known as *diastasis*. Such a fracture—however well treated—may be followed by arrest of growth of the bone or by stiffness of the neighbouring joint.

Delayed union means that consolidation is taking place very slowly, if at all. This may be due to local or constitutional causes, but provided the bones are in good position, nothing further than patience, with massage, and with due attention to general health-measures, is necessary.

An *united fracture* is one in which after many weeks or months no attempt has been made by nature to consolidate the parts. This may be due to the ends not having been brought close enough together; to the seat of fracture having been constantly disturbed; to muscle or tendon being interposed between the broken ends, or to the existence of some constitutional defect in the patient. Except in the last-named condition, the treatment consists in cutting down to the broken ends; freshening them up by sawing off a thin slice, and by adjusting and fixing them by a wire or screw. Ununited fracture of the leg-bones in children is a most unsatisfactory and rebellious condition to deal with.

There is still a difference of opinion as to the best way of treating a recent *fracture of the patella* (knee-cap). Many surgeons are still content to follow the old plan of fixing the limb on a back-splint, or in plaster of Paris splints, and awaiting the result. It is beyond question that a large percentage of these cases recover with a perfectly useful limb—especially if the fibrous bond of union between the pieces of the broken knee-cap is adequately protected against being stretched by bending the leg at too early a date. But in some cases the fragments have been eventually found wide apart, the patient being left with an enfeebled limb. Still, at any rate, this line of treatment was

unassociated with risk. But after Lister showed (1883) that with due care and cleanliness the knee-joint could be opened, and the fragments of the broken patella secured in close apposition by a stout wire suture, the treatment of the injury underwent a remarkable change. The great advantage of Lister's treatment was that the fragments, being fixed close together by the wire stitch, became solidly united by bone, and the joint became as sound as it was before. Some surgeons, however, objected to the operation—in spite of the excellence of the results obtainable by it—because of the undoubted risk which it entailed of the joint becoming invaded by septic micro-organisms. As a sort of compromise, Professor A. E. J. Barker introduced the method, which he deemed to be less hazardous, of holding the fragments close together by means of a strong silver wire passed round them vertically by a large needle without actually laying open the joint. But experience has shown that in the hands of careful and skilful surgeons Lister's operation of openly wiring the fragments gives a perfect result with a comparatively small risk. Other surgeons secure the fragments in close contact for bony union by passing a silk or metal suture around them circumferentially. Many years ago Lister remarked that the careful selection of one's patients is an antiseptic measure—by which he meant that if a surgeon intended to get the most perfect results for his operative work, he must carefully consider whether any individual patient is physically adapted for the performance upon him of any particular operation. This aphorism implies that not every patient with a broken knee-cap is suited for the opening of his knee-joint, or even for the subcutaneous adjustment of the broken fragments. An operative procedure which is admirably suited for one patient might result in disaster when adopted for another, and it is an important part of the surgeon's business to know what to advise in each individual case. (E. O.*)

Industrial Applications of Bones.—By the increasing inventiveness of man, the industrial utilization of animal bone has been so developed that not one of the constituents fails to reappear in commerce. Composed of mineral matter—phosphates, &c.—fat and gelatinous substances, the phosphates are used as artificial manures, the fat is worked up by the soap-maker and chandler, and the gelatinous matter forms the basis of the gelatin and glue of commerce; while by the dry distillation of bones from which the gelatin has been but partially removed, there are obtained a carbonaceous residue—animal charcoal—and a tarry distillate, from which "bone oil" and bone pitch are obtained. To these by-products there must be added the direct uses of bone—for making buttons, knife-handles, &c.—when an estimate is desired of the commercial importance of these components of the animal frame.

While most of the world's supply of bones goes to the glue and gelatin works, the leg and thigh bones, termed "marrows" and "knuckles," are used for the manufacture of bone articles. The treatment which they receive is very different from that practised in the glue-works. The ends are removed by a saw, and the bones are steeped in a 1% brine solution for three to four days, in order to separate the fibrous matter. The bones are now heated with water, and allowed to simmer for about six hours. This removes a part of the fat and gelatinous matter; the former rises as a scum, the latter passes into solution, and the bones remain sufficiently firm to be worked up by the lathe, &c. The fat is skimmed off, and, after bleaching, reappears as a component of fine soaps, or, if unbleached, the oil is expressed and is used as an adulterant of other oils, while the stearine or solid matter goes to the candle-maker; the gelatinous water is used (after filtration) for making size for cardboard boxes; while the bones are scrubbed, dried, and then transferred to the bone-worker.

The glue-worker first removes the fat, which is supplied to the soap and candle trades; the bones are now treated for glue (g.s.): and the residue is worked up for manures, &c. These residues are ground to a fine or coarse meal, and supplied either directly as a fertilizer or treated with sulphuric acid to form the more soluble superphosphates, which are more readily assimilated by growing plants. In some places, especially South America, the residues are burned in a retort to a white ash, the "bone-ash" of commerce, which contains some 70–80% of tricalcium phosphate, and is much used as a manure, and in the manufacture of high-grade superphosphates. In the gelatin industry (see GELATIN) the mineral matter has to be recovered from its solution in hydrochloric acid. To effect this, the liquors are freed from suspended matter by filtration, and then run into vats where they are mixed with milk of lime, or some similar neutralizer. The slightly soluble bicalcium phosphate, Ca_2HPO_4 , is first precipitated, which, with more lime gives ordinary tricalcium phosphate, $\text{Ca}_3(\text{PO}_4)_2$. The contents of

the vats are filter-pressed, and the cakes dried on plates supported on racks in heated chambers. This product is a very valuable manure, and is also used in the manufacture of phosphorus.

Instead of extracting all the gelatinous matter from degreased bones, the practice of extracting about one half and carbonizing the residue is frequently adopted. The bones are heated in horizontal cast-iron retorts, holding about 5 cwt., and the operation occupies about twelve to thirteen hours. The residue in the retorts is removed while still red-hot to air-tight vessels in which it is allowed to cool. It is then passed through grinding mills, and is subsequently riddled by revolving cylindrical sieves. The yield is from 55 to 60% of the bones carbonized, and the product contains about 10% of carbon and about 75% of calcium phosphate, the remainder being various inorganic salts and moisture (6-7%). Animal charcoal has a deep black colour, and is much used as a filtering and clarifying material. The vapours evolved during carbonization are condensed in vertical air condensers. The liquid separates into two layers: the upper tarry layer is floated off and redistilled; the distillate is termed "bone oil," and mainly consists of many fatty amines and pyridine derivatives, characterized by a most disgusting odour; the residue is "bone pitch," and finds application in the manufacture of black varnishes and like compositions. The lower layer is ammoniacal liquor; it is transferred to stills, distilled with steam, and the ammonia received in sulphuric acid; the ammonium sulphate, which separates, is removed, drained and dried, and is principally used as a manure. Both during the carbonization of the bones and the distillation of the tar inflammable gases are evolved; these are generally used, after purification, for motive or illuminating purposes. (C. E.)

BONE BED, a term loosely used by geologists when speaking generally of any stratum or deposit which contains bones of whatever kind. It is also applied to those brecciated and stalagmitic deposits on the floor of caves, which frequently contain osseous remains. In a more restricted sense it is used to connote certain thin layers of bony fragments, which occur upon well-defined geological horizons. One of the best-known of these is the Ludlow Bone Bed, which is found at the base of the Downton Sandstone in the Upper Ludlow series. At Ludlow itself, two such beds are actually known, separated by about 14 ft. of strata. Although quite thin, the Ludlow Bone Bed can be followed from that town into Gloucestershire for a distance of 45 m. It is almost made up of fragments of spines, teeth and scales of ganoid fish. Another well-known bed, formerly known as the "Bristol" or "Lias" Bone Bed, exists in the form of several thin layers of micaceous sandstone, with the remains of fish and saurians, which occur in the Rhaetic Black Paper Shales that lie above the Keuper marls in the south-west of England. It is noteworthy that a similar bone bed has been traced on the same geological horizon in Brunswick, Hanover and Franconia. A bone bed has also been observed at the base of the Carboniferous limestone series in certain parts of the south-west of England.

BONE-LACE, a kind of lace made upon a cushion from linen thread; the pattern is marked out with pins, round which are twisted the different threads, each wound on its own bobbin. The lace was so called from the fact that bobbins were formerly made of bone.

BONER (or **BONERUS**), **ULRICH** (fl. 14th century), German-Swiss writer of fables, was born in Bern. He was descended of an old Bernese family, and, as far as can be ascertained, took clerical orders and became a monk; yet as it appears that he subsequently married, it is certain that he received the "tonsure" only, and was thus entitled to the benefit of the *clericus uxoriatus*, who, on divesting themselves of the clerical garb, could return to secular life. He is mentioned in records between 1324 and 1349, but neither before nor after these dates. He wrote, in Middle High German, a collection of fables entitled *Der Edelstein* (c. 1349), one hundred in number, which were based principally on those of Avianus (4th century) and the *Aesopismus* (edited by I. Nevelet, 1610). This work he dedicated to the Bernese patrician and poet, Johann von Rinkenbergh, advocatus (*Vogt*) of Brienz (d. c. 1350). It was printed in 1461 at Bamberg; and it is claimed for it that it was the first book

printed in the German language. Boner treats his sources with considerable freedom and originality; he writes a clear and simple style, and the necessarily didactic tone of the collection is relieved by touches of humour.

Der Edelstein has been edited by G. F. Benecke (Berlin, 1816) and Franz Pfeiffer (Leipzig, 1844); a translation into modern German by K. Pannier will be found in Reclam's *Universal-Bibliothek* (Leipzig, 1895). See also G. E. Lessing in *Zur Geschichte und Literatur* (*Werke*, ix.); C. Waas, *Die Quellen der Beispiele Boners* (Giessen, 1897).

BO'NESS, or **BORROWSTOUNNESS**, a municipal and police burgh and seaport of Linlithgowshire, Scotland. Pop. (1891) 6295; (1901) 9306. It lies on the southern shore of the Firth of Forth, 17 m. W. by N. of Edinburgh, and 24 m. by rail, being the terminus of the North British railway's branch line from Manuel. In the 18th century it ranked next to Leith as a port, but the growth of Grangemouth, higher up the firth, seriously affected its shipping trade, which is, however, yet considerable, coal and pig-iron forming the principal exports, and pit props from the Baltic the leading import. It has an extensive harbour (the area of the dock being 7½ acres). The great industries are coal-mining—some of the pits extending for a long distance beneath the firth—iron-founding (with several blast furnaces) and engineering, but it has also important manufactures of salt, soap, vitriol and other chemicals. Shipbuilding and whaling are extinct. Traces of the wall of Antoninus which ran through the parish may still be made out, especially near Inveravon. Blackness, on the coast farther east, was the seaport of Linlithgow till the rise of Bo'ness, but its small export trade now mainly consists of coal, bricks, tiles and lime. Its castle, standing on a promontory, is of unknown age. James III. of Scotland is stated to have consigned certain of the insurgent nobles to its cells, and later it was used as a prison in which many of the Covenanters were immured. It was one of the four castles that had to be maintained by the Articles of Union, but when its uselessness for defensive purposes became apparent, it was converted into an ammunition depot. Kinneil House, 1 m. south of Bo'ness, a seat of the duke of Hamilton, formerly a keep, was fortified by the regent Arran, plundered by the rebels in Queen Mary's reign, and reconstructed in the time of Charles II. Dr John Roebuck (1718-1794), founder of the Carron Iron Works, occupied it for several years from 1764. It was here that, on his invitation, James Watt constructed a model of his steam-engine, which was tested in a now disused colliery. Though Roebuck lost all his money in the coal-mines and salt works which he established at Bo'ness, the development of the mineral resources of the district may be regarded as due to him.

BONFIGLI, **BENEDETTO**, 15th century Italian painter, was born at Perugia. Until near the middle of the 15th century the Umbrian school was far behind those of Florence and the North, but in the person of Perugino and some of his followers it suddenly advanced into the very first rank. Among the latter none holds a more distinguished place than Benedetto Bonfigli. The most important of his extant works are a series, in fresco, of the life of St Louis of Toulouse, in the communal palace of Perugia.

BONFIRE (in Early English "bone-fire," Scottish "bane-fire"), originally a fire of bones, now any large fire lit in the open air on an occasion of rejoicing. Though the spelling "bonfire" was used in the 16th century, the earlier "bone-fire" was common till 1760. The earliest known instance of the derivation of the word occurred as *ban fyre ignis ossium* in the *Catholicum Anglicum*, A.D. 1483. Other derivations, now rejected, have been sought for the word. Thus some have thought it *Baal-fire*, passing through *Bael*, *Baen* to *Bane*. Others have declared it to be *boon-fire* by analogy with *boen-harow*, i.e. "harrowing by gift," the suggestion being that these fires were "contribution" fires, every one in the neighbourhood contributing a portion of the material, just as in Northumberland the "contributed Ploughing Days" are known as *Bone-daags*.

Whatever the origin of the word, it has long had several meanings—(a) a fire of bones, (b) a fire for corpses, a funeral pile, (c) a fire for immolation, such as that in which heretics and

Bone oil, also known as Dippel's oil, was originally produced by the distillation of stags' horns; it is of interest in the history of chemistry, since from it were isolated in 1846 by T. Anderson pyridine and some of its homologues.

proscribed books were burnt, (d) a large fire lit in the open air, on occasions of national rejoicing, or as a signal of alarm such as the bonfires which warned England of the approach of the Armada. Throughout Europe the peasants from time immemorial have lighted bonfires on certain days of the year, and danced around or leapt over them. This custom can be traced back to the middle ages, and certain usages in antiquity so nearly resemble it as to suggest that the bonfire has its origin in the early days of heathen Europe. Indeed the earliest proof of the observance of these bonfire ceremonies in Europe is afforded by the attempts made by Christian synods in the 7th and 8th centuries to suppress them as pagan. Thus the third council of Constantinople (A.D. 680), by its 65th canon, orders: "Those fires that are kindled by certain people on new moons before their shops and houses, over which also they use ridiculously and foolishly to leape, by a certaine antient custome, we command them from henceforth to cease." And the Synodus Franca under Pope Zachary, A.D. 742, forbids "those sacrilegious fires which they call *Nedfri* (or bonefires), and all other observations of the Pagans whatsoever." Leaping over the fires is mentioned among the superstitious rites used at the *Pallia* (the feast of Palés, the shepherds' goddess) in Ovid's *Fasti*, when the shepherds lit heaps of straw and jumped over them as they burned. The lighting of the bonfires in Christian festivals was significant of the compromise made with the heathen by the early Church. In Cornwall bonfires are lighted on the eve of St John the Baptist and St Peter's day, and midsummer is thence called in Cornish *Golan*, which means both "light" and "festivity." Sometimes effigies are burned in these fires, or a pretence is made of burning a living person in them, and there are grounds for believing that anciently human sacrifices were actually made in the bonfires. Spring and midsummer are the usual times at which these bonfires are lighted, but in some countries they are made at Hallowe'en (October 31) and at Christmas. In spring the 1st Sunday in Lent, Easter eve and the 1st of May are the commonest dates.

See J. G. Frazer, *Golden Bough*, vol. iii., for a very full account of the bonfire customs of Europe, &c.

BONGARS, JACQUES (1554-1612), French scholar and diplomatist, was born at Orleans, and was brought up in the reformed faith. He obtained his early education at Marburg and Jena, and returning to France continued his studies at Orleans and Bourges. After spending some time in Rome he visited eastern Europe, and subsequently made the acquaintance of Ségur Pardailan, a representative of Henry, king of Navarre, afterwards Henry IV. of France. He entered the service of Pardailan, and in 1587 was sent on a mission to many of the princes of northern Europe, after which he visited England to obtain help from Queen Elizabeth for Henry of Navarre. He continued to serve Henry as a diplomatist, and in 1593 became the representative of the French king at the courts of the imperial princes. Vigorously seconding the efforts of Henry to curtail the power of the house of Habsburg, he spent health and money ungrudgingly in this service, and continued his labours until the king's murder in 1610. He then returned to France, and died at Paris on the 29th of July 1612. Bongars wrote an abridgment of Justin's abridgment of the history of Trogus Pompeius under the title *Justinus, Trogi Pompeii Historiarum Philippicarum epitoma de manuscriptis codicibus emendator et prologis auctior* (Paris, 1581). He collected the works of several French writers who as contemporaries described the crusades, and published them under the title *Gesta Dei per Francos* (Hanover, 1611). Another collection made by Bongars is the *Rerum Hungaricarum scriptores varii* (Frankfort, 1600). His *Epistolae* were published at Leiden in 1647, and a French translation at Paris in 1668-1670. Many of his papers are preserved in the library at Bern, to which they were presented in 1632, and a list of them was made in 1634. Other papers and copies of instructions are now in several libraries in Paris; and copies of other instructions are in the British Museum.

See H. Hagen, *Jacobus Bongarsius* (Bern, 1874); L. Anquez, *Henri IV et l'Allemagne* (Paris, 1887).

BONGHI, RUGGERO (1828-1895), Italian scholar, writer and politician, was born at Naples on the 20th of March 1828. Exiled from Naples in consequence of the movement of 1848, he took refuge in Tuscany, whence he was compelled to flee to Turin on account of a pungent article against the Bourbons. At Turin he resumed his philosophic studies and his translation of Plato, but in 1858 refused a professorship of Greek at Pavia, under the Austrian government, only to accept it in 1859 from the Italian government after the liberation of Lombardy. In 1860, with the Cavour party, he opposed the work of Garibaldi, Crispi and Bertani at Naples, and became secretary of Luigi Carlo Farini during the latter's lieutenantancy, but in 1865 assumed contemporaneously the editorship of the *Perseveranza* of Milan and the chair of Latin literature at Florence. Elected deputy in 1860 he became celebrated by the biting wit of his speeches, while, as journalist, the acrimony of his polemical writings made him a redoubtable adversary. Though an ardent supporter of the historic Right, and, as such, entrusted by the Lanza cabinet with the defence of the law of guarantees in 1870, he was no respecter of persons, his caustic tongue sparing neither friend nor foe. Appointed minister for public instruction in 1873, he, with feverish activity, reformed the Italian educational system, suppressed the privileges of the university of Naples, founded the Vittorio Emanuele library in Rome, and prevented the establishment of a Catholic university in the capital. Upon the fall of the Right from power in 1876 he joined the opposition, and, with characteristic vivacity, protracted during two months the debate on Baccelli's University Reform Bill, securing, single-handed, its rejection. A bitter critic of King Humbert, both in the *Perseveranza* and in the *Nuova Antologia*, he was, in 1893, excluded from court, only securing readmission shortly before his death on the 22nd of October 1895. In foreign policy a Francophile, he combated the Triple Alliance, and took considerable part in the organization of the inter-parliamentary peace conference. (H. W. S.)

BONGO (DOR or DERAN), a tribe of Nilotic negroes, probably related to the Zandeh tribes of the Welle district, inhabiting the south-west portion of the Bahr-el-Ghazal province, Anglo-Egyptian Sudan. G. A. Schweinfurth, who lived two years among them, declares that before the advent of the slave-raiders, c. 1850, they numbered at least 300,000. Slave-raiders, and later the dervishes, greatly reduced their numbers, and it was not until the establishment of effective control by the Sudan government (1904-1906) that recuperation was possible. The Bongo formerly lived in countless little independent and peaceful communities, and under the Sudan government they again manage their own affairs. Their huts are well built, and sometimes 24 ft. high. The Bongo are a race of medium height, inclined to be thick-set, with a red-brown complexion—"like the soil upon which they reside"—and black hair. Schweinfurth declares their heads to be nearly round, no other African race, to his knowledge, possessing a higher cephalic index. The women incline to steatopygia in later life, and this deposit of fat, together with the tail of bast which they wore, gave them, as they walked, Schweinfurth says, the appearance of "dancing baboons." The Bongo men formerly wore only a loin-cloth, and many dozen iron rings on the arms (arranged to form a sort of armour), while the women had simply a girdle, to which was attached a tuft of grass. Both sexes now largely use cotton cloths as dresses. The tribal ornaments consist of nails or plugs which are passed through the lower lip. The women often wear a disk several inches in diameter in this fashion, together with a ring or a bit of straw in the upper lip, straws in the *alae* of the nostrils, and a ring in the *septum*. The Bongo, unlike other of the upper Nile Negroes, are not great cattle-breeders, but employ their time in agriculture. The crops mostly cultivated are sorghum, tobacco, sesame and durra. The Bongo eat the fruits, tubers and fungi in which the country is rich. They also eat almost every creature—bird, beast, insect and reptile, with the exception of the dog. They despise no flesh, fresh or putrid. They drive the vulture from carrion, and eat with relish the intestinal worms of the ox. Earth-eating, too, is

common among them. They are particularly skilled in the smelting and working of iron. Iron forms the currency of the country, and is extensively employed for all kinds of useful and ornamental purposes. Bongo spears, knives, rings, and other articles are frequently fashioned with great artistic elaboration. They have a variety of musical instruments—drums, stringed instruments, and horns—in the practice of which they take great delight; and they indulge in a vocal recitative which seems intended to imitate a succession of natural sounds. Schweinfurth says that Bongo music is like the raging of the elements. Marriage is by purchase; and a man is allowed to acquire three wives, but not more. Tattooing is partially practised. As regards burial, the corpse is bound in a crouching position with the knees drawn up to the chin; men are placed in the grave with the face to the north, and women with the face to the south. The form of the grave is peculiar, consisting of a niche in a vertical shaft, recalling the mastaba graves of the ancient Egyptians. The tombs are frequently ornamented with rough wooden figures intended to represent the deceased. Of the immortality of the soul they have no defined notion; and their only approach to a knowledge of a beneficent deity consists in a vague idea of luck. They have, however, a most intense belief in a great variety of petty goblins and witches, which are essentially malignant. Arrows, spears and clubs form their weapons, the first two distinguished by a multiplicity of barbs. Euphorbia juice is used as a poison for the arrows. Shields are rare. Their language is musical, and abounds in the vowels *e* and *a*; its vocabulary of concrete terms is very rich, but the same word has often a great variety of meanings. The grammatical structure is simple. As a race the Bongo are gentle and industrious, and exhibit strong family affection.

See G. A. Schweinfurth, *The Heart of Africa* (London, 1873); W. Junker, *Travels in Africa* (Eng. edit., London, 1890-1892).

BONGO (*Boobercus erycaurus*), a West African bushbuck, the largest of the group. The male is deep chestnut, marked on the body with narrow white stripes, on the chest with a white crescent, and on the face by two white spots below the eye. In the East African bongo (*B. e. isaaci*) the body hue is stronger and richer. There is, as yet, no evidence as to whether the females of the true bongo bear horns, though it is probable they do; but as the horns are present in both sexes of the East African form, Mr Oldfield Thomas has made that the type of the genus.¹

BONHAM, a town and the county-seat of Fannin county, Texas, U.S.A., about 14 m. S. of the Red river, in the north-east part of the state, and 70 m. N. of Dallas. Pop. (1890) 3361; (1900) 5042 (1223 being negroes); (1910), 4844. It is served by the Missouri, Kansas & Texas, and the Texas & Pacific railways. Bonham is the seat of Carlton College (Christian), a woman's college founded in 1867; and its high school is one of the best in the state. It is a trading and shipping centre of an extensive farming territory devoted to the raising of live-stock and to the growing of cotton, Indian corn, fruit, &c. It has large cotton gins and compresses, a large cotton mill, flour mills, canning and ice factories, railway repair shops, planing mills and carriage works. The town was named in honour of J. B. Bonham, a native of South Carolina, who was killed in the Alamo. The first settlement here was made in 1836. The town was incorporated in 1850, and was reincorporated in 1886.

BONHEUR [MARIE ROSALIE], ROSA (1822-1890), French painter, was born at Bordeaux on the 22nd of March 1822. She was of Jewish origin. Jacques Wiener, the Belgian medallist, a native of Venloo, says that he and Raymond Bonheur, Rosa's father, used to attend synagogue in that town; while another authority asserts that Rosa used to be known in common parlance by the name of Rosa Mazeltov (a Hebrew term for "good luck," *Gollid* Bonheur). She was the eldest of four children, all of whom were artists—Auguste (1824-1884) painted animals and landscape; Juliette (1830-1891) was "honourably mentioned" at the exhibition of 1855; Isidore, born in 1827, was a sculptor of animals. Rosa at an early age was taught to draw by her

father (who died in 1849), and he, perceiving her very remarkable talent, permitted her to abandon the business of dressmaking, to which, much against her will, she had been put, in order to devote herself wholly to art. From 1840 to 1845 she exhibited at the salon, and five times received a prize; in 1848 a medal was awarded to her. Her fame dates more especially from the exhibition of 1855; from that time Rosa Bonheur's works were much sought after in England, where collectors and public galleries competed eagerly for them. What is chiefly remarkable and admirable in her work is that, like her contemporary, Jacques Raymond Brascassat (1804-1867), she represents animals as they really are, as she saw them in the country. Her gift of accurate observation was, however, allied to a certain dryness of style in painting; she often failed to give a perfect sense of atmosphere. On the other hand, the anatomy of her animals is always faultlessly true. There is nothing feminine in her handling; her treatment is always manly and firm. Of her many works we may note the following:—"Ploughing in the Nivernais" (1848), in the Luxembourg gallery; "The Horse Fair" (1853), one of the two replicas of which is in the National Gallery, London, the original being in the United States; and "Hay Harvest in Auvergne" (1855). She was decorated with the Legion of Honour by the empress Eugénie, and was subsequently promoted to the rank of "officer" of the order. After 1867 Rosa Bonheur exhibited but once in the salon, in 1899, a few weeks before her death. She lived quietly at her country house at By, near Fontainebleau, where for some years she had held gratuitous classes for drawing. She left at her death a considerable number of pictures, studies, drawings and etchings, which were sold by auction in Paris in the spring of 1900. (H. Fr.)

BONHEUR DU JOUR, the name for a lady's writing-desk, so called because, when it was introduced in France about 1760, it speedily became intensely fashionable. The bonheur du jour is always very light and graceful; its special characteristic is a raised back, which may form a little cabinet or a nest of drawers, or may simply be fitted with a mirror. The top, often surrounded with a chased and gilded bronze gallery, serves for placing small ornaments. Beneath the writing surface there is usually a single drawer. The details vary greatly, but the general characteristics are always traceable. The bonheur du jour has never been so delicate, so charming, so coquettish as in the quarter of a century which followed its introduction. The choicer examples of the time are inlaid with marqueterie, edged with exotic woods, set in gilded bronze, or enriched with panels of Oriental lacquer.

BONI (*Bona*), a vassal state of the government of Celebes, Dutch East Indies, in the south-west peninsula of Celebes, on the Gulf of Boni. Area, 2600 sq. m. It produces rice, tobacco, coffee, cotton and sugar-cane, none of them important as exports. The breeds of buffaloes and horses in this state are highly esteemed. The chief town, Boni, lies 80 m. N.E. of Macassar, and 2½ m. from the east coast of the peninsula. The native race of Bugis (*g.v.*), whose number within this area is about 70,000, is one of the most interesting in the whole archipelago.

Boni was once the most powerful state of Celebes, all the other princes being regarded as vassals of its ruler, but its history is not known in detail. In 1666 the rajah Palakkah, whose father and grandfather had been murdered by the family of Hassan, the tyrant of Sumatra, made common cause with the Dutch against that despot. From that date till the beginning of the 19th century Dutch influence in the state remained undisputed. In 1814, however, Boni fell into the hands of the British, who retained it for two years; but by the European treaties concluded on the downfall of Napoleon it reverted to its original colonizers. Their influence, however, was resisted more than once by the natives. An expedition in 1825, under General van Geen, was not fully successful in enforcing it; and in 1858 and the following year two expeditions were necessary to oppose an attempt by the princes regent towards independence. In 1860 a new prince, owing allegiance to the Dutch, was set up. As in other native states in Celebes,

¹ *Annals and Mag. Nat. Hist.* vol. x. (seventh series), p. 309.

succession to the throne in the female line has precedence over the male line.

For the wars in Boni, see Perelaer, *De Bonische expeditio, 1859-1860* (Leiden, 1872); and Meyers, in the *Militaire Spectator* (1880).

BONIFACE, SAINT (680-754), the apostle of Germany, whose real name was Wynfrith, was born of a good Saxon family at Crediton or Kirton in Devonshire. While still young he became a monk, and studied grammar and theology first at Exeter, then at Nottell near Winchester, under the abbot Winberht. He soon distinguished himself both as scholar and preacher, and had every inducement to remain in his monastery, but in 716 he followed the example of other Saxon monks and set out as missionary to Frisia. He was soon obliged to return, however, probably owing to the hostility of Radbod, king of the Frisians, then at war with Charles Martel. At the end of 717 he went to Rome, where in 719 Pope Gregory II. commissioned him to evangelize Germany and to counteract the influence of the Irish monks there. Crossing the Alps, Boniface visited Bavaria and Thuringia, but upon hearing of the death of Radbod he hurried again to Frisia, where, under the direction of his countryman Willibrord (d. 738), the first bishop of Utrecht, he preached successfully for three years. About 722 he visited Hesse and Thuringia, won over some chieftains, and converted and baptized great numbers of the heathen. Having sent special word to Gregory of his success, he was summoned to Rome and consecrated bishop on the 30th of November 722, after taking an oath of obedience to the pope. Then his mission was enlarged. He returned with letters of recommendation to Charles Martel, charged not only to convert the heathen but to suppress heresy as well.

Charles's protection, as he himself confessed, made possible his great career. Armed with it he passed safely into heathen Germany and began a systematic crusade, baptizing, overturning idols, founding churches and monasteries, and calling from England a band of missionary helpers, monks and nuns, some of whom have become famous: St Lull, his successor in the see at Mainz; St Burchard, bishop of Würzburg; St Gregory, abbot at Utrecht; Willibald, his biographer; St Lioba, St Walburge, St Thecla. In 732 Boniface was created archbishop. In 738 for the third time he went to Rome. On his return he organized the church in Bavaria into the four bishoprics of Regensburg, Freising, Salzburg and Passau. Then his power was extended still further. In 741 Pope Zacharias made him legate, and charged him with the reformation of the whole Frankish church. With the support of Carloman and Pippin, who had just succeeded Charles Martel as mayors of the palace, Boniface set to work. As he had done in Bavaria, he organized the east Frankish church into four bishoprics, Erfurt, Würzburg, Buraburg and Eichstädt, and set over them his own monks. In 742 he presided at what is generally counted as the first German council. At the same period he founded the abbey of Fulda, as a centre for German monastic culture, placing it under the Bavarian Sturm, whose biography gives us so many picturesque glimpses of the time, and making its rule stricter than the Benedictine. Then came a theological and disciplinary controversy with Virgil, the Irish bishop of Salzburg, who held, among other heresies, that there were other worlds than ours. Virgil must have been a most remarkable man; in spite of his leanings toward science he held his own against Boniface, and was canonized after his death. Boniface was more successful in France. There a certain Adalbert or Aldebert, a Frankish bishop of Neustria, had caused great disturbance. He had been performing miracles, and claimed to have received his relics, not from Rome like those of Boniface, but directly from the angels. Planting crosses in the open fields he drew the people to desert the churches, and had won a great following throughout all Neustria. Opinions are divided as to whether he was a Culdee, a representative of a national Frankish movement, or simply the charlatan that Boniface paints him. At the instance of Pippin, Boniface secured Adalbert's condemnation at the synod of Soissons in 744; but he, and Clement, a Scottish missionary and a heretic on predestination, continued to find followers in spite of legate, council and pope, for three or four years more.

Between 746 and 748 Boniface was made bishop of Mainz, and became metropolitan over the Rhine bishoprics and Utrecht, as well as over those he had established in Germany—thus founding the pre-eminence of the see of Mainz. In 747 a synod of the Frankish bishops sent to Rome a formal statement of their submission to the papal authority. The significance of this act can only be realized when one recalls the tendencies toward the formation of national churches, which had been so powerful under the Merovingians. Boniface does not seem to have taken part in the anointing of Pippin as king of the Franks in 752. In 754 he resigned his archbishopric in favour of Lull, and took up again his earliest plan of a mission to Frisia; but on the 5th of June 754 he and his companions were massacred by the heathen near Dookum. His remains were afterwards taken to Fulda.

St Boniface has well been called the proconsul of the papacy. His organizing genius, even more than his missionary zeal, left its mark upon the German church throughout all the middle ages. The missionary movement which until his day had been almost independent of control, largely carried on by schismatic Irish monks, was brought under the direction of Rome. But in so welding together the scattered centres and binding them to the papacy, Boniface seems to have been actuated by simple zeal for unity of the faith, and not by a conscious political motive.

Though pre-eminently a man of action, Boniface has left several literary remains. We have above all his Letters (*Epistolae*); difficult to date, but extremely important from the standpoint of history, dogma, or literature; see Dümmler's edition in the *Monumenta Germaniae historica*, 1891. Besides these there are a grammar (*De octo partibus orationibus*, ed. Mai, in *Classici Auctores*, t. vii.), some sermons of contested authenticity, some poems (*Aenigmata*, ed. Dümmler, *Poetae latini aevi Carolini*, i. 1881), a penitential, and some *Dicta Bonifacii* (ed. Nürnberger in *Theologische Quartalschrift*, Tübingen, vol. 70, 1888), the authenticity of which it is hard to prove or to refute. Migne in his *Patrologia Latina* (vol. 89) has reproduced the edition of Boniface's works by Giles (London, 1844).

There are very many monographs on Boniface and on different phases of his life (see Potthast, *Bibliotheca medii aevi*, and Ulysse Chevalier's *Bibliographie*, 2nd ed. for indications), but none that is completely satisfactory. Among recent studies are those of B. Kuhlmann, *Der heilige Bonifatius, Apostel der Deutschen* (Paderborn, 1895), and of G. Kurth, *Saint Boniface* (2nd ed., 1902). W. Levison has edited the *Vitae sancti Bonifacii* (Hanover, 1905). (J. T. S.)

BONIFACE (*Bonifacius*), the name of nine of the popes.

BONIFACE I., bishop of Rome from 418 to 422. At the death of Pope Zosimus, the Roman clergy were divided into two factions, one of which elected the deacon Eulalius, and the other the priest Boniface. The imperial government, in the interests of public order, commanded the two competitors to leave the town, reserving the decision of the case to a council. Eulalius having broken his ban, the emperor Honorius decided to recognize Boniface, and the council was countermanded. But the faction of Eulalius long continued to foment disorders, and the secular authority was compelled to intervene.

BONIFACE II., pope from 530 to 532, was by birth a Goth, and owed his election to the nomination of his predecessor, Felix IV., and to the influence of the Gothic king. The Roman electors had opposed to him a priest of Alexandria called Dioscorus, who died a month after his election, and thus left the position open for him. Boniface endeavoured to nominate his own successor, thus transforming into law, or at least into custom, the proceeding by which he had benefited; but the clergy and the senate of Rome forced him to cancel this arrangement.

BONIFACE III. was pope from the 15th of February to the 12th of November 606. He obtained from Phocas recognition of the "headship of the church at Rome," which signifies, no doubt, that Phocas compelled the patriarch of Constantinople to abandon (momentarily) his claim to the title of oecumenical patriarch.

BONIFACE IV. was pope from 608 to 615. He received from the emperor Phocas the Pantheon at Rome, which was converted into a Christian church.

BONIFACE V., pope from 619 to 625, did much for the christianizing of England. Bede mentions (*Hist. Eccl.*) that he wrote encouraging letters to Mellitus, archbishop of Canterbury, and Justus, bishop of Rochester, and quotes three letters—to Justus, to Edwin, king of Northumbria, and to his wife Æthelberga. William of Malmesbury gives a letter to Justus of the year 625, in which Canterbury is constituted the metropolitan see of Britain for ever.

BONIFACE VI. was elected pope in April 896, and died fifteen days afterwards.

BONIFACE VII. was pope from August 984 to July 985. His family name was Franco. In 974 he was substituted by Crescentius and the Roman barons for Benedict VI., who had been assassinated. He was ejected by Count Sicco, the representative of the emperor Otto II., and fled to Constantinople. On the death of Otto (983) he returned, seized Pope John XIV., threw him into prison, and installed himself in his place. (L. D. *)

BONIFACE VIII. (Benedetto Gaetano), pope from 1294 to 1303, was born of noble family at Anagni, studied canon and civil law in Italy and possibly at Paris. After being appointed to canonicates at Todi (June 1260) and in France, he became an advocate and then a notary at the papal court. With Cardinal Ottoboni, who was to aid the English king, Henry III., against the bishops of the baronial party, he was besieged in the Tower of London by the rebellious earl of Gloucester, but was rescued by the future Edward I., on the 27th of April 1267. Created cardinal deacon in 1281, and in 1291 cardinal priest (SS. Sylvester et Martini), he was entrusted with many diplomatic missions and became very influential in the Sacred College. He helped the ineffective Celestine V. to abdicate, and was himself chosen pope at Naples on the 24th of December 1294.

Contrary to custom, the election was not made unanimous, probably because of the hostility of certain French cardinals. Celestine attempted to rule in extreme monastic poverty and humility; not so Boniface, who ardently asserted the lordship of the papacy over all the kingdoms of the world. He was crowned at Rome in January 1295 with great pomp. He planned to pacify the West and then recover the Holy Land from the infidel; but during his nine years' reign, so far from being a peacemaker, he involved the papacy itself in a series of controversies with leading European powers. Avarice, lofty claims and frequent exhibitions of arrogance made him many foes. The policy of supporting the interests of the house of Anjou in Sicily proved a grand failure. The attempt to build up great estates for his family made most of the Colonna his enemies. Until 1303 he refused to recognize Albert of Austria as the rightful German king. Assuming that he was overlord of Hungary, he declared that its crown should fall to the house of Anjou. He humbled Eric VI. of Denmark, but was unsuccessful in the attempt to try Edward I., the conqueror of Scotland, on the charge of interfering with a papal fief; for parliament declared in 1301 that Scotland had never been a fief of Rome. The most noted conflict of Boniface was that with Philip IV. of France. In 1296, by the bull *Clericis laicos*, the pope forbade the levying of taxes, however disguised, on the clergy without his consent. Forced to recede from this position, Boniface canonized Louis IX. (1297). The hostilities were later renewed; in 1302 Boniface himself drafted and published the indubitably genuine bull *Unam sanctam*, one of the strongest official statements of the papal prerogative ever made. The weight of opinion now tends to deny that any part of this much-discussed document save the last sentence bears the marks of an infallible utterance. The French vice-chancellor Guillaume de Nogaret was sent to arrest the pope, against whom grave charges had been brought, and bring him to France to be deposed by an oecumenical council. The accusation of heresy has usually been dismissed as a slander; but recent investigations make it probable, though not quite certain, that Boniface privately held certain Averroist tenets, such as the denial of the immortality of the soul. With Sciarra Colonna, Nogaret surprised Boniface at Anagni, on the 7th of September 1303, as the latter was about to pronounce the sentence of excommunication

against the king. After a nine-hours' truce the palace was stormed, and Boniface was found lying in his bed, a cross clasped to his breast; that he was sitting in full regalia on the papal throne is a legend. Nogaret claimed that he saved the pope's life from the vengeful Colonna. Threatened, but not maltreated, the pope had remained three days under arrest when the citizens of Anagni freed him. He was conducted to Rome, only to be confined in the Vatican by the Orsini. He died on the 11th or 12th of October 1303, not eighty-six years old, as has commonly been believed, but perhaps under seventy, at all events not over seventy-five. "He shall come in like a fox, reign like a lion, die like a dog," is a gibc wrongly held to be a prophecy of his unfortunate predecessor. Dante, who had become embittered against Boniface while on a political mission in Rome, calls him the "Prince of the new Pharisees" (*Inferno*, 27, 85), and laments that "in his Vicar Christ was made a captive," and was "docked a second time" (*Purgatory*, 20, 87 f.).

AUTHORITIES.—Digard, Faucon and Thomas, *Les Registres de Boniface VIII.* (Paris, 1884, ff.); Wetzer and Welte, *Kirchenlexikon*, vol. ii. (2nd ed., Freiburg, 1883), 1037-1062; Herzog-Hauck, *Realencyclopädie*, vol. iii. (3rd ed., Leipzig, 1897), 291-300, contains an elaborate bibliography; J. Loewerth, *Geschichte des späteren Mittelalters* (Munich, 1903), 206-232; H. Finke, *Aus den Tagen Bonifaz VIII.* (Münster, 1902) is dreary but epoch-making; *Göttische gelehrte Anzeigen*, Jahrgang 166, 857-869 (Berlin, 1904); R. Scholz, *Die Publizistik zur Zeit Philipps des Schönen und Bonifaz VIII.* (Stuttgart, 1903); K. Wenck, "War Bonifaz VIII. ein Ketzer?" in von Sybel's *Historische Zeitschrift*, vol. xciv. (Munich, 1903), 1-66. Special literature on *Unam Sanctam*: C. Mirbt, *Quellen zur Geschichte des Papsttums* (2nd ed., Tübingen, 1901), 148 f.; *Kirchenlexikon*, xii. (1901), 229-240, an exhaustive discussion; H. Finke, 146-190; J. H. Robinson, *Readings in European History*, vol. I. (Boston, 1904), 346 ff. On *Clericis laicos*: Gee and Hardy, *Documents Illustrative of English Church History* (London, 1896), 87 ff. (W. W. R. *)

BONIFACE IX. (Piero Tomacelli), pope from 1389 to 1404, was born at Naples of a poor but ancient family. Created cardinal by Urban VI., he was elected successor to the latter on the 2nd of November 1389. In 1391 he canonized Birgitta of Sweden. He was able to restore Roman authority in the major part of the papal states, and in 1398 put an end to the republican liberties of the city itself. Boniface won Naples, which had owed spiritual allegiance to the antipopes Clement VII. and Benedict XIII. of Avignon, to the Roman obedience. In 1403 he ventured at last to confirm the deposition of the emperor Wenceslaus and the election of Rupert. Negotiations for the healing of the Great Schism were without result. In spite of his inferior education, the contemporaries of Boniface trusted his prudence and moral character; yet when in financial straits he sold offices, and in 1399 transformed the annates into a permanent tax. In 1390 he celebrated the regular jubilee, but a rather informal one held in 1400 proved more profitable. Though probably not personally avaricious, he was justly accused of nepotism. He died on the 1st of October 1404, being still under sixty years of age. (W. W. R. *)

BONIFACE OF SAVOY (d. 1270), archbishop of Canterbury, became primate in 1243, through the favour of Henry III., of whose queen, Eleanor of Provence, he was an uncle. Boniface, though a man of violent temper and too often absent from his see, showed some sympathy with the reforming party in the English church. Though in 1250 he provoked the English bishops by claiming the right of visitation in their dioceses, he took the lead at the council of Merton (1258) in vindicating the privileges of his order. In the barons' war he took the royalist side, but did not distinguish himself by great activity.

See Matthew Paris, *Chronica Majora*; François Mugnier, *Les Savoisyards en Angleterre* (Chambéry, 1890).

BONIFACIO, a maritime town at the southern extremity of Corsica, in the arrondissement of Sartène, 87 m. S.S.E. of Ajaccio by road. Pop. (1906) 2940. Bonifacio, which overlooks the straits of that name separating Corsica from Sardinia, occupies a remarkable situation on the summit of a peninsula of white calcareous rock, extending parallel to the coast and enclosing a narrow and secure harbour. Below the town and in the cliffs facing it the rock is hollowed into caverns accessible only by boat.

St Dominic, a church built in the 13th century by the Templars, and the cathedral of Santa Maria Maggiore which belongs mainly to the 12th century, are the chief buildings. The fortifications and citadel date from the 16th and 17th centuries. A massive medieval tower serves as a powder-magazine. The trade of Bonifacio, which is carried on chiefly with Sardinia, is in cereals, wine, cork and olive-oil of fine quality. Cork-cutting, tobacco-manufacture and coral-fishing are carried on. The olive is largely cultivated in the neighbourhood and there are oil-works in the town.

Bonifacio was founded about 828 by the Tuscan marquis whose name it bears, as a defence against the Saracen pirates. At the end of the 11th century it became subject to Pisa, and at the end of the 12th was taken and colonized by the Genoese, whose influence may be traced in the character of the population. In 1420 it heroically withstood a protracted siege by Alphonso V. of Aragon. In 1554 it fell into the hands of the Franco-Turkish army.

BONIFACIUS (d. 432), the Roman governor of the province of Africa who is generally believed to have invited the Vandals into that province in revenge for the hostile action of Placidia, ruling in behalf of her son the emperor Valentinian III. (428-429). That action is by Procopius attributed to his rival Aëtius, but the earliest authorities speak of a certain Felix, chief minister of Placidia, as the calumniator of Bonifacius. Whether he really invited the Vandals or not, there is no doubt that he soon turned against them and bravely defended the city of Hippo from their attacks. In 432 he returned to Italy, was received into favour by Placidia, and appointed master of the soldiery. Aëtius, however, resented his promotion, the two rivals met, perhaps in single combat, and Bonifacius, though victorious, received a wound from the effects of which he died three months later.

The authorities for the extremely obscure and difficult history of these transactions are well discussed by E. A. Freeman in an article in the *English Historical Review*, July 1887, to which the reader is referred. But compare also Gibbon, *Decline and Fall of the Roman Empire*, vol. iii. pp. 505-506, edited by J. B. Bury (London, 1897).

BONIN ISLANDS, called by the Japanese OGASAWARA-JIMA, a chain of small islands belonging to Japan, stretching nearly due north and south, a little east of 142° E., and from 26° 35' to 27° 45' N., about 500 m. from the mainland of Japan. They number twenty, according to Japanese investigations, and have a coast-line of 174.65 m. and a superficies of 28.82 sq. m. Only ten of them have any appreciable size, and these are named—commencing from the north—Muko-shima (Bridegroom Island), Nakadachi-shima (Go-between Island¹), Yome-shima (Bride Island), Ototo-jima (Younger-brother Island), Ani-shima (Elder-brother Island), Chichi-jima (Father Island), Haha-jima (Mother Island), Mei-jima (Niece Island), Ani-jima (Elder-sister Island) and Imoto-jima (Younger-sister Island). European geographers have been accustomed to divide the islands into three groups for purposes of nomenclature, calling the northern group the Parry Islands, the central the Beechey Islands and the southern the Coffin or Bailey Islands. The second largest of all, Chichi-jima, in Japanese cartography was called Peel Island in 1827 by Captain Beechey, and the same officer gave the name of Stapleton Island to the Ototo-jima of the Japanese, and that of Buckland Island to their Ani-jima. To complete this account of Captain Beechey's nomenclature, it may be added that he called a large bay on the south of Peel Island Fitton Bay, and a bay on the south-west of Buckland Island Walker Bay.² Port Lloyd, the chief anchorage (situated on Peel Island), is considered by Commodore Perry—who visited the islands in 1853 and strongly urged the establishment of a United States coaling station there—to have been formerly the crater of a volcano from which the surrounding hills were thrown up, the entrance to the harbour being a fissure through which lava used to pour into the sea. The islands are, indeed, plainly volcanic in their nature.

History.—The diversity of nomenclature indicated above

¹ Referring to the Japanese custom of employing a go-between to arrange a marriage.

² These details are taken from *The Bonin Islands* by Russell Robertson, formerly H.B.M. consul in Yokohama, who visited the islands in 1875.

suggests that the ownership of the islands was for some time doubtful. According to Japanese annals they were discovered towards the close of the 16th century, and added to the fief of a Daimyo, Ogasawa Sadayori, whence the name Ogasawara-jima. They were also called *Bunin-jima* (corrupted by foreigners into Bonin) because of their being without (*bu*) inhabitants (*jin*). Effective occupation did not take place, however, and communications with the islands ceased altogether in 1635, as was a natural consequence of the Japanese government's veto against the construction of sea-going vessels. In 1728 fitful communication was restored by the then representative of the Ogasawara family, only to be again interrupted until 1861, when an unsuccessful attempt was made to establish a Japanese colony at Port Lloyd. Meanwhile, Captain Beechey visited the islands in the "Blossom," assigned names to some of them, and published a description of their features. Next a small party consisting of two British subjects, two American citizens, and a Dane, sailed from the Sandwich Islands for Port Lloyd in 1830, taking with them some Hawaiian natives. These colonists hoisted the British flag on Peel Island (Chichi-jima), and settled there. When Commodore Perry arrived in 1853, there were on Peel Island thirty-one inhabitants, four being English, four American, one Portuguese and the rest natives of the Sandwich Islands, the Ladrões, &c.; and when Mr Russell Robertson visited the place in 1875, the colony had grown to sixty-nine, of whom only five were pure whites. Mr Robertson found them without education, without religion, without laws and without any system of government, but living comfortably on clearings of cultivated land. English was the language of the settlers, and they regarded themselves as a British colony. But in 1861 the British government renounced all claim to the islands in recognition of Japan's right of possession. There is now regular steam communication; the affairs of the islands are duly administered, and the population has grown to about 4500. There are no mountains of any considerable height in the Ogasawara Islands, but the scenery is hilly with occasional bold crags. The vegetation is almost tropically luxuriant—palms, wild pineapples, and ferns growing profusely, and the valleys being filled with wild beans and patches of taro. Mr Robertson catalogues a number of valuable timbers that are obtained there, among them being Tremana, cedar, rose-wood, iron-wood (red and white), box-wood, sandal and white oak. The kekop tree, the orange, the laurel, the juniper, the wild cactus, the curry plant, wild sage and celery flourish. No minerals have been discovered. The shores are covered with coral; earthquakes and tidal waves are frequent, the latter not taking the form of bores, but of a sudden steady rise and equally sudden fall in the level of the sea; the climate is rather tropical than temperate, but sickness is almost unknown among the residents. (F. B. V.)

BONITZ, HERMANN (1814-1888), German scholar, was born at Langensalza in Saxony on the 20th of July 1814. Having studied at Leipzig under G. Hermann and at Berlin under Böckh and Lachmann, he became successively teacher at the Blochmann institute in Dresden (1836), Oberlehrer at the Friedrich-Wilhelms gymnasium (1838) and the Graues Kloster (1840) in Berlin, professor at the gymnasium at Stettin (1842), professor at the university of Vienna (1849), member of the imperial academy (1854), member of the council of education (1864), and director of the Graues Kloster gymnasium (1867). He retired in 1888, and died on the 25th of July in that year at Berlin. He took great interest in higher education, and was chiefly responsible for the system of teaching and examination in use in the high schools of Prussia after 1882. But it is as a commentator on Plato and Aristotle that he is best known outside Germany. His most important works in this connexion are: *Disputationes Platonicae Duae* (1837); *Platonische Studien* (3rd ed., 1886); *Observationes Criticae in Aristotelis Libros Metaphysicos* (1842); *Observationes Criticae in Aristotelis quae feruntur Magna Moralia et Ethica Eudemia* (1844); *Alexandri Aphrodisiensis Commentarius in Libros Metaphysicos Aristotelis* (1847); *Aristotelis Metaphysica* (1848-1849); *Über die Kategorien des A.* (1853); *Aristotelische Studien* (1862-1867); *Index*

Aristodocus (1870). Other works: *Über den Ursprung der homerischen Gedichte* (5th ed., 1881); *Beiträge zur Erklärung des Thukydides* (1854), *des Sophokles* (1856-1857). He also wrote largely on classical and educational subjects, mainly for the *Zeitschrift für die österreichischen Gymnasien*.

A full list of his writings is given in the obituary notice by T. Comper in the *Biographisches Jahrbuch für Altertumskunde* (1890).

BONIVARD, FRANÇOIS (1493-1570), the hero of Byron's poem, *The Prisoner of Chillon*, was born at Seyssel of an old Savoyard family. Bonivard has been described as "a man of the Renaissance who had strayed into the age of the Reformation." His real character and history are, however, widely different from the legendary account which was popularized by Byron. In 1510 he succeeded his uncle, who had educated him, as prior of the Cluniac priory of St Victor, close to Geneva. He naturally, therefore, opposed the attempts of the duke of Savoy, aided by his relative, the bishop of the city, to maintain his rights as lord of Geneva. He was imprisoned by the duke at Gev from 1519 to 1521, lost his priory, and became more and more anti-Savoyard. In 1530 he was again seized by the duke and imprisoned for four years underground, in the castle of Chillon, till he was released in 1536 by the Bernese, who then wrested Vaud from the duke. He had been imprisoned for political reasons, for he did not become a Protestant till after his release, and then found that his priory had been destroyed in 1534. He obtained a pension from Geneva, and was four times married, but owing to his extravagances was always in debt. He was officially entrusted in 1542 with the task of compiling a history of Geneva from the earliest times. In 1551 his MS. of the *Chroniques de Genève* (ending in 1530) was submitted to Calvin for correction, but it was not published till 1831. The best edition is that of 1867. The work is uncritical and partial, but is his best title to fame.

BONN, a town of Germany, in the Prussian Rhine province, on the left bank of the Rhine, 15 m. S. by E. from Cologne, on the main line of railway to Mainz, and at the junction of the lines to the Eifel and (by ferry) to the right bank of the Rhine. Pop. (1885) 35,989; (1905) 81,997. The river is here crossed by a fine bridge (1806-1808), 1417 ft. in length, flanked by an embankment 2 m. long, above and parallel with which is the Coblenzer-strasse, with beautiful villas and pretty gardens reaching down to the Rhine. The central part of the town is composed of narrow streets, but the outskirts contain numerous fine buildings, and the appearance of the town from the river is attractive. There are six Roman Catholic and two Protestant churches, the most important of which is the Münster (minster), an imposing edifice of grey stone, in the Romanesque and Transition styles, surmounted by five towers, of which the central, rising to a height of 315 ft., is a landmark in the Rhine valley. The church dates from the 11th, 12th and 13th centuries, was restored in 1875 and following years and in 1890-1894 was adorned with paintings. Among other churches are the Stiftskirche (monastic church), rebuilt 1879-1884; the Jesuitenkirche (1693); the Minoritenkirche (1278-1318), the Herz Jesu-kirche (1862) and the Marienkirche (1892). There is also a synagogue, and the university chapel serves as an English church. The town also possesses a town hall situate on the market square and dating from 1737, a fine block of law-court buildings, several high-grade schools and a theatre.

By far the finest of the buildings, however, is the famous university, which occupies the larger part of the southern frontage of the town. The present establishment only dates from 1818, and owes its existence to King Frederick William III. of Prussia; but as early as 1786 the academy which had been founded about nine years before was raised by Archbishop Maximilian Frederick of Cologne to the rank of a university, and continued to exercise its functions till 1794, when it was dissolved by the last elector. The building now occupied by the university was originally the electoral palace, constructed about 1717 out of the materials of the old fortifications. It was remodelled after the town came into Prussian possession. There are five faculties in the university—a legal, a medical, and a

philosophic, and one of Roman Catholic and another Protestant theology. The library numbers upwards of 230,000 volumes; and the antiquarian museum contains a valuable collection of Roman relics discovered in the neighbourhood. Connected with the university are also physiological, pathological and chemical institutes, five clinical departments and a laboratory. An academy of agriculture, with a natural history museum and botanic garden attached, is established in the palace of Clemens-rube at Poppelsdorf, which is reached by a fine avenue about a mile long, bordered on both sides by a double row of chestnut trees. A splendid observatory, long under the charge of Friedrich Wilhelm Argelander, stands on the south side of the road. The Roman Catholic archiepiscopal theological college, beautifully situated on an eminence overlooking the Rhine, dates from 1892.

Beethoven was born in Bonn, and a statue was erected to him in the Münster-platz in 1845. B. G. Niebuhr is buried in the cemetery outside of the Stertor, where a monument was placed to his memory by Frederick William IV. Here are also the tombs of A. W. von Schlegel, the diplomatist Christian Karl von Bunsen, Robert Schumann, Karl Simrock, E. M. Arndt and Schiller's wife. The town is adorned with a marble monument commemorating the war of 1870-71, a handsome fountain, and a statue of the Old Catholic bishop Reinkens. In 1889 a museum of Beethoven relics was opened in the house in which the composer was born. There are further a municipal museum, arranged in a private house since 1882, an academic art museum (1884), with some classic originals, a creation of F. G. Welcker, and the provincial museum, standing near the railway station, which contains a collection of medieval stone monuments and works of art, besides a small picture gallery.

One of the most conspicuous features of Bonn, viewed from the river, is the pilgrimage (monastic) church of Kreuzberg (1627), behind and above Poppelsdorf; it has a flight of 28 steps, which pilgrims used to ascend on their knees. "Der alte Zoll," commanding a magnificent view of the Siebengebirge, is the only remaining bulwark of the old fortifications, the Stertor having been removed in order to open up better communication with the rapidly increasing western suburbs and the terminus of the light railway to Cologne.

But for its university Bonn would be a place of comparatively little importance, its trade and commerce being of moderate dimensions. Its principal industries are jute spinning and weaving, and the manufacture of porcelain, flags, machinery and beer, and it has some trade in wine. There are considerable numbers of foreign residents, notably English, attracted by the natural beauty of the place and by the educational facilities it affords.

Bonn (*Bonna* or *Castra Bonnaensia*), originally a town of the Ubii, became at an early period the site of a Roman military settlement, and as such is frequently mentioned by Tacitus. It was the scene, in A.D. 70, of a battle in which the Romans were defeated by Claudius Civilis, the valiant leader of the Batavians. Greatly reduced by successive barbarian incursions it was restored about 359 by the emperor Julian. In the centuries that followed the break-up of the Roman empire it again suffered much from barbarian attacks, and was finally devastated in 889 by bands of Norse raiders who had sailed up the Rhine. It was again fortified by Konrad von Hochstaden, archbishop of Cologne (1238-1261), whose successor, Engelbert von Falkenburg (d. 1274), driven out of his cathedral city by the townspeople, established himself here (1265); from which time until 1794 it remained the residence of the electors of Cologne. During the various wars that devastated Germany in the 16th, 17th and 18th centuries, the town was frequently besieged and occupied by the several belligerents, but continued to belong to the electors till 1794, when the French took possession of it. At the peace of Lunéville they were formally recognized in their occupation; but in 1815 the town was made over by the congress of Vienna to Prussia. The fortifications had been dismantled in 1717.

See F. Ritter, *Entstehung der drei ältesten Städte am Rhein: Köln, Bonn und Mainz* (Bonn, 1851); H. von Sybel, *Die Gründung der Universität Bonn* (1868); and *Führer von Hesse* (10th ed., 1901).

BONNAT, LÉON JOSEPH FLORENTIN (1833-), French painter, was born at Bayonne on the 20th of June 1833. He was educated in Spain, under Madrazo at Madrid, and his long series of portraits shows the influence of Velasquez and the Spanish realists. In 1869 he won a medal of honour at Paris, where he became one of the leading artists of his day, and in 1888 he became professor of painting at the Ecole des Beaux Arts. In May 1905 he succeeded Paul Dubois as director. His vivid portrait-painting is his most characteristic work, but his subject pictures, such as the "Martyrdom of St Denis" in the Panthéon, are also famous.

BONNE-CARRÈRE, GUILLAUME DE (1754-1825), French diplomatist, was born at Muret in Languedoc on the 13th of February 1754. He began his career in the army, but soon entered the diplomatic service under Vergennes. A friend of Mirabeau and of Dumouriez, he became very active at the Revolution, and Dumouriez re-established for him the title of director-general of the department of foreign affairs (March 1792). He remained at the ministry, preserving the habits of the diplomacy of the old régime, until December 1792, when he was sent to Belgium as agent of the republic, but he was involved in the treason of Dumouriez and was arrested on the 2nd of April 1793. To justify himself, he published an account of his conduct from the beginning of the Revolution. He was freed from prison in July 1794. Napoleon did not trust him, and gave him only some unimportant missions. After 1815 Bonne-Carrère retired into private life, directing a profitable business in public carriages between Paris and Versailles.

BONNER, EDMUND (1507-1569), bishop of London, was perhaps the natural son of George Savage, rector of Davenham, Cheshire, by Elizabeth Frodsham, who was afterwards married to Edmund Bonner, a sawyer of Hanley in Worcestershire. This account, which was printed with many circumstantial details by Strype (*Eccles. Mem.* III. i. 172-173), was disputed by Strype's contemporary, Sir Edmund Lechmere, who asserted on not very satisfactory evidence (*ib. Annals*, I. ii. 300) that Bonner was of legitimate birth. He was educated at Broadgates Hall, now Pembroke College, Oxford, graduating bachelor of civil and canon law in June 1519. He was ordained about the same time, and admitted D.C.L. in 1525. In 1529 he was Wolsey's chaplain, and he was with the cardinal at Cawood at the time of his arrest. Subsequently he was transferred, perhaps through Cromwell's influence, to the service of the king, and in January 1532 he was sent to Rome to obstruct the judicial proceedings against Henry in the papal curia. In October 1533 he was entrusted with the unmannerly task of intimating to Clement VII., while he was the guest of Francis I. at Marseilles, Henry's appeal from the pope to a general council; but there seems to be no good authority for Burnet's story that Clement threatened to have him burnt alive. For these and other services Bonner had been rewarded by the grant of several livings, and in 1535 he was made archdeacon of Leicester.

Towards the end of that year he was sent to further what he called "the cause of the Gospel" (*Letters and Papers*, 1536, No. 469) in North Germany; and in 1536 he wrote a preface to Gardiner's *De vera Obedientia*, which asserted the royal, denied the papal, supremacy, and was received with delight by the Lutherans. After a brief embassy to the emperor in the spring of 1538, Bonner superseded Gardiner at Paris, and began his mission by sending Cromwell a long list of accusations against his predecessor (*ib.* 1538, ii. 144). He was almost as bitter against Wyatt and Mason, whom he denounced as a "papist," and the violence of his conduct led Francis I. to threaten him with a hundred strokes of the halberd. He seems, however, to have pleased his patron, Cromwell, and perhaps Henry, by his energy in seeing the king's "Great" Bible in English through the press in Paris. He was already king's chaplain; his appointment at Paris had been accompanied by promotion to the see of Hereford, and before he returned to take possession he was translated to the bishopric of London (October 1539).

Hitherto Bonner had been known as a somewhat coarse and unscrupulous tool of Cromwell, a sort of ecclesiastical Wrothley.

He is not known to have protested against any of the changes effected by his masters; he professed to be no theologian, and was wont, when asked theological questions, to refer his interrogators to the divines. He had graduated in law, and not in theology. There was nothing in the Reformation to appeal to him, except the repudiation of papal control; and he was one of those numerous Englishmen whose views were faithfully reflected in the Six Articles. He became a staunch Conservative, and, apart from his embassy to the emperor in 1524-1543, was mainly occupied during the last years of Henry's reign in brandishing the "whip with six strings."

The accession of Edward VI. opened a fresh and more creditable chapter in Bonner's career. Like Gardiner, he could hardly repudiate that royal supremacy, in the establishment of which he had been so active an agent; but he began to doubt that supremacy when he saw to what uses it could be put by a Protestant council, and either he or Gardiner evolved the theory that the royal supremacy was in abeyance during a royal minority. The ground was skilfully chosen, but it was not legally nor constitutionally tenable. Both he and Gardiner had in fact sought fresh licences to exercise their ecclesiastical jurisdiction from the young king; and, if he was supreme enough to confer jurisdiction, he was supreme enough to issue the injunctions and order the visitation to which Bonner objected. Moreover, if a minority involved an abeyance of the royal supremacy in the ecclesiastical sphere, it must do the same in the temporal sphere, and there could be nothing but anarchy. It was on this question that Bonner came into conflict with Edward's government. He resisted the visitation of August 1547, and was committed to the Fleet; but he withdrew his opposition, and was released in time to take an active part against the government in the parliament of November 1547. In the next session, November 1548-March 1549, he was a leading opponent of the first Act of Uniformity and Book of Common Prayer. When these became law, he neglected to enforce them, and on the 1st of September 1549 he was required by the council to maintain at St Paul's Cross that the royal authority was as great as if the king were forty years of age. He failed to comply, and after a seven days' trial he was deprived of his bishopric by an ecclesiastical court over which Cranmer presided, and was sent to the Marshalsea. The fall of Somerset in the following month raised Bonner's hopes, and he appealed from Cranmer to the council. After a struggle the Protestant faction gained the upper hand, and on the 7th of February 1550 Bonner's deprivation was confirmed by the council sitting in the Star Chamber, and he was further condemned to perpetual imprisonment.

He was released by Mary's accession, and was at once restored to his see, his deprivation being regarded as invalid and Ridley as an intruder. He vigorously restored Roman Catholicism in his diocese, made no difficulty about submitting to the papal jurisdiction which he had sworn, and in 1555 began the persecution to which he owes his fame. His apologists explain that his action was merely "official," but Bonner was one of those who brought it to pass that the condemnation of heretics to the fire should be part of his ordinary official duties. The enforcement of the first Book of Common Prayer had also been part of his official duties; and the fact that Bonner made no such protest against the burning of heretics as he had done in the former case shows that he found it the more congenial duty. Tunstal was as good a Catholic as Bonner; he left a different repute behind him, a clear enough indication of a difference in their deeds.

On the other hand, Bonner did not go out of his way to persecute; many of his victims were forced upon him by the council, which sometimes thought that he had not been severe enough (see *Acts of the P.C. 1554-1556*, pp. 115, 139; *1556-1558*, pp. 18, 19, 216, 276). So completely had the state dominated the church that religious persecutions had become state persecutions, and Bonner was acting as an ecclesiastical sheriff in the most refractory district of the realm. Even Foxe records instances in which Bonner failed to persecute. But he had

no mercy for a fallen foe; and he is seen at his worst in his brutal jeers at Cranmer, when he was entrusted with the duty of degrading his former chief. It is a more remarkable fact that, in spite of his prominence, neither Henry VIII. nor Mary should ever have admitted him to the privy council. He seems to have been regarded by his own party as a useful instrument, especially in disagreeable work, rather than as a desirable colleague.

On her accession Elizabeth refused to allow him to kiss her hand; but he sat and voted in the parliament and convocation of 1559. In May he refused to take the oath of supremacy, acquiring like his colleagues consistency with old age. He was sent to the Marshalsea, and a few years later was indicted on a charge of *præmunire* on refusing the oath when tendered him by his diocesan, Bishop Horne of Winchester. He challenged the legality of Horne's consecration, and a special act of parliament was passed to meet the point, while the charge against Bonner was withdrawn. He died in the Marshalsea on the 5th of September 1569, and was buried in St George's, Southwark, at midnight to avoid the risk of a hostile demonstration.

See *Letters and Papers of Henry VIII.* vols. iv. xx.; *Acts of the Privy Council (1542-1569)*; *Lords' Journals*, vol. i.; *Wilkins' Councils*; *Foxe's Acts and Monuments*, ed. Townsend; *Burnet*, ed. Pocock; *Scrype's Works*; *Gough's Index to Parker Soc. Publ.*; *S. R. Maitland's Essays on the Ref.*; *Froude's* and *R. W. Dixon's Histories*; *Pollard's Cromwell and England under Somerset*; other authorities cited in *Dict. Nat. Biogr.* (A. F. F.)

BONNET, CHARLES (1720-1793), Swiss naturalist and philosophical writer, was born at Geneva on the 13th of March 1720, of a French family driven into Switzerland by the religious persecution in the 16th century. He made law his profession, but his favourite pursuit was the study of natural science. The account of the ant-lion in N. A. Pluche's *Spectacle de la nature*, which he read in his sixteenth year, turned his attention to insect life. He procured R. A. F. de Réaumur's work on insects, and with the help of live specimens succeeded in adding many observations to those of Réaumur and Pluche. In 1740 Bonnet communicated to the academy of sciences a paper containing a series of experiments establishing what is now termed parthenogenesis in aphides or tree-lice, which obtained for him the honour of being admitted a corresponding member of the academy. In 1741 he began to study reproduction by fission and the regeneration of lost parts in the freshwater hydra and other animals; and in the following year he discovered that the respiration of caterpillars and butterflies is performed by pores, to which the name of *stigmata* has since been given. In 1743 he was admitted a fellow of the Royal Society; and in the same year he became a doctor of laws—his last act in connexion with a profession which had ever been distasteful to him.

His first published work appeared in 1745, entitled *Traité d'entomologie*, in which were collected his various discoveries regarding insects, along with a preface on the development of germs and the scale of organized beings. Botany, particularly the leaves of plants, next attracted his attention; and after several years of diligent study, rendered irksome by the increasing weakness of his eyesight, he published in 1754 one of the most original and interesting of his works, *Recherches sur l'usage des feuilles dans les plantes*; in which among other things he advances many considerations tending to show (as has quite recently been done by Francis Darwin) that plants are endowed with powers of sensation and discernment. But Bonnet's eyesight, which threatened to fail altogether, caused him to turn to philosophy. In 1754 his *Essai de psychologie* was published anonymously in London. This was followed by the *Essai asiatique sur les facultés de l'âme* (Copenhagen, 1760), in which he develops his views regarding the physiological conditions of mental activity. He returned to physical science, but to the speculative side of it, in his *Considérations sur les corps organisés* (Amsterdam, 1762), designed to refute the theory of epigenesis, and to explain and defend the doctrine of pre-existent germs. In his *Contemplation de la nature* (Amsterdam, 1764-1765; translated into Italian, German, English and Dutch), one of his

most popular and delightful works, he sets forth, in eloquent language, the theory that all the beings in nature form a gradual scale rising from lowest to highest, without any break in its continuity. His last important work was the *Palingénésie philosophique* (Geneva, 1769-1770); in it he treats of the past and future of living beings, and supports the idea of the survival of all animals, and the perfecting of their faculties in a future state.

Bonnet's life was uneventful. He seems never to have left Switzerland, nor does he appear to have taken any part in public affairs except for the period between 1752 and 1768, during which he was a member of the council of the republic. The last twenty five years of his life he spent quietly in the country, at Genthod, near Geneva, where he died after a long and painful illness on the 20th of May 1793. His wife was a lady of the family of De la Rive.

They had no children, but Madame Bonnet's nephew, the celebrated H. B. de Saussure, was brought up as their son.

Bonnet's philosophical system may be outlined as follows. Man is a compound of two distinct substances, mind and body, the one immaterial and the other material. All knowledge originates in sensations; sensations follow (whether as physical effects or merely as sequents Bonnet will not say) vibrations in the nerves appropriate to each; and lastly, the nerves are made to vibrate by external physical stimulus. A nerve once set in motion by a particular object tends to reproduce that motion; so that when it a second time receives an impression from the same object it vibrates with less resistance. The sensation accompanying this increased flexibility in the nerve is, according to Bonnet, the condition of memory. When reflection—that is, the active element in mind—is applied to the acquisition and combination of sensations, those abstract ideas are formed which, though generally distinguished from, are thus merely sensations in combination only. That which puts the mind into activity is pleasure or pain; happiness is the end of human existence. Bonnet's metaphysical theory is based on two principles borrowed from Leibnitz—first, that there are not successive acts of creation, but that the universe is completed by the single original act of the divine will, and thereafter mover on by its own inherent force; and secondly, that there is no break in the continuity of existence. The divine Being originally created a multitude of germs in a graduated scale, each with an inherent power of self-development. At every successive step in the progress of the universe, these germs, as progressively modified, advance nearer to perfection; if some advanced and others did not there would be a gap in the continuity of the chain. Thus not man only but all other forms of existence are immortal. Nor is man's mind alone immortal; his body also will pass into the higher stage, not, indeed, the body he now possesses, but a finer one of which the germ at present exists within him. It is impossible, however, to reach absolute perfection, because the distance is infinite. In this final proposition Bonnet violates his own principle of continuity, by postulating an interval between the highest created being and the Divine. It is also difficult to understand whether the constant advance to perfection is performed by each individual, or only by each race of beings as a whole. There seems, in fact, to be an oscillation between two distinct but analogous doctrines—that of the constantly increasing advancement of the individual in future stages of existence, and that of the constantly increasing advancement of the race as a whole according to the successive evolutions of the globe.

Bonnet's complete works appeared at Neuchâtel in 1779-1783, partly revised by himself. An English translation of certain portions of the *Palingénésie philosophique* was published in 1787, under the title, *Philosophical and Critical Inquiries concerning Christianity*. See also A. Lemoine, *Charles Bonnet* (Paris, 1850); the duc de Caraman, *Charles Bonnet, philosophe et naturaliste* (Paris, 1859); Max Offerer, *Die Psychologie C. B.* (Leipzig, 1893); Joh. Speck, in *Arch. f. Gesch. d. Philos.* x. (1897), xi. (1897), pp. 58 foll., xi. (1898) pp. 1-211; J. Trembley, *Vie privée et littéraire de C. B.* (Bern, 1794).

BONNET (from Lat. *bonetum*, a kind of stuff, then the cap made of this stuff), originally a soft cap or covering for the head,

the common term in English till the end of the 17th century; this sense survives in Scotland, especially as applied to the cap known as a "glengarry." The "bonnet" of a ship's sail now means an additional piece laced on to the bottom, but it seems to have formerly meant a piece laced to the top, the term "to veil the bonnet" being found at the beginning of the 16th century to mean "strike sail" (from the Fr. *avaler*), to let down. In modern times "bonnet" has come to be used of a type of head-covering for women, differentiated from "hat" by fitting closely to the head and often having no brim, but varying considerably in shape according to the period and fashion. The term, by a natural extension, is also applied to certain protective devices, as in a steam-engine or safety-lamp, or in slang use to a gambler's accomplice, a decoy.

BONNEVAL, CLAUDE ALÉXANDRE, COMTE DE (1675-1747), French adventurer, known also as **ARMED PASHA**, was the descendant of an old family of Limousin. He was born on the 14th of July 1675, and at the age of thirteen joined the Royal Marine Corps. After three years he entered the army, in which he rose to the command of a regiment. He served in the Italian campaigns under Catinat, Villeroi and Vendôme, and in the Netherlands under Luxemburg, giving proofs of indomitable courage and great military ability. His insolent bearing towards the minister of war was made matter for a court-martial (1704). He was condemned to death, but saved himself by flight to Germany. Through the influence of Prince Eugene he obtained a general's command in the Austrian army, and fought with great bravery and distinction against France, and afterwards against Turkey. He was present at Malplaquet, and was severely wounded at Peterwardein. The proceedings against him in France were then allowed to drop, and he visited Paris, and married a daughter of Marshal de Biron. He returned, however, after a short time to the Austrian army, and fought with distinction at Belgrade. He might now have risen to the highest rank, had he not made himself disagreeable to Prince Eugene, who sent him as master of the ordnance to the Low Countries. There his ungovernable temper led him into a quarrel with the marquis de Prfé, Eugene's deputy governor in the Netherlands, who answered his challenge by placing him in confinement. A court-martial was again held upon him, and he was condemned to death; but the emperor commuted the sentence to one year's imprisonment and banishment. Bonneval, soon after his release, offered his services to the Turkish government, professed the Mahomedan faith, and took the name of Ahmed. He was made a pasha, and appointed to organize and command the artillery. He rendered valuable services to the sultan in his war with Russia, and with the famous Nadir Shah. As a reward he received the governorship of Chion, but he soon fell under the suspicion of the Porte, and was banished for a time to the shores of the Black Sea. He was meditating a return to Europe and Christianity when he died at Constantinople on the 23rd of March 1747.

The *Memoirs* published under his name are spurious. See Prince de Ligne, *Mémoire sur le comte de Bonneval* (Paris, 1817); and A. Vandal, *Le Pacha Bonneval* (Paris, 1885).

BONNEVILLE, BENJAMIN L. E. (1795-1878), American military engineer and explorer, was born in France about 1795. He emigrated to the United States in early youth, and graduated at the United States Military Academy at West Point in 1815. He was engaged in the construction of military roads in the south-west, and became a captain of infantry in 1825. In 1831-1836, having obtained leave of absence from the army, he conducted, largely on his own responsibility, an exploring expedition to the Rocky Mountains, proceeding up the Platte river through parts of the later states of Colorado and Wyoming into the Great Salt Lake basin and thence into California. After being absolutely cut off from civilization for several years, and having his name struck from the army list, he returned with an interesting and valuable account of his adventures, which was edited and amplified by Washington Irving and published under the title *The Rocky Mountains: or Scenes, Incidents, and Adventures in the Far West; from the Journal of Captain Benjamin*

L. E. Bonneville of the Army of the United States (2 vols., 1837), subsequent editions bearing the title *The Adventures of Captain Bonneville, U.S.A., in the Rocky Mountains and the Far West*. Bonneville became a major in 1845, and was breveted lieutenant-colonel for gallantry in the battles of Contreras and Churubusco during the Mexican War. He became a colonel in 1855, commanded the Gila river expedition against the Apaches in 1857, and from 1858 to 1861 commanded the department of New Mexico. He was retired in 1861, but served during the Civil War as recruiting officer and commandant of barracks at St Louis, Missouri, receiving the brevet rank of brigadier-general in 1865. He died at Fort Smith, Arkansas, on the 12th of June 1878. The extinct glacial lake which once covered what is now north-western Utah has been named in his honour.

BONNEY, THOMAS GEORGE (1833-), English geologist, eldest son of the Rev. Thomas Bonney, master of the grammar school at Rugeley, was born in that town on the 27th of July 1833. Educated at Uppingham and St John's College, Cambridge, he graduated as 12th wrangler in 1856, and was ordained in the following year. From 1856 to 1861 he was mathematical master at Westminster school, and geology was pursued by him only as a recreation, mainly in Alpine regions. In 1868 he was appointed tutor at St John's College and lecturer in geology. His attention was specially directed to the study of the igneous and metamorphic rocks in Alpine regions and in various parts of England, in the Lizard, at Salcombe, in Charnwood Forest, in Wales and the Scottish Highlands. In 1877 he was chosen professor of geology in University College, London. He became secretary and afterwards president of the Geological Society (1884-1886), secretary of the British Association (1881-1885), president of the Mineralogical Society and of the Alpine Club. He was also in 1887 appointed honorary canon of Manchester. His purely scientific works are: *Cambridgeshire Geology* (1875); *The Story of our Planet* (1893); *Charles Lyell and Modern Geology* (1895); *Ice Work, Past and Present* (1896); *Volcanoes* (1899). In addition to many papers published in the *Quarterly Journal of the Geological Society* and *Geological Magazine*, he wrote several popular works on Alpine Regions, on English and Welsh scenery, as well as on theological subjects.

See *Geological Magazine* for September 1901 (with bibliography).

BONNIER, ANGE ELISABETH LOUIS ANTOINE (1749-1799), French diplomatist, was a member of the Legislative Assembly and of the Convention, where he voted with the majority. During the Directory he was charged with diplomatic missions, first to Lille and then to the congress of Rastadt (October 1797), where the negotiations dragged wearily along and were finally broken. On the 28th of April 1799 the plenipotentiaries on leaving Rastadt were assailed at the gates of the town by Hungarian hussars, probably charged to secure their papers. Bonnier and one of his colleagues, Claude Roberjot, were killed. The other, Jean Debry, was wounded.

See Huefer, *Der Rastadtergesandtenmord* (Boon, 1896).

BONNIVET, GUILLAUME GOUFFIER, SEIGNEUR DE (c. 1488-1525), French soldier, was the younger brother of Artus Gouffier, seigneur de Boisy, tutor of Francis I. of France. Bonnivet was brought up with Francis, and after the young king's accession he became one of the most powerful of the royal favourites. In 1515 he was made admiral of France. In the imperial election of 1519 he superintended the candidature of Francis, and spent vast sums of money in his efforts to secure the votes of the electors, but without success. He was the implacable enemy of the constable de Bourbon and contributed to his downfall. In command of the army of Navarre in 1521, he occupied Fuenterrabia and was probably responsible for its non-restoration and for the consequent renewal of hostilities. He succeeded Marshal Lautrec in 1523 in the command of the army of Italy and entered the Milanese, but was defeated and forced to effect a disastrous retreat, in which the chevalier Bayard perished. He was one of the principal commanders of the army which Francis led into Italy at the end of 1524, and died at the battle of Pavia on the 24th of February 1525. Brantôme says that it was at Bonnivet's suggestion that the battle

of Pravia was fought, and that, seeing the disaster he had caused, he courted and found death heroically in the fight. In spite of his failures as a general and diplomatist, his handsome face and brilliant wit enabled him to retain throughout his life the intimacy and confidence of his king. He was a man of licentious life. According to Brantôme he was the successful rival of the king for the favours of Madame de Châteaubriand, and if we may believe him to have been—as is very probable—the hero of the fourth story of the *Heptameron*, Marguerite d'Angoulême had occasion to resist his importunities.

AUTHORITIES.—Bonnivet's correspondence in the Bibliothèque Nationale, Paris; memoirs of the time; complete works of Brantôme, vol. iii., published by Ludovic Lalanne for the Société de l'Histoire de France (1864 seq.). See also Ernest Lavisse, *Histoire de France*, vol. v., by H. Lemonnier (1903-1904).

BONOMI, GIUSEPPI (1739-1808), English architect, was born at Rome on the 10th of January 1739. After attaining a considerable reputation in Italy, he came in 1767 to England, and finally settled in practice there. He was the innocent cause of the retirement of Sir Joshua Reynolds from the presidency of the Royal Academy. Sir Joshua wished him to become a full Academician, regarding him as a fitting occupant of the then vacant chair of perspective. But the majority of the Academicians were opposed to this suggestion, and Bonomi was elected an associate only, and that merely by the president's casting vote. Bonomi was largely responsible for the revival of classical architecture in England. His most famous work was the Italian villa at Roseneath, Dumbartonshire, designed for the duke of Argyll. In 1804 he was appointed honorary architect to St Peter's at Rome. He died in London on the 9th of March 1808.

His son, **GIUSEPPI BONOMI** (1796-1878), studied art in London at the Royal Academy, and became a sculptor, but is best known as an illustrator of the leading Egyptological publications of his day. From 1824 to 1832 he was in Egypt, making drawings of the monuments in the company of Burton, Lane and Wilkinson. In 1833 he visited the mosque of Omar, returning with detailed drawings, and from 1842 to 1844 was again in Egypt, attached to the Prussian government exploration expedition under Lepsius. He assisted in the arrangement of the Egyptian court at the Crystal Palace in 1853, and in 1861 was appointed curator of the Soane Museum. He died on the 3rd of March 1878.

BONONCINI (or **BUONONCINI**), **GIOVANNI BATTISTA** (1672?-1790?), Italian musical composer, was the son of the composer Giovanni Maria Bononcini, best known as the author of a treatise entitled *Il Musico Pratico* (Bologna, 1673), and brother of the composer Marc' Antonio Bononcini, with whom he has often been confused. He is said to have been born at Modena in 1672, but the date of his birth must probably be placed some ten years earlier. He was a pupil of his father and of Colonna, and produced his first operas, *Tullo Ostilio* and *Serse*, at Rome in 1694. In 1696 he was at the court of Berlin, and between 1700 and 1720 divided his time between Vienna and Italy. In 1720 he was summoned to London by the Royal Academy of Music, and produced several operas, enjoying the protection of the Marlborough family. About 1731 it was discovered that he had a few years previously palmed off a madrigal by Loti as his own work, and after a long correspondence he was obliged to leave the country. He remained for several years in France, and in 1748 was summoned to Vienna to compose music in honour of the peace of Aix-la-Chapelle. He then went to Venice as a composer of operas, and nothing more is known of his life.

Bononcini's rivalry with Handel will always ensure him immortality, but he was in himself a musician of considerable merit, and seems to have influenced the style, not only of Handel but even of Alessandro Scarlatti. Either he or his brother (our knowledge of the two composers' lives is at present not sufficient to distinguish their works clearly) was the inventor of that sharply rhythmical style conspicuous in *Il Trionfo di Camilla* (1697), the success of which at Naples probably induced Scarlatti to adopt a similar type of melody. It is noticeable in the once popular air of Bononcini, *L'esperto nocchiero*, and in the air

Vado ben spesso, long attributed to Salvator Rosa, but really by Bononcini.

BONONIA (mod. *Bologna*), the chief town of ancient Aemilia (see *ARIMILIA, VIA*), in Italy. It was said by classical writers to be of Etruscan origin, and to have been founded, under the name Felsina, from Perugia by Aencus or Ocnus. Excavations of recent years have, however, led to the discovery of some 600 ancient Italic (Ligurian?) huts, and of cemeteries of the same and the succeeding (Umbrian) periods (800-600? B.C.), of which the latter immediately preceded the Etruscan civilization (c. 600-400 B.C.). An extensive Etruscan necropolis, too, was discovered on the site of the modern cemetery (A. Zannoni, *Scavi della Certosa*, Bologna, 1876), and others in the public garden and on the Arnoaldi Velli property (*Notizie degli Scavi, indice* 1876-1900, s.s. "Bologna"). In 106 B.C., when the town first appears in history, it was already in the possession of the Boii, and had probably by this time changed its name, and in 189 B.C. it became a Roman colony. After the conquest of the mountain tribes, its importance was assured by its position on the Via Aemilia, by which it was connected in 187 B.C. with Ariminum and Placentia, and on the road, constructed in the same year, to Arretium; while another road was made, perhaps in 175 B.C., to Aquileia. It thus became the centre of the road system of north Italy. In 90 B.C. it acquired Roman citizenship. In 43 B.C. it was used as his base of operations against Decius Brutus by Mark Antony, who settled colonists here; Augustus added others later, constructing a new aqueduct from the Letta, a tributary of the Rhenus, which was restored to use in 1881 (G. Gozzadini in *Notizie degli Scavi*, 1881, 162). After a fire in A.D. 53 the emperor Claudius made a subvention of 70 million sesterces (£1,087,500). Bononia seems, in fact, to have been one of the most important cities of ancient Italy, as Bologna is of modern Italy. It was able to resist Alaric in 470 and to preserve its existence during the general ruin. It afterwards belonged to the Greek exarchate of Ravenna. Of remains of the Roman period, however, there are none above ground, though various discoveries have been made from time to time within the city walls, the modern streets corresponding more or less, as it seems, with the ancient lines. Remains of the bridge of the Via Aemilia over the Rhenus have also been found—consisting of parts of the parapets on each side, in brick-faced concrete which belong to a restoration, the original construction (probably by Augustus in 2 B.C.) having been in blocks of Venetian red marble—and also of a massive protecting wall slightly above it, of late date, in the construction of which a large number of Roman tombstones were used. The bed of the river was found to have risen at least 30 ft. since the collapse of this bridge (about A.D. 1000), the total length of which must have been about 650 ft. and the width between the parapets 38½ ft.

See E. Brizio in *Notizie degli Scavi* (1896), 125, 450; (1897) 330; (1898) 465; (1902) 532. (T. As.)

BONPLAND, AIMÉ JACQUES ALEXANDRE (1773-1858), French traveller and botanist, whose real name was GOUJANO, was born at La Rochelle on the 22nd of August 1773. After serving as a surgeon in the French army and studying under J. N. Corvisart at Paris, he accompanied A. von Humboldt during five years of travel in Mexico, Colombia and the districts bordering on the Orinoco and Amazon. In these explorations he collected and classified about 6000 plants till then mostly unknown in Europe, which he afterwards described in *Plantes équinoxiales*, &c. (Paris, 1808-1816). On returning to Paris he received a pension and the superintendence of the gardens at Malmaison, and published *Monographie des Mélastomées* (1806), and *Description des plantes rares de Navarre* (1813). In 1816 he set out, taking with him various European plants, for Buenos Aires, where he was elected professor of natural history, an office which he soon quitted in order to explore central South America. While journeying to Bolivia he was arrested in 1821, by command of Dr Francia, the dictator of Paraguay, who detained him until 1831. On regaining liberty he resided at San Borgia in the province of Corrientes, until his removal in 1853 to Santa Anna, where he died on the 4th of May 1858.

BONSTETTEN, CHARLES VICTOR DE (1745-1832), Swiss writer, an excellent type of a liberal patrician, more French than Swiss, and a good representative of the Gallicized Bern of the 18th century. By birth a member of one of the great patrician families of Bern, he was educated in his native town, at Yverdon, and (1763-1766) at Geneva, where he came under the influence of Rousseau and of Charles Bonnet, and imbibed liberal sentiments. Recalled to Bern by his father, he was soon sent to Leiden, and then visited (1769) England, where he became a friend of the poet Gray. After his father's death (1770) he made a long journey in Italy, and on his return to Bern (1774) entered political life, for which he was unfitted by reason of his liberal ideas, which led him to patronize and encourage Johannes Müller, the future Swiss historian. In 1779 he was named the Bernese baillif of Saanen or Gessenay (here he wrote his *Lettres pastorales sur une contrée de la Suisse*, published in German in 1781), and in 1787 was transferred in a similar capacity to Nyon, from which post he had to retire after taking part (1791) in a festival to celebrate the destruction of the Bastille. From 1795 to 1797 he governed (for the Swiss Confederation) the Italian-speaking districts of Lugano, Locarno, Mendrisio and Val Maggia, of which he published (1797) a pleasing description, and into which he is said to have introduced the cultivation of the potato. The French revolution of 1798 in Switzerland drove him again into private life. He spent the years 1798 to 1801 in Denmark, with his friend Fredrik's Brun, and then settled down in 1803 in Geneva for the rest of his life. There he enjoyed the society of many distinguished persons, among whom was (1809-1817) Madame de Staël. It was during this period that he published his most celebrated work, *L'Homme du midi et l'homme du nord* (1824), a study of the influence of climate on different nations, the north being exalted at the expense of the south. Among his other works are the *Recherches sur la nature et les lois de l'imagination* (1807), and the *Études de l'homme, ou Recherches sur les facultés de penser et de sentir* (1821), but he was better as an observer than as a philosopher.

Lives by A. Steinlen (Lausanne, 1860), by C. Morell (Winterthur, 1861), and by R. Willy (Bern, 1898). See also vol. xiv. of *Sainte-Beuve's Causeries du Lundi*. (W. A. B. C.)

BONUS (a jocular application of the Lat. *bonus*, for *bonum*, "a good thing"), a sum paid to shareholders in a joint-stock company, as an addition to the ordinary dividend, and generally given out of accumulated profits, or out of profits gained from exceptional transactions. As used by insurance companies, the word denotes the addition made to the amount of a policy by a distribution *pro rata* of accumulated profits or surplus. In a more general sense, bonus is any payment or remuneration over and above what is due and promised.

BONZE (from Japanese *bonso*, probably a mispronunciation of Chinese *fan sung*, "religious person"), the European name for the members of the Buddhist religious orders of Japan and China. The word is loosely used of all the Buddhist priests in those and the neighbouring countries.

BOOK, the common name for any literary production of some bulk, now applied particularly to a printed composition forming a volume, or, if in more than one volume, a single organic literary work. The word is also used descriptively for the internal divisions or sections of a comprehensive work.

The word "book" is found with variations of form and gender in all the Teutonic languages, the original form postulated for it being a strong feminine *Bōks*, which must have been used in the sense of a writing-tablet. The most obvious connexion of this is with the old English *bōc*, a beech tree, and though this is not free from philological difficulties, no probable alternative has been suggested.

As early as 2400 B.C., in Babylonia, legal decisions, revenue accounts, &c. were inscribed in cuneiform characters on clay tablets and placed in jars, arranged on shelves and labelled by clay tablets attached by straws. In the 7th century B.C. a library of literary works written on such tablets existed at Nineveh, founded by Sargan (721-705 B.C.). As in the case of the "Creation" series at the British Museum the narrative was

sometimes continued from one tablet to another, and some of the tablets are inscribed with entries forming a catalogue of the library. These clay tablets are perhaps entitled to be called books, but they are out of the direct ancestry of the modern printed book with which we are here chiefly concerned. One of the earliest direct ancestors of this extant is a roll of eighteen columns in Egyptian hieratic writing of about the 25th century B.C. in the Musée de Louvre at Paris, preserving the maxims of Ptah-hetep. Papyrus, the material on which the manuscript (known as the Papyrus Prisse) is written, was made from the pith of a reed chiefly found in Egypt, and is believed to have been in use as a writing material as early as about 4000 B.C. It continued to be the usual vehicle of writing until the early centuries of the Christian era, was used for pontifical bulls until A.D. 1022, and occasionally even later; while in Coptic manuscripts, for which its use had been revived in the 7th century, it was employed as late as about A.D. 1250. It was from the name by which they called the papyrus, *βιβλος* or *βιβλος*, that the Greeks formed *βιβλιον*, their word for a book, the plural of which (mistaken for a feminine singular) has given us our own word Bible. In the 2nd century B.C. Eumenes II., king of Pergamus, finding papyrus hard to procure, introduced improvements into the preparations of the skins of sheep and calves for writing purposes, and was rewarded by the name of his kingdom being preserved in the word *pergamentum*, whence our "parchment," by which the dressed material is known. In the 10th century the supremacy which parchment had gradually established was attacked by the introduction from the East of a new writing material made from a pulp of linen rags, and the name of the vanquished papyrus was transferred to this new rival. Paper-mills were set up in Europe in the 12th century, and the use of paper gained ground, though not very rapidly, until on the invention of printing, the demand for a cheap material for books, and the ease with which paper could be worked on a press, gave it a practical monopoly. This it preserved until nearly the end of the 19th century, when substances mainly composed of wood-pulp, esparto grass and clay largely took its place, while continuing, as in the transition from papyrus to linen-pulp, to pass under the same name (see PAPER).

So long as the use of papyrus was predominant the usual form of a book was that of the *volumen* or roll, wound round a stick, or sticks. The modern form of book, called by the Latins *codex* (a word originally used for the stump of a tree, or block of wood, and thence for the three-leaved tablets into which the block was sawn) was coming into fashion in Martial's time at Rome, and gained ground in proportion as parchment superseded papyrus. The *volumen* as it was unrolled revealed a series of narrow columns of writing, and the influence of this arrangement is seen in the number of columns in the earliest codices. Thus in the Codex Sinaiticus and Codex Vaticanus of the Bible, both of the 4th century, there are respectively four and three columns to a page; in the Codex Alexandrinus (5th century) only two; in the Codex Bezae (6th century) only one, and from this date to the invention of printing, while there were great changes in handwriting, the arrangement of books changed very little, single or double columns being used as was found convenient. In the external form of books there was much the same conservatism. In the Codex Amiatinus written in England in the 8th century one of the miniatures shows a book in a red leather cover, and the arrangement of the pattern on this curiously resembles that of the 15th-century red leather bindings predominant in the Biblioteca Laurenziana at Florence, in which the codex itself is preserved. In the same way some of the small stamps used in Oxford bindings in the 15th century are nearly indistinguishable from those used in England three centuries earlier. Much fuller details as to the history of written books in these as well as other respects will be found in the article MANUSCRIPT, to which the following account of the fortunes of books after the invention of printing must be regarded as supplementary.

Between a manuscript written in a formal book-hand and an early printed copy of the same work, printed in the same district as the manuscript had been written, the difference in general

appearance was very slight. The printer's type (see TYPOGRAPHY) would as a rule be based on a handwriting considered by the scribes appropriate to works of the same class; the chapter headings, headlines, initial-letters, paragraph marks, and in some cases illustrations, would be added by hand in a style which might closely resemble the like decorations in the manuscript from which the text was being printed; there would be no title-page, and very probably no statement of any kind that the book was printed, or as to where, when or by whom it was produced. Information as to these points, if given at all, was reserved for a paragraph at the end of the book, called by bibliographers a colophon (*q.v.*), to which the printer often attached a device consisting of his arms, or those of the town in which he worked, or a fanciful design. These devices are sometimes beautiful and often take the place of a statement of the printer's name. Many facsimiles or copies of them have been published.¹ The first dated title-page known² is a nine-line paragraph on an otherwise blank page giving the title of the book, *Sermo ad populum predicabilis in festo presentacionis Beatissime Marie Semper Virginis*, with some words in its praise, the date 1470 in roman numerals, and a reference to further information on the next page. The book in which this title-page occurs was printed by Arnold ther Hoernen at Cologne. Six years later Erhard Ratdolt and his partners at Venice printed their names and the date, together with some verses describing the book, on the title-page of a Latin calendar, and surrounded the whole with a border in four pieces. For another twenty years, however, when title-pages were used at all, they usually consisted merely of the short title of the book, with sometimes a woodcut or the printer's (subsequently the publisher's) device beneath it, decoration being more often bestowed on the first page of text, which was sometimes surrounded by an ornamental border. Title-pages completed by the addition of the name and address of printer or publisher, and also by the date, did not become common till about 1520.

While the development of the title-page was thus slow the completion of the book, independently of handwork, in other respects was fairly rapid. Printed illustrations appear first in the form of rude woodcuts in some small books produced at Bamberg by Albrecht Pfister about 1461. Pagination and headlines were first used by ther Hoernen at Cologne in 1470 and 1471; printed signatures to guide binders in arranging the quires correctly (see BIBLIOGRAPHY AND BIBLIOLOGY) by Johann Koelhoff, also at Cologne in 1472. Illustrations abound in the books printed at Augsburg in the early 'seventies, and in the 'eighties are common in Germany, France and the Low Countries, while in Italy their full development dated from about 1490. Experiments were made in both Italy and France with illustrations engraved on copper, but in the 15th century these met with no success.

Bound with wooden boards covered with stamped leather, or with half of the boards left uncovered, many of the earliest printed books are immensely large and heavy, especially the great choir-books, the Bibles and the Biblical and legal commentaries, in which a great mass of notes surrounds the text. The paper on which these large books were printed was also extraordinarily thick and strong. For more popular books small folio was at first a favourite size, but towards the end of the century small thin quartos were much in vogue. Psalters, books of hours,

¹ Works especially devoted to these facsimiles are:—Berjeau's *Early Dutch, German and English Printers' Marks* (London, 1866); W. Roberts's *Printers' Marks* (London, 1893); Silvestre's *Marques typographiques* (French; Paris, 1853-1867); *Die Büchermarken oder Buchdrucker und Verlegerzeichen* (Strassburg, 1892-1898), the successive parts containing the devices used in Alsace, Italy, Basel, Frankfurt, Mainz and Cologne; and *Marques typographiques des imprimeurs et libraires qui ont exercé dans les Pays-Bas* (Gand, 1894). Numerous devices are also reproduced in histories of printing and in volumes of facsimiles of early types.

² An edition of a bull of Pope Pius II. in the John Rylands library, Manchester, in types used by Fust and Schoeffer at Mainz, bears printed on the top of the first page the words " Dis ist die bul zu dutsch die unser allerheiliger vatter der bapst Pius herugesant hat wider die snoden unseubigen turcken." This is attributed to the year 1463, and is claimed as the first book with a printed title-page.

and other prayer-books were practically the only very small books in use. Owing to changes, not only in the value of money but in the coinage, the cost of books in the 15th century is extremely difficult to ascertain. A vellum copy of the first printed Bible (Mainz, c. 1455) in two large folio volumes, when rubricated and illuminated, is said to have been worth 100 florins. In 1467 the bishop of Aleria writing to Pope Paul II. speaks of the introduction of printing having reduced prices to one-fifth of what they had previously been. Fifteen "Legends" bequeathed by Caxton to St Margaret's, Westminster, were sold at prices varying from 6s. 8d. to 5s. This would be cheap for a large work like the *Golden Legend*, but the bequest was more probably of copies of the Sarum *Legenda*, or Lectionary, a much smaller book.

16th Century.—The popularization of the small octavo by Aldus at Venice in 1501 and the introduction in these handy books of a new type, the italic, had far-reaching consequences. Italics grew steadily in favour during the greater part of the century, and about 1570 had almost become the standard vernacular type of Italy. In France also they were very popular, the attempt to introduce a rival French cursive type (*lettres de civilité*) attaining no success. In England they gained only slight popularity, but roman type, which had not been used at all in the 15th century, made steady progress in its contest with black letter, which by the end of the century was little used save for Bibles and proclamations. The modern practice in the use of i and j, u and v dates from about 1580, though not firmly established till the reign of Charles I.

In the second quarter of the 16th century the French printers at Paris and Lyons halved the size of the Aldine octavos in their small sextodecimos, which found a ready market, though not a lasting one, the printers of Antwerp and Leiden ousting them with still smaller books in 24mo or small twelves. These little books were printed on paper much thinner than had previously been used. The size and weight of books was also reduced by the substitution of pasteboards for wooden sides. Gold tooling came into use on bindings, and in the second half of the century very elaborate decoration was in vogue in France until checked by a sumptuary law. On the other hand a steady decline in the quality of paper combined with the abandonment of the old simple outline woodcuts for much more ambitious designs made it increasingly difficult for printers to do justice to the artists' work, and woodcuts, at first in the Low Countries and afterwards in England and elsewhere, were gradually superseded by copper-plates printed separately from the text. At the beginning of this century in England a ballad or Christmas carol sold for a halfpenny and thin quarto chapbooks for 4d. (a price which lasted through the century), the Great Bible of 1541 was priced at 10s. in sheets and 12s. bound, Edward VI.'s prayer-book (1549) at 2s. 2d. unbound, and 3s. 8d. in paste or boards; Sidney's *Arcadia* and other works in 1598 sold for 9s.

17th Century.—Although the miniature editions issued by the Elzevirs at Leiden, especially those published about 1635, have attracted collectors, printing in the 17th century was at its worst, reaching its lowest depths in England in the second quarter. After this there was a steady improvement, partly due to slight modifications of the old printing presses, adopted first in Holland and copied by the English printers. In the first half of the century many English books, although poorly printed, were ornamented with attractive frontispieces, or portraits, engraved on copper. During the same period, English prayer-books and small Bibles and New Testaments were frequently covered with gay embroideries in coloured silks and gold or silver thread. In the second half of the century the leather bindings of Samuel Mearne, to some extent imitated from those of the great French binder Le Gascon, were the daintiest England had yet produced. For trade bindings rough calf and sheepskin were most used, and the practice of lettering books on the back, instead of on the sides or fore-edges or not at all, came gradually into favour. Owing to the increase of money, and in some cases to the action of monopolists, in others to the increased payments made to authors, book-prices rather rose than fell. Thus church Bibles, which had been sold at 10s. in 1541, rose successively to

258., 308. and (in 1641) to 408. Single plays in quarto cost 6d. each in Shakespeare's time, 1s. after the Restoration. The Shakespeare folio of 1623 is said to have been published at 1s. Bishop Walton's polyglot Bible in six large volumes was sold for 110 to subscribers, but resulted in a heavy loss. Izaak Walton's *Compleat Angler* was priced at 1s. 6d. in sheepskin, *Paradise Lost* at 3s., *The Pilgrim's Progress* at 1s. 6d.; Dryden's *Virgil* was published by subscription at 15s. It was a handsome book, ornamented with plates; but in the case of this and other subscription books a desire to honour or befriend the author was mainly responsible for the high price.

18th Century.—During this century there was a notable improvement alike in paper, type and presswork in both France and England, and towards the end of the century in Germany and Italy also. Books became generally neat and sometimes elegant. Book-illustration revived with the French *livres-d'ornement*, and English books were illustrated by Gravelot and other French artists. In the last quarter of the century the work of Bewick heralded a great revival in woodcut illustrations, or as the use of the graver now entitled them to be called, wood engravings. The best 18th-century binders, until the advent of Roger Payne, were inferior to those of the 17th century, but the technique of the average work was better. In trade bindings the use of sheepskin and calf became much less common, and books were mostly cased in paper boards. The practice of publishing poetry by subscription at a very high price, which Dryden had found lucrative, was followed by Prior and Pope. Single poems by Pope, however, were sold at 1s. and 1s. 6d. Novels were mostly in several volumes. The price at the beginning of the century was mostly 1s. 6d. each. It then remained fairly steady for many years, and at the close of the century rose again. Thus Miss Burney's *Essalina* (3 vols., 1778) sold for 7s. 6d., her *Cecilia* (5 vols., 1782) for 12s. 6d., and her *Camilla* (5 vols., 1796) for 11s. Johnson's *Dictionary* (2 vols. folio, 1755) cost 14s. 4s. in sheets, 14s. 1s. in boards.

19th Century.—A great change in the appearance of books was caused by the use first of glazed calico (about 1820), afterwards (about 1830) of cloth for the cases of books as issued by their publishers. At first the lettering was printed on paper labels, but soon it was stamped in gilt on the cloth, and in the last quarter of the century many very beautiful covers were designed for English and American books. The designs for leather bindings were for many years chiefly imitated from older work, but towards the end of the 'eighties much greater originality began to be shown. Book illustrations passed through many phases. As subsidiary methods colour-prints, line engravings, lithographs and etchings were all used during the first half of the century, but the main reliance was on wood-engraving, in which extraordinary technical skill was developed. In the 'sixties and the years which immediately preceded and followed them many of the chief English artists supplied the engravers with drawings. In the last decade of the century wood-engraving was practically killed by the perfection attained by photographic methods of reproduction (see PROCESS), the most popular of these methods entailing the use of paper heavily coated with china clay. During the century trade-printing, both in England and America, steadily improved, and the work done by William Morris at his Kelmscott Press (1891-1896), and by other amateur printers who imitated him, set a new standard of beauty of type and ornament, and of richness of general effect. On the other hand the demand for cheap reprints of famous works induced by the immense extension of the reading public was supplied by scores of pretty if flimsy editions at 1s. 6d. and 1s. and even less. The problem of how to produce books at moderate prices on good paper and well sewn, was left for the 20th century to settle. About 1804 the number of such medium-priced books was greatly increased in England by the substitution of single-volume novels at 6s. each (subject to discount) for the three-volume editions at 31s. 6d. The preposterous price of 10s. 6d. a volume had been adopted during the first popularity of the *Waverley Novels*, and despite the example of France, where the standard price was 3 fr. 50, had continued in force for the greater part of the century. Even after

novels were sold at reasonable rates artificial prices were maintained for books of travel and biographies, so that the circulating libraries were practically the only customers for the first editions. (See PUBLISHING and BOOKSELLING). (A. W. Po.)

BOOKBINDING. Bindings or covers to protect written or printed matter have always followed the shapes of the material on which the writing or printing was done. Very early inscriptions on rocks or wood needed no coverings, and the earliest instances of protective covers are to be found among the smaller Assyrian tablets of about the 8th century B.C. These tablets, with cuneiform inscriptions recording sales of slaves, loans of money and small matters generally, are often enclosed in an outer shell of the same shape and impressed with a short title. Egyptian papyrus rolls were generally kept in roll form, bound round with papyrus tape and often sealed with seals of Nile mud; and the rolls in turn were often preserved in rectangular hollows cut in wood. The next earliest material to papyrus used for writing upon was tree bark. Bark books, still commonly used by uncultured nations, often consisting of collections of magical formulae or medical receipts, are generally rolls, folded backwards and forwards upon themselves like the sides of a concertina. At Pompeii in 1875 several diptychs were found, the wooden leaves hollowed on the inner sides, filled with blackened wax, and hinged together at the back with leather thongs. Writings were found scratched on the wax, one of them being a record of a payment to Umbricia Januaria in A.D. 55. This is the earliest known Latin manuscript. The diptychs are the prototypes of the modern book. From about the 1st to the 6th century, ornamental diptychs were made of carved ivory, and presented to great personages by the Roman consuls.

Rolls of papyrus, vellum or paper were written upon in three ways. (1) In short lines, at right angles to the length of the roll. (2) In long lines each the entire length of the roll. (3) In short lines parallel to the length of the roll, each column or page of writing having a space left on each side of it. Rolls written in the first of these ways were simply rolled up and kept in cylinders of like shape, sometimes several together, with a title tag at the end of each, in a box called a *scrinium*. In the case of the second form, the most obvious instances of which are to be found in the Buddhist prayer-wheels, the rolls were and are kept in circular boxes with handles through the centres so that they can revolve easily. In the third manner of arranging the manuscript the page forms show very clearly, and it is still used in the scrolls of the law in Jewish synagogues, kept on two rollers, one at each end. But this form of writing also developed a new method for its own more convenient preservation. A roll of this kind can be folded up, backwards and forwards, the bend coming in the vacant spaces between the columns of writing. When this is done it at once becomes a book, and takes the Chinese and Japanese form known as *orihon*—all the writing on one side of the roll or strip of paper and all the other side blank. Some books of this kind are simply guarded by two boards, but generally they are fastened together along one of the sides, which then becomes the back of the book. The earliest fastening of such books consists of a lacing with some cord or fibre run through holes stabbed right through the substance of the roll, near the edge. Now the *orihon* is complete, and it is the link between the roll and the book. This "stabbed" form of binding is the earliest method of keeping the leaves of a book together; it occurs in the case of a Coptic papyrus of about the 8th century found at Thebes, but it is rarely used in the case of papyrus, as the material is too brittle to retain the threads properly.

The method of folding vellum into pages seems to have been first followed about the 5th century. The sheets were folded once, and gatherings of four or more folded sheets were made, so that stitches through the fold at the back would hold all the sheets together and each leaf could be conveniently turned over. Very soon an obvious plan of fixing several of these gatherings, or quires, together was followed by the simple expedient of fastening the threads at the back round a strong strip of leather or vellum held at right angles to the line of the backs. This early plan of "sewing" books is to-day used in the case of valuable



Fig. 1.—Winchester Domesday Book of the
12th Century.
Dark brown morocco, blind stamped.



Fig. 2.—St Cuthbert's Gospels.
Red leather with repoussé design, prob-
ably the work of the 7th or 8th century.
The fine lines are impressed by hand, and
painted blue and yellow.



Fig. 3.—Binding Made for Jean Grolier.
Pale brown morocco, gold tooled.



Fig. 4.—Binding Made for
James I.
Dark blue morocco, gold
tooled. The red in the coat-
of-arms inlaid with red mo-
rocco.



Fig. 5.—Common Prayer (London, 1678).
Smooth red morocco, gold tooled with black
fillets. Bound by Samuel Mearne.



Fig. 6.—*Le Livre des Statuts et
Ordonnances de L'ordre du Ben-
vist Saint Esprit* (Paris, 1578).
Brown morocco, gold tooled,
arms of Henry III., King of
France. Bound by Nicholas Eve.



Fig. 7.—Catalogue of the Pictures at
Hagley Hall.
Red niger morocco, gold tooled. Bound
by Douglas Cockerell.



Fig. 8.—Walton's Compleat Angler (1772).
Golden brown morocco, gold tooled.
Bound by Miss E. M. MacColl.

books; it is known as "flexible" work, and has never been improved upon.

As soon as the method of sewing quires together in this way became well understood, it was found that the projecting bands at the back needed protection, so that when all the quires were joined together and, so far, finished, strips of leather were fastened all over the back. But it was also found that vellum leaves were apt to curl strongly, and to counteract this tendency strong wooden boards were put on each side. The loose ends of the bands were fastened to the boards, which hinged upon them, and the protecting strip of leather at the back was drawn over the boards far enough to cover the hinge. So we get the medieval "half-binding" which shows the strip of leather over the back of the book, projecting for a short way over the boards, the rest of which is left uncovered. The boards were usually kept closed by means of clasps in front.

The leather strip soon developed, and covered the whole of the boards, "whole" binding as it is called, and it was quickly found that these fine flat pieces of leather offered a splendid field for artistic decoration.

The first ornamentation on leather bindings was probably made by means of impressions from small metal points or lines, pressed upon the leather. This in time led to the purposeful cutting of small decorative stamps to be used in the same way. It is considered that English binders excelled in this art of "blind" stamping, that is, without the use of gold leaf. Most of the stamps were cut intaglio, so that their impressions are in cameo form. Such bindings were made to perfection during the 12th and 13th centuries at Durham, Oxford, Cambridge, London and other places. One of the most charming examples left is the binding of the Winchester Domesday Book of the 12th century (Plate, fig. 1), now belonging to the Society of Antiquaries of London.

From about the 7th to the 16th century illuminated manuscripts were held in the greatest esteem. Among them can be found not only exquisite calligraphy but exquisite miniature painting. Moreover, the gorgeousness of the illuminations inside suggested gorgeousness of the outside coverings, so we find splendid work in metals with jewels, enamels and carved ivory, dating from the 7th-century *Gospels of Theodotinda* at Monza, the Irish cumdach of the *Sionne Missal*, the *Lindau Gospels* now in America, and the *Gospels of Charlemagne* in the Victoria and Albert Museum at South Kensington, to the magnificent bindings of 14th-century Limoges enamel in the British Museum. Such English bindings of this kind—intrinsically precious—as may have existed have all disappeared,—most likely they were melted up by Henry VIII. or Edward VI.; but at Stonyhurst there is a book known as *St Cuthbert's Gospels*, which is bound in red leather with a reposed design upon it, and is probably the work of the 7th or 8th century (Plate, fig. 2).

When printing was introduced into Europe about the middle of the 15th century, there was very soon a reaction against the large, beautiful and valuable illuminated MSS. and their equally precious covers. Printing brought small books, cheap books, ugly books, generally bound in calf, goatskin or sheepskin, and ornamented with large panel stamps in blind. But a new art came into birth very shortly, namely the art of gold tooling on leather, which in capable hands is almost a great art, and specimens of the work of the few great masters that have practised it are now much sought after and likely to increase in estimation and value. All this, as usual, brings a school of skilled *fussaires* into the field, and already the collector of fine bindings must be wary, or he may easily give thousands of pounds for forged or made-up objects that are worth but little.

In the matter of leather bindings with gold tooling, an art which was probably brought to Venice from the East, the finest examples are to be found in late 15th-century Italian work. The art quickly spread, and Thomas Berthelet, Royal Binder to Henry VIII., seems to have been the first binder who practised it in England. Berthelet's work is strongly Italian in feeling, especially at first, and it is likely that he was taught the new art by an Italian master; he worked until about 1558.

During the late 15th and the 16th century in England, numbers of fine printed books were bound in velvet and satin, sometimes set with enamels, sometimes embroidered. These books, having strong threads of metal freely used upon them, have lasted much better than would be expected, and instances of such work made for Henry VIII. are still in excellent condition, and most decorative.

The fashion of ornamenting English royal books with heraldic designs, which is considered to have begun in the reign of Edward IV., has continued without break. The same fashion in books belonging to private owners was first followed during the later Tudor period, and then numbers were made, and have been, more or less, ever since.

During the whole Tudor period several small bindings of gold ornamented with enamels were made. Some of these still exist, and they are charming little jewels. They were always provided with a ring at the top, no doubt for attaching to the girdle.

Aldus Manutius, the great Venetian printer, had several of his books charmingly bound in dark morocco with "Aldine" knot leaves and small dolphins both in blind and gold tooling; and Giunta, a Florentine printer, had his books bound in a similar way but without the dolphins. Many early Venetian bindings have recessed panels, made by the use of double boards, the upper of which is pierced, finished in true oriental fashion.

Jean Grolier, viscount d'Agulsy, treasurer of France in 1545, was a great collector of fine books, most of which were bound for himself, and bear upon them his legend, *Portio mea domine sit in terra viventium*, and also his name, *Io Grolierii et Amicorum* (Plate, fig. 3). Tommaso Maloli, an Italian collector of about the same time, used the same form of legend. Books bound for him are curiously marked with atoms of gold remaining in the irregularities of the leather.

Demetrio Canevari, physician to Pope Urban VIII., had his books bound in dark green or deep red morocco, and upon them is a fine cameo stamp with a design of Apollo driving a chariot with one white horse and one black horse towards a mountain on which is a silver Pegasus. The stamp was coloured, but in most cases the colour has now worn off. Round the stamp is the legend *ΟΡΘΟΣ ΚΑΙ ΜΗ ΑΟΖΙΟΣ*.

The Italian bindings which were made for popes and cardinals are always of much interest and often of high merit, but as a rule later Italian bindings are disappointing.

Geoffrey Tory, printer and engraver to Francis I. of France, designed some fine bindings, some for himself and quite possibly some for Jean Grolier.

For Henry II. of France much highly decorative work in binding was done, richly gilded and coloured. These bindings have upon them the king's initials, the initials of his queen, Catherine de' Medici, and the emblems of crescents and bows. Henry's device was a crescent with the legend, *Donec impleat totum orbem*. Bindings of similar style were made for Diane de Poitiers, duchesse de Valentinois, with her initials and the same devices of crescents and bows. They are always fine work.

German bindings are mostly in pigskin, finely stamped in blind. Several are, however, in calf. Gilding, when it exists, is generally bad.

In England during the 17th century much fine work was done in binding, most of it in morocco, but Henry, prince of Wales, always had his books bound in calf. The Jacobean style is heraldic, with semis of small stamps and heavy corners, but James I. has left some very fine bindings in another style (Plate, fig. 4), very possibly done for him by John Gibson, who bound the royal books while James was king of Scotland only. During the reign of Charles I. Nicholas Ferrar founded his curious establishment at Little Gidding, and there his niece Mary Collet and her sisters set up a bindery. They made large scrap-books, harmonies of the Gospels and other parts of the Bible, with illustrations, and bound them magnificently in velvet stamped in gold and silver. They were taught by a binder who worked for John and Thomas Buck, printers to the university of Cambridge, and the Little Gidding stamps are often identical with Buck's.

Samuel Mearne (d. 1683) was royal binder to Charles II., and invented the cottage style of decoration, a style which has lasted till the present day; the Bible on which Edward VII. took the coronation oath was ornamented in that way. An inner rectangle is run parallel to the edges of the book, and the upper and lower lines are broken outwards into the outline of a gable roof. Mearne's work as a binder (Plate, fig. 5) is of the highest merit. Many of his books have their fore-edge painted in such a way that the work is invisible when the book is shut, and only shows when the edges are fanned out.

In France 16th- and 17th-century binding is distinguished by the work of such masters as Nicholas Eve, who bound the beautiful *Livre des Statuts et Ordonnances de l'Ordre du Bemist Saint Esprit* for Henry III. (Plate, fig. 6); Clovis Eve, who is credited with the invention of the style known as "fanfare," a delicate tracery over the boards of a book, filled out with spirals of leafy stems; and Le Gascon, who invented the dotted work which has been used more or less ever since. Le Gascon caused his small gilding tools—curves and arabesques—to be scored across, so that when impressions were made from them a dotted line showed instead of a right line. Florimond Badier worked in a style very similar to that of Le Gascon and sometimes signed his work, which Le Gascon never did. Le Gascon had many imitators, the best and closest being Poncyn and Magnus, Dutch binders who worked at Amsterdam in the 17th century, and his style has been continuously followed to the present day.

The bindings of Padeloup le Jeune often have small tickets with his name upon them; they usually have borders of lace-like gold tooling known as "dentelle" and are often inlaid. He belonged to a family of binders, all of whom were excellent workmen, and lived in the 17th and 18th centuries.

The Deromes were another of the great French families of binders; the most celebrated was Nicholas Denis, called "Le Jeune," born in 1731. He used dentelle borders resembling those of Padeloup, but with little birds interspersed among the arabesques—"dentelles à l'oiseau."

Among the many French binders of the 18th century who used delicate inlays of coloured leathers, Jean Charles le Monnier was perhaps the most skilled. He often signed his bindings in small capitals impressed in gold somewhere about the inlaid part.

Eliot and Chapman bound the library of Robert Harley, earl of Oxford, about the middle of the 18th century. The bindings are in morocco, with broad, richly gold-tooled borders, and usually a diamond-shaped centre-piece. This is known as the Harleyan style.

Thomas Hollis had his books bound in fine red morocco, ornamented with small, well-cut stamps engraved by Thomas Pingo, the medallist. These stamps comprise a cap of liberty, a figure of liberty, a figure of Britannia and several smaller ones.

Towards the end of the 18th century, when binding in England was decoratively at a low level, Roger Payne, a native of Windsor, came to London and set up as a bookbinder. He was a splendid workman, and introduced richly gold-tooled corner-pieces, ornamental "doublures" or inside linings, and also invented the graining of morocco, graining it, however, in one direction only, known as the "straight grain." It is said that Payne cut his own binding tools of iron; they certainly are exquisitely made, and in many of his bindings he has put a written description of loving work he has done upon them. Payne was, unfortunately, a drunkard, but he has in spite of this rendered an immortal service to the art of bookbinding in England.

In 1785 John Edwards of Halifax patented a method of making vellum transparent, and using it as a covering over delicate paintings. He also painted pictures on the fore-edges of many of his books in the same manner as that followed by Samuel Mearne in the 17th century, so that they did not show until the book was opened. John Whitaker used calf for his bindings, but ornamented the calf in a curious way with strong acids and with prints from engraved metal plates. Both Edwards and Whitaker liked classical borders and ornaments, and their bindings are in consequence often known as "Etruscan."

The main styles used in England at the beginning of the 19th

century were nothing more than distant imitations of Roger Payne. Kalthoeber, Staggemeier, Walther and Hering were all disciples of this master, but Charles Lewis worked on original lines. He developed arabesques and paid particular attention to richly gold-tooled doublures. He also used gold end papers, and the bands at the back of his bindings are often double and always broad, flat and gold-tooled. His workmanship is excellent; he worked largely for Thomas Grenville and other great collectors.

French binding of the 19th century is remarkable for wonderful technical excellence in every part. Among the most skilled of these admirable workmen and artists may be particularly mentioned Thouvenin, Bauzonnet, Lortic, Niedr e, Cap  and Duru, and fortunately they generally sign their work in small gold lettering either on the back of their bindings or inside along the lower edge.

Recent years have witnessed a marked revival of interest in the art of bookbinding, but modern binders have two serious difficulties to contend with. One of these is the prevalence of bad paper, overlaid with clay and with wood pulp, and also the fact that many of the modern Modern methods.

leathers are badly prepared and dangerously treated with sulphuric acid, which in time inevitably rots the fibre. The Society of Arts has appointed committees of experts to report upon both of these evils, and the published accounts of both inquiries are of much value, and it is to be hoped that the results may be beneficial. Concurrently with the revival of the artistic side of the subject, there has also arisen a remarkable development in the technical processes, owing to the invention of ingenious and delicate machinery which is capable of executing the work which had hitherto been always laboriously done by hand. The processes of folding the printed sheets, and sewing them together on bands, rounding the backs when sewn, and of making the outer cases, covering them with cloth or leather and stamping designs upon them, can now all be efficiently executed by means of machines. The saving in time and labour thus effected is very great, although it must be said that the old methods of carrying out the process of sewing and rounding the backs of books by hand labour were safer and stronger, as well as being much less liable to bruise and injure the paper. These processes unfortunately are not only slow but also necessitate highly skilled labour. Already the larger trade binders utilize machines extensively and advantageously, but exclusively high-class trade binders do not as yet materially depart from the older methods. Private binders have naturally no reason to use machines at all. Fine and delicate examples of large metal blocks or dies have been very successfully used for the decoration of covers measuring about 11½ by 8 in.

Besides the large trade binders working mainly by the help of machinery, and producing a great quantity of bound work which is not expected to last long, there also exists in London, Paris, New York and other large cities, a small class of art binders who work throughout upon the principles which have been continuously in use for first-class work ever since about the 5th century. The initial impetus to this school can be traced to William Morris, who himself made some beautiful designs for bookbindings, to be executed both in gold and in blind. Although he probably did not fully appreciate either the peculiar limitations or the possibilities of the art of gold-tooling on leather, nevertheless his genius-guided him truly as to the spirit in which the designs should be conceived. The revived art soon reached its first stage of development under the guidance of Mr T. J. Cobden-Sanderson, who may fairly be considered as the founder of the modern school of design for gold-tooling on book-covers, the pre-eminence and individuality of his work in this direction being proved by the number of his imitators. Among the most successful of his pupils is Mr Douglas Cockerell, whose work (Plate, fig. 7) is distinguished by a marked originality of treatment, while it shows a scholarly appreciation of ancient methods. Mr Alfred de Sauty has succeeded in developing a new and admirable style in inlaid leathers, combined with delicate pointille work. A number of women artists, both in England

and in America, have already discovered in bookbinding a fitting and lucrative field for their energies. One, Miss Sarah Prideaux, is not only skilled and original in her own work, but she has also given us much valuable literature on her subject. Miss E. M. MacColl may claim to be the inventor of the small curved gold line produced by means of a tiny wheel, for though the possibility of producing such a line in blind was known for a long time, it was rarely used. The graceful curves and lines found on Miss MacColl's work have been designed for her by her brother, Mr D. S. MacColl (Plate, fig. 8). Miss Joanna Birkenruth recalls the highly decorative medieval binding by her use of jewels cut *en cabochon*, but set in morocco instead of gold or silver, and there are many others who are working well and earnestly at art binding with delicate skill and taste. Outside

full advantage of them can only be taken where there is a large edition of one book.

Book-sewing machines (fig. 9) are of two kinds: one sews the books on bands, either flat or round, and the other supplies the place of bands by a kind of chain stitch. The band-working machines bring the return thread back by pulling *Sewing* through the upper and lower edges of the back of each section, thereby to some extent weakening each section, but at the same time this weakening can be to some extent neutralized by careful headbanding. The other system, where the band is replaced by a chain stitch, brings back the return thread inside each section; the objection to this is that there is a flattening out of the back of the book, which becomes a difficulty when the subsequent operation of covering the book begins. The sections are sewn continuously in a long line, and are afterwards cut apart. The threads catch into hooked needles and are drawn through holes made by piercers set to a certain distance; a shuttle like that used in an ordinary sewing-machine

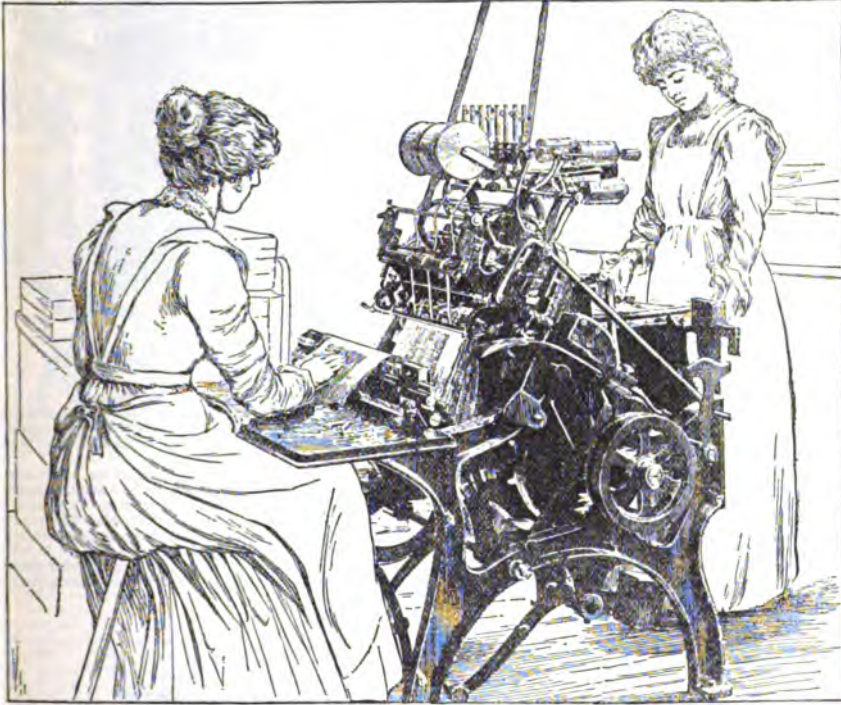

FIG. 9.—Book-sewing Machine.

the inner circle of professional bookbinders there has grown up a new profession, that of the designer for pictorial book-covers, especially those intended to be shown in colour on cloth or paper. Among notable designers may be mentioned Lewis F. Day, A. A. Turbayne, Walter Crane and Charles Ricketts.

Machine-binding.—The principal types of machine for commercial binding are described below. They are almost all due to American or German ingenuity. It may be noted that, while books sewn by hand on bands have the loose ends of the bands actually drawn through the boards and strongly fastened to them through their substance, no machines for covering sewn books will do this so effectively. All they will do as a rule is to paste down to the inner surfaces of the boards the loose ends of the tapes on which the sewing is done. So that, although it may last a long time if not much used, a "cased" book is likely to slip out of its cover as soon as the paste fixing it perishes. Modern bookbinding machines of all kinds are usually driven by power, and in consequence of the necessary setting of most of them accurately to some particular size of book, they are not suitable for binding books of different sizes; the

sews the inner thread backwards and forwards. Each section is placed upon a sort of metal saddle by the hand of the operator, one after the other, the machine working continuously unless the action is cut off or controlled by a foot-lever or pedal. This machine is much quieter to work, and although the inner threads are too bulky to be quite satisfactory, this is not a serious matter like the cutting of the upper and lower edges of the back already described, and, moreover, is probably capable of being either improved away or so minimized that it will become of small importance.

The Martini book-sewing machine, which sews books on tape without cutting up head or tail—a most important improvement—and also forms complete Kettle stitches, will sew books of any size up to 18 in. The needles are straight, and the necessary adjustments for various sizes of books are very simple.

The machine for rounding and backing sewn books requires a rather elaborate and very careful setting of several parts to the exact requirement of each size to be worked. The sewn book with the back glued is caught in a clip and forced between two tight rollers, the result being that the hitherto flat back is automatically turned into a rounded shape (figs. 10 and 11). The book is then drawn forward, by a continuance

*Rounding
and
backing.*

of the onward movement, until it reaches the rounding plate, which is a block of steel with a polished groove a little larger than the size required. This rounding plate moves within a small arc by means of heavy counter-weights, and on the back of the book being strongly pressed against it, it receives the permanent form of the groove cut in it, at the same time a strong grip on each side of the book causes the ledge to rise up along each outer edge of the back. This ledge it is which enables the boards to be subsequently fixed in such a way as to hinge on a line outside the actual and natural boundary of the book. Before the discovery of the possibility of producing this ledge, the boards of books hinged upon a line coincident with the inner edges of the back, the result of which was that when the book was opened there was an invariable tendency to open and pull away the few outer sections of the paper or vellum itself—a destructive and disagreeable peculiarity. These machines are capable, after they are properly set, of rounding and backing about 750 volumes of the same size within an hour.

The machine for making cases, or "case" covers (fig. 12), for books is large and complicated, but beautifully effective. It contains altogether over fifty springs, some of which are very small, like watch

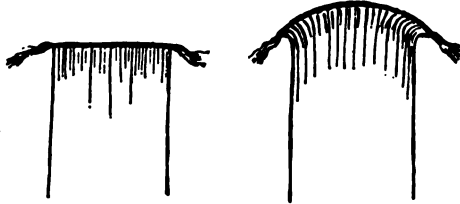

FIG. 10.—Section of back of book sewn on bands. FIG. 11.—Section of same book after it has passed through the machine for rounding and backing.

fittings, while others are large and powerful. The machine is fed with pieces of cardboard cut exactly to the sizes of the required boards, other pieces cut to the size of the back, and a long roll of the cloth with which the cases are to be covered, and when set working the roll of cloth is gradually unwound and glued by contact with a roller, which is drawn along until it reaches a point where the two boards are ingeniously dropped upon it—one by one, then on again to where a long arm swings backwards and forwards, at each movement picking up a piece of cardboard for the back and placing it gently exactly upon the glued bed left for it between the two boards already fixed. Next, as the cloth passes along, it comes under the sharp influence of two rectangular gouges which cut out the corners, the remaining side pieces being gradually but irresistibly turned up by hollow raisers and flattened down by small rollers, a very delicate piece of machinery finishing the corners in a masterly way. Then, lastly, an arrangement of raisers and rollers acting at right angles to the last mentioned turn over and press out the remaining pieces of cloth. Of course each piece of cloth is cut across at the proper point before the turning up begins. This machine is capable of

producing 1200 cases in an hour of any size that the machine will take.

The Smyth casing-in machine (fig. 13) pastes the sides of a book as required and then attaches the cover over all. Cleverly arranged rollers catch the book, and by a carefully regulated pressure fix the cover in the proper position. There is a "jointing-in" device which

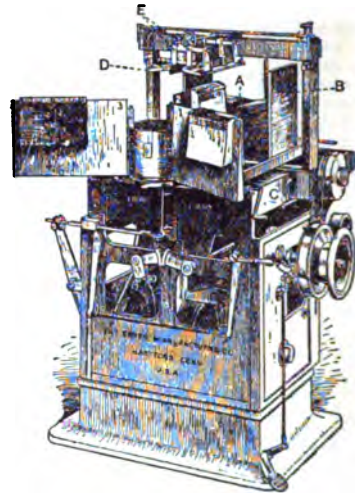

FIG. 13.—Smyth Casing-in Machine.

- | | |
|-------------------------|--|
| A. Cases. | 1. 1st position. |
| B. Side of Case Hopper. | 2. 2nd position. |
| C. Paste box. | 3. 3rd position and finished book. |
| D. Head Clamp Rod. | When in 2nd position the book drops to level of paste box. |
| E. Head Clamp. | |

at a critical moment forces the joints in the cover into the joints in the book. It will work books from 4 to 22 in. in length and from $\frac{1}{4}$ to 3 in. in thickness, and can cover from 10 to 15 books per minute.

Here may also be mentioned the Sheridan wrapping machine, which covers magazines and pamphlets ranging from 5 to 12 in. in length at the rate of 40 a minute.

Wiring is a cheap method of keeping together thin parts of periodicals or tracts. The machine that executes it is simple in construction

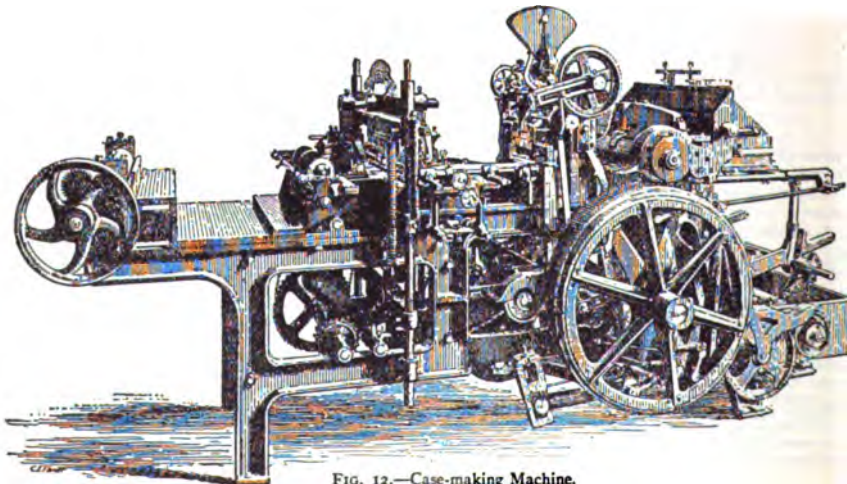

FIG. 12.—Case-making Machine.

and use. It drives a short wire pin, bent at right angles at each end, through the folds of the sections of a book or through the entire thickness, sideways, after the manner of stabbing. The projecting ends, when through the substance of the paper, are bent over and flattened so as to grip firmly. The metal used for these pins was at first very liable to rust, and consequently did much damage to the paper near it, but this defect has now been largely remedied. At the same time the principle of using hard metal wire instead of flexible hempen thread is essentially vicious, and should only be used as a temporary expedient for publications of little value.

The machines (Fig. 14) now used for blocking designs upon book-covers are practically the same as have been employed for many years. Several small improvements have been introduced as to better linking of the rollers for colour work, and better heating of the blocks used for gold work. A blocking press is now, in consequence of the size of many of the blocks, a large and cumbersome machine. The block itself is fixed firmly in a strong metal bed, and a movable table in front of it is fitted with gages which keep the cover exactly in its right place. For gold

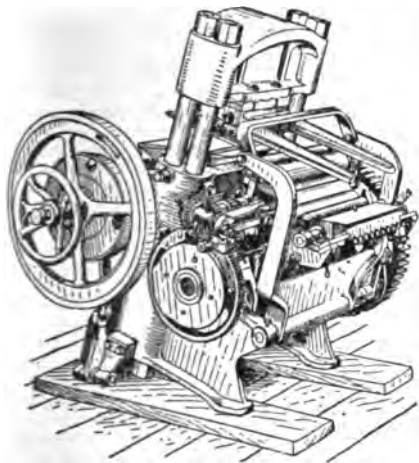

FIG. 14.—Blocking Machine.

work the block is kept at the proper temperature by means of gas jets, and the cover being properly overlaid with gold leaf is passed, on its table, directly under the block and then pressed steadily upwards against it, lowered, drawn out, and the superfluous gold rubbed off. The same process is followed in the case of colour blocks, only now the block need not be heated, but is inked by means of a roller for each impression. A separate printing is necessary for each colour. These printings always require great care on the part of the operator, who has to watch the working of each pull very carefully, and if any readjustment is wanted, to make it at once, so that it is difficult to estimate at what rate they can be made. In the matter of gold blocking there must be great care exercised in the matter of the heat of the block, for if it is too hot the gold will adhere where it is not wanted, and if too cool it will not adhere where it is required. Great nicety is also necessary as to the exact pressure required as well as the precise number of moments during which the block should be in contact with the gold, which is fastened to the cloth or leather by means of the solidification by heat of egg albumen. Blocking presses are also largely used.

ЛУТВОРИТЕЛ.—See the *Anglo-Saxon Review* (1897-1901); C. J. Dawson, *Royal English Bookbinding* (1896); *Cantor Lectures on Bookbinding* (1898); *English Embroidered Bookbindings* (1899); *Life of Thomas Berthelet* (1901); *Life of Samuel Mearne* (1906); W. Y. Fletcher, *English Bookbindings in the British Museum* (1895); *Foreign Bookbindings in the British Museum* (1896); L. Gruel, *Manuel de l'amateur de relieures* (1887); H. P. Horne, *The Binding of Books* (1894); S. T. Pridaun, *Historical Sketch of Bookbinding* (1893); E. Thoinan, *Les Relieurs français* (1893); O. Uzanne, *Les Relieurs modernes* (1887); H. B. Wheatley, *Remarkable Bindings in the British Museum* (1889); J. W. Zaehnsdorf, *The Art of Bookbinding* (1880). (C. D.)

BOOKCASE, an article of furniture, forming a shelved receptacle, usually perpendicular or horizontal, for the storage of books. When books, being written by hand, were excessively

scarce, they were kept in small coffers which the great carried about with them on their journeys. As manuscript volumes accumulated in the religious houses or in regal palaces, they were stored upon shelves or in cupboards, and it is from these cupboards that the bookcase of to-day directly descends. At a somewhat later date the doors were, for convenience' sake, discarded, and the evolution of the bookcase made one step forward. Even then, however, the volumes were not arranged in the modern fashion. They were either placed in piles upon their sides, or if upright, were ranged with their backs to the wall and their edges outwards. The band of leather, vellum or parchment which closed the book was often used for the inscription of the title, which was thus on the fore-edge instead of on the back. It was not until the invention of printing had greatly cheapened books that it became the practice to write the title on the back and place the edges inwards. Early bookcases were usually of oak, which is still deemed to be the most appropriate wood for a stately library. The oldest bookcases in England are those in the Bodleian library at Oxford, which were placed in position in the last year or two of the 16th century; in that library are the earliest extant examples of shelved galleries over the flat wall-cases. Long ranges of book-shelves are necessarily somewhat severe in appearance, and many attempts have been made by means of carved cornices and pilasters to give them a more *richest* appearance—attempts which were never so successful as in the hands of the great English cabinet-makers of the second half of the 18th century.

Both Chippendale and Sheraton made or designed great numbers of bookcases, mostly glazed with little lozenges encased in fret-work frames often of great charm and elegance. The alluring grace of some of Sheraton's satinwood bookcases has very rarely indeed been equalled. The French cabinet-makers of the same period were also highly successful with small ornamental cases. Mahogany, rosewood, satinwood and even choicer exotic timbers were used; they were often inlaid with marqueterie and mounted with chased and gilded bronze. Dwarf bookcases were frequently finished with a slab of choice marble at the top. In the great public libraries of the 20th century the bookcases are often of iron, as in the British Museum where the shelves are covered with cowhide, of steel, as in the library of Congress at Washington, or of slate, as in the Fitzwilliam library at Cambridge. There are three systems of arranging bookcases—flat against the wall; in "stacks" or ranges parallel to each other with merely enough space between to allow of the passage of a librarian; or in bays or alcoves where cases jut out into the room at right angles to the wall-cases. The stack system is suitable only for public libraries where economy of space is essential; the bay system is not only handsome but utilizes the space to great advantage. The library of the city of London at the Guildhall is a peculiarly effective example of the bay arrangement.

The whole question of the construction and arrangement of bookcases was learnedly discussed in the light of experience by W. E. Gladstone in the *Nineteenth Century* for March 1890. (J. P.-B.)

BOOK-COLLECTING, the bringing together of books which in their contents, their form or the history of the individual copy possess some element of permanent interest, and either actually or prospectively are rare, in the sense of being difficult to procure. This qualification of rarity, which figures much too largely in the popular view of book-collecting, is entirely subordinate to that of interest, for the rarity of a book devoid of interest is a matter of no concern. On the other hand so long as a book (or anything else) is and appears likely to continue to be easily procurable at any moment, no one has any reason for collecting it. The anticipation that it will always be easily procurable is often unfounded; but so long as the anticipation exists it restrains collecting, with the result that Horn-books are much rarer than First Folio Shakespeares. It has even been laid down that the ultimate rarity of books varies in the inverse ratio of the number of copies originally printed, and though the generalization is a little sweeping, it is not far from the truth. To triumph over small difficulties being the chief element in games of skill, the

different varieties of book-collecting, which offer almost as many varieties of grades of difficulty, make excellent hobbies. But in its essence the pastime of a book-collector is identical with the official work of the curator of a museum, and thus also with one branch of the duties of the librarian of any library of respectable age. In its inception every library is a literary workshop, with more or less of a garden or recreation ground attached according as its managers are influenced by the humanities or by a narrow conception of utility. As the library grows, the books and editions which have been the tools of one generation pass out of use; and it becomes largely a depository or storehouse of a stock much of which is dead. But from out of this seemingly dead stock preserved at haphazard, critics and antiquaries gradually pick out books which they find to be still alive. Of some of these the interest cannot be reproduced in its entirety by any mere reprint, and it is this salvage which forms the literary museum. Book-collectors are privileged to leap at once to this stage in their relations with books, using the dealers' shops and catalogues as depositories from which to pick the books which will best fit with the aim or central idea of their collection. For in the modern private collection, as in the modern museum, the need for a central idea must be fully recognized. Neither the collector nor the curator can be content to keep a mere curiosity-shop. It is the collector's business to illustrate his central idea by his choice of examples, by the care with which he describes them and the skill with which they are arranged. In all these matters many amateurs rival, if they do not outstrip, the professional curators and librarians, and not seldom their collections are made with a view to their ultimate transference to public ownership. In any case it is by the zeal of collectors that books which otherwise would have perished from neglect are discovered, cared for and preserved, and those who achieve these results certainly deserve well of the community.

Whenever a high degree of civilization has been attained book-lovers have multiplied, and to the student with his modest *History* desire to read his favourite author in a well-written or well-printed copy there has been added a class of owners suspected of caring more for the externals of books than for the enjoyment to be obtained by reading them. But although adumbrations of it existed under the Roman empire and towards the end of the middle ages, book-collecting, as it is now understood, is essentially of modern growth. A glance through what must be regarded as the medieval text-book on the love of books, the *Philobiblon*, attributed to Richard de Bury (written in 1345), shows that it deals almost exclusively with the delights of literature, and Sebastian Brant's attack on the book-fool, written a century and a half later, demonstrates nothing more than that the possession of books is a poor substitute for learning. This is so obviously true that before book-collecting in the modern sense can begin it is essential that there should be no lack of books to read, just as until cups and saucers became plentiful there was no room for the collector of old china. Even when the invention of printing had reduced the cost of books by some 80%, book-collectors did not immediately appear. There is a natural temptation to imagine that the early book-owners, whose libraries have enriched modern collectors with some of their best-known treasures, must necessarily have been collectors themselves. This is far from being the case. Hardly a book of all that Jean Grollier (1479-1565) caused to be bound so tastefully for himself and his friends reveals any antiquarian instincts in its liberal owner, who bought partly to encourage the best printers of his day, partly to provide his friends with the most recent fruits of Renaissance scholarship. In England Archbishop Cranmer, Lords Arundel and Lumley, and Henry, prince of Wales (1504-1612), in France the famous historian Jacques Auguste de Thou (1553-1617), brought together the best books of their day in all departments of learned literature, put them into handsome leather jackets, and enriched them with their coats of arms, heraldic badges or other marks of possession. But they bought their books together for use and study, to be read by themselves and by the scholars who frequented their houses, and no evidence has been produced that they appreciated

what a collector might now call the points of a book other than its fine condition and literary or informational merits. Again, not a few other more or less famous men have been dubbed collectors on the score of a scanty shelf-full of volumes known to have been stamped with their arms. Collecting, as distinct both from the formation of working libraries and from casual ownership of this latter kind, may perhaps be said to have begun in England at the time of the antiquarian reaction produced by the book-massacres when the monasteries were dissolved by Henry VIII., and the university and college libraries and the parish service books were plundered and stript by the commissioners of Edward VI. To rescue good books from perishing is one of the main objects of book-collecting, and when Archbishop Parker and Sir Robert Cotton set to work to gather what they could of the scattered records of English statecraft and literature, and of the decorative art bestowed so lavishly on the books of public and private devotion, they were book-collectors in a sense and on a scale to which few of their modern imitators can pretend. Men of more slender purses, and armed with none of Archbishop Parker's special powers, worked according to their ability on similar lines. Humphrey Dyson, an Elizabethan notary, who collected contemporary proclamations and books from the early English presses, and George Thomason (d. 1666), the bookseller who bought, stored and catalogued all the pamphlet literature of the Civil War, were mindful of the future historians of the days in which they lived. By the end of the 17th century book-collecting was in full swing all over Europe, and much of its apparatus had come into existence. In 1676 book auctions were introduced into England from Holland, and soon we can trace in priced catalogues the beginning of a taste for Caxtons, and the books prized by collectors slowly fought their way up from amid the heavy volumes of theology by which they were at first overwhelmed.

While book-collecting thus came into existence it was rather as an added grace in the formation of a fine library than as a separate pursuit. Almost all the large book-buyers of the 16th, 17th and 18th centuries bought with a public object, or were rewarded for their zeal by their treasures being thought worthy of a public resting-place. Sir Thomas Smith (d. 1577) bequeathed his books to Queens' College, Cambridge; Archbishop Parker's were left under severe restrictions to Corpus Christi College in the same university; Sir Thomas Bodley refounded during his lifetime the university library at Oxford, to which also Laud gave liberally and Selden bequeathed his books. The library of Archbishop Williams went to St John's College, Cambridge; that of Archbishop Usher was bought for Trinity College, Dublin. The mathematical and scientific books of Thomas Howard, earl of Norfolk (d. 1646), were given by his grandson to the Royal Society; the heraldic collections of Ralph Sheldon (d. 1684) to Heralds' College; the library in which Pepys took so much pleasure to Magdalene College, Cambridge. Bishop Moore's books, including a little volume of Caxton quartos, almost all unique, were bought by George I. and presented to the university library at Cambridge. Archbishop Marsh, who had previously bought Stillingfleet's printed books (his manuscripts went to Oxford), founded a library at Dublin. The immense accumulations of Thomas Rawlinson (d. 1725) provided materials for a series of auctions, and Harley's printed books were sold to Osbourne the bookseller. But the trend was all towards public ownership. While Richard Rawlinson (d. 1755) allowed his brother's books to be sold, the best of his own were bequeathed to Oxford, and the Harleian MSS. were offered to the nation at a sum far below their value. A similar offer of the great collections formed by Sir Hans Sloane, including some 50,000 printed books, together with the need for taking better care of what remained of the Cotton manuscripts, vested in trustees for public use in 1702 and partially destroyed by fire in 1731, led to the foundation of the British Museum in 1753, and this on its opening in 1757 was almost immediately enriched by George II.'s gift of the old royal library, formed by the kings and queens of England from Henry VII. to Charles II., and by Henry, prince of Wales, son of James I., who had bought the books belonging to Archbishop Cranmer and Lords Arundel and Lumley. A few notable book-

buyers could not afford to bequest their treasures to libraries, e.g. Richard Smith, the secondary of the Poultry Cooper (d. 1675), at whose book-sale (1682) a dozen Caxtons sold for from 2s. to 18s. apiece, Dr Francis Bernard (d. 1698), Narcissus Luttrell (d. 1732) and Dr Richard Mead (d. 1754). At the opposite end of the scale, in the earls of Sunderland (d. 1722) and Pembroke (d. 1733), we have early examples of the attempts, seldom successful, of book-loving peers to make their libraries into permanent heirlooms. But as has been said, the drift up to 1760 was all towards public ownership, and the libraries were for the most part general in character, though the interest in typographical antiquities was already well marked.

When George III. came to the throne he found himself bookless, and the magnificent library of over 80,000 books and pamphlets and 440 manuscripts which he accumulated shows on a large scale the catholic and literary spirit of the book-lovers of his day. As befitted the library of an English king it was rich in English classics as well as in those of Greece and Rome, and the typographical first-fruits of Mainz, Rome and Venice were balanced by numerous works from the first presses of Westminster, London and Oxford. This noble library passed in 1823 to the British Museum, which had already received the much smaller but carefully chosen collection of the Rev. C. M. Cracherode (d. 1799), and in 1846 was further enriched by the wonderful library formed by Thomas Grenville, the last of its great book-loving benefactors, who died in that year, aged ninety-one. A few less wealthy men had kept up the old public-spirited tradition during George III.'s reign, Garrick bequeathing his fine collection of English plays and Sir Joseph Banks his natural history books to the British Museum, while Capell's Shakespearian treasures enriched Trinity College, Cambridge, and those of Malone went to the Bodleian library at Oxford, the formation of these special collections, in place of the large general library with a sprinkling of rarities, being in itself worth noting. But the noble book-buyers celebrated by the Rev. Thomas Frognall Dibdin in his numerous bibliographical works kept mainly on the old lines, though with aims less patriotic than their predecessors. The duke of Roxburgh's books were sold in 1812, and the excitement produced by the auction, more especially by the competition between Lord Spencer and the duke of Marlborough (at that time marquis of Blandford) for an edition of Boccaccio printed by Valdarfer at Venice in 1471, led to the formation of the Roxburgh Club at a commemorative dinner. In 1810 the duke of Marlborough's books were sold, and the Boccaccio for which he had paid £2260 went to Earl Spencer (d. 1834) for £750, to pass with the rest of his rare books to Mrs Rylands in 1892, and by her gift to the John Rylands library at Manchester in 1899. The books of Sir M. M. Sykes were sold in 1824, those of J. B. Inglis in 1826 (after which he collected again) and those of George Hibbert in 1829. The 150,000 volumes brought together by Richard Heber at an expense of about £100,000 were disposed of by successive sales during the years 1834-1837 and realized not much more than half their cost. The wonderful library of William Beckford (d. 1844), especially rich in fine bindings, bequeathed to his daughter, the duchess of Hamilton, was sold in 1882, with the Hamilton manuscripts, for the most part to the German government. Their dispersal was preceded in 1881 by that of the Sunderland collection, already mentioned. The library of Brian Fairfax (d. 1749), which had passed to the earls of Jersey, was sold in 1885, that of Sir John Thorold (d. 1815) in 1884, his "Gutenberg" Bible fetching £3900 and his Mainz Falter £4950. The great collection of manuscripts formed by Sir Thomas Phillipps (d. 1872) has furnished materials for numerous sales. The printed books of the earl of Ashburnham (d. 1878) kept the auctioneers busy in 1897 and 1898; his manuscripts were sold, some to the British government (the Stowe collection shared between the British Museum and Dublin), the German government (part of the Libri and Barrois collection, all, save one MS. of 13th century German ballads, resold to France), the Italian government (the rest of the Libri collection) Mr Yates Thompson (the MSS. known as the Appendix) and Mr J. Pierpont Morgan (the Lindau Gospels). The collections formed by Mr W. H. Miller (d. 1848, mainly English poetry), the

duke of Devonshire (d. 1858) and Mr Henry Huth (d. 1878), are still intact.

Among the book-buyers of the reign of George III., John Ratcliffe, an ex-coal-merchant, and James West had devoted themselves specially to Caxtons (of which the former possessed 48 and the latter 34) and the products of other early English presses. The collections of Capell and Garrick were also small and homogeneous. Each section, moreover, of some of the great libraries that have just been enumerated might fairly be considered a collection in itself, the union of several collections in the same library being made possible by the wealth of their purchaser and the small prices fetched by most classes of books in comparison with those which are now paid. But perhaps the modern cabinet theory of book-collecting was first carried out with conspicuous skill by Henry Perkins (d. 1855), whose 865 fine manuscripts and specimens of early printing, when sold in 1870, realized nearly £26,000. If surrounded by a sufficient quantity of general literature the collection might not have seemed noticeably different from some of those already mentioned, but the growing cost of books, together with difficulties as to house-room, combined to discourage miscellaneous buying on a large scale, and what has been called the "cabinet" theory of collecting, so well carried out by Henry Perkins, became increasingly popular among book buyers, alike in France, England and the United States of America. Henri Béraldi, in his catalogue of his own collection (printed 1892), has described how in France a little band of book-loving amateurs grew up who laughed at the *bibliophile de la vieille roche* as they disrespectfully called their predecessors, and prided themselves on the unity and compactness of their own treasures. In place of the miscellaneous library in which every class of book claimed to be represented, and which needed a special room or gallery to house it, they aimed at small collections which should epitomize the owner's tastes and require nothing bulkier than a neat bookcase or cabinet to hold them. The French bibliophiles whom M. Béraldi celebrated applied this theory with great success to collecting the dainty French illustrated books of the 18th century which were their especial favourites. In England Richard Fisher treated his fine examples of early book-illustration as part of his collection of engravings, etchings and woodcuts (illustrated catalogue printed 1879), and Frederick Locker (Locker-Lampson) formed in two small bookcases such a gathering of first editions of English imaginative literature that the mere catalogue of it (printed in 1886) produced the effect of a stately and picturesque procession. Some of the book-hoards of previous generations could have spared the equivalent of the Locker collection without seeming noticeably the poorer, but the compactness and unity of this small collection, in which every book appears to have been bought for a special reason and to form an integral part of the whole, gave it an artistic individuality which was a pleasant triumph for its owner, and excited so much interest among American admirers of Mr Locker's poetry that it may be said to have set a fashion. As another example of the value of a small collection, both for delight and for historical and artistic study, mention may be made of the little roomful of manuscripts and incunabula which William Morris brought together to illustrate the history of the bookish arts in the middle ages before the Renaissance introduced new ideals. Many living collectors are working in a similar spirit, and as this spirit spreads the monotony of the old libraries, in which the same editions of the same books recurred with wearisome frequency, should be replaced by much greater individuality and variety. Moreover, if they can be grouped round some central idea cheap books may yield just as good sport to the collector as expensive ones, and the collector of quite modern works may render admirable service to posterity. The only limitation is against books specially manufactured to attract him, or artificially made rare. A quite wholesome interest in contemporary first editions was brought to nought about 1889 by the booksellers beginning to board copies of Browning's *Asolando* and Mr Lang's *Blue Fairy Book* on the day of publication, while a graceful but quite minor poet was made ridiculous by £100 being asked for a set of his privately printed *opuscula*. The

petty gambling in books printed at the Kelmscott and Doves' presses, and in the fine paper copies of a certain *Life of Queen Victoria*, for which a premium of 250% was asked before publication, is another proof that until the manufacturing stage is over collecting cannot safely begin. But with this exception the field is open, and the 19th century offers as good a hunting ground as any of its predecessors.

While book-collecting may thus take an endless variety of forms the heads under which these may be grouped are few and fairly easily defined. They may be here briefly indicated together with some notes as to the literature which has grown up round them. The development of which bibliographical literature has taken is indeed very significant of the changed ideals of collectors. Brunet's *Manuel du libraire*, first published in 1810, attained its fifth edition in 1860-1864, and has never since been re-edited (supplement, 1878-1880). The *Bibliographer's Manual of English Literature* by W. T. Lowndes, first published in 1834, was revised by H. G. Bohn in 1857-1864, and of this also no further edition has been printed. These two works between them gave all the information the old-fashioned collectors required, the *Tresor de livres rares et précieux* by J. G. T. Graesse (Dresden, 1859-1867, supplementary volume in 1866) adding little to the information given by Brunet. The day of the omnivorous collector being past, the place of these general manuals has been taken by more detailed bibliographies and handbooks on special books, and though new editions of both Lowndes and Brunet would be useful to librarians and booksellers no publisher has had the courage to produce them.

To attract a collector a book must appeal to his eye, his mind or his imagination, and many famous books appeal to all three. A book may be beautiful by virtue of its binding, its illustrations or the simple perfection and harmony of its print and paper. The attraction of a fine binding has always been felt in France, the high prices quoted for Elzevirs and French first editions being often due much more to their 17th and 18th century jackets than to the books themselves. The appreciation of old bindings has greatly increased in England since the exhibition of them at the Burlington Fine Arts Club in 1891 (illustrated catalogue printed the same year), English blind stamped bindings, embroidered bindings, and bindings attributable to Samuel Mearene (*temp.* Charles II.) being much more sought after than formerly. (See BOOKBINDING.)

Illustrated books of certain periods are also much in request, and with the exception of a few which early celebrity has prevented becoming rare have increased inordinately in price. The primitive woodcuts in incunabula are now almost too highly appreciated, and while the *Nuremberg Chronicle* (1493) seldom fetches more than £30 or the *Hyperbomachia Poliphili* (Venice, 1499) more than £120, rarer books are priced in hundreds. The best books on the subject are: for Italy, Lippmann's *Wood Engraving in Italy in the 15th Century* (1888), Kristeller's *Early Florentine Woodcuts* (1897), the *duc de Rivoli's* (*Prince d'Essling's*) *Bibliographie des livres à figures vénitiens 1469-1525* (1892, new edition 1906); for Germany, Muther's *Die deutsche Bücherillustration der Gotik und Frührenaissance* (1884); for Holland and Belgium, Sir W. M. Conway's *The Woodcutters of the Netherlands in the 15th Century* (1884); for France the material will all be found in Claudin's *Histoire de l'imprimerie en France* (1900, &c.). Some information on the illustrated books of the early 16th century is given in Butsch's *Die Bücherornamentik der Renaissance* (1878), but the pretty French books of the middle of the century and the later Dutch and English copper-engraved book illustrations (for the latter see Colvin's *Early Engraving and Engravers in England*, 1905) have been imperfectly appreciated. This cannot be said of the French books of the 18th century chronicled by H. Cohen, *Guide de l'amateur de livre à grandes lettres du XVIII^e siècle* (5th ed., 1886), much of the same information, with a little more about English books, being given in Lewine's *Bibliography of Eighteenth Century Art and Illustrated Books* (1898). English books with coloured illustrations, for which there has arisen a sudden fashion, are well

described in Martin Hardie's *English Colour Books* (1906). Bewick's work has been described by Mr Austin Dobson.

Appreciation of finely printed books has seldom extended much beyond the 15th century. In addition to the works mentioned in the article on incunabula (*q.v.*), note may be made of Humphrey's *Masterpieces of the Early Printers and Engravers* (1870), while Lippmann's *Druckskriften des XV bis XVIII Jahrhunderts* (1884-1887) covers, though not very fully, the later period.

Among books which make an intellectual appeal to the collectors may be classed all works of historical value which have not been reprinted, or of which the original editions are more authentic, or convincing, than modern reprints. It is evident that these cover a vast field, and that the collector in taking possession of any corner of it is at once the servant and rival of historical students. Lord Crawford's vast collections of English, Scottish and Irish proclamations and of papal bulls may be cited as capital instances of the work which a collector may do for the promotion of historical research, and the philological library brought together by Prince Lucien Bonaparte (*An Attempt at a Catalogue* by V. Collins, published 1894) and the Foxwell collection of early books on political economy (presented to the university of London by the Goldsmiths' Company) are two other instances of recent date. Much collecting of this kind is now being carried on by the libraries of institutes and societies connected with special professions and studies, but there is ample room also for private collectors to work on these lines.

Of books which appeal to a collector's imagination the most obvious examples are those which can be associated with some famous person or event. A book which has belonged to a king or queen (more especially one who, like Mary queen of Scots, has appealed to popular sympathies), or to a great statesman, soldier or poet, which bears any mark of having been valued by him, or of being connected with any striking incident in his life, has an interest which defies analysis. Collectors themselves have a natural tenderness for their predecessors, and a copy of a famous work is all the more regarded if its pedigree can be traced through a long series of book-loving owners. Hence the production of such works as *Great Book-Collectors* by Charles and Mary Elton (1893), *English Book-Collectors* by W. V. Fletcher (1902) and Guigard's *Novel armorial du bibliophile* (1890). Books condemned to be burnt, or which have caused the persecution of their authors, have an imaginative interest of another kind, though one which seems to have appealed more to writers of books than to collectors. As has already been noted, most of the books specially valued by collectors make a double or triple appeal to the collecting instinct, and the desire to possess first editions may be accounted for partly by their positive superiority over reprints for purposes of study, partly by the associations which they can be proved to possess or which imagination creates for them. The value set on them is at least to some extent fanciful. It would be difficult, for instance, to justify the high prices paid by collectors of the days of George III. for the first printed editions of the Greek and Latin classics. With few exceptions these are of no value as texts, and there are no possible associations by which they can be linked with the personality of their authors. It may be doubted whether any one now collects them save as specimens of printing, though no class of books which has once been prized ever sinks back into absolute obscurity. On the other hand the prestige of the first editions of English and French literary masterpieces has immensely increased. A first folio Shakespeare (1623) was in 1906 sold separately for £3000, and the MacGeorge copies of the first four folios (1623, 1632, 1663-1664 and 1685) fetched collectively the high price of £10,000. The quarto editions of Shakespeare plays have appreciated even more, several of these little books, once sold at 6d. apiece, having fetched over £1000, while the unknown and unique copy of the 1594 edition of *Titus Andronicus*, discovered in Sweden, speedily passed to an American collector for £2000. Information as to early editions of famous English books will be found in Lowndes' *Bibliographer's Manual*, in Hazlitt's *Handbook to the Popular Poetical and Dramatic Literature of Great Britain from the Invention of Printing to the Restorations*

(1867) and his subsequent *Collections and Notes* (1876-1903), and as to more recent books in Slater's *Early Editions*, a *bibliographical survey of the works of some popular modern authors* (1894), while French classics have found an excellent chronicler in Jules Le Petit (*Bibliographie des principales éditions originales d'écrivains français du XV^e au XVIII^e siècle*, 1888).

In most cases there is a marked falling off in the interest with which early editions other than the first are regarded, and consequently in the prices paid for them, though important changes in the text give to the edition in which they first occur some shadow of the prestige attaching to an original issue. One of the recognized byways of book-collecting, however, used to be the collection of as many editions as possible of the same work. When this result in the acquisition of numerous late editions of no value for the text its only usefulness would appear to be the index it may offer to the author's popularity. But in translations of the Bible, in liturgical works, and in editions published during the author's life the aid offered to the study of the development of the final text by a long row of intermediate editions may be very great.

Another instance in which imagination reinforces the more positive interest a book may possess is in the case of editions which can be connected with the origin, diffusion or development of printing. Piety suggests that book-lovers should take a special interest in the history of the art which has done so much for their happiness, and in this respect they have mostly shown themselves religious. The first book printed in any town is reasonably coveted by local antiquaries, and the desire to measure the amount and quality of the work of every early printer has caused the preservation of thousands of books which would otherwise have perished. (See *INCUNABULA*.)

The financial side of book-collecting may be studied in Slater's *Book-Prices Current*, published annually since 1887, and in Livingston's *American Book Prices Current*, and in the same author's *Auction Prices of Books* (1905). While largely influenced by fashion the prices given for books are never wholly unreasonable. They are determined, firstly by the positive or associative interest which can be found in the book itself, secondly by the infrequency with which copies come into the market compared with the number and wealth of their would-be possessors, and thirdly, except in the case of books of the greatest interest and rarity, by the condition of the copy offered in respect to completeness, size, freshness and absence of stains. (A. W. Po.)

BOOK-KEEPING, a systematic record of business transactions, in a form conveniently available for reference, made by individuals or corporations engaged in commercial or financial operations with a view to enabling them with the minimum amount of trouble and of dislocation to the business itself to ascertain at any time (1) the detailed particulars of the transactions undertaken, and (2) the cumulative effect upon the business and its financial relations to others. Book-keeping, sometimes described as a science and sometimes as an art, partakes of the nature of both. It is not so much a discovery as a growth, the crude methods of former days having been gradually improved to meet the changing requirements of business, and this process of evolution is still going on. The ideal of any system of book-keeping is the maximum of record combined with the minimum of labour, but as dishonesty has to be guarded against, no system of book-keeping can be regarded as adequate which does not enable the record to be readily verified as a true and complete statement of the transactions involved. Such a verification is called an audit, and in the case of public and other large concerns is ordinarily undertaken by professional accountants (*q.v.*). Where the book-keeping staff is large it is usually organized so that its members, to some extent at least, check each other's work, and to that extent an audit, known as a "staff audit" or "internal check," is frequently performed by the book-keeping staff itself.

Formerly, when credit was a considerably less important factor than now in commercial transactions, book-keeping was frequently limited to an account of receipts and payments of money; and in early times, before money was in use, to an account of the receipt and issue of goods of different kinds. Even now

what may be called the "cash system" of accounts is almost exclusively used by governments, local authorities, and charitable and other institutions; but in business it is equally necessary to record movements of credit, as a mere statement of receipts and payments of money would show only a part of the total number of transactions undertaken. As for practical purposes some limit must be placed upon the daily record of transactions, certain classes show only a record of cash receipts and payments, which must, when it is desired to ascertain the actual position of affairs, be adjusted by bringing into account those transactions which have not yet been completed by the receipt or payment of money. For instance, it is usual to charge customers with goods sold to them at the date when the sale takes place, and to give them credit for the amount received in payment upon the date of receipt (thus completely recording every phase of the transaction as and when it occurs); but in connexion (say) with wages it is not usual to give each workman credit for the services rendered by him from day to day, but merely to charge up the amounts, when paid, to a wages account, which thus at any date only shows the amounts which have actually been paid, and takes no cognisance of the sums accruing due. When, therefore, it is desired to ascertain the actual expenditure upon wages for any given period, it is necessary to allow for the payments made during that period in respect of work previously performed, and to add the value of work performed during the current period which remains unpaid. In the majority of businesses those accounts which deal with various forms of standing expenses are thus dealt with, and in consequence the record, as it appears from day to day, is *pro tanto* incomplete. Another very important series of transactions which is not included in the ordinary day-to-day record is that representing the loss gradually accruing by reason of waste, or depreciation, of assets or general equipment of the business; proper allowance for these losses must of course be made whenever it is desired to ascertain the true position of affairs.

The origin of book-keeping is lost in obscurity, but recent researches would appear to show that some method of keeping accounts has existed from the remotest times. Babylonian records have been found dating back as far as 2600 B.C., written with a stylus on small slabs of clay, and it is of interest to note (*Records of the Past*, xi. 89) that these slabs or tablets "usually contain impressions from cylinder seals, and nail marks, which were considered to be a man's natural seal," thus showing that the modern method of identifying criminals by finger prints had its counterpart in Babylonia some 4500 years ago. Egyptian records were commonly written on papyrus, and contemporary pictures show a scribe keeping account of the quantities of grain brought into and removed from the government store-houses. It will thus be seen that some form of book-keeping existed long before bound books were known, and therefore the more general term *accounting* would seem to be preferable—the more so as the most modern developments are in the direction of again abandoning the bound book in favour of loose or easily detached sheets of paper or card, thus capable of being rearranged as circumstances or convenience may dictate. Most of the earlier accounting records are in the nature of a mere narrative of events, which—however complete in itself—failed to fulfil the second requirement of an adequate system of book-keeping already referred to. Prior to the use of money nothing in this direction could of course well be attempted; but for a long time after its employment became general money values were recorded in Roman figures, which naturally did not lend themselves to ready calculation.

At the present time it may be generally stated that all book-keeping records are kept in three distinct columns, dealing respectively with the date of the transaction, its nature, and its money value. The earliest extant example of accounts so kept is probably a ledger in the Advocates' library at Edinburgh, dated 1697, which, it is of interest to note, is ruled by hand. Prior to that time, however, double-entry book-keeping had been in general use. The exact date of its introduction is unknown; but it was certainly not, as has been frequently stated, the

invention of Lucas de Bergo, in or about 1494. This, however, is the date of the first issue (at Venice) of a printed book entitled *Everything about Arithmetic, Geometry and Proportion*, by Luca Pacioli, which contains *inter alia* an explanation of book-keeping by double-entry as then understood; but in all probability, the system had then been in use for something like 200 years. It is perhaps unfortunate that from 1494 until comparatively recent times the literature of accounting has been provided by theorists and students, rather than by practical business men, and it may well be doubted, therefore, whether it accurately describes contemporary procedure. Another illusion which it is necessary to expose in the interests of truth is the value attached to *Jones's English System of Book-keeping by Single or Double Entry*, published at Bristol in 1796. Before publishing this book, E. T. Jones issued a prospectus, stating that he had patented an entirely new and greatly improved system, and that subscribers (at a guinea a copy) would be entitled to a special licence empowering them to put the new invention into practice in their own book-keeping. With this bait he secured thousands of subscribers, but so far as can be gathered his system was entirely without merit, and it is chiefly of interest as indicating the value, even then, of advertising.

It is impossible here to describe fully all the improvements that have been made in methods of accounting during recent years, but it is proposed to deal with the more important

Modern methods. of these improvements, after the general principles upon which all systems of book-keeping are based have been briefly described.

The centre of all book-keeping systems is the *ledger*, and it may be said that all other books are only kept as a matter of practical convenience—hence the name “subsidiary books” that is frequently applied thereto. Inasmuch, however, as the transactions are first recorded in these subsidiary books, and afterwards classified therefrom into the ledger, the names *books of entry* or *books of first entry* are often employed. Subsidiary books which do not form the basis of subsequent entries into the ledger, but are merely used for statistical purposes, are known as *statistical* or *auxiliary books*. In the early days of book-keeping the ledger comprised merely those accounts which it was thought desirable to keep accessible, and was not a complete record of all transactions. Thus in many instances records were only kept of transactions with other business houses, known as *personal accounts*. In the earliest examples transactions tending to reduce indebtedness were recorded in order of date, as they occurred underneath transactions recording the creation of the indebtedness; and the amount of the reduction was subtracted from the sum of the indebtedness up to that date. This method was found to be inconvenient, and the next step was to keep one account of the transactions recording the creation of indebtedness and another account (called the *contra account*) of those transactions reducing or extinguishing it. For convenience these two accounts were kept on opposite sides of the ledger, and thus was evolved the *Dr.* and *Cr.* account as at present in general use:—

Dr.			A.B.			Contra.			Cr.		
Date.	Narrative.	Amount.	Date.	Narrative.	Amount.	Date.	Narrative.	Amount.	Date.	Narrative.	Amount.
		£ s. d.						£ s. d.			

In this form of account all transactions creating indebtedness due from the person named therein to the business—that is to say, all benefits received by that person from the business—are recorded upon the left-hand, or *Dr.* side, and *per contra* all transactions representing benefits imparted by him, giving rise to a liability on the part of the business, are recorded upon the *Cr.* side. The account may run on indefinitely,

but as a matter of convenience is usually ruled off each time all indebtedness is extinguished, and also at certain periodical intervals, so that the state of the account may then be readily apparent.

A mere collection of *personal accounts* is, however, obviously a very incomplete record of the transactions of any business, and does not suffice to enable a statement of its financial position to be prepared. So at an early date other accounts were added to the ledger, recording the acquisition of and disposal of different classes of property, such accounts being generally known as *real accounts*. These accounts are kept upon the same principle as *personal accounts*, in that all expenditure upon the part of the business is recorded upon the *Dr.* side, and all receipts upon the *Cr.* side; the excess of the debit entries over the credit entries thus showing the value placed upon those assets that still remain the property of the business. With the aid of *personal* and *real accounts* properly written up to date, it is possible at any time to prepare a statement of assets and liabilities showing the financial position of a business, and the following is an example of such a statement, which shows also how the profit made by the business may be thus ascertained, assuming that the financial position at the commencement of the current financial period, and the movements of capital into and out of the business during the period, are capable of being ascertained.

STATE OF AFFAIRS AS AT 31ST DECEMBER 1906

Liabilities.		Assets.	
Trade Creditors . . .	£4,961 10 0	Fixtures, Furniture, &c. . .	£1,269 4 3
Bills Payable . . .	2,620 18 4	Stock on hand . . .	5,751 3 10
Balance, being excess of assets over liabilities (or "Capital") at this date, carried down	14,918 7 2	Trade Debtors . . .	3,842 7 9
	£22,500 15 6	Bills Receivable . . .	7,468 14 3
		Cash at Bank . . .	4,169 5 5
			£22,500 15 6
Amount of Capital on 1st Jan. 1906 . . .	£15,010 1 7	Balance brought down . . .	£14,918 7 2
Balance, being net profit for the year ended this date . . .	1,408 5 7	Amount drawn out of business during year ended this date . . .	1500 0 0
	£16,418 7 2		£16,418 7 2

The method of accounting hitherto described represents *single-entry*, which—albeit manifestly incomplete—is still very generally used by small business houses, and particularly by retail traders. Its essential weakness is that it provides no automatic check upon the clerical accuracy of the record, and should any mistake be made in the keeping of the books, or in the extraction therefrom of the lists of assets and liabilities, the statement of assets and liabilities and the profit or loss of the current financial period, will be incorrect to an equal extent. It was to avoid this obvious weakness of *single-entry* that the system of *double-entry* was evolved.

The essential principle of *double-entry* is that it constitutes a complete record of every business transaction, and as these transactions are invariably cross-dealings—involving simultaneously the receipt of a benefit by some one and the imparting of a benefit by some one—a complete record of transactions from both points of view necessitates an entry of equal amount upon debit and credit sides of the ledger. Hence it follows that, if the clerical work be correctly performed, the aggregate amount entered up upon the debit side of the ledger must at all times equal the aggregate amount entered up upon the credit side; and thus a complete list of all ledger balances will show an agreement of the total debit balances with the total credit balances. Such a list is called a *trial balance*, an example of which is given below. It should be observed, however, that the test supplied by the *trial balance* is a purely mechanical one, and does not prove the absolute accuracy of the ledger as

Single-entry accounts.

Double-entry.

a record of transactions. Thus transactions which have actually taken place may have been omitted from the books altogether, or they may have been recorded to the wrong accounts, or the money values attached to them may be incorrect; or, yet again, fictitious records may be entered

necessary to introduce into the ledger a third class of accounts, known as *impersonal* or *nominal accounts*. These accounts record the transferences of money, or of money's worth, which, so far from representing a mere reshuffling of assets and liabilities, involve an increase in or a reduction of the amount invested in the business, i.e. a profit or a loss. Transactions representing profits are recorded upon the *Cr.* side of nominal accounts, and those representing losses (including expenses) upon the *Dr.* side. This is consistent with the rules already laid down in connexion with real and nominal accounts, inasmuch as expenditure which does not result in the acquisition of an asset is a loss, whereas receipts which do not involve the creation of liabilities represent profits. All debit balances therefore that are not assets are losses, and *per contra* all credit balances that are not liabilities are profits. So that, inasmuch as double-entry provides *inter alia* a complete statement under suitable headings of all profits and all losses, it is possible by aggregating these results to deduce therefrom the net profit or loss of carrying on the business—and that by a method entirely distinct from that previously described in connexion with single-entry, thus constituting a valuable additional check. Taking the trial balance shown above, the following represent the *trading account*, *profit and loss account*, and *balance sheet* compiled therefrom. The trading account may be variously regarded as the account recording the movements of goods which represent the stock-in-trade, and as a preliminary to (or a subdivision of) the profit and loss account. The balance sheet is a statement of the assets and liabilities; but—inasmuch as, by transferring the balance of the profit and loss account to the capital account, it is possible to bring the latter account up to date and to show the credit balance representing the surplus of assets over liabilities to date—the balance sheet, instead of showing a difference, or a “balance,” representing what is *assumed to be* the amount of the capital to date, shows an absolute agreement of assets upon the one hand and of liabilities *plus* capital upon the other. The two sides of the account thus balance—hence the name.

TRIAL BALANCE, 31ST DECEMBER 1906

	Dr.	Cr.
1 Capital account		£15,010 1 7
5 Drawings	1,500 0 0	
20 Trade creditors		4,961 10 0
24 Fixtures, furniture, &c.	1,269 4 3	
27 Bills payable		2,620 18 4
40 Bad debts	71 4 2	
44 Stock 1st Jan. 1906	4,078 16 4	
50 Discounts allowed	975 3 3	
53 Trade debtors	3,842 7 9	
60 Discounts received		1,117 17 8
65 Wages and salaries	1,865 12 0	
75 Depreciation	141 0 5	
79 Rent, rates and taxes	1,242 13 8	
82 General expenses	1,087 8 0	
90 Bills receivable	7,468 14 3	
97 Purchases	44,731 2 10	
100 Sales		48,732 4 9
106 Cash at bank	4,169 5 5	
	£72,442 12 4	£72,442 12 4

in the ledger of transactions which have never taken place. A *trial balance* is thus no very adequate safeguard against fraud, nor does it bring to light mistakes in the monetary value attaching to the various transactions recorded. This last point is of especial importance, in that the monetary value of transactions may have been correctly recorded in the first instance, but owing to altered circumstances may have become inaccurate at a later date. This of course means that the altered circumstances constitute an additional “transaction” which has been omitted. It will be observed, therefore, that in order to complete the record of the transactions by double-entry, it has become

Dr.		TRADING ACCOUNT for the Year ended 31st December 1906		Cr.	
To Stock on hand, 1st Jan. 1906	£4,078 16 4	By Sales	£48,732 4 9		
„ Purchases	44,731 2 10	„ Stock on hand, 31st Dec. 1906	5,751 3 10		
„ Gross Profit, transferred to Profit and Loss account	5,673 9 5				
	£54,483 8 7		£54,483 8 7		

Dr.		PROFIT AND LOSS ACCOUNT for the Year ended 31st December 1906		Cr.	
To Rent, rates and taxes £1242 13 8		By Gross Profit as per Trading Account	£5673 9 5		
„ Salaries and wages 1865 12 0		„ Discount received	1117 17 8		
„ General expenses 1087 8 0					
	£4195 13 8				
„ Discounts allowed	975 3 3				
„ Bad debts	71 4 2				
„ Depreciation	141 0 5				
„ Net Profit for the year transferred to Capital account	1408 5 7				
	£6791 7 1		£6791 7 1		

Dr.		BALANCE SHEET as at 31st December 1906		Cr.	
To A. B., Capital account	£14,918 7 2	By Fixtures, furniture, &c.	£1,269 4 3		
„ Trade creditors	4,961 10 0	„ Stock on hand	5,751 3 10		
„ Bills payable	2,620 18 4	„ Trade debtors	3,842 7 9		
		„ Bills receivable	7,468 14 3		
		„ Cash at bank	4,169 5 5		
	£22,500 15 6		£22,500 15 6		

Dr.		A. B., CAPITAL ACCOUNT		Cr.	
1906. Dec. 31	To Drawings account	£1,500 0 0	1906. Jan. 1	By Balance from last account	£15,010 1 7
	„ Balance carried down	14,918 7 2	Dec. 31	„ Profit and Loss account, being net profit for the year ended this date	1,408 5 7
		£16,418 7 2			£16,418 7 2
			1907. Jan. 1	By Balance brought down	£14,918 7 2

In the foregoing example the customary method has been followed of deducting withdrawals of capital from the capital account and of adding profits thereto. Sometimes, however, the balance of the capital account remains constant, and the drawings and net profits are transferred to a separate account called *current account*. This plan is but rarely observed in the case of undertakings owned by individuals, or private firms, but is invariably adopted in connexion with joint-stock companies, although in such cases the name *appropriation of profit account* is generally employed.

Although it is now usual to employ several books of first-entry, in the case of comparatively small businesses one such book is sufficient for all purposes, in that it is practicable for one person to record all the transactions that take place as and when they occur. A book of this description is called the *journal*, and for many years represented the only book of first-entry employed in book-keeping. An example of the journal is given below. The entries appearing therein are such as would be necessary to prepare the trading and profit and loss accounts from the trial balance shown above, and to bring the capital account up to date.

In modern times, however, with the growth of business, it was soon found impracticable to keep one book of first-entry for all transactions, and accordingly it became necessary either to treat the journal as an intermediate book, in which the transactions might be brought together and focused as a preliminary to being recorded in the ledger, or else to split up the journal into numerous books of first-entry, each of which might in that case be employed for the record of a particular class of transaction. The first method has been generally adopted in the continental countries of Europe, as will be shown later on, whereas in Great Britain and in North America the latter method more generally obtains; that is, instead of having one journal in which all classes of transactions are recorded in the first instance, it is usual to employ several journals, as follows:—a *sales journal*, *sales book* or *day book*, to record particulars of goods sold; a *bought journal*,

now generally kept in sections. Thus the cash account and the bank account are frequently bound together in one separate book called the *cash book*, showing in parallel columns the movements of office cash and of cash at the bank, and by the addition

DAY BOOK 1906			
	Forward		£3761 7 8
	27th December.—		
471	A. Brown, 492 New Street, Walworth— 2 doz. V.C. port 31/- 1 " A.C. pale brandy 49/-	£3 2 0 2 9 0	
	28th December.—		5 11 0
216	Fredk. Newton, Farleigh House, Epsom— 1 gall. E. Pale sherry 13/6 2 doz. O.B. Heidsieck 1892 160/- 2 gall. P. Scotch 21/-	£0 13 6 16 0 0 2 2 0	18 15 6
408	Robert French, 214 High Road, Sutton— 6 doz. F. D. Pomard, 1899 30/- 1 " M.F. Margaux, 1893 66/- 2 " A. Niersteiner 24/-	£9 0 0 3 6 0 2 8 0	14 14 0
			£3800 8 2
			100

of a third column for discounts the necessity of keeping an additional book of first entry as a *discount journal* may also be avoided. Of late years, however, most businesses pay all moneys received into their bankers without deduction, and pay all accounts by cheque; the necessity of an account for office cash thus no longer exists, save in connexion with petty payments, which are recorded in a separate book called the *petty cash book*.

With regard to the remaining ledger accounts, personal accounts—which are the most numerous—are frequently separated from the real and nominal accounts, and are further subdivided so that customers' accounts are kept separate from the accounts of trade creditors. The customers' accounts are kept in a ledger (or, if need be, in several ledgers) called *sales ledgers*, or *sold ledgers*; while the accounts of trade creditors are similarly kept in *purchases ledgers* or *bought ledgers*. The nominal and real accounts, if together, are kept in what is called the *general ledger*; but this may be further subdivided into a *nominal ledger* and a *private ledger*. This last subdivision is, however, rarely made upon a scientific basis, for such accounts as the profit and loss account and trading account are generally kept in the private ledger although strictly speaking nominal accounts; while the bills receivable account and the bills payable account are generally kept in the nominal ledger, so as to reduce to a minimum the amount of clerical work in connexion with the private ledger, which is kept either by the principal himself or

JOURNAL 1906

Dec. 31		Dr.	Cr.
	Trading account	110	
	To Stock account	44	
	.. Purchases account	97	
		£48,809 19 2	£4,078 16 4
			44,731 2 10
"	Sales account	100	48,732 4 9
	Stock account	44	5,751 3 10
	To Trading account	110	54,483 8 7
"	Trading account	110	5,673 9 5
	To Profit and Loss account	129	5,673 9 5
"	Profit and Loss account	120	5,383 1 6
	To Rent, rates and taxes,	78	1,242 13 8
	.. Salaries and wages	65	1,865 12 0
	.. General expenses	82	1,087 8 0
	.. Discounts allowed	50	975 3 3
	.. Bad debts	40	71 4 2
	.. Depreciation	75	141 0 5
"	Discounts received	60	1,117 17 8
	To Profit and Loss account	120	1,117 17 8
"	Profit and Loss account	120	1,408 5 7
	To A.B., Capital account	1	1,408 5 7
"	A.B., Capital account	1	1,500 0 0
	To Drawings account	5	1,500 0 0
		£118,376 1 11	£118,376 1 11

invoice book or *purchases book*, to record particulars of goods purchased; a *returns inwards book*, to record particulars of goods sold but subsequently returned by customers; a *returns outwards book*, to record the like particulars with regard to goods purchased and subsequently returned; a *bills receivable book*, to record particulars of bills of exchange received from debtors; and a *bills payable book*, to record particulars of bills of exchange given to creditors.

With a view still further to split up the work, thus enabling a large staff to be simultaneously engaged, the ledger itself is

by his confidential employee. By the employment of *adjustment accounts*, which complete the double-entry record in each ledger, these various ledgers may readily be made self-balancing, thus enabling clerical errors to be localized and responsibility enforced.

Of recent years considerable attention has been devoted to further modifications of book-keeping methods with a view to reducing clerical work, increasing the speed with which results are available, and enabling them to be handled more quickly

and with greater certainty. *Tabular book-keeping* is a device to achieve one or more of these ends by the substitution of books ruled with numerous columns for the more usual form. The system may be applied either to books of first entry or to ledgers. As applied to books of first-entry it enables the same book to deal conveniently with more than one class of transaction; thus if the trading of a business is divided into several departments, by providing a separate column for the sales of each depart-

Tabular book-keeping.

computed; after which they are filed away in a form convenient for reference. Sometimes the process is carried a step further, and the original slips, filed away with suitable guide-cards indicating the nature of the account, themselves constitute the ledger record—which in such cases is to be found scattered over a number of sheets, one for each transaction, instead of, as in the case of the ordinary book ledger, a considerable number of transactions being recorded upon a single page. This adaptation of the slip system is impracticable except in cases where the transactions

Reference No.	Name of Debtor.	Amount due on 1st Oct. 1906.	Charges for Current Quarter.	Total Debit.	Date received.	Amount received.	Discounts.	Allowances.	Bad Debts.	Amount due on 31st Dec. 1906.	Remarks.
		£ s. d.	£ s. d.	£ s. d.		£ s. d.	£ s. d.	£ s. d.	£ s. d.	£ s. d.	

ment it is possible readily to arrive at separate totals for the aggregate sales of each, thus simplifying the preparation of *departmental trading accounts*. As applied to ledgers, the application of the system may be best described by the aid of the above example (the proceedings of the columns being given only), which shows how a very large number of personal accounts may be recorded upon a single opening of a ledger provided the number of entries to be made against each individual be few.

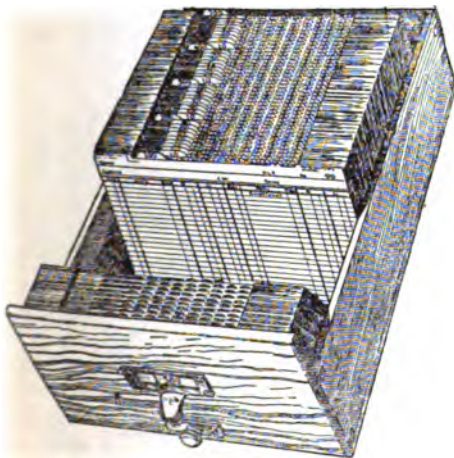

FIG. 1.—Card-Ledger Tray (Library Bureau System).

Another important application of modern methods consists of what may be described as the *slip system*, which is in many respects a reversion to the method of keeping records upon movable slabs or tablets, as in the Babylonian accounts referred to at the beginning of this article. This system may be applied to books of first-entry, or to ledgers, or to both. As applied to books of first-entry it aims at so modifying the original record of the transaction—whether it represents an invoice for goods sold or an acknowledgment given for money received—that a facsimile duplicate may be taken of the original entry by the aid of a carbon sheet, which instead of being immovably bound up in a book is capable of being handled separately and placed in any desired order or position, and thus more readily recorded in the ledger. Postings are thus made direct from the original slips, which have been first sorted out into an order convenient for that purpose, and afterwards re-sorted so that the total sales of each department may be readily

with each individual are few in number, and is not worth adoption unless the exceedingly large number of personal accounts makes it important as far as possible to avoid all duplication of clerical work. The more usual adaptation of the slip system to ledgers is to be found in the employment of *card ledgers* or *loose-leaf ledgers*. With card ledgers (fig. 1) each ledger account is upon an independent sheet of cardboard suitably arranged in drawers or cabinets. The system is advantageous as allowing all dead matter to be eliminated from the record continuously in use, and as permitting the order in which the accounts stand to be varied from time to time as convenience dictates, thus (if necessary) enabling the accounts to be always kept in alphabetical order in spite of the addition of new accounts and the dropping out of old ones. An especial convenience of the card system is that in times of pressure any desired number of book-keepers may be simultaneously employed, whereas the maximum number that can be usefully employed upon any bound book is two. The loose-leaf ledger (fig. 2) may be described as midway between

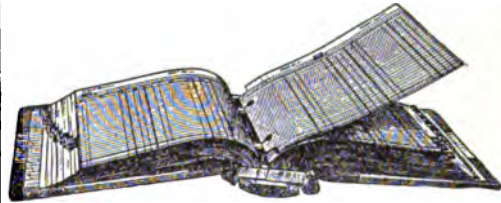

FIG. 2.—Loose-Leaf Ledger (Library Bureau System).

card and bound ledgers. It consists of a number of sheets in book form, so bound as to be capable of being readily separated when desired. The loose-leaf ledger thus embraces most of the advantages of the card ledger, while remaining sufficiently like the more old-fashioned book ledger as to enable it to be readily handled by those whose previous experience has been confined to the latter. Both the card and loose-leaf systems will be frequently found of value for records in connexion with cost and stores accounts, quite irrespective of their advantages in connexion with the book-keeping records pure and simple of certain businesses.

All book-keeping methods rest upon the same fundamental principles, but their development in practice in different countries is to some extent influenced by the manner in which business is there conducted, and by the legislative requirements imposed by the several states. In France traders are required by the Code of Commerce to keep three books—a journal, an inventory and a letter book, somewhat elaborate provisions being made to identify these books, and to prevent substitution. The compulsory journal makes the employment of numerous books of first-entry impossible without an undesirable amount of duplication, and wherever

Legislative requirements.

this provision obtains the book-keeping methods are in an accordingly comparatively backward state. The inventory book comprises periodical lists of ledger balances and the balance sheet, records which are invariably kept under every adequate system, although not always in a book specially set aside for that purpose. In Germany the statutory requirements are similar to those in France, save that the journal is not compulsory; but there is an additional provision that the accounts are to be kept in *bound* books with the pages numbered consecutively—a requirement which makes the introduction of card or loose-leaf ledgers of doubtful legality. A balance sheet must be drawn up every year; but where a stock-in-trade is from its nature or its size difficult to take, it is sufficient for an inventory to be taken every two years. In Belgium the law requires every merchant to keep a journal recording his transactions from day to day, which (with the balance book) must be initialled by a prescribed officer. All letters and telegrams received, and copies of all such sent, must be preserved for ten years. The Commercial Code of Spain requires an inventory, journal, ledger, letter book and invoice book to be kept; while that of Portugal prescribes the use of a balance book, journal, ledger and copy-letter book. The law of Holland requires business men to keep books in which are correctly recorded their commercial transactions, letters received and copies of letters sent. It also provides for the preparation of an annual balance sheet. The law of Rumania makes the employment of journal, inventory book and ledger compulsory, a small tax per page being charged on the two first named. There are no special provisions as to book-keeping contained in the Russian law, nor in the United States law, but in Russia public companies have to supply the government with copies of their annual accounts, which are published in a state newspaper, and in the United States certain classes of companies have to submit their accounts to an official audit. In general terms it may be stated that at the present time the employment of card and loose-leaf ledger systems is more general in the United States than in Great Britain.

Apart from the organizations of professional accountants, there is none of note devoted to the scientific study of book-keeping other than purely educational institutions. **Education.** Among the universities those in the United States were the first to include accounting as part of their curriculum; while in Great Britain the London School of Economics (university of London), the university of Birmingham, and the Victoria University of Manchester have, so far, alone treated the subject seriously and upon adequate lines. Quite recently Japan has been making a movement in the same direction, and other countries will doubtless follow suit. In England there have for a number of years past been various bodies—such for instance as the Society of Arts, the London Chamber of Commerce and Owens College, Manchester—which hold examinations in book-keeping and grant diplomas to successful candidates, while most of the polytechnics and technical schools give instruction in book-keeping; these latter, however, for the most part regard it as a "craft" merely.

AUTHORITIES.—Those interested in the bibliography of book-keeping are referred to the catalogue of the library of the Institute of Chartered Accountants in England and Wales, which probably contains the most complete collection in existence of ancient and modern works on accounting, both British and foreign. The following short list comprises those most likely to be found of general interest: G. van de Linde, *Book-keeping* (1898); L. R. Dicksee, *Book-keeping* (5th ed., 1906) and *Advanced Accounting* (2nd ed., 1905); *Encyclopaedia of Accounting*, ed. by G. Lisle (1903); *Accountants' Library*, ed. by the editor of *The Accountant* (1901); J. W. Hearn, *The Antiquity of Book-keeping* (1898); *History of Accounting and Accountants*, ed. by R. Brown (1905). (L. R. D.)

BOOK-PLATES. The book-plate, or *ex-libris*, a printed label intended to indicate ownership in individual volumes, is nearly as old as the printed book itself. It bears very much the same relation to the hand-painted armorial or otherwise symbolical personal device found in medieval manuscripts that the printed page does to the scribe's work. The earliest known examples of book-plates are German. According to Friedrich Warnecke, of Berlin (one of the best authorities on the subject), the oldest

movable *ex-libris* are certain woodcuts representing a shield of arms supported by an angel (fig. 1), which were pasted in books



FIG. 1.—Gift-plate of Hildebrand Brandenburg of Biberach to the Monastery of Buxheim (c. 1480).

presented to the Carthusian monastery of Buxheim by Brother Hildebrand Brandenburg of Biberach, about the year 1480—the date being fixed by that of the recorded gift. The woodcut, in imitation of similar devices in old MSS., is hand-painted. In France the most ancient *ex-libris* as yet discovered is that of one Jean Bertaud de la Tour-Blanche, the date of which is 1529;



*N. Bacon eques auratus & magni
sigilli Angliae Custos librum hunc bi-
bliothecae Cantabrig. dicauit.*

1574.

FIG. 2.—Book-plate of Sir Nicholas Bacon (slightly reduced), and in England that of Sir Nicholas Bacon, a gift-plate for the books he presented to the university of Cambridge (fig. 2).

Holland comes next with the plate of a certain Anna van der Aa, in 1597; then Italy with one attributed to the year 1622. The earliest known American example is the plain printed label of one John Williams, 1679.

A sketch of the history of the book-plate, either as a minor work of symbolical and decorative art, or as an accessory to the binding of books, must obviously begin in Germany, not only because the earliest examples known are German, but also because they are found in great numbers long before the fashion spread to other countries, and are often of the highest artistic interest. Albrecht Dürer is known to have actually engraved at least six plates (some of very important size) between 1503 and 1510 (fig. 3), and to have supplied designs for many others. Several notable plates are ascribed to Lucas Cranach and to Hans Holbein, and to that bevy of so-called Little Masters, the



FIG. 3.—Book-plate of Lazarus Spengler, by Albrecht Dürer, 1515 (reduced).

Behams, Virgil Solis, Matthias Zundt, Jost Amman, Saldörfer, Georg Hüpschmann and others. The influence of these draughtsmen over the decorative styles of Germany has been felt through subsequent centuries down to the present day, notwithstanding the invasion of successive Italian and French fashions during the 17th and 18th centuries, and the marked effort at originality of composition observable among modern designers. The heavy, over-elaborated German style never seems to have affected neighbouring countries; but since it was undoubtedly from Germany that was spread the fashion of ornamental book-plates as marks of possession, the history of German *ex-libris* remains on that account one of high interest to all those who are curious in the matter.

It was not before the 17th century that the *movable ex-libris* became tolerably common in France. Up to that time the more hurried habit of stamping the cover with a personal device had been in such general favour with book-owners as to render the use of labels superfluous. From the middle of the century, however, the *ex-libris* proper became quite naturalized; examples of that period are very numerous, and, as a rule, are very hand-

some. It may be here pointed out that the expression *ex-libris*, used as a substantive, which is now the recognized term for book-plate everywhere on the continent, found its origin in France. The words only occur in the personal tokens of other nationalities long after they had become a recognized inscription on French labels.

In many ways the consideration of the English book-plate, in its numerous styles, from the late Elizabethan to the late Victorian period, is peculiarly interesting. In all its varieties it reflects with great fidelity the prevailing taste in decorative art at different epochs. Of English examples, none thus far seems to have been discovered of older date than the gift-plate of Sir Nicholas Bacon; for the celebrated, gorgeous, hand-painted armorial device attached to a folio that once belonged to Henry VIII., and now reposes in the King's library, British Museum, does not come under the head of book-plate in its modern sense. The next is that of Sir Thomas Tresham, dated 1585. Until the last quarter of the 17th century the number of authentic English plates is very limited. Their composition is always remarkably simple, and displays nothing of the German elaborateness. They are as a rule very plainly armorial, and the decoration is usually limited to a symmetrical arrangement of mantling, with an occasional display of palms or wreaths. Soon after the Restoration, however, a book-plate seems to have suddenly become an established accessory to most well-ordered libraries. Book-plates of that period offer very distinctive characteristics. In the simplicity of their heraldic arrangements they recall those of the previous age; but their physiognomy is totally different. In the first place, they invariably display the tincture lines and dots, after the method originally devised in the middle of the century by Petra Sancta, the author of *Tesseræ Geniūtiae*, which by this time had become adopted throughout Europe. In the second, the mantling assumes a much more elaborate appearance—one that irresistibly recalls that of the perwig of the period—surrounding the face of the shield. This style was undoubtedly imported from France, but it assumed a character of its own in England. As a matter of fact, thenceforth until the dawn of the French Revolution, English modes of decoration in book-plates, as in most other chattels, follow at some years' distance the ruling French taste. The main characteristics of the style which prevailed during the Queen Anne and early Georgian periods are:—ornamental frames suggestive of carved oak, a frequent use of fish-scales, trellis or diapered patterns, for the decoration of plain surfaces; and, in the armorial display, a marked reduction in the importance of the mantling. The introduction of the scallop-shell as an almost constant element of ornamentation gives already a foretaste of the *Rocaille-Coquille*, the so-called Chippendale fashions of the next reign. As a matter of fact, during the middle third of the century this rococo style (of which the Convers plate [fig. 4] gives a tolerably typical sample) affects the book-plate as universally as all other decorative objects. Its chief element is a fanciful arrangement of scroll and shell work with curveting acanthus-like sprays—an arrangement which in the examples of the best period is generally made asymmetrical in order to give freer scope for a variety of countercurves. Straight or concentric lines and all appearances of flat surface are studiously avoided; the helmet and its symmetrical mantling tends to disappear, and is replaced by the plain crest on a fillet. The earlier examples of this manner are tolerably ponderous and simple. Later, however, the composition becomes exceedingly light and complicated; every conceivable and often incongruous element of decoration is introduced, from cupids to dragons, from flowerets to Chinese pagodas. During the early part of George III.'s reign there is a return to greater sobriety of ornamentation, and a style more truly national, which may be called the *urn style*, makes its appearance. Book-plates of this period have invariably a physiognomy which at once recalls the decorative manner made popular by architects and designers such as Chambers, the Adams, Josiah Wedgwood, Hepplewhite and Sheraton. The shield shows a plain spade-like outline, manifestly based upon that of the pseudo-classic urn then so much to the fore. The

ornamental accessories are symmetrical palms and sprays, wreaths and ribbands. The architectural boss is also an important factor. In many plates, indeed, the shield of arms takes quite a subsidiary position by the side of the predominantly architectural urn. From the beginning of the 19th century, until



FIG. 4.—Book-plate of P. A. Convers, 1762.

comparatively recent days, no special style of decoration seems to have established itself. The immense majority of examples display a plain shield of arms with motto on a scroll below, and crest on a fillet above. Of late years, however, a rapid impetus appears to have been given to the designing of *ex-libris*; a new era, in fact, has begun for the book-plate, one of great interest.

The main styles of decoration (and these, other data being

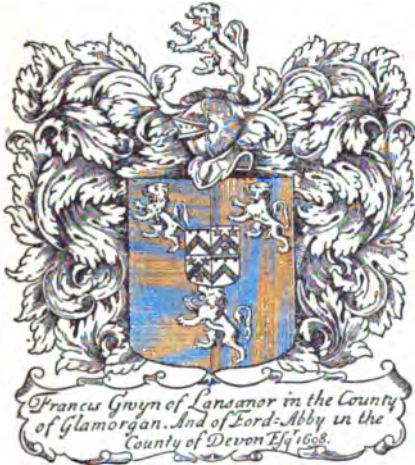

FIG. 5.—Book-plate of Francis Gwyn of Lansanor, 1698.

absent, must always in the case of old examples remain the criteria of date) have already been noticed. It is, however, necessary to point out that certain styles of composition were also prevalent at certain periods. Many of the older plates (like the majority of the most modern ones) were essentially pictorial.

Of this kind the best-defined English genus may be recalled: *the library interior*—a term which explains itself—and *book-piles*, exemplified by the *ex-libris* (fig. 6) of W. Hewer, Samuel Pepys's secretary. We have also many *portrait-plates*, of which, perhaps, the most notable are those of Samuel Pepys himself and of John Gibbs, the architect; *allegories*, such as were engraved by Hogarth, Bartolozzi, John Pine and George Vertue; *landscape-plates*, by wood engravers of the Bewick school (see Plate), &c. In most of these the armorial element plays but a secondary part.

The value attached to book-plates, otherwise than as an object of purely personal interest, is comparatively modern. The study of and the taste for collecting these private tokens of book-ownership hardly date farther back than the year 1875. The first real impetus was given by the appearance of the *Guide to the Study of Book-Plates*, by Lord de Tabley (then the Hon. Leicester Warren) in 1880. This work, highly interesting from many points of view, established what is now accepted as the general classification of styles: *early armorial* (i.e. previous to Restoration, exemplified by the Nicholas Bacon plate); *Jacobean*, a somewhat misleading term, but distinctly understood to include



FIG. 6.—Book-plate of William Hewer, 1699.

the heavy decorative manner of the Restoration, Queen Anne and early Georgian days (the Lansanor plate, fig. 5, is typically Jacobean); *Chippendale* (the style above described as *rococo*, tolerably well represented by the French plate of Convers); *wreath and ribbon*, belonging to the period described as that of the urn, &c. Since then the literature on the subject has grown considerably. Societies of collectors have been founded, first in England, then in Germany and France, and in the United States, most of them issuing a journal or archives: *The Journal of the Ex-libris Society* (London), the *Archives de la société française de collectionneurs d'ex-libris* (Paris), both of these monthlies; the *Ex-libris Zeitschrift* (Berlin), a quarterly.

Much has been written for and against book-plate collecting. If, on the one hand, the more enthusiastic ex-librists (for such a word has actually been coined) have made the somewhat ridiculous claim of science for "ex-librisme," the bitter animadversion, on the other, of a certain class of intolerant bibliophiles upon the vandalism of removing book-plates from old books has at times been rather extravagant. Book-plates are undoubtedly very often of high interest (and of a value often far greater than the odd volume in which they are found affixed), either as specimens of bygone decorative fashion or as personal relics of well-known personages. There can be no

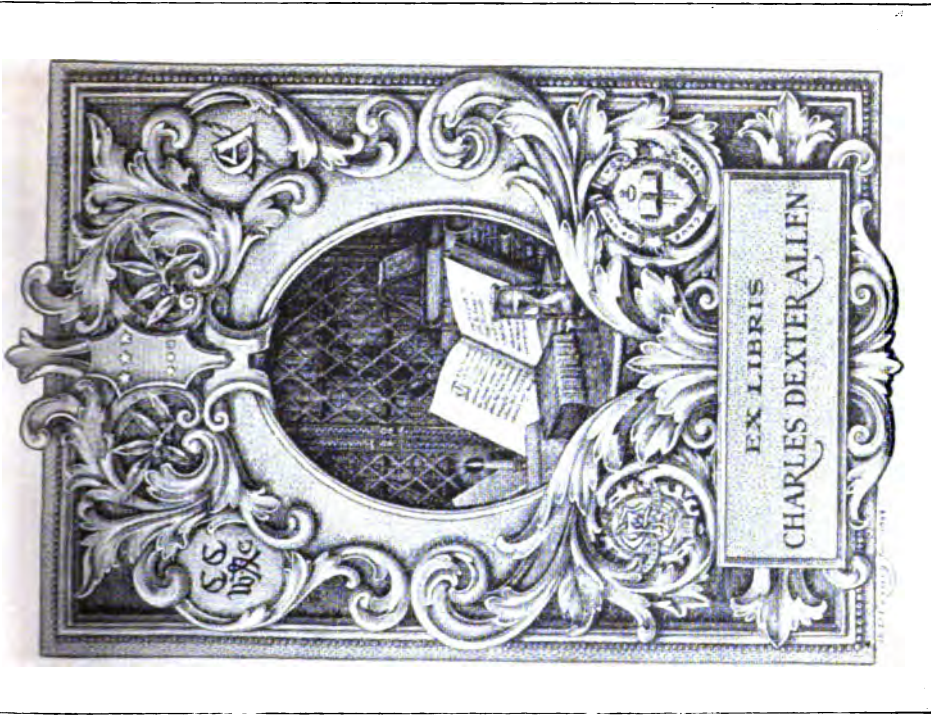

Book-plate of Charles Dexter Allen.
By E. D. French.



Book-plate of Robert Pinkney.
By Thomas Bewick.

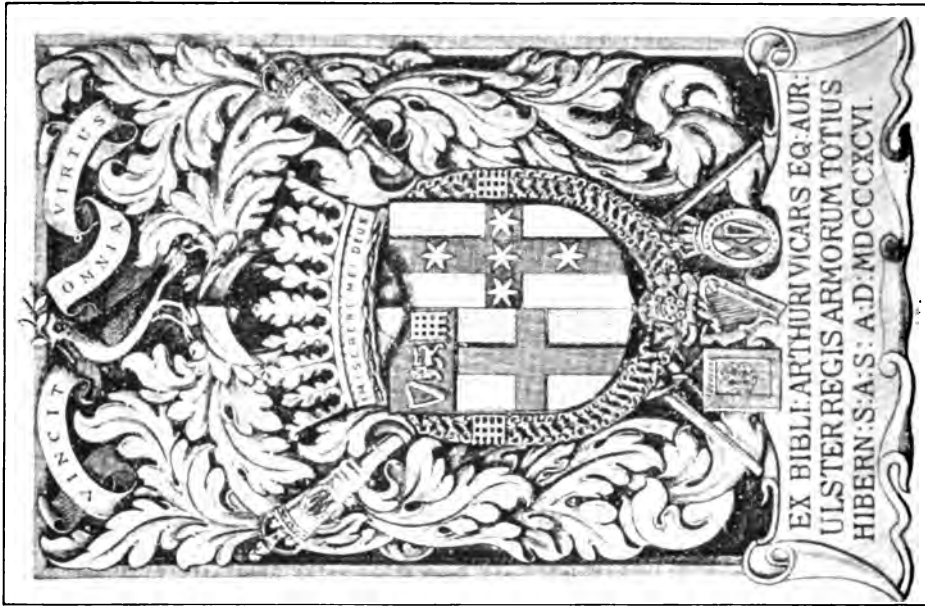

Book-plate of Sir Arthur Vicars.
By C. W. Sherborn.

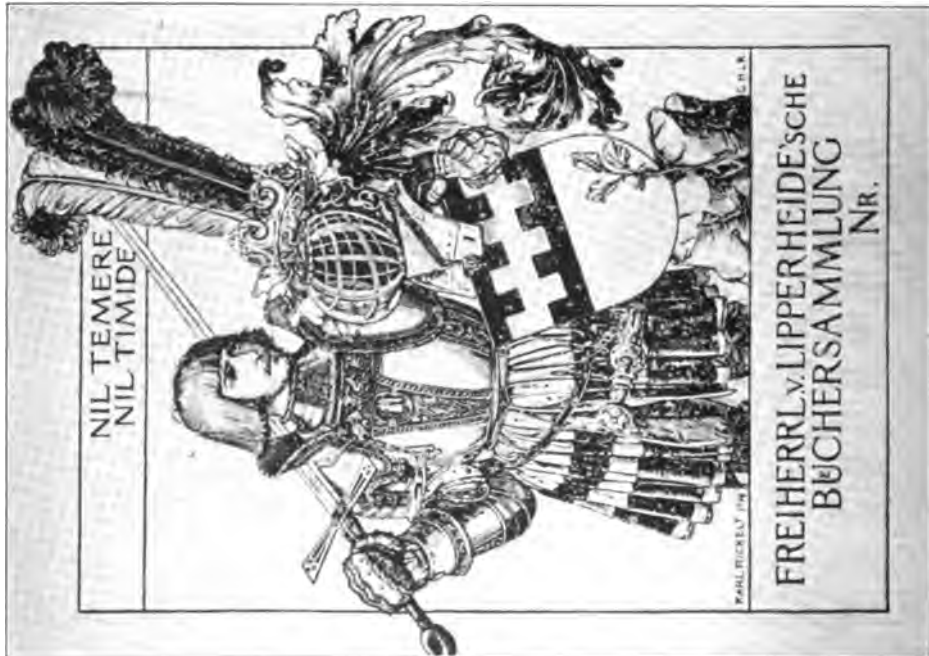

Book-plate of Freiherr v. Lipperheide.
By Karl Rickelt.

question, for instance, that engravings or designs by artists such as Holbein and Dürer and the Little Masters of Germany, by Charles Eisen, Hubert François Bourguignon, dit Gravelot, D. N. Chodowiecki or Simon Gribelin; by W. Marshall, W. Faithorne, David Loggan, Sir Robert Strange, Francesco Pisanetti; by Hogarth, Cipriani, Bartolozzi, John Keyse Sherwin, William Henshaw, Hewitt or Bewick and his imitators; or, to come to modern times, that the occasional examples traced to the handicraft of Thomas Stothard, Thackeray, Millais, Macise, Bell Scott, T. G. Jackson, Walter Crane, Caldecott, Stacy Marks, Edwin Abbey, Kate Greenaway, Gordon Brown, Herbert Railton, Aubrey Beardsley, Alfred Parsons, D. Y. Cameron, Paul Avril—are worth collecting.

Until the advent of the new taste the devising of book-plates was almost invariably left to the routine skill of the heraldic stationer. Of late years the composition of personal book-tokens has become recognized as a minor branch of a higher art, and there has come into fashion an entirely new class of designs which, for all their wonderful variety, bear as unmistakable a character as that of the most definite styles of bygone days. Broadly speaking, it may be said that the purely heraldic element tends to become subsidiary and the allegorical or symbolic to assert itself more strongly. Among modern English artists who have more specially paid attention to the devising of book-plates, and have produced admirable designs, may be mentioned C. W. Sherborn, G. W. Eve, Robert Anning Bell, J. D. Batten, Erat Harrison, J. Forbes Nixon, Charles Ricketts, John Vinycomb, John Leighton and Warrington Hogg. The development in various directions of process work, by facilitating and cheapening the reproduction of beautiful and elaborate designs, has no doubt helped much to popularize the book-plate—a thing which in older days was almost invariably restricted to ancestral libraries or to collections otherwise important. Thus the great majority of modern plates are reproduced by process. There are, however, a few artists left who devote to book-plates their skill with the graver. Some of the work they produce challenges comparison with the finest productions of bygone engravers. Of these the best-known are C. W. Sherborn (see Plate) and G. W. Eve in England, and in America J. W. Spenceley of Boston, Mass., K. W. F. Hopson of New Haven, Conn., and E. D. French of New York City (see Plate).

AUTHORITIES.—The curious in the matter of book-plate composition will find it treated in the various volumes of the *Ex-libris Series* (London). See also A. Poulet-Lafossé, *Les Ex-libris français* (1875); Hoa. J. Leicester Warren (Lord de Tabley), *A Guide to the Study of Book-plates* (1880); Sir A. W. Franks, *Notes on Book-plates, 1774-1800* (private, 1887); Friedrich Warnecke, *Die deutschen Bücherzeichen* (1899); Henri Bouchot, *Les Ex-libris et les marques de possession du livre* (1891); Egerton Castle, *English Book-plates* (1892); Walter Hamilton, *French Book-plates* (1892); *Dated Book-plates* (1895); H. W. Fincham, *Artists and Engravers of British and American Book-plates* (1897); *German Book-plates*, by Count K. E. zu Leiningen-Westerburg, translated by G. R. Denis (1901). (E. CA.)

BOOK-SCORPION, or **FALSE SCORPION**, minute arachnids superficially resembling tailless scorpions and belonging to the order Pseudoscorpiones of the class Arachnida. Occurring in all temperate and tropical countries, book-scorpions live for the most part under stones, beneath the bark of trees or in vegetable detritus. A few species, however, like the common British forms *Cheylex canescens* and *Chiridium muscorum*, frequent human dwellings and are found in books, old chests, furniture, &c.; others like *Gonyptus littoralis* and allied species may be found under stones or pieces of coral between tide-marks; while others, which are for the most part blind, live permanently in dark caves. Their food consists of minute insects or mites. It is possibly for the purpose of feeding on parasitic mites that book-scorpions lodge themselves beneath the wing-cases of large tropical beetles; and the same explanation, in default of a better, may be extended to their well-known and oft-recorded habit of seizing hold of the legs of horse-flies or other two-winged insects. For safety during hibernation and moulting, book-scorpions spin a small spherical cocoon. They are oviparous; and the eggs after being laid are carried about by the mother, attached to the lower surface of her body, the young remaining with their parent until

they have acquired their definite form and are able to shift for themselves. (R. I. P.)

BOOKSELLING. The trade in books is of a very ancient date. The early poets and orators recited their effusions in public to induce their hearers to possess written copies of their poems or orations. Frequently they were taken down *visu voce*, and transcripts sold to such as were wealthy enough to purchase. In the book of Jeremiah the prophet is represented as dictating to Baruch the scribe, who, when questioned, described the mode in which his book was written. These scribes were, in fact, the earliest booksellers, and supplied copies as they were demanded. Aristotle, we are told, possessed a somewhat extensive library; and Plato is recorded to have paid the large sum of one hundred minae for three small treatises of Philolaus the Pythagorean. When the Alexandrian library was founded about 300 B.C., various expedients were resorted to for the purpose of procuring books, and this appears to have stimulated the energies of the Athenian booksellers, who were termed *βιβλιοπωλάς*. In Rome, towards the end of the republic, it became the fashion to have a library as part of the household furniture; and the booksellers, *librarii* (Cic. *D. Leg.* iii. 20) or *bibliopolas* (Martial iv. 71, xiii. 3), carried on a flourishing trade. Their shops (*taberna librarii*, Cicero, *Phil.* ii. 9) were chiefly in the Argiletum, and in the Vicus Sandalarius. On the door, or on the side posts, was a list of the books on sale; and Martial (i. 118), who mentions this also, says that a copy of his First Book of Epigrams might be purchased for five denarii. In the time of Augustus the great booksellers were the Sosii. According to Justinian (ii. 1. 33), a law was passed securing to the scribes the property in the materials used; and in this may, perhaps, be traced the first germ of the modern law of copyright.

The spread of Christianity naturally created a great demand for copies of the Gospels and other sacred books, and later on for missals and other devotional volumes for church and private use. Benedict Biscop, the founder of the abbey at Wearmouth in England, brought home with him from France (671) a whole cargo of books, part of which he had "bought," but from whom is not mentioned. Passing by the intermediate ages we find that previous to the Reformation, the text writers or stationers (*stacyoneres*), who sold copies of the books then in use—the A B C, the Paternoster, Creed, Ave Maria and other MS. copies of prayers, in the neighbourhood of St Paul's, London,—were, in 1403, formed into a guild. Some of these "stacyoneres" had stalls or stations built against the very walls of the cathedral itself, in the same manner as they are still to be found in some of the older continental cities. In Henry Anstey's *Musings Academica*, published under the direction of the master of the rolls, we catch a glimpse of the "sworn" university bookseller or stationer, John More of Oxford, who apparently first supplied pupils with their books, and then acted the part of a pawnbroker. Anstey says (p. 77), "The fact is that they (the students) mostly could not afford to buy books, and had they been able, would not have found the advantage so considerable as might be supposed, the instruction given being almost wholly oral. The chief source of supplying books was by purchase from the university sworn stationers, who had to a great extent a monopoly. Of such books there were plainly very large numbers constantly changing hands." Besides the sworn stationers there were many booksellers in Oxford who were not sworn; for one of the statutes, passed in the year 1373, expressly recites that, in consequence of their presence, "books of great value are sold and carried away from Oxford, the owners of them are cheated, and the sworn stationers are deprived of their lawful business." It was, therefore, enacted that no bookseller except two sworn stationers or their deputies, should sell any book being either his own property or that of another, exceeding half a mark in value, under a pain of imprisonment, or, if the offence was repeated, of abjuring his trade within the university.

"The trade in bookselling seems," says Hallam, "to have been established at Paris and Bologna in the 12th century, the lawyers and universities called it into life. It is very improbable that it existed in what we properly call the dark ages. Peter of

Blois mentions a book which he had bought of a public dealer (*a quodam publico mangone librorum*); but we do not find many distinct accounts of them till the next age. These dealers were denominated *stationarii*, perhaps from the open stalls at which they carried on their business, though *statio* is a general word for a shop in low Latin. They appear, by the old statutes of the university of Paris, and by those of Bologna, to have sold books upon commission, and are sometimes, though not uniformly, distinguished from the *librarii*, a word which, having originally been confined to the copyists of books, was afterwards applied to those who traded in them. They sold parchment and other materials of writing, which have retained the name of stationery, and they naturally exercised the kindred occupations of binding and decorating. They probably employed transcribers; we find at least that there was a profession of copyists in the universities and in large cities."

The modern system of bookselling dates from soon after the introduction of printing. The earliest printers were also editors and booksellers; but being unable to sell every copy of the works they printed, they had agents at most of the seats of learning. Antony Koburger, who introduced the art of printing into Nuremberg in 1470, although a printer, was more of a bookseller; for, besides his own sixteen shops, we are informed by his biographers that he had agents for the sale of his books in every city of Christendom. Wynkyn de Worde, who succeeded to Caxton's press in Westminster, had a shop in Fleet Street.

The religious dissensions of the continent, and the Reformation in England under Henry VIII. and Edward VI., created a great demand for books; but in England neither Tudor nor Stuart could tolerate a free press, and various efforts were made to curb it. The first patent for the office of king's printer was granted to Thomas Berthelet by Henry VIII. in 1529, but only such books as were first licensed were to be printed. At that time even the purchase or possession of an unlicensed book was a punishable offence. In 1556 the Company of Stationers was incorporated, and very extensive powers were granted in order that obnoxious books might be repressed. In the following reigns the Star Chamber exercised a pretty effectual censorship; but, in spite of all precaution, such was the demand for books of a polemical nature, that many were printed abroad and surreptitiously introduced into England. Queen Elizabeth interfered but little with books except when they emanated from Roman Catholics, or touched upon her royal prerogatives; and towards the end of her reign, and during that of her pedantic successor, James, bookselling flourished. Archbishop Laud, who was no friend to booksellers, introduced many arbitrary restrictions; but they were all, or nearly all, removed during the time of the Commonwealth. So much had bookselling increased during the Protectorate that, in 1658, was published *A Catalogue of the most Vendible Books in England, digested under the heads of Divinity, History, Physic, &c., with School Books, Hebrew, Greek and Latin, and an Introduction, for the use of Schools*, by W. London. A bad time immediately followed. The Restoration also restored the office of Licensor of the Press, which continued till 1694.

In the first English Copyright Act (1709), which specially relates to booksellers, it is enacted that, if any person shall think the published price of a book unreasonably high, he may thereupon make complaint to the archbishop of Canterbury, and to certain other persons named, who shall thereupon examine into his complaint, and if well founded reduce the price; and any bookseller charging more than the price so fixed shall be fined £5 for every copy sold. Apparently this enactment remained a dead letter.

For later times it is necessary to make a gradual distinction between *booksellers*, whose trade consists in selling books, either by retail or wholesale, and *publishers*, whose business involves the production of the books from the author's manuscripts, and who are the intermediaries between author and bookseller, just as the booksellers (in the restricted sense) are intermediaries between the author and publisher and the public. The article on PUBLISHING (*q.v.*) deals more particularly with this second class, who, though originally booksellers, gradually took a higher

rank in the book-trade, and whose influence upon the history of literature has often been very great. The convenience of this distinction is not impaired by the fact either that a publisher is also a wholesale bookseller, or that a still more recent development in publishing (as in the instance of the direct sale in 1902, by the London Times, of the supplementary volumes to the 9th edition of the *Encyclopædia Britannica*, which were also "published" by *The Times*) started a reaction to some extent in the way of amalgamating the two functions. The scheme of *The Times Book Club* (started in 1905) was, again, a combination of a subscription library with the business of bookselling (see NEWSPAPERS); and it brought the organization of a newspaper, with all its means of achieving publicity, into the work of pushing the sale of books, in a way which practically introduced a new factor into the bookselling business.

During the 19th century it remains the fact that the distinction between publisher and bookseller—literary promoter and shop-keeper—became fundamental. The booksellers, as such, were engaged either in wholesale bookselling, or in the retail, the old or second-hand, and the periodical trades.

Coming between the publisher and the retail bookseller is the important distributing agency of the *wholesale bookseller*. It is to him that the retailer looks for his miscellaneous supplies, as it is simply impossible for him to stock one-half of the books published. In Paternoster Row, London, which has for over a hundred years been the centre of this industry, may be seen the collectors from the shops of the retail booksellers, busily engaged in obtaining the books ordered by the book-buying public. It is also through these agencies that the country bookseller obtains his miscellaneous supplies. At the leading house in this department of bookselling almost any book can be found, or information obtained concerning it. At one of these establishments over 1,000,000 books are constantly kept in stock. It is here that the publisher calls first on showing or "subscribing" a new book, a critical process, for by the number thus subscribed the fate of a book is sometimes determined.

What may be termed the third partner in publishing and its ramification is the *retail bookseller*; and to protect his interests there was established in 1890 a London booksellers' society, which had for its object the restriction of discounts to 25 %, and also to arrange prices generally and control all details connected with the trade. The society a few years afterwards widened its field of operations so as to include the whole of the United Kingdom, and its designation then became "The Associated Booksellers of Great Britain and Ireland."

The trade in old or (as they are sometimes called) second-hand books is in a sense no doubt, a higher class of business, requiring a knowledge of bibliography, while the transactions are with individual books rather than with numbers of copies. Occasionally dealers in this class of books replenish their stocks by purchasing remainders of books, which, having ceased from one cause or another to sell with the publisher, they offer to the public as bargains. The periodical trade grew up during the 19th century, and was in its infancy when the *Penny Magazine*, *Chambers's Journal*, and similar publications first appeared. The growth of this important part of the business was greatly promoted by the abolition of the newspaper stamp and of the duty upon paper, the introduction of attractive illustrations, and the facilities offered for purchasing books by instalments.

The history of bookselling in America has a special interest. The Spanish settlements drew away from the old country much of its enterprise and best talent, and the presses of Mexico and other cities teemed with publications mostly of a religious character, but many others, especially linguistic and historical, were also published. Bookselling in the United States was of a somewhat later growth, although printing was introduced into Boston as early as 1676, Philadelphia in 1685, and New York in 1693. Franklin had served to make the trade illustrious, yet few persons were engaged in it at the commencement of the 19th century. Books chiefly for scholars and libraries were imported from Europe; but after the second war printing-presses multiplied rapidly, and with the spread of newspapers and education there also arose a demand for books, and publishers set to work to secure the advantages offered by the wide field of English literature, the whole of which they had the liberty of reaping free of all cost beyond that of production. The works of Scott, Byron, Moore, Southey, Wordsworth, and indeed of every author of note, were reprinted without the smallest payment to author or proprietor. Half the names of the authors in the so-called "American" catalogue of books printed between 1820 and 1852 are British. By this means the works of the best

authors were brought to the doors of all classes in the cheapest variety of forms. In consequence of the Civil War, the high price of labour, and the restrictive duties laid on in order to protect native industry, coupled with the frequent intercourse with England, a great change took place, and American publishers and booksellers, while there was still no international copyright, made liberal offers for early sheets of new publications. Boston, New York and Philadelphia still retained their old supremacy as bookselling centres. Meanwhile, the distinct publishing business also grew, till gradually the conditions of business became assimilated to those of Europe.

In the course of the 16th and 17th centuries the Low Countries for a time became the chief centre of the bookselling world, and many of the finest folios and quartos in our libraries bear the names of Jansen, Blauw or Plantin, with the imprint of Amsterdam, Utrecht, Leiden or Antwerp, while the Elsevirs besides other works produced their charming little pocket classics. The southern towns of Douai and St Omer at the same time furnished polemical works in English.

Under PUBLISHING are noticed various further developments of this subject. Much interesting information on the history of the book trade will be found in Charles Knight's *Biography of William Caxton*, and in the same author's *Shadows of the Old Booksellers* (1865). See also Henry Curwen, *History of Booksellers* (1873); and Heinrich Lempertz, *Bilder-Hefte zur Geschichte des Bücherhandels* (Cologne, 1854).

BOOLE, GEORGE (1815-1864), English logician and mathematician, was born in Lincoln on the 2nd of November 1815. His father was a tradesman of limited means, but of studious character and active mind. Being especially interested in mathematical science, the father gave his son his first lessons; but the extraordinary mathematical powers of George Boole did not manifest themselves in early life. At first his favourite subject was classics. Not until the age of seventeen did he attack the higher mathematics, and his progress was much retarded by the want of efficient help. When about sixteen years of age he became assistant-master in a private school at Doncaster, and he maintained himself to the end of his life in one grade or other of the scholastic profession. Few distinguished men, indeed, have had a less eventful life. Almost the only changes which can be called events are his successful establishment of a school at Lincoln, its removal to Waddington; his appointment in 1849 as professor of mathematics in the Queen's College at Cork, and his marriage in 1855 to Miss Mary Everest, who, as Mrs Boole, afterwards wrote several useful educational works on her husband's principles.

To the public Boole was known only as the author of numerous abstruse papers on mathematical topics, and of three or four distinct publications which have become standard works. His earliest published paper was one upon the "Theory of Analytical Transformations," printed in the *Cambridge Mathematical Journal* for 1839, and it led to a friendship between Boole and D. F. Gregory, the editor of the journal, which lasted until the premature death of the latter in 1844. A long list of Boole's memoirs and detached papers, both on logical and mathematical topics, will be found in the *Catalogue of Scientific Memoirs* published by the Royal Society, and in the supplementary volume on *Differential Equations*, edited by Isaac Todhunter. To the *Cambridge Mathematical Journal* and its successor, the *Cambridge and Dublin Mathematical Journal*, Boole contributed in all twenty-two articles. In the third and fourth series of the *Philosophical Magazine* will be found sixteen papers. The Royal Society printed six important memoirs in the *Philosophical Transactions*, and a few other memoirs are to be found in the *Transactions of the Royal Society of Edinburgh* and of the *Royal Irish Academy*, in the *Bulletin de l'Académie de St-Petersbourg* for 1862 (under the name G. Boldt, vol. iv. pp. 198-215), and in *Crelle's Journal*. To these lists should be added a paper on the mathematical basis of logic published in the *Mechanic's Magazine* for 1848. The works of Boole are thus contained in about fifty scattered articles and a few separate publications.

Only two systematic treatises on mathematical subjects were completed by Boole during his lifetime. The well-known

Treatise on Differential Equations appeared in 1850, and was followed, the next year, by a *Treatise on the Calculus of Finite Differences*, designed to serve as a sequel to the former work. These treatises are valuable contributions to the important branches of mathematics in question, and Boole, in composing them, seems to have combined elementary exposition with the profound investigation of the philosophy of the subject in a manner hardly admitting of improvement. To a certain extent these works embody the more important discoveries of their author. In the 16th and 17th chapters of the *Differential Equations* we find, for instance, a lucid account of the general symbolic method, the bold and skilful employment of which led to Boole's chief discoveries, and of a general method in analysis, originally described in his famous memoir printed in the *Philosophical Transactions* for 1844. Boole was one of the most eminent of those who perceived that the symbols of operation could be separated from those of quantity and treated as distinct objects of calculation. His principal characteristic was perfect confidence in any result obtained by the treatment of symbols in accordance with their primary laws and conditions, and an almost unrivalled skill and power in tracing out these results.

During the last few years of his life Boole was constantly engaged in extending his researches with the object of producing a second edition of his *Differential Equations* much more complete than the first edition; and part of his last vacation was spent in the libraries of the Royal Society and the British Museum. But this new edition was never completed. Even the manuscripts left at his death were so incomplete that Todhunter, into whose hands they were put, found it impossible to use them in the publication of a second edition of the original treatise, and wisely printed them, in 1865, in a supplementary volume.

With the exception of Augustus de Morgan, Boole was probably the first English mathematician since the time of John Wallis who had also written upon logic. His novel views of logical method were due to the same profound confidence in symbolic reasoning to which he had successfully trusted in mathematical investigation. Speculations concerning a calculus of reasoning had at different times occupied Boole's thoughts, but it was not till the spring of 1847 that he put his ideas into the pamphlet called *Mathematical Analysis of Logic*. Boole afterwards regarded this as a hasty and imperfect exposition of his logical system, and he desired that his much larger work, *An Investigation of the Laws of Thought, on which are founded the Mathematical Theories of Logic and Probabilities* (1854), should alone be considered as containing a mature statement of his views. Nevertheless, there is a charm of originality about his earlier logical work which no competent reader can fail to appreciate. He did not regard logic as a branch of mathematics, as the title of his earlier pamphlet might be taken to imply, but he pointed out such a deep analogy between the symbols of algebra and those which can be made, in his opinion, to represent logical forms and syllogisms, that we can hardly help saying that logic is mathematics restricted to the two quantities, 0 and 1. By unity Boole denoted the universe of thinkable objects; literal symbols, such as x , y , z , v , u , &c., were used with the elective meaning attaching to common adjectives and substantives. Thus, if x =horned and y =sheep, then the successive acts of election represented by x and y , if performed on unity, give the whole of the class *horned sheep*. Boole showed that elective symbols of this kind obey the same primary laws of combination as algebraical symbols, whence it followed that they could be added, subtracted, multiplied and even divided, almost exactly in the same manner as numbers. Thus, $1-x$ would represent the operation of selecting all things in the world except *horned things*, that is, *all not horned things*, and $(1-x)(1-y)$ would give us *all things neither horned nor sheep*. By the use of such symbols propositions could be reduced to the form of equations, and the syllogistic conclusion from two premises was obtained by eliminating the middle term according to ordinary algebraic rules.

Still more original and remarkable, however, was that part of his system, fully stated in his *Laws of Thought*, which formed

a general symbolic method of logical inference. Given any propositions involving any number of terms, Boole showed how, by the purely symbolic treatment of the premises, to draw any conclusion logically contained in those premises. The second part of the *Laws of Thought* contained a corresponding attempt to discover a general method in probabilities, which should enable us from the given probabilities of any system of events to determine the consequent probability of any other event logically connected with the given events.

Though Boole published little except his mathematical and logical works, his acquaintance with general literature was wide and deep. Dante was his favourite poet, and he preferred the *Paradiso* to the *Inferno*. The metaphysics of Aristotle, the ethics of Spinoza, the philosophical works of Cicero, and many kindred works, were also frequent subjects of study. His reflections upon scientific, philosophical and religious questions are contained in four addresses upon *The Genius of Sir Isaac Newton*, *The Right Use of Leisure*, *The Claims of Science* and *The Social Aspect of Intellectual Culture*, which he delivered and printed at different times.

The personal character of Boole inspired all his friends with the deepest esteem. He was marked by the modesty of true genius, and his life was given to the single-minded pursuit of truth. Though he received a medal from the Royal Society for his memoir of 1844, and the honorary degree of LL.D. from the university of Dublin, he neither sought nor received the ordinary rewards to which his discoveries would entitle him. On the 8th of December 1864, in the full vigour of his intellectual powers, he died of an attack of fever, ending in suffusion on the lungs.

An excellent sketch of his life and works, by the Rev. R. Harley, F.R.S., is to be found in the *British Quarterly Review* for July 1866, No. 87. (W. S. J.)

BOOM, a word of Teutonic origin (cf. the Ger. *Baum*, tree, and the Eng. *beam*) for a pole, bar or barrier, used especially as a nautical term, for a long spar, used to extend a sail at the foot (main-boom, jib-boom, &c.). The "boom" of a cannon (note of a bell, cry of the bittern) is distinct from this, being onomatopoeic. In the sense of a barrier, a boom is generally formed of timber lashed together, or of chains, built across the mouth of a river or harbour as a means of defence. Possibly from the metaphor of a breaking boom, and the accompanying rush and roar, or from the rush of rising waters (mingled with the onomatopoeic use), "boom" began in America to be used of a sudden "spurt" or access of industrial activity, as in the phrase "a boom in cotton." Hence the verb "to boom," meaning to advertise or push into public favour.

BOOMERANG, a missile weapon of the Australian aborigines and other peoples. The word is taken from the native name used by a single tribe in New South Wales, and was mentioned in 1827 by Captain King as "the Port Jackson term" (*Nav. Surv. Coasts Austral.* i. 355). It has been erroneously connected with the *womera* or spear-thrower, and equally erroneously regarded as onomatopoeic—for it does not "boom" but whistles in the air. Two main types may be distinguished: (a) the return boomerang; (b) the non-return or war boomerang. Both types are found in most parts of Australia; the return form was, according to General Pitt-Rivers, used in ancient Egypt; and a weapon which has a close resemblance to the boomerang survives to the present day in North-East Africa, whence it has spread in allied forms made of metal (throwing knives). Among the Dravidians of South India is found a boomerang-shaped instrument which can be made to return. It is, however, still uncertain whether the so-called boomerangs of Egypt and India have any real resemblance to the Australian return boomerang. The Hopis (Moquis) of Arizona use a non-return form. The general form of both weapons is the same. They are sickle-shaped, and made of wood (in India of ivory or steel), so modelled that the thickness is about $\frac{1}{4}$ th of the breadth, which again is $\frac{1}{3}$ th of the length, the last varying from 6 in. to 3 or 4 ft. The return boomerang, which may have two straight arms at an angle of from 70° to 120°, but in Australia is always curved at an angle of 90° or more, is usually 2 to 3 ft. in length and weighs some 8 oz.;

the arms have a skew, being twisted 2° or 3° from the plane running through the centre of the weapon, so that B and D (fig. 1) are above it, A and E below it; the ends AB and DE are also to some extent raised above the plane of the weapon at C; the cross section is asymmetrical, the upper side in the figure being convex, the lower flat or nearly so; this must be thrown with the right hand. The non-return boomerang has a skew in the opposite direction but is otherwise similar.

The peculiarity of the boomerang's flight depends mainly on its skew. The return boomerang is held vertically, the concave side forward, and thrown in a plane parallel to the surface of the ground, as much rotation as possible being imparted to it. It travels straight for 30 yds. or more, with nearly vertical rotation; then it inclines to the left, lying over on the flat side and rising in the air; after describing a circle of 50 or more yards in diameter it returns to the thrower. Some observers state that it returns after striking the object; it is certainly possible to strike the ground without affecting the return. Throws of 100 yds. or more, before the leftward curve begins, can be accomplished by Australian natives, the weapon rising as much as 150 ft. in the air and circling five times before returning. The non-return type



FIG. 1.

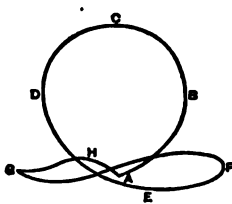

FIG. 2.—Flight in Horizontal Plane.

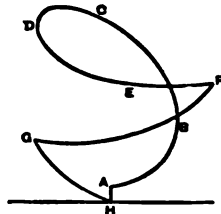

FIG. 3.—Flight in Vertical Plane.

may also be made to return in a nearly straight line by throwing it at an angle of 45°, but normally it is thrown like the return type, and will then travel an immense distance. No accurate measurements of Australian throws are available, but an English throw of 180 yds. has been recorded, compared with the same thrower's 70 yds. with the cricket ball.

The war boomerang in an expert's hand is a deadly weapon, and the lighter hunting boomerang is also effective. The return boomerang is chiefly used as a plaything or for killing birds, and is often as dangerous to the thrower as to the object at which it is aimed.

See Pitt-Rivers (Lane Fox) in *Anthropological and Archaeological Fragments*. "Primitive Warfare"; also in *Journ. Royal United Service Inst.* xii. No. 51; *British Ass. Report* (1872); *Catalogue of Bethnal Green Collection*, p. 28; Buchner in *Globus*, lxxxviii. pp. 63; G. T. Walker in *Phil. Trans.* cxc. 23; *Wide World Mag.* ii. 626; *Nature*, xiv. 248, lxiv. 338; Brough Smyth, *Aborigines of Victoria*, i. 310-329; Roth, *Ethnological Studies*. (N. W. T.)

BOONE, DANIEL (1734-1820), American pioneer and backwoodsman, of English descent, was born near the present city of Reading, Pennsylvania, on the 2nd of November (N.S.) 1734. About 1751 his father, Squire Boone, with his family settled in the Yadkin Valley in what is now Davie county, North Carolina, then on the frontier. Daniel worked on his father's farm, and spent much of his time hunting and trapping. In 1755 he served as a wagoner and blacksmith in Braddock's disastrous expedition against the Indians. In 1765 he visited Florida, and in 1767 he first visited the Kentucky region. With several companions, including John Finley, who had been there as early as 1752, he spent two years, 1769-1771, roaming about what is now Kentucky, meeting with numberless adventures, coming in conflict with roving bands of Indians, and collecting bear, beaver and deer skins. He served in Lord Dunmore's War (1774), and in 1775 led to Kentucky the party of settlers who founded Boonesborough, long an important settlement. On the 7th of February 1778 he

and the party he led, were captured by a band of Shawnees. He was adopted into the Shawnee tribe, was taken to Detroit, and on the return from that place escaped, reaching Boonesborough, after a perilous journey of 160 m., within four days, in time to give warning of a formidable attack by his captors. In repelling this attack, which lasted from the 8th to the 17th of September, he bore a conspicuous part. He also took part in the sanguinary "Battle of Blue Licks" in 1782. For a time he represented the settlers in the Virginia legislature (Kentucky then being a part of Virginia), and he also served as deputy surveyor, sheriff and county lieutenant of Fayette county, one of the three counties into which Kentucky was then divided. Having lost all his land through his carelessness in regard to titles, he removed in 1788 to Point Pleasant, Virginia (now W. Va.), whence about 1799 he removed to a place in what is now Missouri, about 45 m. west of St Louis, in territory then owned by Spain. He received a grant of 1000 arpents (about 8½ acres) of land, and was appointed syndic of the district. After the United States gained possession of "Louisiana" in 1803, Boone's title was found to be defective, and he was again dispossessed. He died on the 22nd of September 1820, and in 1845 his remains were removed to Frankfort, Kentucky, where a monument has been erected to his memory. Boone was a typical American pioneer and backwoodsman, a great hunter and trapper, highly skilled in all the arts of woodcraft, familiar with the Indians and their methods of warfare, a famous Indian fighter, restless, resourceful and fearless. His services, however, have been greatly over-estimated, and he was not, as is popularly believed, either the first to explore or the first to settle the Kentucky region.

The best biography is that by Reuben G. Thwaites, *Daniel Boone* (New York, 1902).

BOONE, a city and the county-seat of Boone county, Iowa, U.S.A., a short distance from the Des Moines river and near the centre of the state. Pop. (1890) 6500; (1900) 8880; (1905, state census) 9500 (1334 foreign-born); (1910) 10,347. It is served by the Chicago & North-Western (which has construction and repair shops here), the Chicago, Milwaukee & St Paul railways, and by the Fort Dodge, Des Moines & Southern (inter-urban) railway, which connects with Des Moines, Ames, &c. Boone is an important coal centre; bricks and tiles are manufactured from the clay obtained near by; there is a packing plant for the manufacture of beef and pork products; and from the rich farming section by which the city is surrounded come large quantities of grain, some of which is milled here, and live-stock. Boone was laid out in 1865, was incorporated as a town in 1866, and was chartered as a city in 1868.

BOONVILLE, a city and the county-seat of Cooper county, Missouri, U.S.A., on the right bank of the Missouri river, about 210 m. W. by N. of St Louis. Pop. (1890) 4141; (1900) 4377, including 1111 negroes; (1910) 4252. It is served by the Missouri Pacific, and the Missouri, Kansas & Texas railways. The city lies along a bluff about 100 ft. above the river. It is the seat of the Missouri training school for boys (1880), and of the Kemper military school (1844). Among its manufactures are earthenware, tobacco, vinegar, flour, farm-gates (iron), sash and doors, marble and granite monuments, carriages and bricks. Iron, zinc and lead are found in the vicinity, and some coal is mined. Boonville, named in honour of Daniel Boone, was settled in 1810, was laid out in 1817, incorporated as a village in 1839, and chartered as a city of the third class in 1806. Here on the 17th of June 1867, Captain (Major-General) Nathaniel Lyon, commanding about 2000 Union troops, defeated a slightly larger, but undisciplined Confederate force under Brigadier-General John S. Marmaduke. David Barton (d. 1837), one of the first two United States senators from Missouri, was buried here.

BOORDE (or **BORDE**), **ANDREW** (1490?–1549), English physician and author, was born at Boord's Hill, Holms Dale, Sussex. He was educated at Oxford, and was admitted a member of the Carthusian order while under age. In 1521 he was "dispensed from religion" in order that he might act as suffragan bishop of Chichester, though he never actually filled

the office, and in 1529 he was freed from his monastic vows, not being able to endure, as he said, the "rugorosity of your religion." He then went abroad to study medicine, and on his return was summoned to attend the duke of Norfolk. He subsequently visited the universities of Orleans, Poitiers, Toulouse, Montpellier and Wittenberg, saw the practice of surgery at Rome, and went on pilgrimage with others of his nation to Compostella in Navarre. In 1534 Boorde was again in London at the Charterhouse, and in 1536 wrote to Thomas Cromwell, complaining that he was in "thraldom" there. Cromwell set him at liberty, and after entertaining him at his house at Bishops Waltham in Hampshire, seems to have entrusted him with a mission to find out the state of public feeling abroad with regard to the English king. He writes to Cromwell from various places, and from Catalonia he sends him the seeds of rhubarb, two hundred years before that plant was generally cultivated in England. Two letters in 1535 and 1536 to the prior of the Charterhouse anxiously argue for his complete release from monastic vows. In 1536 he was studying medicine at Glasgow and gathering his observations about the Scots and the "devellyshe dysposicion of a Scottysch man, not to love nor favour an Englishe man." About 1538 Boorde set out on his most extensive journey, visiting nearly all the countries of Europe except Russia and Turkey, and making his way to Jerusalem. Of these travels he wrote a full itinerary, lost unfortunately by Cromwell, to whom it was sent. He finally settled at Montpellier and before 1542 had completed his *Fyrst Boke of the Introduction of Knowledge*, which ranks as the earliest continental guide book, his *Dietary* and his *Breviary*. He probably returned to England in 1542, and lived at Winchester and perhaps at Fevensey. John Ponet, bishop of Winchester, in an *Apology* against Bishop Gardiner, relates as matter of common knowledge that in 1547 Doctor Boord, a physician and a holy man, who still kept the Carthusian rules of fasting and wearing a hair shirt, was convicted in Winchester of keeping in his house three loose women. For this offence, apparently, he was imprisoned in the Fleet, where he made his will on the 9th of April 1549. It was proved on the 25th of the same month. Thomas Hearne (*Benedictus Abbas*, i p. 52) says that he went round like a quack doctor to country fairs, and therefore rashly supposed him to have been the original merry-andrew.

Andrew Boorde was no doubt a learned physician, and he has left two amusing and often sensible works on domestic hygiene and medicine, but his most entertaining book is *The Fyrst Boke of the Introduction of Knowledge. The whyche dothe teache a man to speake parte of all maner of languages, and to know the usage and fashion of all maner of countreys. And for to know the mooste parte of all maner of coynes of money, the whych is currant in every region. Made by Andrew Borde, of Physyche Doctor. Dedicated to the right honourable and gracious lady Mary daughter of our soverayne Lorde Kynge Henry the eyght (c. 1547)*. The Englishman describes himself and his foibles—his fickleness, his fondness for new fashions and his obstinacy—in lively verse. Then follows a geographical description of the country, followed by a model dialogue in the Cornish language. Each country in turn is dealt with on similar lines. His other authentic works are: *Here foloweth a Compendyous Regimente or Dyetary of health, made in Mountpyllor* (Thomas Colwell, 1562), of which there are undated and doubtless earlier editions; *The Breviary of Health* (1547?); *The Princyples of Astronomy* (1547?); "The Perigrination of Doctor Boord," printed by Thomas Hearne in *Benedictus Abbas Petroburgensis*, vol. ii. (1735); *A Pronostycacyon or an Almanache for the yere of our lorde MCCCCXXV. made by Andrew Boorde*. His *Itinerary of Europe and Treatyse upon Berdes* are lost. Several jest-books are attributed to him without authority—*The Merie Tales of the Mad Men of Golam* (earliest extant edition, 1630), *Scogin's Jestes* (1626), *A merry jest of the Mylner of Abyngton, with his wyfe, and his daughter, and of two poore scholers of Cambridge* (printed by Wynkyn de Worde), and a Latin poem, *Nos Vagabunduli*.

See Dr F. J. Furnivall's reprint of the *Introduction* and some other selections for the Early English Text Society (new series, 1870).

BOOS, MARTIN (1762-1825), German Roman Catholic theologian, was born at Huttenried in Bavaria on the 25th of December 1762. Orphaned at the age of four, he was reared by an uncle at Augsburg, who finally sent him to the university of Dillingen. There he laid the foundation of the modest piety by which his whole life was distinguished. After serving as priest in several Bavarian towns, he made his way in 1799 to Linz in Austria, where he was welcomed by Bishop Gall, and set to work first at Leonding and then at Waldneukirchen, becoming in 1806 pastor at Gallneukirchen. His pietistic movement won considerable way among the Catholic laity, and even attracted some fifty or sixty priests. The death of Gall and other powerful friends, however, exposed him to bitter enmity and persecution from about 1812, and he had to answer endless accusations in the consistorial courts. His enemies followed him when he returned to Bavaria, but in 1817 the Prussian government appointed him to a professorship at Düsseldorf, and in 1819 gave him the pastorate at Sayn near Neuweid. He died on the 29th of August 1825.

See *Life* by J. Gossner (1831).

BOOT. (1) (From the O. Eng. *bōt*, a word common to Teutonic languages, e.g. Goth. *bōta*, "good, advantage," O.H.G. *buosa*, Mod. Ger. *Busse*, "penance, fine"; cf. "better," the comparative of "good"), profit or advantage. The word survives in "bootless," i.e. useless or unavailing, and in such expressions, chiefly archaic, as "what boots it?" "Bote," an old form, survives in some old compound legal words, such as "house-bote," "fire-bote," "hedge-bote," &c., for particular rights of "estover," the Norman French word corresponding to the Saxon "bote" (see *ESTOVERS* and *COMMONS*). The same form survives also in such expressions as "thief-bote" for the Old English customary compensation paid for injuries.

(2) (A word of uncertain origin, which came into English through the O. Fr. *bote*, modern *botte*; Med. Lat. *botla* or *bota*), a covering for the foot. Properly a boot covers the whole lower part of the leg, sometimes reaching to or above the knee, but in common usage it is applied to one which reaches only above the ankle, and is thus distinguished from "shoe" (see *COSTUME* and *SROE*).

The "boot" of a coach has the same derivation. It was originally applied to the fixed outside step, the French *botte*, then to the uncovered spaces on or beside the step on which the attendants sat facing sideways. Both senses are now obsolete, the term now being applied to the covered receptacles under the seats of the guard and coachman.

THE BOOT, BOOTS or BOOTKIN was an instrument of torture formerly in use to extort confessions from suspected persons, or obtain evidence from unwilling witnesses. It originated in Scotland, but the date of its first use is unknown. It was certainly frequently employed there in the latter years of the 16th century. In a case of forgery in 1579 two witnesses, a clergyman and an attorney, were so tortured. In a letter dated 1583 at the Record Office in London, Walsingham instructs the English ambassador at Edinburgh to have Father Holt, an English Jesuit, "put to the boots." It seems to have fallen into disuse after 1630, but was revived in 1666 on the occasion of the Covenanters' rebellion, and was employed during the reigns of Charles II. and James II. Upon the accession of William III. the Scottish convention denounced "the use of torture, without evidence and in ordinary crimes, as contrary to law." However, a year or so later, one Neville Payne, an Englishman suspected of treasonable motives for visiting Scotland, was put to the torture under the authority of a warrant signed by the king. This is the last recorded case of its use, torture being finally abolished in Scotland in 1709. It was not used in England after 1640. The boot was made of iron or wood and iron fastened on the leg, between which and the boot wedges were driven by blows from a mallet. After each blow a question was put to the victim, and the ordeal was continued until he gave the information or fainted. The wedges were usually placed against the calf of the leg, but Bishop Burnet says that they were sometimes put against the shin-bone. A similar instrument, called "Spanish boots," was used in Germany.

There were also iron boots which were heated on the victim's foot. A less cruel form was a boot of buskin made wet and drawn upon the legs and then dried with fire.

BOOTES (Gr. *βούρως*, a ploughman, from *βοῦς*, an ox), a constellation of the northern hemisphere, mentioned by Eudoxus (4th century B.C.) and Aratus (3rd century B.C.), and perhaps alluded to in the book of Job (see *ARCTURUS*), and by Homer and Hesiod. The ancient Greeks symbolized it as a man walking, with his right hand grasping a club, and his left extending upwards and holding the leash of two dogs, which are apparently barking at the Great Bear. Ptolemy catalogues twenty-three stars, Tycho Brahe twenty-eight, Hevelius fifty-two. In addition to Arcturus, the brightest in the group, the most interesting stars of this constellation are: ϵ *Boötis*, a beautiful double star composed of a yellow star of magnitude 3, and a blue star of magnitude 6½; ξ *Boötis*, a double star composed of a yellow star, magnitude 4½, and a purple star, magnitude 6½; and *W. Boötis*, an irregularly variable star. This constellation has been known by many other names—Arcas, Arctophylax, Arcturus minor, Bubuleus, Bubulus, Canis latrans, Clamator, Icarus, Lycæon, Philometus, Plaustrici custos, Plorans, Thegnis, Vociferator; the Arabs termed it Aramech or Archamech; Hesychius named it Orion; Jules Schiller, St Sylvester; Schickard, Nimrod; and Weigelius, the Three Swedish Crowns.

BOOTH, BARTON (1681-1733), English actor, who came of a good Lancashire family, was educated at Westminster school, where his success in the Latin play *Andria* gave him an inclination for the stage. He was intended for the church; but in 1698 he ran away from Trinity College, Cambridge, and obtained employment in a theatrical company in Dublin, where he made his first appearance as Oroonoko. After two seasons in Ireland he returned to London, where Betterton, who on an earlier application had withheld his active aid, probably out of regard for Booth's family, now gave him all the assistance in his power. At Lincoln's Inn Fields (1700-1704) he first appeared as Maximus in *Valentinian*, and his success was immediate. He was at the Haymarket with Betterton from 1705 to 1708, and for the next twenty years at Drury Lane. Booth died on the 10th of May 1733, and was buried in Westminster Abbey. His greatest parts, after the title-part of Addison's *Cato*, which established his reputation as a tragedian, were probably Hotspur and Brutus. His *Lear* was deemed worthy of comparison with Garrick's. As the ghost in *Hamlet* he is said never to have had a superior. Among his other Shakespearian rôles were Mark Antony, Timon of Athens and Othello. He also played to perfection the gay Lothario in Rowe's *Fair Penitent*. Booth was twice married; his second wife, Hester Santlow, an actress of some merit, survived him.

See Cibber, *Lives and Characters of the most eminent Actors and Actresses* (1753); Victor, *Memoirs of the Life of Barton Booth* (1733).

BOOTH, CHARLES (1840-), English sociologist, was born at Liverpool on the 30th of March 1840. In 1862 he became a partner in Alfred Booth & Company, a Liverpool firm engaged in the Brazil trade, and subsequently chairman of the Booth Steamship Company. He devoted much time, and no inconsiderable sums of money, to inquiries into the statistical aspects of social questions. The results of these are chiefly embodied in a work entitled *Life and Labour of the People in London* (1891-1903), of which the earlier portion appeared under the title of *Life and Labour* in 1889. The book is designed to show "the numerical relation which poverty, misery and depravity bear to regular earnings and comparative comfort, and to describe the general conditions under which each class lives." It contains a most striking series of maps, in which the varying degrees of poverty are represented street by street, by shades of colour. The data for the work were derived in part from the detailed records kept by school-board "visitors," partly from systematic inquiries directed by Mr Booth himself, supplemented by information derived from relieving officers and the Charity Organization Society. Mr Booth also paid much attention to a kindred subject—the lot of the aged poor. In 1894 he published a volume of statistics on the subject, and, in 1891

and 1899, works on Old-age pensions, his scheme for the latter depending on a general provision of pensions of five shillings a week to all aged persons, irrespective of the cost to the state. He married, in 1871, the daughter of Charles Zachary Macaulay. In 1904 he was made a privy councillor.

BOOTH, EDWIN (THOMAS) (1833-1893), American actor, was the second son of the actor Junius Brutus Booth, and was born in Belair, Maryland, on the 13th of November 1833. His father (1796-1852) was born in London on the 1st of May 1796, and, after trying printing, law, painting and the sea, made his first appearance on the stage in 1813, and appeared in London at Covent Garden in 1815. He became almost at once a great favourite, and a rival of Kean, whom he was thought to resemble. To Kean's Othello nevertheless he played Iago on several occasions. Richard III., Hamlet, King Lear, Shylock and Sir Giles Overreach were his best parts, and in America, whither he removed in 1821, they brought him great popularity. His eccentricities sometimes bordered on insanity, and his excited and furious fencing as Richard III. and as Hamlet frequently compelled the Richmond and Laertes to fight for their lives in deadly earnest.

Edwin Booth's first regular appearance was at the Boston Museum on the 10th of September 1849, as Tressel to his father's Richard, in Colley Cibber's version of *Richard III.* He was lithe and graceful in figure, buoyant in spirits; his dark hair fell in waving curls across his brow, and his eyes were soft, luminous and most expressive. His father watched him with great interest, but with evident disappointment, and the members of the theatrical profession, who held the acting of the elder Booth in great reverence, seemed to agree that the genius of the father had not descended to the son. Edwin Booth's first appearance in New York was in the character of Willford in *The Iron Chest*, which he played at the National theatre in Chatham Street, on the 27th of September 1850. A year later, on the illness of the father, the son took his place in the character of Richard III. It was not until after his parent's death that the son conquered for himself an unassailable position on the stage. Between 1852 and 1856 he played in California, Australia and the Sandwich Islands, and those who had known him in the east were surprised when the news came that he had captivated his audiences with his brilliant acting. From this time forward his dramatic triumphs were warmly acknowledged. His Hamlet, Richard and Richelieu were pronounced to be superior to the performances of Edwin Forrest; his success as Sir Giles Overreach in *A New Way to Pay Old Debts* surpassed his father's. In 1862 he became manager of the Winter Garden theatre, New York, where he gave a series of Shakespearian productions of then unexampled magnificence (1864-1867), including *Hamlet*, *Othello* and *The Merchant of Venice*. The splendour of this period in his career was dashed for many months when in 1865 his brother, John Wilkes Booth, assassinated President Lincoln (see LINCOLN, ABRAHAM). The three Booth brothers, Junius Brutus (1821-1883), Edwin and John Wilkes (1839-1865), had played together in *Julius Caesar* in the autumn of the previous year—the performance being memorable both for its own excellence, and for the tragic situation into which two of the principal performers were subsequently hurled by the crime of the third. Edwin Booth did not reappear on the stage until the 3rd of January 1866, when he played Hamlet at the Winter Garden theatre, the audience showing by unstinted applause their conviction that the glory of the one brother would never be imperilled by the infamy of the other.

In 1868-1869 Edwin Booth built a theatre of his own—Booth's theatre, at the corner of 23rd Street and 6th Avenue, New York—and organized an excellent stock company, which produced *Romeo and Juliet*, *The Winter's Tale*, *Julius Caesar*, *Macbeth*, *Much Ado about Nothing*, *The Merchant of Venice* and other plays. In all cases Booth used the true text of Shakespeare, thus antedating by many years a similar reform in England. Almost invariably his ventures were successful, but he was of a generous and confiding nature, and his management was not economical. In 1874 the grand dramatic structure he had raised was taken from him, and with it went his

entire fortune. By arduous toil, however, he again accumulated wealth, in the use of which his generous nature was shown. He converted his spacious residence in Gramercy Park, New York, into a club—the Players'—for the elect of his profession, and for such members of other professions as they might choose. The house, with all his books and works of art, and many invaluable mementos of the stage, became the property of the club. A single apartment he kept for himself. In this he died on the 7th of June 1893. Among his parts were Macbeth, Lear, Othello, Iago, Shylock, Wolsey, Richard II., Richard III., Benedick, Petruccio, Richelieu, Sir Giles Overreach, Brutus (Payne's), Bertuccio (in Tom Taylor's *The Fool's Revenge*), Ruy Blas, Don Cesar de Bazan, and many more. His most famous part was Hamlet, for which his extraordinary grace and beauty and his eloquent sensibility peculiarly fitted him. He probably played the part oftener than any other actor before or since. He visited London in 1851, and again in 1880 and in 1882, playing at the Haymarket theatre with brilliant success. In the last year he also visited Germany, where his acting was received with the highest enthusiasm. His last appearance was in Brooklyn as Hamlet in 1891. Booth was twice married: in 1860 to Mary Devlin (d. 1863), and in 1869 to Mary F. McVicker (d. 1881). He left by his first wife one daughter, Edwina Booth Grossman, who published *Edwin Booth: Recollections* (New York, 1894).

Edwin Booth's prompt-books were edited by William Winter (1878). In a series of volumes, *Actors and Actresses of Great Britain and America*, edited by Lawrence Hutton and Brander Matthews, Edwin Booth contributed recollections of his father, which contain much valuable autobiographic material. For the same series Lawrence Barrett contributed an article on Edwin Booth. See also William Winter, *Life and Art of Edwin Booth* (1893); Lawrence Hutton, *Edwin Booth* (1893); Henry A. Clapp, *Reminiscences of a Dramatic Critic* (Boston, 1902); A. B. Clarke, *The Elder and the Younger Booth* (Boston, 1882). (J. J.')

BOOTH, WILLIAM (1829—), founder and "general" of the Salvation Army (q.v.), was born at Nottingham on the 10th of April 1829. At the age of fifteen his mind took a strongly religious turn, under the influence of the Wesleyan Methodists, in which body he became a local preacher. In 1849 he came to London, where, according to his own account, his passion for open-air preaching caused his severance from the Wesleyans. Joining the Methodist New Connexion, he was ordained a minister, but, not being employed as he wished in active "travelling evangelization," left that body also in 1861. Meanwhile he had (1855) married Miss Catherine Mumford, and had a family of four children. Both he and his wife occupied themselves with preaching, first in Cornwall and then in Cardiff and Walsall. At the last-named place was first organized a "Hallelujah band" of converted criminals and others, who testified in public of their conversion. In 1864 Booth went to London and continued his services in tents and in the open air, and founded a body which was successively known as the East London Revival Society, the East London Christian Mission, the Christian Mission and (in 1878) the Salvation Army. The Army operates (1) by outdoor meetings and processions; (2) by visiting public-houses, prisons, private houses; (3) by holding meetings in theatres, factories and other unusual buildings; (4) by using the most popular song-tunes and the language of everyday life, &c.; (5) by making every convert a daily witness for Christ, both in public and private. The army is a quasi-military organization, and Booth modelled its "Orders and Regulations" on those of the British army. Its early "campaigns" excited violent opposition, a "Skeleton Army" being organized to break up the meetings, and for many years Booth's followers were subjected to fine and imprisonment as breakers of the peace. Since 1889, however, these disorders have been little heard of. The operations of the army were extended in 1880 to the United States, in 1881 to Australia, and spread to the European continent, to India, Ceylon and elsewhere, "General" Booth himself being an indefatigable traveller, organizer and speaker. His wife (b. 1829) died in 1890. By her preaching at Gateshead, where her husband was circuit minister, in 1860, she began the women's ministry which is so prominent a feature of the army's work. A biography of her by Mr Booth Tucker appeared in 1892.

In 1890 "General" Booth attracted further public attention by the publication of a work entitled *In Darkest England, and the Way Out*, in which he proposed to remedy pauperism and vice by a series of ten expedients: (1) the city colony; (2) the farm colony; (3) the over-sea colony; (4) the household salvage brigade; (5) the rescue homes for fallen women; (6) deliverance for the drunkard; (7) the prison-gate brigade; (8) the poor man's bank; (9) the poor-man's lawyer; (10) Whitechapel-by-the-Sea. Money was liberally subscribed and a large part of the scheme was carried out. The opposition and ridicule with which Booth's work was for many years received gave way, towards the end of the 19th century, to very widespread sympathy as his genius and its results were more fully realized.

The active encouragement of King Edward VII., at whose instance in 1902 he was invited officially to be present at the coronation ceremony, marked the completeness of the change; and when, in 1905, the "general" went on a progress through England, he was received in state by the mayors and corporations of many towns. In the United States also, and elsewhere, his work was cordially encouraged by the authorities.

See T. F. Coates, *The Life Story of General Booth* (2nd ed., London, 1906), and bibliography under SALVATION ARMY.

BOOTH (connected with a Teutonic root meaning to dwell, whence also "bower"), primarily a temporary dwelling of boughs or other slight materials. Later the word gained the special meaning of a market stall or any non-permanent erection, such as a tent at a fair, where goods were on sale. Later still it was applied to the temporary structure where votes were registered, viz. polling-booth. Temporary booths erected for the weekly markets naturally tended to become permanent shops. Thus Stow states that the houses in Old Fish Street, London, "were at first but movable boards set out on market days to show their fish there to be sold; but procuring licence to set up sheds, they grew to shops, and by little and little, to tall houses." As *bothy* or *bothie*, in Scotland, meaning generally a hut or cottage, the word was specially applied to a barrack-like room on large farms where the unmarried labourers were lodged. This, known as the *Bothy system*, was formerly common in Aberdeenshire and other parts of northern Scotland.

BOOTHIA (*Boothia Felix*), a peninsula of British North America, belonging to Franklin district, and having an area of 13,100 sq. m., between 69° 30' and 71° 50' N. and 91° 30' and 97° W. Its northernmost promontory, Murchison Point, is also the northernmost point of the American mainland. It was discovered by Captain (afterwards Sir James) Ross, during his expedition of 1829-1833, and was named after Sir Felix Booth, who had been chiefly instrumental in fitting out the expedition. Boothia forms the western side of Boothia Gulf. From the main mass of the continent the peninsula is almost separated by lakes and inlets; and a narrow channel known as Bellot Strait intervenes between it and North Somerset Island, which was discovered by Sir E. Parry in 1819. The peninsula is not only interesting for its connexion with the Franklin expedition and the Franklin search, but is of scientific importance from the north magnetic pole having been first distinctly localized here by Ross, on the western side, in 70° 5' N., 96° 47' W.

Boothia Gulf separates the north-western portion of Baffin Land and Melville Peninsula from Boothia Peninsula. It is connected with Barrow Strait and Lancaster Sound by Prince Regent Inlet, with Franklin Strait by Bellot Strait, and with Fox Channel by Fury and Hecla Strait. The principal bays are Committee and Pelly in the southern portion, and Lord Mayor in the western.

BOOTLE, a municipal and county borough in the Bootle parliamentary division of Lancashire, England; at the mouth of the Mersey, forming a northern suburb of Liverpool. Pop. (1901) 58,566; an increase by nearly nine times in forty years. The great docks on this, the east bank of the Mersey, extend into the borough, but are considered as a whole under LIVERPOOL (q.v.). Such features, moreover, as communications, water-supply, &c., may be considered as part of the greater systems of the same city. The chief buildings and institutions are a hand-

some town hall, a museum, free libraries, technical schools, and several public pleasure grounds. Bootle was incorporated in 1868 and was created a county borough in 1888; the corporation consists of a mayor, 10 aldermen and 30 councillors. A proposal to include it within the city of Liverpool was rejected in parliament in July 1903. Area, 1576 acres.

BOOTY (apparently influenced by "boot," O. Eng. *bot*, advantage or profit, through an adaptation from an earlier form cognate with Ger. *Beute* and Fr. *butin*), plunder or gain. The phrase "to play booty," dating from the 16th century, means to play into a confederate's hands, or to play intentionally badly at first in order to deceive an opponent.

BOPP, FRANZ (1791-1867), German philologist, was born at Mainz on the 14th of September 1791. In consequence of the political troubles of that time, his parents removed to Aschaffenburg, in Bavaria, where he received a liberal education at the Lyceum. It was here that his attention was drawn to the languages and literature of the East by the eloquent lectures of Karl J. Windischmann, who, with G. F. Creuzer, J. J. Görres, and the brothers Schlegel, was full of enthusiasm for Indian wisdom and philosophy. And further, Fr. Schlegel's book, *Über die Sprache und Weisheit der Indier* (Heidelberg, 1808), which was just then exerting a powerful influence on the minds of German philosophers and historians, could not fail to stimulate also Bopp's interest in the sacred language of the Hindus. In 1812 he went to Paris at the expense of the Bavarian government, with a view to devote himself vigorously to the study of Sanskrit. There he enjoyed the society of such eminent men as A. L. Chézy, S. de Sacy, L. M. Langlès, and, above all, of Alexander Hamilton (1762-1824), who had acquired, when in India, an acquaintance with Sanskrit, and had brought out, conjointly with Langlès, a descriptive catalogue of the Sanskrit manuscripts of the Imperial library. At that library Bopp had access not only to the rich collection of Sanskrit manuscripts, most of which had been brought from India by Father Pons early in the 18th century, but also to the Sanskrit books which had up to that time issued from the Calcutta and Serampore presses. The first fruit of his four years' study in Paris appeared at Frankfort-on-Main in 1816, under the title *Über das Conjugationssystem der Sanskritsprache in Vergleichung mit jenem der griechischen, lateinischen, persischen und germanischen Sprache*, and it was accompanied with a preface from the pen of Windischmann. In this first book Bopp entered at once on the path on which the philological researches of his whole subsequent life were concentrated. It was not that he wished to prove the common parentage of Sanskrit with Persian, Greek, Latin and German, for that had long been established; but his object was to trace the common origin of their grammatical forms, of their inflections from composition,—a task which had never been attempted. By a historical analysis of those forms, as applied to the verb, he furnished the first trustworthy materials for a history of the languages compared.

After a brief sojourn in Germany, Bopp came to London, where he made the acquaintance of Sir Charles Wilkins and H. T. Colebrooke, and became the friend of Wilhelm von Humboldt, then Prussian ambassador at the court of St James's, to whom he gave instruction in Sanskrit. He brought out, in the *Annals of Oriental Literature* (London, 1820), an essay entitled, "Analytical Comparison of the Sanskrit, Greek, Latin and Teutonic Languages," in which he extended to all parts of the grammar what he had done in his first book for the verb alone. He had previously published a critical edition, with a Latin translation and notes, of the story of *Nala and Damayanti* (London, 1819), the most beautiful episode of the Mahābhārata. Other episodes of the Mahābhārata—*Indralokāgamana*, and three others (Berlin, 1824); *Diluvium*, and three others (Berlin, 1829); and a new edition of *Nala* (Berlin, 1832)—followed in due course, all of which, with A. W. Schlegel's edition of the *Bhagavadgītā* (1823), proved excellent aids in initiating the early student into the reading of Sanskrit texts. On the publication, in Calcutta, of the whole Mahābhārata, Bopp discontinued editing Sanskrit texts, and confined himself thenceforth exclusively to grammatical investigations.

After a short residence at Göttingen, Bopp was, on the recommendation of Humboldt, appointed to the chair of Sanskrit and comparative grammar at Berlin in 1821, and was elected member of the Royal Prussian Academy in the following year. He brought out, in 1827, his *Ausführliches Lehrgebäude der Sanskritsprache*, on which he had been engaged since 1821. A new edition, in Latin, was commenced in the following year, and completed in 1832; and a shorter grammar appeared in 1834. At the same time he compiled a Sanskrit and Latin glossary (1830) in which, more especially in the second and third editions (1847 and 1867), account was also taken of the cognate languages. His chief activity, however, centred on the elaboration of his *Comparative Grammar*, which appeared in six parts at considerable intervals (Berlin, 1833, 1835, 1842, 1847, 1849, 1852), under the title *Vergleichende Grammatik des Sanskrit, Zend, Griechischen, Lateinischen, Lithuanischen, Altslavischen, Gotthischen, und Deutschen*. How carefully this work was matured may be gathered from the series of monographs printed in the *Transactions of the Berlin Academy* (1824 to 1831), by which it was preceded. They bear the general title, *Vergleichende Zergliederung des Sanskrits und der mit ihm verwandten Sprachen*. Two other essays (on the "Numerals," 1835) followed the publication of the first part of the *Comparative Grammar*. The Old-Slavonian began to take its stand among the languages compared from the second part onwards. The work was translated into English by E. B. Eastwick in 1845. A second German edition, thoroughly revised (1856-1861), comprised also the Old-Armenian. From this edition an excellent French translation was made by Professor Michel Bréal in 1866. The task which Bopp endeavoured to carry out in his *Comparative Grammar* was threefold,—to give a description of the original grammatical structure of the languages as deduced from their intercomparison, to trace their phonetic laws, and to investigate the origin of their grammatical forms. The first and second points were subservient to the third. As Bopp's researches were based on the best available sources, and incorporated every new item of information that came to light, so they continued to widen and deepen in their progress. Witness his monographs on the vowel system in the Teutonic languages (1836), on the Celtic languages (1839), on the Old-Prussian (1853) and Albanian languages (1854), on the accent in Sanskrit and Greek (1854), on the relationship of the Malayo-Polynesian with the Indo-European languages (1840), and on the Caucasian languages (1846). In the two last mentioned the impetus of his genius led him on a wrong track. Bopp has been charged with neglecting the study of the native Sanskrit grammars, but in those early days of Sanskrit studies the requisite materials were not accessible in the great libraries of Europe; and if they had been, they would have absorbed his exclusive attention for years, while such grammars as those of Wilkins and Colebrooke, from which his grammatical knowledge was derived, were all based on native grammars. The further charge that Bopp, in his *Comparative Grammar*, gave undue prominence to Sanskrit may be disproved by his own words; for, as early as the year 1820, he gave it as his opinion that frequently the cognate languages serve to elucidate grammatical forms lost in Sanskrit (*Annals of Or. Lit.* i. 3),—an opinion which he further developed in all his subsequent writings.

Bopp's researches, carried with wonderful penetration into the most minute and almost microscopical details of linguistic phenomena, have led to the opening up of a wide and distant view into the original seats, the closer or more distant affinity, and the tenets, practices and domestic usages of the ancient Indo-European nations, and the science of comparative grammar may truly be said to date from his earliest publication. In grateful recognition of that fact, on the fiftieth anniversary (May 16, 1866) of the date of Windischmann's preface to that work, a fund called *Die Bopp-Stiftung*, for the promotion of the study of Sanskrit and comparative grammar, was established at Berlin, to which liberal contributions were made by his numerous pupils and admirers in all parts of the globe. Bopp lived to see the results of his labours everywhere accepted, and his name justly celebrated. But he died, on the 23rd of October 1867, a poor

man,—though his genuine kindness and unselfishness; his devotion to his family and friends, and his rare modesty, endeared him to all who knew him.

See M. Bréal's translation of Bopp's *Vergl. Gramm.* (1866) introduction; Th. Bentley, *Gesch. der Sprachwissenschaft* (1869); A. Kuhn in *Unsere Zeit*, Neue Folge, iv. 1 (1868); Lefmann, *Franz Bopp* (Berlin, 1891-1897).

BOPPARD, a town of Germany, in the Prussian Rhine province, on the left bank of the Rhine, 12 m. S. of Coblenz on the main line to Cologne. Pop. (1900) 5806. It is an old town still partly surrounded by mediæval walls, and its most noteworthy buildings are the Roman Catholic parish church (12th and 13th centuries); the Carmelite church (1318), the former castle, now used for administrative offices; the Evangelical church (1851, enlarged in 1887); and the former Benedictine monastery of the Marienberg, founded 1123 and since 1839 a hydropathic establishment, crowning a hill 100 ft. above the Rhine. Boppard is a favourite tourist centre, and being less pent in by hills than many other places in this part of the picturesque gorge of the Rhine, has in modern times become a residential town. It has some comparatively insignificant industries, such as tanning and tobacco manufacture; its direct trade is in wine and fruit.

Boppard (*Baudobriga*) was founded by the Romans; under the Merovingian dynasty it became a royal residence. During the middle ages it was a considerable centre of commerce and shipping, and under the Hohenstaufen emperors was raised to the rank of a free imperial city. In 1312, however, the emperor Henry VII. pledged the town to his brother Baldwin, archbishop-elect of Trier, and it remained in the possession of the electors until it was absorbed by France during the Revolutionary epoch. It was assigned by the congress of Vienna in 1815 to Prussia.

BORA, an Italian name for a violent cold northerly and north-easterly wind, common in the Adriatic, especially on the Istrian and Dalmatian coasts. There is always a northern tendency in the winds on the north Mediterranean shores in winter owing to the cold air of the mountains sliding down to the sea where the pressure is less. When, therefore, a cyclone is formed over the Mediterranean, the currents in its north-western area draw the air from the cold northern regions, and during the passage of the cyclone the bora prevails. The bora also occurs at Novorossiysk on the Black Sea. It is precisely similar in character to the mistral which prevails in Provence and along the French Mediterranean littoral.

BORACITE, a mineral of special interest on account of its optical anomalies. Small crystals bounded on all sides by sharply defined faces are found in considerable numbers embedded in gypsum and anhydrite in the salt deposits at Lüneburg in Hanover, where it was first observed in 1787. In external form these crystals are cubic with inclined hemihedrism, the symmetry being the same as in blende and tetrahedrite. Their habit varies according to whether the tetrahedron (fig. 1), the cube (fig. 2), or the rhombic dodecahedron (fig. 3) predominates. Penetration

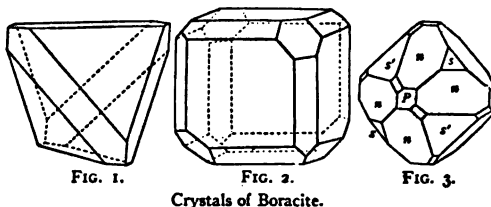

FIG. 1.

FIG. 2.

FIG. 3.

Crystals of Boracite.

twins with a tetrahedron face as twin-plane are sometimes observed. The crystals vary from translucent to transparent, are possessed of a vitreous lustre, and are colourless or white, though often tinged with grey, yellow or green. The hardness is as high as 7 on Mohs' scale; specific gravity 3.0. As first observed by R. J. Haüy in 1791, the crystals are markedly pyroelectric; a cube when heated becomes positively electrified on four of its corners and negatively on the four opposite corners. In a

crystal such as represented in fig. 3, the smaller and dull tetrahedral faces s are situated at the analogous poles (which become positively electrified when the crystal is heated), and the larger and bright tetrahedral faces s' at the antilogous poles.

The characters so far enumerated are strictly in accordance with cubic symmetry, but when a crystal is examined in polarized light, it will be seen to be doubly refracting, as was first observed by Sir David Brewster in 1821. Thin sections show twin-lamellae, and a division into definite areas which are optically biaxial. By cutting sections in suitable directions, it may be proved that a rhombic dodecahedral crystal is really built up of twelve orthorhombic pyramids, the apices of which meet in the centre and the bases coincide with the dodecahedral faces of the compound (pseudo-cubic) crystal. Crystals of other forms show other types of internal structure. When the crystals are heated these optical characters change, and at a temperature of 265° the crystals suddenly become optically isotropic; on cooling, however, the complexity of internal structure reappears. Various explanations have been offered to account for these "optical anomalies" of boracite. Some observers have attributed them to alteration, others to internal strains in the crystals, which originally grew as truly cubic at a temperature above 265° . It would, however, appear that there are really two crystalline modifications of the boracite substance, a cubic modification stable above 265° and an orthorhombic (or monoclinic) one stable at a lower temperature. This is strictly analogous to the case of silver iodide, of which cubic and rhombohedral modifications exist at different temperatures; but whereas rhombohedral as well as pseudo-cubic crystals of silver iodide (iodyrite) are known in nature, only pseudo-cubic crystals of boracite have as yet been met with.

Chemically, boracite is a magnesium borate and chloride with the formula $Mg_2Cl_2B_4O_{10}$. A small amount of iron is sometimes present, and an iron-boracite with half the magnesium replaced by ferrous iron has been called huysenite. The mineral is insoluble in water, but soluble in hydrochloric acid. On exposure it is liable to slow alteration, owing to the absorption of water by the magnesium chloride: an altered form is known as parasite.

In addition to embedded crystals, a massive variety, known as stassfurtite, occurs as nodules in the salt deposits at Stassfurt in Prussia: that from the carnallite layer is compact, resembling fine-grained marble, and white or greenish in colour, whilst that from the kainite layer is soft and earthy, and yellowish or reddish in colour. (L. J. S.)

BORAGE (pronounced like "courage"; possibly from Lat. *borra*, rough hair), a herb (*Borago officinalis*) with bright blue flowers and hairy leaves and stem, considered to have some virtue as a cordial and a febrifuge; used as an ingredient in salads or in making claret-cup, &c.

BORAGINACEAE, an order of plants belonging to the symmetrical section of dicotyledons, and a member of the series Tubiflorae. It is represented in Britain by bugloss (*Echium*) (fig. 1), comfrey (*Symphytum*), *Myosotis*, hounds-tongue (*Cynoglossum*) (fig. 2), and other genera, while borage (*Borago officinalis*) (fig. 3) occurs as a garden escape in waste ground. The plants are rough-haired annual or perennial herbs, more rarely shrubby or arborescent, as in *Cordia* and *Ehretia*, which are tropical or sub-tropical. The leaves, which are generally alternate, are usually entire and narrow: the radical leaves in some genera, as *Pulmonaria* (lungwort) and *Cynoglossum*, differ in form from the stem-leaves, being generally broader and sometimes heart-shaped. A characteristic feature is the one-sided (*dorsinental*) inflorescence, well illustrated in forget-me-not and other species of *Myosotis*; the cyme is at first closely coiled, becoming uncoiled as the flowers open. At the same time there is often a change in colour in the flowers, which are red in bud, becoming blue as they expand, as in *Myosotis*, *Echium*, *Symphytum* and others. The flowers are generally regular; the form of the corolla varies widely. Thus in borage it is rotate, tubular in comfrey, funnel-shaped in hounds-tongue, and salver-shaped in alkanet (*Anchusa*); the throat is often closed by

scale-like outgrowths from the corolla, forming the so-called corona. A departure from the usual regular corolla occurs in *Echium* and a few allied genera, where it is oblique; in *Lycopsis* it is also bent.

The five stamens alternate in position with the lobes of the corolla. The ovary, of two carpels, is seated on a ring-like disk



FIG. 1.—Viper's Bugloss (*Echium vulgare*), about $\frac{1}{2}$ nat. size.

1. Single flower, about nat. size.
2. Corolla split open.
3. Calyx.
4. Pistil.
5. One stamen.
6. Calyx surrounding nutlets.
7. Same part of calyx cut away.
8. Two nutlets.
9. Same enlarged.

which secretes honey. Each carpel becomes divided by a median constriction in four portions, each containing one ovule; the style springs from the centre of the group of four divisions.

The flowers show well-marked adaptation to insect-visits. Their colour and tendency to arrangement on one surface, with

the presence of honey, serve to attract insects. The scales around the throat of the corolla protect the pollen and honey from wet or undesirable visitors, and by their difference in colour from the corolla-lobes, as in the yellow eye of forget-me-not, may serve to indicate the position of the honey. In most genera the fruit consists of one-seeded nutlets, generally four, but one or more may be undeveloped. The shape of the nutlet and the character of its coat are very varied. Thus in *Lithospermum* the nutlets are hard like a stone, in *Myosotis* usually polished, in *Cynoglossum* covered with bristles, &c.

The order is widely spread in of Forget-me-not; (2) temperate and tropical regions; and fruits. contains 8; genera with about 1200 species. Its chief centre is the Mediterranean region, whence it extends over cent

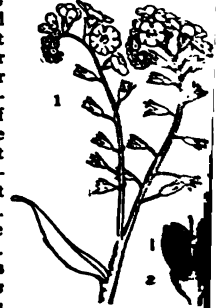

FIG. 2.—(1) Inflorescence

Europe and Asia, becoming less frequent northwards. A smaller centre occurs on the Pacific side of North America. The order is less developed in the south temperate zone.

The order is of little economic value. Several genera, such as



FIG. 3.—(1) Flower of Borage; (2) same in vertical section enlarged; (3) horizontal plan of flower; (4) flower of Comfrey after removal of corolla, showing uruipie fruit; (5) (1) and (4) natural size.

borago and *Pulmonaria*, were formerly used in medicine, and the roots yield purple or brown dyes, as in *Alkanna tinctoria* (alkanet). Heliotrope or cherry-pie (*Hediotropium persianum*) is a well-known garden plant.

BORAS, a town of Sweden, in the district (*län*) of Elfsborg, 45 m. E. of Gothenburg by rail, on the river Viska. Pop. (1880) 4,723; (1900) 15,837. It ranks among the first twelve towns in Sweden both in population and in the value of its manufacturing industries. These are principally textile, as there are numerous cotton spinning and weaving mills, together with a technical weaving school. The town was founded in 1632 by King Gustavus Adolphus.

BORAX (sodium pyroborate or sodium baborate), $\text{Na}_2\text{B}_4\text{O}_7$, a substance which appears in commerce under two forms, namely "common" or prismatic borax, $\text{Na}_2\text{B}_4\text{O}_7 \cdot 10\text{H}_2\text{O}$, and "jewellers'" or octahedral borax, $\text{Na}_2\text{B}_4\text{O}_7 \cdot 5\text{H}_2\text{O}$. It is to be noted that the term "borax" was used by the alchemists in a very vague manner, and is therefore not to be taken as meaning the substance now specifically known by the name. Prismatic borax is found widely distributed as a natural product (see below, *Mineralogy*) in Tibet, and in Canada, Peru and Transylvania, while the bed of Borax Lake, near Clear Lake in California, is occupied by a large mass of crystallized borax, which is fit for use by the assayer without undergoing any preliminary purification. The supply of borax is, however, mainly derived from the boric acid of Tuscany, which is fused in a reverberatory furnace with half its weight of sodium carbonate, and the mass after cooling is extracted with warm water. An alternative method is to dissolve sodium carbonate in lead-lined steam-heated pans, and add the boric acid gradually; the solution then being concentrated until the borax crystallizes. Borax is also prepared from the naturally occurring calcium borate, which is mixed in a finely divided condition with the requisite quantity of soda ash; the mixture is fused, extracted with water and concentrated until the aqueous commences to crystallize.

From a supersaturated aqueous solution of borax, the pentahydrate, $\text{Na}_2\text{B}_4\text{O}_7 \cdot 5\text{H}_2\text{O}$, is deposited when evaporation takes place at somewhat high temperatures. The same hydrate can be prepared by dissolving borax in water until the solution has a specific gravity of 1.126, and then allowing the solution to cool. The pentahydrate is deposited between 79°C . and 56°C .; below this temperature the anhydrous or ordinary borax, $\text{Na}_2\text{B}_4\text{O}_7$, is deposited. Crystals of ordinary borax swell up to a very great extent on heating, losing their water of crystallization and melting to a clear white glass. The crystals of octahedral borax fuse more easily than those of the prismatic form and are less liable to split when heated, so that they are preferable for soldering or fluxing. Fused borax dissolves many metallic oxides, forming complex borates which in many cases show characteristic colours. Its use in soldering depends on the fact that it not only adheres to the surface of an untarnished metal, and consequently a little borax is placed on the surface of the metal and heated by the soldering iron in order to remove any superficial film of oxide. It is also used for glazing pottery, in glass-making and the glazing of

ionized gives only a very small quantity of hydrogen ions, whilst the base (sodium hydroxide) produced by the hydrolysis occasioned by the dilution of the solution, being a "strong base," is highly ionized and gives a comparatively large amount of hydroxyl ions. In the solution, therefore, there is now an excess of hydroxyl ions; consequently it has an alkaline reaction and the litmus turns blue.

Mineralogy.—The Tibetan mineral deposits have been known since very early times, and formerly the crude material was exported to Europe, under the name of *finca*, for the preparation of pure borax and other boron salts. The most westerly of the Tibetan deposits are in the lake-plain of Pugha on the Rulangchu, a tributary of the Indus, at an elevation of 15,000 ft.: here the impure borax (*sokaga*) occurs over an area of about 2 sq. m., and is covered by a saline efflorescence; successive crops are obtained by the action of rain and snow and subsequent evaporation. Deposits of purer material (*chê tsalê* or water borax) occur at the lakes of Rudok, situated to the east of the Pugha district; also still farther to the east at the great lakes Tengri Nor, north of Lhasa, and several other places. More recently, the extensive deposits of borates (chiefly, however, of calcium; see COLEMANITE) in the Mohave desert on the borders of California and Nevada, and in the Atacama desert in South America, have been the chief commercial sources of boron compounds. The boron contained in solution in the salt lakes has very probably been supplied by hot springs and solfataras of volcanic origin, such as those which at the present day charge the waters of the lagoons in Tuscany with boric acid. The deposits formed by evaporation from these lakes and marshes or salines, are mixtures of borates, various alkaline salts (sodium carbonate, sulphate, chloride), gypsum, &c. In the mud of the lakes and in the surrounding marshy soil fine isolated crystals of borax are frequently found. For example, crystals up to 7 in. in length and weighing a pound each have been found in large numbers at Borax Lake in Lake county, and at Borax Lake in San Bernardino county, both in California.

Borax crystallizes with ten molecules of water, the composition of the crystals being $\text{Na}_2\text{B}_4\text{O}_7 \cdot 10\text{H}_2\text{O}$. The crystals belong to the monoclinic system, and it is a curious fact that in habit and angles they closely resemble pyroxene (a silicate of calcium, magnesium and iron). There is a perfect cleavage parallel to the orthopinacoid and less perfect cleavages parallel to the faces of the prism. The mineral is transparent to opaque and white, sometimes greyish, bluish or greenish in colour. Hardness 2-2½; sp. gr. 1.69-1.72.

The optical characters are interesting, because of the striking crossed dispersion of the optic axes, of which phenomenon borax affords the best example. The optic figure seen in convergent polarized light through a section cut parallel to the plane of symmetry of a borax crystal is symmetrical only with respect to the central point. The plane of the optic axes for red light is inclined at 2° to that for blue light, and the angle between the optic axes themselves is 3° greater for red than for blue light.

BORDA, JEAN CHARLES (1733-1799), French mathematician and nautical astronomer, was born at Dax on the 4th of May 1733. He studied at La Flèche, and at an early age obtained a commission in the cavalry. In 1756 he presented a *Mémoire sur le mouvement des projectiles* to the Academy of Sciences, who elected him a member. He was present at the battle of Hastembeck, and soon afterwards joined the naval service. He visited the Azores and the Canary Islands, of which he constructed an admirable map. In 1782 his frigate was taken by a British squadron; he himself was carried to England, but was almost immediately released on parole and returned to France. He died at Paris on the 20th of February 1799. Borda contributed a long series of valuable memoirs to the Academy of Sciences. His researches in hydrodynamics were highly useful for marine engineering, while the reflecting and repeating circles, as improved by him, were of great service in nautical astronomy. He was associated with J. B. J. Delambre and P. F. A. Méchain in the attempt to determine an arc of the meridian, and the greater number of the instruments employed in the task were invented by him.

See J. B. Biot, "Notice sur Borda" in the *Mém. de l'Acad. des Sciences*, iv.

BORDAGE. (1) A nautical term (from Fr. *bord*, side) for the planking on a ship's side. (2) A feudal term (from Lat. *borda*, a cottage) for the tenure by which a certain class of villein held

boric acid (q.v.) being only a weak acid, its salts readily undergo hydrolytic dissociation in aqueous solution, and this property can be readily shown with a concentrated aqueous solution of borax, by adding litmus and then just sufficient acetic acid to turn the colour red, the addition of a large volume of water to the solution changes the colour back to blue again. The boric acid being scarcely

their cottages; also the services due from these villeins or "bordars." A "bordar" (Med. Lat. *bordarius*) was a villein who obtained a cottage from his lord in return for menial services (see VILLENAGE).

BORDEAUX, a city of south-western France, capital of the department of Gironde, 350 m. S.S.W. of Paris by a main line of the Orléans railway and 159 m. N.W. of Toulouse on the main line of the Southern railway. Pop. (1906) 237,707. Bordeaux, one of the finest and most extensive cities in France, is situated on the left or west bank of the Garonne about 60 m. from the sea, in a plain which comprises the wine-growing district of *Médoc*. The Garonne at this point describes a semicircle, separating the city proper on the left bank from the important suburb of La Bastide on the right bank. The river is crossed by the Pont de Bordeaux, a fine stone structure of the early 19th century, measuring 1534 ft. in length, and by a railway bridge connecting the station of the Orléans railway company in La Bastide with that of the Southern company on the left bank. Looking west from the Pont de Bordeaux, the view embraces a crescent of wide and busy quays with a background of lofty warehouses, factories and mansions, behind which rise towers and steeples. Almost at the centre of the line of quays is the Place des Quinconces, round which lie the narrow, winding streets in which the life of the city is concentrated. Outside this quarter, which contains most of the important buildings, the streets are narrow and quiet and bordered by the low white houses which at Bordeaux take the place of the high tenements characteristic of other large French towns. The whole city is surrounded by a semicircle of boulevards, beyond which lie the suburbs of Le Bouscat, Caudéran, Mérignac, Talence and Bégles. The principal promenades are situated close together near the centre of the city. They comprise the beautiful public garden, the allées de Tournay and the Place des Quinconces. The latter is planted with plane trees, among which stand two huge statues of Montaigne and Montesquieu, and terminates upon the quays with two rostral columns which serve as lighthouses. On its west side there is a monument to the Girondin deputies proscribed under the convention in 1793. At its south-west corner the Place des Quinconces opens into the Place de la Comédie, which contains the Grand Théâtre (18th century), the masterpiece of the architect Victor Louis. The Place de la Comédie, the centre of business in Bordeaux, is traversed by a street which, under the names of Cours du Chapeau-Rouge, rue de l'Intendance and rue Judaïque, runs from the Place de la Bourse and the quai de la Douane on the east to the outer boulevards on the west. Another important thoroughfare, the rue Sainte Cathérine, runs at right angles to the rue de l'Intendance and enters the Place de la Comédie on the south. The Pont de Bordeaux is continued by the Cours Victor Hugo, a curved street crossing the rue Sainte Cathérine and leading to the cathedral of St André. This church, dating from the 11th to the 14th centuries, is a building in the Gothic style with certain Romanesque features, chief among which are the arches in the nave. It consists of a large nave without aisles, a transept at the extremities of which are the main entrances, and a choir, flanked by double aisles and chapels and containing many works of art. Both the north and south façades are richly decorated with sculpture and statuary. Of the four towers flanking the principal portals, only those to the north are surmounted by spires. Near the choir stands an isolated tower. It contains the great bell of the cathedral and is known as the Clocher Pey-Berland, after the archbishop of Bordeaux who erected it in the 15th century. Of the numerous other churches of Bordeaux the most notable are St Seurin (11th to the 15th centuries), with a finely sculptured southern portal; Ste Croix (12th and 13th centuries), remarkable for its Romanesque façade; and St Michel, a fine Gothic building of the 15th and 16th centuries. The bell tower of St Michel, which has the highest spire (354 ft.) in the south of France, dates from the end of the 15th century, and, like that of the cathedral, stands apart from its church. The palace of the Faculties of Science and of Letters (1881-1886) contains the tomb of Michel de Montaigne. The prefecture, the hôtel de ville, the bourse and the

custom-house belong to the 15th century. The law-courts and the hospital of St André (the foundation of which dates from 1390) belong to the first half of the 19th century. Of greater antiquarian interest is the Palais Gallien, situated near the public garden, consisting of remains of lofty arcades, vaulting and fragments of wall, which once formed part of a Roman amphitheatre. Bordeaux lost its fortifications in the 18th century, but four of the old gateways or triumphal arches belonging to that period still remain. Still older are the Porte de Cailhau, once the entrance to the Palais de l'Ombrière, which before its destruction was the residence of the duke of Aquitaine, and the Porte de l'Hôtel de Ville, the former of the 15th, the latter of the 13th and 16th centuries.

Bordeaux is the seat of an archbishop, the headquarters of the XVIII. army corps, the centre of an *académie* (educational division) and the seat of a court of appeal. A court of assizes is held there, and there are tribunals of first instance and of commerce, a council of trade-arbitrators, a chamber of commerce and a branch of the Bank of France. Its educational institutions include faculties of law, of science, of letters and of medicine and pharmacy, a faculty of Catholic theology, lycées, training colleges, a higher school of commerce, a chair of agriculture, a school of fine art and a naval school of medicine. There are several museums, including one with a large collection of pictures and sculptures, a library with over 200,000 volumes and numerous learned societies.

The trade of Bordeaux, the fourth port in France, is chiefly carried on by sea. Its port, $5\frac{1}{2}$ m. long and on the average 550 yds. wide, is formed by the basin of the Garonne and is divided into two portions by the Pont de Bordeaux. That to the south is used only by small craft; that to the north is accessible to vessels drawing from 21 to 26 ft. according to the state of the tide. From 1000 to 1200 vessels can be accommodated in the harbour, which is lined on both sides by quays and sloping wharves served by railway lines. At the northern extremity of the harbour, on the left bank, there is a floating basin of 25 acres in extent, capable of receiving the largest vessels; it has over 1900 yds. of quays and is furnished with a repairing dock and with elaborate machinery for the loading and unloading of goods. In 1907 the construction of new docks behind this basin was begun. The city maintains commercial relations with nearly all countries, but chiefly with Great Britain, Spain, Argentina, Portugal and the United States. The most important line of steamers using the port is the South American service of the Messageries Maritimes. The total value of the exports and imports of Bordeaux averages between 25 and 26 millions sterling yearly. Of this amount exports make up 13½ millions, of which the sales of wine bring in about one quarter. The city is the centre of the trade in "Bordeaux" wines, and the wine-cellars of the quays are one of its principal sights. Other principal exports are brandy, hides and skins, sugar, rice, woollen and cotton goods, salt-fish, chemicals, oil-cake, pitwood, fruit, potatoes and other vegetables. The chief imports are wool, fish, timber, rice, wine, rubber, coal, oil-grains, hardware, agricultural and other machinery and chemicals. A large fleet is annually despatched to the cod-fisheries of Newfoundland and Iceland. The most important industry is ship-building and re-fitting. Ironclads and torpedo-boats as well as merchant vessels are constructed. Railway carriages are also built. The industries subsidiary to the wine-trade, such as wine-mixing, cooperage and the making of bottles, corks, capsules, straw envelopes and wooden cases, occupy many hands. There are also flour-mills, sugar-refineries, breweries, distilleries, oil-works, cod-drying works, manufactories of canned and preserved fruits, vegetables and meat, and of chocolate. Chemicals, leather, iron-ware, machinery and pottery are manufactured, and a tobacco factory employs 1500 hands.

Bordeaux (*Burdigala*) was originally the chief town of the Bituriges Vivisci. Under the Roman empire it became a flourishing commercial city, and in the 4th century it was made the capital of Aquitania Secunda. Ausonius, a writer of the 4th century, who was a native of the place, describes it as four-square

and surrounded with walls and lofty towers, and celebrates its importance as one of the greatest educational centres of Gaul. In the evils that resulted from the disintegration of the empire Bordeaux had its full share, and did not recover its prosperity to the beginning of the 10th century. Along with Guienne it belonged to the English kings for nearly three hundred years (1154-1453), and was for a time the seat of the brilliant court of Edward the Black Prince, whose son Richard was born in the city. An extensive commerce was gradually developed between the Bordeaux merchants and their fellow-subjects in England,—London, Hull, Exeter, Dartmouth, Bristol and Chester being the principal ports with which they traded. The English administration was favourable to the liberties as well as to the trade of the city. In 1235 it received the right of electing its mayors, who were assisted in the administration by a "jurade" or municipal council. The influence of Bordeaux was still further increased when several important towns of the region, among them St Emilion and Libourne, united in a federation under its leadership. The defeat of the English at the battle of Castillon in 1453 was followed, after a siege of three months, by the submission of Bordeaux to Charles VII. The privileges of the city were at once curtailed, and were only partially restored under Louis XI, who established there the parlement of Guienne. In 1548 the inhabitants resisted the imposition of the salt-tax by force of arms, a rebellion for which they were punished by the constable Anne de Montmorency with merciless severity.

The reformed religion found numerous adherents at Bordeaux, and after the massacre of St Bartholomew nearly three hundred of its inhabitants lost their lives. The 17th century was a period of disturbance. The city was for a time the chief support of the Fronde, and on two occasions, in 1653 and 1675, troops were sent to repress insurrections against royal measures. In the middle of the 18th century, a period of commercial and architectural activity for Bordeaux, the marquis de Tourny, *intendant* of Guienne, did much to improve the city by widening the streets and laying out public squares. It was the headquarters of the Girondists at the Revolution, and during the Reign of Terror suffered almost as severely as Lyons and Marseilles. Its commerce was greatly reduced under Napoleon I. In 1814 it declared for the house of Bourbon; and Louis XVIII. afterwards gave the title of duc de Bordeaux to his grand-nephew, better known as the comte de Chambord. In 1870 the French government was transferred to Bordeaux from Tours on the approach of the Germans to the latter city.

See Camille Julian, *Hist. de Bordeaux, depuis les origines jusqu'en 1895* (Bordeaux, 1895); T. Malvezin, *Hist. du commerce de Bordeaux* (Bordeaux, 1892); *Bordeaux, aperçu historique, sol, population, industrie, commerce, administration* (Bordeaux, 1892).

BORDEN, SIR FREDERICK WILLIAM (1847—), Canadian statesman, was born at Cornwallis, Nova Scotia, on the 14th of May 1847. He was educated at King's College, Windsor, and at Harvard University, and for some years practised medicine at Canning, Nova Scotia. In 1874 he was elected to the Canadian parliament as Liberal member for King's county. In 1896 he became minister of militia and defence in the Liberal ministry.

BORDEN, ROBERT LAIRD (1854—), Canadian statesman, was born at Grand Pré, Nova Scotia, on the 26th of June 1854. In 1878 he was called to the bar, and became a leading lawyer in his native province. In 1896 he was elected to the Canadian parliament for the city of Halifax, but later lost his seat there and was elected for Carlton. In February 1901, on the resignation of Sir Charles Tupper, he became leader of the Conservative opposition. At the general election of 1908 he was returned again for Halifax.

BORDENTOWN, a city of Burlington county, New Jersey, U.S.A. on the E. bank of the Delaware river, 6 m. S. of Trenton and 25 m. N.E. of Philadelphia. Pop. (1890) 4232; (1900) 4110; (1905) 4073; (1910) 4250. It is served by the Pennsylvania railway, the Camden & Trenton railway (an electric line, forming part of the line between Philadelphia and New York) and by freight and passenger steamboat lines on the Delaware. Bordentown is attractively situated on a broad, level plain, 65 ft.

above the river, with wide, beautifully shaded streets. The city is the seat of the Bordentown Military Institute (with the Woodward memorial library), of the state manual training and industrial school for coloured youth, of the St Joseph's convent and mother-house of the Sisters of Mercy, and of St Joseph's academy for girls. There are ship-yards, iron foundries and forges, machine shops, shirt factories, a pottery for the manufacture of sanitary earthenware, a woollen mill and canning factories. The first settlers on the site of the city were several Quaker families who came in the 18th century. Bordentown was laid out by Joseph Borden, in whose honour it was named; was incorporated as a borough in 1825; was re-incorporated in 1849, and was chartered as a city in 1867. It was the home for some years of Francis Hopkinson and of his son Joseph Hopkinson (whose residences are still standing), and from 1817 to 1832 and in 1837-1839 was the home of Joseph Bonaparte, ex-king of Spain, who lived on a handsome estate known as "Bonaparte's Park," which he laid out with considerable magnificence. Here he entertained many distinguished visitors, including Lafayette. The legislature of New Jersey passed a special law, enabling him, as an alien, to own real property, and it is said to have been in reference to this that the state received its nickname "Spain." Prince Napoleon Lucien Charles Murat, the second son of Joachim Murat, also lived here for many years; and the estate known as "Ironsides" was long the home of Rear-Admiral Charles Stewart. The Camden & Amboy railway, begun in 1831 and completed from Bordentown to South Amboy (34 m.) in 1832, was one of the first railways in the United States; in September 1831 the famous engine "Johnny Bull," built in England and imported for this railway, had its first trial at Bordentown, and a monument now marks the site where the first rails were laid.

See E. M. Woodward, *Bonaparte's Park and the Murats* (Trenton, 1879).

BORDERS, THE, a name applied to the territory on both sides of the boundary line between England and Scotland. The term has also a literary and historical as well as a geographical sense, and is most frequently employed of the Scottish side. The line begins on the coast of Berwickshire at a spot 3 m. N. by W. of Berwick, and, after running a short distance W. and S., reaches the Tweed near the village of Paxton, whence it keeps to the river to a point just beyond Carham. There it strikes off S.E. to the Cheviot Hills, the watershed of which for 35 m. constitutes the boundary, which is thereafter formed by a series of streams—Bells Burn, the Kershope, Liddel and Esk. After following the last named for 1 m. it cuts across country due west to the Sark, which it follows to the river's mouth at the head of the Solway Firth. The length of the boundary thus described is 108 m., but in a direct line from the Solway to the North Sea the distance is only 70 m. At the extreme east end a small district of 8 sq. m., consisting of the tract north of the Tweed which is not included in Scotland, forms the "bounds" or "liberties" of Berwick, or the country of the borough and town of Berwick-on-Tweed. At the extreme west between the Sark and Esk as far up the latter as its junction with the Liddel, there was a strip of country, a "No man's land," for generations the haunt of outlaws and brigands. This was called the Debatable Land, because the possession of it was a constant source of contention between England and Scotland until its boundaries were finally adjusted in 1552. The English Border counties are Northumberland and Cumberland, the Scottish Berwick, Roxburgh and Dumfries; though historically, and still by usage, the Scottish shires of Selkirk and Peebles have always been classed as Border shires. On the English side the region is watered by the Till, Bowmont, Coquet, Rede and North Tyne; on the Scottish by the Tweed, Whiteadder, Leet, Kale, Jed, Kershope, Liddel, Esk and Sark. Physically there is a marked difference between the country on each side. On the southern it mostly consists of lofty, bleak moorland, affording subsistence for sheep and cattle, and rugged glens and ravines, while on the northern there are many stretches of fertile soil, especially in the valleys and dales, and the landscape is often romantic and beautiful. Railway communication is

supplied by the east coast route to Berwick, the Waverley route through Liddesdale, the London & North-Western by Carlisle, the North British branch from Berwick to St Boswells, and the North Eastern lines from Berwick to Kelso, Alnwick to Coldstream, and Newcastle to Carlisle.

At frequent intervals during a period of 1500 years the region was the scene of strife and lawlessness. The Roman road of Watling Street crossed the Cheviots at Brownhartlaw (1664 ft.), close to the camp of *Ad Fines*, by means of which the warlike Brigantes on the south and the Gadeni and Otadeni on the north were held in check, while another Roman road, the Wheel Causeway, passed into Scotland near the headwaters of the North Tyne and Liddel. (For early history see *LOTHIAN; NORTHUMBRIA; STRATHCLYDE*.) In the 12th century were founded the abbeys of Hexham and Alnwick, the priory church of Lindisfarne and the cathedral of Carlisle on the English side, and on the Scottish the abbeys of Jedburgh, Kelso, Melrose and Dryburgh. The deaths of Alexander III. (1286) and Margaret the Maid of Norway (1290), whose right to the throne had been acknowledged, plunged the country into the wars of the succession and independence, and until the union of the crowns in 1603 the borders were frequently disturbed. Berwick and Carlisle were repeatedly assailed, and battles took place at Halidon Hill (1333), Otterburn (1388), Nisbet (1402), Homildon (1402), Piperden (1435), Hedgeley Moor (1464), Flodden (1513), Solway Moss (1542), and Ancrum Moor (1544), in addition to many fights arising out of family feuds and raids fomented by the Armstrongs, Eliots, Grahams, Johnstones, Maxwells and other families, of which the most serious were the encounters at Arkenholme (Langholm) in 1455, the Raid of Reidswire (1575), and the bloody combat at Dryfe Sands (1593). The English expeditions of 1544 and 1545 were exceptionally disastrous, since they involved the destruction of the four Scottish border abbeys, the sack of many towns, and the obliteration of Roxburgh. The only other important conflict belongs to the Covenanters' time, when the marquess of Montrose was defeated at Philiphaugh in 1645. Partly for the defence of the kingdoms and partly to overawe the freebooters and mosstroopers who were a perpetual menace to the peace until they were suppressed in the 17th century, castles were erected at various points on both sides of the border.

Even during the period when relations between England and Scotland were strained, the sovereigns of both countries recognized it to be their duty to protect property and regulate the lawlessness of the borders. The frontier was divided into the East, Middle and West Marches, each under the control of an English and a Scots warden. The posts were generally filled by eminent and capable men who had to keep the peace, enforce punishment for breach of the law, and take care that neither country encroached on the boundary of the other. The wardens usually conferred once a year on matters of common interest, and as a rule their meetings were conducted in a friendly spirit, though in 1575 a display of temper led to the affair of the Raid of Reidswire. The appointment was not only one of the most important in this quarter of the kingdom, but lucrative as well, part of the fines and forfeits falling to the warden, who was also entitled to ration and forage for his retinue. On the occasion of his first public progress to London, James I. of England attended service in Berwick church (March 27, 1603) "to return thanks for his peaceful entry into his new dominions." Anxious to blot out all memory of the bitter past, he forbade the use of the word "Borders," hoping that the designation "Middle Shires" might take its place. Frontier fortresses were also to be dismantled and their garrisons reduced to nominal strength. In course of time this policy had the desired effect, though the expression "Borders" proved too convenient geographically to be dropped, the king's proposed amendment being in point of fact merely sentimental and, in the relative positions then and now of England and Scotland, meaningless. Some English strongholds, such as Alnwick, Chillingham, Ford and Naworth, have been modernized; others, like Norham, Wark and Warkworth, are picturesque ruins; but most of the Scottish fortresses

have been demolished and their sites built over, or are now represented by grass-grown mounds. Another familiar feature in the landscape is the chain of peel towers crossing the country from coast to coast. Many were homes of marauding chiefs, and nearly all were used as beacon-stations to give alarm of foray or invasion. Early in the 18th century the Scottish gipsies found a congenial home on the Roxburghshire side of the Cheviots; and at a later period the Scottish border became notorious for a hundred years as offering hospitality to runaway couples who were clandestinely married at Gretna Green, Coldstream or Lamberton. The toll-house of Lamberton displayed the following intimation—"Ginger-beer sold here and marriages performed on the most reasonable terms."

Border ballads occupy a distinctive place in English literature. Many of them were rescued from oblivion by Sir Walter Scott, who ransacked the district for materials for his *Minstrelsy of the Scottish Border*, which appeared in 1802 and 1803. Border traditions and folklore, and the picturesque, pathetic and stirring incidents of which the country was so often the scene, appealed strongly to James Hogg ("the Ettrick Shepherd"), John Wilson ("Christopher North"), and John Mackay Wilson (1804-1835), whose *Tales of the Borders*, published in 1835, long enjoyed popular favour.

Besides the works just mentioned see Sir Herbert Maxwell, *History of Dumfries and Galloway* (1896); George Ridpath, *Border History of England and Scotland* (1776); Professor John Veitch, *History and Poetry of the Scottish Border* (1877); Sir George Douglas, *History of the Border Counties* (Scots), (1899); W. S. Crockett, *The Scots Country* (1902).

BORDIGHERA, a town of Liguria, Italy, in the province of Porto Maurizio, 91 m. S.W. of Genoa by rail, and 3 m. E.N.E. of Ventimiglia. Pop. (1901) 4673. It is a favourite winter resort, especially for visitors from England, and is situated in beautiful coast scenery. It has fine gardens, and its flowers and palms are especially famous: the former are largely exported, while the latter serve for the supply of palm branches for St Peter's at Rome and other churches on Palm Sunday. The new museum contains a unique collection of the flora of the Riviera. From 1682 until the Napoleonic period, Bordighera was the capital of a small republic of the villages of the neighbouring valleys.

BORDONE, PARIS (1495-1570), Venetian painter, was born at Treviso, and entered the *bottega* of Titian in 1500. Vasari, to whom we are indebted for nearly all the facts of Bordone's life—later research has not added much to our knowledge—holds that he did not spend many years with Titian and set himself to imitate the manner of Giorgione to the utmost of his power. As a matter of fact, the Giorgionesque traits in Bordone's earlier works are derived entirely from Titian, whom he imitated so closely that to this day some of his paintings pass under Titian's name. Crowe and Cavalcaselle and Dr Bode ascribe to Bordone the "Baptism of Christ" in the Capitoline gallery, but Morelli sees in it an early work of Titian. Paris Bordone subsequently executed many important mural paintings in Venice, Treviso and Vicenza, all of which have perished. In 1538 he was invited to France by Francis I., at whose court he painted many portraits, though no trace of them is to be found in French collections, the two portraits at the Louvre being later acquisitions. On his return journey he undertook works of great importance for the Fugger palace at Augsburg, which again have been lost sight of. Bordone's pictures are of very unequal merit. They have a certain nobility of style, and that golden harmony of colour which he derived from Titian, together with the realistic conception of the human figure and the dignified character of his portraiture. On the other hand, his nudes are a little coarse in form, and the action of his figures is frequently unnatural and affected. A true child of the Renaissance, he also painted a number of religious pictures, numerous mythological scenes, allegories, nymphs, cupids and subjects from Ovid's fables, but he excelled as a portraitist. His principal surviving work is the "Fisherman and Doge" at the Venice Academy. The National Gallery, London, has a "Daphnis and Chloë" and a portrait of a lady, whilst a "Holy Family" from his brush is at Bridgewater House. Other important works

his are the "Madonna" in the Tadini collection at Lovere, the paintings in the Duomo of Treviso, two mythological pictures at the Villa Borghese and the Doria palace in Rome, the "Chess Players" in Berlin, a very little-known portrait of superb quality in the possession of the landgrave of Hesse at Kronberg, and a "Baptism of Christ" in Philadelphia. Besides these, there are examples of his art in Bergamo, Milan, Genoa, Padua, Siena, Venice, Florence, Munich, Dresden and Vienna.

Beyond some references in general works on Italian painting, very little has been written on Paris Bordone since the days of Vasari. In 1900 the committee of the fourth centenary of Paris Bordone, Treviso, published L. Barlo and G. Biscaro's *Della Vita e delle Opere di Paris Bordone*; and the *Nuova Antologia* (November 16, 1900) contains a sixteen-page paper on Paris Bordone by P. G. Moimanti. (P. G. K.)

BORE, a high tidal wave rushing up a narrow estuary or tidal river. The bore of the Severn is produced by a tide that rises 18 ft. in an hour and a half. This body of water becomes compressed in the narrowing funnel-shaped estuary, and heaped up into an advancing wave extending from bank to bank. The phenomenon is also particularly well illustrated in the Bay of Fundy. The origin of this word is doubtful, but it is usually referred to a Scandinavian word *bára*, a wave, billow. The other name by which the phenomenon is known, "eagre," is also of unknown origin. There is, of course, no connexion with "bore," to make a hole by piercing or drilling, which is a common Teutonic word. cf. Ger. *bohren*, the Indo-European root being seen in Lat. *forare*, to pierce, Gr. *φάσος*, plough. For the making of deep holes for shafts, wells, &c., see **BORING**. The substantival use of this word is generally confined to the circular cavity of objects of tubular shape, particularly of a gun, hence the internal diameter of a gun, its "calibre" (see **GUN**). A "bore" is also a tiresome, wearying person, particularly one who persistently harps on one subject, in or out of season, whatever interest his audience may take in it. This has generally been taken to be merely a metaphorical use of "bore," to pierce. The earliest sense, however, in which it is found in English (1766, in certain letters printed in Jesse's *Life of George Selwyn*) is that of *ennui*, and a French origin is suggested. The *New English Dictionary* conjectures a possible source in Fr. *bourrer*, to stuff, satiate.

BOREAS, in Greek mythology, a personification of the north wind. He was described as the son of Astræus and Eos, brother of Hesperus, Notus and Zephyrus. His dwelling-place was on Mount Hæmus in Thrace, or at Salmydessus, near the country of the Hyperboreans. He was said to have carried off the beautiful Oreithyia, a daughter of Erechtheus, king of Athens, when he found her leading the dance at a festival, or gathering flowers on the banks of the Ilissus or some other spot in the neighbourhood of Athens. He had before wooed her in vain, and now carried her off to Mount Hæmus, where they lived as king and queen of the winds, and had two sons, Zetes and Calais, and two daughters, Cleopatra and Chione (Apollodorus iii. 15; Ovid, *Metam.* vi. 677). For the loss of Oreithyia the Athenians in after times counted on Boreas's friendliness, and were assured of it when he sent storms which wrecked the Persian fleet at Arbos and at Sepias (Herodotus vii. 189). For this they erected to him a sanctuary or altar near the Ilissus, and held a festival (*Boresmos*) in his honour. Thuria also, which was a colony of Athens, offered sacrifice to him as Euergetes every year, because he had destroyed the hostile fleet of Dionysius the elder (Asian, *Var. Hist.* xii. 61). In works of art Boreas was represented as bearded, powerful, draped against cold, and winged. On the Tower of the Winds at Athens he is figured holding a shield such as is blown by Tritons. Boreas carrying off Oreithyia is the subject of a beautiful bronze relief in the British Museum, found in the island of Calymna. The same subject occurs frequently on painted Greek vases.

BOREL, PETRUS, whose full name was PIERRE JOSEPH BAZIL D'HAUTERIVE (1809-1859), French writer, was born at Lyons on the 26th of June 1809. His father had been ruined by taking part in the resistance offered by the Lyonnese royalists against the Convention, and Petrus Borel was educated in Paris to be an architect. He soon abandoned his profession

to become one of the most violent partisans of the Romantic movement. His extravagant sentiments were illustrated in various volumes: *Rhapsodies* (1832), poems; *Champavert, contes immoraux* (1833); *Madame Putiphar* (1839), &c. His works did not rescue him from poverty, but through the kindness of Théophile Gautier and Mme de Girardin he obtained a small place in the civil service. He died at Mostaganem in Algeria on the 14th of July 1859.

See Jules Claretie, *Petrus Borel, le Lycanthrope* (1865); and Ch. Asselineau, *Bibliographie romantique* (1872).

BORELLI, GIOVANNI ALFONSO (1608-1679), Italian physiologist and physicist, was born at Naples on the 28th of January 1608. He was appointed professor of mathematics at Messina in 1649 and at Pisa in 1656. In 1667 he returned to Messina, but in 1674 was obliged to retire to Rome, where he lived under the protection of Christina, queen of Sweden, and died on the 31st of December 1679. His best-known work is *De motu animalium* (Rome, 1680-1681), in which he sought to explain the movements of the animal body on mechanical principles; he thus ranks as the founder of the iatrophysical school. In a letter, *Del movimento della cometa apparsa il mese di dicembre 1664*, published in 1665 under the pseudonym Pier Maria Mutoli, he was the first to suggest the idea of a parabolic path; and another of his astronomical works was *Theorica medicorum planetarum ex causis physicis deducta* (Florence, 1666), in which he considered the influence of attraction on the satellites of Jupiter. He also wrote: *Della Causa delle Febbri maligni* (Pisa, 1658); *De Renum usu Judicium* (Strassburg, 1664); *Euclides Restitutus* (Pisa, 1658); *Apollonii Pergæi Conicorum libri v., vi. et vii.* (Florence, 1661); *De vi percussiois* (Bologna, 1667); *Meteorologia Aetnae* (Reggio, 1669); and *De motuibus naturalibus a gravitate pendentibus* (Bologna, 1670).

BORGÅ (Finnish *Porvoo*), a seaport in the province of Nyland, grand duchy of Finland, situated at the entrance of the river Borgå into the Gulf of Finland, about 33 m. by rail N.W. of Helsingfors. Pop. (1810) 1693; (1870) 3478; (1904) 5255. It is the seat of a Lutheran bishopric which extends over the provinces of Viborg and St Michel with portions of Tavastehus and Nyland; it possesses a beautiful cathedral, and a high school (where the well-known Finnish poet Runeberg lectured for many years), and is the seat of a court of appeal. The weaving of sail-cloth and the manufacture of tobacco are the principal industries, and the chief articles of trade are wood, butter and furs. Borgå was once a city of great dignity and importance, but the rapid growth of Helsingfors has somewhat eclipsed it. In 1809, when the estates of Finland were summoned to a special diet to decide the future of the country, Borgå was the place of meeting, and it was in the cathedral that the emperor Alexander I. pledged himself as grand duke of Finland to maintain the constitution and liberties of the grand duchy.

BORGHESE, a noble Italian family of Sienese origin, first mentioned in 1238, a member of which, Marcantonio Borghese, settled in Rome and was the father of Camillo Borghese (1550-1620), elected pope under the title of Paul V. (1605). Paul created his nephew prince of Vivero on the 17th of November 1609, and Philip III. of Spain conferred the title of prince of Sulmona on him in 1610. The family took its place among the higher Roman nobility by the marriage of the prince's son Paolo with Olimpia, heiress of the Aldobrandini family, in 1614. In 1803 Camillo Filippo Ludovico, Prince Borghese (b. 1775), married Pauline, sister of the emperor Napoleon, and widow of General Leclerc. In 1806 he was made duke of Guastalla, and for some years acted as governor of the Piedmontese and Genoese provinces. After the fall of Napoleon he fixed his residence at Florence, where he died in 1832. The Borghese palace at Rome is one of the most magnificent buildings in the city, and contained a splendid gallery of pictures, most of which have been transferred to the Villa Borghese outside the Porto del Popolo, now Villa Umberto I., the property of the Italian government.

See A. von Reumont, *Geschichte der Stadt Rom*, iii. 605, 609, 617, &c.; *Almanach de Gotha* (Gotha, 1902); J. H. Douglas, *The Principal Noble Families of Rome* (Rome, 1905).

BORGHESI, BARTOLOMEO (1781-1860), Italian antiquarian, was born at Savignano, near Rimini, on the 11th of July 1781. He studied at Bologna and Rome. Having weakened his eyesight by the study of documents of the middle ages, he turned his attention to epigraphy and numismatics. At Rome he arranged and catalogued several collections of coins, amongst them those of the Vatican, a task which he undertook for Pius VII. In consequence of the disturbances of 1821, Borghesi retired to San Marino, where he died on the 16th of April 1860. Although mainly an enthusiastic student, he was for some time podestà of the little republic. His monumental work, *Nuovi Frammenti dei Fasti Consolari Capitolini* (1818-1820), attracted the attention of the learned world as furnishing positive bases for the chronology of Roman history, while his contributions to Italian archaeological journals established his reputation as a numismatist and antiquarian. Before his death, Borghesi conceived the design of publishing a collection of all the Latin inscriptions of the Roman world. The work was taken up by the Academy of Berlin under the auspices of Mommsen, and the result was the *Corpus Inscriptionum Latinarum*. Napoleon III. ordered the publication of a complete edition of the works of Borghesi. This edition, in ten volumes, of which the first appeared in 1862, was not completed until 1897.

BORGIA, CESARE, duke of Valentinois and Romagna (1476-1507), was the son of Pope Alexander VI. by Vanozza dei Catanei. He was born at Rome while his father was cardinal, and on the latter's elevation to the papacy (1492) he was created archbishop of Valencia, and a year later cardinal. Cesare was Alexander's favourite son, and it was for him that the pope's notorious nepotism was most extensively practised. In the early years of his father's pontificate he led a profligate life at the Vatican. When Charles VIII. left Rome for the conquest of Naples (January 25, 1495), Cesare accompanied him as a hostage for the pope's good behaviour, but he escaped at Velletri and returned to Rome. He soon began to give proofs of the violence for which he afterwards became notorious; when in 1497 his brother Giovanni, duke of Gandia, was murdered, the deed was attributed, in all probability with reason, to Cesare. It was suggested that the motive of the murder was the brothers' rivalry in the affection of Donna Sancha, wife of Giuffrè, the pope's youngest son, while there were yet darker hints at incestuous relations of Cesare and the duke with their sister Lucrezia. But it is more probable that Cesare, who contemplated exchanging his ecclesiastical dignities for a secular career, regarded his brother's splendid position with envy, and was determined to enjoy the whole of his father's favours.

In July 1497 Cesare went to Naples as papal legate and crowned Frederick of Aragon king. Now that the duke of Gandia was dead, the pope needed Cesare to carry out his political schemes, and tried to arrange a wealthy marriage for him. Cesare wished to marry Carlotta, the daughter of the king of Naples, but both she and her father resolutely refused an alliance with "a priest, the bastard of a priest." In August 1498, Cesare in the consistory asked for the permission of the cardinals and the pope to renounce the priesthood, and the latter granted it "for the good of his soul." On the 1st of October he set forth for France with a magnificent retinue as papal legate to Louis XII., to bring him the pope's bull annulling his marriage with Jeanne of France (Louis wished to marry Anne of Brittany). In exchange he received the duchy of Valentinois, as well as military assistance for his own enterprises. He found Carlotta of Naples in France, and having again tried to win her over in vain, he had to content himself with Charlotte d'Albret, sister of the king of Navarre (May 1499). Alexander now contemplated sending Cesare to Romagna to subdue the turbulent local despots, and with the help of the French king carve a principality for himself out of those territories owing nominal allegiance to the pope. Cesare made Cesena his headquarters, and with an army consisting of 300 French lances, 4000 Gascons and Swiss, besides Italian troops, he attacked Imola, which surrendered at once, and then besieged Forlì, held by Caterina Sforza (q.v.), the widow of Girolamo Riario. She held out gallantly, but was at

last forced to surrender on the 22nd of January 1500; Cesare treated her with consideration, and she ended her days in a convent. The Sforzas having expelled the French from Milan, Cesare returned to Rome in February, his schemes checked for the moment; his father rewarded him for his successes by making him *gonfaloniere* of the church and conferring many honours on him; he remained in Rome and took part in bull fights and other carnival festivities. In July occurred the murder of the duke of Bisceglie, Lucrezia Borgia's third husband. He was attacked by assassins on the steps of St Peter's and badly wounded; attendants carried him to a cardinal's house, and, fearing poison, he was nursed only by his wife and Sanche, his sister-in-law. Again Cesare was suspected as the instigator of the deed, and in fact he almost admitted it himself. Bisceglie was related to the Neapolitan dynasty, with whose enemies the pope was allied, and he had had a quarrel with Cesare. When it appeared that he was recovering from his wounds, Cesare had him murdered, but not apparently without provocation, for, according to the Venetian ambassador Cappello, the duke had tried to murder Cesare first.

In October 1500 Cesare again set out for the Romagna, on the strength of Venetian friendship, with an army of 10,000 men. Pandolfo Malatesta of Rimini and Giovanni Sforza of Pesaro fled, and those cities opened their gates to Cesare. Faenza held out, for the people were devoted to their lord, Astorre Manfredi, a handsome and virtuous youth of eighteen. Manfredi surrendered in April 1501, on the promise that his life should be spared, but Cesare broke his word, and sent him a prisoner to Rome, where he was afterwards foully outraged and put to death. After taking Castel Bolognese he returned to Rome in June, to take part in the Franco-Spanish intrigues for the partition of Naples. He was now lord of an extensive territory, and the pope created him duke of Romagna. His cruelty, his utter want of scruple, and his good fortune made him a terror to all Italy. His avidity was insatiable and he could brook no opposition; but, unlike his father, he was morose, silent and unsympathetic. His next conquests were Camerino and Urbino, but his power was now greatly shaken by the conspiracy of La Magione (a castle near Perugia where the plotters met). Several of the princes depended by him, the Orsinis, and some of his own captains, such as Vitellozzo Vitelli (q.v.), Oliverotto da Fermo, and G. F. Baglioni, who had been given estates but feared to lose them, joined forces to conspire against the Borgias. Risings broke out at Urbino and in Romagna, and the papal troops were defeated: Cesare could find no allies, and it seemed as though all Italy was about to turn against the hated family, when the French king promised help, and this was enough to frighten the confederates into coming to terms. Most of them had shown very little political or military skill, and several were ready to betray each other. But Cesare, while trusting no one, proved a match for them all. During his operations in northern Romagna, Vitelli, Oliverotto, Paolo Orsini, and the duke of Gravina, to show their repentance, seized Senigallia, which still held for the duke of Urbino, in his name. Cesare arrived at that town, decoyed the unsuspecting *condottieri* into his house, had them all arrested, and had two of them, Vitelli and Oliverotto, strangled (December 31, 1501).

He was back in Rome early in 1503, and took part in reducing the last rebel Orsini. He was gathering troops for a new expedition in central Italy in the summer, when both he and his father were simultaneously seized with fever. The pope died on the 18th of August, while Cesare was still incapacitated, and this unfortunate coincidence proved his ruin; it was the one contingency for which he had not provided. On all sides his enemies rose up against him; in Romagna the deposed princes prepared to regain their own, and the Orsinis raised their heads once more in Rome. Cesare's position was greatly shaken, and when he tried to browbeat the cardinals by means of Don Michelotto and his bravos, they refused to be intimidated; he had to leave Rome in September, trusting that the Spanish cardinals would elect a candidate friendly to his house. At the conclave Francesco Todeschini-Piccolomini was elected as Pius III., and he showed every disposition to be peaceful and respectable, but he was old

and in bad health. Cesare's dominion at once began to fall to pieces; Guidobaldo, duke of Urbino, returned to his duchy with Venetian help; and the lords of Piombino, Rimini and Pesaro soon regained their own; Cesena, defended by a governor faithful to Cesare, alone held out. Pius III. died on the 18th of October 1503, and a new conclave was held. Cesare, who could still count on the Spanish cardinals, wished to prevent the election of Giuliano della Rovere, the enemy of his house, but the latter's chances were so greatly improved that it was necessary to come to terms with him. On the 1st of November he was elected, and assumed the name of Julius II. He showed no ill-will towards Cesare, but declared that the latter's territories must be restored to the church, for "we desire the honour of recovering what our predecessors have wrongfully alienated." Venice hoped to intervene in Romagna and establish her protectorate over the principalities, but this Julius was determined to prevent, and after trying in vain to use Cesare as a means of keeping out the Venetians, he had him arrested. Borgia's power was now at an end, and he was obliged to surrender all his castles in Romagna save Cesena, Forlì and Bettinoro, whose governors refused to accept an order of surrender from a master who was a prisoner. Finally, it was agreed that if Cesare were set at liberty he would surrender the castles; this having been accomplished, he departed for Naples, where the Spaniards were in possession. The Spanish governor, Gonzalo de Cordova, had given him a safe-conduct, and he was meditating fresh plans, when Gonzalo arrested him by the order of Ferdinand of Spain as a disturber of the peace of Italy (May 1504). In August he was sent to Spain, where he remained a prisoner for two years; in November 1506 he made his escape, and fled to the court of his brother-in-law, the king of Navarre, under whom he took service. While besieging the castle of Viana, held by the rebellious count of Lerin, he was killed (March 12, 1507).

Cesare Borgia was a type of the adventurers with which the Italy of the Renaissance swarmed, but he was cleverer and more scrupulous than his rivals. His methods of conquest were atrocious and treacherous; but once the conquest was made he governed his subjects with firmness and justice, so that his rule was preferred to the anarchy of factions and local despots. But he was certainly not a man of genius, as has long been imagined, and his success was chiefly due to the support of the papacy; once his father was dead his career was at an end, and he could no longer play a prominent part in Italian affairs. His fall proved in how unsound a basis his system had been built up.

The chief authorities for the life of Cesare Borgia are the same as those of Alexander VI., especially M. Creighton's *History of the Papacy*, vol. v. (London, 1897); F. Gregorovius's *Geschichte der Stadt Rom*, vol. vii. (Stuttgart, 1881); and F. Villari's *Machiavelli* (London 1892); also C. Yriarte's *César Borgia* (Paris, 1889), an admirable piece of writing; Schubert-Soldern, *Die Borgia und ihre Zeit* (Dresden, 1902), which contains the latest discoveries on the subject; and E. J. Davis, *Cesare Borgia, Duca di Romagna* (Imola, 1878). (L. V.)

BORGIA, FRANCIS (1510–1572), Roman Catholic saint, duke of Gandia, and general of the order of Jesuits, was born at Gandia (Valencia) on the 10th of October 1510, and from boyhood was remarkable for his piety. Educated from his twelfth year at Saragossa under the charge of his uncle the archbishop, he had begun to show a strong inclination towards the monastic life, when his father sent him in 1528 to the court of Charles V. Here he distinguished himself, and on his marriage with Eleanor de Castro, a Portuguese lady of high rank, he was created marquis of Lombay, and was appointed master of the horse to the empress. He accompanied Charles on his African expedition in 1535, and also into Provence in 1536; and on the death of the empress in 1539 he was deputed to convey the body to the burial-place in Granada. This sad duty confirmed his determination to leave the court, and also, should he survive his consort, to embrace the monastic life. On his return to Toledo, however, honours were thrust upon him, much against his will; he was made viceroy of Catalonia and commander of the order of St. James. At Barcelona, the seat of his government, he lived a life of great austerity, but discharged his official duties with energy and efficiency until 1543, when, having succeeded his

father in the dukedom, he at length obtained permission to resign his viceroyalty and to retire to a more congenial mode of life at Gandia. Having already held some correspondence with Ignatius Loyola, he now powerfully encouraged the recently founded order of Jesus. One of his first cares at Gandia was to build a Jesuit college; and on the death of Eleanor in 1546, he resolved to become himself a member of the society. The difficulties arising from political and family circumstances were removed by a papal dispensation, which allowed him, in the interests of his young children, to retain his dignities and worldly possessions for four years after taking the vows. In 1550 he visited Rome, where he was received with every mark of distinction, and where he furnished the means for building the Collegium Romanum. Returning to Spain in the following year, he formally resigned his rank and estate in favour of his eldest son, assumed the Jesuit habit, was ordained priest, and entered upon a life of penance and prayer. At his own earnest request, seconded by Loyola, a proposal that he should be created a cardinal by Julius III. was departed from; and at the command of his superior he employed himself in the work of itinerant preaching. In 1554 he was appointed commissary-general of the order in Spain, Portugal and the Indies, in which capacity he showed great activity, and was successful in founding many new and thriving colleges. In 1556, shortly after Charles V. retired, Borgia had an interview with him, but would not yield to his inducements to transfer his allegiance to the older order of Hieronymites. Some time afterwards Borgia was employed by Charles to conduct negotiations with reference to a project which was to secure for Don Carlos of Spain the Portuguese succession in the event of the death of his cousin Don Sebastian. On the death of Lainez in 1565, Francis Borgia was chosen to succeed him as third general of the Jesuits. In this capacity he showed great zeal and administrative skill; and so great was the progress of the society under his government that he has sometimes been called "its second founder." The peculiarities which are most characteristic of the order were, however, derived from Loyola and Lainez, rather than from Borgia, whose ideal was a simple monasticism rather than a life of manifold and influential contact with the world. He died at Rome on the 30th of September 1572. He was beatified by Urban VIII. in 1624, and canonized by Clement X. in 1671, his festival being afterwards (1683) fixed by Innocent XI. for the 10th of October.

Several works by St Francis Borgia have been published, the principal of these being a series of *Exercitia* similar to the *Exercitia Spiritualia* of Loyola, and a treatise *Rhetorica Concionandi*. The *Opera Omnia* were published at Brussels in 1675. His life was written by his confessor Pedro de Ribadeneira. See also A. Butler's *Lives of the Saints*, and the *Breviarium Romanum* (second nocturn for October 10).

BORGIA, LUCREZIA (1480–1519), duchess of Ferrara, daughter of Cardinal Rodrigo Borgia, afterwards Pope Alexander VI. (q.v.), by his mistress Vanozza dei Cattanei, was born at Rome in 1480. Her early years were spent at her mother's house near her father's splendid palace; but later she was given over to the care of Adriana de Mila, a relation of Cardinal Borgia and mother-in-law of Giulia Farnese, another of his mistresses. Lucrezia was educated according to the usual curriculum of Renaissance ladies of rank, and was taught languages, music, embroidery, painting, &c.; she was famed for her beauty and charm, but the corrupt court of Rome in which she was brought up was not conducive to a good moral education. Her father at first contemplated a Spanish marriage for her, and at the age of eleven she was betrothed to Don Cherubin de Centelles, a Spanish nobleman. But the engagement was broken off almost immediately, and Lucrezia was married by proxy to another Spaniard, Don Gasparo de Procida, son of the count of Aversa. On the death of Innocent VIII. (1492), Cardinal Borgia was elected pope as Alexander VI., and, contemplating a yet more ambitious marriage for his daughter, he annulled the union with Procida; in February 1493 Lucrezia was betrothed to Giovanni Sforza, lord of Pesaro, with whose family Alexander was now in close alliance. The wedding was celebrated in June; but when the pope's policy changed and he became friendly to the king

of Naples, the enemy of the house of Sforza, he planned the subjugation of the vassal lords of Romagna, and Giovanni, feeling his position insecure, left Rome for Pesaro with his wife. By Christmas 1495 they were back in Rome; the pope had all his children around him, and celebrated the carnival with a series of magnificent festivities. But he decided that he had done with Sforza, and annulled the marriage on the ground of the husband's impotence (March 1497). In order to cement his alliance with Naples, he married Lucrezia to Alphonso of Aragon, duke of Bisceglie, a handsome youth of eighteen, related to the Neapolitan king. But he too realized the fickleness of the Borgias' favour when Alexander backed up Louis XII. of France in the latter's schemes for the conquest of Naples. Bisceglie fled from Rome, fearing for his life, and the pope sent Lucrezia to receive the homage of the city of Spoleto as governor. On her return to Rome in 1499, her husband, who really loved her, was induced to join her once more. A year later he was murdered by the order of her brother Cesare. After the death of Bisceglie, Lucrezia retired to Nepi, and then returned to Rome, where she acted for a time as regent during Alexander's absence. The latter now was anxious for a union between his daughter and Alphonso, son and heir to Ercole d' Este, duke of Ferrara. The negotiations were somewhat difficult, as neither Alphonso nor his father was anxious for a connexion with the house of Borgia, and Lucrezia's own reputation was not unblemished. However, by bribes and threats the opposition was overcome, and in September 1501 the marriage was celebrated by proxy with great magnificence in Rome. On Lucrezia's arrival at Ferrara she won over her reluctant husband by her youthful charm (she was only twenty-two), and from that time forth she led a peaceful life, about which there was hardly a breath of scandal. On the death of Ercole in 1505, her husband became duke, and she gathered many learned men, poets and artists at her court, among whom were Ariosto, Cardinal Bembo, Aldus Manutius the printer, and the painters Titian and Dosso Dossi. She devoted herself to the education of her children and to charitable works; the only tragedy connected with this period of her life is the murder of Ercole Strozzi, who is said to have admired her and fallen a victim to Alphonso's jealousy. She died on the 24th of June 1510, leaving three sons and a daughter by the duke of Ferrara, besides one son Rodrigo by the duke of Bisceglie, and possibly another of doubtful paternity. She seems to have been a woman of very mediocre talents, and only played a part in history because she was the daughter of Alexander VI. and the sister of Cesare Borgia. While she was in Rome she was probably no better and no worse than the women around her, but there is no serious evidence for the charges of incest with her father and brothers which were brought against her by the scandal-mongers of the time.

See the bibliographies for ALEXANDER VI. and BORGIA, CESARE; and especially F. Gregorovius's *Lucrezia Borgia* (Stuttgart, 1874), the standard work on the subject; also W. Gilbert's *Lucrezia Borgia, Duchess of Ferrara* (London, 1869), which, while containing much information, is quite without historic value; and G. Campori's "Una Vittima della Storia, Lucrezia Borgia," in the *Nuova Antologia* (August 31, 1866), which aims at the rehabilitation of Lucrezia. (L. V.)

BORGLUM, SOLON HANNIBAL (1868—), American sculptor, was born in Ogden, Utah, on the 22nd of December 1868, the son of a Danish wood-carver. He studied under Louis F. Rebisso in the Cincinnati art school in 1895-1897, and under Frémiet in Paris. He took as his chief subjects incidents of western life, cowboys and Indians, with which he was familiar from his years on the ranch; notably "Lassoing Wild Horses," "Stampeding Wild Horses," "Last Round-up," "On the Border of White Man's Land," and "Burial on the Plains." His elder brother, Gutzon Borglum (b. 1867), also showed himself an artist of some originality.

BORGOGNONE, AMBROGIO (fl. 1473-1524), Italian painter of the Milanese school, whose real name was Ambrogio Stefani da Fossano, was approximately contemporary with Leonardo da Vinci, but represented, at least during a great part of his career, the tendencies of Lombard art anterior to the arrival of that master—the tendencies which he had adopted and perfected

from the hands of his predecessors Foppa and Zenale. We are not precisely informed of the dates either of the death or the birth of Borgognone, who was born at Fossano in Piedmont, and whose appellation was due to his artistic affiliation to the Burgundian school. His fame is principally associated with that of one great building, the Certosa, or church and convent of the Carthusians at Pavia, for which he worked much and in many different ways. It is certain, indeed, that there is no truth in the tradition which represents him as having designed, in 1473, the celebrated façade of the Certosa itself. His residence there appears to have been of eight years' duration, from 1486, when he furnished the designs of the figures of the virgin, saints and apostles for the choir-stalls, executed in *tarsia* or inlaid wood work by Bartolommeo Pola, till 1494, when he returned to Milan. Only one known picture, an altar-piece at the church San Eustorgio, can with probability be assigned to a period of his career earlier than 1486. For two years after his return to Milan he worked at the church of San Satiro in that city. From 1497 he was engaged for some time in decorating with paintings the church of the Incoronata in the neighbouring town at Lodi. Our notices of him thenceforth are few and far between. In 1508 he painted for a church in Bergamo; in 1512 his signature appears in a public document of Milan; in 1524—and this is our last authentic record—he painted a series of frescoes illustrating the life of St Sisinius in the portico of San Simpliciano at Milan. Without having produced any works of signal power or beauty, Borgognone is a painter of marked individuality. He holds an interesting place in the most interesting period of Italian art. The National Gallery, London, has two fair examples of his work—the separate fragments of a silk banner painted for the Certosa, and containing the heads of two kneeling groups severally of men and women; and a large altar-piece of the marriage of St Catherine, painted for the chapel of Rebecchino near Pavia. But to judge of his real powers and peculiar ideals—his system of faint and clear colouring, whether in fresco, tempera or oil; his somewhat slender and pallid types, not without something that reminds us of northern art in their Teutonic sentimentality as well as their Teutonic fidelity of portraiture; the conflict of his instinctive love of placidity and calm with a somewhat forced and borrowed energy in figures where energy is demanded, his conservatism in the matter of storied and minutely diversified backgrounds—to judge of these qualities of the master as they are, it is necessary to study first the great series of his frescoes and altar-pieces at the Certosa, and next those remains of later frescoes and altar-pieces at Milan and Lodi, in which we find the influence of Leonardo and of the new time mingling with, but not expelling his first predilections.

BORGO SAN DONNINO, a town and episcopal see of Emilia, Italy, in the province of Parma, 14 m. N.W. by rail from the town of Parma. Pop. (1901) town, 6251; commune, 12,100. It occupies the site of the ancient Fidentia, on the Via Aemilia; doubt, as its name shows, of Roman origin. Here M. Lucius defeated the democrats under Carbo in 82 B.C. It was independent under Vespasian, but seems soon to have become a vassal dependent on Parma. Its present name comes from the martyrdom of S. Dominus under Maximian in A.D. 304. The cathedral erected in honour of this saint, is one of the finest and best preserved Lombardo-Romanesque churches of the 11th-12th centuries in north Italy. The upper part of the façade is incomplete, but the lower, with its three portals and sculptures, is fine; the interior is simple and well-proportioned, and has not been spoilt by restorations. For the *benitier*, a work of the 11th century, see *Rassegna d'Arte*, 1905, 180. Not far from town is the small church of S. Antonio del Viennese, a 13th century structure in brick (ib., 1906, 22). The Palazzo Comunale in the Gothic-Lombard style, is a work of the 14th century. Borgo S. Donnino is an important centre for the production of cattle of Emilia. (T. Ag.)

BORGU, or **BARBA**, an inland country of West Africa. The western part is included in the French colony of Dahomey; the eastern division forms the Borgu province of the British protectorate of Nigeria. Borgu is bounded N.E. and E. by

Niger, S. by the Yoruba country, N.W. by Gurma. The country consists of an elevated plain traversed by rivers draining north or east to the Niger. The water-parting between the Niger basin and the coast streams of Dahomey and Lagos runs north-east and south-west near the western frontier. In about 10° N., below the town of Bussa, rapids block the course of the Niger, navigable up to that point from the sea. The soil is mostly fertile, and is fairly cultivated, producing in abundance millet, yams, plantains and limes. The acacia tree is common, and from it gum-arabic of good quality is obtained. From the nut of the horse-radish tree ben oil is expressed. Cattle are numerous and of excellent breed, and game is abundant. Borgu is inhabited by a number of pagan negro tribes, several of whom were dependent on the chief of Nikki, a town in the centre of the country, the chief being spoken of as sultan of Borgu. The king of Bussa was another more or less powerful potentate. In the early years of the 19th century Borgu was invaded by the Fula (q.v.), but the Bariba (as the people are called collectively) maintained their independence. In 1804 Borgu became the object of rivalry between France and England. The Royal Niger Company, which had already concluded a treaty of protection with the king of Bussa, sent out Captain (afterwards Sir) F. D. Lugard to negotiate treaties with the king of Nikki and other chiefs, and Lugard succeeded in doing so a few days before the arrival of French expeditions from the west. Disregarding the British treaties, French officers concluded others with various chiefs, invaded Bussa and established themselves at various points on the Niger. To defend British interests, the West African Frontier Force was raised locally under Lugard's command, and a period of great tension ensued, British and French troops facing one another at several places. A conflict was, however, averted, and by the convention of June 1898 the western part of Borgu was declared French and the eastern British, the French withdrawing from all places on the lower Niger.

The British portion of Borgu has an area of about 12,000 sq. m. Up to the period of inclusion within the protectorate of Nigeria little or nothing was known of the country, though there were interesting legends of the antiquity of its history. The population was entirely independent, and resisted with success not only the Fula from the north but also the armies of Dahomey and Mossi from the south and west. Travellers who attempted to penetrate this country had never returned. Since 1898 the country has been opened, and from being the most lawless and truculent of people the Bariba have become singularly amenable and law-abiding. Provincial courts are established, but there is little crime in the province. The British garrisons have been replaced by civil police. The assessment of taxes under British administration was successfully carried out in 1904, and taxes are collected without trouble. In south Borgu the people are agricultural but not industrious or inclined for trade. In the north there are some pastoral settlements of Fula. The Bariba themselves remain agricultural. Cart-roads have been constructed between the town of Kiama and the Niger. The agricultural resources of Borgu are great, and as the population increases with the cessation of war and by immigration the country should show marked development. Shea trees are abundant. Elephants are still to be found in the fifty-mile strip of forest land which stretches between the Niger and the interior of the province. The forest contains valuable sylvan products, and there are great possibilities for the cultivation of rubber. There are also extensive areas of fine land suitable for cotton, with the water-way of the Niger close at hand. Labour might be brought from Yorubaland close by, and a Yoruba colony has been experimentally started. (See NIGERIA and BUSSA.)

BORIC ACID, or **BORACIC ACID**, H_2BO_3 , an acid obtained by dissolving boron trioxide in water. It was first prepared by Wilhelm Homberg (1652-1715) from borax, by the action of mineral acids, and was given the name *sal sedativum Hombergi*. The presence of boric acid or its salts has been noted in sea-water, whilst it is also said to exist in plants and especially in almost all fruits (A. H. Allen, *Analys.*, 1904, 301). The free acid is found native in certain volcanic districts such as Tuscany, the Lipari

Islands and Nevada, issuing mixed with steam from fissures in the ground; it is also found as a constituent of many minerals (borax, boracite, boronatrocalcite and colemanite).

The chief source of boric acid for commercial purposes is the Maremma of Tuscany, an extensive and desolate tract of country over which jets of vapour and heated gases (*soffioni*) and springs of boiling water spurt out from chasms and fissures. In some places the fissures open directly into the air, but in other parts of the district they are covered by small muddy lakes (*logoni*). The soffioni contain a small quantity of boric acid (usually less than 0.1%), together with a certain amount of ammoniacal vapours. In order to obtain the acid, a series of basins is constructed over the vents, and so arranged as to permit of the passage of water through them by gravitation. Water is led into the highest basin and by the action of the heated gases is soon brought into a state of ebullition; after remaining in this basin for about a day, it is run off into the second one and is treated there in a similar manner. The operation is carried on through the entire series, until the liquor in the last basin contains about 2% of boric acid. It is then run into settling tanks, from which it next passes into the evaporating pans, which are shallow lead-lined pans heated by the gases of the soffioni. These pans are worked on a continuous system, the liquor in the first being concentrated and run off into a second, and so on, until it is sufficiently concentrated to crystallize. The crystals are purified by recrystallization from water. Artificial soffioni are sometimes prepared by boring through the rock until the fissures are reached, and the water so obtained is occasionally sufficiently impregnated with boric acid to be evaporated directly. Boric acid is also obtained from boronatrocalcite by treatment with sulphuric acid, followed by the evaporation of the solution so obtained. The residue is then heated in a current of superheated steam, in which the boric acid volatilizes and distils over. It may also be obtained by the decomposition of boracite with hot hydrochloric acid. In small quantities, it may be prepared by the addition of concentrated sulphuric acid to a cold saturated solution of borax.



Boric acid crystallizes from water in white nacreous laminae belonging to the triclinic system; it is difficultly soluble in cold water, but dissolves readily in hot water. It is one of the "weak" acids, its dissociation constant being only 0.0169 (J. Walker, *Jour. of Chem. Soc.*, 1900, lxxvii. 5), and consequently its salts are appreciably hydrolysed in aqueous solution. The free acid turns blue litmus to a claret colour. Its action upon turmeric is characteristic; a turmeric paper moistened with a solution of boric acid turns brown, the colour becoming much darker as the paper dries; while the addition of sodium or potassium hydroxide turns it almost black. Boric acid is easily soluble in alcohol, and if the vapour of the solution be inflamed it burns with a characteristic vivid green colour. The acid on being heated to 100° C. loses water and is converted into *metaboric acid*, HBO_2 ; at 140° C. *pyroboric acid*, $H_2B_2O_4$, is produced; at still higher temperatures boron trioxide is formed. The salts of the normal or orthoboric acid in all probability do not exist; metaboric acid, however, forms several well-defined salts which are readily converted, even by carbon dioxide, into salts of pyroboric acid. That orthoboric acid is a tribasic acid is shown by the formation of ethyl orthoborate on esterification, the vapour density of which corresponds to the molecular formula $B(OC_2H_5)_3$; the molecular formula of the acid must consequently be $B(OH)_3$ or H_3BO_3 . The metallic borates are generally obtained in the hydrated condition, and with the exception of those of the alkali metals, are insoluble in water. The most important of the borates is sodium pyroborate or borax (q.v.).

Borax and boracic acid are feeble but useful antiseptics. Hence they may be used to preserve food-substances, such as milk and butter (see ADULTERATION). In medicine boric acid is used in solution to relieve itching, but its chief use is as a mild antiseptic to impregnate lint or cotton-wool. Recent work has shown it is too feeble to be relied upon alone, but where really efficient antiseptics, such as mercuric chloride and iodide, and carbolic acid, have been already employed, boric acid (which, unlike these, is non-poisonous and non-irritant) may legitimately be used to maintain the aseptic or non-bacterial condition which they have obtained. Borax taken internally is of some value in irritability of the bladder, but as a urinary antiseptic it is now surpassed by several recently introduced drugs, such as urotropine.

BORING. The operations of deep boring are resorted to for ascertaining the nature, thickness and extent of the various

geological formations underlying the surface of the earth. Among the purposes for which boring is specifically employed are: (1) prospecting or searching for mineral deposits; (2) sinking petroleum, natural gas, artesian or salt wells; (3) determining the depth below the surface of bed-rock or other firm substratum, together with the character of the overlying materials, preparatory to mining or civil engineering operations; (4) carrying on geological or other scientific explorations.

Prospecting by boring is practised most successfully in the case of mineral deposits of large area, which are nearly horizontal, or at least not highly inclined; e.g. deposits of coal, iron, lead and salt. Wide, flat beds of such minerals may be pierced at any desired number of points. The depth at which each hole enters the deposit and the thickness of the mineral itself are readily ascertained, so that a map may be constructed with some degree of accuracy. Samples of the mineral are also secured, furnishing data as to the value of the deposit. While boring is sometimes adopted for prospecting irregular and steeply inclined mineral deposits of small area, the results are obviously less trustworthy than under the conditions named above, and may be actually misleading unless a large number of holes are bored. Incidentally, bore-holes supply information as to the character and depth of the valueless depositions of earth or rock overlying the mineral deposit. Such data assist in deciding upon the appropriate method for, and in estimating the cost of, sinking shafts or driving tunnels for the development and exploitation of the deposit. In sinking petroleum wells, boring serves not only for discovering the oil-bearing strata but also for extracting the oil. This industry has become of great importance in many parts of the United States, in southern Russia and elsewhere. Rock salt deposits are sometimes worked through bore-holes, by introducing water and pumping out the solution of brine for further treatment. The sinking of artesian wells is another application of boring. They are often hundreds, and sometimes thousands, of feet in depth. A well in St Louis, Missouri, has a depth of 3843 ft.

Boring is useful in mines themselves for a variety of purposes, such as exploring the deposit ahead of the workings, searching for neighbouring veins, and sounding the ground on approaching dangerous inundated workings. In the coal regions of Pennsylvania, bore-holes are often sunk for carrying steam pipes and hoisting ropes underground at points remote from a shaft.

Several of the methods of boring in soft ground are employed in connexion with civil engineering operations; as for ascertaining the depth below the surface to solid rock, preparatory to excavating for and designing deep foundations for heavy structures, and for estimating the cost of large scale excavations in earth and rock.

Lastly, a number of deep holes have been bored for geological exploration or for observing the increase of temperature in depth in the earth's crust; for example, at Paruschowitz, Silesia, about 6700 ft. deep; at Leipzig, Germany, 6265 ft.; near Pittsburg, Pennsylvania, 5532 ft.; and at Wheeling, West Virginia, nearly 5000 ft. The two last mentioned were intended to obtain as complete a knowledge as possible of the bituminous coal and oil-bearing formations.

There are five methods of boring, viz.: by (1) earth augers, (2) drive pipes, (3) long, jointed rods and drop drill, (4) the rope system, in which the rods are replaced by rope, (5) rotary drills. The first two methods are adapted to soft or earthy soils only; the others are for rock.

1. *Earth augers* comprise spiral and pod augers. The ordinary spiral auger resembles the wood auger commonly used by carpenters. It is attached to the rod or stem by a socket joint, successive sections of rod being added as the hole is deepened. The auger is rotated by means of horizontal levers, clamped to the rod—by hand for holes of small diameter (2 to 6 in.), the larger sizes (8 to 16 in.) by horse power. Clayey, cohesive soils, containing few stones, are readily bored; stony ground with difficulty. The operation of the auger is intermittent. After a few revolutions it is raised and emptied, the soil clinging between the spirals. Depths to 50 or 60 ft. are usually bored by hand; deeper holes by horse power. For sandy, non-cohesive soils, the auger may be encircled by a close-fitting sheet-iron cylinder to prevent the soil from falling out.

Pod augers generally vary in diameter from 8 to 20 in. A common form (fig. 1) consists of two curved iron plates, one attached to the rod rigidly, the other by hinge and key. By being turned through a few revolutions the pod is filled, and is then raised and emptied. For boring in sandy soils, the open sides are closed by hinged plates. Fig. 2 shows another type of pod auger. For holes of large diameter earth augers are handled with the aid of a light derrick.

2. *Drive pipes* are widely used, both for testing the depth and character of soft material overlying solid rock and as a necessary preliminary to rock boring, when some thickness of surface soil must first be passed through. In its simplest form the drive pipe consists of one or more lengths of wrought iron pipe, open at both ends and from $\frac{1}{2}$ in. to 6 in. diameter. When of small size the pipe is driven by a heavy hammer; for deep and large holes, a light pile-driver becomes necessary. The lower end of the pipe is provided with an annular steel shoe; the upper end has a drivehead for receiving the blows of the hammer. Successive lengths are screwed on as required. For shallow holes the pipe is cleaned out by a "bailer" or "sand-pump"—a cylinder 4 to 6 ft. long, with a valve in the lower end. It is lowered at intervals, filled by being dashed up and down, and then raised and emptied. If, after reaching some depth, the external frictional resistance prevents the pipe from sinking farther, another pipe of small diameter may be inserted and the driving continued. Drive pipes are often sunk by applying weights at the surface and slowly rotating by a lever. Two pipes are then used, one inside the other. Water is pumped down the inner pipe, thus loosening the soil, raising the debris and increasing the speed of driving. The "driven well" for water supply is an adaptation of the drive pipe and put down in the same way.

3. *Drill and Rods*.—This method has long been used in Europe and elsewhere for deep boring. In the United States it is rarely employed for depths greater than 200 or 300 ft. The usual form of cutting tool or drill is shown in fig. 3. The iron rods are from 1 to 2 in. square, in long lengths with screw joints (fig. 4). Wooden rods are occasionally used. For shallow holes (50 to 75 ft.) the work is done by hand, one or two cross-bars being clamped to the rod. The men alternately raise and drop the drill, meanwhile slowly walking around and around to rotate the bit and so keep the hole true. The cuttings are cleaned out by a bailer, as for drive pipes.

In boring by hand, the practical limit of depth is soon reached, on account of the increasing weight of the rods. For going deeper a "spring-pole" may be used. This is a tapering pole, say 30 ft. long and 5 or 6 in. diameter at the small end. It rests in an inclined position on a fulcrum set about 10 ft. from the butt, the latter being firmly fixed. The rods are suspended from the end of the pole, which extends at a height of several feet over the mouth of the hole. With the aid of the spring of the pole the strokes are produced by a slight effort on the part of the driller. Average speeds of 6 to 10 ft. per 10 hours are easily made, to depths of 200 to 250 ft.

For deep boring the rod system requires a more elaborate plant. The rods are suspended from a heavy "walking beam" or lever, usually oscillated by a steam engine. By means of a screw-feed device, the rods, which are rotated slightly after every stroke, are gradually fed down as the hole is deepened, length after length being added. A tall derrick carries the sheaves and ropes by which the rods and tools are manipulated. The drill bit cannot be attached rigidly to the rods as in shallow boring, because the momentum of the heavy moving parts, transmitted directly to the bit as the blow is struck, would cause excessive vibration and breakage. It becomes necessary, therefore, to introduce a sliding-link joint between the rods and bit. One form of link is shown in fig. 5. On striking its blow, the bit comes to rest, while the rods continue to descend to the end of the stroke, the upper member of the link sliding down upon the lower. Then, on the up stroke the lower link, with the bit, is raised for delivering another blow. For large holes the striking weight is, say, 800 to 1000 lb, length of stroke $2\frac{1}{2}$ to 5 ft., and speed from 20 to 30 strokes per minute.

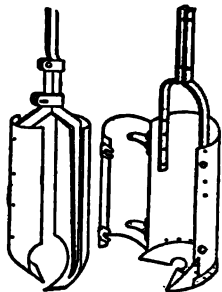

FIG. 1.

FIG. 2.

Pod Auger.

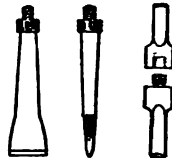

FIG. 3.

FIG. 4.

Drill Bit.

Rod Joint.

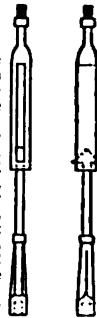

FIG. 5.

Sliding Link.

By using the sliding link the cross-section and weight of the rods may be greatly reduced, the only strain being that of tension. To deliver a sharp, effective blow, however, the rods must drop with a quick stroke, which brings a heavy strain upon the operating machinery. For overcoming this difficulty, various "free-falling tools" have been devised. By these the bit is allowed to fall



FIG. 6.
Kind Free-Falling Tool.

by gravity; the rod follows on its measured down stroke, and picks up the bit. Free-falling tools are of two classes: (1) those by which the bit is released automatically; (2) those operated by a sudden twist imparted to the rod by the drillman. One of the best known of the first class is the Kind free-fall (fig. 6). The shank of the bit is gripped and released by the jaws J, J, worked through a toggle joint by movements of the disk D. When the rod begins its downward stroke, the resistance of the water in the hole slightly raises D, thus opening the jaws and releasing the bit, which falls by gravity. On reaching the end of the stroke the jaws again catch the shank of the bit and raise it for delivering another blow. The Fabian free-fall may be noted as an example of the second class (see Köhler, *Lehrbuch der Bergbaukunde*, p. 57). Tools are sometimes used for cutting an annular groove in the bottom of the hole, and raising to the surface the core so formed, for observing the character of the rock.

4. Rope and Drop Tools.—This method was long ago used in China. Because of its extensive application in the oil-fields it is generally designated in the United States as the "oil-well system." In its various modifications it is often employed also in general prospecting of mineral deposits and in sinking artesian, natural gas and salt wells. One of its forms is known in England as the Mather & Platt system.

The chief point of difference from rod-boring is the substitution of rope for the jointed rods. For deep boring it possesses the advantage of saving the large amount of time consumed in raising and lowering the rods, as required whenever the hole is to be cleaned out, or a dull bit replaced, since the tools are rapidly run up or down by means of the rope with which they are operated while drilling. The speed of rope-boring is therefore but little affected by increase of depth, while with rod-boring it falls off rapidly. In its simplest form the so-called "string of tools," suspended from the rope, is composed of the bit or drill, jars and rope-socket. The jars are a pair of sliding links, similar to those used for rod-boring, but serving a different purpose, viz. to produce a sharp shock on the upward stroke, as the jars come together, for loosening the bit should it tend to stick fast in the hole. A heavy jar (auger stem) is generally inserted between the jars and bit, for increasing the force of the blow. The weight of another jar above the jars (sinker-bar) keeps the rope taut. The length of stroke and feed are regulated by the "temper-screw" (fig. 7), a feed device resembling that used for rod-boring. Clamped to it is the drill rope, which is let out at intervals, as the hole is deepened. The bits usually range from 3 to 8 in. diameter, the speed of boring being generally between 20 and 40 ft. per 24 hours, according to the kind of rock. A great variety of special "fishing tools" are made, for use in case of breakage of parts in the hole or other accident.



FIG. 7.
Temper Screw.

5. Diamond Drill.—The methods described above are capable of boring holes vertically downward only. By the diamond drill, holes can be bored in any direction, from vertically downward to vertically upward. It has the further advantage of making an annular hole from which is obtained a core, furnishing a practically complete cross-section of the strata penetrated; the thickness and character of each stratum are shown, together with its depth below the surface. Thus, the diamond drill is peculiarly well adapted for prospecting mineral deposits from which samples are desired. The first practical application of diamonds for drilling in rock was made in 1863 by Professor Rudolph Leachot, a civil engineer of Paris.

The apparatus consists essentially of a line of hollow rods, coupled by screw joints, an annular steel bit or crown, set with diamonds, being attached to the lower end. By means of a small engine on the surface the rods are rapidly rotated and fed down automatically as the hole is deepened. The speed of rotation is from 300 to 800 revolutions per minute, depending on the character of the rock and diameter of the bit. While boring a stream of water is forced down the hollow rods by a pump, passing back to the surface through the annular space between the rods and the walls of the drill hole. The cuttings are thus carried to the surface, leaving the bottom of the hole

clean and unobstructed. For recovering the core and inspecting the bit and diamonds, the rods are raised at every 3 to 8 ft. of depth. This is done by a small drum and rope, operated by the driving engine.

Diamond drills of standard designs (fig. 8) bore holes from 1 1/4 to 2 1/2 in. diameter, yielding cores of 1 to 1 1/2 in. diameter, and are capable of reaching depths of a few hundred to 4000 ft. or more. They require from 8 to 30 boiler horse-power. Large machines will bore shallower holes up to 6, 9 or even 12 in. diameter. For operating

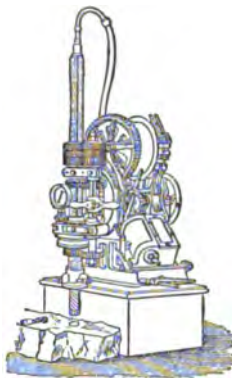

FIG. 8.—Little Champion Rock Drill.

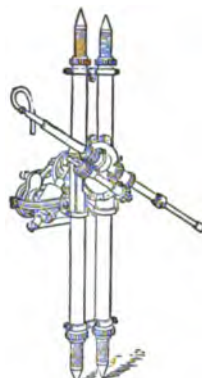

FIG. 9.

in underground workings of mines, small and compact machines are sometimes mounted on columns (fig. 9). They bore 1 1/4 to 1 3/4 in. holes to depths of 300 to 400 ft., cores being 3/4 to 1 in. diameter. Hand-power drills are also built. In the South African goldfields several diamond drill holes from 4500 to 5200 ft. deep have been successfully bored. Rates of advance for core-drilling to moderate depths range usually from 2 to 3 ft. per hour, including ordinary delays, though in favourable rock much higher speeds are often attained. In deep holes the speeds diminish, because of time consumed in raising and lowering the rods. If no core is desired a "solid bit" is used. The drilling then proceeds faster, as it is only necessary to raise the rods occasionally, for examining the condition of the bit.

The driving engine has two inclined cylinders, coupled to a crank-shaft by which, through gearing, the drill-rod is rotated. The rods are wrought iron or steel tubes, in 5 to 10 ft. lengths. For producing the feed two devices are employed, the differential screw and hydraulic cylinder. For the differential feed (fig. 9) the engine has a hollow left-hand threaded screw-shaft, to which the rods are coupled. This shaft is driven by a spline and bevel gearing and is supported by a threaded feed-nut, carried in the lower bearing. Geared to the screw-shaft is a light counter-shaft. By properly proportioning the number of teeth in the system of gear-wheels, the feed-nut is caused to revolve a little faster than the screw-shaft, so that the drill-rod is fed downward a small fraction of an inch for each revolution. To vary the rate of feed, as suitable for different rocks, three pairs of gears with different ratios of teeth are provided. The screw-shaft and gearing are carried by a swivel-head, which can be rotated in a vertical plane, for boring holes at an angle.

The hydraulic feed is an improvement on the above, in that the rate of feed is independent of the rotative speed of the rods and can be adjusted with the utmost nicety. There are either one or two feed cylinders, supplied with water from the pump. The rod, while rotating freely, is supported by the feed cylinder piston and caused to move slowly downward by allowing the water to pass from the lower to the upper part of the cylinder. A valve regulates the passage of the water and hence the rate of feed.

The bit (fig. 10 and fig. 11, B) is of soft steel, set with six to eight or more diamonds, according to its diameter. The diamonds, usually from 1 1/2 to 2 1/2 carats in size, are carefully set in the bit, projecting but slightly from its surface. Two kinds of diamonds are used, "carbons" and "borts." The carbons are opaque, dark



FIG. 10.

Diamond Drill Bit. rods are wrought iron or steel tubes, in 5 to 10 ft. lengths. For producing the feed two devices are employed, the differential screw and hydraulic cylinder. For the differential feed (fig. 9) the engine has a hollow left-hand threaded screw-shaft, to which the rods are coupled. This shaft is driven by a spline and bevel gearing and is supported by a threaded feed-nut, carried in the lower bearing. Geared to the screw-shaft is a light counter-shaft. By properly proportioning the number of teeth in the system of gear-wheels, the feed-nut is caused to revolve a little faster than the screw-shaft, so that the drill-rod is fed downward a small fraction of an inch for each revolution. To vary the rate of feed, as suitable for different rocks, three pairs of gears with different ratios of teeth are provided. The screw-shaft and gearing are carried by a swivel-head, which can be rotated in a vertical plane, for boring holes at an angle.



FIG. 11.

Core-Lifter and Barrel. The bit (fig. 10 and fig. 11, B) is of soft steel, set with six to eight or more diamonds, according to its diameter. The diamonds, usually from 1 1/2 to 2 1/2 carats in size, are carefully set in the bit, projecting but slightly from its surface. Two kinds of diamonds are used, "carbons" and "borts." The carbons are opaque, dark

in colour, tougher than the brilliant, and have no cleavage planes. They are therefore suitable for drilling in hard rock. Boris are rough, imperfect brilliants, and are best used for the softer rocks. As the bit wears, the stones must be reset from time to time. The wear of carbons in a well-set bit is small, though extremely variable. Above the bit are the core-lifter and core-barrel. The core-lifter (fig. 11, A) is a device for gripping and breaking off the core and raising it to the surface. The barrel, 3 to 10 ft. long, fits closely in the hole and is often spirally grooved for the passage of the water and débris. It serves partly as a guide, tending to keep the hole straight, partly for holding and protecting the core.

Diamond drills do not work satisfactorily in broken, fissured rock, as the carbons are liable to be injured, loosened or torn from their settings. In these circumstances, and for soft rocks, the diamond bit may be replaced by a steel toothed bit. Another apparatus for core-drilling is the Davis Calyx drill. For hard rock it has an annular bit, accompanied by a quantity of chilled steel shot; for soft rock, a toothed bit is used.

Diamond drill holes are rarely straight, and usually deviate considerably from the direction in which they are started. Very deep holes have been found to vary as much as 45° and even 60° from their true direction. This is due to the fact that the rods do not fit closely in the hole and therefore bend. It is also likely to occur in drilling through inclined strata, especially when of different degrees of hardness. By using a long and closely fitting core-barrel the liability to deviation is reduced, but cannot be wholly prevented. Holes which are nearly horizontal always deflect upward, because the sag of the rods tilts up the bit. Diamond drill holes should therefore always be surveyed. This is done by lowering into the hole instruments for observing at a number of successive points the direction and degree of deviation.¹ If accurately surveyed a crooked hole may be quite as useful as a straight one.

AUTHORITIES. — For further information on boring see *Trans. Amer. Inst. Mining Engs.* vol. ii. p. 241, vol. xxvii. p. 123; C. le Neve Foster, *Text-book of Ore and Stone Mining*, chap. iii.; *Glebauch*, 9th December 1899, 20th and 27th May 1905; *Scientific American*, 21st August 1886; *Engineering and Mining Jour.* vol. lviii. p. 268, vol. lxx. p. 699, vol. lxxx. p. 920; *Trans. Inst. Mining Engs.*, England, vol. xxiii. p. 685; *School of Mines Quarterly*, N. Y., vol. xvi. p. 1; *Zeitschr. für Berg-, Hütten- und Salinenwesen*, vol. xxv. p. 29; Denny, "Diamond Drilling," *Mines and Minerals*, vol. xx., August 1899, p. 7, to January 1900, p. 241; *Mining Jour.*, 26th January 1901; *Mining and Scientific Press*, 28th November 1903, p. 353; *Ost. Zeitschr. für Berg- und Hüttenwesen*, 21st May, 4th June 1904; *Trans. Inst. Mining and Metallurgy*, vol. xii. p. 301; *Engineering Magazine*, March 1896, p. 1075. (R. P.)

BORIS FEDOROVICH GODUNOV, tsar of Muscovy (c. 1551-1605), the most famous member of an ancient, now extinct, Russian family of Tatar origin, which migrated from the Horde to Muscovy in the 14th century. Boris' career of service began at the court of Ivan the Terrible. He is mentioned in 1570 as taking part in the Serpeisk campaign as one of the archers of the guard. In 1571 he strengthened his position at court by his marriage with Maria, the daughter of Ivan's abominable favourite Maljuta Skuratov. In 1580 the tsar chose Irene, the sister of Boris, to be the bride of the tsarevich Theodore, on which occasion Boris was promoted to the rank of boyar. On his deathbed Ivan appointed Boris one of the guardians of his son and successor; for Theodore, despite his seven-and-twenty years, was of somewhat weak intellect. The reign of Theodore began with a rebellion in favour of the infant tsarevich Demetrius, the son of Ivan's fifth wife Marie Nagaya, a rebellion resulting in the banishment of Demetrius, with his mother and her relations, to their appanage at Uglich. On the occasion of the tsar's coronation (May 31, 1584), Boris was loaded with honours and riches, yet he held but the second place in the regency during the lifetime of his co-guardian Nikita Romanovich, on whose death, in August, he was left without any serious rival. A conspiracy against him of all the other great boyars and the metropolitan Dionysy, which sought to break Boris' power by divorcing the tsar from Godunov's childless sister, only ended in the banishment or tonsuring of the malcontents. Henceforth Godunov was omnipotent. The direction of affairs passed entirely into his hands, and he corresponded with foreign princes as their equal. His policy was generally pacific, but always most prudent. In 1595 he recovered from Sweden the towns lost during the former reign. Five years previously he had defeated a Tatar raid upon Moscow, for which service he received the title of *sluga*,

an obsolete dignity even higher than that of boyar. Towards Turkey he maintained an independent attitude, supporting an anti-Turkish faction in the Crimea, and (furnishing the emperor with subsidies in his war against the sultan. Godunov encouraged English merchants to trade with Russia by exempting them from tolls. He civilized the north-eastern and south-eastern borders of Muscovy by building numerous towns and fortresses to keep the Tatar and Finnic tribes in order. Samara, Saratov, and Tsaritsyn and a whole series of lesser towns derive from him. He also re-colonized Siberia, which had been slipping from the grasp of Muscovy, and formed scores of new settlements, including Tobolsk and other large centres. It was during his government that the Muscovite church received its patriarchate, which placed it on an equality with the other Eastern churches and emancipated it from the influence of the metropolitan of Kiev. Boris' most important domestic reform was the *ukaz* (1587) forbidding the peasantry to transfer themselves from one landowner to another, thus binding them to the soil. The object of this ordinance was to secure revenue, but it led to the institution of serfdom in its most grinding form. The sudden death of the tsarevich Demetrius at Uglich (May 15, 1591) has commonly been attributed to Boris, because it cleared his way to the throne; but this is no clear proof that he was personally concerned in that tragedy. The same may be said of the many, often absurd, accusations subsequently brought against him by jealous rivals or ignorant contemporaries who hated Godunov's reforms as novelties.

On the death of the childless tsar Theodore (January 7, 1598), self-preservation quite as much as ambition constrained Boris to seize the throne. Had he not done so, lifelong seclusion in a monastery would have been his lightest fate. His election was proposed by the patriarch Job, who acted on the conviction that Boris was the one man capable of coping with the extraordinary difficulties of an unexampled situation. Boris, however, would only accept the throne from a *Zemsky Sobor*, or national assembly, which met on the 17th of February, and unanimously elected him on the 21st. On the 21st of September he was solemnly crowned tsar. During the first years of his reign he was both popular and prosperous, and ruled the people excellently well. Enlightened as he was, he fully recognized the intellectual inferiority of Russia as compared with the West, and did his utmost to bring about a better state of things. He was the first tsar to import foreign teachers on a great scale, the first to send young Russians abroad to be educated, the first to allow Lutheran churches to be built in Russia. He also felt the necessity of a Baltic seaboard, and attempted to obtain Livonia by diplomatic means. He cultivated friendly relations with the Scandinavians, in order to intermarry if possible with foreign royal houses, so as to increase the dignity of his own dynasty. That Boris was one of the greatest of the Muscovite tsars there can be no doubt. But his great qualities were overbalanced by an incurable suspiciousness, which made it impossible for him to act cordially with those about him. His fear of possible pretenders induced him to go so far as to forbid the greatest of the boyars to marry. He also encouraged informers and persecuted suspects on their unsupported statements. The Romanov family in especial suffered severely from these delations. Boris died suddenly (April 13, 1605), leaving one son, Theodore II., who succeeded him for a few months and then was foully murdered by the enemies of the Godunovs.

See Platon Vasilievich Pavlov, *On the Historical Significance of the Reign of Boris Godunov* (Rus.) (Moscow, 1850); Serguei Mikhailovich Solovev, *History of Russia* (Rus.) (2nd ed., vols. vii.-viii., St Petersburg, 1897). (R. N. B.)

BORISOGLYBSK, a town of Russia, in the government of Tambov, 100 m. S.E. of the city of that name, in 51° 22' N lat and 43° 4' E. long. It was founded in 1646 to defend the southern frontiers of Muscovy against the Crimean Tatars, and in 1666 was surrounded by wooden fortifications. The principal industries are the preparation of wool, iron-casting, soap-boiling, tallow-melting, and brick-making; and there is an active trade in grain, wool, cattle, and leather, and two important annual fairs. Pop. (1867) 12,254; (1897) 22,370.

¹ Brough, *Mine Surveying*, pp. 276-278; Marriott, *Trans. Inst. Mining and Metallurgy*, vol. xiv. p. 255.

BORKU, or **BORCU**, a region of Central Africa between 17° and 19° N. and 18° and 21° E., forming part of the transitional zone between the arid wastes of the Sahara and the fertile lands of the central Sudan. It is bounded N. by the Tibesti Mountains, and is in great measure occupied by lesser elevations belonging to the same system. These hills to the south and east merge into the plains of Wadai and Darfur. South-west, in the direction of Lake Chad, is the Bodele basin. The drainage of the country is to the lake, but the numerous khors with which its surface is scored are mostly dry or contain water for brief periods only. A considerable part of the soil is light sand drifted about by the wind. The irrigated and fertile portions consist mainly of a number of valleys separated from each other by low and irregular limestone rocks. They furnish excellent dates. Barley is also cultivated. The northern valleys are inhabited by a settled population of Tibbu stock, known as the Daza, and by colonies of negroes; the others are mainly visited by nomadic Berber and Arab tribes. The inhabitants own large numbers of goats and asses.

A caravan route from Barca and the Kufra oasis passes through Borku to Lake Chad. The country long remained unknown to Europeans. Gustav Nachtigal spent some time in it in the year 1871, and gave a valuable account of the region and its inhabitants in his book, *Sahara and Sudan* (Berlin, 1879-1889). In 1899 Borku, by agreement with Great Britain, was assigned to the French sphere of influence. The country, which had formerly been periodically raided by the Walad Siiman Arabs, was then governed by the Senussi (q.v.), who had placed garrisons in the chief centres of population. From its raids were made on French territory. In 1907 a French column from Kanem entered Borku, but after capturing Ain Galakka, the principal Senussi station, retired. Borku is also called Borgu, but must not be confounded with the Borgu (q.v.) west of the Niger.

A summary of Nachtigal's writing on Borku will be found in section 28 of *Gustav Nachtigal's Reisen in der Sahara und im Sudan* (1 vol.), arranged by Albert Fränkel (Leipzig, 1887). See also an article (with map) by Comdm. Bordeaux in *La Géographie*, Oct. 1908.

BORKUM, an island of Germany, in the North Sea, belonging to the Prussian province of Hanover, the westernmost of the East Frisian chain, lying between the east and west arms of the estuary of the Ems, and opposite to the Dollart. Pop. about 2500. The island is 5 m. long and 2½ m. broad, is a favourite summer resort, and is visited annually by about 20,000 persons. There is a daily steamboat service with Emden, Leer and Hamburg during the summer months. The island affords pasture for cattle, and a breeding-place for sea-birds.

BORLASE, WILLIAM (1695-1772), English antiquary and naturalist, was born at Pendeen in Cornwall, of an ancient family, on the 2nd of February 1695. He was educated at Exeter College, Oxford, and in 1719 was ordained. In 1722 he was presented to the rectory of Ludgvan, and in 1732 he obtained in addition the vicarage of St Just, his native parish. In the parish of Ludgvan were rich copper works, abounding with mineral and metallic fossils, of which he made a collection, and this led to study somewhat minutely the natural history of the county. In 1750 he was admitted a fellow of the Royal Society; and in 1754 he published, at Oxford, his *Antiquities of Cornwall* (2nd ed., London, 1760). His next publication was *Observations on the Ancient and Present State of the Islands of Scilly, and their Importance to the Trade of Great Britain* (Oxford, 1756). In 1758 appeared his *Natural History of Cornwall*. He presented to the Ashmolean museum, Oxford, a variety of fossils and antiquities, which he had described in his works, and received the thanks of the university and the degree of LL.D. He died on the 31st of August 1772. Borlase was well acquainted with most of the leading literary men of the time, particularly with Alexander Pope, with whom he kept up a long correspondence, and for whose grotto at Twickenham he furnished the greater part of the fossils and minerals.

Borlase's letters to Pope, St Aubyn and others, with answers, fill several volumes of MS. There are also MS. notes on Cornwall, and a complete unpublished treatise *Concerning the Creation and Deluge*. Some account of these MSS., with extracts from them, was given

in the *Quarterly Review*, October 1875. Borlase's memoirs of his own life were published in Nichol's *Literary Anecdotes*, vol. v.

BORMIO (Ger. *Worms*), a town of Lombardy, Italy, in the province of Sondrio, 4½ m. N.E. of the town of Sondrio. Pop. (1901) 1814. It is situated in the Valtellina (the valley of the Adda), 4020 ft. above sea-level, at the foot of the Stelvio pass, and, owing to its position, was of some military importance in the middle ages. It contains interesting churches and picturesque towers. A cemetery of pre-Roman date was discovered at Bormio in 1820.

The baths of Bormio, 2 m. farther up the valley, are mentioned by Pliny and Cassiodorus, the secretary of Theodoric, and are much frequented.

BORN, IGNAZ, EDLER VON (1742-1791), Austrian mineralogist and metallurgist, was born of a noble family at Karlsburg, in Transylvania, on the 26th of December 1742. Educated in a Jesuit college in Vienna, he was for sixteen months a member of the order, but left it and studied law at Prague. Then he travelled extensively in Germany, Holland and France, studying mineralogy, and on his return to Prague in 1770 entered the department of mines and the mint. In 1776 he was appointed by Maria Theresa to arrange the imperial museum at Vienna, where he was nominated to the council of mines and the mint, and continued to reside until his death on the 24th of July 1791. He introduced a method of extracting metals by amalgamation (*Über das Anquellen der Erze*, 1786), and other improvements in mining and other technical processes. His publications also include *Lithophylacium Bornianum* (1772-1775) and *Bergbaukunde* (1780), besides several museum catalogues. Von Born attempted satire with no great success. *Die Staatsperücke*, a tale published without his knowledge in 1772, and an attack on Father Hell, the Jesuit, and king's astronomer at Vienna, are two of his satirical works. Part of a satire, entitled *Monachologia*, in which the monks are described in the technical language of natural history, is also ascribed to him. Von Born was well acquainted with Latin and the principal modern languages of Europe, and with many branches of science not immediately connected with metallurgy and mineralogy. He took an active part in the political changes in Hungary. After the death of the emperor Joseph II, the diet of the states of Hungary rescinded many innovations of that ruler, and conferred the rights of denizen on several persons who had been favourable to the cause of the Hungarians, and, amongst others, on von Born. At the time of his death in 1791, he was employed in writing a work entitled *Fasi Leopoldini*, probably relating to the prudent conduct of Leopold II, the successor of Joseph, towards the Hungarians.

BORNA, a town of Germany in the kingdom of Saxony, on the Wyhra at its junction with the Pleisse, 17 m. S. by E. of Leipzig by rail. Pop. (1905) 9176. The industries include peat-cutting, iron foundries, organ, pianoforte, felt and shoe factories.

BÖRNE, KARL LUDWIG (1786-1837), German political writer and satirist, was born on the 6th of May 1786 at Frankfort-on-Main, where his father, Jakob Baruch, carried on the business of a banker. He received his early education at Giessen, but as Jews were ineligible at that time for public appointments in Frankfort, young Baruch was sent to study medicine at Berlin under a physician, Markus Herz, in whose house he resided. Young Baruch became deeply enamoured of his patron's wife, the talented and beautiful Henriette Herz (1764-1847), and gave vent to his adoration in a series of remarkable letters. Tiring of medical science, which he had subsequently pursued at Halle, he studied constitutional law and political science at Heidelberg and Giessen, and in 1811 took his doctor's degree at the latter university. On his return to Frankfort, now constituted as a grand duchy under the sovereignty of the prince bishop Karl von Dalberg, he received (1811) the appointment of police actuary in that city. The old conditions, however, returned in 1814 and he was obliged to resign his office. Embittered by the oppression under which the Jews suffered in Germany, he engaged in journalism, and edited the Frankfort liberal newspapers, *Staatsjournal* and *Die Zeitschwingen*. In 1818 he became a convert to Lutheran

protestantism, changing his name from Ldb Baruch to Ludwig Börne. This step was taken less out of religious conviction than, as in the case of so many of his descent, in order to improve his social standing. From 1818 to 1821 he edited *Die Wage*, a paper distinguished by its lively political articles and its powerful but sarcastic theatrical criticisms. This paper was suppressed by the police authorities, and in 1821 Börne quitted for a while the field of publicist writing and led a retired life in Paris, Hamburg and Frankfurt. After the July Revolution (1830), he hurried to Paris, expecting to find the newly-constituted state of society somewhat in accordance with his own ideas of freedom. Although to some extent disappointed in his hopes, he was not disposed to look any more kindly on the political condition of Germany; this lent additional zest to the brilliant satirical letters (*Briefe aus Paris*, 1830-1833, published Paris, 1834), which he began to publish in his last literary venture, *La Balance*, a revival under its French name of *Die Wage*. The *Briefe aus Paris* was Börne's most important publication, and a landmark in the history of German journalism. Its appearance led him to be regarded as one of the leaders of the new literary party of "Young Germany." He died at Paris on the 12th of February 1837.

Börne's works are remarkable for brilliancy of style and for a thorough French vein of satire. His best criticism is to be found in his *Denkrede auf Jean Paul* (1826), a writer for whom he had warm sympathy and admiration, in his *Dramaturgische Blätter* (1829-1834), and the witty satire, *Menzel der Franzosenfresser* (1837). He also wrote a number of short stories and sketches, of which the best known are the *Monographie der deutschen Postschnecke* (1820) and *Der Esskünstler* (1822).

The first edition of his *Gesammelte Schriften* appeared at Hamburg (1829-1834) in 14 volumes, followed by 6 volumes of *Nachgelassene Schriften* (Mannheim, 1844-1850); more complete is the edition in 12 volumes (Hamburg, 1862-1863), reprinted in 1868 and subsequently. The latest complete edition is that edited by A. Klaar (8 vols., Leipzig, 1900). For further biographical matter see K. Gutzkow, *Börnes Leben* (Hamburg, 1840), and M. Holzmann, *L. Börne, sein Leben und sein Wirken* (Berlin, 1888). *Börnes Briefe an Henriette Hers* (1802-1807), first published in 1861, have been re-edited by L. Geiger (Oldenburg, 1905), who has also published Börne's *Berliner Briefe* (1828) (Berlin, 1905). See also Heine's witty attack on Börne (*Werke*, ed. Elster, vii.), G. Gervinus's essay in his *Historische Schriften* (Darmstadt, 1838), and the chapters in G. Brandes, *Hovedstrømninger i det 19de Aarhundredes Litteratur* vol. vi. (Copenhagen, 1890, German trans. 1891; English trans. 1905), and in J. Proelss, *Das junge Deutschland* (Stuttgart, 1892).

BORNEO, a great island of the Malay Archipelago, extending from 0° N. to 4° $20'$ S., and from 108° $53'$ to 119° $22'$ E. It is 830 m. long from N.E. to S.W., by 600 m. in maximum breadth. Its area according to the calculations of the Topographical Bureau of Batavia (1894) comprises 293,496 sq. m. These figures are admittedly approximate, and Meyer, who is generally accurate, gives the area of Borneo at 280,860 sq. m. It is roughly, however, five times as large as England and Wales. Politically Borneo is divided into four portions: (1) British North Borneo, the territory exploited and administered by the Chartered British North Borneo Company, to which a separate section of this article is devoted; (2) Brunei (*q.v.*), a Malayan sultanate under British protection; (3) Sarawak (*q.v.*), the large territory ruled by raja Brooke, and under British protection in so far as its foreign relations are concerned; and (4) Dutch Borneo, which comprises the remainder and by far the largest and most valuable portion of the island.

Physical Features.—The general character of the country is mountainous, though none of the ranges attains to any great elevation, and Kinabalu, the highest peak in the island, which is situated near its north-western extremity, is only 13,698 ft. above sea-level. There is no proper nucleus of mountains whence chains ramify in different directions. The central and west central parts of the island, however, are occupied by three mountain chains and a plateau. These chains are: (1) the folded chain of the upper Kapuas, which divides the western division of Dutch Borneo from Sarawak, extends west to east, and attains near the sources of the Kapuas river a height of 5000 to 6000 ft.; (2) the Schwaner chain, south of the Kapuas, whose summits

range from 3000 to 7500 ft., the latter being the height of Bukit Raja, a plateau which divides the waters of the Kapuas from the rivers of southern Borneo; and (3) the Müller chain, between the eastern parts of the Madi plateau (presently to be mentioned) and the Kapuas chain, a volcanic region presenting heights, such as Bukit Terata (4700 ft.), which were once active but are now long extinct volcanos. The Madi plateau lies between the Kapuas and the Schwaner chains. Its height is from 3000 to 4000 ft., and it is clothed with tropical high fens. These mountain systems are homologous in structure with those, not of Celebes or of Malacca, Banka and Billiton. From the eastern end of the Kapuas mountains there are further to be observed: (1) A chain running north-north-east, which forms the boundary between Sarawak and Dutch Borneo, the highest peak of which, Gunong Tebang, approaches 10,000 ft. This chain can hardly be said to extend continuously to the extreme north of the island, but it carries on the line of elevation towards the mountains of Sarawak to the west, and those of British North Borneo to the north, of which latter Kinabalu is the most remarkable. The mountains of North Borneo are more particularly referred to in the portion of this article which deals with that territory. (2) A chain which runs eastward from the central mountains and terminates in the great promontory of the east coast, known variously as Cape Kanior or Kaniungan. (3) A well-marked chain running in a south-easterly direction among the congeries of hills that extend south-eastward from the central mountains, and attaining, near the southern part of the east coast, heights up to and exceeding 6000 ft.

Coasts.—Resting on a submarine plateau of no great depth, the coasts of Borneo are for the most part rimmed round by low alluvial lands, of a marshy, sandy and sometimes swampy character. In places the sands are fringed by long lines of *Casuarina* trees; in others, and more especially in the neighbourhood of some of the river mouths, there are deep banks of black mud covered with mangroves; in others the coast presents to the sea bold headlands, cliffs, mostly of a reddish hue, sparsely clad with greenery, or rolling hills covered by a growth of rank grass. The depth of the sea around the shore rarely exceeds a maximum depth of 1 to 3 fathoms, and the coast as a whole offers few accessible ports. The towns and seaports are to be found as a rule at or near the mouths of those rivers which are not barricaded too efficiently by bars formed of mud or sand. All round the long coast-line of Dutch Borneo there are only seven ports of call, which are habitually made use of by the ships of the Dutch Packet Company. They are Pontianak, Banjarmasin, Kota Bharu, Pasir, Samarinda, Beru and Bulungan. The islands off the coast are not numerous. Excluding some of alluvial formation at the mouths of many of the rivers, and others along the shore which owe their existence to volcanic upheaval, the principal islands are Banguey and Balambangan at the northern extremity, Labuan (*q.v.*), a British colony off the west coast of the territory of North Borneo, and the Karimata Islands off the south-west coast. On Great Karimata is situated the village of Palembang with a population of about 500 souls employed in fishing, mining for iron, and trading in forest produce.

Rivers.—The rivers play a very important part in the economy of Borneo, both as highways and as lines along which run the main arteries of population. Hydrographically the island may be divided into five principal versants. Of these the shortest embraces the north-western slope, north of the Kapuas range, and discharges its waters into the China Sea. The most important of its rivers are the Sarawak, the Batang-Lupar, the Sarcas, the Rejang (navigable for more than 100 m.), the Baram, the Limbang or Brunei river, and the Padas. The rivers of British North Borneo to the north of the Padas are of no importance and of scant practical utility, owing to the fact that the mountain range here approaches very closely to the coast with which it runs parallel. In the south-western versant the largest river is the Kapuas, which, rising near the centre of the island, falls into the sea between Mampawa and Sukadana after a long and winding course. This river, of volume varying with the tide and the amount of rainfall, is normally navigable by small steamers and

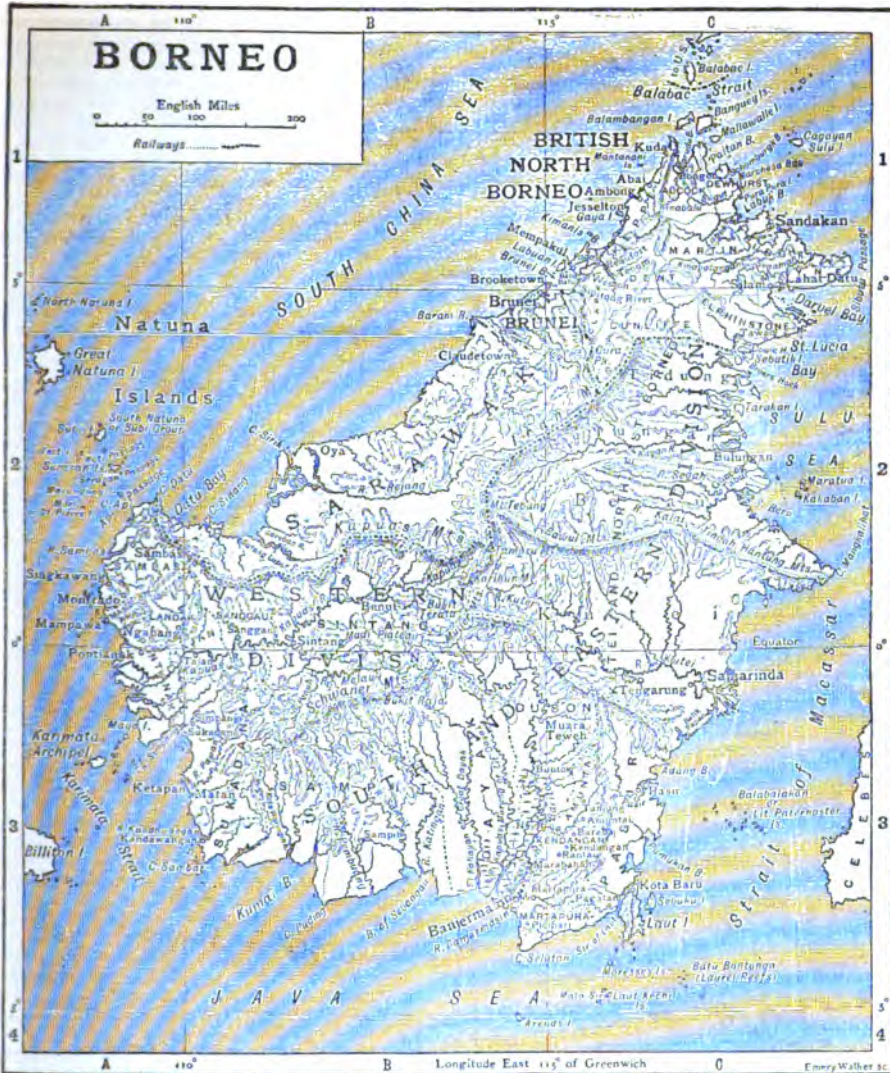

native prahus, of a draught of 4 to 5 ft., for 300 to 400 m., that is to say, from Pontianak up to Sintang, and thence as far as Benut. The middle part of this river, wider and more shallow than the lower reaches, gives rise to a region of inundation and lakes which extend as far as the northern mountain chain. Among its considerable tributaries may be mentioned the southern Melawi with its affluent the Penuh. It reaches the sea through several channels in a wide marshy delta. The Sambas, north of the Kapuas, is navigable in its lower course for vessels drawing 25 ft. Rivers lying to the south of the Kapuas, but of less importance in the way of size, commerce and navigation, are the Simpang, Pawan and Kandawangan, in the neighbourhood of whose mouths, or upon the adjacent coast, the principal native villages are situated in each case. The Barito, which is the principal river of the southern versant, takes its rise in the Kuti Lama Lake, and

falls into the Java Sea in $114^{\circ} 30' E$. Its upper reaches are greatly impeded by rocks, rapids and waterfalls, but the lower part of its course is wide, and traverses a rich, alluvial district, much of which is marshy. Cross branches unite it with two rivers of considerable size towards the west, the Kapuas Murung or Little Dyak, and the Kahayan or Great Dyak. The Katingan or Mendawai, the Sampit, Pemuang or Surian and the Kota Waringin are rivers that fall into the sea farther to the west. The rivers of the southern versant are waters of capacious drainage, the basin of the Kahayan having, for instance, an area of 16,000 sq. m., and the Barito one of 38,000 sq. m. These rivers are navigable for two-thirds of their course by steamers of a fair size, but in many cases the bars at their mouths present considerable difficulties to ships drawing anything over 8 or 9 ft. Most of the larger affluents of the Barito are also navigable throughout the

greater part of their courses. The south-eastern like the north-western corner of the island is watered by a considerable number of short mountain streams. The one great river of the eastern versant is the Kutei or Mahakan, which, rising in the central mountains, flows east with a sinuous course and falls by numerous mouths into the Straits of Macassar. At a great distance from its mouth it has still a depth of three fathoms, and in all its physical features it is comparable to the Kapuas and Barito. The Kayan or Bulungan river is the only other in the eastern versant that calls for mention. Most of the rivers of the northern versant are comparatively small, as the island narrows into a kind of promontory. Of these the Kinabatangan in the territory of British North Borneo is the most important. Lakes are neither numerous nor very large. In most cases they are more fittingly described as swamps. In the flood area of the upper Kapuas, of which mention has already been made, there occurs Lake Luar, and there are several lake expanses of a similar character in the basins of the Barito and Kutei rivers. The only really fine natural harbour in the island of which any use has been made is that of Sandakan, the principal settlement of the North Borneo Company on the north coast.

Geology.—The geology of Borneo is very imperfectly known. The mountain range which lies between Sarawak and the Dutch possessions, and may be looked upon as the backbone of the island, consists chiefly of crystalline schists, together with slates, sandstones and limestones. All these beds are much disturbed and folded. The sedimentary deposits were formerly believed to be Palaeozoic, but Jurassic fossils have since been found in them, and it is probable that several different formations are represented. Somewhat similar rocks appear to form the axis of the range in south-east Borneo, and possibly of the Tampatung Mountains. But the Müller range, the Madi plateau, and the Schwaner Mountains of west Borneo consist chiefly of almost undisturbed sedimentary and volcanic rocks of Tertiary age. The low-lying country between the mountain ranges is covered for the most part by Tertiary and Quaternary deposits, but Cretaceous beds occur at several localities. Some of the older rocks of the mountain regions have been referred to the Devonian, but the evidence cannot be considered conclusive. *Vertebraria* and *Phyllothea*, plants characteristic of the Indian Gondwana series, have been recorded in Sarawak; and marine forms, similar to those of the lower part of the Australian Carboniferous system, are stated to occur in the limestone of north Borneo. *Pseudomonotis salinaria*, a Triassic form, has been noted from the schists of the west of Borneo. In the Kapoewas district radiolarian cherts supposed to be of Jurassic age are met with. Undoubted Jurassic fossils, belonging to several horizons, have been described from west Borneo and Sarawak. The Cretaceous beds, which have long been known in west Borneo, are comparatively little disturbed. They consist for the most part of marls with *Orbitolina concava*, and are referred to the Cenomanian. Cretaceous beds of somewhat later date are found in the Marapuru district in south-east Borneo. The Tertiary system includes conglomerates, sandstones, limestones and marls, which appear to be of Eocene, Oligocene and Miocene age. They contain numerous seams of coal. The Tertiary beds generally lie nearly horizontal and form the lower hills, but in the Madi plateau and the Schwaner range they rise to a height of several thousand feet. Volcanic rocks of Tertiary and late Cretaceous age are extensively developed, especially in the Müller Mountains. The whole of this consists of tuffs and lavas, andesites prevailing in the west and rhyolites and dacites in the east.

Minerals.—The mineral wealth of Borneo is great and varied. It includes diamonds, the majority of which, however, are of a somewhat yellow colour, gold, quicksilver, cinnabar, copper, iron, tin, antimony, mineral oils, sulphur, rock-salt, marble and coal. The exploitation of the mines suffers in many cases from the difficulties and expense of transport, the high duties payable in Dutch Borneo to the native princes, the competition among the rival companies, and often the limited quantities of the minerals found in the mines. The districts of Sambas and Landak in the west, the Kahayan river, the mountain valleys of the extreme south-east and parts of Sarawak furnish the largest quantities of gold, which is obtained for the most part from alluvial washings. The Borneo Company is engaged in working gold-mines in the upper part of the Sarawak valley, and the prospects of the enterprise, which is conducted on a fairly extensive scale, are known to be encouraging. Diamonds are also found widely distributed and mainly in the same regions as the gold. The Kapuas valley has so far yielded the largest quantity, and Pontianak is, for diamonds, the principal port of export.

Considerable progress has been made in the development of the oil-fields in Dutch Borneo, and the *Nederlandsch Indische Industrie en Handel Maatschappij*, the Dutch business of the Shell Transport and Trading Company, increased its output from 123,592 tons in 1901 to 285,720 tons in 1904, and showed further satisfactory increase thereafter. This company owns extensive oil-fields at Balikpapan and Sanga-Sanga. The quality of the oil varies in a remarkable way according to the depth. The upper stratum is struck at a depth of 600 to 700 ft., and yields a natural liquid fuel of heavy specific gravity. The next source is met with at about 1200 ft., yielding an oil which is much lighter in weight and, as such, more suitable for treatment in the refinery. The former oil is almost invariably of an asphaltic basis, whereas the latter sometimes is found to contain a considerable percentage of paraffin wax. The average daily production is very high, owing to a large number of the wells flowing under the natural pressure of the gas. There is every reason to believe that the oil-fields of Dutch Borneo have a great future. Coal mines have, in many instances, been opened and abandoned, failure being due to the difficulty of production. Coal of good quality has been found in Pengaron and elsewhere in the Banjer-masin district, but most Borneo coal is considerably below this average of excellence. It has also been found in fair quantities at various places in the Kutei valley and in Sarawak. The coal-mines of Labuan have been worked spasmodically, but success has never attended the venture. Sadong yields something under 130 tons a day, and the Brooketown mine, the property of the raja of Sarawak, yields some 50 tons a day of rather indifferent coal. The discovery that Borneo produced antimony was made in 1825 by John Crawford, the orientalist, who learned in that year that a quantity had been brought to Singapore by a native trader as ballast. The supply is practically unlimited and widely distributed. The principal mine is at Bidi in Sarawak.

Climate and Health.—As is to be anticipated, having regard to its insular position and to the fact that the equator passes through the very middle of the island, the climate is at once hot and very damp. In the hills and in the interior regions are found which may almost be described as temperate, but on the coasts the atmosphere is dense, humid and oppressive. Throughout the average temperature is from 78° to 80° F., but the thermometer rarely falls below 70°, except in the hills, and occasionally on exceptional days mounts as high as 96° in the shade. The rainy westerly winds (S.W. and N.W.) prevail at all the meteorological stations, not the comparatively dry south-east wind. Even at Banjer-masin, near the south coast, the north-west wind brings annually a rainfall of 60 in., as against 33 in. of rain carried by the south-east wind. The difference between the seasons is not rigidly marked. The climate is practically unchanging all the year round, the atmosphere being uniformly moist, and though days of continuous downpour are rare, comparatively few days pass without a shower. Most rain falls between November and May, and at this season the torrents are tremendous while they last, and squalls of wind are frequent and violent, almost invariably preceding a downpour. Over such an extensive area there is, of course, great variety in the climatic character of different districts, especially when viewed in relation to health. Some places, such as Bidi in Sarawak, for instance, are notoriously unhealthy; but from the statistics of the Dutch government, and the records of Sarawak and British North Borneo, it would appear that the European in Borneo has in general not appreciably more to fear than his fellow in Java, or in the Federated Malay States of the Malay Peninsula. Among the native races the prevailing diseases, apart from those of a malarial origin, are chiefly such as arise from bad and insufficient food, from intemperance, and from want of cleanliness. The habit of allowing their meat to putrefy before regarding it as fit for food, and of encouraging children of tender age to drink to intoxication, accounts for absence of old folk and the heavy mortality which are to be observed among the Muruts of British North Borneo and some of the other more debased tribes of the interior of the island. Scrofula and various forms of lupus are common among the natives throughout the country and

especially in the interior; elephantiasis is frequently met with on the coast. Smallpox, dysentery and fevers, frequently of a bilious character, are endemic and occasionally epidemic. Cholera breaks out from time to time and works great havoc, as was the case in 1903 when one of the raja of Sarawak's punitive expeditions was stricken while ascending the Limbang river by boat, and lost many hundreds of its numbers before the coast could be regained. Ophthalmia is common and sometimes will attack whole tribes. About one sixth of the native population of the interior, and a smaller proportion of those living on the coast, suffer from a kind of ringworm called *kwrap*, which also prevails almost universally among the Sakai and Semang, the aboriginal hill tribes of the Malayan Peninsula. The disease is believed to be aggravated by chronic anaemia. Consumption is not uncommon.

Fauna.—The fauna of Borneo comprises a large variety of species, many of which are numerically of great importance. Among the quadrupeds the most remarkable is the orang-utan (Malay, *orang utan*, i.e. jungle man), as the huge ape, called *mias* or *mayas* by the natives, is named by Europeans. Numerous species of monkey are found in Borneo, including the wahwah, a kind of gibbon, a creature far more human in appearance and habits than the orang-utan, and several *Semnopithecus*, such as the long-nosed ape and the golden-black or *chrysomelas*. The large-eyed *Stenops lardigradus* also deserves mention. The larger beasts of prey are not met with, and little check is therefore put on the natural fecundity of the gaminivorous species. A small panther and the clouded tiger (so called)—*Felis macroscelis*—are the largest animals of the cat kind that occur in Borneo. The Bengal tiger is not found. The Malay or honey-bear is very common. The rhinoceros and the elephant both occur in the northern part of the island, though both are somewhat rare, and in this connexion it should be noted that the distribution of quadrupeds as between Borneo, Sumatra and the Malayan Peninsula is somewhat peculiar and seemingly somewhat capricious. Many quadrupeds, such as the honey-bear and the rhinoceros, are common to all, but while the tiger is common both in the Malayan Peninsula and in Sumatra, it does not occur in Borneo; the elephant, so common in the peninsula, and found in Borneo, is unknown in Sumatra; and the orang-utan, so plentiful in parts of Borneo and parts of Sumatra, has never been discovered in the Malay Peninsula. It has been suggested, but with very scant measure of probability, that the existence of elephants in Borneo, whose confinement to a single district is remarkable and unexplained, is due to importation; and the fact is on record that when Magellan's ships visited Brunei in 1521 tame elephants were in use at the court of the sultan of Brunei. Wild oxen of the Sunda race, not to be in any way confounded with the Malayan *sladang* or gaur, are rare, but the whole country swarms with wild swine, and the *babirusa*, a pig with curious horn-like tusks, is not uncommon. Alligators are found in most of the rivers, and the gavia is less frequently met with. Three or four species of deer are common, including the mouse-deer, or *plandok*, an animal of remarkable grace and beauty, about the size of a hare but considerably less heavy. Squirrels, flying-squirrels, porcupines, civet-cats, rats, bats, flying-foxes and lizards are found in great variety; snakes of various kinds, from the boa-constrictor downward, are abundant, while the forests swarm with tree-leeches, and the marshes with horse-leeches and frogs. A remarkable flying-frog was discovered by Professor A. R. Wallace. Birds are somewhat rare in some quarters. The most important are eagles, kites, vultures, falcons, owls, horn-bills, cranes, pheasants (notably the argus, fire-back and peacock-pheasants), partridges, ravens, crows, parrots, pigeons, woodpeckers, doves, snipe, quail and swallows. Of most of these birds several varieties are met with. The *Cypselus eximius*, or edible-nest swift, is very common, and the nests, which are built mostly in limestone caves, are esteemed the best in the archipelago. Mosquitoes and sand-flies are the chief insect pests, and in some districts are very troublesome. Several kinds of parasitic jungle ticks cause much annoyance to men and to beasts. There are also two kinds of ants, the *semut api* ("fire

ant") and the *semut lada* ("pepper ant"), whose bites are peculiarly painful. Hornets, bees and wasps of many varieties abound. The honey and the wax of the wild bee are collected by the natives. Butterflies and moths are remarkable for their number, size, variety and beauty. Beetles are no less numerously represented, as is to be expected in a country so richly wooded as Borneo. The swamps and rivers, as well as the surrounding seas, swarm with fish. The *siawan* is a species of fish found in the rivers and valued for its spawn, which is salted. The natives are expert and ingenious fishermen. Turtles, trepang and pearl-shell are of some commercial importance.

The dog, the cat, the pig, the domestic fowl (which is not very obviously related to the bantam of the woods), the buffalo, a smaller breed than that met with in the Malayan Peninsula, and in some districts bullocks of the Brahmin breed and small horses, are the principal domestic animals. The character of the country and the nomadic habits of many of the natives of the interior, who rarely occupy their villages for more than a few years in succession, have not proved favourable to pastoral modes of life. The buffaloes are used not only in agriculture, but also as beasts of burden, as draught-animals and for the saddle. Horses, introduced by Europeans and owned only by the wealthier classes, are found in Banjarmasin and in Sarawak. In British North Borneo, and especially in the district of Tempasuk on the north-west coast, Borneo ponies, bred originally, it is supposed, from the stock which is indigenous to the Sulu archipelago, are common.

Flora.—The flora of Borneo is very rich, the greater portion of the surface of the island being clothed in luxuriant vegetation. The king of the forest is the *topan*, which, rising to a great height without fork or branch, culminates in a splendid dome of foliage. The official seats of some of the chiefs are constructed from the wood of this tree. Iron-wood, remarkable for the durability of its timber, is abundant; it is used by the natives for the pillars of their homes and forms an article of export, chiefly to Hong-Kong. It is rivalled in hardness by the *ladu lembesu*. In all, about sixty kinds of timber of marketable quality are furnished in more or less profusion, but the difficulty of extraction, even in the regions situated in close proximity to the large waterways, renders it improbable that the timber trade of Borneo will attain to any very great dimensions until other and easier sources of supply have become exhausted. Palm-trees are abundant in great variety, including the *ntpah*, which is much used for thatching, the cabbage, fan, sugar, coco and sago palms. The last two furnish large supplies of food to the natives, some copra is exported, and sago factories, mostly in the hands of Chinese, prepare sago for the Dutch and British markets. Gutta-percha (*gêlah percha* in the vernacular), camphor, cinnamon, cloves, nutmegs, gambir and betel, or areca-nuts, are all produced in the island; most of the tropical fruits flourish, including the much-admired but, to the uninitiated, most evil-smelling durian, a large fruit with an exceedingly strong outer covering composed of stout pyramidal spikes, which grows upon the branches of a tall tree and occasionally in falling inflicts considerable injuries upon passers-by. Yams, several kinds of sweet potatoes, melons, pumpkins, cucumbers, pineapples, bananas and mangosteens are cultivated, as also are a large number of other fruits. Rice is grown in irrigated lands near the rivers and in the swamps, and also in rude clearings in the interior; sugar-cane of superior quality in Sambas and Montrado; cotton, sometimes exported in small quantities, on the banks of the Negara, a tributary of the Barito; tobacco, used very largely now in the production of cigars, in various parts of northern Borneo; and tobacco for native consumption, which is of small commercial importance, is cultivated in most parts of the island. Indigo, coffee and pepper have been cultivated since 1855 in the western division of Dutch Borneo. Among the more beautiful of the flowering plants are rhododendrons, orchids and pitcher-plants—the latter reaching extraordinary development, especially in the northern districts about Kinabalu. Epiphytous plants are very common, many that are usually independent assuming here the parasitic character; the *Vanda lowii*, for example, grows on the

lower branches of trees, and its strange pendent flower-stalks often hang down so as almost to reach the ground. Ferns are abundant, but not so varied as in Java.

Population.—The population of Borneo is not known with any approach to accuracy, but according to the political divisions of the island it is estimated as follows:—

Dutch Borneo	1,130,000
British North Borneo	200,000
Sarawak	500,000
Brunei	20,000

No effective census of the population has ever been taken, and vast areas in Dutch Borneo and in British North Borneo remain unexplored, and free from any practical authority or control. In Sarawak, owing to the high administrative genius of the first raja and his successor, the natives have been brought far more completely under control, but the raja has never found occasion to utilize the machinery of his government for the accurate enumeration of his subjects.

Dutch Borneo is divided for administrative purposes into two divisions, the western and the south and eastern respectively. Of the two, the former is under the more complete and effective control. The estimated population in the western division is 413,000 and in the south and eastern 717,000. Europeans number barely 1000; Arabs about 3000, and Chinese, mainly in the western division, over 40,000. In both divisions there is an average density of little more than 1 to every 2 sq. m. The sparseness of the population throughout the Dutch territory is due to a variety of causes—to the physical character of the country, which for the most part restricts the area of population to the near neighbourhood of the rivers; to the low standard of civilization to which the majority of the natives have attained and the consequent disregard of sanitation and hygiene; to wars, piracy and head-hunting, the last of which has not even yet been effectually checked among some of the tribes of the interior; and to the aggression and oppressions in earlier times of Malayan, Arab and Bugis settlers. Among the natives, more especially of the interior, an innate restlessness which leads to a life of spasmodic nomadism, poverty, insufficient nourishment, an incredible improvidence which induces them to convert into intoxicating liquor a large portion of their annual crops, feasts of a semi-religious character which are invariably accompanied by prolonged drunken orgies, and certain superstitions which necessitate the frequent procurement of abortion, have contributed to check the growth of population. In Sambas, Montrado and some parts of Pontianak, the greater density of the population is due to the greater fertility of the soil, the opening of mines, the navigation and trade plied on the larger rivers, and the concentration of the population at the junctions of rivers, the mouths of rivers and the seats of government. Of the chief place in the western division, Pontianak has about 9000 inhabitants; Sambas about 8000; Montrado, Mampawa and Landak between 2000 and 4000 each; and in the south and eastern division there are Banjarmasin with nearly 50,000 inhabitants; Marabahan, Amuntai, Negara, Samarinda and Tengarung with populations of from 5000 to 10,000 inhabitants each. In Amuntai and Martapura early Hindu colonization, of which the traces and the influence still are manifest, the fertile soil, trade and industry aided by navigable rivers, have co-operated towards the growth of population to a degree which presents a marked contrast to the conditions in the interior parts of the Upper Barito and of the more westerly rivers. Only a very small proportion of the Europeans in Dutch Borneo live by agriculture and industry, the great majority of them being officials. The Arabs and Chinese are engaged in trading, mining, fishing and agriculture. Of the natives fully 90% live by agriculture, which, however, is for the most part of a somewhat primitive description. The industries of the natives are confined to such crafts as spinning and weaving and dyeing, the manufacture of iron weapons and implements, boat- and shipbuilding, &c. More particularly in the south-eastern division, and especially in the districts of Negara, Banjarmasin, Amuntai and Martapura, shipbuilding, iron-forging, gold- and silversmith's work, and the polishing of

diamonds, are industries of high development in the larger centres of population.

Races.—The peoples of Borneo belong to a considerable variety of races, of different origin and degrees of civilization. The most important numerically are the Dyaks, the Dusuns and Muruts of the interior, the Malays, among whom must be counted such Malayan tribes as the Bajaus, Ilanuns, &c., the Bugis, who were originally immigrants from Celebes, and the Chinese. The Dutch, and to a minor extent the Arabs, are of importance on account of their political influence in Dutch Borneo, while the British communities have a similar importance in Sarawak and in British North Borneo. Accounts of the Malays, Dyaks and Bugis are given under their several headings, and some information concerning the Dusuns and Muruts will be found in the section below, which deals with British North Borneo. The connexion of the Chinese with Borneo calls for notice here. They seem to have been the first civilized people who had dealings with Borneo, if the colonization of a portion of the south-eastern corner of the island by Hindus be excepted. The Chinese annals speak of tribute paid to the empire by Pha-la on the north-east coast of the island as early as the 7th century, and later documents mention a Chinese colonization in the 15th century. The traditions of the Malays and Dyaks seem to confirm the statements, and many of the leading families of Brunei in north-west Borneo claim to have Chinese blood in their veins, while the annals of Sulu record an extensive Chinese immigration about 1575. However this may be, it is certain that the flourishing condition of Borneo in the 16th and 17th centuries was largely due to the energy of Chinese settlers and to trade with China. In the 18th century there was a considerable Chinese population settled in Brunei, engaged for the most part in planting and exporting pepper, but the consistent oppression of the native rajahs destroyed their industry and led eventually to the practical extirpation of the Chinese. The Malay chiefs of other districts encouraged immigration from China with a view to developing the mineral resources of their territories, and before long Chinese settlers were to be found in considerable numbers in Sambas, Montrado, Pontianak and elsewhere. They were at first forbidden to engage in commerce or agriculture, to carry firearms, to possess or manufacture gunpowder. About 1779 the Dutch acquired immediate authority over all strangers, and thus assumed responsibility for the control of the Chinese, who presently proved themselves somewhat troublesome. Their numbers constantly increased and were reinforced by new immigrants, and pushing inland in search of fresh mineral-bearing areas, they contracted frequent inter-marriages with the Dyaks and other non-Mahomedan natives. They brought with them from China their aptitude for the organization of secret societies which, almost from the first, assumed the guise of political associations. These secret societies furnished them with a machinery whereby collective action was rendered easy, and under astute leaders they offered a formidable opposition to the Dutch government. Later, when driven into the interior and eventually out of Dutch territory, they cost the first raja of Sarawak some severe contests before they were at last reduced to obedience. Serious disturbances among the Chinese are now in Borneo matters of ancient history, and to-day the Chinaman forms perhaps the most valuable element in the civilization and development of the island, just as does his fellow in the mining states of the Malayan Peninsula. They are industrious, frugal and intelligent; the richer among them are excellent men of business and are peculiarly equitable in their dealings; the majority of all classes can read and write their own script, and the second generation acquires an education of an European type with great facility. The bulk of the shop-keeping, trading and mining industries, so long as the mining is of an alluvial character, is in Chinese hands. The greater part of the Chinese on the west coast are originally drawn from the boundaries of Kwang-tung and Kwang-si. They are called Keks by the Malays, and are of the same tribes as those which furnish the bulk of the workers to the tin mines of the Malay Peninsula. They are a rough and hardy people, and are

spt at times to be turbulent. The shopkeeping class comes mostly from Fuh-kien and the coast districts of Amoy. They are known to the Borneans as Ollohs.

History.—As far as is known, Borneo never formed a political unity, and even its geographical unity as an island is a fact unappreciated by the vast majority of its native inhabitants. The name of Kalamantan has been given by some Europeans (on what original authority it is not possible now to ascertain) as the native name for the island of Borneo considered as a whole; but it is safe to aver that among the natives of the island itself Borneo has never borne any general designation. To this day, among the natives of the Malayan Archipelago, men speak of going to Pontianak, to Sambas or to Brunei, as the case may be, but make use of no term which recognizes that these localities are part of a single whole. The only archaeological remains are a few Hindu temples, and it is probable that the early settlement of the south-eastern portion of the island by Hindus dates from some time during the first six centuries of our era. There exist, however, no data, not even any trustworthy tradition, from which to reconstruct the early history of Borneo. Borneo began to be known to Europeans after the fall of Malacca in 1511, when Alphonso d'Albuquerque despatched Antonio d'Abreu with three ships in search of the Molucca or Spice Islands with instructions to establish friendly relations with all the native states that he might encounter on his way. D'Abreu, sailing in a south-easterly direction from the Straits of Malacca, skirted the southern coast of Borneo and laid up his ships at Amboyna, a small island near the south-western extremity of Ceram. He returned to Malacca in 1514, leaving one of his captains, Francisco Serrano, at Ternate, where Magellan's followers found him in 1521. After Magellan's death, his comrades sailed from the Moluccas across the Celebes into the Sulu Sea, and were the first white men who are known to have visited Brunei on the north-west coast of Borneo, where they arrived in 1522. Pigafetta gives an interesting account of the place and of the reception of the adventurers by the sultan. The Molucca Islands being, at that time, the principal objective of European traders, and the route followed by Magellan's ships being frequently used, Borneo was often touched at during the remainder of the 16th century, and trade relations with Brunei were successfully established by the Portuguese. In 1573 the Spaniards tried somewhat unsuccessfully to obtain a share of this commerce, but it was not until 1580, when a dethroned sultan appealed to them for assistance and by their agency was restored to his own, that they attained their object. Thereafter the Spaniards maintained a fitful intercourse with Brunei, varied by not infrequent hostilities, and in 1645 a punitive expedition on a larger scale than heretofore was sent to chastise Brunei for persistent acts of piracy. No attempt at annexation followed upon this action, commerce rather than territory being at this period the prime object of both the Spaniards and the Portuguese, whose influence upon the natives was accordingly proportionately small. The only effort at proselytizing of which we have record came to an untimely end in the death of the Theatine monk, Antonio Ventimiglia, who had been its originator. Meanwhile the Dutch and British East India Companies had been formed, had destroyed the monopoly so long enjoyed by the Portuguese, and to a less extent the Spaniards, in the trade of the Malayan Archipelago, and had gained a footing in Borneo. The establishment of Dutch trading-posts on the west coast of Borneo dates from 1604, nine years after the first Dutch fleet, under Houtman, sailed from the Tezel to dispute with the Portuguese the possession of the Eastern trade, and in 1608 Samuel Blommaert was appointed Dutch resident, or head factor, in Landak and Suke-dana. The first appearance of the British in Borneo dates from 1609, and by 1608 they had an important settlement at Banjarmasin, whence they were subsequently expelled by the influence of the Dutch, who about 1733 obtained from the sultan a trading monopoly. The Dutch, in fact, speedily became the predominant European race throughout the Malay Archipelago, defeating the British by superior energy and enterprise, and the trading-posts all along the western and southern coasts of

Borneo were presently their exclusive possessions, the sultan of Bantam, who was the overlord of these districts, ceding his rights to the Dutch. The British meanwhile had turned their attention to the north of the island, over which the sultan of Sulu exercised the rights of suzerain, and from him, in 1759, Alexander Dalrymple obtained possession of the island of Balambangan, and the whole of the north-eastern promontory. A military post was established, but it was destroyed in 1775 by the natives under the *dato'*, or vassal chiefs, who resented the cession of their territory. This mishap rendered a treaty, which had been concluded in 1774 with the sultan of Brunei, practically a dead letter, and by the end of the century British influence in Borneo was to all intents and purposes at an end. The Dutch also mismanaged their affairs in Borneo and suffered from a series of misfortunes which led Marshal Daendels in 1809 to order the abandonment of all their posts. The natives of the coasts of Borneo, assisted and stimulated by immigrants from the neighbouring islands to the north, devoted themselves more and more to organized piracy, and putting to sea in great fleets manned by two and three thousand men on cruises that lasted for two and even three years, they terrorized the neighbouring seas and rendered the trade of civilized nations almost impossible for a prolonged period. During the occupation of Java by the British an embassy was despatched to Sir Stamford Raffles by the sultan of Banjermasin asking for assistance, and in 1811 Alexander Hare was despatched thither as commissioner and resident. He not only obtained for his government an advantageous treaty, but secured for himself a grant of a district which he proceeded to colonize and cultivate. About the same time a British expedition was also sent against Sambas and a post established at Pontianak. On the restoration of Java to the Dutch in 1816, all these arrangements were cancelled, and the Dutch government was left in undisputed possession of the field. An energetic policy was soon after adopted, and about half the kingdom of Banjermasin was surrendered to the Dutch by its sultan in 1823, further concessions being made two years later. Meanwhile, George Müller, while exploring the east coast, obtained from the sultan of Kutei an acknowledgment of Dutch authority, a concession speedily repented by its donor, since the enterprising traveller was shortly afterwards killed. The outbreak of war in Java caused Borneo to be more or less neglected by the Dutch for a considerable period, and no effective check was imposed upon the natives with a view to stopping piracy, which was annually becoming more and more unendurable. On the rise of Singapore direct trade had been established with Sarawak and Brunei, and it became a matter of moment to British merchants that this traffic should be safe. In 1838 Sir James Brooke, an Englishman, whose attention had been turned to the state of affairs in the Eastern Archipelago, set out for Borneo, determined, if possible, to remedy the evil. By 1841 he had obtained from the sultan of Brunei the grant of supreme authority over Sarawak, in which state, on the sultan's behalf, he had waged a successful war, and before many years had elapsed he had, with the aid of the British government, succeeded in suppressing piracy (see BROOKE, SIR JAMES; and SARAWAK). In 1847 the sultan of Brunei agreed to make no cession of territory to any nation or individual without the consent of Great Britain. Since then more and more territory has been ceded by the sultans of Brunei to the raja of Sarawak and to British North Borneo, and to-day the merest remnant of his once extensive state is left within the jurisdiction of the sultan. The treaty in 1847 put an end once for all to the hopes which the Dutch had cherished of including the whole island in their dominions, but it served also to stimulate their efforts to consolidate their power within the sphere already subjected to their influence. Gunong Tebur, Tanjong, and Bulungan had made nominal submission to them in 1834, and in 1844 the sultan of Kutei acknowledged their protectorate, a treaty of a similar character being concluded about the same time with Pasir. The boundaries of British and Dutch Borneo were finally defined by a treaty concluded on the 20th of June 1891. In spite of this, however, large areas in the interior,

both in Dutch Borneo and in the territory owned by the British North Borneo Company, are still only nominally under European control, and have experienced few direct effects of European administration.

BRITISH NORTH BORNEO OR SABAH

Sabah is the name applied by the natives to certain portions of the territory situated on the north-western coast of the island, and originally in no way included the remainder of the country now owned by the British North Borneo Company. It has become customary, however, for the name to be used by Europeans in Borneo to denote the whole of the company's territory, and little by little the more educated natives are insensibly adopting the practice.

History.—As has been seen, the British connexion with northern and north-western Borneo terminated with the 18th century, nor was it resumed until 1838, when Raja Brooke set out for Brunei and Sarawak. The island of Labuan (*q.v.*) was occupied by the British as a crown colony in 1848, and this may be taken as the starting-point of renewed British relations with that portion of northern Borneo which is situated to the north of Brunei. In 1872 the Labuan Trading Company was established in Sandakan, the fine harbour on the northern coast which was subsequently the capital of the North Borneo Company's territory. In 1878, through the instrumentality of Mr (afterwards Sir) Alfred Dent, the sultan of Sulu was induced to transfer to a syndicate, formed by Baron Overbeck and Mr Dent, all his rights in North Borneo, of which, as has been seen, he had been from time immemorial the overlord. The chief promoters of this syndicate were Sir Rutherford Alcock, Admiral the Hon. Sir Harry Keppel, who at an earlier stage of his career had rendered great assistance to the first raja of Sarawak in the suppression of piracy, and Mr Richard B. Martin. Early in 1881 the British North Borneo Provisional Association, Limited, was formed to take over the concession which had been obtained from the sultan of Sulu, and in November of that year a petition was addressed to Queen Victoria praying for a royal charter. This was granted, and subsequently the British North Borneo Company, which was formed in May 1882, took over, in spite of some diplomatic protests on the part of the Dutch and Spanish governments, all the sovereign and territorial rights ceded by the original grants, and proceeded under its charter to organize the administration of the territory. The company subsequently acquired further sovereign and territorial rights from the sultan of Brunei and his chiefs in addition to some which had already been obtained at the time of the formation of the company. The Putatan river was ceded in May 1884, the Padas district, including the Padas and Kalias rivers, in November of the same year, the Kawang river in February 1885, and the Mantanani islands in April 1885. In 1888, by an agreement with the "State of North Borneo," the territory of the company was made a British protectorate, but its administration remained entirely in the hands of the company, the crown reserving only control of its foreign relations, and the appointment of its governors being required to receive the formal sanction of the secretary of state for the colonies. In 1890 the British government placed the colony of Labuan under the administration of the company, the governor of the state of North Borneo thereafter holding a royal commission as governor of Labuan in addition to his commission from the company. This arrangement held good until 1905, when, in answer to the frequently and strongly expressed desire of the colonists, Labuan was removed from the jurisdiction of the company and attached to the colony of the Straits Settlements. In March 1898 arrangements were made whereby the sultan of Brunei ceded to the company all his sovereign and territorial rights to the districts situated to the north of the Padas river which up to that time had been retained by him. This had the effect of rounding off the company's territories, and had the additional advantage of doing away with the various no-man's lands which had long been used by the discontented among the natives as so many Caves of Adullam. The company's acquisition of territory was viewed with considerable dissatisfaction

by many of the natives, and this found expression in frequent acts of violence. The most noted and the most successful of the native leaders was a Bajau named Mat Saleh (Mahomet Saleh), who for many years defied the company, whose policy in his regard was marked by considerable weakness and vacillation. In 1898 a composition was made with him, the terms of which were unfortunately not defined with sufficient clearness, and he retired into the Tambunan country, to the east of the range which runs parallel with the west coast, where for a period he lorded it unchecked over the Dusun tribes of the valley. In 1899 it was found necessary to expel him, since his acts of aggression and defiance were no longer endurable. A short, and this time a successful campaign followed, resulting, on the 31st of January 1900, in the death of Mat Saleh, and the destruction of his defences. Some of his followers who escaped raided the town of Kudat on Marudu Bay in April of the same year, but caused more panic than damage, and little by little during the next years the last smouldering embers of rebellion were extinguished. At the present time, though effective administration of the more inaccessible districts of the interior cannot be said to have been established even yet, the pacification of the native population is to all intents and purposes complete. The Tambunan district, the last stronghold of Mat Saleh, is now thoroughly settled. It is some 500 sq. m. in extent, and carries a population of perhaps 12,000.

Geography.—The state of North Borneo may roughly be said to form a pentagon of which three sides, the north-west, north-east and east are washed by the sea, while the remaining two sides, the south-west and the south, are bordered respectively by the Malayan sultanate of Brunei, and by the territories of the raja of Sarawak and of the Dutch government. The boundary between the company's territory and the Dutch government is defined by the treaty concluded in June 1891, of which mention has already been made.

The total area of the company's territory is estimated at about 31,000 sq. m., with a coast-line of over 900 m. The greater portion is exceedingly hilly and in parts mountainous, and the interior consists almost entirely of highlands with here and there open valleys and plateaus of 50 to 60 sq. m. in extent. On the west coast the mountain range, as already noted, runs parallel with the seashore at a distance from it of about 15 m. Of this range the central feature is the mountain of Kinabalu, which is composed of porphyritic granite and igneous rocks and attains to a height of 13,698 ft. Mount Madalon, some 15 or 20 m. to the north, is 5000 ft. in height, and inland across the valley of the Pagalan river, which runs through the Tambunan country and falls into the Padas, rises the peak of Trus Madi, estimated to be 11,000 ft. above sea-level. The valley of the Pagalan is itself for the most part from 1000 to 2000 ft. above the sea, forming a string of small plateaus marking the sites of former lakes. From the base of Trus Madi to the eastern coast the country consists of huddled hills broken here and there by regions of a more mountainous character. The principal plateaus are in the Tambunan and Keningau valleys, in the basin of the Pagalan, and the Ranau plain to the eastward of the base of Kinabalu. Similar plateaus of minor importance are to be found dotted about the interior. The proximity of the mountain range to the seashore causes the rivers of the west coast, with the single exception of the Padas, to be rapid, boulder-obstructed, shallow streams of little value as means of communication for a distance of more than half a dozen miles from their mouths. The Padas is navigable for light-draught steam-launches and native boats for a distance of nearly 50 m. from its mouth, and smaller craft can be punted up as far as Rayoh, some 15 m. farther, but at this point its bed is obstructed by impassable falls and rapids, which are of such a character that nothing can even be brought down them. Even below Rayoh navigation is rendered difficult and occasionally dangerous by similar obstructions. The other principal rivers of the west coast are the Kalias, Kimanis, Benoneh, Papar, Kinarut, Putatan, Inaman, Mengkabong, Tampasuk and Pandasan, none of which, however, is of any great importance as a means of communication. There is a stout breed of pony

raised along the Tampusak, which is also noted for the Kalupis waterfall (1500 ft.), one of the highest in the world, though the volume of water is not great. Here also are the principal Bajau settlements. Throughout the Malayan Archipelago the words *Béjau* and *pérmpak* (pirate) are still used as synonymous terms. At the northern extremity of the island Marudu Bay receives the waters of the Marudu which rises on the western side of Mount Madalon. On the east coast the principal rivers are the Sugut, which rises in the hills to the east of Kinabalu and forms its delta near Torongohok or Pura-Pura Island; the Labuk, which has its sources 70 m. inland and debouches into Labuk Bay; and the Kinabatangan, the largest and most important river in the territory, which is believed to have its rise eastward of the range of which Trus Madi is the principal feature, and is navigable by steamer for a considerable distance and by native boats for a distance of over 100 m. from its mouth. Some valuable tobacco land, which, however, is somewhat liable to flood, and some remarkable burial-caves are found in the valley of the Kinabatangan. The remaining rivers of the east coast are the Segamah, which rises west of Darvel Bay, the Kumpong, and the Kalabakang, which debouches into Cowie Harbour. Taking it as a whole, the company's territory is much less generously watered than are other parts of Borneo, which again compares unfavourably in this respect with the Malayan states of the peninsula. Many of the rivers, especially those of the west coast, are obstructed by bars at their mouths that render them difficult of access. Several of the natural harbours of North Borneo, on the other hand, are accessible, safe and commodious. Sandakan Harbour, on the north-east coast ($5^{\circ} 40' N.$, $118^{\circ} 10' E.$), runs inland for some 17 m. with a very irregular outline broken by the mouths of numerous creeks and streams. The mouth, only 2 m. across, is split into two channels by the little, high, bluff-like island of Barhala. The depth in the main entrance varies from 10 to 17 fathoms, and vessels drawing 20 ft. can advance half-way up the bay. The principal town in the territory, and the seat of government (though an attempt has been unsuccessfully made to transfer this to Jesselton on the west coast), is Sandakan, situated just inside the mouth of the Sarwaka inlet. At Silam, on Darvel Bay, there is good anchorage; and Kudat in Marudu Bay, first surveyed by Commander Johnstone of H.M.S. "Egeria" in 1881, is a small but useful harbour.

Climate and Population.—The climate of North Borneo is tropical, hot, damp and enervating. The rainfall is steady and not usually excessive. The shade temperature at Sandakan ordinarily ranges from 72° to 94° F. The population of the company's territory is not known with any approach to accuracy, but is estimated, somewhat liberally, to amount to 175,000, including 16,000 Chinese. Of this total about three-fourths are found in the districts of the west coast. The seashore and the country bordering closely on the west coast are inhabited chiefly by Dusuns, by Kadayans, by Bajaus and Ilanuns—both Malayan tribes—and by Brunei Malays. The east coast is very sparsely populated and its inhabitants are mostly Bajaus and settlers from the neighbouring Sulu archipelago. The interior is dotted with infrequent villages inhabited by Dusuns or by Muruts, a village ordinarily consisting of a single long hut divided up into cubicles, one for the use of each family, opening out on to a common verandah along which the skulls captured by the tribe are festooned. It has been customary to speak of these tribes as belonging to the Dyak group, but the Muruts would certainly seem to be the representatives of the aboriginal inhabitants of the island, and there is much reason to think that the Dusuns also must be classed as distinct from the Dyaks. The Dusun language, it is interesting to note, presents very curious grammatical complications and refinements such as are not to be found among the tongues spoken by any of the other peoples of the Malayan Archipelago or the mainland of south-eastern Asia. Dusuns and Muruts alike are in a very low state of civilization, and both indulge inordinately in the use of intoxicating liquors of their own manufacture.

Settlements and Communication.—The company possesses a number of small stations along the coast, of which Sandakan,

with a population of 9500, is the most important. The remainder which call for separate mention are Lahat Datu on Darvel Bay on the east coast; Kudat on Marudu Bay and Jesselton on Gaya Bay on the west coast. A railway of indifferent construction runs along the west coast from Jesselton to Weston on Brunei Bay, with a branch along the banks of the Padas to Tenom above the rapids. It was originally intended that this should eventually be extended across the territory to Cowie Harbour (Sabuko Bay) on the east coast, but the extraordinary engineering difficulties which oppose themselves to such an extension, the sparse population of the territory, and the failure of the existing line to justify the expectations entertained by its designers, combine to render the prosecution of any such project highly improbable. Sandakan is connected by telegraph with Mempakul on the west coast whence a cable runs to Labuan and so gives telegraphic communication with Singapore. The overland line from Mempakul to Sandakan, however, passes through forest-clad and very difficult country, and telegraphic communication is therefore subject to very frequent interruption. Telegraphic communication between Mempakul and Kudat, via Jesselton, has also been established and is more regularly and successfully maintained. The only roads in the territory are bridle-paths in the immediate vicinity of the company's principal stations. The Sabah Steamship Company, subsidized by the Chartered Company, runs steamers along the coast, calling at all the company's stations at which native produce is accumulated. A German firm runs vessels at approximately bi-monthly intervals from Singapore to Labuan and thence to Sandakan, calling in on occasion at Jesselton and Kudat *en route*. There is also fairly frequent communication between Sandakan and Hong-Kong, a journey of four days' steaming.

Products and Trade.—The capabilities of the company's territory are only dimly known. Coal has been found in the neighbourhood of Cowie Harbour and elsewhere, but though its quality is believed to be as good as that exported from Dutch Borneo, it is not yet known whether it exists in payable quantities. Gold has been found in alluvial deposits on the banks of some of the rivers of the east coast, but here again the quantity available is still in serious doubt. The territory as a whole has been very imperfectly examined by geologists, and no opinion can at present be hazarded as to the mineral wealth or poverty of the company's property. Traces of mineral oil, iron ores, copper, zinc and antimony have been found, but the wealth of North Borneo still lies mainly in its jungle produce. It possesses a great profusion of excellent timber, but the difficulty of extraction has so far restricted the lumber industry within somewhat modest limits. Gutta, rubber, rattans, mangrove-bark, edible nuts, guano, edible birds'-nests, &c., are all valuable articles of export. The principal cultivated produce is tobacco, sago, coconuts, coffee, pepper, gambier and sugar-cane. Of these the tobacco and the sago are the most important. Between 1886 and 1900 the value of the tobacco crop increased from £471 to £200,000.

As is common throughout Malayan lands, the trade of North Borneo is largely in the hands of Chinese shopkeepers who send their agents inland to attend the *Tamus* (Malay, *Umū*, to meet) or fairs, which are the recognized scenes of barter between the natives of the interior and those of the coast. At Sandakan there is a Chinese population of over 2000.

Administration.—For administrative purposes the territory is divided into nine provinces: Alcock and Dewhurst in the north; Keppel on the west; Martin in the centre; Myburgh, Mayne and Elphinstone on the east coast; and Dent and Cunliffe in the south. The boundaries of these provinces, however, are purely arbitrary and not accurately defined. The form of government is modelled roughly upon the system adopted in the Malay States of the peninsula during the early days of their administration by British residents. The government is vested primarily in the court of directors appointed under the company's charter, which may be compared to the colonial office in its relation to a British colony, though the court of directors interests itself far more closely than does the colonial

department in the smaller details of local administration. The supreme authority on the spot is represented by the governor, under whom are the residents of Kudat, Darvel Bay and Keppel, officers who occupy much the same position as that usually known by the title of magistrate and collector. The less important districts are administered by district magistrates, who also collect the taxes. The principal departments, whose chiefs reside at the capital, are the treasury, the land and survey, the public works, the constabulary, the medical and the judicial. The secretariat is under the charge of a government secretary who ranks next in precedence to the governor. Legislation is by the proclamation of the governor, but there is a council, meeting at irregular intervals, upon which the principal heads of departments and one unofficial member have seats. The public service is recruited by nomination by the court of directors. The governor is the chief judge of the court of appeal, but a judge who is subordinate to him takes all ordinary supreme court cases. The laws are the Indian Penal and Civil Procedure Codes and Evidence Acts, supplemented by a few local laws promulgated by proclamation. There is an Imam's court for the trial of cases affecting Mahomedan law of marriage, succession, &c. The native chiefs are responsible to the government for the preservation of law and order in their districts. They have restricted judicial powers. The constabulary numbers some 600 men and consists of a mixed force of Sikhs, Pathans, Punjabi Mahomedans, Dyaks and Malays, officered by a few Europeans. There is a Protestant mission which supports a church—the only stone building in the territory—and a school at Sandakan, with branches at Kudat, Kaningau and Tambunan. The Roman Catholic mission maintains an orphanage, a church and school at Sandakan, and has missions among the Dusuns at several points on the west coast and in the Tambunan country. Its headquarters are at Kuching in Sarawak. The Chinese have their joss-houses and the Mahomedans a few small mosques, but the vast majority of the native inhabitants are pagans who have no buildings set apart for religious purposes.

Finance and Money.—The principal sources of revenue are the licences granted for the importation and retailing of opium, wine and spirits, which are in the hands of Chinese; a customs duty of 5% on imports; an export tax of 5% on jungle produce; a poll-tax sanctioned by ancient native custom; and a stamp duty. A land revenue is derived from the sale of government lands, from quit rents and fees of transfer, &c. Judicial fees bring in a small amount, and the issue and sale of postage and revenue stamps have proved a fruitful source of income. The people of the country are by no means heavily taxed, a large number of the natives of the interior escaping all payment of dues to the company, the revenue being for the most part contributed by the more civilized members of the community residing in the neighbourhood of the company's stations. There are bank agencies in Sandakan, and the company does banking business when required. The state, which has adopted the penny postage, is in the Postal Union, and money orders on North Borneo are issued in the United Kingdom and in most British colonies and vice versa. Notes issued by the principal banks in Singapore were made current in North Borneo in 1900. There is also a government note issue issued by the company for use within the territory only. The currency is the Mexican and British dollar, the company issuing its own copper coin—viz. cents and half cents. It is proposed to adopt the coinage of the Straits Settlements, and measures have been taken with a view to the accomplishment of this. In the interior the principal medium of exchange among the natives is the large earthenware jars, imported originally, it is believed, from China, which form the chief wealth both of tribes and individuals. (H. Cl.)

AUTHORITIES.—Among early works may be mentioned, S. Blommaert, *Discours ende ghelegenheit van het eylandt Borneo int Jear 1609*; *Hacheylke reystogt van Jacob Janss. de Roy na Borneo en Achin in het jaar 1691*; Beeckman, *Visit to Borneo, 1718*, in J. Pinkerton's *General Collections* (1808-1814); F. Valentijn in *Ond en Nieuw Oost Indiën* (Dordrecht, 1724-1726). See also H. Keppel, *Expedition to Borneo of H. M. S. "Dido"* (London, 1846); R. Mundy, *Narrative of Events in Borneo and Celebes* (London, 1848); F. S.

Marryat, *Borneo, &c.* (1848); P. J. Veth, *Borneo's Westerafdeeling* (Zalt-Bommel, 1854 and 1856); S. Müller, *Reisen en onderzoekingen in den Indischen Archipel* (Amsterdam, 1857); C. Bock, *Head-hunters of Borneo* (London, 1881), and *Reis in Oost en Zuid-Borneo* (The Hague, 1887); J. Hatton, *The New Ceylon, a Sketch of British North Borneo* (London, 1882); F. Hatton, *North Borneo* (London, 1885); T. Posewicz, *Borneo . . . Verbreitung der nutzbaren Mineralien* (Berlin, 1889), Eng. trans., *Borneo; its Geology and Mineral Resources* (London, 1892); J. Whitehead, *Exploration of Mount Kiri Batu* (London, 1893); Mrs W. B. Pryor, *A Decade in Borneo* (London, 1894); H. Ling Roth, *The Natives of Sarawak and North Borneo* (London, 1896); G. A. F. Molengraaf, *Geologische Verkinningstochten in Centraal Borneo* (Leiden, 1900, Eng. trans. 1902); A. W. Niessenhuis, *In Centraal Borneo* (Leiden, 1901), and *Over door Borneo* (Leiden, 1904), &c.; W. H. Furness, *Horns Life of Borneo Head-hunters* (London, 1902); O. Beccari, *Nelle Foreste di Borneo* (Florence, 1902), Eng. trans., *Wanderings in the Great Forests of Borneo* (London, 1904); D. Cator, *Everyday Life among the Head-hunters* (London, 1905). For geology, besides the works of Posewicz and Molengraaf already cited, see R. B. Newton in *Geol. Mag.*, 1897, pp. 407-415, and *Proc. Malac. Soc.*, London, vol. v. (1902-1903), pp. 403-409. A series of papers on the palaeontology of the island will be found in the several volumes of the *Samm. Geol. R. Mus.* Leiden.

BORNHOLM, an island in the Baltic Sea, 22 m. S.E. of the Swedish coast, belonging to Denmark, lying on 15° E., and between 55° and 55° 18' N., and measuring 24 m. from S.E. to N.W. and 19 (extreme) from E. to W. Pop. (1901) 40,889. The surface is generally hilly; the scenery is fine in the north, where the cliffs reach a height of 135 ft., and the granite hill of Helligdomsklipper dominates the island. Besides freestone, exported for building, limestone, blue marble, and porcelain-clay are worked. A little coal is found and used locally, but it is not of good quality. Oats, flax and hemp are cultivated. The inhabitants are employed in agriculture, fishing, brewing, distillation and the manufacture of earthenware. Weaving and clock-making are also carried on to some extent. The capital is Rønne (115 m. by sea from Copenhagen), and there are five other small towns on the island—Svanike, Neksbø, Hasle, Allinge, and Sandvig. A railway connects Rønne with Neksbø (22 m. E. by S.), where a bust commemorates J. N. Madvig, the philologist, who was born there in 1804 (d. 1886). Blanch's Hotel, 10 m. N. of Rønne, is the most favoured resort on the island, which attracts many visitors. On the north-west coast are the ruins of the castle of Hammershus, which was built in 1158, and long served as a state prison; while another old castle, erected by Christian V. in 1684, and important as commanding the entrance to the Baltic, is situated on Christiansø, one of a small group of islands 15 m. E. by N. The island of Bornholm has had an eventful history. In early times it was long the independent seat of marauding Vikings. In the 12th century it became a fief of the archbishop of Lund. In 1510 it was captured by the Hanseatic League, in 1521 it came under Danish sway, and in 1526 it was made directly subject to the city of Lübeck. In 1645 the Swedes took it by storm, and their possession of it was confirmed by the peace of Roskilde in 1658; but the sympathies of the people were with Denmark, and a popular insurrection succeeded in expelling the Swedish forces, the island coming finally into the possession of Denmark in 1660.

BORNIER, HENRI, VICOMTE DE (1825-1901) French poet and dramatist, was born at Lunel (Hérault) on the 25th of December 1825. He came to Paris in 1845 with the object of studying law, but in that year he published a volume of verse, *Les Premières Feuilles*, and the *Comédie Française* accepted a play of his entitled *Le Mariage de Luther*. He was given a post in the library of the Arsenal, where he served for half a century, becoming director in 1880. In 1875 was produced at the Théâtre Français his heroic drama in verse, *La Fille de Roland*. The action of the play turns on the love of Gérard, son of the traitor Ganelon, for the daughter of Roland. The patriotic subject and the nobility of the character of Gérard, who renounces Berthe when he learns his real origin, procured for the piece a great success. The conflict between honour and love and the grandiose sentiment of the play inevitably provoked comparison with *Cornéille*. The piece would indeed be a masterpiece if, as its critics were not slow to point out, the verse had been quite equal to the subject. Among the numerous other works of M. de

Bornier should be mentioned: *Dimitri* (1876), libretto of an opera by M. V. de Joncières; and the dramas, *Les Noces d'Attila* (1880) and *Mahomet* (1888). The production of this last piece was forbidden in deference to the representations of the Turkish ambassador. Henri de Bornier was critic of the *Nouvelle Revue* from 1879 to 1887. His *Poésies complètes* were published in 1894. He died in January 1901.

BORNU, a country in the Central Sudan, lying W. and S. of Lake Chad. It is bounded W. and S. by the Hausa states and N. by the Sahara. Formerly an independent Mahomedan sultanate it has been divided between Great Britain, Germany and France. To France has fallen a portion of northern Bornu and also Zinder (*q.v.*), a tributary state to the north-west, while the south-west part is incorporated in the German colony of Cameroon. Three-fourths of Bornu proper, some 50,000 sq. m., forms part of the British protectorate of Nigeria.

Bornu is for the most part an alluvial plain, the country sloping gradually to Lake Chad, which formerly spread over a much larger area than it now occupies. The Komadugu (*i.e.* river) Waube—generally known as the Yo—and its tributaries rise in the highlands which, beyond the western border of Bornu, form the watershed between the Niger and Chad systems, and flow north and east across the plains to Lake Chad, the Yo in its last few miles marking the frontier between the French and British possessions. In the south-west a part of Bornu drains to the Benue. The rivers are intermittent, and water in southern Bornu is obtained only from wells, which are sunk to a great depth. The vast plain of Bornu is stoneless, except for rare outcrops of ironstone, and consists of the porous fissured black earth called "cotton soil" in India, alternating with, or more probably overlaid by, sand. Throughout the flat country water is apparently found everywhere at a depth of 54 ft., corresponding to the level of Chad. Towards Damjiri in the north-west the country becomes more broken, hilly and timbered. In the south limestone is found near Gujba and also along the Gongola tributary of the Benue. A forest of red and green barked acacia, yielding the species of gum most valuable in the market, extends from the Gongola to Gujba. Immense baobabs (*Adansonia digitata*), fine tamarinds and a few trees of the genus *Ficus* are met with in the south. North of Maifoni (latitude 12° N.) the baobab ceases, except at Kuka, where extensive plantations have been made, and its place is taken by the *Kigelia* and also by a very handsome species of *Diospyros*. North of Kuka is a dense belt of *Hypbaene* palm with fine tamarinds and figs. Cotton and indigo grow wild, and afford the materials for the cloths, finely dyed with blue stripes, which form the staple fabric of the country. On the shores of Lake Chad the cotton grown is of a peculiarly fine quality. Rice and wheat of excellent quality are raised, but in small quantities, the staple food being a species of millet called *gussub*, which is made into a kind of paste and eaten with butter or honey. Ground-nuts, yams, sweet potatoes, several sorts of beans and grains, peppers, onions, water-melons and tomatoes are grown. Of fruit trees the country possesses the lime and fig.

Wild animals, in great numbers, find both food and cover in the extensive districts of wood and marsh. Lions, giraffes, elephants, hyenas, crocodiles, hippopotami, antelopes, gazelles and ostriches are found. The horse, the camel and the ox are the chief domestic animals; all are used as beasts of burden. The country abounds with bees, and honey forms one of the chief Bornuese delicacies.

The climate, especially from March to the end of June, is oppressively hot, rising sometimes to 105° and 107°, and even during most of the night not falling much below 100°. In May the wet season begins, with violent storms of thunder and lightning. In the end of June the rivers and lakes begin to overflow, and for several months the rains, accompanied with sultry weather, are almost incessant. The inhabitants at this season suffer greatly from fevers. In October the rains abate; cool, fresh winds blow from the west and north-west; and for several months the climate is healthy and agreeable.

Inhabitants.—The inhabitants, of whom the great majority

profess Mahomedanism, are divided into Negroes and those of mixed blood, *i.e.* Negro and Berber, Arab or other crossing. The total population of British Bornu is estimated at 500,000. The dominant tribe, called Bornuese, Berberi or Kanuri, a Negro race with an infusion of Berber blood, have black skins, large mouths, thick lips and broad noses, but good teeth and high foreheads. The females add to their want of beauty by extensive tattooing; they also stain their faces with indigo, and dye their front teeth black and their canine teeth red. The law allows polygamy, but the richest men have seldom more than two or three wives. The marriage ceremonies last for a whole week, the first three days being spent in feasting on the favourite national dishes, and the others appropriated to certain symbolical rites. A favourite amusement is the watching of wrestling matches. A game bearing some resemblance to chess, played with beans and holes in the sand, is also a favourite occupation.

The pastoral districts of the country are occupied by the Shuwas, who are of Arab origin, and speak a well-preserved dialect of Arabic. Of the date of their immigration from the East there is no record; but they were in the country as early as the middle of the 17th century. They are divided into numerous distinct clans. Their villages in general consist of rudely constructed huts, of an exaggerated conical form. Another tribe, called La Salas, inhabits a number of low fertile islands in Lake Chad, separated from the mainland by fordable channels.

The Bornuese are noted horsemen, and in times of war the horses, as well as the riders, used to be cased in light iron mail. The Shuwas, however, are clad only in a light shirt, and the Kanembu spearmen go almost naked, and fight with shield and spear. It is indispensable to a chief of rank that he should possess a huge belly, and when high feeding cannot produce this, padding gives the appearance of it. Notwithstanding the heat of the climate, the body is enveloped in successive robes, the number indicating the rank of the wearer. The head likewise is enclosed in numerous turbans. The prevailing language in Bornu is the Kanuri. It has no affinity, according to Heinrich Barth, with the great Berber family. A grammar was published in 1854 by S. W. Koelle, as well as a volume of tales and fables, with a translation and vocabulary.

The towns in Bornu, which have populations varying from 10,000 to 50,000 or more, are surrounded with walls 35 or 40 ft. in height and 20 ft. in thickness, having at each of the four corners a triple gate, composed of strong planks of wood, with bars of iron. The abodes of the principal inhabitants form an enclosed square, in which are separate houses for each of the wives; the chief's palace consists of turrets connected together by terraces. These are well built of a reddish clay, highly polished, so as to resemble stucco; the interior roof, though composed only of branches, is tastefully constructed. Maidugari, which in 1908 became the seat of the native government, is a thriving commercial town some 70 m. south-west of Lake Chad. The former capital, Kuka (*q.v.*), and Ngornu (the town of "blessing"), are near the shores of Lake Chad. On the Yo are still to be seen extensive remains of Old Bornu or Birni and Gambarou or Ghambaru, which were destroyed by the Fula about 1809. Dikwa, the capital chosen by Rabah (see below), lies in the German part of Bornu.

History.—The history of Bornu goes back to the 9th century A.D., but its early portions are very fragmentary and dubious. The first dynasty known is that of the Sefuwa or descendants of Sef, which came to the throne in the person of Dugu or Duku, and had its capital at Njimiye (Jima) in Kanem on the north-east shores of Lake Chad. The Sefuwa are of Berber origin, the descent from Sef, the Himyaritic ruler, being mythical. From this Berber strain comes the name Berberi or Ba-Berberche, applied by the Hausa to the inhabitants of Bornu. Mahomedanism was adopted towards the end of the 11th century, and has since continued the religion of the country. From 1194 to 1220 reigned Selma II., under whom the power of the kingdom was greatly extended; and Dunama II., his successor

was also a powerful and warlike prince. In the following reigns the prosperity of the country began to diminish, and about 1386 the dynasty was expelled from Nijimiye, and forced to seek refuge in the western part of its territory by the invasion of the Bulala. Mai Ali (I.) Ghajideni, who founded the city of Birni, rendered his country once more redoubtable and strong. His successor, Idris II., completely vanquished the Bulala and subjugated Kanem; and under Mahommed V., the next monarch, Bornu reached its highest pitch of greatness. At this period Zinder became a tributary state. A series of for the most part peaceful reigns succeeded till about the middle of the 18th century, when Ali (IV.) Omarmi entered upon a violent struggle with the Tuareg or Imoshagh. Under his son Ahmed (about 1808) the kingdom began to be harassed by the Fula, who had already conquered the Hausa country. Expelled from his capital by the invaders, Ahmed was only restored by the assistance of the fakir Mahommed al-Amin al-Kanemi, who, pretending to a celestial mission, hoisted the green flag of the Prophet, and undertook the deliverance of his country. The Fula appear to have been taken by surprise, and were in ten months driven completely out of Bornu. The conqueror invested the nearest heir of the ancient kings with all the appearance of sovereignty—reserving for himself, however, under the title of sheik, all its reality. The court of the sultan (*shehu*) was established at New Bornu, or Birni, which was made the capital, the old city having been destroyed during the Fula invasion; while the sheik, in military state, took up his residence at the new city of Kuka. Fairly established, he ruled the country with a rod of iron, and at the same time inspired his subjects with a superstitious notion of his sanctity. His zeal was peculiarly directed against moral or religious offences. The most frivolous faults of women, as talking too loud, and walking in the street unveiled, rendered the offender liable to public indictment, while graver errors were visited with the most ignominious punishments, and often with death itself. Kanemi died in 1835, and was succeeded by his son, Sheik Omar, who altogether abolished the nominal kingship of the Sefuwa.

During Omar's reign, which lasted about fifty years, Bornu was visited by many Europeans, who reached it via Tripoli and the Sahara. The first to enter the country were Walter Oudney, Hugh Clapperton and Dixon Denham (1823). They were followed in 1851–1855 by Heinrich Barth. Later travellers included Gerhard Rohlfs (1866) and Gustav Nachtigal. All these travellers were well received by the Kanuri, whose power from the middle of the 19th century began to decay. This was foreseen by Barth; and Nachtigal, who in 1870 conveyed presents sent by King William of Prussia, in acknowledgment of the sheik's kindness to many German explorers, writes thus in December 1872:

"The rapid declension of Bornu is an undeniable and lamentable fact. It is taking place with increasing rapidity, and the boundless weakness of Sheik Omar—otherwise so worthy and brave a man—must bear almost all the blame. His sons and ministers plunder the provinces in an almost unheard-of manner; trade and intercourse are almost at a standstill; good faith and confidence exist no more. The indolence of the court avoids military expeditions, and anarchy and a lack of security on the routes are the consequences. . . . Thus the sheik and the land grow poorer and poorer, and public morality sinks lower and lower."

After the visit of Nachtigal the country was visited by no European traveller until 1892, when Colonel P. L. Monteil resided for a time at Kuka during his great journey from the Senegal to Tripoli. The French traveller noticed many signs of decadence, the energy of the people being sapped by luxury, while a virtual anarchy prevailed owing to rivalries and intrigues among members of the royal family. The chief of Zinder had ceased to pay tribute, and the sultan was not strong enough to exact it by force. At the same time a danger was threatening from the south-east, where the negro adventurer Rabah, once a slave of Zobeir Pasha, was menacing the kingdom of Bagirmi. After making himself master of the fortified town of Manifa, Rabah proceeded against Bornu, defeating the army of the sultan Ahsem in two pitched battles. In December 1893 Ahsem fled from Kuka, which was entered by Rabah and soon afterwards destroyed, the capital being transferred to Dikwa in the south-

east of the kingdom. These events ruined for many years the trade between Tripoli and Kuka by the long-established route via Bilma. Rabah had raised a large, well-drilled army, and proved a formidable opponent to the French in their advance on Lake Chad from the south. However in 1900 he was killed at Kussuri near the lower Shari, by the combined forces of three French expeditions which had been converging from the Congo, the Sahara and the Niger.

By an Anglo-French agreement of 1898 the tributary state of Zinder in the north had been included in the French sphere, and after the defeat of Rabah French military expeditions occupied both the German and British portions of Bornu, but in 1902 on the appearance of British and German expeditions the French withdrew to their own country east of the Shari. The British placed on the throne of Bornu Shehu Garbai, a descendant of the ancient sultans, and Kuka was again chosen as the capital of the state. From that date British Bornu has been under administrative control. It has been divided into East and West Bornu, the line of division being fixed approximately at longitude 12°, and placed under the administration of a resident. Maifoni and Kuka were selected for British stations in the east, and Damjiri and Gujba in the west. Garrisons are quartered at these points. The province has been mapped, and a network of tracks available for wheeled transport has been made through it. Water communication with the Benue and Niger has been opened through the Gongola river. The *shehu*, who took the oath of allegiance to the British crown on the occasion of his formal installation in November 1904, is maintained in all local dignity as a native chief, and co-operates loyally with the British administration. Peace has prevailed in Bornu since the British occupation, and it is estimated that the population has increased by immigration to about 50% more than it was in 1902. The people are industrious. Extensive areas are being brought under cultivation, and taxes are collected without difficulty. Owing to its increasing commercial importance, the native capital was in 1908 transferred to Maidugari (see also NIGERIA: *History*; and RABAH).

AUTHORITIES.—Heinrich Barth's *Travels in North and Central Africa* (1857, new ed., London, 1890) contains an exact picture of the state in the period (c. 1850) preceding its decay. The earlier *Travels of Denham and Clapperton* (London, 1828) may also be consulted, as well as Rohlfs, *Land und Volk in Afrika* (Bremen, 1870); Nachtigal, *Sahara und Sudan*, vol. i. (Berlin, 1879); and Monteil, *de St.-Louis à Tripoli par le lac Tchad* (Paris, 1895). For later information consult Lady Lugard's *A Tropical Dependency* (London, 1905), and the *Annual Reports*, from 1900 onward, on Northern Nigeria, issued by the Colonial Office, London. (F. L. L.)

BORODIN, ALEXANDER PORFYRIEVICH (1834–1887), Russian musical composer, natural son of a Russian prince, was born in St Petersburg on the 12th of November 1834. He was brought up to the medical profession, and in 1862 was appointed assistant professor of chemistry at the St Petersburg academy of medicine. He wrote several works on chemistry, and took a leading part in advocating women's education, helping to found the school of medicine for women, and lecturing there from 1872 till his death. But he is best known as a musician. His interest in music was indeed stimulated from 1862 onwards by his friendship with Balakirev, and from 1863 by his marriage with a lady who was an accomplished pianist; but in his earlier years he had been proficient both in playing the piano, violin, 'cello and other instruments, and also in composing; and during life he did his best to pursue his studies in both music and chemistry with equal enthusiasm. Like other Russian composers he owed much to the influence of Liszt at Weimar. His first symphony was written in 1862–1867; his opera *Prince Igor*, begun in 1869, was left unfinished at his death, and was completed by Rimsky-Korsakov and Glazounov (1880); his symphonic sketch, "In the Steppes" (1880) is, however, his best-known work. Borodin also wrote a second symphony (1871–1877), part of a third (orchestrated after his death by Glazounov), and a few string quartets and some fine songs. His music is characteristically Russian, and of an advanced modern type. He died suddenly at St Petersburg, on the 28th of February 1887.

BORODINO, a village of Russia, 70 m. W. by S. of Moscow, on the Kolotscha, an affluent of the river Moskva, famous as the scene of a great battle between the army of Napoleon and the Russians under Kutusov on the 7th of September 1812. Though the battle is remembered chiefly for the terrible losses incurred by both sides, in many respects it is an excellent example of Napoleon's tactical methods. After preliminary fighting on the 5th of September both sides prepared for battle on the 6th, Napoleon holding back in the hope of confirming the enemy in his resolution to fight a decisive battle. For the same reason the French right wing, which could have manoeuvred the Russians from their position, was designedly weakened. The Russian right, bent back at an angle and strongly posted, was also neglected, for Napoleon intended to make a direct frontal attack. The enemy's right centre near the village of Borodino was to be attacked by the viceroy of Italy, Eugene, who was afterwards to roll up the Russian line towards its centre, the so-called "great redoubt," which was to be attacked directly from the front by Ney and Junot. Farther to the French right, Davout was to attack frontally a group of field works on which the Russian left centre was formed; and the extreme right of the French army was composed of the weak corps of Poniatowski. The cavalry corps were assigned to the various leaders named, and the Guard was held in reserve. The whole line was not more than about 2 m. long, giving an average of over 20 men per yard. When the Russians closed on their centre they were even more densely massed, and their reserves were subjected to an effective fire from the French field guns. At 6 A.M. on the 7th of September the French attack began. By 8 A.M. the Russian centre was driven in, and though a furious counter-attack enabled Prince Bagration's troops to win back their original line, fresh French troops under Davout and Ney drove them back again. But the Russians, though they lost ground elsewhere, still clung to the great redoubt, and for a time the advance of the French was suspended by Napoleon's order, owing to a cavalry attack by the Russians on Eugene's extreme left. When this alarm was ended the advance was resumed. Napoleon had now collected a sufficient target for his guns. A terrific bombardment by the artillery was followed by the decisive charge of the battle, made by great masses of cavalry. The horsemen, followed by the infantry, charged at speed, broke the Russian line in two, and the French squadrons entered the gorge of the great redoubt just as Eugene's infantry climbed up its faces. In a fearful mêlée the Russian garrison of the redoubt was almost annihilated. The defenders were now dislodged from their main line and the battle was practically at an end. Napoleon has been criticized for not using the Guard, which was intact, to complete the victory. There is, however, no evidence that any further expenditure of men would have had good results. Napoleon had imposed his will on the enemy so far that they ceded possession of Moscow without further resistance. That the defeat and losses of the Russian field army did not end the war was due to the national spirit of the Russians, not to military miscalculations of Napoleon. Had it not been for this spirit, Borodino would have been decisive of the war without the final blow of the Guard. As it was, the Russians lost about 42,000 men out of 121,000; Napoleon's army (of which one-half consisted of the contingents of subject allies—Germany, Poland, Switzerland, Holland, &c.) 32,000 out of 130,000 (Berndt, *Zahl im Kriege*). On the side of the French 31 general officers were killed, wounded or taken, and amongst the killed were General Montbrun, who fell at the head of his cavalry corps, and Auguste Caulaincourt, who took Montbrun's place and fell in the *mêlée* in the redoubt. The Russians lost 22 generals, amongst them Prince Bagration, who died of his wounds after the battle, and to whose memory a monument was erected on the battle-field by the tsar Nicholas I.

BOROLANITE, one of the most remarkable rocks of the British Isles, found on the shores of Loch Borolan in Sutherlandshire, after which it has been named. In this locality there is a considerable area of granite rich in red alkali felspar, and passing, by diminution in the amount of its quartz, into quartz-

syenites (nordmarkites) and syenites. At the margins of the outcrop patches of nepheline-syenite occur; usually the nepheline is decomposed, but occasionally it is well-preserved; the other ingredients of the rock are brown garnet (melanite) and aegirine. The abundance of melanite is very unusual in igneous rocks, though some syenites, leucitophyres, and aegirine-felsites resemble borolanite in this respect. In places the nepheline-syenite assumes the form of a dark rock with large rounded white spots. These last consist of an intermixture of nepheline or sodalite and alkali-felspar. From the analogy of certain leucite-syenites which are known in Arkansas, it is very probable that these spots represent original leucites which have been changed into aggregates of the above-named minerals. They resemble leucite in their shape, but have not yet been proved to have its crystalline outlines. The "pseudo-leucites," as they have been called, measure one-quarter to three-quarters of an inch across. The dark matrix consists of biotite, aegirine-augite and melanite. Connected with the borolanite there are other types of nepheline-syenite and pegmatite. In Finland, melanite-bearing nepheline rocks have been found and described as Ijolite, but the only other locality for melanite-leucite-syenite is Magnet Cove in Arkansas. (J. S. F.)

BORON (symbol B, atomic weight 11), one of the non-metallic elements, occurring in nature in the form of boric (boric) acid, and in various borates such as borax, tincal, boronatrocalcite and boracite. It was isolated by J. Gay Lussac and L. Thénard in 1808 by heating boron trioxide with potassium, in an iron tube. It was also isolated at about the same time by Sir H. Davy, from boric acid. It may be obtained as a dark brown amorphous powder by placing a mixture of 10 parts of the roughly powdered oxide with 6 parts of metallic sodium in a red-hot crucible, and covering the mixture with a layer of well-dried common salt. After the vigorous reaction has ceased and all the sodium has been used up, the mass is thrown into dilute hydrochloric acid, when the soluble sodium salts go into solution, and the insoluble boron remains as a brown powder, which may be filtered off and dried. H. Moissan (*Ann. Chim. Phys.*, 1895, 6, p. 296) heats three parts of the oxide with one part of magnesium powder. The dark product obtained is washed with water, hydrochloric acid and hydrofluoric acid, and finally calcined again with the oxide or with borax, being protected from air during the operation by a layer of charcoal. Pure amorphous boron is a chestnut-coloured powder of specific gravity 2.45; it sublimes in the electric arc, is totally unaffected by air at ordinary temperatures, and burns on strong ignition with production of the oxide B_2O_3 and the nitride BN. It combines directly with fluorine at ordinary temperature, and with chlorine, bromine and sulphur on heating. It does not react with the alkali metals, but combines with magnesium at a low red heat to form a boride, and with other metals at more or less elevated temperatures. It reduces many metallic oxides, such as lead monoxide and cupric oxide, and decomposes water at a red heat. Heated with sulphuric acid and with nitric acid it is oxidized to boric acid, whilst on fusion with alkaline carbonates and hydroxides it gives a borate of the alkali metal. Like silicon and carbon, very varying values had been given for its specific heat, until H. F. Weber showed that the specific heat increases rapidly with increasing temperature. By strongly heating a mixture of boron trioxide and aluminium, protected from the air by a layer of charcoal, F. Wöhler and H. Sainte-Claire Deville obtained a grey product, from which, on dissolving out the aluminium with sodium hydroxide, they obtained a crystalline product, which they thought to be a modification of boron, but which was shown later to be a mixture of aluminium borides with more or less carbon. Boron dissolves in molten aluminium, and on cooling, transparent, almost colourless crystals are obtained, possessing a lustre, hardness and refractivity near that of the diamond. In 1904 K. A. Kühne (D.R.P. 147,871) described a process in which external heating is not necessary, a mixture of aluminium turnings, sulphur and boric acid being ignited by a hot iron rod, the resulting aluminium sulphide, formed as a by-product, being decomposed by water.

Boron hydride has probably never been isolated in the pure condition; on heating boron trioxide with magnesium filings, a magnesium boride Mg_2B_3 is obtained, and if this be decomposed with dilute hydrochloric acid a very evil-smelling gas, consisting of a mixture of hydrogen and boron hydride, is obtained. This mixture burns with a green flame forming boron trioxide; whilst boron is deposited on passing the gas mixture through a hot tube, or on depressing a cold surface in the gas flame. By cooling it with liquid air Sir W. Ramsay and H. S. Hatfield obtained from it a gas of composition B_3H_8 . The mixture probably contained also some BH_3 (W. Ramsay and H. S. Hatfield, *Proc. Chem. Soc.*, 17, p. 152). Boron fluoride BF_3 was first prepared in 1808 by Gay Lussac and L. Thénard and is best obtained by heating a mixture of the trioxide and fluorspar with concentrated sulphuric acid. It is a colourless pungent gas which is exceedingly soluble in water. It fumes strongly in air, and does not attack glass. It rapidly absorbs the elements of water wherever possible, so that a strip of paper plunged into the gas is rapidly charred. It does not burn, neither does it support combustion. A saturated solution of the gas, in water, is a colourless, oily, strongly fuming liquid which after a time decomposes, with separation of metaphoric acid, leaving hydrofluoboric acid $HF \cdot BF_3$ in solution. This acid cannot be isolated in the free condition, but many of its salts are known. Boron fluoride also combines with ammonia gas, equal volumes of the two gases giving a white crystalline solid of composition $BF_3 \cdot NH_3$; with excess of ammonia gas, colourless liquids $BF_3 \cdot 2NH_3$, and $BF_3 \cdot 3NH_3$ are produced, which on heating lose ammonia and are converted into the solid form.

Boron chloride BCl_3 results when amorphous boron is heated in chlorine gas, or more readily, on passing a stream of chlorine over a heated mixture of boron trioxide and charcoal, the volatile product being condensed in a tube surrounded by a freezing mixture. It is a colourless fuming liquid boiling at $17-18^\circ C.$, and is readily decomposed by water with formation of boric and hydrochloric acids. It unites readily with ammonia gas forming a white crystalline solid of composition $2BCl_3 \cdot 3NH_3$.

Boron bromide BBr_3 can be formed by direct union of the two elements, but is best obtained by the method used for the preparation of the chloride. It is a colourless fuming liquid boiling at $90.5^\circ C.$ With water and with ammonia it undergoes the same reactions as the chloride. Boron and iodine do not combine directly, but gaseous hydroiodic acid reacts with amorphous boron to form the iodide, BI_3 , which can also be obtained by passing boron chloride and hydroiodic acid through a red-hot porcelain tube. It is a white crystalline solid of melting point $43^\circ C.$; it boils at $210^\circ C.$, and it can be distilled without decomposition. It is decomposed by water, and with a solution of yellow phosphorus in carbon bisulphide it gives a red powder of composition PBI_3 , which sublimes *in vacuo* at $210^\circ C.$ to red crystals, and when heated in a current of hydrogen loses its iodine and leaves a residue of boron phosphide PB .

Boron nitride BN is formed when boron is burned either in air or in nitrogen, but can be obtained more readily by heating to redness in a platinum crucible a mixture of one part of anhydrous borax with two parts of dry ammonium chloride. After fusion the melt is well washed with dilute hydrochloric acid and then with water, the nitride remaining as a white powder. It can also be prepared by heating borimide $B_3(NH)_3$ or by heating boron trioxide with a metallic cyanide. It is insoluble in water and unaffected by most reagents, but when heated in a current of steam or boiled for some time with a caustic alkali, slowly decomposes with evolution of ammonia and the formation of boron trioxide or an alkaline borate; it dissolves slowly in hydrofluoric acid.

Borimide $B_3(NH)_3$ is obtained on long heating of the compound $B_2S_3 \cdot 6NH_3$ in a stream of hydrogen, or ammonia gas at $115-120^\circ C.$ It is a white solid which decomposes on heating into boron nitride and ammonia. Long-continued heating with water also decomposes it slowly.

Boron sulphide B_2S_3 can be obtained by the direct union of the two elements at a white heat or from the tri-iodide and sulphur at $440^\circ C.$, but is most conveniently prepared by heating a mixture of the trioxide and carbon in a stream of carbon bisulphide vapour. It forms slightly coloured small crystals possessing a strong disagreeable smell, and is rapidly decomposed by water with the formation of boric acid and sulphuretted hydrogen. A pentasulphide B_2S_5 is prepared, in an impure condition, by heating a solution of sulphur in carbon bisulphide with boron iodide, and forms a white crystalline powder which decomposes under the influence of water into sulphur, sulphuretted hydrogen and boric acid.

Boron trioxide B_2O_3 is the only known oxide of boron; and may be prepared by heating amorphous boron in oxygen, or better, by strongly igniting boric acid. After fusion the mass solidifies to a transparent vitreous solid which dissolves readily in water to form boric acid (*q.v.*); it is exceedingly hygroscopic and even on standing in moist air becomes opaque through absorption of water and formation of boric acid. Its specific gravity is 1.83 (J. Dumas). It is not volatile below a white heat, and consequently, if heated with salts of more volatile acids, it expels the acid forming oxide from such salts; for example, if potassium sulphate be heated with boron trioxide, sulphur trioxide is liberated and potassium borate formed. It also possesses the power of combining with most metallic oxides

at high temperatures, forming borates, which in many cases show characteristic colours. Many organic compounds of boron are known; thus, from the action of the trichloride on ethyl alcohol or on methyl alcohol, ethyl borate $B(OC_2H_5)_3$ and methyl borate $B(OC_2H_5)_3$ are obtained. These are colourless liquids boiling at $119^\circ C.$ and $72^\circ C.$ respectively, and both are readily decomposed by water. By the action of zinc methyl on ethyl borate, in the requisite proportions, boron trimethyl is obtained, thus: $2B(OC_2H_5)_3 + 6Zn(CH_3)_2 = 2B(CH_3)_3 + 6Zn \begin{matrix} CH_3 \\ | \\ OC_2H_5 \end{matrix}$ as a colourless spontaneously inflammable gas of unbearable smell. Boron triethyl $B(C_2H_5)_3$ is obtained in the same manner, by using zinc ethyl. It is a colourless spontaneously inflammable liquid of boiling point $95^\circ C.$ By the action of one molecule of ethyl borate on two molecules of zinc ethyl, the compound $B(C_2H_5)_2 \cdot OC_2H_5$, diethylboron ethoxide is obtained as a colourless liquid boiling at $102^\circ C.$ By the action of water it is converted into $B(C_2H_5)_2 \cdot OH$, and this latter compound on exposure to air takes up oxygen slowly, forming the compound $B_2C_2H_5 \cdot OC_2H_5 \cdot OH$, which, with water, gives $B(C_2H_5)_2 \cdot (OH)_2$. From the condensation of two molecules of ethyl borate with one molecule of zinc ethyl the compound $B_2C_2H_5 \cdot (OC_2H_5)_2$ is obtained as a colourless liquid of boiling point $112^\circ C.$ Boron triethyl and boron trimethyl both combine with ammonia.

The atomic weight of boron has been determined by estimating the water content of pure borax (J. Berzelius), also by conversion of anhydrous borax into sodium chloride (W. Ramsay and E. Aston) and from analysis of the bromide and chloride (Sainte-Claire Deville); the values obtained ranging from 10.73 to 11.04. Boron can be estimated by precipitation as potassium fluoroborate, which is insoluble in a mixture of potassium acetate and alcohol. For this purpose only boric acid or its potassium salt must be present; and to ensure this, the borate can be distilled with sulphuric acid and methyl alcohol and the volatile ester absorbed in potash.

BOROUGH [BURROUGH, BURROWE, BORROWS], STEVEN (1525-1584), English navigator, was born at Northam in Devonshire on the 25th of September 1525. In 1553 he took part in the expedition which was despatched from the Thames under Sir Hugh Willoughby to look for a northern passage to Cathay and India, serving as master of the "Edward Bonaventure," on which Richard Chancellor sailed as pilot in chief. Separated by a storm from the "Bona Esperanza" and the "Bona Confidentia," the other two ships of the expedition, Borough proceeded on his voyage alone, and sailing into the White Sea, in the words of his epitaph, "discovered Moscouia by the Northerne sea passage to St Nicholas" (Archangel). In a second expedition, made in the "Serchthrift" in 1556, he discovered Kara Strait, between Novaya Zemlya and Vaygach island. In 1560 he was in charge of another expedition to Russia, and, probably in 1558, he also made a voyage to Spain. At the beginning of 1563 he was appointed chief pilot and one of the four masters of the queen's ships in the Medway, and in this office he spent the rest of his life. He died on the 12th of July 1584, and was buried at Chatham. His son, Christopher Borough, wrote a description of a trading expedition made in 1579-1581 from the White Sea to the Caspian and back.

His younger brother, WILLIAM BOROUGH, born in 1536, also at Northam, served as an ordinary seaman in the "Edward Bonaventure" on her voyage to Russia in 1553, and subsequently made many voyages to St Nicholas. Later he transferred his services from the merchant adventurers to the crown. As commander of the "Lion" he accompanied Sir Francis Drake in his Cadiz expedition of 1587, but he got himself into trouble by presuming to disagree with his chief concerning the wisdom of the attack on Lagos. He died in 1599. He was the author of "A Discourse of the Variation of the Compass, or Magneticall Needle" (1581), and some of the charts he made are preserved at the British Museum and Hatfield.

BOROUGH (A.S. nominative *burh*, dative *byrig*, which produces some of the place-names ending in *bury*, a sheltered or fortified place, the camp of refuge of a tribe, the stronghold of a chieftain; cf. Ger. *Burg*, Fr. *bor*, *borc*, *bourg*), the term for a town, considered as a unit of local government.

History of the English Borough.—After the early English settlement, when Roman fortifications ceased to shelter hostile nations, their colonies and camps were used by the Anglo-Saxon invaders to form tribal strongholds; nevertheless burhs on the sites of Roman colonies show no continuity with Roman municipal organization. The resettlement of the Roman Durovernum as

the burh of the men of (East) Kent, under a changed name, the name "burh of the men of Kent," Cant-wara-byrig (Canterbury), illustrates this point. The burh of the men of West Kent was Hofresceaster (Durobrivae), Rochester, and many other *ceasters* mark the existence of a Roman camp occupied by an early English burh. The tribal burh was protected by an earthen wall, and a general obligation to build and maintain burhs at the royal command was enforced by Anglo-Saxon law. Offences in disturbance of the peace of the burh were punished by higher fines than breaches of the peace of the "ham" or ordinary dwelling. The burh was the home of the king as well as the asylum of the tribe, and there is reason to think that the boundary of the borough was annually sanctified by a religious ceremony, and hence the long retention of a processional perambulation. Possibly the "hedge" or "wall" of the borough gave it, besides safety, a sanctity analogous to that enjoyed by the Germanic assembly while gathered within its "hedge," which the priests solemnly set up when the assembly gathered, and removed when it was over. While the "peace" of the Germanic assembly was essentially temporary, the "peace" of the burh was sacred all the year round. Its "hedge" was never removed. The sanctity of the burh was enjoyed by all the dwellings of the king, at first perhaps only during his term of residence. Neither in the early English language nor in the contemporary Latin was there any fixed usage differentiating the various words descriptive of the several forms of human settlement, and the tribal refuges cannot accordingly be clearly distinguished from villages or the strongholds of individuals by any purely nomenclative test. It is not till after the Danish invasions that it becomes easier to draw a distinction between the burhs that served as military strongholds for national defence and the royal villis which served no such purpose. Some of the royal villis eventually entered the class of boroughs, but by another route, and for the present the private stronghold and the royal dwelling may be neglected. It was the public stronghold and the administrative centre of a dependent district which was the source of the main features peculiar to the borough.

Many causes tended to create peculiar conditions in the boroughs built for national defence. They were placed where artificial defence was most needed, at the junction of roads, in the plains, on the rivers, at the centres naturally marked out for trade, seldom where hills or marshes formed a sufficient natural defence. The burhs drew commerce by every channel; the camp and the palace, the administrative centre, the ecclesiastical centre (for the mother-church of the state was placed in its chief burh), all looked to the market for their maintenance. The burh was provided by law with a mint and royal moneys and exchangers, with an authorized scale for weights and measures. Mercantile transactions in the burhs or *ports*, as they were called when their commercial rather than their military importance was accentuated, were placed by law under special legal privileges in order no doubt to secure the king's hold upon his toll. Over the burh or port was set a reeve, a royal officer answerable to the king for his dues from the burh, his rents for lands and houses, his customs on commerce, his share of the profits from judicial fines. At least from the 10th century the burh had a "moot" or court, the relation of which to the other courts is matter of speculation. A law of Edgar, about 960, required that it should meet three times a year, these being in all likelihood assemblies at which attendance was compulsory on all tenants of the burghal district, when pleas concerning life and liberty and land were held, and men were compelled to find pledges answerable for their good conduct. At these great meetings the borough reeve (*gerefa*) presided, declaring the law and guiding the judgments given by the suitors of the court. The reeve was supported by a group of assistants, called in Devon the "witan," in the boroughs of the Danelaw by a group of (generally twelve) "lawmen," in other towns probably by a group of aldermen, senior burgesses, with military and police authority, whose office was in some cases hereditary. These persons assisted the reeve at the great meetings of the full court, and sat with him as judges at the subordinate meetings which were held to settle the

unfinished causes and minor causes. There was no compulsion on those not specially summoned to attend these extra meetings. At these subordinate jurisdictional assemblies, held in public, and acting by the same authority as the annual gathering of all the *burh-wara*, other business concerning borough administration was decided, at least in later days, and it is to these assemblies that the origin of the town council may in many cases be ascribed. In the larger towns the division into wards, with a separate police system, can be traced at an early time, appearing as a unit of military organization, answerable for the defence of a gate of the town. The police system of London is described in detail in a record of 930-940. Here the free people were grouped in associations of ten, each under the superintendence of a headman. The bishops and reeves who belonged to the "court of London" appear as the directors of the system, and in them we may see the aldermen of the wards of a later time. The use of the word *bertha* for ward at Canterbury, and the fact that the London wardmoot at a later time was used for the frankpledge system as well as for the organization of the muster, point to a connexion between the military and the police systems in the towns. At the end of the 9th and beginning of the 10th century there is evidence of a systematic "timbering" of new burhs, with the object of providing strongholds for the defence of Wessex against the Danes, and it appears that the surrounding districts were charged with their maintenance. In charters of this period a "haw," or enclosed area within a burh, was often conveyed by charter as if it were an apannage of the lands in the neighbourhood with which it was conveyed; the Norman settlers who succeeded to lands in the county succeeded therewith to houses in the burhs, for a close association existed between the "thegns" of the shire and the shirestow, an association partly perhaps of duty and also of privilege. The king granted borough "haws" as places of refuge in Kent, and in London he gave them with commercial privileges to his bishops. What has been called the "heterogeneous" tenure of the shirestow, one of the most conspicuous characteristics of that particular type of borough, was further increased by the liberty which some burgesses enjoyed to "commend" themselves to a lord of their own choosing, promising to that lord suit and service and perhaps rent in return for protection. Over these burgesses the lords could claim jurisdictional rights, and these were in some cases increased by royal grants of special rights within certain "sokes." The great boroughs were honeycombed with sokes, or areas of seigniorial jurisdiction, within which the royal reeve's authority was greatly restricted while that of the lord's reeve took precedence. Even the haws, being "burhs" or strongholds within a stronghold, enjoyed a local "peace" which protected from official intrusion. Besides heterogeneity of tenure and jurisdiction in the borough, there was also heterogeneity of status; there were burh-thegns and *cnichts*, mercatores, burgesses of various kinds, the three groups representing perhaps military, commercial and agricultural elements. The burh generally shows signs of having been originally a village settlement, surrounded by open fields, of which the borough boundary before 1835 will suggest the outline. This area was as a rule eventually the area of borough jurisdiction. There is some evidence pointing to the fact that the restriction of the borough authority to this area is not ancient, but due to the Norman settlement. The wide districts over which the boroughs had had authority were placed under the control of the Norman castle which was itself built by means of the old English levy of "burh-work." The borough court was allowed to continue its work only within its own immediate territory, and, to prevent conflict, the castle was placed outside the borough. Losing their place in the national scheme of defence, the burgh "cnichts" made commerce their principal object under the encouragement of the old privileges of the walled place.

Besides the great co-operative strongholds in which many lords had burgesses, there were small boroughs held by a single lord. In many cases boroughs of this "seigniorial" type were created upon the royal estates. Out of the king's vill, as a rule the jurisdictional centre of a hundred, there was sometimes created

a borough. The lines of division before Domesday Book are obscure, but it is probable that in some cases, by a royal grant of jurisdiction, the inhabitants of a populous royal vill, where a hundred court for the district was already held, were authorized to establish a permanent court, for the settlement of their disputes, distinct from the hundred court of the district. Boroughs of this type with a uniform tenure were created not only on the king's estates but also on those of his tenants-in-chief, and in 1086 they were probably already numerous. A borough was usually, though perhaps not invariably, the companion of a Norman castle. In some cases a French "bourg" was created by the side of an English borough, and the two remained for many generations distinct in their laws and customs: in other cases a French "bourg" was settled by the side of an English village. A large number of the followers of the Norman lords had been almost certainly town-dwellers in their own country, and lost none of their burghal privileges by the migration. Every castle needed for its maintenance a group of skilled artisans, and the lords wished to draw to the castle gates all kinds of commodities for the castle's provision. The strength of the garrison made the neighbourhood of the castle a place of danger to men unprotected by legal privilege; and in order to invite to its neighbourhood desirable settlers, legal privileges similar to those enjoyed in Norman or English boroughs were guaranteed to those who would build on the plots which were offered to colonists. A low fixed rental, release from the renders required of villeins, release from the jurisdiction of the castle, and the creation of a separate borough jurisdiction, with or without the right to choose their own officers, rules fixing the maximum of fees and fines, or promising assessment of the fines by the burgesses themselves, the cancelling of all the castellan's rights, especially the right to take a forced levy of food for the castle from all within the area of his jurisdiction, freedom from arbitrary tallage, freedom of movement, the right to alienate property and devise land, these and many other privileges named in the early seigniorial charters were what constituted the Norman *liber burgus* of the seigniorial type. Not all these privileges were enjoyed by all boroughs; some very meagre releases of seigniorial rights accompanied the lord's charter which created a borough and made burgesses out of villeins. However liberal the grant, the lord or his reeve still remained in close personal relation with the burgesses of such places, and this character, together with the uniformity of their tenure, continued to hold them apart from the boroughs of the old English type, where all varieties of personal relationship between the lords and their groups of tenants might subsist. The royal charters granting the right to retain old customs prevented the systematic introduction into the old boroughs of some of the incidents of feudalism. Rights of the king took precedence of those of the lord, and devise with the king's consent was legal. By these means the lords' position was weakened, and other seigniorial claims were later evaded or contested. The rights which the lords failed to keep were divided between the king and the municipality; in London, for instance, the king obtained all escheats, while the borough court secured the right of wardship of burgess orphans.

From Norman times the yearly profit of the royal boroughs was as a rule included in the general "farm" rendered for the county by the sheriff; sometimes it was rendered by a royal farmer apart from the county-farm. The king generally accepted a composition for all the various items due from the borough. The burgesses were united in their efforts to keep that composition unchanged in amount, and to secure the provision of the right amount at the right time for fear that it should be increased by way of punishment. The levy of fines on rent arrear, and the distraints for debt due, which were obtained through the borough court, were a matter of interest to the burgesses of the court, and first taught the burgesses co-operative action. Money was raised, possibly by order of the borough court, to buy a charter from the king giving the right to choose officers who should answer directly to the exchequer and not through the sheriff of the county. The sheriff was in many cases also the constable of the castle, set by the Normans to overawe

the English boroughs; his powers were great and dangerous enough to make him an officer specially obnoxious to the boroughs. Henry I. about 1131 gave the London citizens the right to choose their own sheriffs and a justiciar answerable for keeping the pleas of the crown. In 1130 the Lincoln citizens paid to hold their city in chief of the king. By the end of the 12th century many towns paid by the hand of their own reeves, and John's charters began to make rules as to the freedom of choice to be allowed in the nomination of borough officers and as to the royal power of dismissal. In Richard I.'s reign London imitated the French communes in styling the chief officer a mayor; in 1208 Winchester also had a mayor, and the title soon became no rarity. The chartered right to choose two or more citizens to keep the pleas of the crown gave to many boroughs the control of their coroners, who occupied the position of the London justiciar of earlier days, subject to those considerable modifications which Henry II.'s systematization of the criminal law had introduced. Burgesses who had gone for criminal and civil justice to their own court in disputes between themselves, or between themselves and strangers who were in their town, secured confirmation of this right by charter, not to exclude the justices in eyre, but to exempt themselves from the necessity of pleading in a distant court. The burgess, whether plaintiff or defendant, was a privileged person, and could claim in this respect a "benefit" somewhat similar to the benefit of clergy. In permitting the boroughs to answer through their own officers for his dues, the king handed over to the boroughs the farming of his rents and a large number of rights which would eventually prove to be sources of great profit.

No records exist showing the nature of municipal proceedings at the time of the first purchase of charters. Certain it is that the communities in the 12th century became alive to the possibilities of their new position, that trade received a new impulse, and the vague constitutional powers of the borough court acquired a new need for definition. At first the selection of officers who were to treat with the exchequer and to keep the royal pleas was almost certainly restricted to a few rich persons who could find the necessary securities. Nominated probably in one of the smaller judicial assemblies, the choice was announced at the great Michaelmas assembly of the whole community, and it is not till the next century that we hear of any attempt of the "vulgus" to make a different selection from that of the magnates. The "vulgus" were able to take effective action by means of the several craft organizations, and first found the necessity to do so when taxation was heavy or when questions of trade legislation were mooted (see GILDS). The taxation of the boroughs in the reign of Henry II. was assessed by the king's justices, who fixed the sums due *per capita*; but if the borough made an offer of a gift, the assessment was made by the burgesses. In the first case the taxation fell on the magnates. In the levy *per communam* the assessment was made through the wardmoots (in London) and the burden fell on the poorer class. In Henry II.'s reign London was taxed by both methods, the *barones majores* by head, the *barones minores* through the wardmoot. The pressure of taxation led in the 13th century to a closer definition of the burghal constitutions; the commons sought to get an audit of accounts, and (in London) not only to hear but to treat of municipal affairs. By the end of the century London had definitely established two councils, that of the mayor and aldermen, representing the old borough court, and a common council, representing the voice of the commonalty, as expressed through the city wards. The choice of councillors in the wards rested probably with the aldermen and the ward jury summoned by them to make the presentments. In some cases juries were summoned not to represent different areas but different classes; thus at Lincoln there were in 1272 juries of the rich, the middling and the poor, chosen presumably by authority from groups divided by means of the tax roll. Elsewhere the several groups of traders and artisans made of their guilds all-powerful agencies for organizing joint action among classes of commons united by a trade interest, and the history of the towns becomes the history of the struggle between the guilds which

captured control of the council and the guilds which were excluded therefrom. Many municipal revolutions took place, and a large number of constitutional experiments were tried all over the country from the 13th century onward. Schemes which directed a gradual co-optation, two to choose four, these six to choose more, and so in widening circles from a centre of officialdom, found much favour throughout the middle ages. A plan, like the London plan, of two companies, alderman and council, was widely favoured in the 14th century, perhaps in imitation of the Houses of Lords and Commons. The mayor was sometimes styled the "sovereign" and was given many prerogatives. Great respect was paid to the "ancients," those, namely, who had already held municipal office. Not till the 15th century were orderly arrangements for counting "voices" arrived at in a few of the most highly developed towns, and these were used only in the small assemblies of the governing body, not in the large electoral assemblies of the people.

In London in the 13th century there was a regular system for the admission of new members to the borough "franchise," which was at first regarded not as conferring any form of suffrage but as a means to secure a privileged position in the borough court and in the trade of the borough. Admission could be obtained by inheritance, by purchase or gift, in some places by marriage, and in London, at least from 1275, by a municipal register of apprenticeship. The new freeman in return for his privileges was bound to share with the other burgesses all the burdens of taxation, control, &c., which fell upon burgesses. Personal service was not always necessary, and in some towns there were many non-resident burgesses. When in later times admission to this freedom came to be used as means to secure the parliamentary franchise, the freedom of the borough was freely sold and given. The elections in which the commons of the boroughs first took interest were those of the borough magistrates. Where the commons succeeded for a time in asserting their right to take part in borough elections they were rarely able to keep it, not in all cases perhaps because their power was feared, but sometimes because of the riotous proceedings which ensued. These led to government interference, which no party in the borough desired. The possibility of a forfeiture of their enfranchised position made the burgesses on the whole fairly submissive. In the 13th century London repeatedly was "taken into the king's hand," subjected to heavy fines and put under the constable of the Tower. In the 15th century disturbances in the boroughs led to the issue of new constitutions, some of which were the outcome of royal charters, others the result of parliamentary legislation. The development of the law of corporations also at this time compelled the boroughs to seek new charters which should satisfy the now exacting demands of the law. The charters of incorporation were issued at a time when the state was looking more and more to the borough authorities as part of its executive and judicial staff, and thus the government was closely interested in the manner of their selection. The new charters were drafted in such a way as to narrow the popular control. The corporations were placed under a council and in a number of cases popular control was excluded altogether, the whole system being made one of co-optation. The absence of popular protest may be ascribed in part to the fact that the old popular control had been more nominal than real, and the new charter gave as a rule two councils of considerable size. These councils bore a heavy burden of taxation in meeting royal loans and benevolences, paying *per capita* like the magnates of the 12th century, and for a time there is on the whole little evidence of friction between the governors and the governed. Throughout, popular opinion in the closest of corporations had a means of expression, though none of execution, in the presentments of the leet juries and sessions juries. By means of their "verdicts" they could use threats against the governing body, express their resentment against acts of the council which benefited the governing body rather than the town, and call in the aid of the justices of assize where the members of the governing body were suspected of fraud. Elizabeth repeatedly declared her dislike of incorpora-

tions "because of the abuses committed by their head rulers," but in her reign they were fairly easily controlled by the privy council, which directed their choice of members of parliament and secured supporters of the government policy to fill vacancies on the borough bench. The practice in Tudor and Stuart charters of specifying by name the members of the governing body and holders of special offices opened the way to a "purging" of the hostile spirits when new charters were required. There were also rather vaguely worded clauses authorizing the dismissal of officers for misconduct, though as a rule the appointments were for life. When under the Stuarts and under the Commonwealth political and religious feeling ran high in the boroughs, use was made of these clauses both by the majority on the council and by the central government to mould the character of the council by a drastic "purging." Another means of control first used under the Commonwealth was afforded by the various acts of parliament, which subjected all holders of municipal office to the test of an oath. Under the Commonwealth there was no improvement in the methods used by the central government to control the boroughs. All opponents of the ruling policy were disfranchised and disqualified for office by act of parliament in 1652. Cases arising out of the act were to be tried by commissioners, and the commissions of the major-generals gave them opportunity to control the borough policy. Few Commonwealth charters have been preserved, though several were issued in response to the requests of the corporations.

In some cases the charters used words which appeared to point to an opportunity for popular elections in boroughs where a usage of election by the town council had been established. In 1598 the judges gave an opinion that the town councils could by by-law determine laws for the government of the town regardless of the terms of the charter. In the 18th century the judges decided to the contrary. But even where a usage of popular election was established, there were means of controlling the result of a parliamentary election. The close corporations, though their right to choose a member of parliament might be doubtful, had the sole right to admit new burgesses, and in order to determine parliamentary elections they enfranchised non-residents. Where conflicts arose over the choice of a member, and two selections were made, the matter came before the House of Commons. On various occasions the House decided in favour of the popularly elected candidate against the nominee of the town council, on the general principle that neither the royal charter nor a by-law could curtail this particular franchise. But as each case was separately determined by a body swayed by the dominant political party, no one principle was steadily adhered to in the trial of election petitions. The royal right to create boroughs was freely used by Elizabeth and James I. as a means of securing a submissive parliament. The later Stuarts abandoned this method, and the few new boroughs made by the Georges were not made for political reasons. The object of the later Stuarts was to control the corporations already in existence, not to make new ones. Charles II. from the time of his restoration decided to exercise a strict control of the close corporations in order to secure not only submissive parliaments, but also a pliant executive among the borough justices, and pliant juries, which were impanelled at the selection of the borough officers. In 1660 it was made a rule that all future charters should reserve expressly to the crown the first nomination of the aldermen, recorder and town-clerk, and a proviso should be entered placing with the common council the return of the member of parliament. The Corporation Act of 1661 gave power to royal commissioners to settle the composition of the town councils, and to remove all who refused the sacraments of the Church of England or were suspected of disaffection, even though they offered to take the necessary oaths. Even so the difficulty of securing submissive juries was again so great in 1682 that a general attack on the borough franchises was begun by the crown. A London jury having returned a verdict hostile to the crown, after various attempts to bend the city to his will, Charles II. issued a *quo warranto* against the mayor and commonalty in order to charge the citizens with illegal encroachments upon their chartered

rights. The want of a sound philosophical principle in the laws which were intended to regulate the actions of organized groups of men made it easy for the crown judges to find flaws in the legality of the actions of the boroughs, and also made it possible for the Londoners to argue that no execution could be taken against the mayor, commonalty and citizens, a "body politic invisible"; that the indictment lay only against every particular member of the governing body; and that the corporation as a corporation was incapable of suffering a forfeiture or of making a surrender. The judges gave a judgment for the king, the charters were forfeited and the government placed with a court of aldermen of the king's own choosing. Until James II. yielded, there was no common council in London. The novelty of the proceedings of Charles II. and James II. lay in using the weapon of the *quo warranto* systematically to ensure a general revocation of charters. The new charters which were then granted required the king's consent for the more important appointments, and gave him power to remove officers without reason given. Under James II. in 1687 six commissioners were appointed to "regulate" the corporations and remove from them all persons who were opposed to the abolition of the penal laws against Catholics. The new appointments were made under a writ which ran, "We will and require you to elect" (a named person). When James II. sought to withdraw from his disastrous policy, he issued a proclamation (October 17, 1688) restoring to the boroughs their ancient charters. The governing charter thenceforth in many boroughs, though not in all, was the charter which had established a close corporation, and from this time on to 1835 the boroughs made no progress in constitutional growth. The tendency for the close corporation to treat the members of the governing body as the only corporators, and to repudiate the idea that the corporation was answerable to the inhabitants of the borough if the corporate property was squandered, became more and more manifest as the history of the past slipped into oblivion. The corporators came to regard themselves as members of a club, legally warranted in dividing the lands and goods of the same among themselves whensoever such a division should seem profitable. Even where the constitution of the corporation was not close by charter, the franchise tended to become restricted to an ever-dwindling electorate, as the old methods for the extension of the municipal franchise by other means than inheritance died out of use. At Ipswich in 1833 the "freemen" numbered only one fifty-fifth of the population. If the electorate was increased, it was increased by the wholesale admission to the freedom of voters willing to vote as directed by the corporation at parliamentary elections. The growth of corruption in the boroughs continued unchecked until the era of the Reform Bill. Several boroughs had by that time become insolvent, and some had recourse to their member of parliament to eke out their revenues. In Buckingham the mayor received the whole town revenue without rendering account; sometimes, however, heavy charges fell upon the officers. Before the Reform era dissatisfaction with the corporations was mainly shown by the number of local acts of parliament which placed under the authority of special commissioners a variety of administrative details, which if the corporation had not been suspected would certainly have been assigned to its care. The trust offered another convenient means of escape from difficulty, and in some towns out of the trust was developed a system of municipal administration where there was no recognized corporation. Thus at Peterborough the feoffees who had succeeded to the control of certain ancient charities constituted a form of town council with very restricted powers. In the 17th century Sheffield was brought under the act "to redress the misemployment of lands given to charitable uses," and the municipal administration of what had been a borough passed into the hands of the trustees of the Burgery or town trust.

The many special authorities created under act of parliament led to much confusion, conflict and overlapping, and increased the need for a general reform. The reform of the boroughs was treated as part of the question of parliamentary reform. In 1832 the exclusive privileges of the corporations in parliamentary

elections having been abolished and male occupiers enfranchised, the question of the municipal franchise was next dealt with. In 1833 a commission inquired into the administration of the municipal corporations. The result of the inquiry was the Municipal Corporations Act 1835, which gave the municipal franchise to the ratepayers. In all the municipal corporations dealt with by the act, the town council was to consist of a mayor, aldermen and councillors, and the councils were given like powers, being divided into those with and those without a commission of the peace. The minutes were to be open to the inspection of any burgess, and an audit of accounts was required. The exclusive rights of retail trading, which in some towns were restricted to freemen of the borough, were abolished. The system of police, which in some places was still medieval in character, was placed under the control of the council. The various privileged areas within the bounds of a borough were with few exceptions made part of the borough. The powers of the council to alienate corporate property were closely restricted. The operations of the act were extended by later legislation, and the divers amendments and enactments which followed were consolidated in the Municipal Corporations Act 1882. (M. BAY.)

Irish Boroughs.—In Ireland the earliest traces of burghal life are connected with the maritime settlements on the southern and eastern coast. The invasion of Henry II. colonized these Ostman ports with Anglo-Norman communities, who brought with them, or afterwards obtained, municipal charters of a favourable kind. The English settlement obviously depended on the advantages which the burgesses possessed over the native population outside. Quite different from these were the new close boroughs which during the plantation of Ulster James I. introduced from England. The conquest was by this time completed, and by a rigorous enforcement of the Supremacy and Uniformity Acts the existing liberties of the older boroughs were almost entirely withdrawn. By the new rules published (in terms of the Act of Settlement and Explanation) in 1672 resident traders were permitted to become freemen, but neither this regulation nor the ordinary admissions through birth, marriage and apprenticeship succeeded in giving to Ireland free and vigorous municipalities. The corrupt admission of non-resident freemen, in order to outvote the ancient freeholders in parliamentary elections, and the systematic exclusion of Roman Catholics, soon divorced the "commonalty" from true local interests, and made the corporations, which elected themselves or selected the constituency, dangerously unpopolar.

Scottish Boroughs.—In Scotland burghs or burrows are divided into royal burghs, burghs of regality and burghs of barony. The first were erected by royal charter, and every burgess held direct of the crown. It was, therefore, impossible to subfeu the burgh lands,—a distinction still traceable in modern conveyancing. Where perhaps no charter ever existed, the law on proof of immemorial possession of the privileges of a royal burgh has presumed that a charter of erection once existed. The charter gave power to elect provost, bailies and council, a power long exercised under the act of 1469, which directed the new council to be chosen annually by the retiring council, and the magistrates by both councils. The jurisdiction of these magistrates, which was specially reserved in the act of 1747 abolishing heritable jurisdictions, was originally cumulative with, and as large as, that of the sheriff. It is now confined to police offences, summary ejections, orders for *interim* aliment (for prisoners), payment of burgh dues and delivery of title deeds. Three head courts were held in the year, at which all burgesses were obliged to attend, and at which public business was done and private transactions were ratified. There were three classes of burgesses—burgesses *in sua arte*, members of one or other of the corporations; burgesses who were gild brothers; and simple burgesses. The Leges Burgorum apparently contemplate that all respectable inhabitants should have the franchise, but a ceremony of admission was required, at which the applicant swore fealty and promised to watch and ward for the community, and to pay his "maill" to the king. These borough maills, or rents, and the great and small customs of burghs, formed a large part of the

royal revenue, and, although frequently leased or feued out for a fixed duty, were on the accession of James I. annexed to the crown as an alimentary fund. Burgh customs still stand in the peculiar position of being neither adjudgeable nor arrestable; they are therefore bad security. The early charters contain the usual privileges of holding a market, of exemption from toll or tribute, and that distraint will be allowed only for the burgh's own debts. There was also the usual strife between the gildry and the craftsmen, who were generally prohibited from trading, and of whom dyers, fishers and shoemakers were forbidden to enter the gildry. Deacons, wardens and visitors were appointed by the crafts, and the rate of wages was fixed by the magistrates. The crafts in Scotland were frequently incorporated, not by royal charter, but, as in the case of the cordiners of Edinburgh, by seals of cause from the corporation. The trade history of the free burghs is very important. Thus in 1466 the privilege of importing and exporting merchandise was confined to freemen, burghesses and their factors. Ships were directed to trade to the king's free burghs, there to pay the customs, and to receive their exports or custom-house seals; and in 1503 persons dwelling outside burghs were forbidden to "use any merchandise," or to sell wine or staple goods. An act of 1633, erroneously called a *Ratification* of the privileges of burghs, extended these privileges of buying and selling to retail as well as wholesale trade, but restricted their enjoyment to royal burghs. Accordingly, in 1672, a general declaratory act was passed confirming to the freemen in royal burghs the wholesale trade in wine, wax, silk, dyeing materials, &c., permitting generally to all persons the export of native raw material, specially permitting the burghesses of barony and regality to export their own manufactures, and such goods as they may buy in "markets," and to import against these consignments certain materials for tillage, building, or for use in their own manufactures, with a general permission to retail all commodities. This extraordinary system was again changed in 1690 by an act which declared that freemen of royal burghs should have the sole right of importing everything by sea or land except beastial, and also of exporting by sea everything which was not native raw material, which might be freely exported by land. The gentry were always allowed to import for their personal consumption and to export an equal quantity of commodities. The act mentions that the royal burghs as an estate of the kingdom contributed one-sixth part of all public impositions, and were obliged to build and maintain prison-buses. Some of these trade privileges were not abolished till 1826.

In the north of Scotland there was an association of free burghs called the *Hanse* or *Amsur*; and the lord chamberlain, by his *Ites*, or circuit of visitation, maintained a common standard of right and duties in all burghs, and examined the state of the "common good," the accounts of which in 1535 were appointed to be laid before the auditors in exchequer. The chamberlain latterly presided in the *Curia Quatuor Burgorum* (Edinburgh, Berwick, Stirling, Roxburgh), which not only made regulations in trade, but decided questions of private right (e.g. succession), according to the varying customs of burghs. This court frequently met at Haddington; in 1454 it was fixed at Edinburgh. The more modern convention of royal burghs which appeared as a judicial *persona* in the Court of Session so late as 1839 probably dates from the act of James III. (1487, c. 111), which appointed the commissioners of burghs, both north and south, to meet yearly at Inverkeithing "to treat of the welfare of merchandise, the good rule and statutes for the common profit of burghs, and to provide for reimeid upon the thefts and injuries sustained within the burghs." Among the more important functions of this body (on whose decrees at one time summary diligence proceeded) were the prohibition of undue fractions within burghs, the revival of the "set" or mode of municipal election, and the *pro rata* division among the burghs of the parliamentary subsidy required from the third estate. The reform of the municipalities, and the complete representation of the mercantile interests in the united parliament, deprived this body of any importance.

Burghs of regality and of barony held in vassalage of some great lordship, lay or ecclesiastical, but were always in theory or in practice created by crown grant. They received jurisdiction in civil and criminal matters, generally cumulative with that of the baron or the lord of regality, who in some cases obtained the right of nominating magistrates. Powers to hold markets and to levy customs were likewise given to these burghs.

The Scottish burghs emerged slowly into political importance. In 1295 the procurators of six burghs ratified the agreement for the marriage of Edward Baliol; and in 1326 they were recognized as a third estate, granting a tenth penny on all rents for the king's life, if he should apply it for the public good. The commissioners of burghs received from the exchequer their costages or expenses of attending parliament. The burghs were represented in the judicial committee, and in the committee on articles appointed during the reign of James V. After the Reformation, in spite of the annexation of kirk lands to the crown, and the increased burdens laid on temporal lands, the proportion of general taxation borne by the burghs (*viz.* 1s. 6d.) was expressly preserved by act 1587, c. 112. The number of commissioners, of course, fluctuated from time to time. Cromwell assigned ten members to the Scottish burghs in the second parliament of Three Nations (1654). The general practice until 1619 had been, apparently, that each burgh should send two members. In that year (by an arrangement with the convention of burghs) certain groups of burghs returned one member, Edinburgh returning two. Under art. 22 of the treaty of Union the number of members for royal burghs was fixed at fifteen, who were elected in Edinburgh by the magistrates and town council, and in the groups of burghs by delegates chosen *ad hoc*. (W. C. S.)

See C. Gross, *Bibliography of British Municipal History* (1897), which contains all needful references up to that date; F. W. Maitland, *Township and Borough* (1898); A. Ballard, *Domesday Boroughs* (1904); M. Bateson, *Borough Customs* (1904-1906); S. and B. Webb, *English Local Government* (3 vols., 1906-1908). For the character of the modern Scottish burgh see Mabel Atkinson, *Local Government in Scotland* (Edinburgh, 1904), where other works are mentioned.

BOROUGHBRIDGE, a market town in the Ripon parliamentary division of the West Riding of Yorkshire, England; 22 m. N.W. of York on a branch of the North Eastern railway. Pop. (1901) 830. It lies in the central plain of Yorkshire, on the river Ure near its confluence with the Swale. It is in the parish of Aldborough, the village of that name (*q.v.*), celebrated for its Roman remains, lying a mile south-east.

About half a mile to the west of Boroughbridge there are three upright stones called the Devil's Arrows, which are of uncertain origin but probably of the Celtic period. The manor of Boroughbridge, then called *Burc*, was held by Edward the Confessor and passed to William the Conqueror, but suffered so much from the ravages of his soldiers that by 1086 it had decreased in value from £10 to 55s. When the site of the Great North Road was altered, towards the end of the 11th century, a bridge was built across the Ure, about half a mile above the Roman bridge at Aldborough, and called *Burgh bridge* or *Ponteburghem*. This caused a village to spring up, and it afterwards increased so much as to become a market town. In 1229 Boroughbridge, as part of the manor of Aldborough, was granted to Hubert de Burgh, but was forfeited a few years later by his son who fought against the king at Evesham. It then remained a royal manor until Charles I. granted it to several citizens of London, from whom it passed through numerous hands to the present owner. The history of Boroughbridge during the early 14th century centres round the war with Scotland, and culminates with the battle fought there in 1321. When in 1317 the Scots invaded England, they penetrated as far south as Boroughbridge and burnt the town. Boroughbridge was evidently a borough by prescription, and as such was called upon to return two members to parliament in 1299. It was not represented again until 1553, when the privilege was revived. The town was finally disfranchised in 1832. In 1504 the bailiff and inhabitants of Boroughbridge received a grant of two fairs, and Charles II. in 1670 created three new fairs in the borough, on the 12th of June, the 5th of August, and the 12th of October, and leased them to Francis Calvert and Thomas Wilkinson for ninety-nine years.

BOROUGH ENGLISH, a custom prevailing in certain ancient English boroughs, and in districts attached to them (where the lands are held in socage), and also in certain copyhold manors (chiefly in Surrey, Middlesex, Suffolk and Sussex), by which in general lands descend to the youngest son, to the exclusion of all

the other children, of the person dying seised and intestate. Descent to the youngest brother to the exclusion of all other collaterals, where there is no issue, is sometimes included in the general definition, but this is really a special custom to be proved from the court-rolls of the manor and from local reputation—a custom which is sometimes extended to the youngest sister, uncle, aunt. Generally, however, Borough English, apart from specialities, may be said to differ from gavelkind in not including collaterals. It is often found in connexion with the distinct custom that the widow shall take as dower the whole and not merely one-third of her husband's lands.

The origin of the custom of Borough English has been much disputed. Though frequently claimed to be of Saxon origin, there is no direct evidence of such being the case. The first mention of the custom in England occurs in Glanvil, without, however, any explanation as to its origin. Littleton's explanation, which is the more usually accepted, is that custom casts the inheritance upon the youngest, because after the death of his parents he is least able to support himself, and more likely to be left destitute of any other support. Blackstone derived Borough English from the usages of pastoral life, the elder sons migrating and the youngest remaining to look after the household. C. I. Elton claims it to be a survival of pre-Aryan times. It was referred to by the Normans as "the custom of the English towns." In the Yearbook of 22 Edward IV. fol. 32b it is described as the custom of Nottingham, which is made clear by the report of a trial in the first year of Edward III. where it was found that in Nottingham there were two districts, the one the *Burgh-Françoyses*, the other the *Burgh-Engloyses*, where descent was to the youngest son, from which circumstance the custom has derived its name. On the European continent the custom of junior-rights is not unknown, more particularly in Germany, and it has by some been ascribed to the *jus primæ noctis* (q.v.). It is also said to exist amongst the Mongols.

See also GAVELKIND; INHERITANCE; PRIMOGENITURE; TENURE; Blackstone's *Commentaries*; Coke's *Institutes*; Comyn's *Digest of the Law*; Elton's *Origin of English History*; Pollock and Maitland, *History of English Law*.

BORROMEAN ISLANDS, a group of four islands on the W. side of Lago Maggiore off Baveno and Stresa. The southernmost, the Isola Bella, is famous for its chateau and terraced gardens, constructed by Count Vitaliano Borromeo (d. 1690). To the N.W. is the Isola dei Pescatori, containing a fishing village; and to the N.E. of this the Isola Madre, the largest of the group, with a chateau and garden; and to the N. again, off Pallanza, is the little Isola S. Giovanni.

BORROMEO, CARLO (1538–1584), saint and cardinal of the Roman Catholic Church, son of Ghiberto Borromeo, count of Arona, and Margarita de' Medici, was born at the castle of Arona on Lago Maggiore on the 2nd of October 1538. When he was about twelve years old, Giulio Cesare Borromeo resigned to him an abbacy, the revenue of which he applied wholly in charity to the poor. He studied the civil and canon law at Pavia. In 1554 his father died, and, although he had an elder brother, Count Federigo, he was requested by the family to take the management of their domestic affairs. After a time, however, he resumed his studies, and in 1559 he took his doctor's degree. In 1560 his uncle, Cardinal Angelo de' Medici, was raised to the pontificate as Pius IV. Borromeo was made primate, entrusted with both the public and the privy seal of the ecclesiastical state, and created cardinal with the administration of Romagna and the March of Ancona, and the supervision of the Franciscans, the Carmelites and the knights of Malta. He was thus at the age of twenty-two practically the leading statesman of the papal court. Soon after he was raised to the archbishopric of Milan. In compliance with the pope's desire, he lived in great splendour; yet his own temperance and humility were never brought into question. He established an academy of learned persons, and published their memoirs as the *Noctes Vaticanæ*. About the same time he also founded and endowed a college at Pavia, which he dedicated to Justina, virgin and martyr. On the death of his elder brother Federigo, he was advised to quit

the church and marry, that his family might not become extinct. He declined the proposal, however, and became henceforward still more fervent in exercises of piety, and more zealous for the welfare of the church. Owing to his influence over Pius IV., he was able to facilitate the final deliberations of the council of Trent, and he took a large share in the drawing up of the Tridentine catechism (*Catechismus Romanus*).

On the death of Pius IV. (1566), the skill and diligence of Borromeo contributed materially to suppressing the cabals of the conclave. Subsequently he devoted himself wholly to the reformation of his diocese, which had fallen into a most unsatisfactory condition owing to the prolonged absences of its previous archbishops. He made a series of pastoral visits, and restored decency and dignity to divine service. In conformity with the decrees of the council of Trent, he cleared the cathedral of its gorgeous tombs, rich ornaments, banners, arms, sparing not even the monuments of his own relatives. He divided the nave of the church into two compartments for the separation of the sexes. He extended his reforms to the collegiate churches (even to the fraternities of penitents and particularly that of St John the Baptist), and to the monasteries. The great abuses which had overrun the church at this time arose principally from the ignorance of the clergy. Borromeo, therefore, established seminaries, colleges and communities for the education of candidates for holy orders. The most remarkable, perhaps, of his foundations was the fraternity of the Oblates, a society whose members were pledged to give aid to the church when and where it might be required. He further paved the way for the "Golden" or "Borromeo" league formed in 1586 by the Swiss Catholic cantons of Switzerland to expel heretics if necessary by armed force.

In 1576, when Milan was visited by the plague, he went about giving directions for accommodating the sick and burying the dead, avoiding no danger and sparing no expense. He visited all the neighbouring parishes where the contagion raged, distributing money, providing accommodation for the sick, and punishing those, especially the clergy, who were remiss in discharging their duties. He met with much opposition to his reforms. The governor of the province, and many of the senators, apprehensive that the cardinal's ordinances and proceedings would encroach upon the civil jurisdiction, addressed remonstrances and complaints to the courts of Rome and Madrid. But Borromeo had more formidable difficulties to struggle with, in the inveterate opposition of several religious orders, particularly that of the Humiliati (Brothers of Humility). Some members of that society formed a conspiracy against his life, and a shot was fired at him in the archiepiscopal chapel under circumstances which led to the belief that his escape was miraculous. The number of his enemies was increased by his successful attack on his Jesuit confessor Ribera, who with other members of the college of Milan was found to be guilty of unnatural offences. His manifold labours and austerities appear to have shortened his life. He was seized upon an intermittent fever, and died at Milan on the 4th of November 1584. He was canonized in 1610, and his feast is celebrated on the 4th of November.

Besides the *Noctes Vaticanæ*, to which he appears to have contributed, the only literary relics of this intrepid and zealous reformer are some homilies, discourses and sermons, with a collection of letters. His sermons, which have little literary merit, were published by J. A. Sax (5 vols., Milan, 1747–1748), and have been translated into many languages. The record of his episcopate is to be found in the two volumes of the *Acta Ecclesiae Mediolanensis* (Milan, 1599). Contrary to his last wishes a memorial was erected to him in Milan cathedral, as well as a statue 70 ft. high on the hill above Arona, by his admirers who regarded him as the leader of a Counter-Reformation.

His nephew, Federigo Borromeo (1564–1631), was archbishop of Milan from 1595, and in 1609 founded the Ambrosian library in that city.

See G. P. Giussano, *Vita di S. Carlo Borromeo* (1610, Eng. ed. by H. E. Manning, London, 1884); A. Sala, *Documenti circa la vita e la gesta di Borromeo* (4 vols., Milan, 1857–1859); Chanoine Silvain,

Histoire de St Charles Borromée (Milan, 1884); and A. Cantono, *Un grande riformatore del secolo XVI* (Florence, 1904); article "Borromäus" in Herzog-Hauck, *Realencyclopädie* (Leipzig, 1897).

BORROMINI, FRANCESCO (1599-1667), Italian architect, was born at Bissone in 1599. He was the chief representative of the style known in architecture as "baroque," which marked a fearless and often reckless departure from the traditional laws of the Renaissance, and often obtained originality only at the cost of beauty or wisdom. One of the main opponents of this style was Barocchio (*q.v.*). Borromini was much employed in the middle of the 17th century at Rome. His principal works are the church of St Agnese in Piazza Navona, the church of La Sapienza in Rome, the church of San Carlino alle Fontane, the church of the Collegio di Propaganda, and the restoration of San Giovanni in Laterano. He died by his own hand at Rome in 1667. Engravings of his chief compositions are to be found in the posthumous work, *Francisci Borrominiopus Architectonicum* (1727).

BORROW, GEORGE HENRY (1803-1881), English traveller, linguist and author, was born at East Dereham, Norfolk, on the 5th of July 1803, of a middle-class Cornish family. His father was a recruiting officer, and his mother a Norfolk lady of French extraction. From 1816 to 1818 Borrow attended, with no very great profit, the grammar school at Norwich. After leaving school he was articled to a firm of Norwich solicitors, where he neglected the law, but gave a great deal of desultory attention to languages. He was encouraged in these studies by William Taylor, the friend of Southey. On the death of his father in 1824 he went to London to seek his fortune as a literary adventurer. In 1826 he published a volume of *Romantic Ballads* translated from the Danish. Engaged by Sir Richard Phillips, the publisher, as a hack-writer at starvation wages, his experiences in London were bitter indeed. His struggles at last became so dire that if he would escape Chatterton's doom, he must leave London and either return to Norwich and share his mother's narrow income, or turn to account in some way the magnificent physical strength with which nature had endowed him. Determining on the latter of these courses, he left London on a tramp. As he stood considerably more than 6 ft. in height, was a fairly trained athlete, and had a countenance of extraordinary impressiveness, if not of commanding beauty—Greek in type with a dash of the Hebrew—we may assume that there had never before appeared on the English high-roads so majestic-looking a tramp as he who, on an afternoon in May, left his squalid lodging with bundle and stick to begin life on the roads. Shaping his course to the south-west, he soon found himself on Salisbury Plain. And then his extraordinary adventures began. After a while he became a travelling hedge-smith, and it was while pursuing this avocation that he made the acquaintance of the splendid road-girl, born at Long Melford workhouse, whom he has immortalized under the name of Isopel Berners. He was now brought much into contact with the gypsies, and this fact gave him the most important subject-matter for his writings. For picturesque as is Borrow's style, it is this subject-matter of his, the Romany world of Great Britain, which—if his pictures of that world are true—will keep his writings alive. Now that the better class of gypsies are migrating so rapidly to America that scarcely any are left in England, Borrow's pictures of them are challenged as being too idealistic. It is unfortunate that no one who knew Borrow, and the greengrocers or horse-dealers with whom he associated, and whom he depicted, has ever written about him and them. Full of "documents" as is Dr Knapp's painstaking biography, it cannot be said to give a vital picture of Borrow and his surroundings during this most interesting period of his life. It is this same peculiar class of gypsies (the greengrocers) with whom the present writer was brought into contact, and he can only refer, in justification of Borrow's descriptions of them, to certain publications of his own, where the whole question is discussed at length, and where he has set out to prove that Borrow's pictures of the section of the English gypsies he knew are not idealized. But there is one great demerit in *all* Borrow's dramatic scenes of gipsy life, wheresoever

they may be laid. This was pointed out by the gentleman who "read" *Zincali* for Mr Murray, the publisher.—

"The dialogues are amongst the best parts of the book; but in several of them the tone of the speakers, of those especially who are in humble life, is too correct and elevated, and therefore out of character. This takes away from their effect. I think it would be very advisable that Mr Borrow should go over them with reference to this point, simplifying a few of the terms of expression and introducing a few contractions—*don'ts, can'ts, &c.* This would improve them greatly."

It is the same with his pictures of the English gypsies. The reader has only to compare the dialogues between the gentlemen given in that photographic study of Romany life, *In Gipsy Tents*, by F. H. Groome, with the dialogues in *Lavengro* and *The Romany Rye*, to see how the illusion in Borrow's narrative is disturbed by the uncolloquial locutions of the speakers. It is true, no doubt, that all Romanies, especially perhaps the English and Hungarian, have a passion for the use of high-sounding words, and the present writer has shown this in his remarks upon the Czigany Czindol, who is said to have taught the Czigany language to the archduke Joseph, often called the "Gipsy Archduke." But after all allowance is made for this racial peculiarity, Borrow's presentation of it considerably weakens our belief in Mr and Mrs Petulengro, Ursula, and the rest, to find them using complex sentences and bookish words which, even among English people, are rarely heard in conversation. As to the deep impression that Borrow made upon his gipsy friends, that is partly explained by the singular nobility of his appearance, for the gypsies of all countries are extremely sensitive upon matters of this kind. The silvery whiteness of the thick crop of hair which Borrow retained to the last seemed to add in a remarkable way to the nobility of his hairless face, but also it gave to the face a kind of strange look "not a bit like a Gorgio's," to use the words of one of his gipsy friends. Moreover, the shy, defiant, stand-off way which Borrow assumed in the company of his social equals left him entirely when he was with the gypsies. The result of this was that these wanderers knew him better than did his own countrymen.

Seven years after the events recorded in *Lavengro* and *The Romany Rye* Borrow obtained the post of agent to the Bible Society, in which capacity he visited St Petersburg (1833-1835) (where he published *Targum*, a collection of translations), and Spain, Portugal and Morocco (1835-1839). From 1837 to 1839 he acted as correspondent to the *Morning Herald*. The result of these travels and adventures was the publication, in 1841, of *Zincali, or The Gypsies in Spain*, the original MS. of which, in the hands of the present writer, shows how careful was Borrow's method of work. In 1843 appeared *The Bible in Spain*, when suddenly Borrow became famous. Every page of the book glows with freshness, picturesqueness and vivacity. In 1840 he married Mary Clarke, the widow of a naval officer, and permanently settled at Oulton Broad, near Lowestoft, with her and her daughter. Here he began to write again. Very likely Borrow would never have told the world about his vagabond life in England as a hedge-smith had not *The Bible in Spain* made him famous as a wanderer. *Lavengro* appeared in 1851 with a success which, compared with that of *The Bible in Spain*, was only partial. He was much chagrined at this, and although *Lavengro* broke off in the midst of a scene in the Dingle, and only broke off there because the three volumes would hold no more, it was not until 1857 that he published the sequel, *The Romany Rye*. In 1844 he travelled in south-eastern Europe, and in 1854 he made a tour with his step-daughter in Wales. This tour he described in *Wild Wales*, published in 1862. In 1874 he brought out a volume of ill-digested material upon the Romany tongue, *Romano Lavo-til, or Word-book of the Gypsy Language*, a book which has been exhaustively analysed and criticized by Mr John Sampson. In the summer of 1874 he left London, bade adieu to Mr Murray and a few friends, and returned to Oulton. On the 26th of July 1881 he was found dead in his house at Oulton, in his seventy-ninth year.

Borrow was indisputably a linguist of wide knowledge, though he was not a scholar in the strict sense. The variety of his

attainments is shown by his translation of the Church of England *Homilies* into Manchu, of the Gospel of St Luke into the Git dialect of the Gitanos, of *The Sleeping Bard* from the Cambrian-British, and of *Bluebeard* into Turkish. But it is not Borrow's linguistic accomplishments that have kept his name fresh, and will continue to keep it fresh for many a generation to come. It is his character, his unique character as expressed, or partially expressed, in his books. Among all the "remarkable individuals" (to use his favourite expression) who during the middle of the 19th century figured in the world of letters, Borrow was surely the most eccentric, the most whimsical, and in many ways the most extraordinary. There was scarcely a point in which he resembled any other writer of his time. With regard to *Lavengro* and *The Romany Rye*, there has been very much discussion as to how much *Dichtung* is mingled with the *Wahrheit* in those fascinating books. Had it not been for the amazingly clumsy pieces of fiction which he threw into the narrative, few readers would have doubted the autobiographical nature of the two books. Such incidents as are here alluded to shed an air of unreality over the whole. It has been said by Dr Knapp that Borrow never created a character, and that to one who thoroughly knows the times and Borrow's writings the originals are easily recognizable. This is true, no doubt, as regards people whom he knew at Norwich, and indeed generally as regards those he knew before the period of his gipsy wanderings. It must not be supposed, however, that such a character as the man who "touched" to avert the evil chance is in any sense a portrait of an individual with whom he had been brought into contact. The character has so many of Borrow's own eccentricities that it might rather be called a portrait of himself. There was nothing that Borrow strove against with more energy than the curious impulse, which he seems to have shared with Dr Johnson, to touch the objects along his path in order to save himself from the evil chance. He never conquered the superstition. In walking through Richmond Park with the present writer he would step out of his way constantly to touch a tree, and he was offended if the friend he was with seemed to observe it. Many of the peculiarities of the man who taught himself Chinese in order to distract his mind from painful thoughts were also Borrow's own. (T. W.-D.)

BORSIPPA (*Borsip* in the Babylonian and Assyrian inscriptions; *Borsif* in the Talmud; mod. Birs or Birs-Nimrud), the Greek name of an ancient city about 15 m. S.W. of Babylon and 10 m. from Hillah, on the Nahr Hindieh, or Hindieh canal, formerly known as "the Euphrates of Borsippa," and even during the Arabic period called "the river of Birs." Borsippa was the sister city of Babylon, and is often called in the inscriptions Babylon II., also the "city without equal." Its patron god was Nebo or Nabu. Like Babylon Borsippa is not mentioned in the oldest inscriptions, but comes into importance first after Khammurabi had made Babylon the capital of the whole land, somewhere before 2000 B.C. He built or rebuilt the temple E-Zida at this place, dedicating it, however, to Marduk (Bel-Merodach). But although Khammurabi himself does not seem to have honoured Nebo (*q.v.*), subsequent kings recognized him as the deity of E-Zida and made him the son of Marduk (*q.v.*). Each new year his image was taken to visit his father, in Babylon, who in his turn gave him escort homeward, and his temple was second in wealth and importance only to E-Saggila, the temple of Marduk in Babylon. As with Babylon, so with Borsippa, the time of Nebuchadrezzar was the period of its greatest prosperity. In general Borsippa shared the fate of Babylon, falling into decay after the time of Alexander, and finally in the middle ages into ruins. The site of the ancient city is represented by two large ruin mounds. Of these the north-westerly, the lower of the two, but the larger in superficial area, is called Ibrahim Khallil, from a *ziara*, or shrine, of Abraham, the friend of God, which stands on its highest point. According to Arabic lore, based on Jewish legends, at this spot Nimrod sought to throw Abraham into a fiery furnace, from which he was saved by the grace of God. Excavations were first conducted here by the French Expédition Scientifique en Mésopotamie in 1852, with small result. In 1879 and 1880 Hormuzd Rassam conducted more extensive, although

unsystematic, excavations in this mound, finding a considerable quantity of inscribed tablets and the like, now in the British Museum; but by far the greater part of this ruin still remains unexplored. The south-westerly mound, the Birs proper, is probably the most conspicuous and striking ruin in all Irak. On the top of a hill over 100 ft. high rises a pointed mass of vitrified brick split down the centre, over 40 ft. high, about which lie huge masses of vitrified brick, some as much as 15 ft. in diameter, and also single enamelled bricks, generally bearing an inscription of Nebuchadrezzar, twisted, curled and broken, apparently by great heat. Jewish and Arabic tradition makes this the Tower of Babel, which was supposed to have been destroyed by lightning. Excavations conducted here by Sir Henry Rawlinson in 1854 showed it to be the stage tower or *ziggurat*, called the "house of the seven divisions of heaven and earth," of E-Zida, the temple of Nebo. On a large platform rose seven solid terraces, each smaller than the one below it, the lowest being 272 ft. square and 26 ft. high. Each of these terraces was faced with bricks of a different colour. The approach to this *ziggurat* was toward the north-east, and on this side lay also the principal rooms of the temple of which this was the tower. These rooms were partly excavated by Hormuzd Rassam in 1879-1880. In its final form this temple and tower were the work of Nebuchadrezzar, but from the clay cylinders found by Sir Henry Rawlinson in two of the corners of the tower it appears that he restored an incomplete *ziggurat* of a former king, "which was long since fallen into decay." Some of the best authorities believe that it was this ambitious but incomplete and ruinous *ziggurat*, existing before the time of Nebuchadrezzar, which gave occasion to or afforded local attachment for the Biblical story of the Tower of Babel.

AUTHORITIES.—H. C. Rawlinson, *Journal of the Royal Asiatic Society* (1860); J. Oppert, *Expédition scientifique en Mésopotamie* (Paris, 1863); F. Delitzsch, *Wo lag das Paradies?* (Leipzig, 1881); J. P. Peters, *Nippur* (New York and London, 1896); H. Rassam, *Asshur and the Land of Nimrod* (London and New York, 1897); M. Jastrow, *Religion of Babylonia and Assyria* (Boston, 1898); see also **BABYLON, BABEL.** (J. P. Pe.)

BORT, or **BOART**, an inferior kind of diamond, unfit for cutting but useful as an abrasive agent. The typical bort occurs in small spherical masses, of greyish colour, rough or drusy on the surface, and showing on fracture a radiate crystalline structure. These masses, known in Brazil as *bolas*, are often called "shot bort" or "round bort." Much of the bort consists of irregular aggregates of imperfect crystals. In trade, the term bort is extended to all small and impure diamonds, and crystalline fragments of diamond, useless as gem-stones. A large proportion of the output of some of the South African mines consists of such material. This bort is crushed in steel mortars to form diamond powder, which is largely used in lapidaries' work.

BORY DE SAINT-VINCENT, JEAN BAPTISTE GEORGE MARIE (1780-1846), French naturalist, was born at Agen in 1780. He was sent as naturalist with Captain Nicholas Baudin's expedition to Australia in 1798, but left the vessel at Mauritius, and spent two years in exploring Réunion and other islands. Joining the army on his return, he was present at the battles of Ulm and Austerlitz, and in 1808 went to Spain with Marshal Soult. His attachment to the Napoleonic dynasty and dislike to the Bourbons were shown in various ways during 1815, and his name was consequently placed on the list of the proscribed; but after wandering in disguise from place to place he was allowed quietly to return to Paris in 1820. In 1829 he was placed at the head of a scientific expedition to the Morea, and in 1839 he had charge of the exploration of Algeria. He died on the 23rd of December 1846. He was editor of the *Dictionnaire classique d'histoire naturelle*, and among his separate productions were:—*Essais sur les Iles Fortunées* (1802); *Voyage dans les Iles d'Afrique* (1803); *Voyage souterrain, ou description du plateau de Saint-Pierre de Mœsrichi et de ses vastes cryptes* (1821); *L'Homme, essai zoologique sur le genre humain* (1827); *Résumé de la géographie de la Péninsule* (1838).

BORZHOM, a watering-place of Russian Transcaucasia, in the government of Tiflis, and 93 m. by rail W. of the city of

Tiffa. Pop. (1897) 5800. It is situated at an altitude of 2750 ft. in the Borzhom gorge, a narrow rift in the Little Caucasus mountains, and on the Kura. Its warm climate, its two hot springs (73°–82° Fahr.) and its beautiful parks make it a favourite summer resort, and give it its popular name of "the pearl of Caucasus." The bottled mineral waters are very extensively exported.

BOS, LAMBERT (1670–1717), Dutch scholar and critic, was born at Workum in Friesland, where his father was headmaster of the school. He went to the university of Franeker (suppressed by Napoleon in 1811), and was appointed professor of Greek there in 1704; after an uneventful life he died at Franeker in 1717. His most famous work, *Ellipses Graecae* (1702), was translated into English by John Seager (1830); and his *Antiquitates Graecae* (1714) passed through several editions. He also published *Vetus Testamentum, Ex Versione Iuxta Interpretum* (1709); notes on Thomas Magister (1698); *Exercitationes Philologicae* (1700); *Animadversiones ad Scriptores quosdam Graecos* (1715); and two small treatises on Accents and Greek Syntax.

BOSA, a seaport and episcopal see on the W. coast of Sardinia, in the province of Cagliari, 30 m. W. of Macomer by rail. Pop. (1901) 6846. The height above the town is crowned by a castle of the Malaspina family. The cathedral, founded in the 12th century, restored in the 15th, and rebuilt in 1806, is fine. There are some tanneries, and the fishing industry is important, but the coral production of Sicily has entirely destroyed that of Bosa since 1857. The district produces oil and wine. The present town of Bosa was founded in 1112 by the Malaspina, 13 m. from the site of the ancient town (Bosa or Calmedia), where a well-preserved church still exists. The old town is of Roman origin, but is only mentioned by Pliny and Ptolemy, and as a station on the coast-road in the Itineraries (*Corp. Inscr. Lat.* x. 7939 seq.). One of the inscriptions preserved in the old cathedral records the erection of four silver statues, of Antoninus Pius, his wife Faustina and their two sons.

BOSBOOM-TOUSSAINT, ANNA LOUISA GEERTRUIDA (1812–1886), Dutch novelist, was born at Alkmaar in north Holland on the 16th of September 1812. Her father, named Toussaint, a local chemist of Huguenot descent, gave her a fair education, and at an early period of her career she developed a taste for historical research, fostered, perhaps, by a forced indoor life, the result of weak health. In 1851 she married the Dutch painter, Johannes Bosboom (1817–1891), and thereafter was known as Mrs Bosboom-Toussaint. Her first romance, *Almogro*, appeared in 1837, followed by the *Graaf van Devonshire* (*The Earl of Devonshire*) in 1838; the *Engelschen te Rome* (*The English at Rome*) in 1840, and *Het Huis Lauernesse* (*The House of Lauernesse*) in 1841, an episode of the Reformation, translated into many European languages. These stories, mainly founded upon some of the most interesting epochs of Dutch history, betrayed a remarkable grasp of facts and situations, combined with an undoubted mastery over her mother tongue, though her style is sometimes involved, and not always faultless. Ten years (1840–1850) were mainly devoted to further studies, the result of which was revealed in 1851–1854, when her *Leycester in Nederland* (3 vols.), *Vrouwen van het Leycesterse Tydperk* (*Women of Leicester's Epoch*, 3 vols.), and *Gideon Florens* (3 vols.) appeared, a series dealing with Robert Dudley's adventures in the Low Countries. After 1870 Mrs Bosboom-Toussaint abandoned historical romance for the modern society novel, but her *Delftsche Wonderdokter* (*The Necromancer of Delft*, 1871, 3 vols.) and *Majoor Frans* (1875, 3 vols.) did not command the success of her earlier works. *Majoor Frank* has been translated into English (1885). She died at the Hague on the 13th of April 1886. Her novels have been published there in a collected edition (1885–1888, 25 vols.).

BOSC, LOUIS AUGUSTIN GUILLAUME (1759–1828), French naturalist, was born at Paris on the 29th of January 1759. He was educated at the college of Dijon, where he showed a taste for botany, and he followed up his studies in Paris at the Jardin des Plantes, where he made the acquaintance of Mme M. J. P.

Roland. At the age of eighteen he obtained a government appointment, and he rose to be one of the chief officials in the postal department. Under the ministry of J. M. Roland in 1792 he also held the post of superintendent of prisons, but the violent outbreaks of 1793 drove him from office, and compelled him to take refuge in flight. For some months he lay concealed at Sainte-Radégonde, in the forest of Montmorency, barely subsisting on roots and vegetables. He was enabled to return to Paris on the fall of Robespierre, and under the title *Appel à l'impartiale postérité par la citoyenne Roland* published a manuscript Mme Roland had entrusted to him before her execution. Soon afterwards he set out for America, resolving to explore the natural riches of that country. The immense materials he gathered were never published in a complete form, but much went to enrich the works of B. G. E. de Lacépède, P. A. Latreille and others. After his return, on the establishment of the Directory, he was reinstated in his old office. Of this he was again deprived by the *coup d'état* of 1799, and for a time he was in great destitution; but by his copious contributions to scientific literature he contrived to support himself and to lay the foundations of a solid reputation. He was engaged on the new *Dictionnaire d'histoire naturelle*, and on the *Encyclopédie méthodique*, he edited the *Dictionnaire raisonné et universel d'agriculture*, and was one of the editors of the *Annales de l'agriculture française*. He was made inspector of the gardens at Versailles, and of the public nurseries belonging to the ministry of the interior. The last years of his life were devoted to an elaborate work on the vine, for which he had amassed an immense quantity of materials, but his death at Paris on the 10th of July 1828 prevented its completion.

BOSCÁN ALMOGAVER, JUAN (1490?–1542), Spanish poet, was born about the close of the 15th century. He was a Catalan of patrician birth, and, after some years of military service, became tutor to the duke of Alva. His poems were published in 1543 at Barcelona by his widow. They are divided into sections which mark the stages of Boscán's poetical evolution. The first book contains poems in the old Castilian metres, written in his youth, before 1526, in which year he became acquainted with the Venetian ambassador, Andrea Navagiero, who urged him to adopt Italian measures, and this advice gave a new turn to Boscán's activity. The remaining books contain a number of pieces in the Italian manner, the longest of these being *Hero y Leander*, a poem in blank verse, based on Musaeus. Boscán's best effort, the *Octava Rima*, is a skilful imitation of Petrarch and Bembo. Boscán also published in 1534 an admirable translation of Castiglione's *Il Cortegiano*. Italian measures had been introduced into Spanish literature by Santillana and Villalpando; it is Boscán's distinction to have naturalized these forms definitively, and to have founded a poetic school.

The best edition of his poems is that issued at Madrid in 1875 by W. J. Knapp; for his indebtedness to earlier writers, see Francesco Flamini, *Studi di storia letteraria italiana e straniera* (Livorno, 1895).

BOSCASTLE, a small seaport and watering-place in the Lauceston parliamentary division of Cornwall, England, 5 m. N. of Camelford station on the London & South-Western railway. Pop. (civil parish of Forrabury, 1901) 329. The village rises steeply above a very narrow cove on the north coast, sheltered, but difficult of access, vessels having to be warped into it by means of hawsers. A mound on a hill above the harbour marks the site of a Norman castle. The parish church of St Symphorian, Forrabury, also stands high, overlooking the Atlantic from Willapark Point. The tower is without bells, and the tradition that a ship bearing a peal hither was wrecked within sight of the harbour, and that the lost bells may still be heard to toll beneath the waves, has been made famous by a ballad of the Cornish poet Robert Stephen Hawker, vicar of Moorwinstow. The coast scenery near Boscastle is severely beautiful, with abrupt cliffs fully exposed to the sea, and broken only by a few picturesque inlets such as Crackington Cove and Pentargan Cove. Inland are bare moors, diversified by narrow dales.

BOSCAWEN, EDWARD (1711–1761), British admiral, was born on the 19th of August 1711. He was the third son of Hugh,

1st Viscount Falmouth. He early entered the navy, and in 1739 distinguished himself at the taking of Porto Bello. At the siege of Cartagena, in March 1741, at the head of a party of seamen, he took a battery of fifteen 24-pounders, while exposed to the fire of another fort. On his return to England in the following year he married, and entered parliament as member for Truro. In 1744 he captured the French frigate "Médée," commanded by M. de Hocquart, the first ship taken in the war. In May 1747 he signaled himself in the engagement off Cape Finisterre, and was wounded in the shoulder with a musket-ball. Hocquart again became his prisoner, and the French ships, ten in number, were taken. On the 15th of July he was made rear-admiral and commander-in-chief of the expedition to the East Indies. On the 29th of July 1748 he arrived off Fort St David's, and soon after laid siege to Pondicherry; but the sickness of his men and the approach of the monsoons led to the raising of the siege. Soon afterwards he received news of the peace, and Madras was delivered up to him by the French. In April 1750 he arrived in England, and was the next year made one of the lords of the Admiralty, and chosen an elder brother of the Trinity House. In February 1755 he was appointed vice-admiral, and in April he intercepted the French squadron bound to North America, and took the "Alcide" and "Lys" of sixty-four guns each. Hocquart became his prisoner for the third time, and Boscawen returned to Spithead with his prizes and 1500 prisoners. For this exploit, he received the thanks of parliament. In 1758 he was appointed admiral of the blue and commander-in-chief of the expedition to Cape Breton, when, in conjunction with General Amherst, he took the fortress of Louisburg, and the island of Cape Breton—services for which he again received the thanks of the House of Commons. In 1759, being appointed to command in the Mediterranean, he pursued the French fleet, commanded by M. de la Clue, and after a sharp engagement in Lagos Bay took three large ships and burnt two, returning to Spithead with his prizes and 2000 prisoners. The victory defeated the proposed concentration of the French fleet in Brest to cover an invasion of England. In December 1760 he was appointed general of the marines, with a salary of £3000 per annum, and was also sworn a member of the privy council. He died at his seat near Guildford on the 10th of January 1761.

BOSCH (or **Bos**), **JEROM** (c. 1460–1518), the name generally given, from his birthplace Hertogenbosch, to Hieronymus van Aeken, the Dutch painter. He was probably a pupil of Albert Ouwater, and may be called the Breughel of the 15th century, for he devoted himself to the invention of bizarre types, *diableries*, and scenes of the kind generally associated with Breughel, whose art is to a great extent based on Bosch's. He was a satirist much in advance of his time, and one of the most original and ingenious artists of the 15th century. He exercised great influence on Lucas Cranach, who frequently copied his paintings. His works were much admired in Spain, especially by Philip II., at whose court Bosch painted for some time. One of his chief works is the "Last Judgment" at the Berlin gallery, which also owns a little "St Jerome in the Desert." "The Fall of the Rebellious Angels" and the "St Anthony" triptych are in the Brussels museum, and two important triptychs are at the Munich gallery. The Lippmann collection in Berlin contains an important "Adoration of the Magi," the Antwerp museum a "Passion," and a practically unknown painting from his brush is at the Naples museum.

BOSCOVICH, **ROGER JOSEPH** (1717–1787), Italian mathematician and natural philosopher, one of the earliest of foreign savants to adopt Newton's gravitation theory, was born at Ragusa in Dalmatia on the 18th of May 1717, according to the usual account, but ten years earlier according to Lalande (*Éloge*, 1792). In his fifteenth year, after passing through the usual elementary studies, he entered the Society of Jesus. On completing his novitiate, which was spent at Rome, he studied mathematics and physics at the Collegium Romanum; and so brilliant was his progress in these sciences that in 1740 he was appointed professor of mathematics in the college. For this post he was especially fitted by his acquaintance with recent

advances in science, and by his skill in a classical severity of demonstration, acquired by a thorough study of the works of the Greek geometers. Several years before this appointment he had made himself a name by an elegant solution of the problem to find the sun's equator and determine the period of its rotation by observation of the spots on its surface. Notwithstanding the arduous duties of his professorship he found time for investigation in all the fields of physical science; and he published a very large number of dissertations, some of them of considerable length, on a wide variety of subjects. Among these subjects were the transit of Mercury, the Aurora Borealis, the figure of the earth, the observation of the fixed stars, the inequalities in terrestrial gravitation, the application of mathematics to the theory of the telescope, the limits of certainty in astronomical observations, the solid of greatest attraction, the cycloid, the logistic curve, the theory of comets, the tides, the law of continuity, the double refraction micrometer, various problems of spherical trigonometry, &c. In 1742 he was consulted, with other men of science, by the pope, Benedict XIV., as to the best means of securing the stability of the dome of St Peter's, Rome, in which a crack had been discovered. His suggestion was adopted. Shortly after he engaged to take part in the Portuguese expedition for the survey of Brazil, and the measurement of a degree of the meridian; but he yielded to the urgent request of the pope that he would remain in Italy and undertake a similar task there. Accordingly, in conjunction with Christopher Maire, an English Jesuit, he measured an arc of two degrees between Rome and Rimini. The operations were begun towards the close of 1750, and were completed in about two years. An account of them was published in 1755, entitled *De Litteraria expeditione per pontificam diuionem ad dimittendos duos meridiansi gradus a P.P. Maire et Boscovich*. The value of this work was increased by a carefully prepared map of the States of the Church. A French translation appeared in 1770. A dispute having arisen between the grand duke of Tuscany and the republic of Lucca with respect to the drainage of a lake, Boscovich was sent, in 1757, as agent of Lucca to Vienna, and succeeded in bringing about a satisfactory arrangement of the matter. In the following year he published at Vienna his famous work, *Theoria philosophice naturalis redacta ad unicam legem virium in natura existentium*, containing his atomic theory (see **MOLECULE**). Another occasion for the exercise of his diplomatic ability soon after presented itself. A suspicion having arisen on the part of the British government that ships of war had been fitted out in the port of Ragusa for the service of France, and that the neutrality of Ragusa had thus been violated, Boscovich was selected to undertake an embassy to London (1760), to vindicate the character of his native place and satisfy the government. This mission he discharged successfully, with credit to himself and satisfaction to his countrymen. During his stay in England he was elected a fellow of the Royal Society. He soon after paid this society the compliment of dedicating to it his Latin poem, entitled *De Solis et Lunae Defectibus* (London, 1764). This prolix composition, one of a class which at that time was much in vogue—metrical epitomes of the facts of science—contains in about five thousand lines, illustrated by voluminous notes, a compendium of astronomy. It was for the most part written on horseback, during the author's rides in the country while engaged in his meridian measurements. The book is characterized by G. B. J. Delambre as "uninstructive to an astronomer and unintelligible to any one else."

On leaving England Boscovich travelled in Turkey, but ill-health compelled him soon to return to Italy. In 1764 he was called to the chair of mathematics at the university of Pavia, and this post he held, together with the directorship of the observatory of Brera, for six years. He was invited by the Royal Society of London to undertake an expedition to California to observe the transit of Venus in 1769; but this was prevented by the recent decree of the Spanish government for the expulsion of the Jesuits from its dominions. The vanity, egotism and petulance of Boscovich provoked his rivals and made him many enemies, so that in hope of peace he was driven to frequent

change of residence. About 1770 he removed to Milan, where he continued to teach and to hold the directorship of the observatory of Brera; but being deprived of his post by the intrigues of his associates he was about to retire to his native place, when the news reached him (1773) of the suppression of his order in Italy. Uncertainty as to his future led him to accept an invitation from the king of France to Paris, where he was naturalized and was appointed director of optics for the marine, an office instituted for him, with a pension of 8000 livres. He remained there ten years, but his position became irksome, and at length intolerable. He continued, however, to devote himself diligently to the pursuits of science, and published many remarkable memoirs. Among them were an elegant solution of the problem to determine the orbit of a comet from three observations, and memoirs on the micrometer and achromatic telescopes. In 1783 he returned to Italy, and spent two years at Bassano, where he occupied himself with the publication of his *Opera postuma ad opticam et astronomiam, &c.*, which appeared in 1785 in five volumes quarto. After a visit of some months to the convent of Vallombrosa, he went to Milan and resumed his literary labours. But his health was failing, his reputation was on the wane, his works did not sell, and he gradually sank a prey to illness and disappointment. He fell into melancholy, imbecility, and at last madness, with lucid intervals, and died at Milan on the 15th (13th) of February 1787. In addition to the works already mentioned Boscovich published *Elementa universae mathematicae* (1754), the substance of the course of study prepared for his pupils; and a narrative of his travels, entitled *Giornale di un viaggio da Costantinopoli in Polonia*, of which several editions and a French translation appeared. His latest labour was the editing of the Latin poems of his friend Benedict Staj on the philosophy of Descartes, with scientific annotations and supplements. (W. L. R. C.)

BOSNIA AND HERZEGOVINA, or BOSNIA-HERZEGOVINA, two provinces formerly included in European Turkey, which now, together with Dalmatia, form the southernmost territories of the Austro-Hungarian Monarchy. The name *Herzegovina* is also written *Hertegovina*, *Hertsegovina* or, in Croatian, *Hercegovina*. In shape roughly resembling an equilateral triangle, with base uppermost, Bosnia and Herzegovina cover an area of 10,696 sq. m., in the north-west of the Balkan Peninsula. They are bounded N. and N.W. by Croatia-Slavonia; W. and S.W. by Dalmatia; S.E. by Montenegro and the Sanjak of Novibazar; and N.E. by Servia. Opposite to the promontory of Sabbioncello, and at the entrance to the Bocche di Cattaro, the frontier of Herzegovina comes down to the Adriatic; but these two strips of coast do not contain any good harbour, and extend only for a total distance of 14½ m. Bosnia is altogether an inland territory.

1. *Physical Features*.—Along the Dalmatian border, and through the centre of Bosnia, runs the backbone of the Dinaric Alps, which attain their greatest altitudes (6000–7500 ft.) near Travnik, Serajevo and Mostar. There are numerous high valleys shut in among the mountains of this range; the most noteworthy being the plain of Livno, which lies parallel to the Dalmatian border, at a height of 500 ft. above the sea. The zone of highlands throughout Bosnia and Herzegovina reaches a mean altitude of 1500 ft., while summits of more than 4000 ft. occur frequently. To the north-east of the Dinaric Alps extends a region of mountain, moor and forest, with deeply sunk alluvial basins, which finally expand into the lowlands of the Posavina, or Vale of the Save, forming the southernmost fringe of the Hungarian Alföld. Bosnia belongs wholly to the watershed of the Save, and its rivers to the Danubian system, no large stream finding a way to the Adriatic. The Save flows eastward along the northern frontier for 237 m. It is joined by four main tributaries, the Drina, Bosna, Vrbas and Una. The Drina is formed on the Montenegrin frontier by the united streams of the Tara and Fva; curving north-eastwards past Višegrad, it marches for 152 m. with Servian territory, and falls into the Save at Racha, after a total course of 155 m. The Bosna issues from many springs near Sarajevo, and winds for 107 m. northward, through a succession of fertile glens, reaching the Save 1 m. west of Samac.

Farther west, the Vrbas cuts a channel through the Dinaric Alps, and, after passing Jajce and Banjaluka, meets the Save 94 m. from its own headwaters. The Una rises on the Croatian border, and, after skirting the Plješevica Planina, in Croatia, turns sharply to the north-east; serving as a frontier stream for 37 m. before entering the Save at Jasenovac. Its length is 98 m. At Novi it is joined by the Sana, a considerable affluent.

Herzegovina, which lies south of Bosnia, in a parallelogram defined by Montenegro, Dalmatia, the Dinaric Alps, and an irregular line drawn from a point 25 m. west-north-west of Mostar to the bend of the river Narenta, differs in many respects from the larger territory. Its mountains, which belong to the Adriatic watershed, and form a continuation of the Montenegrin highlands, are less rounded and more dolomitic in character. They descend in parallel ridges of grey Karst limestone, south-westwards to the sea; their last summits reappear in the multitude of rocky islands along the Dalmatian littoral. As in the peaks of Orjen, Orobac, Samotica and Veliki Kap, their height often exceeds 6000 ft. West of the Narenta, their flanks are in places covered with forests of beech and pine, but north-east of that river they present for the most part a scene of barren desolation. Their monotony is varied only by the fruitful river-valleys and *poljes*, or upland hollows, where the smaller towns and villages are grouped; the districts or cantons thus formed are walled round by a natural rampart of limestone. These *poljes* may be described as oases in what is otherwise a desert expanse of mountains. The surface of some, as notably the *Mostarsko Blato*, lying west of Mostar, is marshy, and in spring forms a lake; others are watered by streams which disappear in swallow-holes of the rock, and make their way by underground channels either to the sea or the Narenta. The most conspicuous example of these is the Trebinjčica, which disappears in two swallow-holes in Popovopolye, and after making its way by a subterranean passage through a range of mountains, wells up in the mighty source of Ombla near Ragusa, and hurries in undiminished volume to the Adriatic. The Narenta, or Neretva, is the one large river of Herzegovina which flows above ground throughout its length. Rising on the Montenegrin border, under the Lebrsnik mountains, it flows north-westwards at the foot of the Dinaric Alps; and, near Konjica, sweeps round suddenly to the south, and falls into the Adriatic near Metković, after traversing 125 m. North of Mostar, it cleaves a passage through the celebrated Narenta defile, a narrow gorge, 12 m. long, overshadowed by mountains which rise on either side and culminate in Lupoglav (6796 ft.) on the east, and Cvrstnica (7205 ft.) on the west.

2. *Geology and Minerals*.—Geologically, the highlands of Bosnia and Herzegovina are to be regarded, in both their orographic and tectonic character, as a continuation of the South Alpine calcareous belt. Along the west frontier there appear broad and strongly marked zones of Cretaceous limestone, alternating with Jurassic and Triassic, joined by a strip of Palaeozoic formations running from the north-west corner of Bosnia. Next, proceeding from this region in an easterly direction, are the Neogene freshwater formations, filling up the greatest part of the north-east of Bosnia, as also a zone of flysch intermingled with several strips of eruptive rock. In the south-east of Bosnia the predominant formations are Triassic and Palaeozoic strata with red sandstone and quartzite. Along the whole northern rim of Bosnia, as also in the fluvial and Karst valleys (*poljes*), are found diluvial and alluvial formations, interrupted at one place by an isolated granite layer. Bosnia is rich in minerals, including coal, iron, copper, chrome, manganese, cinnabar, zinc and mercury, besides marble and much excellent building stone. Among the mountains, gold and silver were worked by the Romans, and, in the middle ages, by the Ragusans. After 1881 the Mining Company of Bosnia began to develop the coal and iron fields; and from 1886 its operations were continued by the government. Valuable salt is obtained from the pits at Dolnja Tuzla, and the southern part of Herzegovina yields asphalt and lignite. Mineral springs also abound, and those of Ilidže, near Sarajevo, have been utilized since the

days of the Romans; but the majority remained unexploited at the beginning of the 20th century.

3. *Climate*.—In climate Bosnia differs considerably from Herzegovina. In both alike the *scirocco*, bringing rain from the south-west, is a prevalent wind, as well as the *bora*, the fearful north-north-easter of Illyria, which, sweeping down the lateral valleys of the Dinaric Alps, overwhelms everything in its path. The snow-fall is slight, and, except on a few of the loftier peaks, the snow soon melts. In Bosnia the weather resembles that of the south Austrian highlands, generally mild, though apt to be bitterly cold in winter. In Serajevo the mean annual temperature is 50° Fahr. Herzegovina has more affinity to the Dalmatian mountains, oppressively hot in summer, when the mercury often rises beyond 110° Fahr. The winter rains of the Karst region show that it belongs to the sub-tropical climatic zone.

4. *Fauna*.—In 1893 the bones of a cave-bear (*Ursus spelaeus*) were taken from a cavern of the Bjelašnica range, in Herzegovina, a discovery without parallel in the Balkan Peninsula. Of existing species the bear, wild-boar, badger, roe-deer and chamois may occasionally be seen in the remotest wilds of mountain and forest. Hares are uncommon, and the last red-deer was shot in 1814; but wolves, otters and squirrels abound. Snipe, woodcock, ducks and rails, in vast flocks, haunt the banks of the Drina and Save; while the crane, pelican, wild-swan and wild-goose are fairly plentiful. The lammergeier (*Gypaetus barbatus*) had almost become extinct in 1900; but several varieties of eagle and falcon are left. Falconry was long a pastime of the Moslem landlords. The destruction of game, recklessly carried out under Turkish rule, is prevented by the laws of 1880, 1883, and 1893, which enforced a close time, and rendered shooting-licences necessary. The list of reptiles includes the venomous *Vipera ammodytes* and *Pelias berus*, while scorpions and lizards infest the stony wastes of the Karst. In the museum at Serajevo there is a large entomological collection, including the remarkable *Pogonius anophthalmus*, from the underground Karst caves. The caves are rich in curious kinds of fish, *Paraphorinus Gethaldii*, which is unknown elsewhere, *Chondrostoma phoxiniss*, *Phoxinellus alepidatus* and others, which are caught and eaten by the peasantry. In Herzegovina, although many of the high mountain tarns are unproductive, the eel-fisheries of the Narenta are of considerable value. Leech-gathering is a characteristic Bosnian industry. The streams of both territories yield excellent trout and crayfish; salmon, sturgeon and sterlet, from the Danube, are netted in the Save.

5. *Flora*.—Serajevo museum has a collection of the Bosnian flora, representing over 3000 species; among them, the rare

Veronica crinita, *Pinus leucodermis*, *Picea omorica* and *Forests*. *Daphne Blagayana*. About 50% of the occupied territory is clothed with forest. "Bosnia begins with the forest," says a native proverb, "Herzegovina with the rock"; and this account is, broadly speaking, accurate, although the Bosnian Karst is as bare as that of Herzegovina. Below the mountain crests, where only the hardest lichens and mosses can survive, comes a belt of large timber, including many giant trees, 200 ft. high, and 20 ft. in girth at the level of a man's shoulder. Dense brushwood prevails on the foothills. There are three main zones of woodland. Up to 2500 ft. among the ranges of northern Bosnia, the sunnier slopes are overgrown by oaks, the shadier by beeches. Farther south, in central Bosnia, the oak rarely mounts beyond the foothills, being superseded by the beech, elm, ash, fir and pine, up to 5000 ft. The third zone is characterized by the predominance, up to 6000 ft., of the fir, pine and other conifers. In all three zones occur the chestnut, aspen, willow (especially *Salix laurea*), hornbeam, birch, alder, juniper and yew, while the mountain ash, hazel, wild plum, wild pear and other wild fruit trees are found at rarer intervals. Until 1878 the forests were almost neglected; afterwards, the government was forced to levy a graduated tax on goats, owing to the damage they inflicted upon young trees, and to curtail the popular rights of cutting timber and fir-wood and of pasturage. These measures were largely successful, but in 1902 the export of oak staves was discontinued owing to a shortage of supply.

6. *Agriculture*.—In 1895, according to the agricultural survey, the surface of Bosnia and Herzegovina was laid out as follows:—

	Acres.
Plough-land	2,355,499
Garden-ground	103,040
Meadow	739,200
Vineyards	12,598
Pasture	1,875,840
Forest	5,670,619
Unproductive	210,998

Apart from the arid wastes of the Karst, the soil is well adapted for the growing of cereals, especially Indian corn; olives, vines, mulberries, figs, pomegranates, melons, oranges, lemons, rice and tobacco flourish in Herzegovina and the more sheltered portions of Bosnia. Near Doboj, on the Bosna, there is a state sugar-refinery, for which beetroot is largely grown in the vicinity. *Pyrethrum cinerariaefolium* is exported for the manufacture of insect-powder, and sunflowers are cultivated for the oil contained in their seeds. The plum-orchards of the Posavina furnish prunes and a spirit called *šljivovica*, *šljivovitsa* or *šljivovica*. This district is the headquarters of a thriving trade in pigs. Poultry, bees and silkworms are commonly kept. On the whole agriculture is backward, despite the richness of the soil; for the cultivators are a very conservative race, and prefer the methods and implements of their ancestors. Many improvements were, nevertheless, introduced by the government after 1878. Machinery was lent to the farmers, and free grants of seed were made. Model farms were established at Livno and at Gačko, on the Montenegrin border; a school of viticulture near Mostar; a model poultry-farm at Prijedor, close to the Croatian boundary; a school of agriculture and dairy farming at Ilidže; and another school at Modrić, near the mouth of the Bosna, where a certain number of village schoolmasters are annually trained, for six weeks, in practical husbandry. Seed is distributed, and agricultural machinery lent, by the government. To better the breeds of live-stock, a stud-farm was opened near Serajevo, and foreign horses, cattle, sheep and poultry are imported.

7. *Land Tenure*.—The *sadruga*, or household community, more common in Servia (*q.v.*), survives to a small extent in Bosnia and Herzegovina; but, as a rule, the tenure of land resembles the system called *melayage*. At the time of the Austrian occupation (1878) it was regulated by a Turkish enactment¹ of the 12th of September 1859. Apart from gardens and house-property, all land was, according to this enactment, owned by the state; in practice, it was held by the Moslem *begs* or *beys* (nobles) and *agas* (landlords), who let it to the peasantry. The landlord received from his tenant (*amet*) a fixed percentage, usually one third (*tretina*), of the annual produce; and, of the remaining two thirds, the cash equivalent of one tenth (*desetina*) went to the state. The amount of the *desetina* was always fixed first, and served as a basis for the assessment of the *tretina*, which, however, was generally paid in kind. At any time the tenant could relinquish his holding; but he could only be evicted for refusing to pay his *tretina*, for willful neglect of his land or for damage done to it. The landlord was bound to keep his tenants' dwellings and outhouses in repair. Should he desire to sell his estates, the right of pre-emption belonged to the tenants, or, in default, to the neighbours. Thus foreign speculators in land were excluded, while a class of peasant proprietors was created; its numbers being increased by the custom that, if any man reclaimed a piece of waste land, it became his own property after ten years. The Turkish land-system remained in force during the entire period of the occupation (1878–1908). It had worked, on the whole, satisfactorily; and between 1885 and 1895 the number of peasants farming their own land rose from 117,000 to 200,000. One conspicuous feature of the Bosnian land-system is the Moslem *Vakuf*, or ecclesiastical property, consisting of estates dedicated to such charitable purposes as poor-relief, and the endowment of mosques, schools, hospitals, cemeteries and baths. It is administered by a central board of Moslem officials, who meet in

¹ This was soon modified in detail. Arrears of debt, for instance, were made recoverable for one year only, instead of the ten years allowed by Turkish law.

Serajevo, under state supervision. Its income rose to £25,000 in 1895, having quadrupled itself in ten years. The *Vakuf* tenants were at that time extremely prosperous, for their rent had been fixed for ten years in advance on the basis of the year's harvest, and so had not risen proportionately to the value of their holdings.

8. *Industries and Commerce.*—Beside agriculture, which employed over 88% of the whole population in 1895, the other industries are insignificant. Chief among them are weaving and leather and metal work, carried on by the workmen in their own houses. There are also government workshops, opened with a view to a higher technical and artistic development of the house industry. More particularly, chased and inlaid metallic wares, *ke* (thin cotton) and carpet-weaving receive government support. Besides the sugar-refinery already mentioned, there were in 1900 four tobacco factories, a national printing-press, an annular furnace for brick-burning, an iron-foundry and several blast-furnaces, under the management of the state. Among the larger private establishments there existed in the same year seven breweries, one brandy distillery, two jam, two soap and candle factories, two building and furniture works, a factory for spinning thread, one iron and steel works, one paper and one ammonia and soda factory, and one mineral-oil refinery.

In respect of foreign trade Bosnia and Herzegovina were in 1895 included in the customs and commercial system of Austria-Hungary, to the extinction of all intermediate imposts. Since 1895 special statistics have been drawn up respecting their trade also with Austria and Hungary. According to these statistics the most important articles of export are coal and turf, fruit, minerals, soda, iron and steel, and cattle. Other articles of export are chemicals, dyeing and tanning stuffs, tobacco, sugar-beet and kitchen-salt. The imports consist principally of food stuffs, building materials, drinks, sugar, machinery, glass, fats, clothes, wood and stone wares, and various manufactured goods.

There is a national bank in Serajevo, which carries on a hypothecary credit business and manages the wholesale trade of the tobacco factories. There are savings banks in Banjaluka, Bjelina and Brčka.

9. *Communications.*—The construction of carriage-roads, wholly neglected by the Turks, was carried out on a large scale by the Austrians. Two railways were also built, in connexion with the Hungarian state system. One crosses the Una at Kostajnica, and, after skirting the right bank of that river as far as Novi, strikes eastward to Banjaluka. The other, a narrow-gauge line, crosses the Save at Bosna Brod, and follows the Bosna to Serajevo, throwing out branches eastward beyond Dolnja Tuzla, and westward to Jajce and Bugojno. It then pierces through the mountains of northern Herzegovina, traverses the Narenta valley, and runs almost parallel with the coast to Trebinje, Ragusa and the Bocche di Cattaro. Up to this point the railways of the occupied territory were complete in 1901. A farther line, from Serajevo to the frontiers of Servia and Novibazar, was undertaken in 1902, and by 1906 782 m. of railway were open. Small steamers ply on the Drina, Save and Una, but the Bosna, though broad from its very source, is, like the *Vrbaš*, too full of shallows to be utilized; while the Narenta only begins to be navigable when it enters Dalmatia. All the railway lines, like the postal, telegraphic and telephonic services, are state property. In many of the principal towns there are also government hotels.

Serajevo, with 41,543 inhabitants in 1895, is the capital of the combined provinces, and other important places are Mostar (17,010), the capital of Herzegovina, Banjaluka (14,812), Dolnja Tuzla (11,034), Travnik (6626), Livno (5273), Visoko (5000), Foča (4217), Jajce (3929) and Trebinje (2966). All these are described in separate articles.

10. *Population and National Characteristics.*—In 1895 the population, which tends to increase slowly, with a preponderance of males over females, numbered 1,568,092. The alien element is small, consisting chiefly of Austrp-Hungarians, gipsies, Italians and Jews. Spanish is a common language of the Jews, whose ancestors fled hither, during the 16th century, to escape the Inquisition. The natives are officially described as Bosniaks,

but classify themselves according to religion. Thus the Roman Catholics prefer the name of Croats, Hrvats or Latins; the Orthodox, of Serbs; the Moslems, of Turks. All alike belong to the Serbo-Croatian branch of the Slavonic race; and all speak a language almost identical with Servian, though written by the Roman Catholics in Latin instead of Cyrillic letters. A full account of this language, and its literature, is given under SERBIA and CROATIA-SLAVONIA. To avoid offending either "Serbs" or "Croats," it is officially designated "Bosnisch." In some parts of Herzegovina the dress, manners and physical type of the peasantry are akin to those of Montenegro. The Bosnians or Bosniaks resemble their Servian kinsfolk in both appearance and character. They have the same love for poetry, music and romance; the same intense pride in their race and history; many of the same superstitions and customs. The Christians retain the Servian costume, modified in detail, as by the occasional use of the turban or fez. The "Turkish" women have in some districts abandoned the veil; but in others they even cover the eyes when they leave home. Polygamy is almost unknown, possibly because many of the "Turks" are descended from the austere Bogomils, who were, in most cases, converted to Islam, but more probably because the "Turks" are as a rule too poor to provide for more than one wife on the scale required by Islamic law. In general, the people of Bosnia and Herzegovina are sober and thrifty, subsisting chiefly on Indian corn, dried meat, milk and vegetables. Their houses are built of timber and thatch, or clay tiles, except in the Karst region, where stone is more plentiful than wood. Family ties are strong, and the women are not ill-treated, although they share in all kinds of manual labour.

11. *Government.*—At the time of the Austrian annexation in 1908, the only remaining token of Ottoman suzerainty was that the foreign consuls received their *exequatur* from Turkey, instead of Austria; otherwise the government of the country was conducted in the name of the Austrian emperor, through the imperial minister of finance at Vienna, who controlled the civil service for the occupied territory. Its central bureau, with departments of the interior, religion and education, finance and justice, was established at Serajevo; and its members were largely recruited among the Austrian Slavs, who were better able than the Germans to comprehend the local customs and language. A consultative assembly, composed of the highest ecclesiastical authorities, together with 12 popular representatives, also met at Serajevo. For administrative purposes the country was divided into 6 districts or prefectures (*kreise*), which were subdivided into 49 subprefectures (*bezirke*).

Every large town has a mayor and deputy mayor, appointed by the government, and a town council, of whom one third are similarly appointed, while the citizens choose the rest; a proportionate number of councillors representing each religious community. To ensure economy, the decisions of this body are supervised by a government commissioner. The commune is preserved, somewhat as in Servia (*g.v.*), but with modified powers. Each district has its court of law, where cases are tried by three official judges and two assessors, selected from the leading citizens. The assessors vote equally with the judges, and three votes decide the verdict. Except where the litigants and witnesses are German, the Serbo-Croatian language is used. An appeal, on points of law alone, may be carried to the supreme court in Serajevo, and there tried by five judges without assessors. In cases not involving a sum greater than 300 florins (£25), no appeal will lie; and where only 50 florins (£4:3:4) are in question, the case is summarily decided at the *Bugajelle Gericht*, or court for trifling cases. The number of lawyers admitted to practice is strictly limited. As far as possible, the Turkish law was retained during the period of occupation; all cases between Moslems were settled in separate courts by Moslem judges, against whom there was an appeal to the supreme court, aided by assessors. All able-bodied males are liable, on reaching their 21st year, for 3 years' service with the colours, and 9 years in the reserve. The garrison numbers about 20,000 Austrian troops, and there are 7100 native troops. The principal military

stations are Bjelina, Zvornik, Višegrad, Gorazda, Foča, Bilek, Avtovac and Trebinje, along the eastern frontier; Mostar and Stolac in the south; Livno in the west; and Bihać in the north.

12. *Religion*.—In 1895 43% of the population were Orthodox Christians, 35% Moslems and 21% Roman Catholics. The patriarch of Constantinople is the nominal head of the Orthodox priesthood; but by an arrangement concluded in 1879, his authority was delegated to the Austrian emperor, in exchange for a revenue equal to the tribute previously paid by the clergy of the provinces; and his nominations for the metropolitanate of Serajevo, and the bishoprics of Dolnja Tuzla, Banjaluka and Mostar require the imperial assent. Under Turkish rule the communes chose their own parish priests, but this right is now vested in the government. The Roman Catholics have an archbishop in Serajevo, a bishop in Mostar and an apostolic administrator in Banjaluka. Serajevo is also the seat of the Jewish chief rabbi; and of the highest Moslem ecclesiastic, or *reis-el-ulema*, who with his council is nominated and paid by the government. The inferior Moslem clergy draw their stipends from the *Vakuf*. Considerable bitterness prevails between the rival confessions, each aiming at political ascendancy, but the government favours none. In order to conciliate even the Moslems, who include the bulk of the great landholders and of the urban population, its representatives visit the mosques in state on festivals; grants are made for the Mecca pilgrimage; and even the howling Dervishes in Serajevo are maintained by the state.

13. *Education*.—Education for boys and girls between the ages of seven and fifteen is free, but not compulsory. The state supports primary schools (352 in 1905), where reading, writing, arithmetic and history are taught; and separate instruction is given by the Orthodox, Roman Catholic, Jewish and Moslem clergy. There are also various private schools, belonging to the different religious communities. These receive a grant from the government, which nevertheless encourages all parents to send their children to its own schools. One of the earliest and best-known private schools is the orphanage at Serajevo, founded in 1869 by two English ladies, Miss Irby and Miss Mackenzie. In the Moslem schools, which, in 1905, comprised 855 *mektebs* or primary schools, and 41 *madrasas* or high schools, instruction is usually given in Turkish or Arabic; while in Orthodox schools the books are printed in Cyrillic characters.

For higher education there were in 1908 three gymnasias, a real-school at Banjaluka, a technical college and a teachers' training-college at Serajevo, where, also, is the state school for Moslem law-students, called *scheriatschule* from the *sheri* or Turkish code; and various theological, commercial and art institutes. Promising pupils are frequently sent to Vienna University, with scholarships, which may be forfeited if the holders engage in political agitation.

14. *Antiquities*.—Up to 1900 no traces of palaeolithic man had been discovered in Bosnia or Herzegovina; but many later prehistoric remains are preserved in Serajevo museum. The neolithic station of Butmir, near Iliđe, was probably a lake-dwellers' colony, and has yielded numerous stone and horn implements, clay figures and pottery. Not far off, similar relics were found at Sobunar, Zlatište and Debelobrd; iron and bronze ornaments, vessels and weapons, often of elaborate design, occur in the huts and cemeteries of Glasinac, and in the cemetery of Jezerine, where they are associated with objects in silver, tin, amber, glass, &c. Among the numerous finds made in other districts may be mentioned the discovery, at Vrankamer, near Bihać, of 98 African coins, the oldest of which dates from 300 B.C. Many vestiges of Roman rule survive, such as roads, mines, ruins, tombs, coins, frescoes and inscriptions. Such remains occur frequently near Bihać, Foča, Livno, Jajce and Serajevo; and especially near the sources of the Drina. The period between the downfall of Roman power, late in the 5th century, and the growth of a Bosnian state, in the 11th, is poorer in antiquities. The later middle ages are represented by several monasteries, and many castles, such as those of Derwent, Dobo, Magla, Žepče and Vranduk, on the Bosna; Bihać, on

the Una; Prijedor and Ključ, on the Sana; and Stolac, Gabela, Irebinje and Konjica, in Herzegovina. The bridge across the Narenta, at Konjica, is said to date from the 10th century. A group of signs carved on some rocks near Višegrad have been regarded as cuneiform writing, but are probably medieval masonic symbols. In a few cases, such as the Begova Džamija at Serajevo, the Foča mosques and the Mostar bridge, the buildings raised by the Turks are of high architectural merit. More remarkable are the tombstones, generally measuring 6 ft. in length, 3 in height and 3 in breadth, which have been supposed to mark the graves of the Bogomils. These are, as a rule, quite unadorned, a few only being decorated with rude bas-reliefs of animals, plants, weapons, the crescent and star, or, very rarely, the cross.

15. *History*.—Under Roman rule Bosnia had no separate name or history, and until the great Slavonic immigration of 636 it remained an undifferentiated part of Illyria (q.v.). Owing to the scarcity of authoritative documents, it is impossible to describe in detail the events of the next three centuries. During this period Bosnia became the generally accepted name for the valley of the Bosna (ancient *Basanius*); and subsequently for several outlying and tributary principalities, notably those of Soli, afterwards Tuzla; Usora, along the south-eastern bank of the Save; Donji Kraji, the later Krajina, Kraina or Turkish Croatia, in the north-west; and Rama, the modern district of Livno. The old Illyrian population was rapidly absorbed or expelled, its Latin institutions being replaced by the autonomous tribal divisions, or *Zupanets*, of the Slavs. Pressure from Hungary and Byzantium gradually welded these isolated social units into a single nation, whose ruler was known as the Ban (q.v.). But the central power remained weak, and the country possessed no strong natural frontiers. It seems probable that the bans were originally viceroys of the Croatian kings, who resumed their sovereignty over Bosnia from 958 to 1010. Thenceforward, until 1180, the bans continued subject to the Eastern empire or Hungary, with brief intervals of independence. The territory now called Herzegovina was also subject to various foreign powers. It comprised the principalities of Tribunia or Travunja, with its capital at Trebinje; and Hum or Hum, the Zaclumia of Constantine Porphyrogenitus, who gives a clear picture of this region as it was in the 10th century.¹

The schism between Eastern and Western Christendom left Bosnia divided between the Greek and Latin Churches. Early in the 12th century a new religion, that of the Bogomils (q.v.), was introduced, and denounced as heretical. Its converts nevertheless included many of the Bosnian nobles and the ban Kulin (1180–1204), whose reign was long proverbial for its prosperity, owing to the flourishing state of commerce and agriculture, and the extensive mining operations carried on by the Ragusans. An unusually able ruler, connected by marriage with the powerful Servian dynasty of Nemanya, and by treaty with the republic of Ragusa,² Kulin perceived in the new doctrines a barrier between his subjects and Hungary. He was compelled to recant, under strong pressure from Pope Innocent III. and Béla III. of Hungary; but, despite all efforts, Bogomilism incessantly gained ground. In 1232 Stephen, the successor of Kulin, was dethroned by the native magnates, who chose instead Matthew Ninoslav, a Bogomil. This event illustrates the three dominant characteristics of Bosnian history: the strength of the aristocracy; the corresponding weakness of the central authority, enhanced by the lack of any definite rule of inheritance; and the supreme influence of religion. Threatened by Pope Gregory IX. with a crusade, Ninoslav was baptized, only to abjure Christianity in 1233. For six years he withstood the Hungarian crusaders, led by Kaloman, duke of Croatia; in 1241 the Tatar invasion of

¹ *De Administrando Imperio*, 33 and 34. The names of *Chalmis* and *Chelmo*, applied to this region by later Latin and Italian chroniclers, are occasionally adopted by English writers.

² For the commercial and political relations of Ragusa and Bosnia, see L. Villari, *The Republic of Ragusa* (London, 1904).

Hungary afforded him a brief respite; and in 1244 peace was concluded after a Bosnian campaign against Croatia. A renewal of the crusade proving equally vain, in 1247 Pope Innocent III. entered into friendly negotiations with the ban, whose country was for the moment an independent and formidable state. The importance attached to its conversion is well attested by the correspondence of Pope Gregory IX. with Ninoslav and various Bosnian ecclesiastics.¹

On the death of Ninoslav in 1250, vigorous efforts were made to exterminate the Bogomil heresy; and to this end, Béla IV., who appeared as the champion of Roman Catholicism, secured the election of his nominee Prijesda to the banate. Direct Hungarian suzerainty lasted until 1299, the bans preserving only a shadow of their former power. From 1299 to 1322 the country was ruled by the Croatian princes, Paul and Mladen Šubić, who, though vassals of Hungary, reunited the provinces of Upper and Lower Bosnia, created by the Hungarians in order to prevent the growth of a dangerous national unity. A rising of the native magnates in 1322 resulted in the election of the Bogomil, Stephen Kotromanić, last and greatest of the Bosnian bans.

At this period the Servian empire had reached its zenith; Hungary, governed by the feeble monarch, Charles Robert of Anjou, was striving to crush the insurgent magnates of Croatia; Venice, whose commercial interests were imperilled, desired to restore peace and maintain the balance of power. Dread of Serbia impelled Kotromanić to aid Hungary. In an unsuccessful war against the Croats (1322-26), from which Venice derived the sole advantage, the ban appears to have learned the value of sea-power; immediately afterwards he occupied the principality of Hlum and the Dalmatian littoral between Spalato and the river Narenta. Ragusa furnished him with money and a fleet, in return for a guarantee of protection; commercial treaties with Venice further strengthened his position; and the Vatican, which had instigated the Croats to invade the dominions of their heretical neighbour (1337-40), was conciliated by his conversion to Roman Catholicism. Defeated by the Servian tsar Dushan, and driven to ally himself with Serbia and Venice against Louis I. of Hungary, Kotromanić returned to his allegiance in 1344. Four years later his influence brought about a truce between Hungary and the Venetians, who had agreed with Bosnia for mutual support against the Croats; and in 1353, the year of his death, his daughter Elizabeth was married to King Louis.

Stephen Tvrtko, the nephew and successor of Kotromanić, was a minor, and for thirteen years his mother, Helena, acted as regent.

Confronted by civil war, and deprived of Hlum by the Hungarians, she was compelled to acknowledge the suzerainty of Stephen Dushan, and afterwards of Louis. But in 1366 Tvrtko overcame all opposition at home, and forthwith embarked on a career of conquest, recapturing Hlum and annexing part of Dalmatia. The death of Stephen Dushan, in 1356, had left his empire defenceless against the Hungarians, Turks and other enemies; and to win help from Bosnia the Servian tsar Lazar ceded to Tvrtko a large tract of territory, including the principality of Tribunia. In 1376 Tvrtko was crowned as "Stephen I., king of Bosnia, Serbia, and all the Sea-coast," although Lazar retained his own title and a diminished authority. The death of Louis in 1392, the regency of his widow Elizabeth, and a fresh outbreak in Croatia, enabled Tvrtko to fulfil his predecessor's designs by establishing a maritime state. With Venetian aid he wrested from Hungary the entire Adriatic littoral between Fiume and Cattaro, except the city of Zara; thus adding Dalmatia to his kingdom at the moment when Serbia was lost through the Ottoman victory of Kosovo (1389). At his coronation he had proclaimed his purpose to revive the ancient Servian empire; in 1378 he had married the daughter of the last Bulgarian tsar; and it is probable that he dreamed of founding an empire which should extend from the Adriatic to the Black Sea. The disaster

of Kosovo, though fatal to his ambition, did not immediately react on Bosnia itself; and when Tvrtko died in 1391, his kingdom was still at the summit of its prosperity.

Kotromanić and Tvrtko had known how to crush or conciliate their turbulent magnates, whose power reasserted itself under Dabiša (Stephen II., 1391-1398), a brother of Tvrtko. Sigismund of Hungary profited by the disorder that ensued to regain Croatia and Dalmatia; and in 1398 the Turks, aided by renegade Slavs,² overran Bosnia. Ostoja (Stephen III., 1398-1418), an illegitimate son of Tvrtko, proved a puppet in the hands of Hrvoje Vukčić, duke of Spalato, Sandalj Hrančić, and other leaders of the aristocracy, who fought indifferently against the Turks, the Hungarians, the king or one another. Some upheld a rival claimant to the throne in Tvrtković, a legitimate son of Tvrtko, and all took sides in the incessant feud between Bogomils and Roman Catholics. During the reigns of Ostojić (Stephen IV., 1418-1421) and Tvrtković (Stephen V., 1421-1444) Bosnia was thus left an easy prey to the Turks, who exacted a yearly tribute, after again ravaging the country, and carrying off many thousands of slaves, with a vast store of plunder.

The losses inflicted on the Turks by Hunyadi János, and the attempt to organize a defensive league among the neighbouring Christian lands, temporarily averted the ruin of Bosnia under Thomas Ostojić (Stephen VI., 1444-1461). Hoping to gain active support from the Vatican, Ostojić renounced Bogomilism, and persecuted his former co-religionists, until the menace of an insurrection forced him to grant an amnesty. His position was endangered by the growing power of his father-in-law, Stephen Vukčić, an ardent Bogomil, who had united Tribunia and Hlum into a single principality. Vukčić—or *Cosaccia*, as he is frequently called by the contemporary chroniclers, from his birthplace, Cosac—was the first and last holder of the title "Duke of St Sava," conferred on him by the emperor Frederick III. in 1448; and from this title is derived the name *Herzegovina*, or "the Duchy." Hardly had the king become reconciled with this formidable antagonist, when, in 1453, the death of Hunyadi, and the fall of Constantinople, left Bosnia defenceless against the Turks. In 1460 it was again invaded. Venice and the Papacy were unable, and Hungary unwilling, to render assistance; while the Croats proved actively hostile. Ostojić died in 1461, and his successor Tomašević (Stephen VII., 1461-1463) surrendered to the Turks and was beheaded. Herzegovina, where Vukčić offered a desperate resistance, held out until 1483; but apart from the heroic defence of Jajce, the efforts of the Bosnians were feeble and inglorious, many of the Bogomils joining the enemy. From 1463 the greater part of the country submitted to the Turks; but the districts of Jajce and Srebrenica were occupied by Hungarian garrisons, and organized as a separate "banate" or "kingdom of Bosnia," until 1526, when the Hungarian power was broken at Mohács. In 1528 Jajce surrendered, after repelling every attack by the Turkish armies for 65 years.

The fall of Jajce was the consummation of the Turkish conquest. It was followed by the flight of large bodies of Christian refugees. Many of the Roman Catholics withdrew into Croatia-Slavonia and south Hungary, where they ultimately fell again under Ottoman dominion. Others found shelter in Rome or Venice, and a large number settled in Ragusa, where they doubtless contributed to the remarkable literary development of the 16th and 17th centuries in which the use of the Bosnian dialect was a characteristic feature. Some of the most daring spirits waged war on their conquerors from Clissa in Dalmatia, and afterwards from Zengg in maritime Croatia, where they formed the notorious pirate community of the Uskoks (*q.v.*). There was less inducement for the Orthodox inhabitants to emigrate, because almost

¹ This is the first recorded instance of such an alliance. The Slavs were probably Bogomils.

² These magnates played a considerable part in the politics of south-eastern Europe; see especially their correspondence with the Venetian Republic, given by Shafarik. *Acta archiepiscopi Veneti*, &c.

¹ Given by Theiner, *Vetera monumenta Hungariorum . . . illustrantia*, I. 73-105.

all the neighbouring lands were governed by Moslems or Roman Catholics; and at home the peasants were permitted to retain their creed and communal organization. Judged by its influence on Bosnian politics, the Orthodox community was relatively unimportant at the Turkish conquest; and its subsequent growth is perhaps due to the official recognition of the Greek Church, as the representative of Christianity in Turkey. The Christian aristocracy lost its privileges, but its ancient titles of duke (*vojvod*) and count (*knez*) did not disappear. The first was retained by the leaders who still carried on the struggle for liberty in Montenegro; the second was transferred to the headmen of the communes. Many of the Franciscans refused to abandon their work, and in 1463 they received a charter from the sultan Mahomet II., which is still preserved in the monastery of Fojnica, near Travnik. This toleration of religious orders, though it did not prevent occasional outrages, remained to the last characteristic of Turkish policy in Bosnia; and even in 1868 a colony of Trappist monks was permitted to settle in Banjaluka.

The Turkish triumph was the opportunity of the Bogomils, who thenceforth, assuming a new character, controlled the destinies of their country for more than three centuries. Bosnia was regarded by successive sultans as the gateway into Hungary; hatred of the Hungarians and their religion was hereditary among the Bogomils. Thus the desire for vengeance and the prospect of a brilliant military career impelled the Bogomil magnates to adopt the creed of Islam, which, in its austerity, presented some points of resemblance to their own doctrines. The nominal governor of the country was the Turkish *vali*, who resided at Banjaluka or Travnik, and rarely interfered in local affairs, if the taxes were duly paid. Below him ranked the newly converted Moslem aristocracy, who adopted the dress, titles and etiquette of the Turkish court, without relinquishing their language or many of their old customs. They dwelt in fortified towns or castles, where the *vali* was only admitted on sufferance for a few days; and, at the outset, they formed a separate military caste, headed by 48 *kapetans*—landholders exercising unfettered authority over their retainers and Christian serfs, but bound, in return, to provide a company of mounted troops for the service of their sovereign. Their favourite pursuits were fighting, either against a common enemy or among themselves, hunting, hawking and listening to the minstrels who celebrated their exploits. Their yearly visits to Serajevo assumed in time the character of an informal parliament, for the discussion of national questions; and their rights tended always to increase, and to become hereditary, in fact, though not in law. In every important campaign of the Turkish armies, these descendants of the Bogomils were represented; they amassed considerable wealth from the spoils of war, and frequently rose to high military and administrative positions. Thus, in 1570, Ali Pasha, a native of Herzegovina, became grand vizier; and he was succeeded by the distinguished soldier and statesman, Mahomet Beg Sokolović, a Bosnian. Below the feudal nobility and their Moslem soldiers came the Christian serfs, tillers of the soil and taxpayers, whose lives and property were at the mercy of their lords. The hardships of their lot, and, above all, the system by which the strongest of their sons were carried off as recruits for the corps of janissaries (*q.v.*), frequently drove them to brigandage, and occasionally to open revolt.

These conditions lasted until the 19th century, and meanwhile the country was involved in the series of wars waged by the Turks against Austria, Hungary and Venice. In the External history 1828-1829: Krajina and all along the Montenegrin frontier, Moslems and Christians carried on a ceaseless feud, irrespective of any treaties concluded by their rulers; while the Turkish campaigns in Hungary provided constant occupation for the nobles during a large part of the 16th and 17th centuries. But after the Ottoman defeat at Vienna in 1683, the situation changed. Instead of extending the foreign conquests of their sultan, the Bosnians were hard pressed to defend their own borders. Zvornik fell before the Austro-Hungarian army in 1688, and the Turkish *vali*, who was

still officially styled the "vali of Hungary," removed his headquarters from Banjaluka to Travnik, a more southerly, and therefore a safer capital. Two years later, the imperial troops reached Dolnja Tuzla, and retired with 3000 Roman Catholic emigrants. Serajevo was burned in 1697 by Eugene of Savoy, who similarly deported 40,000 Christians. The treaties of Carlowitz (1699) and Passarowitz (1718) deprived the Turks of all the Primorje, or littoral of Herzegovina, except the narrow enclaves of Klek and Sutorina, left to sunder the Ragusan dominions from those of Venice. At the same time a strip of territory in northern Bosnia was ceded to Austria, which was thus able to control both banks of the Save. This territory was restored to Turkey in 1739, at the peace of Belgrade; but in 1790 it was reoccupied by Austrian troops. Finally, in 1791, the treaty of Sistova again fixed the line of the Save and Una as the Bosnian frontier.

The reform of the Ottoman government contemplated by the sultan Mahmud II. (1808-1839) was bitterly resented in Bosnia, where Turkish prestige had already been weakened by the establishment of Servian autonomy under Karageorge. Many of the janissaries had married and settled on the land, forming a strongly conservative and fanatical caste, friendly to the Moslem nobles, who now dreaded the curtailment of their own privileges. Their opportunity came in 1820, when the Porte was striving to repress the insurrections in Moldavia, Albania and Greece. A first Bosnian revolt was crushed in 1821; a second, due principally to the massacre of the janissaries, was quelled with much bloodshed in 1827. After the Russo-Turkish War of 1828-29, a further attempt at reform was initiated by the sultan and his grand vizier, Reshid Pasha. Two years later came a most formidable outbreak; the sultan was denounced as false to Islam, and the Bosnian nobles gathered at Banjaluka, determined to march on Constantinople, and reconquer the Ottoman empire for the true faith. A holy war was preached by their leader, Hussein Aga Berberli, a brilliant soldier and orator, who called himself *Zmaj Bosanski*, the "Dragon of Bosnia," and was regarded by his followers as a saint. The Moslems of Herzegovina, under Ali Pasha Rizvanbegović, remained loyal to the Porte, but in Bosnia Hussein Aga encountered little resistance. At Kossovo he was reinforced by 20,000 Albanians, led by the rebel Mustapha Pasha; and within a few weeks the united armies occupied the whole of Bulgaria, and a large part of Macedonia. Their career was checked by Reshid Pasha, who persuaded the two victorious commanders to intrigue against one another, secured the division of their forces, and then fell upon each in turn. The rout of the Albanians at Prilipe and the capture of Mustapha at Scutari were followed by an invasion of Bosnia. After a desperate defence, Hussein Aga fled to Esseg in Croatia-Slavonia; his appeal for pardon was rejected, and in 1832 he was banished for life to Tribizon. The power of the Bosnian nobles, though shaken by their defeat, remained unbroken; and they resisted vigorously when their *kapetanates* were abolished in 1837; and again when a measure of equality before the law was conceded to the Christians in 1839. In Herzegovina, Ali Pasha Rizvanbegović reaped the reward of his fidelity. He was left free to tyrannize over his Christian subjects, a king in all but name. In 1840 he descended from his mountain stronghold of Stojica to wage war upon the vladika Peter II. of Montenegro, and simultaneously to suppress a Christian rising. Peace was arranged at Ragusa in 1842, and it was rumoured that Ali had concluded a secret alliance with Montenegro, hoping to shake off the suzerainty of the sultan, and to found an entirely independent kingdom. It is impossible to verify this charge, but during the troubled years that ensued, Ali pursued an elaborate policy of intrigue. He sent large bribes to influential persons at Constantinople; he aided the Turkish *vali* to repress the Christians, who had again revolted; and he supported the Bosnian nobles against reforms imposed by the *vali*. At last in 1850, a Turkish army was despatched to restore quiet. Al

¹ For details of these events see Umar Effendi, *History of the War in Bosnia (1737-1739)*. Translated by C. Fraser (London, 1830).

Pasha openly professed himself a loyal subject, but secretly sent reinforcements to the rebel aristocracy. The Turks proved everywhere successful. After a cordial reception by their commander Omer or Omar Pasha, Ali was imprisoned; he was shortly afterwards assassinated, lest his lavish bribery of Turkish officials should restore him to favour, and bring disgrace on his captor (March 1851).

The downfall of the Moslem aristocracy resulted in an important administrative change: Serajevo, which had long been the commercial centre of the country, and the jealously guarded stronghold of the nobles, superseded Travnik as the official capital, and the residence of the vali.

A variety of other reforms, including the reorganization of Moslem education, were introduced by Omer Pasha, who governed the country until 1860. But as the administration grew stronger, the position of the peasantry became worse. They had now to satisfy the imperial tax-farmers and excisemen, as well as their feudal lords. The begs and agas continued to exact their forced labour and one-third of their produce; the central government imposed a tithe which had become an eighth by 1875. Three kinds of cattle-tax, the tax for exemption from military service, levied on every newborn male, forced labour on the roads, forced loan of horses, a heavy excise on grapes and tobacco, and a variety of lesser taxes combined to burden the Christian serfs; but even more galling than the amount was the manner in which these dues were exacted—the extortionate assessments of tax-farmers and excisemen, the brutal licence of the soldiery who were quartered on recalcitrant villagers. A crisis was precipitated by the example of Servian independence, the hope of Austrian intervention, and the public bankruptcy of Turkey.

Sporadic insurrections had already broken out among the Bosnian Christians, and on the 1st of July 1875 the villagers of Nevesinje, which gives its name to a mountain range east of Mostar, rose against the Turks. Within a few weeks the whole country was involved. The Herzegovinians, under their leaders Peko Pavlović, Socica, Ljubibratić, and others, held out for a year against all the forces that Turkey could despatch against them.¹ In July 1876 Servia and Montenegro joined the struggle, and in April 1877 Russia declared war on the sultan.

The Austro-Hungarian occupation, authorized on the 13th of July 1878 by the treaty of Berlin (arts. 23 and 26), was not easily effected; and, owing to the difficulty of military operations among the mountains, it was necessary to employ a force of 200,000 men. Haji Loja, the native leader, was supported by a body of Albanians and mutinous Turkish troops, while the whole Moslem population bitterly resented the proposed change. The losses on both sides were very heavy, and, besides those who fell in battle, many of the insurgents were executed under martial law. But after a series of stubbornly contested engagements, the Austrian general, Philippović, entered Serajevo on the 19th of August, and ended the campaign on the 20th of September, by the capture of Bihać in the north-west, and of Klobuk in Herzegovina. The government of the country was then handed over to the imperial ministry of finance; but the bureaucratic methods of the finance ministers, Baron von Hoffmann and Joseph de Sclávy, resulted only in the insurrection of 1881-82. Order was restored in June 1882, when the administration was entrusted to Benjamin von Kállay (q.v.), as imperial minister of finance. Kállay retained this position until his death on the 13th of July 1903, when he was succeeded by Baron Stephan Burian de Rajecz. During this period life and property were rendered secure, and great progress was achieved, on the lines already indicated, in creating an efficient civil service, harmonizing Moslem law with new enactments, promoting commerce, carrying out important public works, and reorganizing the fiscal and educational systems. All classes

and creeds were treated impartially; and, although the administration has been reproached alike for undue harshness and undue leniency, neither accusation can be sustained. Critics have also urged that Kállay fostered the desire for material welfare at the cost of every other national ideal; that, despite his own popularity, he never secured the goodwill of the people for Austria-Hungary; that he left the agrarian difficulty unsolved, and the hostile religious factions unreconciled. These charges are not wholly unfounded; but the chief social and political evils in Bosnia and Herzegovina may be traced to historical causes operative long before the Austro-Hungarian occupation, and above all to the political ambition of the rival churches. Justly to estimate the work done by Kállay, it is only necessary to point to the contrast between Bosnia in 1882 and Bosnia in 1903; for in 21 years the anarchy and ruin entailed by four centuries of misrule were transformed into a condition of prosperity unsurpassed in south-eastern Europe.

It was no doubt natural that Austrian statesmen should wish to end the anomalous situation created by the treaty of Berlin, by incorporating Bosnia and Herzegovina into the Dual Monarchy. The treaty had contemplated the evacuation of the occupied provinces after the restoration of order and prosperity; and this had been expressly stipulated in an agreement signed by the Austro-Hungarian and Ottoman plenipotentiaries at Berlin, as a condition of Turkish assent to the provisions of the treaty. But the Turkish reform movement of 1908 seemed to promise a revival of Ottoman power, which might in time have enabled the Turks to demand the promised evacuation, and thus to reap all the ultimate benefits of the Austrian administration. The reforms in Turkey certainly encouraged the Serb and Moslem inhabitants of the occupied territory to petition the emperor for the grant of a constitution similar to that in force in the provinces of Austria proper. But the Austro-Hungarian government, profiting by the weakness of Russia after the war with Japan, and aware that the proclamation of Bulgarian independence was imminent, had already decided to annex Bosnia and Herzegovina, in spite of the pledges given at Berlin, and although the proposal was unpopular in Hungary. Its decision, after being communicated to the sovereigns of the powers signatory to the treaty of Berlin, in a series of autograph letters from the emperor Francis Joseph, was made known to Bosnia and Herzegovina in an imperial rescript published on the 7th of October 1908. The Serb and Moslem delegates, who had started on the same day for Budapest, to present their petition to the emperor, learned from the rescript that the government intended to concede to their compatriots "a share in the legislation and administration of provincial affairs, and equal protection for all religious beliefs, languages and racial distinctions." The separate administration was, however, to be maintained, and the rescript did not promise that the new provincial diet would be more than a consultative assembly, elected on a strictly limited franchise.

BIBLIOGRAPHY.—C. Capus, *A travers la Bosnie et l'Herzégovine* (Paris, 1896) contains a detailed and fully illustrated account of the combined provinces, their resources and population. J. Asbóth, *An Official Tour through Bosnia and Herzegovina* (London, 1890) is valuable for details of local history, antiquities and topography: A. Bordeaux, *La Bosnie populaire* (Paris, 1904) for social life and mining. Much information is also contained in the works by Lamouche, Miller, Thomson, Joanne, Cambon, Millet, Hamard and Laveleye, cited under the heading BALKAN PENINSULA. See also B. Nikašinić, *Bosnien und die Herzegovina unter der Verwaltung der österreich-ungarischen Monarchie* (Berlin, 1901, &c.), and M. Oransz, *Auf dem Rade durch Kroatien und Bosnien* (Vienna, 1903). The best map is that of the Austrian General Staff. See also for geology, J. Cvijić, *Morphologische und glacielle Studien aus Bosnien* (Vienna, 1900); F. Katzer, *Geologischer Führer durch Bosnien und Herzegovina* (Serajevo, 1903); P. Ballif, *Wasserbauten in Bosnien und Herzegovina* (Vienna, 1896). Sport: "Snaffe," *In the Land of the Bora* (London, 1897). Agriculture and Commerce: annual British consular reports, and the official *Ergebnisse der Viehzählungen* (1879 and 1895), and *Landwirtschaft in Bosnien und Herzegovina* (1899). The chief official publications are in German. For antiquities, see R. Munro, *Through Bosnia-Herzegovina and Dalmatia* (Edinburgh, 1900); A. J. Evans, *Illyrian Letters* (London, 1878); W. Radimský, *Die*

¹ For the Christian rebellion and its causes, see A. J. Evans, *Through Bosnia and Herzegovina on Foot* (London, 1876); and W. J. Stillman, *Herzegovina and the Late Uprising* (London, 1877).

neolithische Station von Bulmir (Vienna 1895-1898); P. Ballif, *Römische Strassen in Bosnien und Herzegovina* (Vienna, 1893, &c.). No adequate history of Bosnia was published up to the 20th century; but the chief materials for such a work are contained in the following books:—A. Theiner, *Vetera monumenta historica Hungariorum sacrum illustrantia* (Rome, 1860) and *Vetera monumenta Slavorum Meridionalium* (I. Rome, 1863; 2. Agram, 1875).—these are collections of Latin documents from the Vatican library; V. Makushev, *Monumenta historica Slavorum meridionalium* (Belgrade, 1885); Y. Shafarik, *Acta archivi Veneti spectantia ad historiam Serborum, &c.* (Belgrade, 1860-1862); F. Miklosich, *Monumenta Serbica* (Vienna, 1858). Other important authorities are G. Lucio, *De Regno Dalmatiae et Croatiae* (Amsterdam, 1666); M. Orbini, *Regno degli Slavi* (Pesaro 1601); D. Farlati and others, *Illyricum Sacrum* (Venice, 1751-1819); C. du Fresne du Cange, *Illyricum vetus et novum* (1746); M. Simek *Politische Geschichte des Königreiches Bosnien und Rama* (Vienna, 1787). The best modern history, though valueless for the period after 1463, is by P. Coquelle, *Histoire du Monténégro et de la Bosnie* (Paris, 1895). See also V. Klaić, *Geschichte Bosniens* (Leipzig 1884). J. Spalajkovič (Spalajković), in *La Bosnie et l'Herzégovine* (Paris, 1897), give a critical account of the Austro-Hungarian administration. (K. G. J.)

BOSPORUS, or **BOSPHORUS** (Gr. Βόσπορος = ox-ford, traditionally connected with Io, daughter of Inachus, who, in the form of a heifer, crossed the Thracian Bosphorus on her wanderings). By the ancients this name, signifying a strait, was especially applied to the *Bosporus Cimmerius* (see below), and the *Bosporus Thracius*; but when used without any adjective it now denotes the latter, which unites the Black Sea with the Sea of Marmora and forms part of the boundary between Europe and Asia. The channel is 18 m. long, and has a maximum breadth at the northern entrance of 2½ m., a minimum breadth of about 800 yds., and a depth varying from 20 to 66 fathoms in mid-stream. In the centre there is a rapid current from the Black Sea to the Sea of Marmora, but a counter-current sets in the opposite direction below the surface and along the shores. The surface current varies in speed, but averages nearly 3 m. an hour; though at narrow places it may run at double this pace. The strait is very rarely frozen over, though history records a few instances; and the Golden Horn, the inlet on either side of which Constantinople lies, has been partially frozen over occasionally in modern times. The shores of the Bosphorus are composed in the northern portion of different volcanic rocks, such as dolerite, granite and trachyte; but along the remaining course of the channel the prevailing formations are Devonian, consisting of sandstones, marls, quartzose conglomerates, and calcareous deposits of various kinds. The scenery on both sides is of the most varied and beautiful description, many villages lining each well-wooded shore, while on the European side are numerous fine residences of the wealthy class of Constantinople. The Bosphorus is under Turkish dominion, and by treaty of 1841, confirmed by the treaty of Berlin in 1878 and at other times, no ship of war other than Turkish may pass through the strait (or through the Dardanelles) without the countenance of the Porte. (See also CONSTANTINOPLE.)

BOSPORUS CIMMERIUS, the ancient name for the Straits of Kerch or Yenikale, connecting the Black Sea and the Sea of Azov; the Cimmerii (*q.v.*) were the ancient inhabitants. The straits are about 25 m. long and 2½ m. broad at the narrowest, and are formed by an eastern extension of the Crimea and the peninsula of Taman, a kind of continuation of the Caucasus. This in ancient times seems to have formed a group of islands intersected by arms of the Hypanis or Kuban and various sounds now silted up. The whole district was dotted with Greek cities; on the west side, Panticapæum (Kerch, *q.v.*), the chief of all, often itself called Bosphorus, and Nymphæum (Eltegen); on the east Phanagoria (Sennája), Cepi, Hermonassa, Portus Sindicus, Gorgippia (Anapa). These were mostly settled by Milesians, Panticapæum in the 7th or early in the 6th century B.C., but Phanagoria (c. 540 B.C.) was a colony of Teos, and Nymphæum had some connexion with Athens—at least it appears to have been a member of the Delian Confederacy. The towns have left hardly any architectural or sculptural remains, but the numerous barrows in their neighbourhood have yielded very beautiful objects now mostly preserved in the Hermitage in St Petersburg. They comprise especially gold work, vases exported from Athens,

textiles and specimens of carpentry and marquetry. The numerous terra-cottas are rather rude in style.

According to Diodorus Siculus (xii. 31) the locality was governed from 480 to 438 B.C. by the Archaeanactidae, probably a ruling family, who gave place to a tyrant Spartocus (438-431 B.C.), apparently a Thracian. He founded a dynasty which seems to have endured until c. 110 B.C. The Spartocids have left many inscriptions which tell us that the earlier members of the house ruled as archons of the Greek cities and kings of various native tribes, notably the Sindi of the island district and other branches of the Maitae (Maeotae). The text of Diodorus, the inscriptions and the coins do not supply sufficient material for a complete list of them. Satyrus (431-387), the successor of Spartocus, established his rule over the whole district, adding Nymphæum to his dominions and laying siege to Theodosia, which was a serious commercial rival by reason of its ice-free port and direct proximity to the cornfields of the eastern Crimea. It was reserved for his son Leucon (387-347) to take this city. He was succeeded by his two sons conjointly, Spartocus II. and Paerisades; the former died in 342 and his brother reigned alone until 310. Then followed a civil war in which Eumelus (310-303) was successful. His successor was Spartocus III. (303-283) and after him Paerisades II. Succeeding princes repeated the family names, but we cannot assign them any certain order. We know only that the last of them, a Paerisades, unable to make headway against the power of the natives, called in the help of Diophantus, general of Mithradates VI. (the Great) of Pontus, promising to hand over his kingdom to that prince. He was slain by a Scythian Saumacus who led a rebellion against him. The house of Spartocus was well known as a line of enlightened and wise princes; although Greek opinion could not deny that they were, strictly speaking, tyrants, they are always described as dynasts. They maintained close relations with Athens, their best customers for the Bosphoran corn export, of which Leucon I. set the staple at Theodosia, where the Attic ships were allowed special privileges. We have many references to this in the Attic orators. In return the Athenians granted him Athenian citizenship and set up decrees in honour of him and his sons. Mithradates the Great entrusted the Bosphorus Cimmerius to his son Machares, who, however, deserted to the Romans. But even when driven out of his own kingdom by Pompey, Mithradates was strong enough to regain the Bosphorus Cimmerius, and Machares slew himself. Subsequently the Bosphorans again rose in revolt under Pharnaces, another of the old king's sons. After the death of Mithradates (B.C. 63), this Pharnaces (63-47) made his submission to Pompey, but tried to regain his dominion during the civil war. He was defeated by Caesar at Zela, and on his return to Rome was slain by a pretender Asander who married his daughter Dynamis, and in spite of Roman nominees ruled as archon, and later as king, until 16 B.C. After his death Dynamis was compelled to marry an adventurer Scribonius, but the Romans under Agrippa interfered and set Polemon (14-8) in his place. To him succeeded Aspurgus (8 B.C.-A.D. 38?), son of Asander, who founded a line of kings which endured with certain interruptions until A.D. 341. These kings, who mostly bore the Thracian names of Cotys, Rhescuporis, Rhoemetalces, and the native name Sauromates, claimed descent from Mithradates the Great, and used the Pontic era (starting from 297 B.C.) introduced by him, regularly placing dates upon their coins and inscriptions. Hence we know their names and dates fairly well, though scarcely any events of their reigns are recorded. Their kingdom covered the eastern half of the Crimea and the Taman peninsula, and extended along the east coast of the Sea of Azov to Tanais at the mouth of the Don, a great mart for trade with the interior. They carried on a perpetual war with the native tribes, and in this were supported by their Roman suzerains, who even lent the assistance of garrison and fleet. At times rival kings of some other race arose and probably produced some disorganization. At one of these periods (A.D. 255) the Goths and Borani were enabled to seize Bosphoran shipping and raid the shores of Asia Minor. With the last coin of the last Rhescuporis, A.D. 341, materials for a connected history of the Bosphorus Cimmerius come to an end. The

kingdom probably succumbed to the Huns established in the neighbourhood. In later times it seems in some sort to have been revived under Byzantine protection, and from time to time Byzantine officers built fortresses and exercised authority at Bosphorus, which was constituted an archbishopric. They also held Ta Matarcha on the Asiatic side of the strait, a town which in the 10th and 11th centuries became the seat of the Russian principality of Tmutarakan, which in its turn gave place to Tatar domination.

The Bosphoran kingdom is interesting as the first Hellenistic state, the first, that is to say, in which a mixed population adopted the Greek language and civilization. It depended for its prosperity upon the export of wheat, fish and slaves, and this commerce supported a class whose wealth and vulgarity are exemplified by the contents of the numerous tombs to which reference has been made. In later times a Jewish element was added to the population, and under its influence were developed in all the cities of the kingdom, especially Tanais, societies of "worshippers of the highest God," apparently professing a monotheism which without being distinctively Jewish or Christian was purer than any found among the inhabitants of the Empire.

We possess a large series of coins of Panticapaeum and other cities from the 5th century B.C. The gold *staters* of Panticapaeum bearing Pan's head and a griffin are specially remarkable for their weight and fine workmanship. We have also coins with the names of the later Spartocids and a singularly complete series of dated *solidi* issued by the later or Achaemenian dynasty; in them may be noticed the swift degeneration of the gold *solidus* through silver and potin to bronze (see also NUMISMATICS).

See, for history, introduction to V. V. Latyshev, *Inscr. orae Septent. Pontis Euxini*, vol. ii. (St Petersburg, 1890); art. "Bosphorus" (2) by C. G. Brandis in Pauly-Wissowa, *Realencycl.* vol. iii. 757 (Stuttgart, 1899); E. H. Minns, *Scythians and Greeks* (Cambridge, 1907). For inscriptions, Latyshev as above and vol. iv. (St Petersburg, 1901). Coins: B. Koehne, *Musée Kotschoubey* (St Petersburg, 1853). Religious Societies: E. Schturer in *Sisber. d. h. pr. Akad. d. Wissenschaften zu Berlin* (1897), I. pp. 200-227. Excavations: *Antiquités de Bosphore cimmérien* (St Petersburg, 1854, repr. Paris, 1892) and *Compte rendu* and *Bulletin de la Commission Imp. Archéologique de St-Petersbourg*. (E. H. M.)

BOSQUET, PIERRE FRANÇOIS JOSEPH (1810-1861), French marshal, entered the artillery in 1833, and a year later went to Algeria. Here he soon did good service, and made himself remarkable not only for technical skill but the moral qualities indispensable for high command. Becoming captain in 1839, he greatly distinguished himself at the actions of Sidi-Lakhdar and Oued-Melah. He was soon afterwards given the command of a battalion of native *tirailleurs*, and in 1843 was thanked in general orders for his brilliant work against the Flittahs. In 1845 he became lieutenant-colonel, and in 1847 colonel of a French line regiment. In the following year he was in charge of the Oran district, where his swift suppression of an insurrection won him further promotion to the grade of general of brigade, in which rank he went through the campaign of Kabulia, receiving a severe wound. In 1853 he returned to France after nineteen years' absence, a general of division. Bosquet was amongst the earliest chosen to serve in the Crimean War, and at the battle of the Alma his division led the French attack. When the Anglo-French troops formed the siege of Sevastopol, Bosquet's corps of two divisions protected them against interruption. His timely intervention at Inkerman (November 5, 1854) secured the victory for the allies. During 1855 Bosquet's corps occupied the right wing of the besieging armies opposite the Mamelon and Malakof. He himself led his corps at the storming of the Mamelon (June 7), and at the grand assault of the 8th of September he was in command of the whole of the storming troops. In the struggle for the Malakof he received another serious wound. At the age of forty-five Bosquet, now one of the foremost soldiers in Europe, became a senator and a marshal of France, but his health was broken, and he lived only a few years longer. He had the grand cross of the Bath, the grand cross of the Legion of Honour, and the Medjidieh of the 1st class.

BOSS. (1) (From the O. Eng. *boce*, a swelling, cf. Ital. *bassa*, and Fr. *besse*, possibly connected with the O. Ger. *bison*, to beat.)

a round protuberance; the projecting centre or "umbo" of a buckler; in geology a projection of rock through strata of another species; in architecture, the projecting keystone of the ribs of a vault which masks their junction; the term is also applied to similar projecting blocks at every intersection. The boss was often richly carved, generally with conventional foliage but sometimes with angels, animals or grotesque figures. The boss was also employed in the flat timber ceilings of the 15th century, where it formed the junction of cross-ribs. (2) (From the Dutch *baas*, a word used by the Dutch settlers in New York for "master," and so generally used by the Kaffirs in South Africa; connected with the Ger. *Base*, cousin, meaning a "chief kinsman," the head of a household or family), a colloquial term, first used in America, for an employer, a foreman, and generally any one who gives orders, especially in American political slang for the manager of a party organization.

BOSSI, GIUSEPPE (1777-1836), Italian painter and writer on art, was born at the village of Busto Arsizio, near Milan. He was educated at the college of Monza; and his early fondness for drawing was fostered by the director of the college, who supplied him with prints after the works of Agostino Caracci for copies. He then studied at the academy of Brera at Milan, and about 1795 went to Rome, where he formed an intimate friendship with Canova. On his return to Milan he became assistant secretary, and then secretary, of the Academy of Fine Arts. He rendered important service in the organization of this new institution. In 1804, in conjunction with Oriani, he drew up the rules of the three academies of art of Bologna, Venice and Milan, and soon after was rewarded with the decoration of the Iron Crown. On the occasion of the visit of Napoleon I. to Milan in 1805, Bossi exhibited a drawing of the Last Judgment of Michelangelo, and pictures representing Aurora and Night, Oedipus and Creon, and the Italian Parnassus. By command of Prince Eugene, viceroy of Italy, Bossi undertook to make a copy of the Last Supper of Leonardo, then almost obliterated, for the purpose of getting it rendered in mosaic. The drawing was made from the remains of the original with the aid of copies and the best prints. The mosaic was executed by Raffelli, and was placed in the imperial gallery of Vienna. Bossi made another copy in oil, which was placed in the museum of Brera. This museum owed to him a fine collection of casts of great works of sculpture acquired at Paris, Rome and Florence. Bossi devoted a large part of his life to the study of the works of Leonardo; and his last work was a series of drawings in monochrome representing incidents in the life of that great master. He left unfinished a large cartoon in black chalk of the Dead Christ in the bosom of Mary, with John and the Magdalene. In 1810 he published a special work in large quarto, entitled *Del Cenacolo di Leonardo da Vinci*, which had the merit of greatly interesting Goethe. His other works are *Delle Opinioni di Leonardo intorno alla simmetria de' corpi umani* (1811), and *Del Tipo dell'arte della pittura* (1816). Bossi died at Milan on the 15th of December 1816. A monument by Canova was erected to his memory in the Ambrosian library, and a bust was placed in the Brera.

BOSSU, RENÉ LE (1631-1680), French critic, was born in Paris on the 16th of March 1631. He studied at Nanterre, and in 1649 became one of the regular canons of Sainte-Geneviève. He wrote *Parallèle des principes de la physique d'Aristote et de celle de René Descartes* (1674), and a *Traité du poème épique*, highly praised by Boileau, the leading doctrine of which was that the subject should be chosen before the characters, and that the action should be arranged without reference to the personages who are to figure in the scene. He died on the 14th of March 1680.

BOSSUET, JACQUES BÉNIGNE (1627-1704), French divine, orator and writer, was born at Dijon on the 27th of September 1627. He came of a family of prosperous Burgundian lawyers; his father was a judge of the parliament (a provincial high court) at Dijon, afterwards at Metz. The boy was sent to school with the Jesuits of Dijon till 1642, when he went up to the college of Navarre in Paris to begin the study of theology; for a pious mother had brought him up to look on the priesthood as his natural vocation. At Navarre he gained a great reputation for

hard work; fellow-students nicknamed him *Bos suetus aratro*—an ox broken in to the plough. But his abilities became known beyond the college walls. He was taken up by the Hôtel de Rambouillet, a great centre of aristocratic culture and the original home of the *Précieuses*. Here he became the subject of a celebrated experiment. A dispute having arisen about extempore preaching, the boy of sixteen was put up, late one night, to deliver an impromptu discourse. He acquitted himself as well as in more conventional examinations. In 1652 he took a brilliant degree in divinity, and was ordained priest. The next seven years he spent at Metz, where his father's influence had got him a canonry at the early age of thirteen; to this was now added the more important office of archdeacon. He was plunged at once into the thick of controversy; for nearly half Metz was Protestant, and Bossuet's first appearance in print was a refutation of the Huguenot pastor Paul Ferry (1655). To reconcile the Protestants with the Roman Church became the great object of his dreams; and for this purpose he began to train himself carefully for the pulpit, an all-important centre of influence in a land where political assemblies were unknown, and novels and newspapers scarcely born. Not that he reached perfection at a bound. His youthful imagination was unbridled, and his ideas ran easily into a kind of paradoxical subtlety, redolent of the divinity school. But these blemishes vanished when he settled in Paris (1659), and three years later mounted the pulpit of the Chapel Royal.

In Paris the congregations had no mercy on purely clerical logic or clerical taste; if a preacher wished to catch their ear, he must manage to address them in terms they would agree to consider sensible and well-bred. Not that Bossuet thought too much of their good opinion. Having very stern ideas of the dignity of a priest, he refused to descend to the usual devices for arousing popular interest. The narrative element in his sermons grows shorter with each year. He never drew satirical pictures, like his great rival Bourdaloue. He would not write out his discourses in full, much less learn them off by heart: of the two hundred printed in his *Works* all but a fraction are rough drafts. No wonder ladies like Mme de Sévigné forsook him, when Bourdaloue dawned on the Paris horizon in 1669; though Fénelon and La Bruyère, two much sounder critics, refused to follow their example. Bossuet possessed the full equipment of the orator, voice, language, flexibility and strength. He never needed to strain for effect; his genius struck out at a single blow the thought, the feeling and the word. What he said of Martin Luther applies peculiarly to himself: he could "fling his fury into theses," and thus unite the dry light of argument with the fire and heat of passion. These qualities reach their highest point in the *Oraisons funèbres*. Bossuet was always best when at work on a large canvas; besides, here no conscientious scruples intervened to prevent him giving much time and thought to the artistic side of his subject. For the *Oraison*, as its name betokened, stood midway between the sermon proper and what would nowadays be called a biographical sketch. At least, that was what Bossuet made it; for on this field he stood not merely first, but alone. His three great masterpieces were delivered at the funerals of Henrietta Maria, widow of Charles I. (1669), her daughter, Henrietta, duchess of Orleans (1670), and the great soldier Condé (1687).

Apart from these state occasions, Bossuet seldom appeared in a Paris pulpit after 1669. In that year he was gazetted bishop of Condom in Gascony, though he resigned the charge on being appointed tutor to the dauphin, only child of Louis XIV., and now a boy of nine (1670). The choice was scarcely fortunate. Bossuet unbent as far as he could, but his genius was by no means fitted to enter into the feelings of a child; and the dauphin was a cross, ungainly, sullen lad, who grew up to be a merely genealogical incident at his father's court. Probably no one was happier than the tutor, when his charge's sixteenth birthday came round, and he was promptly married off to a Bavarian princess. Still the nine years at court were by no means wasted. Hitherto Bossuet had published nothing, except his answer to Ferry. Now he sat down to write for his pupil's instruction—or rather, to fit himself to give that instruc-

tion—a remarkable trilogy. First came the *Traité de la connaissance de Dieu et de soi-même*, then the *Discours sur l'histoire universelle*, lastly the *Politique tirée de l'Écriture Sainte*. The three books fit into each other. The *Traité* is a general sketch of the nature of God and the nature of man. The *Discours* is a history of God's dealings with humanity in the past. The *Politique* is a code of rights and duties drawn up in the light thrown by those dealings. Not that Bossuet literally supposed that the last word of political wisdom had been said by the Old Testament. His conclusions are only "drawn from Holy Scripture," because he wished to gain the highest possible sanction for the institutions of his country—to hallow the France of Louis XIV. by proving its astonishing likeness to the Israel of Solomon. Then, too, the veil of Holy Scripture enabled him to speak out more boldly than court-etiquette would have otherwise allowed, to remind the son of Louis XIV. that kings have duties as well as rights. Louis had often forgotten these duties, but Louis's son would bear them in mind. The tutor's imagination looked forward to a time when France would blossom into Utopia, with a Christian philosopher on the throne. That is what made him so stalwart a champion of authority in all its forms: "*le roi, Jésus-Christ et l'Église, Dieu en ces trois noms.*" he says in a characteristic letter. And the object of his books is to provide authority with a rational basis. For Bossuet's worship of authority by no means killed his confidence in reason; what it did was to make him doubt the honesty of those who reasoned otherwise than himself. The whole chain of argument seemed to him so clear and simple. Philosophy proved that a God exists, and that He shapes and governs the course of human affairs. History showed that this governance is, for the most part, indirect, exercised through certain venerable corporations, as well civil as ecclesiastical, all of which demand implicit obedience as the immediate representatives of God. Thus all revolt, whether civil or religious, is a direct defiance of the Almighty. Cromwell becomes a moral monster, and the revocation of the edict of Nantes is "the greatest achievement of the second Constantine." Not that Bossuet glorified the *status quo* simply as a clerical bigot. The France of his youth had known the misery of divided counsels and civil war; the France of his manhood, brought together under an absolute sovereign, had suddenly shot up into a splendour only comparable with ancient Rome. Why not, then, strain every nerve to hold innovation at bay and prolong that splendour for all time? Bossuet's own *Discours sur l'histoire universelle* might have furnished an answer, for there the fall of many empires is detailed. But then the *Discours* was composed under a single preoccupation. To Bossuet the establishment of Christianity was the one point of real importance in the whole history of the world. Over Mahomet and the East he passed without a word; on Greece and Rome he only touched in so far as they formed part of the *Præparatio Evangelica*. And yet his *Discours* is far more than a theological pamphlet. Pascal, in utter scorn for science, might refer the rise and fall of empires to Providence or chance—the nose of Cleopatra, or "a little grain of sand" in the English lord protector's veins. Bossuet held fast to his principle that God works through secondary causes. "It is His will that every great change should have its roots in the ages that went before it." Bossuet, accordingly, made a heroic attempt to grapple with origins and causes, and in this way his book deserves its place as one of the very first of philosophic histories.

From writing history he turned to history in the making. In 1681 he was gazetted bishop of Meaux; but before he could take possession of his see, he was drawn into a violent quarrel between Louis XIV. and the pope (see GALLICANISM). Here he found himself between two fires. To support the pope meant supporting the Jesuits; and he hated their casuists and *dévotion aisée* almost as much as Pascal himself. To oppose the pope was to play into the hands of Louis, who was frankly anxious to humble the Church before the State. So Bossuet steered a middle course. Before the general assembly of the French clergy he preached a great sermon on the unity of the Church, and made it a magnificent plea for compromise. As Louis

insisted on his clergy making an anti-papal declaration, Bossuet got leave to draw it up, and made it as moderate as he could. And when the pope declared it null and void, he set to work on a gigantic *Defensio Cleri Gallicani*, only published after his death.

The Gallican storm a little abated, he turned back to a project very near his heart. Ever since the early days at Metz he had been busy with schemes for uniting the Huguenots to the Roman Church. In 1668 he converted Turenne; in 1670 he published an *Exposition de la foi catholique*, so moderate in tone that adversaries were driven to accuse him of having fraudulently watered down the Roman dogmas to suit a Protestant taste. Finally in 1688 appeared his great *Histoire des variations des églises protestantes*, perhaps the most brilliant of all his works. Few writers could have made the Justification controversy interesting or even intelligible. His argument is simple enough. Without rules an organized society cannot hold together, and rules require an authorized interpreter. The Protestant churches had thrown over this interpreter; and Bossuet had small trouble in showing that, the longer they lived, the more they varied on increasingly important points. For the moment the Protestants were pulverized; but before long they began to ask whether variation was necessarily so great an evil. Between 1691 and 1701 Bossuet corresponded with Leibnitz with a view to reunion, but negotiations broke down precisely at this point. Individual Roman doctrines Leibnitz thought his countrymen might accept, but he flatly refused to guarantee that they would necessarily believe to-morrow what they believe to-day. "We prefer," he said, "a church eternally variable and for ever moving forwards." Next, Protestant writers began to accumulate some startling proofs of Rome's own variations; and here they were backed up by Richard Simon, a priest of the Paris Oratory, and the father of Biblical criticism in France. He accused St Augustine, Bossuet's own special master, of having corrupted the primitive doctrine of Grace. Bossuet set to work on a *Défense de la tradition*, but Simon calmly went on to raise issues graver still. Under a veil of politely ironical circumlocutions, such as did not deceive the bishop of Meaux, he claimed his right to interpret the Bible like any other book. Bossuet denounced him again and again; Simon told his friends he would wait until "the old fellow" was no more. Another Oratorian proved more dangerous still. Simon had endangered miracles by applying to them lay rules of evidence, but Malebranche abrogated miracles altogether. It was blasphemous, he argued, to suppose that the Author of nature would break through a reign of law He had Himself established. Bossuet might scribble *nona, mira, falsa*, in the margins of his book and urge on Fénelon to attack them; Malebranche politely met his threats by saying that to be refuted by such a pen would do him too much honour. These repeated checks soured Bossuet's temper. In his earlier controversies he had borne himself with great magnanimity, and the Huguenot ministers he refuted found him a kindly advocate at court. Even his approval of the revocation of the edict of Nantes stopped far short of approving dragonades within his diocese of Meaux. But now his patience was wearing out. A dissertation by one Father Caffaro, an obscure Italian monk, became his excuse for writing certain violent *Maximes sur la comédie* (1694) wherein he made an outrageous attack on the memory of Molière, dead more than twenty years. Three years later he was battling with Fénelon over the love of God, and employing methods of controversy at least as odious as Fénelon's own (1697-1699). All that can be said in his defence is that Fénelon, four-and-twenty years his junior, was an old pupil, who had suddenly grown into a rival; and that on the matter of principle most authorities thought him right.

Amid these gloomy occupations Bossuet's life came slowly to an end. Till he was over seventy he had scarcely known what illness was; but in 1702 he was attacked by the stone. Two years later he was a hopeless invalid, and on the 12th of April 1704 he passed quietly away. Of his private life there is little to record. Meaux found him an excellent and devoted bishop, much more attentive to diocesan concerns than his more stirring occupations would seem to allow. In general society he was

kindly and affable enough, though somewhat ill at ease. Until he was over forty, he had lived among purely ecclesiastical surroundings; and it was probably want of self-confidence, more than want of moral courage, that made him shut his eyes a little too closely to the disorders of Louis XIV.'s private life. After all, he was not the king's confessor; and to "reform" Louis, before age and Mme de Maintenon had sobered him down, would have taxed the powers of Daniel or Ezekiel. But in his books Bossuet was anything but timid. All of them, even the attacks on Simon, breathe an air of masculine belief in reason, rare enough among the apologists of any age. Bossuet would willingly have undertaken, as Malebranche actually undertook, to make an intelligent Chinaman accept all his ideas, if only he could be induced to lend them his attention. But his best praise is to have brought all the powers of language to paint an undying picture of a vanished world, where religion and letters, laws and science, were conceived of as fixed unalterable planets, circling for ever round one central Sun.

AUTHORITIES.—The best edition of Bossuet's sermons is the *Œuvres oratoires de Bossuet*, edited by Abbé Lebarq, in 6 vols. (Paris, 1890-1896). His complete works were edited by Lachat, in 31 vols. (Paris, 1862-1864). A complete list of the innumerable works relating to him will be found in the *Bossuet* number of the *Bibliothèque des bibliographies critiques*, compiled by Canon Charles Urbain, and published by the Société des Études Historiques (Paris, 1900). The general reader will find all he requires in the respective studies of M. Rebelliau, *Bossuet* (Paris, 1900), and M. Gustave Lanson, *Bossuet* (Paris, 1901). In English there is a modest *Bossuet* by Mrs Sidney Lear (London, 1874), and two remarkable studies by Sir J. Fitz-James Stephen in the second volume of his *Horae Sabbaticae* (London, 1892). (St. C.)

BOSTANAI, the name of the first exilarch under Mahomedan rule, in the middle of the 7th century. The exilarchs had their seat in Persia, and were practically the secular heads of the Jewish community in the Orient.

BOSTON, THOMAS (1676-1732), Scottish divine, was born at Duns on the 17th of March 1676. His father, John Boston, and his mother, Alison Trotter, were both Covenanters. He was educated at Edinburgh, and licensed in 1697 by the presbytery of Chirnside. In 1699 he became minister of the small parish of Simprin, where there were in all "not more than 90 examinable persons." In 1704 he found, while visiting a member of his flock, a book which had been brought into Scotland by a commonwealth soldier. This was the famous *Marrow of Modern Divinity*, by Edward Fisher, a compendium of the opinions of leading Reformation divines on the doctrine of grace and the offer of the Gospel. Its object was to demonstrate the unconditional freeness of the Gospel. It cleared away such conditions as repentance, or some degree of outward or inward reformation, and argued that where Christ is heartily received, full repentance and a new life follow. On Boston's recommendation, Hog of Carnock reprinted *The Marrow* in 1718; and Boston also published an edition with notes of his own. The book, being attacked from the standpoint of high Calvinism, became the standard of a far-reaching movement in Scottish Presbyterianism. The "Marrow men" were marked by the zeal of their service and the effect of their preaching. As they remained Calvinists they could not preach a universal atonement; they were in fact extreme particular redemptionists. In 1707 Boston was translated to Ettrick. He distinguished himself by being the only member of the assembly who entered a protest against what he deemed the inadequate sentence passed on John Simson, professor of divinity at Glasgow, who was accused of heterodox teaching on the Incarnation. He died on the 20th of May 1732. His books, *The Fourfold State*, *The Crook in the Lot*, and his *Body of Divinity and Miscellanies*, long exercised a powerful influence over the Scottish peasantry.

His *Memoirs* were published in 1776 (ed. G. D. Low, 1908). An edition of his works in 12 volumes appeared in 1849. (D. M. N.)

BOSTON, a municipal and parliamentary borough and seaport of Lincolnshire, England, on the river Witham, 4 m. from its mouth in the Wash, 107 m. N. of London by the Great Northern railway. Pop. (1901) 15,667. It lies in a flat agricultural fen district, drained by numerous cuts, some of which are navigable. The church of St Botolph is a superb Decorated

building, one of the largest and finest parish churches in the kingdom. A Decorated chapel in it, formerly desecrated, was restored to sacred use by citizens of Boston, Massachusetts, U.S.A., in 1857, in memory of the connexion of that city with the English town. The western tower, commonly known as Boston Stump, forms a landmark for 40 m. Its foundations were the first to be laid of the present church (which is on the site of an earlier one), but the construction was arrested until the Perpendicular period, of the work of which it is a magnificent example. It somewhat resembles the completed tower of Antwerp cathedral, and is crowned by a graceful octagonal lantern, the whole being nearly 290 ft. in height. The church of Skirbeck, 1 m. south-east, though extensively restored, retains good Early English details. Other buildings of interest are the guildhall, a 15th-century structure of brick; Shodfriars Hall, a half-timbered house adjacent to slight remains of a Dominican priory; the free grammar school, founded in 1554, with a fine gateway of wrought iron of the 17th century brought from St Botolph's church; and the Hussey Tower of brick, part of a mansion of the 16th century. Public institutions include a people's park and large municipal buildings (1904).

As a port Boston was of ancient importance, but in the 18th century the river had silted up so far as to exclude vessels exceeding about 50 tons. In 1882-1884 a dock some 7 acres in extent was constructed, with an entrance lock giving access to the quay sides for vessels of 3000 tons. The bed of the river was deepened to 27 ft. for 3 m. below the town, and a new cut of 3 m. was made from the mouth into deep water. An iron swing-bridge connects the dock with the Great Northern railway. There is a repairing slipway accommodating vessels of 800 tons. Imports, principally timber, grain, cotton and linseed, increased owing to these improvements from £116,179 in 1881 to £816,698 in 1899; and exports (coal, machinery and manufactured goods) from £83,000 in 1883 to £261,873 in 1899. The deep-sea and coastal fisheries are important. Engineering, oil-cake, tobacco, sail and rope works are the principal industries in the town. Boston returns one member to parliament. The parliamentary borough falls within the Holland or Spalding division of the county. The municipal borough is under a mayor, 6 aldermen and 18 councillors. Area, 2727 acres.

Boston (Icanhoe, St Botolph or Botolph's Town) derives its name from St Botolph, who in 654 founded a monastery here, which was destroyed by the Danes, 870. Although not mentioned in *Domesday*, Boston was probably granted as part of Skirbeck to Alan, earl of Brittany. The excellent commercial position of the town at the mouth of the Witham explains its speedy rise into importance. King John by charter of 1204 granted the bailliff of Boston sole jurisdiction in the town. By the 13th century it was a great commercial centre second only to London in paying £780 for two years to the fifteenth levied in 1205, and Edward III. made it a staple port for wool in 1369. The Hanseatic and Flemish merchants largely increased its prosperity, but on the withdrawal of the Hanseatic League about 1470 and the break-up of the gild system Boston's prosperity began to wane, and for some centuries it remained almost without trade. Nevertheless it was raised to the rank of a free borough by Henry VIII.'s charter of 1546, confirmed by Edward VI. in 1547, by Mary in 1553, by Elizabeth (who granted a court of admiralty) in 1558 and 1573, and by James I. in 1608. Boston sent members to the great councils in 1337, 1352 and 1353; and from 1552 to 1885 two members were returned to each parliament. The Redistribution Act 1885 reduced the representation to one member. In 1257 a market was granted to the abbot of Crowland and in 1308 to John, earl of Brittany. The great annual mart was held before 1218 and attended by many German and other merchants. Two annual fairs and two weekly markets were granted by Henry VIII.'s charter, and are still held. The Great Mart survives only in the *Beast Mart* held on the 11th of December.

See *Fishey Thompson, History and Antiquities of Boston and the Hundred of Skirbeck* (Boston, 1856); George Jebb, *Guide to the Church of St Botolph, with Notes on the History of Boston; Victoria County History: Lincolnshire*.

BOSTON, the capital of the state of Massachusetts, U.S.A., in Suffolk county; lat. 42° 21' 27-6" N., long. 71° 3' 30" W. Pop. (1900) 560,892, (1917, 129 being foreign born); (1905, state census) 595,580; (1910), 670,585. Boston is the terminus of the Boston & Albany (New York Central), the Old Colony system of the New York, New Haven & Hartford, and the Boston & Maine railway systems, each of which controls several minor roads once in-

dependent. The city lies on Massachusetts bay, on what was once a pear-shaped peninsula attached to the mainland by a narrow, marshy neck, often swept by the spray and water. On the north is the Charles river, which widens here into a broad, originally much broader, inner harbour or back-bay. The surface of the peninsula was very hilly and irregular, the shore-line was deeply indented with coves, and there were salt marshes that fringed the neck and the river-channel and were left oozy by the ebbing tides. Until after the War of Independence the primitive topography remained unchanged, but it was afterwards subjected to changes greater than those effected on the site of any other American city. The area of the original Boston was only 783 acres, but by the filling in of tidal flats (since 1804) this was increased to 1829 acres; while the larger corporate Boston of the present day—including the annexed territories of South Boston (1804), Roxbury (1868), Charlestown, Dorchester, Brighton and West Roxbury (1874)—comprehends almost 43 sq. m. The beautiful Public Garden and the finest residential quarter of the city—the Back Bay, so called from that inner harbour from whose waters it was reclaimed (1856-1886)—stand on what was once the narrowest, but to-day is the widest and fairest portion of the original site. Whole forests, vast quarries of granite, and hills of gravel were used in fringing the water margins, constructing wharves, piers and causeways, redeeming flats, and furnishing piling and solid foundations for buildings. At the edge of the Common, which is now well within the city, the British troops in 1775 took their boats on the eve of the battle of Lexington; and the post-office, now in the very heart of the business section of the city, stands on the original shore-line. The reclaimed territory is level and excellently drained. The original territory still preserves to a large degree its irregularity of surface, but its hills have been much degraded or wholly razed. Beacon Hill, so called from its ancient use as a signal warning station, is still the most conspicuous topographical feature of the city, but it has been changed from a bold and picturesque eminence into a gentle slope. After the great fire of 1872 it became possible, in the reconstruction of the business district, to widen and straighten its streets and create squares, and so provide for the traffic that had long outgrown the narrow, crooked ways of the older city. Atlantic Avenue, along the harbour front, was created, and Washington Street, the chief business artery, was largely remade after 1866. It is probable that up to 1875, at least, there had been a larger outlay of labour, material and money, in reducing, levelling and reclaiming territory, and in straightening and widening thoroughfares¹ in Boston, than had been expended for the same purposes in all the other chief cities of the United States together. Washington Street, still narrow, is perhaps the most crowded and congested thoroughfare in America. The finest residence streets are in the Back Bay, which is laid out, in sharp contrast with the older quarters, in a regular, rectangular arrangement. The North End, the original city and afterwards the fashionable quarter, is now given over to the Jews and foreign colonies.

The harbour islands, three of which have been ceded to the United States for the purpose of fortification, are numerous, and render the navigation of the shipping channels difficult and easily guarded. Though tortuous of access, the channels afford a clear passage of 27-35 ft. since great improvements were undertaken by the national government in 1892, 1899, 1902 and 1907, and the harbour, when reached, is secure. It affords nearly 60 sq. m. of anchorage, but the wharf line, for lack of early reservation, is not so large as it might and should have been. The islands in the harbour, now bare, were for the most part heavily wooded when first occupied. It has been found impossible to afforest them on account of the roughness of the sea-air, and the wash from their bluffs into the harbour has involved large expense in the erection of sea-walls. Castle Island has been fortified since the earliest days; Fort Independence, on this island, and Forts Winthrop and Warren on neighbouring islands, constitute permanent harbour defences. The broad watercourses

¹ On the alteration of streets alone \$26,691,496 were expended from 1822 to 1880.

around the peninsula are spanned by causeways and bridges, East Boston only, that the harbours may be open to the navy-yard at Charlestown, being reached by ferry (1870), and by the electric subway under the harbour. At the Charlestown navy-yard (1800) there are docks, manufactories, foundries, machine-shops, ordnance stores, rope-walks, furnaces, casting-pits, timber-sheds, ordnance-parks, ship-houses, &c. The famous frigate "Independence" was launched here in 1814, the more famous "Constitution" having been launched while the yard was still private in 1797. The first bridge over the Charles, to Charlestown, was opened in 1786. The bridge of chief artistic merit is the Cambridge Bridge (1908), which replaced the old West Boston Bridge, and is one feature of improvements long projected for the beautifying of the Charles river basin.

Comparatively few relics of the early town have been spared by time and the improvements of the modern city. Three cemeteries remain intact—King's chapel burying ground, with the graves of John Winthrop and John Cotton; the Old Granary burial ground in the heart of the city, where Samuel Sewall, the parents of Franklin, John Hancock, James Otis and Samuel Adams are buried; and Copp's Hill burial ground, containing the tombs of the Mathers. Christ church (1723) is the oldest church of the city; in its tower the signal lanterns were displayed for Paul Revere on the night of the 18th of April 1775. The Old South church (1730-1782), the old state house (1748, restored 1882), and Faneuil Hall (1762-1763, enlarged 1805, reconstructed 1898) are rich in memorable associations of the period preceding the War of Independence. The second was the seat of the royal government of Massachusetts during the provincial period, and within its walls from 1760 to 1775 the questions of colonial dependence or independence probably first came into evident conflict. The Old South church has many associations; it was, for instance, the meeting-place of the people after the "Boston Massacre" of 1770, when they demanded the removal of the British troops from the city; and here, too, were held the meetings that led up to the "Boston Tea Party" of 1773. Faneuil Hall (the original hall of the name was given to the city by Peter Faneuil, a Huguenot merchant, in 1742) is associated, like the Old South, with the patriotic oratory of revolutionary days and is called "the cradle of American liberty." Its association with reform movements and great public issues of later times is not less close and interesting.¹ The adjoining Quincy market may be mentioned because its construction (1826) was utilized to open six new streets, widen a seventh, and secure flats, docks and wharf rights—all without laying tax or debt upon the city. The original King's chapel (1688, present building 1749-1754) was the first Episcopal church of Boston, which bitterly resented the action of the royal governor in 1687 in using the Old South for the services of the Church of England. The new state house, the oldest portion of which (designed by Charles Bulfinch) was erected in 1795-1798, was enlarged in 1853-1856, and again by a huge addition in 1889-1898 (total cost about \$6,800,000 to 1900). Architecturally, everything is subordinated to a conformity with the style of the original portion; and its gilded dome is a conspicuous landmark. Other buildings of local importance are the city hall (1865); the United States government building (1871-1878, cost about \$6,000,000); the county court-house (1887-1893, \$2,250,000); the custom-house (1837-1848); and the chamber of commerce (1892).

Copley Square, in the Back Bay, is finely distinguished by a group of exceptional buildings: Trinity church, the old Museum of Fine Arts, the public library and the new Old South church. Trinity (1877, cost \$800,000), in yellowish granite with dark sandstone trimmings, the masterpiece of H. H. Richardson, is built in the Romanesque style of southern France; it is a Latin cross surmounted by a massive central tower, with smaller towers and an adjacent chapel reached by open cloisters that distribute the balance (see ARCHITECTURE, Plate XVI. fig. 137). It has windows by La Farge, William Morris, Burne-Jones and others.

¹ Faneuil Hall is the headquarters of the Ancient and Honourable Artillery Company of Boston, the oldest military organization of the country, organized in 1638.

The library (1888-1895; cost \$2,486,000, exclusive of the site, given by the state) is a dignified, finely proportioned building of pinkish-grey stone, built in the style of the Italian Renaissance, suggesting a Florentine palace. It has an imposing exterior (see ARCHITECTURE, Plate XVI. fig. 135), a beautiful inner court, and notable decorative features and embellishments, including bronze doors by D. C. French, a statue of Sir Henry Vane by Macmonnies, a fine staircase in Siena marble, some characteristic decorative panels by Puvis de Chavannes (illustrating the history of science and literature), and other notable decorative paintings by John S. Sargent (on the history of religion), Edwin A. Abbey (on the quest of the Holy Grail). The old Museum of Fine Arts (1876) is a red brick edifice in modern Gothic style, with trimmings of light stone and terra-cotta. The new Old South (the successor of the Old South, which is now a museum) is a handsome structure of Italian Gothic style, with a fine campanile. The dignified buildings of the Massachusetts Institute of Technology are near. In Huntington Avenue, at its junction with Massachusetts Avenue, is another group of handsome new buildings, including Horticultural Hall, Symphony Hall (1900) and the New England Conservatory of Music. In the Back Bay Fens, reclaimed swamps laid out by F. L. Olmsted, still other groups have formed—among others those of the marble buildings of the Harvard medical school; Fenway Court, a building in the style, internally, of a Venetian palace, that houses the art treasures of Mrs. J. L. Gardner, and Simmons College. Here, too, is the new building (1908) of the Museum of Fine Arts. Throughout the Fens excellently effective use is being made of monumental buildings grouped in ample grounds.

Boston compares favourably with other American cities in the character of its public and private architecture. The height of buildings in the business section is limited to 125 ft., and in some places to 90 ft.

One of the great public works of Boston is its subway for electric trams, about 3 m. long, in part with four tracks and in part with two, constructed since 1895 at a cost of about \$7,500,000 up to 1905. The branch to East Boston (1900-1904) passes beneath the harbour bed and extends from Scollay Square, Boston, to Maverick Square, East Boston; it was the first all-cement tunnel (diameter, 23.6 ft.) in the world. The subway was built by the city, but leased and operated by a private company on such terms as to repay its cost in forty years. Another tunnel has been added to the system, under Washington Street. The narrow streets and the traffic congestion of the business district presented difficult problems of urban transit, but the system is of exceptional efficiency. There is an elevated road whose trains, like the surface cars, are accommodated in the centre of the city by the subway. All the various roads—surface, elevated (about 7 m., built 1896-1901), and subway—are controlled, almost wholly, by one company. They all connect and interchange passengers freely; so that the ordinary American five-cent fare enables a passenger to travel between almost any two points over an area of 100 sq. m. The two huge steam-railway stations of the Boston & Maine and the Boston & Albany systems also deserve mention. The former (the North, or Union station, 1893) covers 9 acres and has 23 tracks; the latter (the South Terminal, 1898), one of the largest stations in the world, covers 13 acres and has 32 tracks, and is used by the Boston & Albany and by the New York, New Haven & Hartford railways.

A noteworthy feature of the metropolitan public water service was begun in 1896 in the Wachusett lake reservoir at Clinton, on the Nashua river. The basin here excavated by ten years of labour, lying 385 ft. above high-tide level of Boston harbour, has an area of 6.5 sq. m., an average depth of 46 ft., and a capacity of 63,068,000,000 gallons of water. It is the largest municipal reservoir in the world,² yet

² The dam is 1250 ft. long, with a maximum height of 129 ft., only 750 ft. having a depth of more than 40 ft. from high water to rock. The entire surface of the basin was scraped to bed rock, sand or mineral earth, this alone costing \$3,000,000. Connected with the reservoir is an aqueduct, of which 2 m. are tunnel and 7 m. covered masonry. The metropolitan system as planned in 1905 for the near future contemplated storage for 80,000,000,000 gallons,

it is only part of a system planned for the service of the metropolitan area.

The park system is quite unique among American cities. The Common, a park of 48 acres, in the centre of the city, has been a public reservation since 1634, and no city park in the world is cherished more affectionately for historical associations. Adjoining it is the Public Garden of 24 acres (1859), part of the made area of the city. Commonwealth Avenue, one of the Back Bay streets running from the foot of the Public Garden, is one of the finest residence streets of the country. It is 240 ft. wide, with four rows of trees shading the parking of its central mall, and is a link through the Back Bay Fens with the beautiful outer park system. The park system consists of two concentric rings, the inner being the city system proper, the outer the metropolitan system undertaken by the commonwealth in co-operation with the city. The former has been laid out since 1875, and includes upwards of 2300 acres, with more than 100 m. of walks, drives and rides. Its central ornament is Franklin Park (527 acres). The metropolitan system, which extends around the city on a radius of 10 to 12 m., was begun in 1893. It embraces over 10,000 acres, including the Blue Hill reservation (about 5000 acres), the highest land in eastern Massachusetts, a beautiful reservation of forest, crag and pond known as Middlesex Fells, two large beach bath reservations on the harbour at Revere and Hull (Nantasket), and the boating section of the Charles river. At the end of 1907 more than \$13,000,000 had been expended on the system. Including the local parks of the cities and towns of the metropolitan district there are over 17,000 acres of pleasure grounds within the metropolitan park district. Boston was the pioneer municipality of the country in the establishment of open-air gymnasiums. A great improvement, planned for many years, was brought nearer by the completion of the new Cambridge Bridge. This improvement was projected to include the damming of the Charles river, and the creation of a great freshwater basin, with drive-ways of reclaimed land along the shores, and other adornments, somewhat after the model of the Alster basins at Hamburg.

Art and Literature.—The Museum of Fine Arts was founded in 1870 (though there were art exhibits collected from 1826 onward) and its present building was erected in 1908. It has one of the finest collections of casts in existence, a number of original pieces of Greek statuary, the second-best collection in the world of Aretine ware, the finest collection of Japanese pottery, and probably the largest and finest of Japanese paintings in existence. Among the memorials to men of Massachusetts (a large part of them Bostonians) commemorated by monuments in the Common, the Public Garden, the grounds of the state house, the city hall, and other public places of the city, are statues of Charles Sumner, Josiah Quincy and John A. Andrew by Thomas Ball; of Generals Joseph Hooker and William F. Bartlett, and of Rufus Choate by Daniel C. French; of W. L. Garrison and Charles Devens by Olin L. Warner; of Samuel Adams by Anne Whitney; of John Winthrop and Benjamin Franklin by R. S. Greenough; of Edward Everett (W. W. Story), Colonel W. Prescott (Story), Horace Mann (E. Stebbins), Daniel Webster (H. Powers), W. E. Channing (H. Adams), N. P. Banks (H. H. Kitson), Phillips Brooks (A. St Gaudens), and J. B. O'Reilly (D. C. French).

Among other important monuments are a group by J. Q. A. Ward commemorating the first proof of the anaesthetic properties of ether, made in 1846 in the Massachusetts General Hospital by Dr W. T. G. Morton; an emancipation group of Thomas Ball with a portrait statue of Lincoln; a fine equestrian statue, by the same sculptor, of Washington, one of the best works in the country (1869); an army and navy monument in the Common by Martin Millmore, in memory of the Civil War; another (1888) recording the death of those who fell in the Boston Massacre of 1770; statues of Admiral D. G. Farragut (H. H. Kitson), Leif Ericson (Anne Whitney), and Alexander

Hamilton (W. Rimmer); and a magnificent bronze bas-relief (1897) by Augustus St Gaudens commemorating the departure from Boston of Colonel Robert G. Shaw with the first regiment of negro soldiers enlisted in the Civil War. There is an art department of the city government, under unpaid commissioners, appointed by the mayor from candidates named by local art and literary institutions; and without their approval no work of art can now become the property of the city.

The public library, containing 922,348 volumes in January 1908, is the second library of the country in size, and is the largest free circulating library in the world (circulation 1907, 1,529,111 volumes). There was a public municipal library in Boston before 1674—probably in 1653; but it was burned in 1747 and was apparently never replaced. The present library (antedated by several circulating, social and professional collections) may justly be said to have had its origin in the efforts of the Parisian, Alexandre Vattemare (1796-1864), from 1830 on, to foster international exchanges. From 1847 to 1851 he arranged gifts from France to American libraries aggregating 30,655 volumes, and a gift of 50 volumes by the city of Paris in 1843 (reciprocated in 1849 with more than 1000 volumes contributed by private citizens) was the nucleus of the Boston public library. Its legal foundation dates from 1848. Among the special collections are the George Ticknor library of Spanish and Portuguese books (6393 vols.), very full sets of United States and British public documents, the Bowditch mathematical library (7090 vols.), the Galatea collection on the history of women (2193 vols.), the Barton library, including one of the finest existing collections of Shakespeariana (3309 vols., beside many in the general library), the A. A. Brown library of music (9886 vols.), a very full collection on the anthropology and ethnology of Europe, and more than 100,000 volumes on the history, biography, geography and literature of the United States. The library is supported almost entirely by municipal appropriations, though holding also considerable trust funds (\$388,742 in 1905). The other notable book-collections of the city include those of the Athenaeum, founded in 1807 (about 230,000 vols. and pamphlets), the Massachusetts Historical Society (founded 1791; 50,300), the Boston medical library (founded 1874; about 80,000), the New England Historic-Genealogical Society (founded 1845; 33,750 volumes and 34,150 pamphlets), the state library (founded 1826; 140,000), the American Academy of Arts and Sciences (founded 1780; 30,000), the Boston Society of Natural History (founded 1830; about 35,000 volumes and 27,000 pamphlets).

The leading educational institutions are the Massachusetts Institute of Technology, the largest purely scientific and technical school in the country, opened to students (including women) in 1865, four years after the granting of a charter to Prof. W. B. Rogers, the first president; Boston University (chartered in 1869; Methodist Episcopal; co-educational); the New England Conservatory of Music (co-educational; private; 1867, incorporated 1880), the largest in the United States, having 2400 students in 1905-1906; the Massachusetts College of Pharmacy (1852); the Massachusetts Normal Art School (1873); the School of Drawing and Painting (1876) of the Museum of Fine Arts; Boston College (1860), Roman Catholic, under the Society of Jesus; St John's Theological Seminary (1880), Roman Catholic; Simmons College (1899) for women, and several departments of Harvard University. The Institute of Technology has an exceptional reputation for the wide range of its instruction and its high standards of scholarship. It was a pioneer in introducing as a feature of its original plans laboratory instruction in physics, mechanics and mining. The architects of the United States navy are sent here for instruction in their most advanced courses. Boston University was endowed by Isaac Rich (1801-1872), a Boston fish-merchant, Lee Claflin (1791-1871), a shoe manufacturer and a benefactor of Wesleyan University and of Wilbraham Seminary, and Jacob Sleeper. It has been co-educational from the beginning. Its faculties of theology—founded in 1821 at Newbury, Vt., as the Biblical Institute; in 1847-1867 in Concord, N.H.; and in 1867-1871 the Boston Theological Seminary—law, music, medicine, liberal

arts and agriculture (at Amherst, in association with the Massachusetts Agricultural College), all antedate 1876. The funds for Simmons College were left by John Simmons in 1870, who wished to found a school to teach the professions and "branches of art, science and industry best calculated to enable the scholars to acquire an independent livelihood." The Lowell Institute (*q.v.*), established in 1839 (by John Lowell, Jr., who bequeathed \$137,000 for the purpose), provides yearly courses of free public lectures, and its lecturers have included many of the leading scholars of America and Europe. During each winter, also, a series of public lectures on American history is delivered in the Old South meeting house. The public schools, particularly the secondary schools, enjoy a very high reputation. The new English High and Latin school, founded in 1635, is the oldest school of the country. A girls' Latin school, with the same standards as the boys' school, was established in 1878 (an outcome of the same movement that founded Radcliffe College). There are large numbers of private schools, in art, music and academic studies.

In theatrical matters Boston is now one of the chief American centres. The Federal Street theatre—the first regular theatre—was established in 1794, the old Puritan feeling having had its natural influence in keeping Boston behind New York and Philadelphia in this respect. The dramatic history of the city is largely associated with the Boston Museum, built in 1841 by Moses Kimball on Tremont Street, and rebuilt in 1846 and 1880; here for half a century the principal theatrical performances were given (see an interesting article in the *New England Magazine*, June 1903), in later years under the management of R. Montgomery Field, until in 1903 the famous Boston Museum was swept away, as other interesting old places of entertainment (the old Federal Street theatre, the Tremont theatre, &c.) had been, in the course of further building changes. The Boston theatre dates from 1854, and there were seventeen theatres altogether in 1900.

As a musical centre Boston rivals New York. Among musical organizations may be mentioned the Handel and Haydn Society (1811), the Harvard Musical Association (1837), the Philharmonic (1880) and the Symphony Orchestra, organized in 1881 by the generosity of Henry Lee Higginson. This orchestra has done much for music not only in Boston but in the United States generally. In 1908 the Boston Opera Company was incorporated, and an opera house has been erected on the north side of Huntington Avenue.

Boston was the undisputed literary centre of America until the later decades of the 19th century, and still retains a considerable and important colony of writers and artists. Its ascendancy was identical with the long predominance of the New England literary school, who lived in Boston or in the country round about. Two Boston periodicals (one no longer so) that still hold an exceptional position in periodical literature, the *North American Review* (1815) and the *Atlantic Monthly* (1857), date from this period. The great majority of names in the long list of worthies of the commonwealth—writers, statesmen, orators, artists, philanthropists, reformers and scholars, are intimately connected with Boston. Among the city's daily newspapers the *Boston Herald* (1846), the *Boston Globe*, the *Evening Transcript* (1830), the *Advertiser* (1813) and the *Post* (1831) are the most important.

Industry and Commerce.—Boston is fringed with wharves. Commercial interests are largely concentrated in East Boston. Railway connexion with Worcester, Lowell and Providence was opened in 1835; with Albany, N.Y., and thereby with various lines of interior communication, in 1841 (double track, 1868); with Fitchburg, in 1845; and in 1851 connexion was completed with the Great Lakes and Canada. In 1840 Boston was selected as the American terminus of the Cunard Line, the first regular line of trans-Atlantic steamers. The following decade was the most active of the city's history as regards the ocean carrying trade. Boston ships went to all parts of the globe. The Cunard arrangement was the first of various measures that worked for a commercial rapprochement between the New England states and Canada, culminating in the reciprocity treaty

of 1854, and Boston's interests are foremost to-day in demanding a return to relations of reciprocity. Beginning about 1855 the commerce of the port greatly declined. The Cunard service has not been continuous. In 1866 there was not one vessel steaming directly for Europe; in 1900 there were 973 for foreign ports. Great improvements of the harbour were undertaken in 1902 by the United States government, looking to the creation of two broad channels 35 ft. deep. Railway rates have also been a matter of vital importance in recent years; Boston, like New York, complaining of discriminations in favour of Philadelphia, Baltimore, New Orleans and Galveston. Boston also feels the competition of Montreal and Portland; the Canadian roads being untrammelled in the matter of freight differentials. Boston is the second import port of the United States, but its exports in 1907 were less than those of Philadelphia, of Galveston, or of New Orleans. The total tonnage in foreign trade entering and leaving in 1907 was 5,148,429 tons; and in the same year 9616 coasting vessels (tonnage, 10,261,474) arrived in Boston. The value of imports and exports for 1907 were respectively \$123,414,168 and \$104,610,908. Fibres and vegetable grasses, wool, hides and skins, cotton, sugar, iron and steel and their manufactures, chemicals, coal, and leather and its manufactures are the leading imports; provisions, leather and its manufactures, cotton and its manufactures, breadstuffs, iron and steel and their manufactures are the leading exports. In the exportation of cattle, and of the various meat and dairy products classed as provisions, Boston is easily second to New York. It is the largest wool and the largest fish market of the United States, being in each second in the world to London only.

Manufacturing is to-day the most distinctive industry, as was commerce in colonial times. The value of all manufactured products from establishments under the "factory system" in 1900 was \$162,764,523; in 1905 it was \$184,351,163. Among the leading and more distinctive items were printing and publishing (\$21,023,855 in 1905); sugar and molasses refining (\$15,746,547 in 1900; figures not published in 1905 because of the industry being in the hands of a single owner); men's clothing (in 1900, \$3,609,475; in 1905, \$11,246,004); women's clothing (in 1900, \$3,258,483; in 1905, \$5,705,470); boots and shoes (in 1900, \$3,882,655; in 1905, \$5,575,927); boot and shoe cut stock (in 1905, \$5,211,445); malt liquors (in 1900, \$7,518,668; in 1905, \$6,715,215); confectionery (in 1900, \$4,455,184; in 1905, \$6,210,023); tobacco products (in 1900, \$3,504,603; in 1905, \$4,592,698); pianos and organs (\$3,670,771 in 1905); other musical instruments and materials (in 1905, \$231,780); rubber and elastic goods (in 1900, \$3,139,783; in 1905, \$2,887,323); steam fittings and heating apparatus (in 1900, \$2,876,327; in 1905, \$3,354,020); bottling, furniture, &c. Art tiles and pottery are manufactured in Chelsea. Shipbuilding and allied industries early became of great importance. The Waltham watch and the Singer sewing-machine had their beginning in Boston in 1850. The making of the Chickering pianos goes back to 1823, and of Mason & Hamlin reed organs to 1854; these are to-day very important and distinctive manufactures of the city. The ready-made clothing industry began about 1830.

Government.—Beyond a recognition of its existence in 1630, when it was renamed, Boston can show no legal incorporation before 1822; although the uncertain boundaries between the powers of colony and township prompted repeated petitions to the legislature for incorporation, beginning as early as 1650. In 1822 Boston became a city. Thus for nearly two centuries it preserved intact its old "town" government, disposing of all its affairs in the "town-meeting" of its citizens. Excellent political training such a government unquestionably offered; but it became unworkable as disparities of social condition increased, as the number of legal voters (above 7000 in 1822) became greater, and as the population ceased to be homogeneous in blood. All the citizens did not assemble; on the contrary ordinary business seldom drew out more than a hundred voters, and often a mere handful. From very early days executive officers known as "select-men," constables, clerks of markets, hog reeves, packers of meat and fish, &c., were chosen; and the

select-men, particularly, gained power as the attendance of the freemen on meetings grew onerous. Interested cliques could control the business of the town-meeting in ordinary times, and boisterousness marred its democratic excellence in exciting times. Large sums were voted loosely, and expended by executive boards without any budgetary control. The whole system was full of looseness, complexity and makeshifts. But the tenacity with which it was clung to, proved that it was suited to the community; and whether helpful or harmful to, it was not inconsistent with, the continuance of growth and prosperity. Various other Massachusetts townships, as they have grown older, have been similarly compelled to abandon their old form of government. The powers of the old township were much more extensive than those of the present city of Boston, including as they did the determination of the residence of strangers, the allotment of land, the grant of citizenship, the fixing of wages and prices, of the conditions of lawsuits and even a voice in matters of peace and war. The city charter was revised in 1854, and again reconstructed in important particulars by laws of 1885 separating the executive and legislative powers, and by subsequent acts. A complete alteration of the government has indeed been effected since 1885. Boston proper is only the centre of a large metropolitan area, closely settled, with interests in large part common. This metropolitan area, within a radius of approximately 10 m. about the state house, contained in 1900 about 40% of the population of the state. In the last two decades of the 19th century the question of giving to this greater city some general government, fully consolidated or of limited powers, was a standing question of expediency. The commonwealth has four times recognized a community of metropolitan interests in creating state commissions since 1882 for the union of such interests, beginning with a metropolitan health district in that year. The metropolitan water district (1895) included in 1908 Boston and seventeen cities or townships in its environs; the metropolitan sewerage district (1889) twenty four; the park service (1893) thirty-nine. Local sentiment was firmly against complete consolidation. The creation of the state commissions, independent of the city's control, but able to commit the city indefinitely by undertaking expensive works and new debt, was resented. Independence is further curtailed by other state boards semi-independent of the city—the police commission of three members from 1885 to 1906, and in 1906 a single police commissioner, appointed by the governor, a licensing board of three members, appointed by the governor; the transit commission, &c. There are, further, county offices (Suffolk county comprises only Boston, Chelsea, Revere and Winthrop), generally independent of the city, though the latter pays practically all the bills.

A new charter went into effect in 1910. It provided for municipal elections in January; for the election of a mayor for four years; for his recall at the end of two years if a majority of the registered voters so vote in the state election in November in the second year of his term; for the summary removal for cause by the mayor of any department head or other of his appointees, for a city council of one chamber of nine members, elected at large each for three years; for nomination by petition; for a permanent finance commission appointed by the governor; for the confirmation of the mayor's appointments by the state civil service commission; for the mayor's preparation of the annual budget (in which items may be reduced but not increased by the council), and for his absolute veto of appropriations except for school use. The school committee (who serve gratuitously) appoint the superintendent and supervisors of schools. The number of members of the school-board was in 1905 reduced from twenty-four to five, elected by the city at large, and serving for one, two or three years; at the same time power was centralized in the hands of the superintendent of schools. Civil service reform principles cover the entire municipal administration. The city's work is done under an eight-hour law.

An analysis of city election returns for the decade 1800-1809 showed that the interest of the citizens was greatest in the choice

of a president; then, successively, in the choice of a mayor, a governor, the determination of liquor-license questions by referendum, and the settlement of other referenda. On 21 referenda, 10 being questions of license, the ratio of actual to registered voters ranged on the latter from 57.00 to 75.38% (mean 67.15), and on other referenda from 75.63 to 33.40 (mean 61.39),—the mean for all, 64.18. But the average of two presidential votes was 85.37%; and the maxima, minima and means for mayors and governors were respectively 83.86, 74.99, 78.36 and 84.73, 61.78, 75.72. Of those who might, only some 50 to 65% actually register. Women vote for school committees (categories as above, 95.18, 59.62, 76.49%). On a referendum in 1895 on the expediency of granting municipal suffrage to women only 59.08% of the women who were registered voted, and probably less than 10% of those entitled to be registered.

Hospitals, asylums, refuges and homes, pauper, reformatory and penal institutions, flower missions, relief associations, and other charitable or philanthropic organizations, private and public, number several hundreds. The Associated Charities is an incorporated organization for systematizing the various charities of the city. The Massachusetts general hospital (1811-1821)—with a branch for mental and nervous diseases, McLean hospital (1816), in the township of Belmont (post-office, Waverley) about 6 m. W.N.W. of Boston; the Perkins Institution and Massachusetts school for the blind (1832), famous for its conduct by Samuel C. Howe, and for association with Laura Bridgman and Helen Keller; the Massachusetts school for idiotic and feeble-minded children (1839); and the Massachusetts charitable eye and ear infirmary (1824), all receive financial aid from the commonwealth, which has representation in their management. The city hospital dates from 1864. A floating hospital for women and children in the summer months, with permanent and transient wards, has been maintained since 1804 (incorporated 1901). Boston was one of the first municipalities of the country to make provision for the separate treatment of juvenile offenders; in 1906 a juvenile court was established. A People's Palace dedicated to the work of the Salvation Army, and containing baths, gymnasium, a public hall, a library, sleeping-rooms, an employment bureau, free medical and legal bureaus, &c., was opened in 1906. Simmons College and Harvard University maintain the Boston school for social workers (1904). Beneficent social work out of the more usual type is directed by the music and bath departments of the city government. In the provision of public gymnasiums and baths (1866) Boston was the pioneer city of the country, and remains the most advanced. The beach reservations of the metropolitan park system at Revere and Nantasket, and several smaller city beaches are a special feature of this service. Benjamin Franklin, who was born and spent his boyhood in Boston, left £1000 to the city in his will; it amounted in 1905 to \$403,000, and constituted a fund to be used for the good of the labouring class of the city.

Largely owing to activity in public works Boston has long been the most expensively governed of American cities. The average yearly expenditure for ten years preceding 1904 was \$27,354,416, exclusive of payments on funded and floating debts. The running expenses *per capita* in 1900 were \$35.23; more than twice the average of 86 leading cities of the country (New York, \$23.92; Chicago, \$11.62). Schools, police, charities, water, streets and parks are the items of heaviest cost. The cost of the public schools for the five years from 1901-1902 to 1906-1907 was \$27,883,937, of which \$7,057,895.42 was for new buildings; the cost of the police department was \$11,387,314.66 for the six years 1902-1907; and of the water department \$4,941,343.37 for the six years 1902-1907; of charities and social work a much larger sum. The re-making of the city was enormously expensive, especially the alteration of the streets after 1866, when the city received power to make such alterations and assess a part of the improvements upon abutting estates. The creation of the city water-system has also been excessively costly, and the total cost up to the 31st of January 1908 of the works remaining to the city after the creation of the metropolitan board in 1898 was about \$17,000,000. The metropolitan water board—of whose expenditures Boston bears only a share—expended from 1895 to 1900 \$20,693,870; and the system was planned to consume finally probably 40 millions at least. The city park

system proper had cost \$16,627,033 up to 1899 inclusive; and the metropolitan parks \$13,679,456 up to 1907 inclusive. There are no municipal lighting-plants; but the companies upon which the city depends for its service are (with all others) subject to the control of a state commission. In 1885 a state law placed a limit on the contractable debt and upon the taxation rate of the city. Revenues were not realized adequate to its lavish undertakings, and loans were used to meet current expenses. The limits were altered subsequently, but the net debt has continued to rise. In 1822 it was \$100,000; in 1850, \$6,195,144; in 1886, \$2,712,820; in 1904, \$8,216,725; in 1907, \$7,781,569 (gross debt, \$104,206,706)—this included the debt of Suffolk county which in 1907 was \$3,517,000. The chief objects for which the city debt was created were in 1907, in millions of dollars: highways, 24.07, parks, 16.29, drainage and sewers, 15.05, rapid transit, 13.57 and water-works, 4.53. Boston paid in 1907 36 3/8 % of all state taxes, and about 33, 62, 47 and 79 % respectively of the assessments for the metropolitan sewer, parks, boulevards and water services. About a third of its revenue goes for such uses or for Suffolk county expenditures over which it has but limited control. The improvement of the Back Bay and of the South Boston flats was in considerable measure forced upon the city by the commonwealth. The debt per capita is as high as the cost of current administration relatively to other cities. The average interest rate on the city obligations in 1907 was about 3.7 %. The city's tax valuation in 1907 was \$1,313,471,556 (in 1822, \$42,140,200; in 1850, \$180,000,500), of which only \$242,606,856 represented personality; although in the judgment of the city board of trade such property cannot by any possibility be inferior in value to reality.

Population.—Up to the War of Independence the population was not only American, but it was in its ideas and standards essentially Puritan; modern liberalism, however, has introduced new standards of social life. In 1900 35.1 % of the inhabitants were foreign-born, and 72.2 % wholly or in part of foreign parentage. Irish, English-Canadian, Russian, Italian, English and German are the leading races. Of the foreign-born population these elements constituted respectively 35.6, 24.0, 7.6, 7.0, 6.7 and 5.3 %. Large foreign colonies, like adjoining but unmixing nations, divide among themselves a large part of the city, and give to its life a cosmopolitan colour of varied speech, opinion, habits, traditions, social relations and religions. Most remarkable of all, the Roman Catholic churches, in this stronghold of exiled Puritanism where Catholics were so long under the heavy ban of law, outnumber those of any single Protestant denomination; Irish Catholics dominate the politics of the city, and Protestants and Catholics have been aligned against each other on the question of the control of the public schools. Despite, however, its heavy foreign admixture the old Americanism of the city remains strikingly predominant. The population of Boston at the end of each decennial period since 1790 was as follows:—(1790), 18,320; (1800), 24,937; (1810), 33,787; (1820), 43,298; (1830), 61,392; (1840), 93,383; (1850), 136,881; (1860), 177,840; (1870), 250,526; (1880), 362,839; (1890), 448,477; (1900), 560,892.

History.—John Smith visited Boston Harbour in 1614, and it was explored in 1621 by a party from Plymouth. There were various attempts to settle about its borders in the following years before John Endecott in 1628 landed at Salem as governor of the colony of Massachusetts bay, within which Boston was included. In June 1630 John Winthrop's company reached Charlestown. At that time a "bookish recluse," William Blaxton (Blackstone), one of the several "old planters" scattered about the bay, had for several years been living on Boston peninsula. The location seemed one suitable for commerce and defence, and the Winthrop party chose it for their settlement. The triple summit of Beacon Hill, of which no trace remains to-day (or possibly a reference to the three hills of the then peninsula, Beacon, Copp's and Fort) led to the adoption of the name Trimountaine for the peninsula,—a name perpetuated variously in present municipal nomenclature as in Tremont; but on the 17th of September 1630, the date adopted for anniversary celebrations, it was ordered that "Trimountaine shall be called Boston," after the borough of that name in Lincolnshire, England, of which several of the leading settlers had formerly been prominent citizens.¹

¹ In 1851 the mayor of the English Boston sent over a copy of that city's seals, framed in oak from St Botolph's church, of which John Cotton, the famous Boston divine (he came over in 1633) had been vicar. The seals now hang in the city hall. In 1855 a number of

For several years it was uncertain whether Cambridge, Charlestown or Boston should be the capital of the colony, but in 1632 the General Court agreed "by general consent, that Boston is the fittest place for public meetings of any place in the Bay." It rapidly became the wealthiest and most populous. Throughout the 17th century its history is so largely that of Massachusetts generally that they are inseparable. Theological systems were largely concerned. The chief features of this epoch—the Antinomian dissensions, the Quaker and Baptist persecutions, the witchcraft delusion (four witches were executed in Boston, in 1648; 1651, 1656, 1688) &c.—are referred to in the article MASSACHUSETTS (q.v.). In 1692 the first permanent and successful printing press was established; in 1704 the first newspaper in America, the *Boston News-Letter*, which was published weekly until 1776. Puritanism steadily mellowed under many influences. By the turn of the first century bigotry was distinctly weakened. Among the marks of the second half of the 17th century was growing material prosperity, and there were those who thought their fellows unduly willing to relax church tests of fellowship when good trade was in question. There was an unpleasant Englishman who declared in 1699 that he found "Money Their God, and Large Possessions the only Heaven they Covet." Prices were low, foreign commerce was already large, business thriving; wealth gave social status; the official British class lent a lustre to society; and Boston "town" was drawing society from the "country." Of the two-score or so of families most prominent in the first century hardly one retained place in the similar list for the early years of the second. Boston was a prosperous, thrifty, English country town, one traveller thought. Another, Daniel Neal, in 1720, found Boston conversation "as polite as in most of the cities and towns in England, many of their merchants having the advantage of a free conversation with travellers; so that a gentleman from London would almost think himself at home at Boston, when he observes the number of people, their houses, their furniture, their tables, their dress and conversation, which perhaps is as splendid and showy as that of the most considerable tradesmen in London."

The population, which was almost stationary through much of the century, was about 20,000 in the years immediately before the War of Independence. At this time Boston was the most flourishing town of North America. It built ships as cheaply as any place in the world, it carried goods for other colonies, it traded—often evading British laws—with Europe, Guinea, Madagascar and above all with the West Indies. The merchant princes and social leaders of the time are painted with elaborate show of luxury in the canvases of Copley. The great English writers of Queen Anne's reign seem to have been but little known in the colony, and the local literature, though changed somewhat in character, showed but scant improvement. About the middle of the century restrictions upon the press began to disappear. At the same time questions of trade, of local politics, finally of colonial autonomy, of imperial policy, had gradually, but already long since, replaced theology in leading interest. In the years 1760–1776 Boston was the most frequently recurring and most important name in British colonial history. Sentiments of limited independence of the British government had been developing since the very beginning of the settlement (see MASSACHUSETTS), and their strength in 1680 had been strikingly exhibited in the local revolution of that year, when the royal governor, Sir Edmund Andros, and other high officials, were frightened into surrender and were imprisoned. This movement, it should be noted, was a popular rising, and not the work of a few leaders.

The incidents that marked the approach of the War of Independence need barely be adverted to. Opposition to the measures of the British government for taxing and oppressing the colonies began in Boston. The argument of Otis on the writs of assistance

Americans, including Charles Francis Adams and Edward Everett, and also various descendants of Cotton, united to restore the south-west chapel of St Botolph's church, and to erect in it a memorial tablet to Cotton's memory. The total amount raised by subscription for this purpose was £673.

was in 1760-1761. The Stamp Act, passed in 1765, was repealed in 1766; it was opposed in Boston by a surprising show of determined and unified public sentiment. Troops were first quartered in the town in 1768. In 1770, on the 5th of March, in a street brawl, a number of citizens were killed or wounded by the soldiers, who fired into a crowd that were baiting a sentry. This incident is known as the "Boston Massacre." The Tea Act of 1773 was defied by the emptying into the harbour of three cargoes of tea on the 16th of December 1773, by a party of citizens disguised as Indians, after the people in town-meeting had exhausted every effort, through a period of weeks, to procure the return of the tea-ships to England. To this act Great Britain replied by various penal regulations and reconstructive acts of government. She quartered troops in Boston; she made the juries, sheriffs and judges of the colony dependent on the royal officers; she ordered capital offenders to be tried in Nova Scotia or England; she endeavoured completely to control or to abolish town-meetings; and finally, by the so-called "Boston Port Bill," she closed the port of Boston on the 1st of June 1774. Not even a ferry, a scow or other boat could move in the harbour. Marblehead and Salem were made ports of entry, and Salem was made the capital. But they would not profit by Boston's misfortune. The people covenanted not to use British goods and to suspend trade with Great Britain. From near neighbours and from distant colonies came provisions and encouragement. In October 1774, when General Gage refused recognition to the Massachusetts general court at Salem, the members adjourned to Concord as the first provincial congress. Finally came war, with Lexington and Bunker Hill, and beleaguering by the colonial army; until on the 17th of March 1776 the British were compelled by Washington to evacuate the city. With them went about 1100 Tory refugees, many of them of the finest families of the city and province. The evacuation closed the heroic period of Boston's history. War did not again approach the city.

The years from 1776 to the end of "town" government in 1822 were marked by slow growth and prosperity. Commerce and manufactures alike took great impetus. Direct trade with the East Indies began about 1785, with Russia in 1787. A Boston vessel, the "Columbia" (Captain Robert Gray), opened trade with the north-west coast of America, and was the first American ship to circumnavigate the globe (1787-1790). In 1805 Boston began the export of ice to Jamaica, a trade which was gradually extended to Cuba, to ports of the southern states, and finally to Rio de Janeiro and Calcutta (1833), declining only after the Civil War; it enabled Boston to control the American trade of Calcutta against New York throughout the entire period. But of course it was far less important than various other articles of trade in the aggregate values of commerce. It was Boston commerce that was most sorely hurt by the embargo and non-importation policy of President Jefferson. In manufactures the foundation was laid of the city's wealth. In politics the period is characterized by Boston's connexion with the fortunes of the Federalist party. The city was warmly in favour of the adoption of the federal constitution of 1787, even Samuel Adams was rejected for Congress because he was backward in its support. It was the losses entailed upon her commerce by the commercial policy of Jefferson's administration that embittered Boston against the Democratic-Republican party and put her public men in the forefront of the opposition to its policies that culminated in lukewarmness toward the War of 1812, and in the Hartford Convention of 1814.

Some mention must be made of the Unitarian movement. Unitarian tendencies away from the Calvinism of the old Congregational churches were plainly evident about 1750, and it is said by Andrew P. Peabody (1811-1893) that by 1780 nearly all the Congregational pulpits around Boston were filled by Unitarians. Organized Unitarianism in Boston dates from 1785. In 1782 King's chapel (Episcopal) became Unitarian, and in 1805 one of that faith was made professor of divinity in Harvard. But the Unitarianism of those times, even the Unitarianism of Channing, was very different from that of to-day. Theodore

Parker and Channing have been the greatest leaders. The American Unitarian Association, organized in 1825, has always retained its headquarters in Boston. The theological and philosophical developments of the second quarter of the 19th century were characterized by the transcendental movement (see MASSACHUSETTS).

In the period from 1822 to the Civil War anti-slavery is the most striking feature of Boston's annals. Garrison established the *Liberator* in 1831; W. E. Channing became active in the cause of abolition in 1835, and Wendell Phillips a little later. In 1835 a mob, composed in part of wealthy and high-standing citizens, attacked a city-building, and dragged Garrison through the streets until the mayor secured his safety by putting him in gaol. But times changed. In 1850 a reception was given in Faneuil Hall in honour of the English anti-slavery leader, George Thompson, whose reported intention to address Bostonians in 1835 precipitated the riot of that year. In 1851 the Court House was surrounded with chains to prevent the "rescue" of a slave (Sims) held for rendition under the Fugitive Slave Law; another slave (Shadrach) was released this same year, and in 1854 there was a riot and intense excitement over the rendition of Anthony Burns. Boston had long since taken her place in the very front of anti-slavery ranks, and with the rest of Massachusetts was playing somewhat the same part as in the years before the War of Independence.

Later events of importance have already been indicated in essentials. On the 9th-10th of November 1872 a terrible fire swept the business part of the city, destroying hundreds of buildings of brick and granite, and inflicting a loss of some \$7,500,000. Within two years the whole area, solidly rebuilt and with widened and straightened streets, showed no traces of the ruin except an appearance superior in all respects to that presented before the fire. The expense of this re-creation probably duplicated, at least, the loss from the conflagration. Since this time there has been no set-back to the prosperity of the city. But it is not upon material prosperity that Boston rests its claims for consideration. It prides itself on its schools, its libraries, its literary traditions, its splendid public works and its reputation as the chief centre of American culture.

AUTHORITIES.—See the annual *City Documents*; also Justin Winsor (ed.) *The Memorial History of Boston, including Suffolk County . . . 1630-1880* (4 vols., Boston, 1880-1881), a work that covers every phase of the city's growth, history and life; S. A. Drake, *The History and Antiquities of . . . Boston* (2 vols., Boston, 1854; and later editions), and *Old Landmarks and Historic Personages of Boston* (Boston, 1873; and later editions); Josiah Quincy, *A Municipal History of . . . Boston . . . to . . . 1830* (Boston, 1852); C. W. Ernst, *Constitutional History of Boston* (Boston, 1894); H. H. Sprague, *City Government in Boston—its Rise and Development* (Boston, 1890); E. E. Hale, *Historic Boston and its Neighbourhood* (New York, 1898), and L. Swift, *Literary Landmarks of Boston* (Boston, 1903). A great mass of original historical documents have been published by the registry department of the city government since 1876 (34 v. to 1905). Boston has been described in many works of fiction, and the reader may be referred to the novels of E. L. Bynner, to L. Maria Childs' *The Rebels*, to J. F. Cooper's *Loeul Lincoln*, to the early novels of W. D. Howells (also those of Arlo Bates), to O. W. Holmes' *Poet and Autocrat*, and Hawthorne's *Scarlet Letter*, as pictures of Boston life at various periods since early colonial days.

BOSTON, a game of cards invented during the last quarter of the 18th century. It is said to have originated in Boston, Massachusetts, during the siege by the British. It seems to have been invented by the officers of the French fleet which lay for a time off the town of Marblehead, and the name of the two small islands in Marblehead harbour which have, from the period of the American Revolution, been called Great and Little Misery, correspond with expressions used in the game. William Tudor, in his *Letters on the Eastern States*, published in 1821, states somewhat differently that "A game of cards was invented in Versailles and called in honour of the town, Boston; the points of the game are allusive, 'great independence,' 'little independence,' 'great misery,' 'little misery,' &c. It is composed partly of whist and partly of quadrille, though partaking mostly of the former." The game enjoyed an extraordinary vogue in high French society, where it was the fashion at that time to admire

all things American. "The ladies . . . filled my pockets with bon-bons, and . . . called me '*le petit Bostonien*.' It was indeed by the name of Bostonian that all Americans were known in France then. The war having broken out in Boston and the first great battle fought in its neighbourhood, gave to that name universal celebrity. A game invented at that time, played with cards, was called 'Boston,' and is to this day (1830) exceedingly fashionable at Paris by that appellation" (*Recollections of Samuel Brock*, Philadelphia, 1877). There was a tradition that Dr Franklin was fond of the game and even that he had a hand in its invention. At the middle of the 19th century it was still popular in Europe, and to a less degree in America, but its favour has steadily declined since then.

The rules of Boston recognized in English-speaking countries differ somewhat from those in vogue in France. According to the former, two packs of 52 cards are used, which rank as in whist, both for cutting and dealing. Four players take part, and there are usually no partners. Counters are used, generally of three colours and values, and each hand is settled for as soon as finished. The entire first pack is dealt out by fours and fives, and the second pack is cut for the trump, the suit of the card turned being "first preference" the other suit of the same colour "second preference" or "colour," while the two remaining suits are "plain suits." The eldest hand then announces that he will make a certain number of tricks provided he may name the trump, or lose a certain number without trumps. The different bids are called by various names, but the usual ones are as follows:—To win five tricks, "Boston." (To win) "six tricks." (To win) "seven tricks." To lose twelve tricks, after discarding one card that is not shown, "little *misère*." (To win) "eight tricks." (To win) "nine tricks." To lose every trick, "grand *misère*." (To win) "ten tricks." (To win) "eleven tricks." To lose twelve tricks, after discarding one card that is not shown, the remaining twelve cards being exposed on the table but not liable to be called, "little spread." (To win) "twelve tricks." To lose every trick with exposed cards, "grand spread." To win thirteen tricks, "grand slam." If a player does not care to bid he may pass, and the next player bids. Succeeding players may "overcall," i.e. overbid, previous bidders. Players passing may thereafter bid only "*misères*." If a player bids seven but makes ten he is paid for the three extra tricks, but on a lower scale than if he had bid ten. If no bid should be made, a "*misère perious*" (general poverty) is often played, the trump being turned down and each player striving to take as few tricks as possible. Payments are made by each loser according to the value of the winner's bid and the overtricks he has scored. There are regular tables of payments. In America overtricks are not usually paid for. In French Boston the knave of diamonds arbitrarily wins over all other cards, even trumps. The names of the different bids remind one of the period of the American Revolution, including "Independence," "Philadelphia," "Souveraine," "Concordia," &c. Other variations of the game are *Boston de Fontainebleau* and Russian Boston.

BOSTONITE, in petrology, a fine-grained, pale-coloured, grey or pinkish rock, which consists essentially of alkali-felspar (orthoclase, microperthite, &c.). Some of them contain a small amount of interstitial quartz (quartz-bostonites); others have a small percentage of lime, which occasions the presence of a plagioclase felspar (maenite, gautcite, lime-bostonite). Other minerals, except apatite, zircon and magnetite, are typically absent. They have very much the same composition as the trachytes; and many rocks of this series have been grouped with these or with the orthophyres. Typically they occur as dikes or as thin sills, often in association with nepheline-syenite; and they seem to bear a complementary relationship to certain types of lamprophyre, such as camptonite and monchiquite. Though nowhere very common they have a wide distribution, being known from Scotland, Wales, Massachusetts, Montreal, Portugal, Bohemia, &c. The linoites and quartz-linoites of Norway are closely allied to the bostonites.

BOSTRÖM, CHRISTOFFER JACOB (1797-1866), Swedish philosopher, was born at Pitå and studied at Upsala, where from 1840 to 1863 he was professor of practical philosophy. His philosophy, as he himself described it, is a thoroughgoing rational idealism founded on the principle that the only true reality is spiritual. God is Infinite Spirit in whom all existence is contained, and is outside the limitations of time and space. Thus Boström protests not only against empiricism but also against those doctrines of Christian theology which seemed to him to picture God as something less than Pure Spirit. In ethics the highest aim is the direction of actions by reason in harmony

with the Divine; so the state, like the individual, exists solely in God, and in its most perfect form consists in the harmonious obedience of all its members to a constitutional monarch; the perfection of mankind as a whole is to be sought in a rational orderly system of such states in obedience to Universal Reason. This system differs from Platonism in that the "ideas" of God are not archetypal abstractions but concrete personalities.

Boström's writings were edited by H. Edfeldt (2 vols. Upsala, 1883). For his school see SWEDEN: *Literature*; also H. Höffding, *Filosofien i Sverige* (German trans. in *Philos. Monatshefte*, 1879), and *History of Mod. Philos.* (Eng. trans., 1900), p. 284; R. Falckenberg, *Hist. of Phil.* (Eng. trans., 1895); A. Nyblæus, *Om den Boströmske filosofien* (Lund, 1883), and *Karakteristik af den Boströmske filosofien* (Lund, 1892).

BOSWELL, JAMES (1740-1795), Scottish man of letters, the biographer of Samuel Johnson, was born at Edinburgh on the 29th of October 1740. His grandfather was in good practice at the Scottish bar, and his father, Alexander Boswell of Auchinleck, was also a noted advocate, who, on his elevation to the supreme court in 1754, took the name of his Ayrshire property as Lord Auchinleck. A Thomas Boswell (said upon doubtful evidence to have been a minstrel in the household of James IV.) was killed at Flodden, and since 1513 the family had greatly improved its position in the world by intermarriage with the first Scots nobility. In contradiction to his father, a rigid Presbyterian Whig, James was "a fine boy, wore a white cockade, and prayed for King James until his uncle Cochrane gave him a shilling to pray for King George, which he accordingly did" ("Whigs of all ages are made in the same way" was Johnson's comment). He met one or two English boys, and acquired a "tincture of polite letters" at the high school in Edinburgh. Like R. L. Stevenson, he early frequented society such as that of the actors at the Edinburgh theatre, sternly disapproved of by his father. At the university, where he was constrained for a season to study civil law, he met William Johnson Temple, his future friend and correspondent. The letters of Boswell to his "Atticus" were first published by Bentley in 1857. One winter he spent at Glasgow, where he sat under Adam Smith, who was then lecturing on moral philosophy and rhetoric.

In 1760 he was first brought into contact with "the elegance, the refinement and the liberality" of London society, for which he had long sighed. The young earl of Eglintoun took him to Newmarket and introduced him into the society of "the great, the gay and the ingenious." He wrote a poem called "The Cub at Newmarket," published by Dodsley in 1762, and had visions of entering the Guards. Reclaimed with some difficulty by his father from his rakish companions in the metropolis, he contrived to alleviate the irksomeness of law study in Edinburgh by forcing his acquaintance upon the celebrities then assembled in the northern capital, among them Kames, Blair, Robertson, Hume and Sir David Dalrymple (Lord Hailes), of whose sayings on the Northern Circuit he kept a brief journal. Boswell had already realized his vocation, the exercise of which was to give a new word to the language. He had begun to Boswellize. He was already on the track of bigger game—the biggest available in the Britain of that day. In the spring of 1763 Boswell came to a composition with his father. He consented to give up his pursuit of a guidon in the Guards and three and sixpence a day on condition that his father would allow him to study civil law on the continent. He set out in April 1763 by "the best road in Scotland" with a servant, on horseback like himself, in "a cocked hat, a brown wig, brown coat made in the court fashion, red vest, corduroy small clothes and long military boots." On Monday, the 16th of May 1763, in the back shop of Tom Davies the bookseller, No. 8 Russell Street, Covent Garden, James Boswell first met "Dictionary Johnson," the great man of his dreams, and was severely buffeted by him. Eight days later, on Tuesday, the 24th of May, Boswell boldly called on Mr Johnson at his chambers on the first floor of No. 1 Inner Temple Lane. On this occasion Johnson pressed him to stay; on the 13th of June he said, "Come to-me as often as you can"; on the 25th of June Boswell gave the great man a little sketch of his own life, and Johnson exclaimed with warmth, "Give me your hand; I have

taken a liking to you." Boswell experienced a variety of sensations, among which exultation was predominant. Some one asked, "Who is this Scotch cur at Johnson's heels?" "He is not a cur," replied Goldsmith, "he is only a bur. Tom Davies flung him at Johnson in sport, and he has the faculty of sticking." Johnson was fifty-four at this time and Boswell twenty-three. After June 1763 they met on something like 270 subsequent days. These meetings formed the memorable part of Boswell's life, and they are told inimitably in his famous biography of his friend.

The friendship, consecrated by the most delightful of biographies, and one of the most gorgeous feasts in the whole banquet of letters, was not so ill-assorted as has been inconsiderately maintained. Boswell's freshness at the table of conversation gave a new zest to every maxim that Johnson enunciated, while Boswell developed a perfect genius for interpreting the kind of worldly philosophy at which Johnson was so unapproachable. Both men welcomed an excuse for avoiding the task-work of life. Johnson's favourite indulgence was to talk; Boswell's great idea of success to elicit memorable conversation. Boswell is almost equally admirable as a reporter and as an interviewer, as a collector and as a researcher. He prepared meetings for Johnson, he prepared topics for him, he drew him out on questions of the day, he secured a copy of his famous letter to Lord Chesterfield, he obtained an almost verbatim report of Johnson's interview with the king, he frequented the tea-table of Miss Williams, he attended the testy old scholar on lengthy peregrinations in the Highlands and in the midlands. "Sir," said Johnson to his follower, "you appear to have only two subjects, yourself and me, and I am sick of both." Yet thorough as the scheme was from the outset, and admirable as was the devotedness of the biographer, Boswell was far too volatile a man to confine himself to any one ambition in life that was not consistent with a large amount of present fame and notoriety. He would have liked to Boswellize the popular idol Wilkes, or Chatham, or Voltaire, or even the great Frederick himself. As it was, during his continental tour he managed in the autumn of 1765 to get on terms with Pasquale di Paoli, the leader of the Corsican insurgents in their unwise struggle against Genoa. After a few weeks in Corsica he returned to London in February 1766, and was received by Johnson with the utmost cordiality. In accordance with the family compact referred to he was now admitted advocate at Edinburgh, and signaled his return to the law by an enthusiastic pamphlet entitled *The Essence of the Douglas Cause* (November 1767), in which he vigorously repelled the charge of imposture from the youthful claimant. In the same year he issued a little book called *Dorando*, containing a history of the Douglas cause in the guise of a Spanish tale, and bringing the story to a conclusion by the triumph of Archibald Douglas in the law courts. Editors who published extracts while the case was still *sub judice* were censured severely by the court of session; but though his identity was notorious the author himself escaped censure. In the spring of 1768 Boswell published through the Foulis brothers of Glasgow his *Account of Corsica, Journal of a Tour to that Island, and Memoirs of Pascal Paoli*. The liveliness of personal impression which he managed to communicate to all his books gained for this one a deserved success, and the *Tour* was promptly translated into French, German, Italian and Dutch. Walpole and others, jeered, but Boswell was talked about everywhere, as Paoli Boswell or Paoli's Englishman, and to aid the mob in the task of identifying him at the Shakespeare jubilee of 1769 he took the trouble to insert a placard in his hat bearing the legend "Corsica Boswell." The amazing costume of "a Corsican chief" which he wore on this occasion was described at length in the magazines.

On the 25th of November 1769, after a short tour in Ireland undertaken to empty his head of Corsica (Johnson's emphatic direction), Boswell married his cousin Margaret Montgomery at Lainsbow in Ayrshire. For some years henceforth his visits to London were brief, but on the 30th of April 1773 he was present at his admission to the Literary Club, for which honour he had been proposed by Johnson himself, and in the autumn of this

year in the course of his tour to the Hebrides Johnson visited the Boswells in Ayrshire. Neither Boswell's father nor his wife shared his enthusiasm for the lexicographer. Lord Auchinleck remarked that Jamie was "gane clean gyte . . . And whose tail do ye think he has pinned himself to mow, man? A dominie, an auld dominie, that keepit a schule and ca'd it an academy!" Housewives less prim than Mrs Boswell might have objected to Johnson's habit of turning lighted candles upside down when in the parlour to make them burn better. She called the great man a bear. Boswell's *Journal of a Tour in the Hebrides* was written for the most part during the journey, but was not published until the spring of 1786. The diary of Peypys was not then known to the public, and Boswell's indiscretions as to the emotions aroused in him by the neat ladies' maids at Inveraray, and the extremity of drunkenness which he exhibited at Corrichatachin, created a literary sensation and sent the *Tour* through three editions in one year. In the meantime his pecuniary and other difficulties at home were great; he made hardly more than £100 a year by his profession, and his relations with his father were chronically strained. In 1775 he began to keep terms at the Inner Temple and managed to see a good deal of Johnson, between whom and John Wilkes he succeeded in bringing about a meeting at the famous dinner at Dilly's on the 15th of May 1776. On the 30th of August 1782 his father died, leaving him an estate worth £1600 a year. On the 30th of June 1784, Boswell met Johnson for the last time at a dinner at Sir Joshua Reynolds's. He accompanied him back in the coach from Leicester Square to Bolt Court. "We bade adieu to each other affectionately in the carriage. When he had got down upon the foot pavement he called out 'Fare you well'; and without looking back, sprung away with a kind of pathetic briskness, if I may use that expression, which seemed to indicate a struggle to conceal uneasiness, and impressed me with a foreboding of our long, long separation." Johnson died that year, and two years later the Boswells moved to London. In 1789 Mrs Boswell died, leaving five children. She had been an excellent mother and a good wife, despite the infidelities and drunkenness of her husband, and from her death Boswell relapsed into worse excesses, grievously aggravated by hypochondria. He died of a complication of disorders at his house in Great Poland Street on the 10th of May 1795, and was buried a fortnight later at Auchinleck.

Up to the eve of his last illness Boswell had been busy upon his magnum opus, *The Life of Samuel Johnson*, which was in process of crystallization to the last. The first edition was published in two quarto volumes in an edition of 1700 copies on the 16th of May 1791. He was preparing a third edition when he died; this was completed by his friend Edmund Malone, who brought out a fifth edition in 1807. That of James Boswell junior (the editor of Malone's *Variorum Shakespeare*, 1821) appeared in 1811.

The Life of Johnson was written on a scale practically unknown to biographers before Boswell. It is a full-length with all the blotches and pimples revealed ("I will not make my tiger a cat to please anybody," wrote "Bozzy"). It may be overmuch an exhibition of oddities, but it is also, be it remembered, a pioneer application of the experimental method to the determination of human character. Its size and lack of divisions (to divide it into chapters was an original device of Croker's) are a drawback, and have prevented Boswell's *Life* from that assured triumph abroad which has fallen to the lot of various English classics such as *Robinson Crusoe* or *Gulliver's Travels*. But wherever English is spoken, it has become a veritable sacred book and has pervaded English life and thought in the same way, that the Bible, Shakespeare and Bunyan have done. Boswell has successfully (to use his own phrase) "Johnsonized" Britain, but has not yet Johnsonized the planet. The model originally proposed to himself by Boswell was Mason's *Life of Gray*, but he far surpassed that, or indeed any other, model. The fashion that Boswell adopted of giving the conversations not in the neutral tints of *oratio obliqua* but in full *oratio recta* was a stroke of genius. But he is far from being the mere mechanical transmitter of good things. He is a dramatic and descriptive artist of the first order. The extraordinary vitality of his figures postulates

a certain admixture of fiction, and it is certain that Boswell exaggerates the sympathy expressed in word or deed by Johnson for some of his own tenderer foibles. But, on the whole, the best judges are of opinion that Boswell's accuracy is exceptional, as it is undoubtedly seconded by a power of observation of a singular retentiveness and intensity. The difficulty of dramatic description can only be realized, as Jowett well pointed out, by those who have attempted it, and it is not until we compare Boswell's reports with those of less skilful hearers that we can appreciate the skill with which the essence of a conversation is extracted, and the whole scene indicated by a few telling touches. The result is that Johnson, not, it is true, in the early days of his poverty, total idleness and the pride of literature, but in the fulness of fame and competence of fortune from 1763 to 1784, is better known to us than any other man in history. The old theory to explain such a marvel (originally propounded by Gray when the *Tour in Corsica* appeared) that "any fool may write a valuable book by chance" is now regarded as untenable. If fool is a word to describe Boswell (and his folly was at times transcendent) he wrote his great book because and not in despite of the fact that he was one. There can be no doubt, in fact, that he was a biographical genius, and that he arranged his opportunities just as he prepared his transitions and introduced those inimitable glosses by which Johnson's motives are explained, his state of mind upon particular occasions indicated, and the general feeling of his company conveyed. This remarkable literary faculty, however, was but a fraction of the total make-up requisite to produce such a masterpiece as the *Life*. There is a touch of genius, too, in the naïf and imperturbable good nature and persistency ("Sir, I will not be baited with 'what' and 'why.' 'Why is a cow's tail long?' 'Why is a fox's tail bushy?'"), and even in the abnegation of all personal dignity, with which Boswell pursued his hero. As he himself said of Goldsmith, "He had sagacity enough to cultivate assiduously the acquaintance of Johnson, and his faculties were gradually enlarged." Character, the vital principle of the individual, is the *ignis fatuus* of the mechanical biographer. Its attainment may be secured by a variety of means—witness Xenophon, Cellini, Aubrey, Lockhart and Froude—but it has never been attained with such complete intensity as by Boswell in his *Life of Johnson*. The more we study Boswell, the more we compare him with other biographers, the greater his work appears.

The eleventh edition of Boswell's *Johnson* was brought out by John Wilson Croker in 1831; in this the original text is expanded by numerous letters and variorum anecdotes and is already knee-deep in annotation. Its blunders provoked the celebrated and mutually corrective criticisms of Macaulay and Carlyle. Its value as an unrivalled granary of Johnsoniana, stored opportunely before the last links with a Johnsonian age had disappeared, has not been adequately recognized. A new edition of the original text was issued in 1874 by Percy Fitzgerald (who has also written a useful *Life of James Boswell* in 2 vols., London, 1891); a six-volume edition, including the *Tour* and Johnsoniana, was published by the Rev. Alexander Napier in 1884; the definitive edition is that by Dr Birbeck Hill in 6 vols., 1887, with copious annotations and a model index. A generously illustrated edition was completed in 1907 in two large volumes by Roger Inghen, and reprints of value have also been edited by R. Carruthers (with woodcuts), A. Birrell, Howray Morris (Globe edition) and Austin Dobson. A short biography of Boswell was written in 1896 by W. Keith Leask. Boswell's commonplace-book was published in 1876, under the title of *Boswelliana*, with a memoir by the Rev. C. Rogers. (T. Sx.)

BOSWORTH, JOSEPH (1780-1870), British Anglo-Saxon scholar, was born in Derbyshire in 1780. Educated at Repton, whence he proceeded to Aberdeen University, he became in 1817 vicar of Little Horwood, Buckinghamshire, and devoted his spare time to literature and particularly to the study of Anglo-Saxon. In 1823 appeared his *Elements of Anglo-Saxon Grammar*. In 1829 Bosworth went to Holland as chaplain, first at Amsterdam and then at Rotterdam. He remained in Holland until 1840, working there on his *Dictionary of the Anglo-Saxon Language* (1838), his best-known work. In 1857 he became rector of Water Stelford, Buckinghamshire, and in the following year was appointed Rawlinson professor of Anglo-Saxon at Oxford. He gave to the university of Cambridge in 1867 £10,000 for the

establishment of a professorship of Anglo-Saxon. He died on the 27th of May 1876, leaving behind him a mass of annotations on the Anglo-Saxon charters.

BOTANY (from Gr. *βότᾱν*, plant; *βίωσκω*, to graze), the science which includes everything relating to the vegetable kingdom, whether in a living or in a fossil state. It embraces a consideration of the external forms of plants—of their anatomical structure, however minute—of the functions which they perform—of their arrangement and classification—of their distribution over the globe at the present and at former epochs—and of the uses to which they are subservient. It examines the plant in its earliest state of development, and follows it through all its stages of progress until it attains maturity. It takes a comprehensive view of all the plants which cover the earth, from the minutest organism, only visible by the aid of the microscope, to the most gigantic productions of the tropics. It marks the relations which subsist between all members of the plant world, including those between existing groups and those which are known only from their fossilized remains preserved in the rocks. We deal here with the history and evolution of the science.

The plants which adorn the globe more or less in all countries must necessarily have attracted the attention of mankind from the earliest times. The science that treats of them dates back to the days of Solomon, who "spake of trees, from the cedar of Lebanon to the hyssop on the wall." The Chaldeans, Egyptians and Greeks were the early cultivators of science, and botany was not neglected, although the study of it was mixed up with crude speculations as to vegetable life, and as to the change of plants into animals. About 300 years before Christ Theophrastus wrote a *History of Plants*, and described about 500 species used for the treatment of diseases. Dioscorides, a Greek writer, who appears to have flourished about the time of Nero, issued a work on *Materia Medica*. The elder Pliny described about a thousand plants, many of them famous for their medicinal virtues. Asiatic and Arabian writers also took up this subject. Little, however, was done in the science of botany, properly so called, until the 16th century of the Christian era, when the revival of learning dispelled the darkness which had long hung over Europe. Otto Brunfels, a physician of Bern, has been looked upon as the restorer of the science in Europe. In his *Herbarium*, printed at Strassburg (1530-1536), he gave descriptions of a large number of plants, chiefly those of central Europe, illustrated by beautiful woodcuts. He was followed by other writers.—Leonhard Fuchs, whose *Historia Stirpium* (Basel, 1542) is worthy of special note for its excellent woodcuts; Hieronymus Bock, whose *Kreutter Buch* appeared in 1539; and William Turner, "The Father of English Botany," the first part of whose *New Herbal*, printed in English, was issued in 1551. The descriptions in these early works were encumbered with much medicinal detail, including speculations as to the virtues of plants. Plants which were strikingly alike were placed together, but there was at first little attempt at systematic classification. A crude system, based on the external appearance of plants and their uses to man, was gradually evolved, and is well illustrated in the *Herbal*, issued in 1597 by John Gerard (1545-1612), a barber-surgeon, who had a garden in Holborn, and was a keen student of British plants.

One of the earliest attempts at a methodical arrangement of plants was made in Florence by Andreas Caesalpinus (1519-1603), who is called by Linnaeus *primus versus systematicus*. In his work *De Plantis*, published at Florence in 1583, he distributed the 1520 plants then known into fifteen classes, the distinguishing characters being taken from the fruit.

John Ray (1627-1705) did much to advance the science of botany, and was also a good zoologist. He promulgated a system which may be considered as the dawn of the "natural system" of the present day (Ray, *Methodus Plantarum*, 1682). He separated flowering from flowerless plants, and divided the former into Dicotyledons and Monocotyledons. His orders (or "classes") were founded to some extent on a correct idea of the affinities of plants, and he far outstripped his contemporaries in his enlightened views of arrangement.

About the year 1670 Dr Robert Morison¹ (1620-1683), the first professor of botany at Oxford, published a systematic arrangement of plants, largely on the lines previously suggested by Caesalpinus. He divided them into eighteen classes, distinguishing plants according as they were woody or herbaceous, and taking into account the nature of the flowers and fruit. In 1690 Rivinus² promulgated a classification founded chiefly on the forms of the flowers. J. P. de Tournefort³ (1656-1708), who about the same time took up the subject of vegetable taxonomy, was long at the head of the French school of botany, and published a systematic arrangement in 1694-1700. He described about 8000 species of plants, and distributed them into twenty-two classes, chiefly according to the form of the corolla, distinguishing herbs and under-shrubs on the one hand from trees and shrubs on the other. The system of Tournefort was for a long time adopted on the continent, but was ultimately displaced by that of Carl von Linné, or Linnaeus (q.v.; 1707-1778).

The system of Linnaeus was founded on characters derived from the stamens and pistils, the so-called sexual organs of the flower, and hence it is often called the sexual system. It is an artificial method, because it takes into account only a few marked characters in plants, and does not propose to unite them by natural affinities. It is an index to a department of the book of nature, and as such is useful to the student. It does not aspire to any higher character, and although it cannot be looked upon as a scientific and natural arrangement, still it has a certain facility of application which at once commended it. It does not of itself give the student a view of the true relations of plants, and by leading to the discovery of the name of a plant, it is only a stepping-stone to the natural system. Linnaeus himself claimed nothing higher for it. He says—"Methodi Naturalis fragmenta studioso inquirenda sunt. Primum et ultimum hoc in botanicis desideratum est. Natura non facit saltus. Plantae omnes utrinque affinitatem monstrant, uti territorium in mappa geographica." Accordingly, besides his artificial index, he also promulgated fragments of a natural method of arrangement.

The Linnean system was strongly supported by Sir James Edward Smith (1759-1828), who adopted it in his *English Flora*, and who also became possessor of the Linnean collection. The system was for a long time the only one taught in the schools of Britain, even after it had been discarded by those in France and in other continental countries.

The foundation of botanic gardens during the 16th and 17th centuries did much in the way of advancing botany. They were at first appropriated chiefly to the cultivation of medicinal plants. This was especially the case at universities, where medical schools existed. The first botanic garden was established at Padua in 1545, and was followed by that of Pisa. The garden at Leiden dates from 1577, that at Leipzig from 1579. Gardens also early existed at Florence and Bologna. The Montpellier garden was founded in 1592, that of Giessen in 1605, of Strassburg in 1620, of Altdorf in 1625, and of Jena in 1629. The Jardin des Plantes at Paris was established in 1626, and the Upsala garden in 1627. The botanic garden at Oxford was founded in 1632. The garden at Edinburgh was founded by Sir Andrew Balfour and Sir Robert Sibbald in 1670, and, under the name of the Physic Garden, was placed under the superintendence of James Sutherland, afterwards professor of botany in the university. The garden at Kew dates from about 1730, when Frederick, prince of Wales, obtained a long lease of Kew House and its gardens from the Capel family. After his death in 1751 his widow, Princess Augusta of Saxe-Gotha, showed great interest in their scientific development, and in 1759 engaged William Aiton to establish a Physic Garden. The garden of the Royal Dublin Society at Glasnevin was opened about 1796; that of Trinity College, Dublin, in 1807; and that of Glasgow

¹ Morison, *Praecludia Botanica* (1672); *Plantarum Historia Universalis* (1680).

² Rivinus (Augustus Quirinus) paterno nomine Bachmann, *Introductio generalis in Rem Herbariam* (Lipsiae, 1690).

³ Tournefort, *Éléments de botanique* (1694); *Institutiones Rei Herbariae* (1700).

in 1818. The Madrid garden dates from 1763, and that of Coimbra from 1773. Jean Gesner (1709-1790), a Swiss physician and botanist, states that at the end of the 18th century there were 1600 botanic gardens in Europe.

A new era dawned on botanical classification with the work of Antoine Laurent de Jussieu (1748-1836). His uncle, Bernard de Jussieu, had adopted the principles of Linnaeus in his arrangement of the plants in the royal garden at the Trianon. At an early age Antoine became botanical demonstrator in the Jardin des Plantes, and was thus led to devote his time to the science of botany. Being called upon to arrange the plants in the garden, he necessarily had to consider the best method of doing so, and, following the lines already suggested by his uncle, adopted a system founded in a certain degree on that of Ray, in which he embraced all the discoveries in organography, adopted the simplicity of the Linnean definitions, and displayed the natural affinities of plants. His *Genera Plantarum*, begun in 1778, and finally published in 1780, was an important advance, and formed the basis of all natural classifications. One of the early supporters of this natural method was Augustin Pyramus de Candolle (1778-1841), who in 1813 published his *Théorie Élémentaire de la botanique*, in which he showed that the affinities of plants are to be sought by the comparative study of the form and development of organs (morphology), not of their functions (physiology). His *Prodromus Systematis Naturalis Regni Vegetabilis* was intended to embrace an arrangement and description of all known plants. The work was continued after his death, by his son Alphonse de Candolle, with the aid of other eminent botanists, and embraces descriptions of the genera and species of the orders of Dicotyledonous plants. The system followed by de Candolle is a modification of that of Jussieu.

In arranging plants according to a natural method, we require to have a thorough knowledge of structural and morphological botany, and hence we find that the advances made in these departments have materially aided the efforts of systematic botanists.

Robert Brown (1773-1858) was the first British botanist to support and advocate the natural system of classification. The publication of his *Prodromus Florae Novae Hollandiae* (in 1810), according to the natural method, led the way to the adoption of that method in the universities and schools of Britain. In 1827 Brown announced his important discovery of the distinction between Angiosperms and Gymnosperms, and the philosophical character of his work led A. von Humboldt to refer to him as "Botanicorum facile princeps." In 1830 John Lindley published the first edition of his *Introduction to the Natural System*, embodying a slight modification of de Candolle's system. From the year 1832 up to 1850 great advances were made in systematic botany, both in Britain and on the continent of Europe. The *Enchiridion and Genera Plantarum* of S. L. Endlicher (1804-1849), the *Prodromus* of de Candolle, and the *Vegetable Kingdom* (1846) of J. Lindley became the guides in systematic botany, according to the natural system.

The least satisfactory part of all these systems was that concerned with the lower plants or Cryptogams as contrasted with the higher or flowering plants (Phanerogams). The development of the compound microscope rendered possible the accurate study of their life-histories; and the publication in 1851 of the results of Wilhelm Hofmeister's researches on the comparative embryology of the higher Cryptogamia shed a flood of light on their relationships to each other and to the higher plants, and supplied the basis for the distinction of the great groups Thallophyta, Bryophyta, Pteridophyta and Phanerogamae, the last named including Gymnospermae and Angiospermae.

A system of classification for the Phanerogams, or, as they are frequently now called, Spermatophyta (seed-plants), which has been much used in Great Britain and in America, is that of Bentham and Hooker, whose *Genera Plantarum* (1867-1883) is a descriptive account of all the genera of flowering plants, based on their careful examination. The arrangement is a modification of that adopted by the de Candolles. Another system differing somewhat in detail is that of A. W. Eichler (Berlin, 1883), a

modified form of which was elaborated by Dr Adolf Engler of Berlin; the principal editor of *Die natürliche Pflanzenfamilien*.

The study of the anatomy and physiology of plants did not keep pace with the advance in classification. Nehemiah Grew and his contemporary Marcello Malpighi were the earliest discoverers in the department of plant anatomy. Both authors laid an account of the results of their study of plant structure before the Royal Society of London almost at the same time in 1671. Malpighi's complete work, *Anatomie Plantarum*, appeared in 1675 and Grew's *Anatomy of Plants* in 1682. For more than a hundred years the study of internal structure was neglected. In 1802 appeared the *Traité d'anatomie et de physiologie végétale* of C. F. B. de Mirbel (1776-1854), which was quickly followed by other publications by Kurt Sprengel, L. C. Treviranus (1779-1864), and others. In 1812 J. J. P. Moldenhauer isolated cells by maceration of tissues in water. The work of F. J. F. Meyen and H. von Mohl in the middle of the 19th century placed the study of plant anatomy on a more scientific basis. Reference must also be made to M. J. Schleiden (1804-1881) and F. Unger (1800-1870), while in K. W. von Nägeli's investigations on molecular structure and the growth of the cell membrane we recognize the origin of modern methods of the study of cell-structure included under cytology (*q.v.*). The work of Karl Sano and Th. Hartig advanced knowledge on the structure and development of tissues, while A. de Bary's *Comparative Anatomy of the Phanerogams and Ferns* (1877) supplied an admirable presentation of the facts so far known. Since then the work has been carried on by Ph. van Tieghem and his pupils, and others, who have sought to correlate the large mass of facts and to find some general underlying principles (see **PLANTS: Anatomy**).

The subject of fertilization was one which early excited attention. The idea of the existence of separate sexes in plants was entertained in early times, long before separate male and female organs had been demonstrated. The production of dates in Egypt, by bringing two kinds of flowers into contact, proves that in very remote periods some notions were entertained on the subject. Female date-palms only were cultivated, and wild ones were brought from the desert in order to fertilize them. Herodotus informs us that the Babylonians knew of old that there were male and female date-trees, and that the female required the concurrence of the male to become fertile. This fact was also known to the Egyptians, the Phœnicians and other nations of Asia and Africa. The Babylonians suspended male clusters from wild dates over the females; but they seem to have supposed that the fertility thus produced depended on the presence of small flies among the wild flowers, which, by entering the female flowers, caused them to set and ripen. The process was called palmification. Theophrastus, who succeeded Aristotle in his school in the 114th Olympiad, frequently mentions the sexes of plants, but he does not appear to have determined the organs of reproduction. Pliny, who flourished under Vespasian, speaks particularly of a male and female palm, but his statements were not founded on any real knowledge of the organs. From Theophrastus down to Caesalpinus, who died at Rome in 1603, there does not appear to have been any attention paid to the reproductive organs of plants. Caesalpinus had his attention directed to the subject, and he speaks of a halitus or emanation from the male plants causing fertility in the female.

Nehemiah Grew seems to have been the first to describe, in a paper on the *Anatomy of Plants*, read before the Royal Society in November 1676, the functions of the stamens and pistils. Up to this period all was vague conjecture. Grew speaks of the *attire*, or the stamens, as being the male parts, and refers to conversations with Sir Thomas Millington, Sedleian professor at Oxford, to whom the credit of the sexual theory seems really to belong. Grew says that "when the attire or apices break or open, the globules or dust falls down on the seedcase or uterus, and touches it with a prolific virtue." Ray adopted Grew's views, and states various arguments to prove their correctness in the preface to his work on European plants, published in 1694. In 1694 R. J. Camerarius, professor of botany and medicine at

Tübingen, published a letter on the sexes of plants, in which he refers to the stamens and pistils as the organs of reproduction, and states the difficulties he had encountered in determining the organs of Cryptogamic plants. In 1703 Samuel Morland, in a paper read before the Royal Society, stated that the farina (pollen) is a congeries of seminal plants, one of which must be conveyed into every ovum or seed before it can become prolific. In this remarkable statement he seems to anticipate in part the discoveries afterwards made as to pollen tubes, and more particularly the peculiar views promulgated by Schleiden. In 1711 E. F. Geoffroy, in a memoir presented to the Royal Academy at Paris, supported the views of Grew and others as to the sexes of plants. He states that the germ is never to be seen in the seed till the apices (anthers) shed their dust; and that if the stamina be cut out before the apices open, the seed will either not ripen, or be barren if it ripens. He mentions two experiments made by him to prove this—one by cutting off the staminal flowers in Maize, and the other by rearing the female plant of Mercurialis apart from the male. In these instances most of the flowers were abortive, but a few were fertile, which he attributes to the dust of the apices having been wafted by the wind from other plants.

Linnaeus took up the subject in the inauguration of his sexual system. He first published his views in 1736, and he thus writes—"Antheras et stigmata constitucere sexum plantarum, a palmicolis, Millingtono, Grewio, Rayo, Camerario, Godofredo, Morlando, Vaillantio, Blairio, Jussievio, Bradleyo, Royeno, Logano, &c., detectum, descriptum, et pro infallibili assumptum; nec ullum, apertis oculis considerantem cujuscunque plantae flores, latere potest." He divided plants into sexual and asexual, the former being Phanerogamous or flowering, and the latter Cryptogamous or flowerless. In the latter division of plants he could not detect stamens and pistils, and he did not investigate the mode in which their germs were produced. He was no physiologist, and did not promulgate any views as to the embryogenic process. His followers were chiefly engaged in the arrangement and classification of plants, and while descriptive botany made great advances the physiological department of the science was neglected. His views were not, however, adopted at once by all, for we find Charles Alston stating arguments against them in his *Dissertation on the Sexes of Plants*. Alston's observations were founded on what occurred in certain unisexual plants, such as Mercurialis, Spinach, Hemp, Hop and Bryony. The conclusion at which he arrives is that the pollen is not in all flowering plants necessary for impregnation, for fertile seeds can be produced without its influence. He supports parthenogenesis in some plants. Soon after the promulgation of Linnaeus's method of classification, the attention of botanists was directed to the study of Cryptogamic plants, and the valuable work of Johann Hedwig (1730-1790) on the reproductive organs of mosses made its appearance in 1782. He was one of the first to point out the existence of certain cellular bodies in these plants which appeared to perform the functions of reproductive organs, and to them the names of antheridia and pistillidia were given. This opened up a new field of research, and led the way in the study of Cryptogamic reproduction, which has since been much advanced by the labours of numerous botanical inquiries. The interesting observations of Morland, already quoted, seem to have been neglected, and no one attempted to follow in the path which he had pointed out. Botanists were for a long time content to know that the scattering of the pollen from the anther, and its application to the stigma, were necessary for the production of perfect seed, but the stages of the process of fertilization remained unexplored. The matter seemed involved in mystery, and no one attempted to raise the veil which hung over the subject of embryogeny. The general view was, that the embryo originated in the ovule, which was in some obscure manner fertilized by the pollen.

In 1815 L. C. Treviranus, professor of botany in Bonn, roused the attention of botanists to the development of the embryo, but although he made valuable researches, he did not add much in the way of new information. In 1823 G. B. Amici discovered the

existence of pollen tubes, and he was followed by A. T. Brongniart and R. Brown. The latter traced the tubes as far as the nucleus of the ovule. These important discoveries mark a new epoch in embryology, and may be said to be the foundation of the views now entertained, which were materially aided by the subsequent elucidation of the process of cytogenesis, or cell-development, by Schleiden, Schwann, Mohl and others. The whole subject of fertilization and development of the embryo has been more recently investigated with great assiduity and zeal, as regards both cryptogamous and phanerogamous plants, and details must be sought in the various special articles. The observations of Darwin as to the fertilization of orchids, *Primula*, *Linum* and *Lylthrum*, and other plants, and the part which insects take in this function, gave an explanation of the observations of Christian Konrad Sprengel, made at the close of the 18th century, and opened up a new phase in the study of botany, which has been followed by Hermann Müller, Federico Delpino and others, and more recently by Paul Knuth.

One of the earliest workers at plant physiology was Stephen Hales. In his *Statical Essays* (1727) he gave an account of numerous experiments and observations which he had made on the nutrition of plants and the movement of sap in them. He showed that the gaseous constituents of the air contribute largely to the nourishment of plants, and that the leaves are the organs which elaborate the food; the importance of leaves in nutrition had been previously pointed out by Malpighi in a short account of nutrition which forms an appendix to his anatomical work. The birth of modern chemistry in the work of J. Priestley and Lavoisier, at the close of the 18th century, made possible the scientific study of plant-nutrition, though Jan Ingenhousz in 1779 discovered that plants incessantly give out carbonic acid gas, but that the green leaves and shoots only exhale oxygen in sunlight or clear daylight, thereby indicating the distinction between assimilation of carbonic acid gas (photosynthesis) and respiration. N. T. de Saussure (1767-1845) gave precision to the science of plant-nutrition by use of quantitative methods. The subjects of plant nutrition and respiration were further studied by R. J. H. Dutrochet towards the middle of the century, and Liebig's application of chemistry to agriculture and physiology put beyond question the parts played by the atmosphere and the soil in the nutrition of plants.

The phenomena of movements of the organs of plants attracted the attention of John Ray (1693), who ascribed the movements of the leaf of *Mimosa* and others to alteration in temperature. Linnaeus also studied the periodical movements of flowers and leaves, and referred to the assumption of the night-position as the sleep-movement. Early in the 19th century Andrew Knight showed by experiment that the vertical growth of stems and roots is due to the influence of gravitation, and made other observations on the relation between the position assumed by plant organs and external directive forces, and later Dutrochet, H. von Mohl and others contributed to the advance of this phase of plant physiology. Darwin's experiments in reference to the movements of climbing and twining plants, and of leaves in insectivorous plants, have opened up a wide field of inquiry as to the relation between plants and the various external factors, which has attracted numerous workers. By the work of Julius Sachs and his pupils plant physiology was established on a scientific basis, and became an important part of the study of plants, for the development of which reference may be made to the article *PLANTS: Physiology*. The study of form and development has advanced under the name "morphology," with the progress of which are associated the names of K. Goebel, E. Strasburger, A. de Bary and others, while more recently, as cytology (*q.v.*), the intimate study of the cell and its contents has attracted considerable attention.

The department of geographical botany made rapid advance by means of the various scientific expeditions which have been sent to all quarters of the globe, as well as by individual effort (see *PLANTS: Distribution*) since the time of A. von Humboldt. The question of the mode in which the floras of islands and of continents have been formed gave rise to important speculations

by such eminent botanical travellers as Charles Darwin, Sir J. D. Hooker, A. R. Wallace and others. The connexion between climate and vegetation has also been studied. Quite recently under the name of "Ecology" or "Oecology" the study of plants in relation to each other and to their environment has become the subject of systematic investigation.

The subject of palaeontological botany (see *PALAEOBOTANY*) has been advanced by the researches of both botanists and geologists. The nature of the climate at different epochs of the earth's history has also been determined from the character of the flora. The works of A. T. Brongniart, H. R. Goepfert and W. P. Schimper advanced this department of science. Among others who contributed valuable papers on the subject may be noticed Oswald Heer (1809-1883), who made observations on the Miocene flora, especially in Arctic regions; Gaston de Saporta (1823-1895), who examined the Tertiary flora; Sir J. W. Dawson and Leo Lesquereux, and others who reported on the Canadian and American fossil plants. In Great Britain also W. C. Williamson, by his study of the structure of the plants of the coal-measures, opened up a new line of research which has been followed by Bertrand Renault, D. H. Scott, A. C. Seward and others, and has led to important discoveries on the nature of extinct groups of plants and also on the phylogeny of existing groups.

Botany may be divided into the following departments:—

1. Structural, having reference to the form and structure of the various parts, including (a) Morphology, the study of the general form of the organs and their development—this will be treated in a series of articles dealing with the great subdivisions of plants (see *ANGIOSPERMS*, *Gymnosperms*, *Pteridophyta*, *Bryophyta*, *Algae*, *Lichens*, *Fungi* and *Bacteriology*) and the more important organs (see *STEM*, *LEAF*, *ROOT*, *FLOWER*, *FRUIT*); (b) Anatomy, the study of internal structure, including minute anatomy or histology (see *PLANTS: Anatomy*).
2. Cytology (*q.v.*), the intimate structure and behaviour of the cell and its contents—protoplasm, nucleus, &c.
3. Physiology, the study of the life-functions of the entire plant and its organs (see *PLANTS: Physiology*).
4. Systematic, the arrangement and classification of plants (see *PLANTS: Classification*).
5. Distribution or Geographical Botany, the consideration of the distribution of plants on the earth's surface (see *PLANTS: Distribution*).
6. Palaeontology, the study of the fossils found in the various strata of which the earth is composed (see *PALAEOBOTANY*).
7. Ecology or Oecology, the study of plants in relation to each other and to their environment (see *PLANTS: Ecology*).

Besides these departments which deal with Botany as a science, there are various applications of botany, such as forestry (see *FORESTS AND FORESTRY*), agriculture (*q.v.*), horticulture (*q.v.*), and materia medica (for use in medicine; see the separate articles on each plant). (A. B. R.)

BOTANY BAY, an inlet on the coast of Cumberland county, New South Wales, Australia, 5 m. south of the city of Sydney. On its shore is the township of Botany, forming a suburb of Sydney, with which it is connected by a tramway. It was first visited by Captain Cook in 1770, who landed at a spot marked by a monument, and took possession of the territory for the crown. The bay received its name from Joseph Banks, the botanist of the expedition, on account of the variety of its flora. When, on the revolt of the New England colonies, the convict establishments in America were no longer available (see *DEPORTATION AND NEW SOUTH WALES*), the attention of the British government, then under the leadership of Pitt, was turned to Botany Bay; and in 1787 Commodore Arthur Phillip was commissioned to form a penal settlement there. Finding, on his arrival, however, that the locality was ill suited for such a purpose, he removed northwards to the site of the present city of Sydney. The name of Botany Bay seems to have struck the popular fancy, and continued to be used in a general way for any convict establishment in Australia. The transportation of criminals to New South Wales was discontinued in 1840.

BOTHA, LOUIS (1862—), Boer general and statesman, was the son of one of the "Voortrekkers," and was born on the 27th of September 1862 at Greytown (Natal). He saw active service in savage warfare, and in 1887 served as a field-cornet. Subsequently he settled in the Vryheid district, which he represented in the Volksraad of 1897. In the war of 1899 he served at first under Lucas Meyer in northern Natal, but soon rose to higher commands. He was in command of the Boers at the battles of Colenso and Spion Kop, and these victories earned him so great a reputation that on the death of P. J. Joubert, Botha was made commander-in-chief of the Transvaal Boers. His capacity was again demonstrated in the action of Belfast-Dalmanutha (August 23-28, 1900), and after the fall of Pretoria he reorganized the Boer resistance with a view to prolonged guerrilla warfare. In this task, and in the subsequent operations of the war, he was aided by his able lieutenants de la Rey and de Wet. The success of his measures was seen in the steady resistance offered by the Boers to the very close of the three years' war. He was the chief representative of his countrymen in the peace negotiations of 1902, after which, with de Wet and de la Rey, he visited Europe in order to raise funds to enable the Boers to resume their former avocations. In the period of reconstruction under British rule, General Botha, who was still looked upon as the leader of the Boer people, took a prominent part in politics, advocating always measures which he considered as tending to the maintenance of peace and good order and the re-establishment of prosperity in the Transvaal. After the grant of self-government to the Transvaal in 1907, General Botha was called upon by Lord Selborne to form a government, and in the spring of the same year he took part in the conference of colonial premiers held in London. During his visit to England on this occasion General Botha declared the whole-hearted adhesion of the Transvaal to the British empire, and his intention to work for the welfare of the country regardless of racial differences. (See *TRANSVAAL: History*.)

BOTHNIA, GULF OF, the northern part of the Baltic Sea (*q.v.*). The name is preserved from the former territory of Bothnia, of which the western part is now included in Sweden, the eastern in Finland.

BOTHWELL, JAMES HEPBURN, 4TH EARL OF, duke of Orkney and Shetland (c. 1536-1578), husband of Mary, queen of Scots, son of Patrick, 3rd earl of Bothwell, and of Agnes, daughter of Henry, Lord Sinclair, was born about 1536. His father, Patrick, the 3rd earl (c. 1512-1556), was the only son of Adam, the 2nd earl, who was killed at Flodden, and the grandson of Patrick (d. c. 1508), 3rd Lord Hailes and 1st earl of Bothwell. It was this Patrick who laid the foundation of the family fortunes. Having fought against King James III. at the battle of Sauchieburn in 1488, he was rewarded by the new king, James IV., with the earldom of Bothwell, the office of lord high admiral and other dignities. He also received many grants of land, including the lordship of Bothwell, which had been taken from John Ramsay, Lord Bothwell (d. 1513), the favourite of James III.

James Hepburn succeeded in 1556 to his father's titles, lands and hereditary offices, including that of lord high admiral of Scotland. Though a Protestant, he supported the government of Mary of Guise, showed himself violently anti-English, and led a raid into England, subsequently in 1559 meeting the English commissioners and signing articles for peace on the border. The same year he seized £1000 secretly sent by Elizabeth to the lords of the congregation. In retaliation Arran occupied and stripped his castle at Crichton, whereupon Bothwell in November sent Arran a challenge, which the latter declined. In December he was sent by the queen dowager to secure Stirling, and in 1560 was despatched on a mission to France, visiting Denmark on the way, where he either married or seduced Anne, daughter of Christopher Thorsen, whom he afterwards deserted, and who came to Scotland in 1563 to obtain redress. He joined Mary at Paris in September, and in 1561 was sent by her as a commissioner to summon the parliament; in February he arrived in Edinburgh and was chosen a privy councillor on the 6th of September. He now entered into obligations to keep the peace with his

various rivals, but was soon implicated in riots and partisan disorders, and was ordered in December to leave the city. In March 1562, having made up his quarrel with Arran, he was accused of having proposed to the latter a project for seizing the queen, and in May he was imprisoned in Edinburgh castle, whence he succeeded in escaping on the 28th of August. On the 23rd of September he submitted to the queen. Murray's influence, however, being now supreme, he embarked in December for France, but was driven by storms on to Holy Island, where he was detained, and was subsequently, on the 18th of January 1564, seized at Berwick and sent by Elizabeth to the Tower, whence he was soon liberated and proceeded to France. After these adventures he returned to Scotland in March 1565, but withdrew once more before the superior strength of his opponents to France. The same year, however, he was recalled by Mary to aid in the suppression of Murray's rebellion, successfully eluding the ships of Elizabeth sent to capture him. As lieutenant of the Marches he was employed in settling disputes on the border, but used his power to instigate thieving and disorders, and is described by Cecil's correspondents as "as naughty a man as liveth and much given to the most detestable vices," "as false as a devil," "one that the godly of this whole nation hath a cause to curse for ever."¹ In February 1566 Bothwell, in spite of his previous matrimonial engagements—and he had also been united by "handfasting" to Janet Betoun of Cranstoun Riddell—married Jane, daughter of George Gordon, 4th earl of Huntly. Notwithstanding his insulting language concerning Mary and the fact that he was the "stoutest" in refusing mass, he became one of her chief advisers, but his complete ascendancy over her mind and affections dates from the murder of Rizzio on the 9th of March 1566. The queen required a protector, whom she found, not in the feeble Darnley, nor in any of the leaders of the factions, but in the strong, determined earl who had ever been a staunch supporter of the throne against the Protestant party and English influence. In Bothwell also, "the glorious, rash and hazardous young man," romantic, handsome, charming even in his guilt, Mary gained what she lacked in her husband, a lover. He now stood forth as her champion; Mary took refuge with him at Dunbar, presented him, among other estates, with the castle there and the chief lands of the earldom of March, and made him the most powerful noble in the south of Scotland. Her partiality for him increased as her contempt and hatred of Darnley became more confirmed. On the 7th of October he was dangerously wounded, and the queen showed her anxiety for his safety by riding 40 miles to visit him, incurring a severe illness. In November she visited him at Dunbar, and in December took place the conference at Craigmillar at which both were present, and at which the disposal of Darnley was arranged, Bothwell with some others subsequently signing the bond to accomplish his murder. He himself superintended all the preparations, visiting Darnley with Mary on the night of the crime, Sunday, 9th of February 1567, attending the queen on her return to Holyrood for the ball, and riding back to Kirk o' Field to carry out the crime. After the explosion he hurried back to Holyrood and feigned surprise at the receipt of the news half an hour later, ascribing the catastrophe to "the strangest accident that ever chancit, to wit, the foudler (lightning) came out of the luff (sky) and had burnt the king's house."²

Bothwell's power was now greater, and the queen's affection for him more ardent than ever. She was reported to have said that she cared not to lose France, England and her own country for him, and would go with him to the world's end in a white petticoat ere she left him.³ He was gratified with further rewards, and his success was clouded by no stings of conscience or remorse. According to Melville he had designs on the life of the young prince. On the demand of Lennox, Darnley's father, Bothwell was put upon his trial in April, but Lennox, having been forbidden to enter the city with more than six attendants, refused to attend, and Bothwell was declared not guilty. The queen's

¹ *Col. of State Papers, Scottish*, i. 679.

² Sir James Melville's *Mem.* 174.

³ *Col. of State Pap., Foreign*, 1566-1568, p. 212.

intention to marry Bothwell, which had been kept a strict secret before the issue of the trial, was now made public. On the 19th of April he obtained the consent and support of the Protestant lords, who signed a bond in his favour. On the 24th he seized Mary's willing person near Edinburgh, and carried her to his castle at Dunbar. On the 3rd of May Bothwell's divorce from his wife was decreed by the civil court, on the ground of his adultery with a maidservant, and on the 7th by the Roman Catholic court on the ground of consanguinity. Archbishop Hamilton, however, who now granted the decree, had himself obtained a papal dispensation for the marriage,¹ and in consequence it is extremely doubtful whether according to the Roman Catholic law Bothwell and Mary were ever husband and wife. On the 12th Bothwell was created duke of Orkney and Shetland and the marriage took place on the 15th according to the Protestant usage, the Roman Catholic rite being performed, according to some accounts, afterwards in addition.²

Bothwell's triumph, however, was shortlived. The nobles, both Protestant and Roman Catholic, now immediately united to effect his destruction. In June Mary and Bothwell fled from Holyrood to Borthwick Castle, whence Bothwell, on the place being surrounded by Morton and his followers, escaped to Dunbar, Mary subsequently joining him. Thence they marched with a strong force towards Edinburgh, meeting the lords on the 15th of June at Carberry Hill. Bothwell invited any one of the nobles to single combat, but Mary forbade the acceptance of the challenge. Meanwhile, during the negotiations, the queen's troops had been deserting; a surrender became inevitable, and Bothwell returned to Dunbar, parting from Mary for ever. Subsequently Bothwell left Dunbar for the north, visited Orkney and Shetland, and in July placed himself at the head of a band of pirates, and after cluding all attempts to capture him, arrived at Karm Sound in Norway. Here he was confronted by his first wife or victim, Anne Thorssen, whose claims he satisfied by the gift of a ship and promises of an annuity, and on his identity becoming known he was sent by the authorities to Copenhagen, where he arrived on the 30th of September. He wrote *Les Affaires du comte de Boduel*, exhibiting himself as the victim of the malice of his enemies, and gained King Frederick II.'s goodwill by an offer to restore the Orkneys and Shetlands to Denmark. In consequence the king allowed him to remain at Copenhagen, and refused all requests for his surrender. In January 1568 he was removed to Malmoe in Sweden. He corresponded frequently with Mary, but there being no hopes whatever of his restoration, and a new suitor being found in the duke of Norfolk, Mary demanded a divorce, on pleas which recall those of Henry VIII. in the matter of Catherine of Aragon. The divorce was finally granted by the pope in September 1570 on the ground of her pre-nuptial ravishment by Bothwell,³ and met with no opposition from the latter. After the downfall of Mary, Bothwell's good treatment came to an end, and on the 16th of June 1573 he was removed to the castle of Dragsholm or Adelsborg in Zealand. Here the close and solitary confinement, and the dreary and hopeless inactivity to which he was condemned, proved a terrible punishment for the full-blooded, energetic and masterful Bothwell. He sank into insanity, and died on the 14th of April 1578. He was buried at the church of Faareveille, where a coffin, doubtfully supposed to be his, was opened in 1858. A portrait was taken of the head of the body found therein, now in the museum of the Society of Antiquaries in Scotland. His so-called death-bed confession is not genuine.

He left no lawful descendants; but his nephew, FRANCIS STEWART HEPBURN, who, through his father, John Stewart, prior of Coldingham, was a grandson of King James V., and was thus related to Mary, queen of Scots, and the regent Murray, was in 1581 created earl of Bothwell. He was lord high admiral of Scotland, and was a person of some importance at the court of James VI. during the time when the influence of the Protestants was uppermost. He was anxious that Mary Stuart's death

should be avenged by an invasion of England, and in 1589 he suffered a short imprisonment for his share in a rising. By this time he had completely lost the royal favour. Again imprisoned, this time on a charge of witchcraft, he escaped from captivity in 1591, and was deprived by parliament of his lands and titles; as an outlaw his career was one of extraordinary lawlessness. In 1591 he attempted to seize Holyrood palace, and in 1593 he captured the king, forcing from him a promise of pardon. But almost at once he reverted to his former manner of life, and, although James failed to apprehend him, he was forced to take refuge in France about 1595. He died at Naples before July 1614. This earl had three sons, but his titles were never restored.

BIBLIOGRAPHY.—See the article in the *Dict. of Nat. Biog.* and authorities; *Les Affaires du comte de Boduel* (written January 1568, publ. Bannatyne Club, 1829); "Memoirs of James, Earl of Bothwell," in G. Chalmers's *Life of Mary, Queen of Scots* (1818); *Life of Bothwell*, by F. Schiern (trans. 1880); *Pièces et documents relatifs au comte de Bothwell*, by Prince A. Lobanoff (1856); *Appendix to the Hist. of Scotland*, by G. Buchanan (1721); *Sir James Melville's Memoirs* (Bannatyne Club, 1827); *A Lost Chapter in the Hist. of Mary, Queen of Scots*, by J. Stuart (1874); J. H. Burton's *Hist. of Scotland* (1873); A. Lang's *Hist. of Scotland*, ii. (1902); *Archæologia*, xxviii. 308; *Cal. of State Papers, Foreign, Scottish, Venetian*, vii.; *Exchequer Rolls of Scotland*, xix. and xx.; *Domestic, Border Papers; Hist. MSS. Comm., MSS. of Marj. of Salisbury*, i. ii. See also MARY, QUEEN OF SCOTS. (P. C. Y.)

BOTHWELL, a town of Lanarkshire, Scotland. Pop. of town (1901) 3015; of parish (1901) 45,905. The town lies on the right bank of the Clyde, 9 m. E.S.E. of Glasgow by the North British and Caledonian railways. Owing to its pleasant situation it has become a residential quarter of Glasgow. The choir of the old Gothic church of 1308 (restored at the end of the 19th century) forms a portion of the parish church. Joanna Baillie, the poetess, was born in the manse, and a memorial has been erected in her honour. The river is crossed by a suspension bridge as well as the bridge near which, on the 22nd of June 1679, was fought the battle of Bothwell Bridge between the Royalists, under the duke of Monmouth, and the Covenanters, in which the latter lost 500 men and 1000 prisoners. Adjoining this bridge, on the level north-eastern bank, is the castle that once belonged to James Hamilton of Bothwellhaugh (fl. 1566–1580), the assassin of the regent Murray; and near the present farmhouse the South Calder is spanned by a Roman bridge. The picturesque ruins of Bothwell Castle occupy a conspicuous position on the side of the river, which here takes the bold sweep famed in Scottish song as Bothwell bank. The fortress belonged to Sir Andrew Moray, who fell at Stirling in 1297, and passed by marriage to the Douglasses. The lordship was bestowed in 1487 on Patrick Hepburn, 3rd Lord Hailes, 1st earl of Bothwell, who resigned it in 1491 in favour of Archibald Douglas, 5th earl of Angus. It thus reverted to the Douglasses and now belongs to the earl of Home, a descendant. The castle is a fine example of Gothic, and mainly consists of a great oblong quadrangle, flanked on the south side by circular towers. At the east end are the remains of the chapel. A dungeon bears the nickname of "Wallace's Beef Barrel." The unpretending mansion near by was built by Archibald Douglas, 1st earl of Forfar (1653–1712). The parish of Bothwell contains several flourishing towns and villages, all owing their prosperity to the abundance of coal, iron and oil-shale. The principal places, most of which have stations on the North British or Caledonian railway or both, are Bothwell Park, Carfin, Chapelhall, Bellshill (pop. 8786), Holytown, Mossend, Newarthill, Uddingston (pop. 7463), Clydesdale, Hamilton Palace, Colliery Rows and Tennochside.

BOTOCUDOS (from Port. *botoque*, a plug, in allusion to the wooden disks or plugs worn in their lips and ears), the foreign name for a tribe of South American Indians of eastern Brazil, also known as the Aimores or Aimbore. They appear to have no collective tribal name for themselves. Some are called Nac-nanuk or Nac-poruk, "sons of the soil." The name Botocudos cannot be traced much farther back than the writings of Prince Maximilian von Neuwied (*Reise nach Brasilien*, Frankfort-on-Main, 1820). When the Portuguese adventurer Vasco Fernando Coutinho reached the east coast of Brazil in 1535, he erected a

¹ *Hist. MSS. Comm. Rep. ii. p. 177.*

² *Cal. of State Pap., Scottish*, ii. 333.

³ *Cal. of State Pap., Foreign, 1569–1571, p. 322.*

fort at the head of Espirito Santo Bay to defend himself against "the Aimores and other tribes." The original home of the tribe comprised most of the present province of Espirito Santo, and reached inland to the headwaters of Rio Grande (Belmonte) and Rio Doce on the eastern slopes of the Serra do Espinhaço, but the Botocudos are now mainly confined to the country between Rio Pardo and Rio Doce, and seldom roam westward beyond Serra dos Aimores into Minas Geraes. It was in the latter district that at the close of the 18th century they came into collision with the whites, who were attracted thither by the diamond fields.

The Botocudos are nomads, wandering naked in the woods and living on forest products. They are below the medium height, but broad-shouldered and remarkable for the muscular development and depth of their chests. Their arms and legs are, however, soft and fleshy, and their feet and hands small. Their features, which vary individually almost as much as those of Europeans, are broad and flat, with prominent brow, high cheekbones, small bridgeless nose, wide nostrils and slight projection of the jaws. They are longheaded, and their hair is coarse, black and lank. Their colour is a light yellowish brown, sometimes almost approaching white. The general yellow tint emphasizes their Mongolic appearance, which all travellers have noticed. The Botocudos were themselves greatly struck by the Chinese coolies, whom they met in Brazilian seaports, and whom they at once accepted as kinsmen (Henri HOLLARD, *De l'homme et des races humaines*, Paris, 1853).¹ Some few Botocudos have settled and become civilized, but the great bulk of them, numbering between twelve and fourteen thousand, are still the wildest of savages. During the earlier frontier wars (1790-1830) every effort was made to exterminate them. They were regarded by the Portuguese as no better than wild beasts. Smallpox was deliberately spread among them; poisoned food was scattered in the forests; by such infamous means the coast districts about Rios Doce and Belmonte were cleared, and one Portuguese commander boasted that he had either slain with his own hands or ordered to be butchered many hundreds of them. Their implements and domestic utensils are all of wood; their only weapons are spears and bows and arrows. Their dwellings are rough shelters of leaf and bast, seldom 4 ft. high. So far as the language of the Botocudos is known, it would appear that they have no means of expressing the numerals higher than one. Their only musical instrument is a small bamboo nose-flute. They attribute all the blessings of life to the "day-fire" (sun) and all evil to "night-fire" (moon). At the graves of the dead they keep fires burning for some days to scare away evil spirits, and during storms and eclipses arrows are shot into the sky to drive away demons.

The most conspicuous feature of the Botocudos is the *tembeira*, or wooden plug or disk which is worn in the lower lip of the lobe of the ear. This disk, made of the specially light and carefully dried wood of the barriguda tree (*Chorisia ventricosa*), is called by the natives themselves *emburi*, whence Augustin Saint Hilaire suggests the probable derivation of their name Aimbore (*Voyages dans l'intérieur du Brésil 1816-1821*, Paris, 1830). It is worn only in the under-lip, now chiefly by women, but formerly by men also. The operation for preparing the lip begins often as early as the eighth year, when an initial boring is made by a hard pointed stick, and gradually extended by the insertion of larger and larger disks or plugs, sometimes at last as much as 3 in. in diameter. Notwithstanding the lightness of the wood the *tembeira* weighs down the lip, which at first sticks out horizontally and at last becomes a mere ring of skin around the wood. Ear-plugs are also worn, of such size as to distend the lobe down to the shoulders. Ear-ornaments of like nature are common in south and even central America, at least as far north as Honduras. When Columbus discovered this latter country during his fourth voyage (1502)

he named part of the seaboard *Costa de la Oreja*, from the conspicuously distended ears of the natives. Early Spanish explorers also gave the name *Orejones* or "big-eared" to several Amazon tribes.

See A. R. WALLACE, *Travels on the Amazon (1853-1900)*; H. H. Bancroft, *Hist. of Pacific States* (San Francisco, 1882), vol. i. p. 211; A. H. KEANE, "On the Botocudos" in *Journ. Anthropol. Instit.* vol. xiii (1884); J. R. FEIXOTO, *Novos Estudos Craniológicos sobre os Botocudos* (Rio Janeiro, 1884); Prof. C. F. HARRT, *Geology and Physical Geography of Brazil* (Boston, 1870), pp. 577-606.

BOTORI, a Japanese game played at the naval, military and other schools, by two sides of equal number, usually about one hundred, each of which defends a pole about 8 ft. high firmly set in the ground, the poles being about 200 yds. distant from each other. The object of each party is to overthrow the adversaries' pole while keeping their own upright. Pulling, hauling and wrestling are allowed, but no striking or kicking. The players resort to all kinds of massed formations to arrive at the enemies' pole, and frequently succeed in passing over their heads and shoulders one or more comrades, who are thus enabled to reach the pole and bear it down unless pulled off in time by its defenders. A game similar in character is played by the Sophomore and Freshman classes of Amherst College (Massachusetts), called the "Flag-rush." It was instituted at the instance of the faculty to take the place of the traditional "Cane-rush," a general *milite* between the two classes for the ultimate possession of a stout walking-stick, which became so rough that students were frequently seriously injured. In the "Flag-rush" a small flag is set upon a padded post about 6 ft. high, and is defended by one class while the other endeavours, as at Botori, to overthrow it. If the flag is not captured or torn down within a certain time the defending side wins.

BOTOSHANI (*Botosani*), the capital of the department of Botoshani, Rumania; on a small tributary of the river Jijia, and in one of the richest agricultural and pastoral regions of the north Moldavian hills. Pop. (1900) 32,193. Botoshani is commercially important as the town through which goods from Poland and Galicia pass in transit for the south; being situated on a branch railway between Dorohoi and on the main line from Caernowits to Galatz. It has extensive starch and flour mills; and Botoshani flour is highly prized in Rumania, besides being largely exported to Turkey and the United Kingdom. Botoshani owes its name to a Tatar chief, Batus or Batu Khan, grandson of Jenghiz Khan, who occupied the country in the 13th century. There are large colonies of Armenians and Jews.

BO-TREE, or **BOOH-TREE**, the name given by the Buddhists of India and Ceylon to the Pipul or sacred wild fig (*Ficus religiosa*). It is regarded as sacred, and one at least is planted near each temple. These are traditionally supposed to be derived from the original one, the Bodhi-tree of Buddhist annals, beneath which the Buddha is traditionally supposed to have attained perfect knowledge. The Bo-tree at the ruined city of Anuradhapura, 80 m. north of Kandy, grown from a branch of the parent-tree sent to Ceylon from India by King Asoka in the 3rd century B.C., is said to have been planted in 288 B.C. and is to this day worshipped by throngs of pilgrims who come long distances to pray before it. Usually a bo-tree is planted on the graves of the Kandy priests.

BOTRYTIS, a minute fungus which appears as a brownish-grey mould on decaying vegetation or on damaged fruits. Under a hand-lens it is seen to consist of tiny, upright, brown stalks which are branched at the tips, each branchlet being crowned with a naked head of pale-coloured spores. It is a very common fungus, growing everywhere in the open or in greenhouses, and can be found at almost any season. It has also a bad record as a plant disease. If it once gains entrance into one of the higher plants, it spreads rapidly, killing the tissues and reducing them to a rotten condition. Seedling pines, lilies and many other cultivated plants are subject to attack by *Botrytis*. Some of the species exist in two other growth-forms, so different in appearance from the *Botrytis* that they have been regarded as distinct plants:—a sclerotium, which is a hard compact mass of fungal filaments, or mycelium, that can retain its vitality for a

¹ A parallel case is that of the Bashkir soldiers of Orenburg, who formed part of the Russian army sent to put down the Hungarian revolt of 1848, and who recognized their Ugrian kinsmen in the Zeklari and other Magyars settled in the Danube basin.

considerable time in a resting condition; and a stalked *Perisa*, or cup-fungus, which grows out of the sclerotium. The latter is the perfect form of fruit. The *Botrytis* mould is known as the conidial form.

BOTTA, CARLO GIUSEPPE GUGLIELMO (1766-1837), Italian historian, was born at San Giorgio Canavese in Piedmont. He studied medicine at the university of Turin, and obtained his doctor's degree when about twenty years of age. Having rendered himself obnoxious to the government during the political commotions that followed the French Revolution, he was imprisoned for over a year; and on his release in 1795 he withdrew to France, only to return to his native country as a surgeon in the French army, whose progress he followed as far as Venice. Here he joined the expedition to Corfu, from which he did not return to Italy till 1798. At first he favoured French policy in Italy, contributed to the annexation of Piedmont by France in 1799, and was an admirer of Napoleon; but he afterwards changed his views, realizing the necessity for the union of all Italians and for their freedom from foreign control. After the separation of Piedmont from France in 1814 he retired into private life, but, fearing persecution at home, became a French citizen. In 1817 he was appointed rector of the university of Rouen, but in 1822 was removed owing to clerical influence. Amid all the vicissitudes of his early manhood Botta had never allowed his pen to be long idle, and in the political quiet that followed 1816 he naturally devoted himself more exclusively to literature. In 1824 he published a history of Italy from 1789 to 1814 (4 vols.), on which his fame principally rests; he himself had been an eyewitness of many of the events described. His continuation of Guicciardini, which he was afterwards encouraged to undertake, is a careful and laborious work, but is not based on original authorities and is of small value. Though living in Paris he was in both these works the ardent exponent of that recoil against everything French which took place throughout Europe. A careful exclusion of all Gallicisms, as a reaction against the French influences of the day, is one of the marked features of his style, which is not infrequently impassioned and eloquent, though at the same time cumbrous, involved and ornate. Botta died at Paris in August 1837, in comparative poverty, but in the enjoyment of an extensive and well-earned reputation.

His son, Paul Émile Botta (1802-1870), was a distinguished traveller and Assyrian archaeologist, whose excavations at Khorsabad (1843) were among the first efforts in the line of investigation afterwards pursued by Layard.

The works of Carlo Botta are *Storia naturale e medica dell' Isola di Corfu* (1798); an Italian translation of Born's *Journis Physiophis specimens monachologiae* (1801); *Souvenirs d'un voyage en Dalmatie* (1802); *Storia della guerra dell' Indipendenza d'America* (1809); *Camillo*, a poem (1815); *Storia d'Italia dal 1780 al 1814* (1824, new ed., Prato, 1862); *Storia d'Italia in continuazione: al Guicciardini* (1832, new ed., Milan, 1878). See C. Dionisiotti, *Vita di Carlo Botta* (Turin, 1867); C. Pavese, *Carlo Botta e le sue opere storiche* (Florence, 1874); Scipione Botta, *Vita privata di Carlo Botta* (Florence, 1877); A. d'Ancona e O. Bacci, *Manuela della Letteratura Italiana* (Florence, 1894), vol. v. pp. 245 seq.

BOTTESINI, GIOVANNI (1823-1880), Italian contrabassist and musical composer, was born at Crema in Lombardy on the 24th of December 1823. He studied music at the Milan Conservatoire, devoting himself especially to the double-bass, an instrument with which his name is principally associated. On leaving Milan he spent some time in America and also occupied the position of principal double-bass in the theatre at Havana. Here his first opera, *Cristoforo Colombo*, was produced in 1847. In 1849 he made his first appearance in England, playing double-bass solos at one of the Musical Union concerts. After this he made frequent visits to England, and his extraordinary command of his unwieldy instrument gained him great popularity in London and the provinces. Apart from his triumphs as an executant, Bottesini was a conductor of European reputation, and earned some success as a composer, though his work had not sufficient individuality to survive the changes of taste and fashion. He was conductor at the Théâtre des Italiens in Paris from 1855 to 1857, where his second opera, *L'Assedio di Firenze*, was produced

in 1856. In 1861 and 1862 he conducted at Palermo, supervising the production of his opera *Marion Delorme* in 1862, and in 1863 at Barcelona. During these years he diversified the toils of conducting by repeated concert tours through the principal countries of Europe. In 1871 he conducted a season of Italian opera at the Lyceum theatre in London, during which his opera *Ali Baba* was produced, and at the close of the year he was chosen by Verdi to conduct the first performance of *Aida*, which took place at Cairo on 27th December 1871. Bottesini wrote three operas besides those already mentioned: *Il Diavolo della Notte* (Milan, 1859); *Vinciguerra* (Paris, 1870); and *Ero e Leandro* (Turin, 1880), the last named to a libretto by Arrigo Boito, which was subsequently set by Mancinelli. He also wrote *The Garden of Olivet*, a devotional oratorio (libretto by Joseph Bennett), which was produced at the Norwich festival in 1887, a concerto for the double-bass, and numerous songs and minor instrumental pieces. Bottesini died at Parma on the 7th of July 1889.

BOTTICELLI, SANDRO, properly **ALESSANDRO DI MARIANO DEI FILIPEPI** (1444-1510), Florentine painter, was born at Florence in 1444, in a house in the Via Nuova, Borg' Ognisanti. This was the home of his father, Mariano di Vanni dei Filipepi, a struggling tanner. Sandro, the youngest child but one of his parents, derived the name Botticelli, by which he was commonly known, not, as related by Vasari, from a goldsmith to whom he was apprenticed, but from his eldest brother Giovanni, a prosperous broker, who seems to have taken charge of the boy, and who for some reason bore the nickname *Botticello* or Little Barrel. A return made in 1457 by his father describes Sandro as aged thirteen, weak in health, and still at school (if the words *sta al legare* are to be taken as a misspelling of *sta al leggere*, otherwise they might perhaps mean that he was apprenticed either to a jeweller or a bookbinder). One of his elder brothers, Antonio, who afterwards became a bookseller, was at this time in business as a goldsmith and gold-leaf-beater, and with him Sandro was very probably first put to work. Having shown an irrepresible bent towards painting, he was apprenticed in 1458-1459 to Fra Filippo Lippi, in whose workshop he remained as an assistant apparently until 1467, when the master went to carry out a commission for the decoration with frescoes of the cathedral church of Spoleto. During his apprentice years Sandro no doubt employed with other pupils upon the great series of frescoes in the choir of the Pieve at Prato upon which his master was for long intermittently engaged. The later among these frescoes in many respects anticipate, by charm of sentiment, animation of movement and rhythmic flutter of draperies, some of the prevailing characteristics of Sandro's own style. One of Sandro's earliest extant pictures, the oblong "Adoration of the Magi" at the National Gallery, London (No. 592, long ascribed in error to Filippino), shows him almost entirely under the influence of his first master. Left in Florence on Fra Filippo's departure to Spoleto, he can be traced gradually developing his individuality under various influences, among which that of the realistic school of the Pollaiuoli is for some time the strongest. From that school he acquired a knowledge of bodily structure and movement, and a searching and expressive precision of linear draughtsmanship, which he could never have learnt from his first master. The Pollaiuolo influence dominates, with some slight admixture of that of Verrocchio, in the fine figure of Fortitude, now in the Uffizi, which was painted by Botticelli for the Mercanzia about 1470; this is one of a series of the seven Virtues, of which the other six, it seems, were executed by Piero Pollaiuolo from the designs of his brother Antonio. The same influence is again very manifest in the two brilliant little pictures at the Uffizi in which the youthful Botticelli has illustrated the story of Judith and Holofernes; in his injured portrait of a man holding a medal of Cosimo de' Medici, No. 1286 at the Uffizi; and in his life-sized "St Sebastian" at Berlin, which we know to have been painted for the church of Sta Maria Maggiore in 1473. Tradition and internal evidence seem also to point to Botticelli's having occasionally helped, in his earliest or Pollaiuolo period, to furnish designs to the

school of engravings in Florence which had been founded by the goldsmith Maso Finiguerra.

Some authorities hold that he must have attended for a while the much-frequented workshop of Verrocchio. But the "Fortitude" is the only authenticated early picture in which the Verrocchio influence is really much apparent; the various other pictures on which this opinion is founded, chiefly Madonnas dispersed among the museums of Naples, Florence, Paris and elsewhere, have been shown to be in all probability the work not of Sandro himself, but of an anonymous artist, influenced partly by him and partly by Verrocchio, whose individuality it has been endeavoured to reconstruct under the provisional name of Amico di Sandro. At the same time we know that the young Botticelli stood in friendly relations with some of the pupils in Verrocchio's workshop, particularly with Leonardo da Vinci. Among the many "Madonnas" which bear Botticelli's name in galleries public and private, the earliest which carries the unmistakable stamp of his own hand and invention is that which passed from the Chigi collection at Rome to that of Mrs Gardner at Boston. At the beginning of 1474 he entered into an agreement to work at Pisa, both in the Campo Santo and in the chapel of the Incoronata in the Duomo, but after spending some months in that city abandoned the task, we know not why. Next in the order of his preserved works comes probably the much-injured round of the "Adoration of the Magi" in the National Gallery (No. 1033), long ascribed in error, like the earlier oblong panel of the same subject, to Filippino Lippi. (To about this date is assigned by some the well-known "Assumption of the Virgin surrounded with the heavenly hierarchies," formerly at Hamilton Palace and now in the National Gallery [No. 1126]; but recent criticism has proved that the tradition is mistaken which since Vasari's time has ascribed this picture to Botticelli, and that it is in reality the work of a subordinate painter somewhat similarly named, Francesco Botticini.)

A more mature and more celebrated "Adoration of the Magi" than either of those in the National Gallery is that now in the Uffizi, which Botticelli painted for Giovanni Lami, probably in 1477, and which was originally placed over an altar against the front wall of the church of Sta Maria Novella to the right inside the main entrance. The scene is here less crowded than in some other of the master's representations of the subject, the conception entirely sane and masculine, with none of those elements of bizarre fantasy and over-strained sentiment to which he was sometimes addicted and which his imitators so much exaggerated; the execution vigorous and masterly. The picture has, moreover, special interest as containing lifelike portraits of some of the chief members of the Medici family. Like other leading artists of his time in Florence, Botticelli had already begun to profit by the patronage of this family. For the house of Lorenzo II Magnifico in the Via Larga he painted a decorative piece of Pallas with lance and shield (not to be confounded with the banner painted with a similar allegoric device of Pallas by Verrocchio, to be carried by Giuliano de' Medici in the famous tournament in 1475 in which he wore the favour of La Bella Simonetta, the wife of his friend Marco Vespucci). This Pallas by Botticelli is now lost, as are several other decorative works in fresco and panel recorded to have been done by him for Lorenzo II Magnifico between 1475 and Lorenzo's death in 1492. But Sandro's more especial patron, for whom were executed several of his most important still extant works, was another Lorenzo, the son of Pierfrancesco de' Medici, grandson of a natural brother of Cosimo *Pater Patriae*, and inheritor of a vast share of the family estates and interests. For the villa of this younger Lorenzo at Castello Botticelli painted about 1477-1478 the famous picture of "Primavera" or Spring now in the Academy at Florence. The design, inspired by Poliziano's poem the "Giostra," with reminiscences of Lucretius and of Horace (perhaps also, as has lately been suggested, of the late Latin "Mythologikon" of Fulgentius) thrown in, is of an enchanting fantasy, and breathes the finest and most essential spirit of the early Renaissance at Florence. Venus fancifully draped, with Cupid hovering above her, stands in a grove of orange and myrtle and welcomes the approach of Spring, who

enters heralded by Mercury, with Flora and Zephyrus gently urging her on. In pictures like this and in the later "Birth of Venus," the Florentine genius, brooding with passion on the little that it really yet knew of the antique, and using frankly and freshly the much that it was daily learning of the truths of bodily structure and action, creates a style wholly new, in which something of the strained and pining mysticism of the middle ages is intimately and exquisitely blended with the newly awakened spirit of naturalism and the revived pagan delight in bodily form and movement and richness of linear rhythm. In connexion with this and other classic and allegoric pictures by the master, much romantic speculation has been idly spent on the supposition that the chief personages were figured in the likeness of Giuliano de' Medici and Simonetta Vespucci. Simonetta in point of fact died in 1476, Giuliano was murdered in 1478; the web of romance which has been spun about their names in modern days is quite unsubstantial; and there is no reason whatever why Botticelli should have introduced the likenesses of these two supposed lovers (for it is not even certain that they were lovers at all) in pictures all of which were demonstrably painted after the death of one and most of them after the death of both.

The tragedy of Giuliano's assassination by the Pazzi conspirators in 1478 was a public event which certainly brought employment to Botticelli. After the capture and execution of the criminals he was commissioned to paint their effigies hanging by the neck on the walls of the Palazzo del Podestà, above the entrance of what was formerly the Dogana. In the course of Florentine history public buildings had on several previous occasions received a similar grim decoration: the last had been when Andrea del Castagno painted in 1434 the effigies, hanging by the heels, of the chief citizens outlawed and expelled on the return of Cosimo de' Medici. Perhaps from the time of this Pazzi commission may be dated the evidences which are found in some of Botticelli's work of a closer study than heretofore of the virile methods and energetic types of Castagno. His frescoes of the hanged conspirators held their place for sixteen years only, and were destroyed in 1494 in consequence of another revolution in the city's politics. Two years later (1480) he painted in rivalry with Ghirlandajo a grand figure of St Augustine on the choir screen of the Ognissanti, now removed to another part of the church. About the same time we find clear evidence of his contributing designs to the workshops of the "fine-manner" engravers in the shape of a beautiful print of the triumph of Bacchus and Ariadne adapted from an antique sarcophagus (the only example known is in the British Museum), as well as in nineteen small cuts executed for the edition of Dante with the commentary of Landino printed at Florence in 1481 by Lorenzo della Magna. This series of prints was discontinued after canto xix., perhaps because of the material difficulties involved by the use of line engravings for the decoration of a printed page, perhaps because the artist was at this time called away to Rome to undertake the most important commission of his life. Due possibly to the same call is the unfinished condition of a much-damaged, crowded "Adoration of the Magi" by Botticelli preserved in the Uffizi, the design of which seems to have influenced Leonardo da Vinci in his own Adoration (which in like manner remains unfinished) of nearly the same date, also at the Uffizi.

The task with which Botticelli was charged at Rome was to take part with other leading artists of the time (Ghirlandajo, Cosimo Rosselli, Perugino and Pinturicchio) in the decoration of Sixtus IV.'s chapel at the Vatican, the ceiling of which was afterwards destined to be the field of Michelangelo's noblest labours. Internal evidence shows that Sandro and his assistants bore a chief share in the series of papal portraits which decorate the niches between the windows. His share in the decoration of the walls with subjects from the Old and the New Testament consists of three frescoes, one illustrating the history of Moses (several episodes of his early life arranged in a single composition); another the destruction of Korah, Dathan and Abiram; a third the temptation of Christ by Satan (in this case the main theme is relegated to the background, while the foreground is filled with an

animated scene representing the ritual for the purification of a leper). On these three frescoes Botticelli laboured for about a year and a half at the height of his powers, and they may be taken as the central and most important productions of his career, though they are far from being the best-known, and from their situation on the dimmed and stained walls of the chapel are by no means easy of inspection. Skill in the interlinking of complicated groups; in the principal actors energy of dramatic action and expression not yet overstrained, as it came to be in the artist's later work; an incisive vigour of portraiture in the personages of the male bystanders; in the faces and figures of the women an equally vital grasp of the model, combined with that peculiar strain of haunting and melancholy grace which is this artist's own; the most expressive care and skill in linear draughtsmanship, the richest and most inventive charm in fanciful costume and decorative colouring, all combine to distinguish them. During this time of his stay in Rome (1481-1482) Botticelli is recorded also to have painted another "Adoration of the Magi," his fifth or sixth embodiment of the same subject; this has been identified, no doubt rightly, with a picture now in the Hermitage gallery at St Petersburg.

Returning to Florence towards the end of 1482, Botticelli worked there for the next ten years, until the death of Lorenzo II Magnifico in 1492, with but slight variations in manner and sentiment, in the now formed manner of his middle life. Some of the recorded works of this time have perished; but a good many have been preserved, and except in the few cases where the dates of commission and payment can be established by existing records, their sequence can only be conjectured from internal evidence. A scheme of work which he was to have undertaken with other artists in the Sala dei Gigli in the Palazzo Pubblico came to nothing (1483); a set of important mythologic frescoes carried out by him in the vestibule of a villa of Lorenzo II Magnifico at Spedaletto near Volterra in 1484 has been destroyed by the effects first of damp and then of fire. To 1482-1483 belongs the fine altar-piece of San Barnabo (a Madonna and Child with six saints and four angels), now in the academy at Florence. Very nearly of the same time must be the most popular and most often copied, though very far from the best-preserved, of his works, the round picture of the Madonna with singing angels in the Uffizi, known, from the text written in the open choir-book, as the "Magnificat." Somewhere near this must be placed the beautiful and highly finished drawing of "Abundance," which has passed through the Rogers, Morris Moore and Malcolm collections into the British Museum, as well as a small Madonna in the Poldi-Pezzoli collection at Milan, and the fine full-faced portrait of a young man, probably some pupil or apprentice in the studio, at the National Gallery (No. 626). For the marriage of Antonio Pucci to Lucrezia Dini in 1483 Botticelli designed, and his pupils or assistants carried out, the interesting and dramatic set of four panels illustrating Boccaccio's tale of Nastagio degli Onesti, which were formerly in the collection of Mr Barker and are now dispersed. His magnificent and perfectly preserved altar-piece of the Madonna between the two saints John, now in the Berlin gallery, was painted for the Bardi chapel in the church of San Spirito in 1486. In the same year he helped to celebrate the marriage of Lorenzo Tornabuoni with Giovanna degli Albizzi in an exquisite pair of symbolical frescoes, the remains of which, after they had been brought to light from under a coat of whitewash on the walls of the Villa Lemmi, were removed in 1882 to the Louvre. Within a few years of the same date (1485-1488) should apparently be placed that second masterpiece of fanciful classicism done for Lorenzo di Pierfrancesco's villa at Castello, the "Birth of Venus," now in the Uffizi, the design of which seems to have been chiefly inspired by the "Stanze" of Poliziano, perhaps also by the *Pervigilium Veneris*; together with the scarcely less admirable "Mars and Venus" of the National Gallery, conceived in the master's peculiar vein of virile sanity mingled with exquisite caprice; and the most beautiful and characteristic of all his Madonnas, the round of the "Virgin with the Pomegranate" (Uffizi). The fine picture of "Pallas and the Centaur," rediscovered after an

occultation of many years in the private apartments of the Pitti Palace, would seem to belong to about 1488, and to celebrate the security of Florentine affairs and the quelling of the spirit of tumult in the last years of the power of the great Lorenzo (1488-1490). "The Annunciation" from the convent of Castello, now in the Uffizi, shows a design adapted from Donatello, and expressive, in its bending movements and vehement gestures, of that agitation of spirit the signs of which become increasingly perceptible in Botticelli's work from about this time until the end. The great altar-piece at San Marco with its *predelle*, commissioned by the Arte della Seta in 1488 and finished in 1490, with the incomparable ring of dancing and quiring angels encircling the crowned Virgin in the upper sky, is the last of Botticelli's altar-pieces on a great scale. To nearly the same date probably belongs his deeply felt and beautifully preserved small painting of the "Last Communion of St Jerome" belonging to the Marchese Farinola.

In 1490 Botticelli was called to take part with other artists in a consultation as to the completion of the façade of the Duomo, and to bear a share with Alessio Baldovinetti and others in the mosaic decorations of the chapel of San Zenobio in the same church. The death of Lorenzo II Magnifico in 1492, and the accession to chief power of his worthless son Piero, soon plunged Florence into political troubles, to which were by and by added the profound spiritual agitation consequent upon the preaching and influence of Savonarola. Lorenzo di Pierfrancesco de' Medici, who with his brother Giovanni was in a position of political rivalry against their cousin Piero, continued his patronage of Botticelli; and it was for him, apparently chiefly between the years 1492 and 1495, that the master undertook to execute a set of drawings in illustration of Dante on a far more elaborate and ambitious plan than the little designs for the engraver which had been interrupted in 1481. Eighty-five of these drawings are in the famous manuscript acquired for the Berlin museum at the sale of the Hamilton Palace collection in 1882, and eleven more in the Vatican library at Rome. The series is one of the most interesting that has been preserved by any ancient master; revealing an intimate knowledge of and profound sympathy with the text; full of Botticelli's characteristic poetic yearning and vehemence of expression, his half-childish intensity of vision; exquisite in lightness of touch and in swaying, rhythmical grace of linear composition and design. These gifts were less suited to the whole to the illustration of the Hell than of the later parts of the poem, and in the fiercer episodes there is often some puerility and inadequacy of invention. Throughout the Hell and Purgatory Botticelli maintains a careful adherence to the text, illustrating the several progressive incidents of each canto on a single page in the old-fashioned way. In the Paradise he gives a freer rein to his invention, and his designs become less a literal illustration of the text than an imaginative commentary on it. Almost all interest is centred on the persons of Dante and Beatrice, who are shown us again and again in various phases of ascending progress and rapt contemplation, often with little more than a bare symbolical suggestion of the beatific visions presented to them. Most of the drawings remain in pen outline only over a light preliminary sketch with the lead stylus; all were probably intended to be finished in colour, as a few actually are. To the period of these drawings (1492-1497) would seem to belong the fine and finely preserved small round of the "Virgin and Child with Angels" at the Ambrosiana, Milan, and the famous "Calumny of Apelles" at the Uffizi, inspired no doubt by some contemporary translation of the text by Lucian, and equally remarkable by a certain feverish energy in its sentiment and composition, and by its exquisite finish and richness of execution and detail. Probably the small "St Augustine" in the Uffizi, and the injured "Judith with the head of Holofernes" in the Kaufmann collection at Berlin, and the "Virgin and Child with St John," belonging to Mr Heseltine in London, are works of the same period.

Simone di Mariano, a brother of Botticelli long resident at Naples, returned to Florence in 1493 and shared Sandro's home in the Via Nuova. He soon became a devoted follower of

Savonarola, and has left a manuscript chronicle which is one of the best sources for the history of the friar and of his movement. Sandro himself seems to have remained aloof from the movement almost until the date of the execution of Savonarola and his two followers in 1498. At least there is clear evidence of his being in the confidence and employ of Lorenzo di Pierfrancesco so late as 1496 and 1497, which he could not possibly have been had he then been an avowed member of the party of the Piagnoni. It was probably the enforced departure of Lorenzo from Florence in 1497 that brought to a premature end the master's great undertaking on the illustration of Dante. After Lorenzo's return, following on the overthrow and death of Savonarola in 1498, we find no trace of any further relations between him and Botticelli, who by that time would seem to have become a declared devotee of the friar's memory and an adherent, like his brother, of the defeated side. During these years of swift political and spiritual revolution in Florence, documents give some glimpses of him: in 1497 as painting in the monastery of Monticelli a fresco of St Francis which has perished; in the winter of the same year as bound over to keep the peace with a neighbour living next to the small suburban villa which Sandro held jointly with his brother Simone in the parish of San Sepolcro; in 1499 as paying belated matriculation fees to the guild of doctors and druggists (of which the painters were a branch); and again in 1499 as carrying out some decorative paintings for a member of the Vespucci family. It has been suggested, probably with reason, that portions of these decorations are to be recognized in two panels of dramatic scenes from Roman history, one illustrating the story of Virginia, which has passed with the collection of Senatore Morelli into the gallery at Bergamo, the other a history of Lucretia formerly belonging to Lord Ashburnham, which passed into Mrs Gardner's collection at Boston. These and the few works still remaining to be mentioned are all strongly marked by the strained vehemence of design and feeling characteristic of the master's later years, when he dramatizes his own high-strung emotions in figures flung forward and swaying out of all balance in the vehemence of action, with looks cast agonizingly earthward or heavenward, and gestures of wild yearning or appeal. These characters prevail still more in a small Pietà at the Poldi-Pezzoli gallery, probably a contemporary copy of one which the master is recorded to have painted for the Panciatichi chapel in the church of Sta Maria Maggiore; they are present to a degree even of caricature in the larger and coarser painting of the same subject which bears the master's name in the Munich gallery, but is probably only a work of his school. The mystic vein of religious and political speculation into which Botticelli had by this time fallen has its finest illustration in the beautiful symbolic "Nativity" which passed in succession from the Aldobrandini, the Ottley, and the Fuller Maitland collections into the National Gallery in 1882, with the apocalyptic inscription in Greek which the master has added to make his meaning clear (No. 1034). In a kindred vein is a much-injured symbolic "Magdalene at the foot of the Cross" in private possession at Lyons. Among extant pictures those which from internal evidence we must put latest in the master's career are three panels illustrating the story of St Zenobius, of which one is at Dresden and the other two in the collection of Dr Mond in London. The documentary notices of him after 1500 are few. In 1502 he is mentioned in the correspondence of Isabella d'Este, marchioness of Gonzaga, and in a poem by Ugolino Verino. In 1503-1504 he served on the committee of artists appointed to decide where the colossal David of Michelangelo should be placed. In these and the following years we find

lying fees to the company of St Luke, and the next year of him is his death, followed by his burial in the garden burial-ground of the Ognissanti, in May

vein of poetical fantasy and mystical imagination to which many of his paintings testify, and the religious conviction and emotional conversion which made him an ardent, if belated, disciple of Savonarola, in, according to all records, with a strong vein

of the laughing humour and love of rough practical and verbal jesting which belonged to the Florentine character in his age. His studio in the Via Nuova is said to have been the resort, not only of pupils and assistants, of whom a number seem to have been at all times working for him, but of a company of more or less idle goosings with brains full of rumour and tongues always wagging. Vasari's account of the straits into which he was led by his absorption in the study of Dante and his adhesion to the sect of Savonarola are evidently much exaggerated, since there is proof that he lived and died, not rich indeed, but possessed of property enough to keep him from any real pinch of distress. The story of his work and life, after having been the subject in recent years of much half-informed study and speculation, has at length been fully elucidated in the work of Mr H. P. Horne cited below,—a masterpiece of documentary research and critical exposition.

BIBLIOGRAPHY.—Vasari, *Le Opere* (ed. Milanesi), vol. iii.; Crowe-Cavalcaselle, *Hist. of Painting in Italy*, vol. ii.; Dr Lippmann, *Botticelli's Zeichnungen zu Dantes Göttlicher Komödie*; Dr Karl Werrmann, "Sandro Botticelli" (in *Dohme, Kunst u. Künstler*); Dr Hermann Ulmann, *Sandro Botticelli*; Dr E. Steinmann, *Sandro Botticelli* (in *Knackfuss* series, valuable for the author's elucidation of the Sixtine frescoes); I. B. Supino, *Sandro Botticelli*; Bernhard Berenson, *The Drawings of the Florentine Painters*; *The Florentine Painters of the Renaissance* (2nd ed.); *The Study and Criticism of Italian Art*; papers in the *Burlington Magazine*, the *Gazette des Beaux-Arts* (to this critic is due the first systematic attempt to discriminate between the original work of Botticelli and that of his various pupils); J. Mesnil, *Miscellanea d'Arte* and papers in the *Rivista d'Arte*, &c.; W. Warburg, *Sandro Botticelli's "Geburt der Venus" and "Frühling"*; Julia Cartwright (Mrs Ady), *The Life and Art of Sandro Botticelli* (1904); F. Wickhoff in the *Jahrbuch der k. Preussischen Kunstsammlungen* (1906); Herbert P. Horne, *Alessandro Filipepi commonly called Sandro Botticelli* (1908); this last authority practically supersedes all others. (S. C.)

BÖTTIGER, KARL AUGUST (1760-1835), German archaeologist, was born at Reichenbach on the 8th of June 1760. He was educated at the school of Pforta, and the university of Leipzig. After holding minor educational posts, he obtained in 1791, through the influence of Herder, the appointment of rector of the gymnasium at Weimar, where he entered into a circle of literary men, including Wieland, Schiller, and Goethe. He published in 1803 a learned work, *Sabina, oder Morgensenen im Putzsimmer einer reichen Römerin*, a description of a wealthy Roman lady's toilette, and a work on ancient art, *Griechische Vasengemälde*. At the same time he assisted in editing the *Journal des Luxus und der Moden*, the *Deutsche Merkur*, and the *London and Paris*. In 1804 he was called to Dresden as superintendent of the studies of the court pages, and received the rank of privy councillor. In 1814 he was made director of studies at the court academy, and inspector of the Museum of Antiquities. He died at Dresden on the 17th of November 1835. His chief works are:—*Ideen zur Archäologie der Malerei*, i. (1811) (no more published); *Kunstmythologie* (1811); *Vorlesungen und Aufsätze zur Alterthumskunde* (1817); *Amalthea* (1821-1825); *Ideen zur Kunstmythologie* (1826-1836). The *Opuscula et Carmina Latina* were published separately in 1837; with a collection of his smaller pieces, *Kleine Schriften* (1837-1838), including a complete list of his works (56 pages). His biography was written by his son Karl Wilhelm Böttiger (1790-1862), for some time professor of history at Erlangen, and author of several valuable histories (*History of Germany*, *History of Saxony*, *History of Bavaria*, *Universal History of Biographies*).

BOTTLE (Fr. *bouteille*, from a diminutive of the Lat. *butta*, a flask; cf. Eng. "butt"), a vessel for containing liquids, generally as opposed to one for drinking from (though this probably is not excluded), and with a narrow neck to facilitate closing and pouring. The first bottles were probably made of the skins of animals. In the *Iliad* (iii. 247) the attendants are represented as bearing wine for use in a bottle made of goat's skin. The ancient Egyptians used skins for this purpose, and from the language employed by Herodotus (ii. 121), it appears that a bottle was formed by sewing up the skin and leaving the projection of the leg and foot to serve as a vent, which was hence termed *robov*. The aperture was closed with a plug or a string. Skin

bottles of various forms occur on Egyptian monuments. The Greeks and Romans also were accustomed to use bottles made of skins; and in the southern parts Europe they are still used for the transport of wine. The first of explicit reference to bottles of skin in Scripture occurs in Joshua (ix. 4), where it is said that the Gibeonites took "old sacks upon their asses, and wine-bottles old and rent and bound up." The objection to putting "new wine into old bottles" (Matt. ix. 17) is that the skin, already stretched and weakened by use, is liable to burst under the pressure of the gas from new wine. Skins are still most extensively used throughout western Asia for the conveyance and storage of water. It is



Roman Skin Bottles, from specimens at Pompeii and Herculaneum.

an error to represent the bottles of the ancient Hebrews as being made exclusively of skins. In Jer. xix. 1 the prophet speaks of "a potter's earthen vessel." The Egyptians (see Egypt: *Art and Archaeology*) possessed vases and bottles of hard stone, alabaster, glass, ivory, bone, porcelain, bronze, silver and gold, and also of glazed pottery or common earthenware. In modern times bottles are usually made of glass (q.v.), or occasionally of earthenware. The glass bottle industry has attained enormous dimensions, whether for wine, beer, &c., or mineral waters; and labour-saving machinery for filling the bottles has been introduced, as well as for corking or stoppering, for labelling and for washing them.

BOTTLE-BRUSH PLANTS, a genus of Australian plants, known botanically as *Callistemon*, and belonging to the myrtle family (Myrtaceae). They take their name from the resemblance of the head of flowers to a bottle-brush. They are well known in cultivation as greenhouse shrubs; the flower owes its beauty to the numerous long thread-like stamens which far exceed the small petals. *Callistemon salignus* is a valuable hard wood.

BOTTLENOSE WHALE (*Hyperoodon rostratus*), a member of the sperm-whale family, which is an inhabitant of the North Atlantic, passing the summer in the Spitzbergen seas and going farther south in winter. It resembles the sperm-whale in possessing a large store of oil in the upper part of the head, which yields spermaceti when refined, on this account, and also for the sake of the blubber, which supplies an oil almost indistinguishable from sperm-oil, this whale became the object of a regular chase in the latter half of the 19th century. In length these whales vary between 20 ft. and 30 ft.; and in colour from black on the upper surface in the young to light brown in old animals, the under-parts being greyish white. There is no notch between the flukes, as in other whales, but the hinder part of the tail is rounded. Bottlenoses feed on cuttle-fishes and squills, and are practically toothless; the only teeth which exist in the adult being a small pair at the front of the lower jaw, concealed beneath the gum during life. Examples have frequently been recorded on the British coasts. In November 1904 a female, 24 ft. long, and a calf 15 ft. long were driven ashore at Whitstable. (See CETACEA.)

BOTTOMRY, a maritime contract by which a ship (or bottom) is hypothecated in security for money borrowed for expenses incurred in the course of her voyage, under the condition that if she arrive at her destination the ship shall be liable for repayment of the loan, together with such premium thereon as may have been agreed for; but that if the ship be lost, the lender shall have no claim against the borrower either for the sum advanced or for the premium. The freight may be pledged as well as the ship, and, if necessary, the cargo also. In some cases the personal obligation of the shipmaster is also included. When money is borrowed on the security of the cargo alone, it is said to be taken up at *respondentia*; but it is now only in rare and exceptional

cases that it could be competent to the shipmaster to pledge the cargo, except under a general bottomry obligation, along with the ship and freight. In consideration of the risks assumed by the lender, the bottomry premium (sometimes termed *maritime interest*) is usually high, varying of course with the nature of the risk and the difficulty of procuring funds.

A bottomry contract may be written out in any form which sufficiently shows the conditions agreed on between the parties; but it is usually drawn up in the form of a *bond* which confers a maritime lien (q.v.). The document must show, either by express terms or from its general tenor, that the risk of loss is assumed by the lender,—this being the consideration for which the high premium is conceded. The lender may transfer the bond by indorsation, in the same manner as a bill of exchange or bill of lading, and the right to recover its value becomes vested in the indorsee. (See BOND.)

According to the law of England, a bottomry contract remains in force so long as the ship exists *in the form of a ship*, whatever amount of damage she may have sustained. Consequently, the "constructive total loss" which is recognized in marine insurance, when the ship is damaged to such an extent that she is not worth repairing, is not recognized in reference to bottomry, and will not absolve the borrower from his obligation. But if the ship go to pieces, the borrower is freed from all liability under the bottomry contract; and the lender is not entitled to receive any share of the proceeds of such of the ship's stores or materials as may have been saved from the wreck. Money advanced on bottomry is not liable in England for general average losses. If the ship should *deviate* from the voyage for which the funds were advanced, her subsequent loss will not discharge the obligation of the borrower under the bottomry contract. If she should not proceed at all on her intended voyage, the lender is not entitled to recover the bottomry premium in addition to his advance, but only the ordinary rate of interest for the temporary loan. As the bottomry premium is presumed, in every case, to cover the risks incurred by the lender, he is not entitled to charge the borrower with the premium which he may pay for *insurance* of the sum advanced, in addition to that stipulated in the bond.

The contract of bottomry seems to have arisen from the custom of permitting the master of a ship, when in a foreign country, to pledge the ship in order to raise money for repairs, or other extraordinary expenditures rendered necessary in the course of the voyage. Circumstances often arise, in which, without the exercise of this power on the part of the master, it would be impossible to provide means for accomplishing the voyage; and it is better that the master should have authority to burden the ship, and, if necessary, the freight and cargo also, in security for the money which has become requisite, than that the adventure should be defeated by inability to proceed. But the right of the master to pledge the ship or goods must always be created by necessity; if exercised without necessity the contract will be void. Accordingly, the master of a British ship has no power to grant a bottomry bond at a British port, or at any foreign port where he might raise funds on the personal credit of the shipowners. Neither has he any power to pledge the ship or goods for private debts of his own, but only for such supplies as are indispensable for the purposes of the voyage. And in all cases he ought, if possible, to communicate with the owners of the ship, and with the proprietor of the cargo before pledging their property ("The Bonaparte," 1853, 8 Moo. P.C. 473; "The Staffordshire," 1872, L.R. 4 P.C. 194). Increased facility of communication, by telegraph and otherwise, has given additional stringency to this rule, and caused a decline in the practice of giving bottomry bonds.

The bottomry lender must use reasonable diligence to ascertain that a real necessity exists for the loan; but he is not bound to see to the application of the money advanced. If the lender has originally advanced the funds on the personal credit of the owner he is not entitled to require a bottomry obligation. A bond procured from the shipmaster by improper compulsion would be void.

The power of the master to pledge the cargo depends upon there being some reasonable prospect of benefit to it by his so doing. He has no such power except in virtue of circumstances which may oblige him to assume the character of *agent for the cargo*, in the absence of any other party authorized to act on its behalf. Under ordinary circumstances he is not at liberty to pledge the cargo for repairs to the ship. If indeed the goods be of a perishable nature, and if it be impossible to get the ship repaired in sufficient time to obviate serious loss on them by delay, without including them under the bottomry contract, he has power to do so, because it may fairly be assumed, in the case supposed, that the cargo will be benefited by this procedure. The general principle is, that the master must act for the cargo, with a reasonable view to the interests of its proprietors, under the whole circumstances of the case. When he does this his proceedings will be sustained; but should he manifestly prejudice the interests of the cargo by including it under bottomry for the mere purpose of relieving the ship, or of earning the freight, the owners of the cargo will not be bound by the bottomry contract. Any bottomry or respondentia bond may be good in part or bad in part, according as the master may have acted *within or beyond* the scope of his legitimate authority in granting it. If two or more bottomry bonds have been granted at different stages of the voyage, and the value of the property be insufficient to discharge them all, the last-dated bond has the priority of payment, as having furnished the means of preserving the ship, and thereby preventing the total loss of the security for the previous bonds.

When the sum due under a bottomry bond over ship, freight and cargo is not paid at the stipulated time, proceedings may be taken by the bondholder for recovery of the freight and for the sale of the ship; and should the proceeds of these be insufficient to discharge the claim, a judicial sale of the cargo may be resorted to. As a general rule the value of the ship and freight must be exhausted before recourse can be taken against the cargo. A bottomry bond gives no remedy to the lenders against the owners of the ship or cargo personally. The whole liability under it may be met by the surrender of the property pledged, whether the value so surrendered covers the amount of the bond or not. But the owners of the ship, though not liable to the bondholder for more than the value of the ship and freight, may be further liable to the proprietors of the cargo for any sum in excess of the cargo's proper share of the expenses, taken by the bondholder out of the proceeds of the cargo to satisfy the bond, after the ship and freight have been exhausted.

The bottomry premium must be ultimately paid by the parties for whose benefit the advances were obtained, as ascertained on the final adjustment of the average expenditures at the port of destination.

The practice of pledging property subject to maritime risks was common among the ancient Greeks, being known as *ὑπότοις* or *ὑπότοκος* (see Demosthenes' speeches *Pro Phormione*, *Contra Lacritum* and *In Dionysodorum*); it passed into Roman law as *foenus nauticum* or *usura maritima*.

See also *LITEN: Maritime*; and generally Abbott on *Shipping* (14th ed., 1901).

BOTZARIS [BOZZARIS], MARCO (c. 1788–1823), leader in the War of Greek Independence, born at Suli in Albania, was the second son of Kitzo Botzaris, murdered at Arta in 1809 by order of Ali of Iannina. In 1803, after the capture of Suli by Ali Pasha, Marco, with the remnant of the Suliots, crossed over to the Ionian Islands, where he ultimately took service in an Albanian regiment in French pay. In 1814 he joined the Greek patriotic society known as the *Hetairia Philike*, and in 1820, with other Suliots, made common cause with Ali of Iannina against the Ottomans. On the outbreak of the Greek revolt, he distinguished himself by his courage, tenacity and skill as a partisan leader in the fighting in western Hellas, and was conspicuous in the defence of Missolonghi during the first siege (1822–1823). On the night of the 21st of August 1823 he led the celebrated attack at Karpenisi of 350 Suliots on 4000 Albanians who formed the vanguard of the army with which Mustai Pasha was advancing to reinforce the besiegers. The rout of the Turks

was complete; but Botzaris himself fell. His memory is still celebrated in popular ballads in Greece. Marco Botzaris's brother Kosta (Constantine), who fought at Karpenisi and completed the victory, lived to become a general and senator in the Greek kingdom. He died at Athens on the 13th of November 1853. Marco's son, Dimitri Botzaris, born in 1813, was three times minister of war under the kings Otho and George. He died at Athens on the 17th of August 1870.

BOTZEN, or **BOZEN** (Ital. *Bolzano*), a town in the Austrian province of Tirol, situated at the confluence of the Talfer with the Eisak, and a short way above the junction of the latter with the Adige or Etsch. It is built at a height of 869 ft., and is a station on the Brenner railway, being 58 m. S. of that pass and 35 m. N. of Trent. In 1900 it had a population of 13,632, Romanist and mainly German-speaking, though the Italian element is said to be increasing. Botzen is a Teutonic town amid Italian surroundings. It is well built, and boasts of a fine old Gothic parish church, dating from the 14th and 15th centuries, opposite which a statue was erected in 1889 to the memory of the famous *Minnesänger*, Walther von der Vogelweide, who, according to some accounts, was born (c. 1170) at a farm above Waidbruck, to the north of Botzen. Botzen is the busiest commercial town in the German-speaking portion of Tirol, being admirably situated at the junction of the Brenner route from Germany to Italy with that from Switzerland down the Upper Adige valley or the Vintschgau. Hence the transit trade has always been very considerable (it has four large fairs annually), while the local wine is mentioned as early as the 7th century. Lately its prosperity has been increased by the rise into favour as a winter resort of the village of Gries, on the other bank of the Talfer, and now practically a suburb of Botzen.

The *pons Drusi* (probably over the Adige, just below Botzen) is mentioned in the 4th century by the *Pestinger Table*. In the 7th to 8th centuries Botzen was held by a dynasty of Bavarian counts. But in 1027, with the rest of the diocese of Trent, it was given by the emperor Conrad II. to the bishop of Trent. From 1028 onwards it was ruled by local counts, the vassals of the bishops, but after Tirol fell into the hands of the Habsburgers (1363) their power grew at the expense of that of the bishops. In 1381 Leopold granted to the citizens the privilege of having a town council, while in 1462 the bishops resigned all rights of jurisdiction over the town to the Habsburgers, so that its later history is merged in that of Tirol. (W. A. B. C.)

BOUCHARDON, EDMÉ (1698–1762), French sculptor, was esteemed in his day the greatest sculptor of his time. Born at Chaumont, he became the pupil of Guillaume Coustou and gained the *prix de Rome* in 1722. Resisting the tendency of the day he was classic in his taste, pure and chaste, always correct, charming and distinguished, a great stickler for all the finish that sand-paper could give. During the ten years he remained at Rome, Bouchardon made a striking bust of Pope Benedict XIII. (1730). In 1746 he produced his first acclaimed masterpiece, "Cupid fashioning a Bow out of the Club of Hercules," perfect in its grace, but cold in the purity of its classic design. His two other leading *chefs-d'œuvre* are the fountain in the rue de Grenelle, Paris, the first portions of which had been finished and exhibited in 1740, and the equestrian statue of Louis XV., a commission from the city of Paris. This superb work, which, when the model was produced, was declared the finest work of its kind ever produced in France, Bouchardon did not live to finish, but left its completion to Pigalle. It was destroyed during the Revolution.

Among the chief books on the sculptor and his art are *Vie d'Edmé Bouchardon*, by le comte de Caylus (Paris, 1762); *Notice sur Edmé Bouchardon, sculpteur*, by E. Jolibois (Versailles, 1837); *Notice historique sur Edmé Bouchardon*, by J. Carnandet (Paris, 1855); and *French Architects and Sculptors of the 18th Century*, by Lady Dilke (London, 1900).

BOUCHER, FRANÇOIS (1703–1770), French painter, was born in Paris, and at first was employed by Jean François Cars (1670–1739), the engraver, father of the engraver Laurent Cars (1690–1771), to make designs and illustrations for books. In 1727,

however, he went to Italy, and at Rome became well known as a painter. He returned to Paris in 1731 and soon became a favourite in society. His picture "Rinaldo and Armida" (1734) is now in the Louvre. He was made inspector of the Gobelins factory in 1755 and court painter in 1765, and was employed by Madame de Pompadour both to paint her portrait and to execute various decorative works. He died in 1770. His Watteau-like style and graceful voluptuousness gave him the title of the Anacreon of painting, but his repute declined until recent years. The Wallace collection, at Hertford House, has some of his finest pictures, outside the Louvre. His etchings were also numerous and masterly.

See Antoine Bret's notice in the *Nécrologe des hommes célèbres* for 1771, and the monographs by the brothers de Goncourt and Paul Mantz.

BOUCHER, JONATHAN (1738–1804), English divine and philologist, was born in the hamlet of Blencogo, near Wigton, Cumberland, on the 12th of March 1738. He was educated at the Wigton grammar school, and about 1754 went to Virginia, where he became a private tutor in the families of Virginia planters. Among his charges was John Parke Custis, the step-son of George Washington, with whom he began a long and intimate friendship. Returning to England, he was ordained by the bishop of London in March 1762, and at once sailed again for America, where he remained until 1775 as rector of various Virginia and Maryland parishes, including Hanover, King George's county, Virginia, and St Anne's at Annapolis, Maryland. He was widely known as an eloquent preacher, and his scholarly attainments won for him the friendship and esteem of some of the ablest scholars in the colonies. During his residence in Maryland he vigorously opposed the "vestry act," by which the powers and emoluments of the Maryland pastors were greatly diminished. When the struggle between the colonies and the mother country began, although he felt much sympathy for the former, his opposition to any form of obstruction to the Stamp Act and other measures, and his denunciation of a resort to force created a breach between him and his parish, and in a fiery farewell discourse preached after the opening of hostilities he declared that no power on earth should prevent him from praying and shouting "God save the King." In the succeeding autumn he returned to England, where his loyalism was rewarded by a government pension. In 1784 he became vicar of Epsom in Surrey, where he continued until his death on the 27th of April 1804, becoming known as one of the most eloquent preachers of his day. He was an accomplished writer and scholar, contributed largely to William Hutchinson's *History of the County of Cumberland* (2 vols., 1794 seq.), and published *A View of the Causes and Consequences of the American Revolution* (1797), dedicated to George Washington, and consisting of thirteen discourses delivered in America between 1763 and 1775. His philological studies, to which the last fourteen years of his life were devoted, resulted in the compilation of "A Glossary of Provincial and Archaic Words," intended as a supplement to Dr Johnson's *Dictionary*, but never published except in part, which finally in 1831 passed into the hands of the English compilers of Webster's *Dictionary*, by whom it was utilized.

His son, **BARTON BOUCHER** (1794–1865), rector of Fonthill Bishops, Wiltshire, in 1856, was well known as the author of religious tracts, hymns and novels.

BOUCHER DE CRÈVECŒUR DE PERTHES, JACQUES (1788–1868), French geologist and antiquary, was born on the 10th of September 1788 at Rethel, Ardennes, France. He was the eldest son of Jules Armand Guillaume Boucher de Crèvecœur, botanist and customs officer, and of Étienne-Jeanne-Marie de Perthes (whose surname he was authorized by royal decree in 1818 to assume in addition to his father's). In 1802 he entered government employ as an officer of customs. His duties kept him for six years in Italy, whence returning (in 1811) he found rapid promotion at home, and finally was appointed (March 1825) to succeed his father as director of the *douane* at Abbeville, where he remained for the rest of his life, being superannuated in January 1853, and dying on the 5th of August 1868. His

leisure was chiefly devoted to the study of what was afterwards called the Stone Age, "antediluvian man," as he expressed it. About the year 1830 he had found, in the gravels of the Somme valley, flints which in his opinion bore evidence of human handiwork; but not until many years afterwards did he make public the important discovery of a worked flint implement with remains of elephant, rhinoceros, &c., in the gravels of Menchecourt. This was in 1846. A few years later he commenced the issue of his monumental work, *Antiquités celtiques et an édiluviennes* (18 7, 1857, 1864; 3 vols.), a work in which he was the first to establish the existence of man in the Pleistocene or early Quaternary period. His views met with little approval, partly because he had previously propounded theories regarding the antiquity of man without facts to support them, partly because the figures in his book were badly executed and they included drawings of flints which showed no clear sign of workmanship. In 1855 Dr Jean Paul Rigollot (1810–1873), of Amiens, strongly advocated the authenticity of the flint implements; but it was not until 1858 that Hugh Falconer (*q.v.*) saw the collection at Abbeville and induced Prestwich (*q.v.*) in the following year to visit the locality. Prestwich then definitely agreed that the flint implements were the work of man, and that they occurred in undisturbed ground in association with remains of extinct mammalia. In 1863 his discovery of a human jaw, together with worked flints, in a gravel-pit at Moulins-Quignon near Abbeville seemed to vindicate Boucher de Perthes entirely; but doubt was thrown on the antiquity of the human remains (owing to the possibility of interment), though not on the good faith of the discoverer, who was the same year made an officer of the Legion of Honour together with Quatrefages his champion. Boucher de Perthes displayed activity in many other directions. For more than thirty years he filled the presidential chair of the Société d'Émulation at Abbeville, to the publications of which he contributed articles on a wide range of subjects. He was the author of several tragedies, two books of fiction, several works of travel, and a number of books on economic and philanthropic questions. To his scientific books may be added *De l'homme antédiluvien et de ses œuvres* (Paris, 1860).

See Alcuis Ledien, *Boucher de Perthes; sa vie, ses œuvres, sa correspondance* (Abbeville, 1885); Lady Prestwich, "Recollections of M. Boucher de Perthes" (with portrait) in *Essays Descriptive and Biographical* (1901).

BOUCHES-DU-RHÔNE, a maritime department of south-eastern France situated at the mouth of the Rhone. Area, 20.6 sq. m. Pop. (1906) 765,918. Formed in 1790 from western Provence, it is bounded N. by Vaucluse, from which it is separated by the Durance, E. by Var, W. by Gard, and S. by the Mediterranean, along which its seaboard stretches for about 120 m. The western portion consists of the Camargue (*q.v.*), a low and marshy plain enclosed between the Rhone and the Petit-Rhône, and comprising the Rhone delta. A large portion of its surface is covered by lagoons and pools (*lans*), the largest of which is the Étang de Vaccarès; to the east of the Camargue is situated the remarkable stretch of country called the Crau, which is strewn with pebbles like the sea-beach; and farther east and north there are various ranges of mountains of moderate elevation belonging to the Alpine system. The Étang de Berre, a lagoon covering an area of nearly 60 sq. m., is situated near the sea to the south-east of the Crau. A few small tributaries of the Rhone and the Durance, a number of streams, such as the Arc and the Touloubre, which flow into the Étang de Berre, and the Huveaune, which finds its way directly to the sea, are the only rivers that properly belong to the department.

Bouches-du-Rhône enjoys the beautiful climate of the Mediterranean coast, the chief drawback being the mistral, the icy north-west wind blowing from the central plateau of France. The proportion of arable land is small, though the quantity has been considerably increased by artificial irrigation and by the draining of marshland. Cereals, of which wheat and oats are the commonest, are grown in the Camargue and the plain of Arles, but they are of less importance than the olive-tree, which

is grown largely in the east of the department and supplies the oil-works of Marseilles. The vine is also cultivated, the method of submersion being used as a safeguard against phylloxera. In the cantons of the north-west large quantities of early vegetables are produced. Of live-stock, sheep alone are raised to any extent. Almonds, figs, capers, mulberry trees and silk-worms are sources of considerable profit. Iron is worked, but the most important mines are those of lignite, in which between 2000 and 3000 workmen are employed; the department also produces bauxite, building-stone, lime, cement, gypsum, clay, sand and gravel and marble. The salt marshes employ many workmen, and the amount of sea-salt obtained exceeds in quantity the produce of any other department in France. Marseilles, the capital, is by far the most important industrial town. In its oil-works, soap-works, metallurgical works, shipbuilding works, distilleries, flour-mills, chemical works, tanneries, engineering and machinery works, brick and tile works, manufactories of preserved foods and biscuits, and other industrial establishments, is concentrated most of the manufacturing activity of the department. To these must be added the potteries of the industrial town of Aubagne, the silk-works in the north-west cantons, and various paper and cardboard manufactories, while several of the industries of Marseilles, such as the distilling of oil, metal-founding, shipbuilding and soap-making, are common to the whole of Bouches-du-Rhône. Fishing is also an important industry. Cereals, flour, silk, woollen and cotton goods, wine, brandy, oils, soap, sugar and coffee are chief exports; cereals, oil-seeds, wine and brandy, raw sugar, cattle, timber, silk, wool, cotton, coal, &c., are imported. The foreign commerce of the department, which is principally carried on in the Mediterranean basin, is for the most part concentrated in the capital; the minor ports are Martigues, Cassis and La Ciotat. Internal trade is facilitated by the canal from Arles to Port-de-Bouc and two smaller canals, in all about 35 m. in length. The Rhone and the Petit-Rhône are both navigable within the department.

Bouches-du-Rhône is divided into the three arrondissements of Marseilles, Aix and Arles (33 cantons, 111 communes). It belongs to the archiepiscopal province of Aix, to the region of the XV. army corps, the headquarters of which are at Marseilles, and to the *académie* (educational division) of Aix. Its court of appeal is at Aix. Marseilles, Aix, Arles, La Ciotat, Martigues, Salon, Les Saintes-Maries, St Rémy, Les Baux and Tarascon, the principal places, are separately noticed. Objects of interest elsewhere may be mentioned. Near Saint-Chamas there is a remarkable Roman bridge over the Touloubre, which probably dates from the 1st century B.C. and is thus the oldest in France. It is supported on one semicircular span and has triumphal arches at either end. At Vernègues there are remains of a Roman temple known as the "Maison-Basse." The famous abbey of Montmajour, of which the oldest parts are the Romanesque church and cloister, is 2½ m. from Arles. At Oyon there are the ruins of a château of the 15th century, and near La Roque d'Anthéron the church and other buildings of the Cistercian abbey of Silvacane, founded in the 12th century.

BOUCHOR, MAURICE (1855—), French poet, was born on the 15th of December 1855 in Paris. He published in succession *Chansons joyeuses* (1874), *Poèmes de l'amour et de la mer* (1875), *Le Faust moderne* (1878) in prose and verse, and *Les Contes persiciens* (1880) in verse. His *Aurore* (1883) showed a tendency to religious mysticism, which reached its fullest expression in *Les Symboles* (1888; new series, 1895), the most interesting of his works. Bouchor (whose brother, Joseph Félix Bouchor, b. 1853, became well known as an artist) was a sculptor as well as a poet, and he designed and worked the figures used in his charming pieces as marionettes, the words being recited or chanted by himself or his friends behind the scenes. These miniature dramas on religious subjects, *Tobie* (1889), *Noël* (1890) and *Sainte Cécile* (1892), were produced in Paris at the Théâtre des Marionnettes. A one-act verse drama by Bouchor, *Comte de Noël*, was played at the Théâtre Français in 1895, but *Dieu le veut* (1888) was not produced. In conjunction with the musician Julien Tiersot (b. 1857), he made efforts for the preservation of

the French folk-songs, and published *Chants populaires pour les écoles* (1897).

BOUCHOTTE, JEAN BAPTISTE NOËL (1754-1840), French minister, was born at Metz on the 25th of December 1754. At the outbreak of the Revolution he was a captain of cavalry, and his zeal led to his being made colonel and given the command at Cambrai. When Dumouriez delivered up to the Austrians the minister of war, the marquis de Beurnonville, in April 1793, Bouchotte, who had bravely defended Cambrai, was called by the Convention to be minister of war, where he remained until the 31st of March 1794. The predominant rôle of the Committee of Public Safety during that period did not leave much scope for the new minister, yet he rendered some services in the organization of the republican armies, and chose his officers with insight, among them Kléber, Masséna, Moreau and Bonaparte. During the Thermidorian reaction, in spite of his incontestable honesty, he was accused by the anti-revolutionists. He was tried by the tribunal of the Eure-et-Loire and acquitted. Then he withdrew from politics, and lived in retirement until his death on the 8th of June 1840.

BOUCICAULT, DION (1822-1890), Irish actor and playwright, was born in Dublin on the 26th of December 1822, the son of a French refugee and an Irish mother. Before he was twenty he was fortunate enough to make an immediate success as a dramatist with *London Assurance*, produced at Covent Garden on the 4th of March 1841, with a cast that included Charles Matthews, William Farren, Mrs Nesbitt and Madame Vestris. He rapidly followed this with a number of other plays, among the most successful of the early ones being *Old Heads and Young Hearts*, *Louis XI.*, and *The Corsican Brothers*. In June 1852 he made his first appearance as an actor in a melodrama of his own entitled *The Vampire* at the Princess's theatre. From 1853 to 1869 he was in the United States, where he was always a popular favourite. On his return to England he produced at the Adelphi a dramatic adaptation of Gerald Griffin's novel, *The Collegians*, entitled *The Colleen Bawn*. This play, one of the most successful of modern times, was performed in almost every city of the United Kingdom and the United States, and made its author a handsome fortune, which he lost in the management of various London theatres. It was followed by *The Octoroon* (1861), the popularity of which was almost as great. Boucicault's next marked success was at the Princess's theatre in 1865 with *Arrah-na-Pogue*, in which he played the part of a Wicklow carman. This, and his admirable creation of Con in his play *The Shaughrans* (first produced at Drury Lane in 1875), won him the reputation of being the best stage Irishman of his time. In 1875 he returned to New York City and finally made his home there, but he paid occasional visits to London, where his last appearance was made in his play, *The Jilt*, in 1886. *The Streets of London* and *After Dark* were two of his late successes as a dramatist. He died in New York on the 18th of September 1890. Boucicault was twice married, his first wife being Agnes Robertson, the adopted daughter of Charles Kean, and herself an actress of unusual ability. Three children, Dion (b. 1859), Aubrey (b. 1868) and Nina, also became distinguished in the profession.

BOUCICAUT, JEAN [JEAN LE MEINGRE, called BOUCICAUT] (c. 1366-1421), marshal of France, was the son of another Jean le Meingre, also known as Boucicaut, marshal of France, who died on the 15th of March 1368 (N.S.). At a very early age he became a soldier; he fought in Normandy, in Flanders and in Prussia, distinguishing himself at the battle of Roosebeke in 1382; and then after a campaign in Spain he journeyed to the Holy Land. Boucicaut's great desire appears to have been to fight the Turk, and in 1396 he was one of the French soldiers who marched to the defence of Hungary and shared in the Christian defeat at Nicopolis, where he narrowly escaped death. After remaining for some months a captive in the hands of the sultan, he obtained his ransom and returned to France; then in 1399 he was sent at the head of an army to aid the Eastern emperor, Manuel II., who was harassed by the Turks. Boucicaut drove the enemy from his position before Constantinople and returned to France for fresh troops, but instead of proceeding

again to eastern Europe, he was despatched in 1401 to Genoa, who in 1396 had placed herself under the dominion of France. Here he was successful in restoring order and in making the French occupation effective, and he was soon able to turn his attention to the defence of the Genoese possessions in the Mediterranean. The energy which he showed in this direction involved him not only in a quarrel with Janus, king of Cyprus, but led also to a short war with Venice, whose fleet he encountered off Modon in the Archipelago in October 1403. This battle has been claimed by both sides as a victory. Peace was soon made with the republic, and then in 1409, while the marshal was absent on a campaign in northern Italy, Genoa threw off the French yoke, and Boucicaut, unable to reduce her again to submission, retired to Languedoc. He fought at Agincourt, where he was taken prisoner, and died in England. Boucicaut, who was very skillful in the tournament, founded the order of the *Dame blanche à l'écu vert*, a society the object of which was to defend the wives and daughters of absent knights.

There is in existence an anonymous account of Boucicaut's life and adventures, entitled *Livre des faits du bon messire Jean le Meingre dit Boucicaut*, which was published in Paris by T. Godefroy in 1620. See J. Delaville le Roux, *La France en Orient: expéditions du maréchal Boucicaut* (Paris, 1886).

BOUDIN, EUGÈNE (1824-1898), French painter of the *paysage de mer*, was the son of a pilot. Born at Honfleur he was cabin-boy for a while on board the rickety steamer that plied between Havre and Honfleur across the estuary of the Seine. But before old age came on him, Boudin's father abandoned seafaring, and the son gave it up too, having of course no real vocation for it, though he preserved to his last days much of a sailor's character,—frankness, accessibility, open-heartedness. Boudin the elder now established himself as stationer and frame-maker; this time in the greater seaport town of Havre; and Eugène helped in the little business, and, in stolen hours, produced certain drawings. That was a time at which the romantic outlines of the Norman coast engaged Isabey, and the green wide valleys of the inland country engaged Troyon; and Troyon and Isabey, and Millet too, came to the shop at Havre. Young Boudin found his desire to be a painter stimulated by their influence; his work made a certain progress, and the interest taken in the young man resulted in his being granted for a short term of years by the town of his adoption a pension, that he might study painting. He studied partly in Paris; but whatever individuality he possessed in those years was hidden and covered, rather than disclosed. An instance of tiresome, elaborate labour—good enough, no doubt, as groundwork, and not out of keeping with what at least was the popular taste of that day—is his "Pardon of Sainte Anne de la Palud," a Breton scene, of 1858, in which he introduced the young Breton woman who was immediately to become his wife. This conscientious and unmoving picture hangs in the museum of Havre, along with a hundred later, fresher, thoroughly individual studies and sketches, the gift of Boudin's brother, Louis Boudin, after the painter's death. Re-established at Honfleur, Boudin was married and poor. But his work gained character and added, to merely academic correctness, character and charm. He was beginning to be himself by 1864 or 1865—that was the first of such periods of his as may be accounted good—and, though not at that time so fully a master of transient effects of weather as he became later, he began then to paint with a success genuinely artistic the scenes of the harbour and the estuary, which no longer lost vivacity by deliberate and too obvious completeness. The war of 1870-71 found Boudin impecunious but great, for then there had well begun the series of freshly and vigorously conceived canvases and panels, which record the impressions of a precursor of the Impressionists in presence of the Channel waters, and of those autumn skies, or skies of summer, now radiant, now uncertain, which hung over the small ports and the rocky or chalk-cliff coasts, over the watering-places, Trouville, Dieppe, and over those larger harbours, with *port* and *avant-port* and *bassin*, of Dunkirk, of Havre. In the war time, Boudin was in Brittany and then in the Low Countries. About 1875-

1876 he was at Rotterdam and Bordeaux. That great bird's-eye vision of Bordeaux which is in the Luxembourg dates from these years, and in these years he was at Rotterdam, the companion of Jongkind, with whom he had so much in common, but whose work, like his, free and fearless and unconventional, can never be said with accuracy to have seriously influenced his own. Doing excellent things continually through all the 'seventies, when he was in late middle age—gaining scope in colour, having now so many notes—faithful no longer wholly to his amazing range of subtle greys, now blithe and silvery, now nobly deep—sending to the Salon great canvases, and to the few enlightened people who would buy them of him the *toile* or panel of most moderate size on which he best of all expressed himself—Boudin was yet not acceptable to the public or to the fashionable dealer. The late 'eighties had to come and Boudin to be elderly before there was a sale for his work at any prices that were in the least substantial. Broadly speaking his work in those very 'eighties was not so good as the labour, essentially delicate and fresh and just, of some years earlier, nor had it always the attractiveness of the impulsive deliverances of some years later, when the inspired sketch was the thing that he generally stopped at. Old age found him strong and receptive. Only in the very last year of his life was there perceptible a positive deterioration. Not very long before it, Boudin, in a visit to Venice, had produced impressions of Venice for which much more was to be said than that they were not Ziem's. And the deep colouring of the South, on days when the sunshine blazes least, had been caught by him and presented nobly at Antibes and Villefranche. At last, resorting to the south again as a refuge from ill-health, and recognizing soon that the relief it could give him was almost spent, he resolved that it should not be for him, in the words of Maurice Barrès, a "*tombe fleurie*," and he returned, hastily, weak and sinking, to his home at Deauville, that he might at least die within sight of Channel waters and under Channel skies. As a "marine painter"—more properly as a painter of subjects in which water must have some part, and as curiously expert in the rendering of all that goes upon the sea, and as the painter too of the green banks of tidal rivers and of the long-stretched beach, with crinolined Parisienne noted as ably as the sailor-folk—Boudin stands alone. Beside him others are apt to seem rather theatrical—or if they do not romance they appear, perhaps, to chronicle dully. The pastels of Boudin—summary and economic even in the 'sixties, at a time when his painted work was less free—obtained the splendid eulogy of Baudelaire, and it was no other than Corot who, before his pictures, said to him: "You are the master of the sky."

See also Gustave Cahen, *Eugène Boudin* (Paris, 1899); Arsène Alexandre, *Essais*; Frederick Wedmore, *Whistler and Others* (1906). (F. W. E.)

BOUDINOT, ELIAS (1740-1821), American revolutionary leader, was born at Philadelphia, Pennsylvania, of Huguenot descent, on the 2nd of May 1740. He studied law at Princeton, New Jersey, in the office of Richard Stockton, whose sister Hannah he married in 1762, and in November 1760 he was licensed as a counsellor and attorney-at-law, afterwards practising at Elizabethtown, New Jersey. On the approach of the War of Independence he allied himself with the conservative Whigs. He was a deputy to the provincial congress of New Jersey from May to August 1775, and from May 1777 until July 1778 was the commissary-general of prisoners, with the rank of colonel, in the continental army. He was one of the New Jersey members of the continental congress in 1778 and again from 1781 until 1783, and from November 1782 until October 1783 was president of that body, acting also for a short time, after the resignation of Robert R. Livingston, as secretary for foreign affairs. From 1789 to 1795 he sat as a member of the national House of Representatives, and from 1795 until 1805 he was the director of the United States mint at Philadelphia. He took an active part in the founding of the American Bible Society in 1816, of which he became the first president. He was a trustee and a benefactor of the college of New Jersey (afterwards Princeton University).

In reply to Thomas Paine's *Age of Reason*, he published the *Age of Revelation* (1790); he also published a volume entitled *A Star in the West, or a Humble Attempt to Discover the Long Lost Ten Tribes of Israel* (1816), in which he endeavours to prove that the American Indians may be the ten lost tribes. Boudinot died at Burlington, New Jersey, on the 24th of October 1821.

See *The Life, Public Services, Addresses and Letters of Elias Boudinot*, edited by J. J. Boudinot (Boston and New York, 1896).

BOUÉ, AMI (1794-1881), Austrian geologist, was born at Hamburg on the 16th of March 1794, and received his early education there and in Geneva and Paris. Proceeding to Edinburgh to study medicine at the university, he came under the influence of Robert Jameson, whose teachings in geology and mineralogy inspired his future career. Boué was thus led to make geological expeditions to various parts of Scotland and the Hebrides, and after taking his degree of M.D. in 1817 he settled for some years in Paris. In 1820 he issued his *Essai géologique sur l'Écosse*, in which the eruptive rocks in particular were carefully described. He travelled much in Germany, Austria and southern Europe, studying various geological formations, and becoming one of the pioneers in geological research; he was one of the founders of the Société Géologique de France in 1830, and was its president in 1835. In 1841 he settled in Vienna, and became naturalized as an Austrian. He died on the 21st of November 1881. To the Imperial Academy of Sciences at Vienna he communicated important papers on the geology of the Balkan States (1859-1870), and he also published *Mémoires géologiques et paléontologiques* (Paris, 1832) and *La Turquie d'Europe; observations sur la géographie, la géologie, l'histoire naturelle, &c.* (Paris, 1840).

BOUFFLERS, LOUIS FRANÇOIS, DUC DE, comte de Cagny (1644-1711), marshal of France, was born on the 10th of January 1644. He entered the army and saw service in 1663 at the siege of Marsal, becoming in 1666 colonel of dragoons. In the conquest of Lorraine (1670) he served under Marshal de Créqui. In Holland he served under Turenne, frequently distinguishing himself by his skill and bravery; and when Turenne was killed by a cannon-shot in 1675 he commanded the rear-guard during the retreat of the French army. He was already a brigadier, and in 1677 he became *maréchal de camp*. He served throughout the campaigns of the time with increasing distinction, and in 1681 became lieutenant-general. He commanded the French army on the Moselle, which opened the War of the League of Augsburg with a series of victories; then he led a corps to the Sambre, and reinforced Luxemburg on the eve of the battle of Fleurus. In 1691 he acted as lieutenant-general under the king in person; and during the investment of Mons he was wounded in an attack on the town. He was present with the king at the siege of Namur in 1692, and took part in the victory of Steinkirk. For his services he was raised in 1692 to the rank of marshal of France, and in 1694 was made a duke. In 1694 he was appointed governor of French Flanders and of the town of Lille. By a skilful manoeuvre he threw himself into Namur in 1695, and only surrendered to his besiegers after he had lost 8000 of his 13,000 men. In the conferences which terminated in the peace of Ryswick he had a principal share. During the following war, when Lille was threatened with a siege by Marlborough and Eugene, Boufflers was appointed to the command, and made a most gallant resistance of three months. He was rewarded and honoured by the king for his defence of Lille, as if he had been victorious. It was indeed a species of triumph; his enemy, appreciating his merits, allowed him to dictate his own terms of capitulation. In 1708 he was made a peer of France. In 1709, when the affairs of France were threatened with the most urgent danger, Boufflers offered to serve under his junior, Villars, and was with him at the battle of Malplaquet. Here he displayed the highest skill, and after Villars was wounded he conducted the retreat of the French army without losing either cannon or prisoners. He died at Fontainebleau on the 22nd of August 1711.

See F. . . . *Vie du Mal. de Boufflers* (Lille, 1852), and Père Delarue's and Père Poisson's *Oraisons funèbres du Mal. B.* (1712).

BOUFFLERS, STANISLAS JEAN, CHEVALIER DE (1737-1815), French statesman and man of letters, was born near Nancy on the 31st of May 1738. He was the son of Louis François, marquis de Boufflers. His mother, Marie Catherine de Beauveau Craon, was the mistress of Stanislas Leszczyński, and the boy was brought up at the court of Lunéville. He spent six months in study for the priesthood at Saint Sulpice, Paris, and during his residence there he put in circulation a story which became extremely popular, *Aline, reine de Golconde*. Boufflers did not, however, take the vows, as his ambitions were military. He entered the order of the Knights of Malta, so that he might be able to follow the career of arms without sacrificing the revenues of a benefice he had received in Lorraine under King Stanislas. After serving in various campaigns he reached the grade of *maréchal de camp* in 1784, and in the next year was sent to West Africa as governor of Senegal. He proved an excellent administrator, and did what he could to mitigate the horrors of the slave trade; and he interested himself in opening up the material resources of the colony, so that his departure in 1787 was regarded as a real calamity by both colonists and negroes. The *Mémoires secrets* of Bachaumont give the current opinion that Boufflers was sent to Senegal because he was in disgrace at court; but the real reason appears to have been a desire to pay his debts before his marriage with Mme de Sabran, which took place soon after his return to France. Boufflers was admitted to the Academy in 1788, and subsequently became a member of the states-general. During the Revolution he found an asylum with Prince Henry of Prussia at Rheinsberg. At the Restoration he was made joint-librarian of the Bibliothèque Mazarine. His wit and his skill in light verse had won him a great reputation, and he was one of the idols of the Parisian salons. His paradoxical character was described in an epigram attributed to Antoine de Rivarol, "*abbé libéral, militaire philosophe, diplomate chansonnier, émigré patriote, républicain courtisan.*" He died in Paris on the 18th of January 1815.

His *Œuvres complètes* were published under his own supervision in 1803. A selection of his stories in prose and verse was edited by Eugene Assé in 1878; his *Poésies* by O. Uzanne in 1886; and the *Correspondance inédite de la comtesse de Sabran et du chevalier de Boufflers* (1778-1788), by E. de Magnieu and Henri Prat in 1875.

BOUGAINVILLE, LOUIS ANTOINE DE (1732-1811), French navigator, was born at Paris on the 11th of November 1732. He was the son of a notary, and in early life studied law, but soon abandoned the profession, and in 1753 entered the army in the corps of musketeers. At the age of twenty-five he published a treatise on the integral calculus, as a supplement to De l'Hôpital's treatise, *Des infiniment petits*. In 1755 he was sent to London as secretary to the French embassy, and was made a member of the Royal Society. In 1756 he went to Canada as captain of dragoons and aide-de-camp to the marquis de Montcalm; and having distinguished himself in the war against England, was rewarded with the rank of colonel and the cross of St Louis. He afterwards served in the Seven Years' War from 1761 to 1763. After the peace, when the French government conceived the project of colonizing the Falkland Islands, Bougainville undertook the task at his own expense. But the settlement having excited the jealousy of the Spaniards, the French government gave it up to them, on condition of their indemnifying Bougainville. He was then appointed to the command of the frigate "La Boudeuse" and the transport "L'Étoile," and set sail in December 1766 on a voyage of discovery round the world. Having executed his commission of delivering up the Falkland Islands to the Spanish, Bougainville proceeded on his expedition, and touched at Buenos Aires. Passing through the Straits of Magellan, he visited the Tuamotu archipelago, and Tahiti, where the English navigator Wallis had touched eight months before. He proceeded across the Pacific Ocean by way of the Samoan group, which he named the Navigators Islands, the New Hebrides and the Solomon Islands. His men now suffering from scurvy, and his vessels requiring refitting, he anchored at Buru, one of the Moluccas, where the governor of the Dutch settlement supplied his wants. It was the beginning of September, and the expedition took

advantage of the easterly monsoon, which carried them to Batavia. In March 1769 the expedition arrived at St Malo, with the loss of only seven out of upwards of 200 men. Bougainville's account of the voyage (Paris, 1771) is written with simplicity and some humour. After an interval of several years, he again accepted a naval command and saw much active service between 1779 and 1782. In the memorable engagement of the 12th of April 1782, in which Rodney defeated the comte de Grasse, near Martinique, Bougainville, who commanded the "Auguste," succeeded in rallying eight ships of his own division, and bringing them safely into St Eustace. He was created *chef d'escadre*, and on re-entering the army, was given the rank of *maréchal de camp*. After the peace he returned to Paris, and obtained the place of associate of the Academy. He projected a voyage of discovery towards the north pole, but this did not meet with support from the French government. Bougainville obtained the rank of vice-admiral in 1791; and in 1792, having escaped almost miraculously from the massacres of Paris, he retired to his estate in Normandy. He was chosen a member of the Institute at its formation, and returning to Paris became a member of the Board of Longitude. In his old age Napoleon I. made him a senator, count of the empire, and member of the Legion of Honour. He died at Paris on the 31st of August 1811. He was married and had three sons, who served in the French army.

Bougainville's name is given to the largest member of the Solomon Islands, which belongs to Germany; and to the strait which divides it from the British island of Choiseul. It is also applied to the strait between Mallicollo and Espiritu Santo Islands of the New Hebrides group, and the South American climbing plant *Bougainvillea*, often cultivated in greenhouses, is named after him.

BOUGHTON, GEORGE HENRY (1834-1905), Anglo-American painter, was born in England, but his parents went to the United States in 1839, and he was brought up at Albany, N.Y. He studied art in Paris in 1861-62, and subsequently lived mainly in London; he was much influenced by Frederick Walker, and the delicacy and grace of his pictures soon made his reputation. He was elected an A.R.A. in 1879, and R.A. in 1896, and a member of the National Academy of Design in New York in 1871. His pictures of Dutch life and scenery were especially characteristic; and his subject-pictures, such as the "Return of the Mayflower" and "The Scarlet Letter," were very popular in America.

BOUGIE, a seaport of Algeria, chief town of an arrondissement in the department of Constantine, 120 m. E. of Algiers. The town, which is defended by a wall built since the French occupation, and by detached forts, is beautifully situated on the slope of Mount Guraya. Behind it are the heights of Mounts Babor and Tababort, rising some 6400 ft. and crowned with forests of pinsapo fir and cedar. The most interesting buildings in the town are the ancient forts, Borj-el-Ahmer and Abd-el-Kader, and the kasbah or citadel, rectangular in form, flanked by bastions and towers, and bearing inscriptions stating that it was built by the Spaniards in 1545. Parts of the Roman wall exist, and considerable portions of that built by the Hammadites in the 11th century. The streets are very steep, and many are ascended by stairs. The harbour, sheltered from the east by a breakwater, was enlarged in 1897-1902. It covers 63 acres and has a depth of water of 23 to 30 ft. Bougie is the natural port of Kabylia, and under the French rule its commerce—chiefly in oils, wools, hides and minerals—has greatly developed; a branch railway runs to Beni Mansur on the main line from Constantine to Oran. Pop. (1906) of the town, 10,419; of the commune, 17,540; of the arrondissement, which includes eight communes, 37,711.

Bougie, if it be correctly identified with the Saldæ of the Romans, is a town of great antiquity, and probably owes its origin to the Carthaginians. Early in the 5th century Genseric the Vandal surrounded it with walls and for some time made it his capital. En-Nasr (1062-1088), the most powerful of the Berber dynasty of Hammad, made Bougie the seat of his government, and it became the greatest commercial centre of the North

African coast, attaining a high degree of civilization. From an old MS. it appears that as early as 1068 the heliograph was in common use, special towers, with mirrors properly arranged, being built for the purpose of signalling. The Italian merchants of the 12th and 13th centuries owned numerous buildings in the city, such as warehouses, baths and churches. At the end of the 13th century Bougie passed under the dominion of the Hafsidæ, and in the 15th century it became one of the strongholds of the Barbary pirates. It enjoyed partial independence under amirs of Hafside origin, but in January 1510 was captured by the Spaniards under Pedro Navarro. The Spaniards strongly fortified the place and held it against two attacks by the corsairs Barbarossa. In 1555, however, Bougie was taken by Salah Rais, the pasha of Algiers. Leo Africanus, in his *Africa descriptio*, speaks of the "magnificence" of the temples, palaces and other buildings of the city in his day (c. 1525), but it appears to have fallen into decay not long afterwards. When the French took the town from the Algerians in 1833 it consisted of little more than a few fortifications and ruins. It is said that the French word for a candle is derived from the name of the town candles being first made of wax imported from Bougie.

BOUGUER, PIERRE (1698-1758), French mathematician, was born on the 16th of February 1698. His father, John Bouguer, one of the best hydrographers of his time, was regius professor of hydrography at Croisic in lower Brittany, and author of a treatise on navigation. In 1713 he was appointed to succeed his father as professor of hydrography. In 1727 he gained the prize given by the Académie des Sciences for his paper "On the best manner of forming and distributing the masts of ships"; and two other prizes, one for his dissertation "On the best method of observing the altitude of stars at sea," the other for his paper "On the best method of observing the variation of the compass at sea." These were published in the *Prix de l'Académie des Sciences*. In 1729 he published *Essai d'optique sur la gradation de la lumière*, the object of which is to define the quantity of light lost by passing through a given extent of the atmosphere. He found the light of the sun to be 300 times more intense than that of the moon, and thus made some of the earliest measurements in photometry. In 1730 he was made professor of hydrography at Havre, and succeeded P. L. M. de Maupertuis as associate geometer of the Académie des Sciences. He also invented a heliometer, afterwards perfected by Fraunhofer. He was afterwards promoted in the Academy to the place of Maupertuis, and went to reside in Paris. In 1735 Bouguer sailed with C. M. de la Condamine for Peru, in order to measure a degree of the meridian near the equator. Ten years were spent in this operation, a full account of which was published by Bouguer in 1749, *Figure de la terre déterminée*. His later writings were nearly all upon the theory of navigation. He died on the 15th of August 1758.

The following is a list of his principal works:—*Traité d'optique sur la gradation de la lumière* (1729 and 1760); *Entretiens sur la cause d'inclinaison des orbites des planètes* (1734); *Traité de navire*, &c. (1746, 4to); *La Figure de la terre déterminée*, &c. (1749), 4to; *Nouveau traité de navigation, contenant la théorie et la pratique du pilotage* (1753); *Solution des principaux problèmes sur la manœuvre des vaisseaux* (1757); *Opérations faites pour la vérification du degré du méridien entre Paris et Amiens*, par Messrs. Bouguer, Camus, Cassini et Pigné (1757).

See J. E. Montucla, *Histoire des mathématiques* (1802).

BOUGUEREAU, ADOLPHE WILLIAM (1825-1905), French painter, was born at La Rochelle on the 30th of November 1825. From 1843 till 1850 he went through the course of training at the École des Beaux-Arts, and in 1850 divided the Grand Prix de Rome scholarship with Baudry, the subject set being "Zenobia on the banks of the Araxes." On his return from Rome in 1855 he was employed in decorating several aristocratic residences, deriving inspiration from the frescoes which he had seen at Pompeii and Herculaneum, and which had already suggested his "Idyll" (1853). He also began in 1847 to exhibit regularly at the Salon. "The Martyr's Triumph," the body of St Cecilia borne to the catacombs, was placed in the Luxembourg after being exhibited at the Paris Exhibition of 1855; and in the same

year he exhibited "Fraternal Love," a "Portrait" and a "Study." The state subsequently commissioned him to paint the emperor's visit to the sufferers by the inundations at Tarascon. In 1857 Bouguereau received a first prize medal. Nine of his panels executed in wax-painting for the mansion of M. Bartholomy were much discussed—"Love," "Friendship," "Fortune," "Spring," "Summer," "Dancing," "Arion on a Sea-horse," a "Bacchante" and the "Four Divisions of the Day." He also exhibited at the Salon "The Return of Tobit" (now in the Dijon gallery). While in antique subjects he showed much grace of design, in his "Napoleon," a work of evident labour, he betrayed a lack of ease in the treatment of modern costume. Bouguereau subsequently exhibited "Love Wounded" (1859), "The Day of the Dead" (at Bordeaux), "The First Discord" (1861, in the Club at Limoges), "The Return from the Fields" (a picture in which Théophile Gautier recognized "a pure feeling for the antique"), "A Fawn and Bacchante" and "Peace"; in 1863 a "Holy Family," "Remorse," "A Bacchante teasing a Goat" (in the Bordeaux gallery); in 1864 "A Bather" (at Ghent), and "Sleep"; in 1865 "An Indigent Family" and a portrait of Mme Bartholomy; in 1866 "A First Cause," and "Covetousness," with "Phylomela and Procne"; and some decorative work for M. Montlun at La Rochelle, for M. Emile Péreire in Paris, and for the churches of St Clotilde and St Augustin; and in 1866 the large painting of "Apollo and the Muses on Olympus," in the Great Theatre at Bordeaux. Among other works by this artist may be mentioned "Between Love and Riches" (1866), "A Girl Bathing" (1870), "In Harvest Time" (1872), "Nymphs and Satyrs" (1873), "Charity" and "Homer and his Guide" (1874), "Virgin and Child," "Jesus and John the Baptist," "Return of Spring" (which was purchased by an American collector, and was destroyed by a fanatic who objected to the nudity), a "Pieta" (1876), "A Girl defending herself from Love" (1880), "Night" (1883), "The Youth of Bacchus" (1884), "Biblis" (1885), "Love Disarmed" (1886), "Love Victorious" (1887), "The Holy Women at the Sepulchre" and "The Little Beggar Girls" (1890), "Love in a Shower" and "First Jewels" (1891). To the Exhibition of 1900 were contributed some of Bouguereau's best-known pictures. Most of his works, especially "The Triumph of Venus" (1856) and "Charity," are popularly known through engravings. "Prayer," "The Invocation" and "Sappho" have been engraved by M. Thirion, "The Golden Age" by M. Annetombe. Bouguereau's pictures, highly appreciated by the general public, have been severely criticized by the partisans of a freer and fresher style of art, who have reproached him with being too content to revive the formulas and subjects of the antique. At the Paris Exhibition of 1867 Bouguereau took a third-class medal, in 1878 a medal of honour, and the same again in the Salon of 1885. He was chosen by the Society of French Artists to be their vice-president, a post he filled with much energy. He was made a member of the Legion of Honour in 1856, an officer of the Order 26th of July 1876, and commander 12th of July 1885. He succeeded Isidore Pils as member of the Institute, 8th of January 1876. He died on the 20th of August 1905.

See Ch. Vendryes, *Catalogue illustré des œuvres de Bouguereau* (Paris, 1885); Jules Claretie, *Peintres et sculpteurs contemporains* (Paris, 1874); P. G. Hamerton, *French Painters; Artists modernes: écrivain illustré des beaux-arts* (1885); "W. Bouguereau," *Port-folio* (1875); Émile Bayard, "William Bouguereau," *Monde moderne* (1897).

BOUHOURS, DOMINIQUE (1628–1702), French critic, was born in Paris in 1628. He entered the Society of Jesus at the age of sixteen, and was appointed to read lectures on literature in the college of Clermont at Paris, and on rhetoric at Tours. He afterwards became private tutor to the two sons of the duke of Longueville. He was sent to Dunkirk to the Romanist refugees from England, and in the midst of his missionary occupations published several books. In 1665 or 1666 he returned to Paris, and published in 1671 *Les Entretiens d'Aristote et d'Épène*, a critical work on the French language, printed five times at Paris, twice at Grenoble, and afterwards at Lyons, Brussels, Amsterdam, Leiden, &c. The chief of his other works

are *La Manière de bien penser sur les ouvrages d'esprit* (1687), *Doutes sur la langue française* (1674), *Vie de Saint Ignace de Loyola* (1679), *Vie de Saint François Xavier* (1682), and a translation of the New Testament into French (1697). His practice of publishing secular books and works of devotion alternately led to the motto, "qu'il servait le monde à la ciel par semestre." Bouhours died at Paris on the 27th of May 1702.

See Georges Doucieux, *Un Jésuite homme de lettres au dix-septième siècle: Le père Bouhours* (1886). For a list of Bouhours' works see Backer and Sommervogel, *Bibliothèque de la Compagnie de Jésus*, i. pp. 1886 et seq.

BOUILHET, LOUIS HYACINTHE (1822–1869), French poet and dramatist, was born at Cany, Seine Inférieure, on the 27th of May 1822. He was a schoolfellow of Gustave Flaubert, to whom he dedicated his first work, *Méloenis* (1851), a narrative poem in five cantos, dealing with Roman manners under the emperor Commodus. His volume of poems entitled *Fossiles* attracted considerable attention, on account of the attempt therein to use science as a subject for poetry. These poems were included also in *Festons et astragales* (1859). As a dramatist he secured a success with his first play, *Madame de Montarcy* (1856), which ran for seventy-eight nights at the Odéon; and *Hélène Peyron* (1858) and *L'Oncle Million* (1860) were also favourably received. But of his other plays, some of them of real merit, only the *Conjuración d'Amboise* (1866) met with any great success. Bouilhet died on the 18th of July 1866, at Rouen. Flaubert published his posthumous poems with a notice of the author, in 1872.

See also Maxime du Camp, *Souvenirs littéraires* (1882); and H. de la Ville de Mirmont, *Le Poète Louis Bouilhet* (1888).

BOUILLÉ, FRANÇOIS CLAUDE AMOUR, MARQUIS DE (1730–1800), French general. He served in the Seven Years' War, and as governor in the Antilles conducted operations against the English in the War of American Independence. On his return to France he was named governor of the Three Bishoprics, of Alsace and of Franche-Comté. Hostile to the Revolution, he had continual quarrels with the municipality of Metz, and brutally suppressed the military insurrections at Metz and Nancy, which had been provoked by the harsh conduct of certain noble officers. Then he proposed to Louis XVI. to take refuge in a frontier town where an appeal could be made to other nations against the revolutionists. When this project failed as a result of Louis XVI.'s arrest at Varennes, Bouillé went to Russia to induce Catherine II. to intervene in favour of the king, and then to England, where he died in 1800, after serving in various royalist attempts on France. He left *Mémoires sur la Révolution française depuis son origine jusqu'à la retraite du duc de Brunswick* (Paris, 1801).

BOUILLON, formerly the seat of a dukedom in the Ardennes, now a small town in the Belgian province of Luxemburg. Pop. (1904) 2721. It is most picturesquely situated in the valley under the rocky ridge on which are still the very well preserved remains of the castle of Godfrey of Bouillon (q.v.), the leader of the first crusade. The town, 660 ft. above the sea, but lying in a basin, skirts both banks of the river Semois which is crossed by two bridges. The stream forms a loop round and almost encircles the castle, from which there are beautiful views of the sinuous valley and the opposite well-wooded heights. The whole effect of the grim castle, the silvery stream and the verdant woods makes one of the most striking scenes in Belgium. In the 8th and 9th centuries Bouillon was one of the castles of the counts of Ardenne and Bouillon. In the 10th and 11th centuries the family took the higher titles of dukes of Lower Lorraine and Bouillon. These dukes all bore the name of Godfrey (Godfrey) and the fifth of them was the great crusader. He was the son of Eustace, count of Boulogne, which has led many commentators into the error of saying that Godfrey of Bouillon was born at the French port, whereas he was really born in the castle of Baisy near Genappe and Waterloo. His mother was Ida d'Ardenne, sister of the fourth Godfrey ("the Hunchback"), and the successful defence of the castle when a mere youth of seventeen on her behalf was the first feat of arms of the future conqueror of Jerusalem. This medieval fortress, strong by

art as well as position before the invention of modern artillery, has since undergone numerous sieges. In order to undertake the crusade Godfrey sold the castle of Bouillon to the prince bishop of Liège, and the title of duke of Bouillon remained the appanage of the bishopric till 1678, or for 80 years. The bishops appointed "châtelains," one of whom was the celebrated "Wild Boar of the Ardennes," William de la Marck. His descendants made themselves quasi-independent and called themselves princes of Sedan and dukes of Bouillon, and they were even recognized by the king of France. The possession of Bouillon thenceforward became a constant cause of strife until in 1678 Louis XIV. garrisoned it under the treaty of Nijmegen. From 1594 to 1641 the duchy remained vested in the French family of La Tour d'Auvergne, one of whom (Henry, viscount of Turenne and marshal of France) had married in 1591 Charlotte de la Marck, the last of her race. In 1676 the duke of Créqui seized it in the name of Louis XIV., who in 1678 gave it to Godefroy Marie de La Tour d'Auvergne, whose descendants continued in possession till 1795. Bouillon remained French till 1814, and Vauban called it "the key of the Ardennes." In 1760 the elder Rousseau established here the famous press of the Encyclopedists. In 1814-1815, before the decrees of the Vienna Congress were known, an extraordinary attempt was made by Philippe d'Auvergne of the British navy, the cousin and adopted son of the last duke, to revive the ancient duchy of Bouillon. The people of Bouillon freely recognized him, and Louis XVIII. was well pleased with the arrangement, but the congress assigned Bouillon to the Netherlands. Napoleon III. on his way to Germany after Sedan slept one night in the little town, which is a convenient centre for visiting that battlefield.

BOUILLOTTE, a French game of cards, very popular during the Revolution, and again for some years from 1830. Five, four or three persons may play; a piquet pack is used, from which, in case five play, the sevens, when four the knaves, and when three the queens also, are omitted. Counters or chips, as in poker, are used. Before the deal each player "antes" one counter, after which each, the "age" passing, may "raise" the pot; those not "seeing the raise" being obliged to drop out. Three cards are dealt to each player, and a thirteenth, called the *retourne*, when four play, turned up. Each player must then bet, call, raise or drop out. When a call is made the hands are shown and the best hand wins. The hands rank as follows: *brélan carré*, four of a kind, one being the *retourne*; *simple brélan*, three of a kind, ace being high; *brélan favori*, three of a kind, one being the *retourne*. When no player holds a *brélan* the hand holding the greatest number of pips wins, ace counting 11, and court cards 10.

BOUILLY, JEAN NICOLAS (1763-1842), French author, was born near Tours on the 24th of January 1763. At the outbreak of the Revolution he held office under the new government, and had a considerable share in the organization of primary education. In 1799 he retired from public life to devote himself to literature. His numerous works include the musical comedy, *Pierre le Grand* (1790), for Grétry's music, and the opera, *Les Deux Journées* (1800), music by Cherubini; also *L'Abbé de l'Épée* (1800), and some other plays; and *Cousines d'un vieillard* (1807), *Contes à ma fille* (1800), and *Les Adieux du vieux conteur* (1835). His *Léonore* (1798) formed the basis of the libretto of the *Fidelio* of Beethoven. Bouilly died in Paris on the 14th of April 1842.

See Bouilly, *Mes récapitulations* (3 vols., 1836-1837); E. Legouvé, *Soixante ans de souvenirs* (1^{ère} partie, 1886).

BOULAINVILLIERS, HENRI, COMTE DE (1658-1722), French political writer, was born at St Saire in Normandy in 1658. He was educated at the college of Jully, and served in the army until 1697. He wrote a number of historical works (published after his death), of which the most important were the following: *Histoire de l'ancien gouvernement de la France* (La Haye, 1727); *Etat de la France, avec des mémoires sur l'ancien gouvernement* (London, 1727); *Histoire de la pairie de France* (London, 1753); *Histoire des Arabes* (1731). His writings are characterized by

an extravagant admiration of the feudal system. He was an aristocrat of the most pronounced type, attacking absolute monarchy on the one hand and popular government on the other. He was at great pains to prove the pretensions of his own family to ancient nobility, and maintained that the government should be entrusted solely to men of his class. He died in Paris on the 23rd of January 1722.

BOULANGER, the name of several French artists:—**JEAN** (1606-1660), a pupil of Guido Reni at Bologna, who had an academy at Modena; his cousin **JEAN** (1607-1680), a celebrated line-engraver; the latter's son **MATTHIEU**, another engraver; **LOUIS** (1806-1867), a subject-painter, the friend of Victor Hugo, and director of the imperial school of art at Dijon; the best-known, **GUSTAVE RODOLPHE CLARENCE** (1824-1888), a pupil of Paul Delaroche, a notable painter of Oriental and Greek and Roman subjects, and a member of the Institute (1882); and **CLÉMENT** (1805-1842), a pupil of Ingres.

BOULANGER, GEORGE ERNEST JEAN MARIE (1837-1891), French general, was born at Rennes on the 29th of April 1837. He entered the army in 1856, and served in Algeria, Italy, Cochinchina and the Franco-German War, earning the reputation of being a smart soldier. He was made a brigadier-general in 1880, on the recommendation of the duc d'Aumale, then commanding the VII. army corps, and Boulanger's expressions of gratitude and devotion on this occasion were remembered against him afterwards when, as war minister in M. Freycinet's cabinet, he erased the name of the duc d'Aumale from the army list, as part of the republican campaign against the Orleanist and Bonapartist princes. In 1882 his appointment as director of infantry at the war office enabled him to make himself conspicuous as a military reformer; and in 1884 he was appointed to command the army occupying Tunis, but was recalled owing to his differences of opinion with M. Cambon, the political resident. He returned to Paris, and began to take part in politics under the aegis of M. Clémenceau and the Radical party; and in January 1886, when M. Freycinet was brought into power by the support of the Radical leader, Boulanger was given the post of war minister.

By introducing genuine reforms for the benefit of officers and common soldiers alike, and by laying himself out for popularity in the most pronounced fashion—notably by his fire-eating attitude towards Germany in April 1887 in connexion with the Schnaebelé frontier incident—Boulanger came to be accepted by the mob as the man destined to give France her revenge for the disasters of 1870, and to be used simultaneously as a tool by all the anti-Republican intriguers. His action with regard to the royal princes has already been referred to, but it should be added that Boulanger was taunted in the Senate with his ingratitude to the duc d'Aumale, and denied that he had ever used the words alleged. His letters containing them were, however, published, and the charge was proved. Boulanger fought a bloodless duel with the baron de Lareinty over this affair, but it had no effect at the moment in dimming his popularity, and on M. Freycinet's defeat in December 1886 he was retained by M. Goblet at the war office. M. Clémenceau, however, had by this time abandoned his patronage of Boulanger, who was becoming so inconveniently prominent that, in May 1887, M. Goblet was not sorry to get rid of him by resigning. The mob clamoured for their "brav' général," but M. Rouvier, who next formed a cabinet, declined to take him as a colleague, and Boulanger was sent to Clermont-Ferrand to command an army corps. A Boulangerist "movement" was now in full swing. The Bonapartists had attached themselves to the general, and even the comte de Paris encouraged his followers to support him, to the dismay of those old-fashioned Royalists who resented Boulanger's treatment of the duc d'Aumale. His name was the theme of the popular song of the moment—"C'est Boulanger qu'il nous faut"; the general and his black horse became the idol of the Parisian populace; and he was urged to play the part of a plebiscitary candidate for the presidency.

The general's vanity lent itself to what was asked of it; after various symptoms of insubordination had shown themselves, he

was deprived of his command in 1888 for twice coming to Paris without leave, and finally on the recommendation of a council of inquiry composed of five generals, his name was removed from the army list. He was, however, almost at once elected to the chamber for the Nord, his political programme being a demand for a revision of the constitution. In the chamber he was in a minority, since genuine Republicans of all varieties began to see what his success would mean, and his actions were accordingly directed to keeping the public gaze upon himself. A popular hero survives many deficiencies, and neither his failure as an orator nor the humiliation of a discomfiture in a duel with M. Floquet, then an elderly civilian, sufficed to check the enthusiasm of his following. During 1888 his personality was the dominating feature of French politics, and, when he resigned his seat as a protest against the reception given by the chamber to his revisionist proposals, constituencies vied with one another in selecting him as their representative. At last, in January 1890, he was returned for Paris by an overwhelming majority. He had now become an open menace to the parliamentary Republic. Had Boulanger immediately placed himself at the head of a revolt he might at this moment have effected the *coup d'État* which the intriguers had worked for, and might not improbably have made himself master of France; but the favourable opportunity passed. The government, with M. Constans as minister of the interior, had been quietly taking its measures for bringing a prosecution against him, and within two months a warrant was signed for his arrest. To the astonishment of his friends, on the 1st of April he fled from Paris before it could be executed, going first to Brussels and then to London. It was the end of the political danger, though Boulangerist echoes continued for a little while to reverberate at the polls during 1889 and 1890. Boulanger himself, having been tried and condemned *in absentia* for treason, in October 1889 went to live in Jersey, but nobody now paid much attention to his doings. The world was startled, however, on the 30th of September 1891 by hearing that he had committed suicide in a cemetery at Brussels by blowing out his brains on the grave of his mistress, Madame de Bonnemains (née Marguerite Crouzet), who had died in the preceding July.

See also the article FRANCE: History; and Verly, *Le Général Boulanger et la conspiration monarchique* (Paris, 1893). (H. CB.)

BOULAY DE LA MEURTHE, ANTOINE JACQUES CLAUDE JOSEPH, COMTE (1761-1840), French politician and magistrate, son of an agricultural labourer, was born at Chamousey (Vosges) on the 19th of February 1761. Called to the bar at Nancy in 1783, he presently went to Paris, where he rapidly acquired a reputation as a lawyer and a speaker. He supported the revolutionary cause in Lorraine, and fought at Valmy (1792) and Wissembourg (1793) in the republican army. But his moderate principles brought suspicion on him, and during the Terror he had to go into hiding. He represented La Meurthe in the Council of Five Hundred, of which he was twice president, but his views developed steadily in the conservative direction. Fearing a possible renewal of the Terror, he became an active member of the plot for the overthrow of the Directory in November 1799. He was rewarded by the presidency of the legislative commission formed by Napoleon to draw up the new constitution; and as president of the legislative section of the council of state he examined and revised the draft of the civil code. In eight years of hard work as director of a special land commission he settled the titles of land acquired by the French nation at the Revolution, and placed on an unassailable basis the rights of the proprietors who had bought this land from the government. He received the grand cross of the Legion of Honour and the title of count, was a member of Napoleon's privy council, but was never in high favour at court. After Waterloo he tried to obtain the recognition of Napoleon II. He was placed under surveillance at Nancy, and later at Halberstadt and Frankfort-on-Main. He was allowed to return to France in 1819, but took no further active part in politics, although he presented himself unsuccessfully for parliamentary election in 1824 and 1827. He died in Paris on the 4th of February 1840. He published two books on

English history—*Essai sur les causes qui, en 1649, amenèrent en Angleterre l'établissement de la république* (Paris, 1799), and *Tableau politique des règnes de Charles II et Jacques II, derniers rois de la maison de Stuart* (The Hague, 1818)—which contained much indirect criticism of the Directory and the Restoration governments. He devoted the last years of his life to writing his memoirs, which, with the exception of a fragment on the *Théorie constitutionnelle de Sieyès* (1836), remained unpublished.

His elder son, Comte HENRI GEORGES BOULAY DE LA MEURTHE (1797-1858), was a constant Bonapartist, and after the election of Louis Napoleon to the presidency, was named (January 1849) vice-president of the republic. He zealously promoted popular education, and became in 1842 president of the society for elementary instruction.

BOULDER, a city and the county-seat of Boulder county, Colorado, U.S.A., about 30 m. N.W. of Denver. Pop. (1890) 3330; (1900) 6150 (693 foreign-born); (1910) 9539. It is served by the Union Pacific, the Colorado & Southern, and the Denver, Boulder & Western railways; the last connects with the neighbouring mining camps, and affords fine views of mountain scenery. Boulder lies about 5300 ft. above the sea on Middle Boulder Creek, a branch of the St Vrain river about 30 m. from its confluence with the Platte, and has a beautiful situation in the valley at the foot of the mountains. The state university of Colorado, established at Boulder by an act of 1861, was opened in 1877; it includes a college of liberal arts, school of medicine (1883), school of law (1892), college of engineering (1893), graduate school, college of commerce (1906), college of education (1908), and a summer school (1904), and has a library of about 42,000 volumes. There are a fine park of 2840 acres, the property of the city, and three beautiful cañons near Boulder. At the southern limits, in a beautiful situation 400 ft. above the city, are the grounds of an annual summer school, the Colorado Chautauqua. The climate is beneficial for those afflicted with bronchial and pulmonary troubles; the average mean annual temperature for eleven years ending with 1907 was 51° F. There are medicinal springs in the vicinity. The water-works are owned and operated by the city, the water being obtained from lakes at the foot of the Arapahoe Peak glacier in the Snowy Range, 20 m. from the city. The surrounding country is irrigated, and successfully combines agriculture and mining. There are ore sampling works and brick-making establishments. Oil and natural gas abound in the vicinity; there are oil refineries in the city; and in Boulder county, especially at Nederland, 18 m. south-west, and at Eldora, about 22 m. south-west of the city, has been obtained since 1900 most of the tungsten mined in the United States; the output in 1907 was valued at about \$520,000. The first settlement near the site of Boulder was made in the autumn of 1858. Placer gold was discovered on an affluent of Boulder Creek in January 1859. The town was laid out and organized in February 1859, and a city charter was secured in 1871 and another in 1882.

BOULDER (short for "boulder-stone," of uncertain origin; cf. Swed. *bullersten*, a large stone which causes a noise of rippling water in a stream, from *bullra*, to make a loud noise), a large stone, weathered or water-worn; especially a geological term for a large mass of rock transported to a distance from the formation to which it belongs. Similarly, in mining, a mass of ore found at a distance from the lode.

BOULDER CLAY, in geology, a deposit of clay, often full of boulders, which is formed in and beneath glaciers and ice-sheets wherever they are found, but is in a special sense the typical deposit of the Glacial Period in northern Europe and America. Boulder clay is variously known as "till" or "ground moraine" (Ger. *Blocklehme*, *Geschlebsmergel* or *Grundmoräne*; Fr. *argile à blocs*, *moraine profonde*; Swed. *Krossstenslera*). It is usually a stiff, tough clay devoid of stratification; though some varieties are distinctly laminated. Occasionally, within the boulder clay, there are irregular lenticular masses of more or less stratified sand, gravel or loam. As the boulder clay is the result of the abrasion (direct or indirect) of the older rocks over which the ice has travelled, it takes its colour from them; thus, in Britain,

over Triassic and Old Red Sandstone areas the clay is red, over Carboniferous rocks it is often black, over Silurian rock it may be buff or grey, and where the ice has passed over chalk the clay may be quite white and chalky (chalky boulder clay). Much boulder clay is of a bluish-grey colour where unexposed, but it becomes brown upon being weathered.

The boulders are held within the clay in an irregular manner, and they vary in size from mere pellets up to masses many tons in weight. Usually they are somewhat oblong, and often they possess a flat side or "sole"; they may be angular, sub-angular, or well rounded, and, if they are hard rocks, they frequently bear grooves and scratches caused by contact with other rocks while held firmly in the moving ice. Like the clay in which they are borne, the boulders belong to districts over which the ice has travelled; in some regions they are mainly limestones or sandstones; in others they are granite, basalts, gneisses, &c.; indeed, they may consist of any hard rock. By the nature of the contained boulders it is often possible to trace the path along which a vanished ice-sheet moved; thus in the Glacial drift of the east coast of England many Scandinavian rocks can be recognized.

With the exception of foraminifera which have been found in the boulder clay of widely separated regions, fossils are practically unknown; but in some maritime districts marine shells have been incorporated with the clay. See GLACIAL PERIOD; and GLACIER.

BOULÉ (Gr. βουλή, literally "will," "advice"; hence a "council"), the general term in ancient Greece for an advisory council. In the loose Homeric state, as in all primitive societies, there was a council of this kind, probably composed of the heads of families, i.e. of the leading princes or nobles, who met usually on the summons of the king for the purpose of consultation. Sometimes, however, it met on its own initiative, and laid suggestions before the king. It formed a means of communication between the king and the freemen assembled in the Agora. In Dorian states this aristocratic form of government was retained (for the Spartan Council of Elders see ΓΕΡΟΥΣΙΑ). In Athens the ancient council was called the Boulé until the institution of a democratic council, or committee of the Ecclesia, when, for purposes of distinction, it was described as "the Boulé of the Areopagus," or, more shortly, "the Areopagus" (q.v.). It must be clearly understood that the second, or Solonian Boulé, was entirely different from the Areopagus which represented the Homeric Council of the King throughout Athenian history, even after the "mutilation" carried out by Ephialtes. Further, it is, as will appear below, a profound mistake to call the second Boulé a "senate." There is no real analogy between the Roman senate and the Athenian council of Five Hundred.

Before describing the Athenian Boulé, the only one of its kind of which we have even fairly detailed information, it is necessary to mention that councils existed in other Greek states also, both oligarchic and democratic. A Boulé was in the first place a necessary part of a Greek oligarchy; the transition from monarchy to oligarchy was nominally begun by the gradual transference of the powers of the monarch to the Boulé of nobles. Further, in the Greek democracy, the larger democratic Boulé was equally essential. The general assembly of the people was utterly unsuited to the proper management of state affairs in all their minutiae. We therefore find councils of both kinds in almost all the states of Greece. (1) At Corinth we learn that there was an oligarchic council of unknown numbers presided over by eight leaders (Nicol. Damasc. *Frag.* 60). It was probably like the old Homeric council, except that its constitution did not depend on a birth qualification, but on a high census. This was natural in Corinth where, according to Herodotus (ii. 167), mercantile pursuits bore no stigma. (2) From an inscription we learn that the Athenians, in imposing a constitution on Erythrae (about 450 B.C.), included a council analogous to their own. (3) In Elis (Thuc. v. 47) there was an aristocratic council of ninety, which was superseded by a popular council of six hundred (471). (4) Similarly in Argos there were an aristocratic council of eighty and later a popular council of much larger size (Thuc.

v. 47). Councils are also found at (5) Rhodes, (6) Megalopolis (democratic), (7) Corcyra (democratic), (Thuc. iii. 70). Of these seven the most instructive is that of Erythrae, which proves that in the 5th century the Council of Five Hundred was so efficient in Athens that a similar body was imposed at Erythrae (and probably in the other tributary cities).

The Boulé at Athens. History.—The origin of the second Boulé, or Council of Four Hundred, at Athens is involved in obscurity. In the Aristotelian *Constitution of Athens* (c. 4), it is stated that Draco established a council of 401, and that he transferred to it some of the functions of the Council of Areopagus (q.v.). It is, however, generally held (see DRACO) that this statement is untrue, and that it was Solon who first established the council as a part of the constitution. Thirdly, it has been held that the council was not invented either by Draco or by Solon, but was of older and unknown origin. Fourthly, it has also been maintained by some recent writers that no Boulé existed before Cleisthenes. The principal evidence for this view is the omission of any reference to the Boulé in one of the earliest Athenian inscriptions, that relating to Salamis (Hicks and Hill, No. 4), where in place of the customary formula of a later age, εδοξε τῇ βουλῇ καὶ τῷ δήμῳ, we have the formula εδοξε τῷ δήμῳ. This argument is far from conclusive, and it is clear from the *Constitution* (c. 20) that the resistance of the Boulé to Cleomenes and Isagoras was anterior to the legislation of Cleisthenes (i.e. that the Boulé in question was the Solonian and not the Cleisthenian). On the whole it is reasonable to conclude that it was Solon who invented the Boulé to act as a semi-democratic check upon the democracy, whose power he was increasing at the expense of the oligarchs by giving new powers to the people in the Ecclesia and the Dicasteries. Practically nothing is known of the operations of this council until the struggle between Isagoras and Cleisthenes (Herod. v. 72). Solon's council had been based on the four Ionic tribes. When Cleisthenes created the new ten tribes in order to destroy the local influence of dominant families and to give the country demes a share in government, he changed the Solonian council into a body of 500 members, 50 from each tribe. This new body (see below) was the keystone of the Cleisthenean democracy, and may be said in a sense to have embodied the principle of local representation. After Cleisthenes, the council remained unaltered till 306 B.C., when, on the addition of two new tribes named after Antigonus and his son, Demetrius Poliorcetes, its numbers were increased to 600. In A.D. 126-127 the old number of 500 was restored. A council of 750 members is mentioned in an inscription of the early 3rd century A.D., and about A.D. 400 the number of councillors had fallen to 300.

Constitution and Functions.—(a) Under Solon the council consisted of 400 members, 100 from each of the four Ionic tribes. It is certain that all classes were eligible except the Thêtes, but the method of appointment is not known. Three suggestions have been made, (1) that each tribe chose its representatives, (2) that they were chosen by lot from qualified citizens in rotation, (3) that the combined method of selection by lot from a larger number of elected candidates was employed. According to the passage in Plutarch's *Solon* the functions of this body were from the first *probouleutic* (i.e. it prepared the business for the Ecclesia). Others hold that this function was not assigned to it until the Cleisthenean reforms. When we consider, however, the double danger of leaving the Ecclesia in full power, and yet under the presidency of the aristocratic archons, it seems probable that the probouleutic functions were devised by Solon as a method of maintaining the balance. On this hypothesis the Solonian Boulé was from the first what it certainly was later, a *committee* of the Ecclesia, i.e. not a "senate." It may be regarded as certain that the system of Prytaneis was the invention of Cleisthenes, not of Solon. (b) Under Cleisthenes the council reached its full development as a democratic representative body. Its actual organization is still uncertain, but it may be inferred that it became gradually a more strictly self-existent body than the Solonian council. Every

Solon's council.

Cleisthenes' council.

full citizen of thirty years of age was eligible, and, unlike other civil offices, it was permissible to serve twice, but not more than twice (*Ath. Pol.* c. 62). It may be regarded as certain, although our evidence is derived from inscriptions which date from the 3rd century B.C., that from the first the Bouleutae were appointed by the demes, in numbers proportionate to the size of the deme, and that from the first also the method of sortition was employed. For each councillor chosen by lot, a substitute was chosen in case of death or disgrace. After nomination each had to pass before the old council an examination in which the whole of his private life was scrutinized. After this, the councillors had to take an oath that they (1) would act according to the laws, (2) would give the best advice in their power, and (3) would carry out the examination of their successors in an impartial spirit. As symbols of office they wore wreaths; they received payment originally at the rate of one drachma a day,¹ at the end of the 4th century of five obols a day. At the end of the year of office each councillor had to render an account of his work, and if the council had done well the people voted crowns of honour. Within its own sphere the council exercised disciplinary control over its members by the device known as *Echphyllophoria*; it could provisionally suspend a member, pending a formal trial before the whole council assembled *ad hoc*. The council had further a complete system of scribes or secretaries (*grammateis*), private treasury officials, and a paid herald who summoned the Boule and the Ecclesia. The meetings took place generally in the council hall (*Bouleuterion*), but on special occasions in the theatre, the stadium, the dockyards, the Acropolis or the Theseum. They were normally public, the audience being separated by a barrier, but on occasions of peculiar importance the public was excluded.

The Ecclesia, owing to its size and constitution, was unable to meet more than three or four times a month; the council, on the other hand, was in continuous session, except on *Prytaneis* feast days. It was impossible that the Five Hundred should all sit every day, and, therefore, to facilitate the despatch of business, the system of Prytaneis was introduced, probably by Cleisthenes. By this system the year was divided into ten equal periods. During each of these periods the council was represented by the fifty councillors of one of the ten tribes, who acted as a committee for carrying on business for a tenth of the year. Each of these committees was led by a president (*Epistates*), who acted as chairman of the Boule and the Ecclesia also, and a third of its members lived permanently during their period of office in the Tholos (Dome) or Skias, a round building where they (with certain other officials and honoured citizens) dined at the public expense. In 378-377 B.C. (or perhaps in the archonship of Euclides, 403) the presidency of the Ecclesia was transferred to the *Epistates of the Proedri*, the *Proedri* being a body of nine chosen by lot by the Epistates of the Prytaneis from the remaining nine tribes. It was the duty of the Boule (i.e. the Prytany which was for the time in session) to prepare all business for the consideration of the Ecclesia. Their recommendation (*προβουλευμα*) was presented to the popular assembly (for procedure, see ECCLESIA), which either passed it as it stood or made amendments subject to certain conditions. It must be clearly understood that the recommendation of the council had no intrinsic force until by the votes of the Ecclesia it passed into law as a psephism. But in addition to this function, the Council of the Five Hundred had large administrative and judicial control. (1) It was before the council that the Poletae arranged the farming of public revenues, the receipt of tenders for public works and the sale of confiscated property; further, it dealt with defaulting collectors (*ἐκλόγευς*), exacted the debts of private persons to the state, and probably drew up annual estimates. (2) It supervised the treasury payments of the Apodectae ("Receivers") and the "Treasurers of the God." (3) From Demosthenes (*In Androt.*) it is clear that it had to arrange for the provision of so many triremes per annum and

the award of the trierarchic crown. (4) It arranged for the maintenance of the cavalry and the special levies from the demes. (5) It heard certain cases of *eisangelia* (impeachment) and had the right to fine up to 500 drachmas, or hand the case over to the Heliæa. The cases which it tried were mainly prosecutions for crimes against the state (e.g. treason, conspiracy, bribery). In later times it acted mainly as a court of first instance. Subsequently (*Ath. Pol.* c. 45) its powers were limited and an appeal was allowed to the popular courts. (6) The council presided over the *dokimasia* (consideration of fitness) of the magistrates; this examination, which was originally concerned with a candidate's moral and physical fitness, degenerated into a mere inquiry into his politics. (7) In foreign affairs the council as the only body in permanent session naturally received foreign envoys and introduced them to the Ecclesia. Further, the Boule, with the Strategoi ("Generals"), took treaty oaths, after the Ecclesia had decided on the terms. The Xenophonic *Politeia* states that the council of the 5th century was "concerned with war," but in the 4th century it chiefly supervised the docks and the fleet. On two occasions at least the council was specially endowed with full powers; Demosthenes (*De Fals. Leg.* p. 389) states that the people gave it full powers to send ambassadors to Philip, and Andocides (*De Myst.* 14 foll.) states that it had full power to investigate the affair of the mutilation of the Hermae on the night before the sailing of the Sicilian Expedition.

It will be seen that this democratic council was absolutely essential to the working of the Athenian state. Without having any final legislative authority, it was a necessary part of the legislative machinery, and it may be regarded as certain that a large proportion of its recommendations were passed without alteration or even discussion by the Ecclesia. The Boule was, therefore, in the strict sense a committee of the Ecclesia, and was immediately connected with a system of sub-committees which exercised executive functions.

BIBLIOGRAPHY.—With this article compare ECCLESIA, STRATEGUS, ARCHON, DRACO, SOLON, CLEISTHENES, where collateral information is given. Besides the chief histories of Greece (Grote, ed. 1907, Meyer &c.), see Gilbert, *Constitutional Antiquities* (Eng. trans. by E. J. Brooks and T. Nicklin, 1895; J. B. Bury, *History of Greece* (1900); A. H. J. Greenidge *Handbook of Greek Constitutional History* (1896); J. E. Sandys' edition of the *Constitution of Athens*; Boeckh, *Die Staatshaushaltung der Athener* (1886); Schömann, *Griechische Altertümer* (1897-1902); Busolt, *Die griechischen Staats- und Rechtsaltertümer* (1902). See also H. Swoboda, *Die griechischen Volksbeschlüsse* (1890); Szanto, *Das griechische Bürgerrecht* (1892); Perrot, *Essai sur le droit public d'Athènes* (1869). It should be observed that all works published before 1891 are so far useless that they are without the information contained in the *Constitution of Athens* (q.v.). See also GREEK LAW. (J. M. M.)

BOULEVARD (a Fr. word, earlier *boulevard*, from Dutch or Ger. *Bollwerk*, cf. Eng. "bulwark"), originally, in fortification, an earthwork with a broad platform for artillery. It came into use owing to the width of the gangways in medieval walls being insufficient for the mounting of artillery thereon. The boulevard or bulwark was usually an earthen outwork mounting artillery, and so placed in advance as to prevent the guns of a besieger from battering the foot of the main walls. It was as a rule circular. Semicircular *demi-boulevards* were often constructed round the bases of the old masonry towers with the same object. In modern times the word is most frequently used to denote a promenade laid out on the site of a former fortification, and, by analogy, a broad avenue in a town planted with rows of trees.

BOULLE, ANDRÉ CHARLES (1642-1732), French cabinet-maker, who gave his name to a fashion of inlaying known as Boule or Buhl work. The son of Jean Boule, a member of a family of *ébénistes* who had already achieved distinction—Pierre Boule, who died c. 1636, was for many years *tourneur et menuisier du roy des cabinets d'ébène*,—he became the most famous of his name and was, indeed, the second cabinet-maker—the first was Jean Macé—who has acquired individual renown. That must have begun at a comparatively early age, for at thirty he had already been granted one of those lodgings in the galleries of the Louvre which had been set apart by Henry IV. for the use of the

¹ The institution of pay for the councillors may safely be ascribed to Pericles although we have no direct evidence of it before 411 B. C. (Thuc. viii. 60; see PERICLES).

most talented of the artists employed by the crown. To be admitted to these galleries was not only to receive a signal mark of royal favour, but to enjoy the important privilege of freedom from the trammels of the trade guilds. Boulle was given the deceased Jean Macé's own lodging in 1672 by Louis XIV. upon the recommendation of Colbert, who described him as "*le plus habile ébéniste de Paris*," but in the patent conferring this privilege he is described also as "chaser, gilder and maker of marqueterie." Boulle appears to have been originally a painter, since the first payment to him by the crown of which there is any record (1666) specifies "*ouvrages de peinture*." He was employed for many years at Versailles, where the mirrored walls, the floors of "wood mosaic," the inlaid panelling and the pieces in marqueterie in the Cabinet du Dauphin were regarded as his most remarkable work. These rooms were long since dismantled and their contents dispersed, but Boulle's drawings for the work are in the Musée des Arts Décoratifs. His royal commissions were, indeed, innumerable, as we learn both from the *Comptes des bâtiments* and from the correspondence of Louvois. Not only the most magnificent of French monarchs, but foreign princes and the great nobles and financiers of his own country crowded him with commissions, and the *mot* of the abbé de Marolles, "*Boulle y tourne en ovale*," has become a stock quotation in the literature of French cabinet-making. Yet despite his distinction, the facility with which he worked, the high prices he obtained, and his workshops full of clever craftsmen, Boulle appears to have been constantly short of money. He did not always pay his workmen, clients who had made considerable advances failed to obtain the fine things they had ordered, more than one application was made for permission to arrest him for debt under orders of the courts within the asylum of the Louvre, and in 1704 we find the king giving him six months' protection from his creditors on condition that he used the time to regulate his affairs or "*ce sera la dernière grâce que sa majesté lui fera là-dessus*." Twenty years later one of his sons was arrested at Fontainebleau and kept in prison for debt until the king had him released. In 1720 his finances were still further embarrassed by a fire which, beginning in another *atelier*, extended to his twenty workshops and destroyed most of the seasoned materials, appliances, models and finished work of which they were full. The salvage was sold and a petition for pecuniary help was sent to the regent, the result of which does not appear. It would seem that Boulle was never a good man of business, but, according to his friend Mariette, many of his pecuniary difficulties were caused by his passion for collecting pictures, engravings and other objects of art—the inventory of his losses in the fire, which exceeded £40,000 in amount, enumerates many old masters, including forty-eight drawings by Raphael and the manuscript journal kept by Rubens in Italy. He attended every sale of drawings and engravings, borrowed at high interest to pay for his purchases, and when the next sale took place, fresh expedients were devised for obtaining more money. Collecting was to Boulle a mania of which, says his friend, it was impossible to cure him. Thus he died in 1732, full of fame, years and debts. He left four sons who followed in his footsteps in more senses than one—Jean Philippe (born before 1690, dead before 1745), Pierre Benoit (d. 1741), Charles André (1685–1749) and Charles Joseph (1688–1754). Their affairs were embarrassed throughout their lives, and the three last are known to have died in debt.

All greatness is the product of its opportunities, and the elder Boulle was made by the happy circumstances of his time. He was born into a France which was just entering upon the most brilliant period of sumptuous magnificence which any nation has known in modern times. Louis XIV., so avid of the delights of the eye, by the reckless extravagance of his example turned the thoughts of his courtiers to domestic splendours which had hitherto been rare. The spacious palaces which arose in his time needed rich embellishment, and Boulle, who had not only inherited the rather flamboyant Italian traditions of the late Renaissance, but had *ébénisterie* in his blood, arose, as some such man invariably does arise, to gratify tastes in which personal pride and love of art were not unequally intermingled. He was

by no means the first Frenchman to practise the delightful art of marqueterie, nor was he quite the inventor of the peculiar type of inlay which is chiefly associated with his name; but no artist, before or since, has used these motives with such astonishing skill, courage and surety. He produced pieces of monumental solidity blazing with harmonious colour, or gleaming with the sober and dignified reticence of ebony, ivory and white metal. The Renaissance artists chiefly employed wood in making furniture, ornamenting it with gilding and painting, and inlaying it with agate, cornelian, lapis-lazuli, marble of various tints, ivory, tortoise-shell, mother-of-pearl and various woods. Boulle improved upon this by inlaying brass devices into wood or tortoise-shell, which last he greatly used according to the design he had immediately in view, whether flowers, scenes, scrolls, &c.; to these he sometimes added enamelled metal. Indeed the use of tortoise-shell became so characteristic that any furniture, however cheap and common, which has a reddish *fond* that might by the ignorant be mistaken for inlay, is now described as "Buhl"—the name is the invention of the British auctioneer and furniture-maker. In this process the brass is thin, and, like the ornamental wood or tortoise-shell, forms a veneer. In the first instance the production of his work was costly, owing to the quantity of valuable material that was cut away and wasted, and, in addition, the labour lost in separately cutting for each article or copy of a pattern. By a subsequent improvement Boulle effected an economy by gluing together various sheets of material and sawing through the whole, so that an equal number of figures and matrices were produced at one operation. Boulle adopted from time to time various plans for the improvement of his designs. He placed gold-leaf or other suitable material under the tortoise-shell to produce such effect as he required; he chased the brass-work with a graver for a like purpose, and, when the metal required to be fastened down with brass pins or nails, these were hammered flat and disguised by ornamental chasing. He also adopted, in relief or in the round, brass feet, brackets, edgings, and other ornaments of appropriate design, partly to protect the corners and edges of his work, and partly for decoration. He subsequently used other brass mountings, such as claw-feet to pedestals, or figures in high or low relief, according to the effect he desired to produce. These mounts in the pieces that undoubtedly come from Boulle's *atelier* are nearly always of the greatest excellence. They were cast in the rough—the tools of the chaser gave them their sharpness, their minute finish, their jewel-like smoothness.

Unhappily it is by no means easy, even for the expert, to declare the authenticity of a commode, a bureau, or a table in the manner of Boulle and to all appearance from his workshops. His sons unquestionably carried on the traditions for some years after his death, and his imitators were many and capable. A few of the more magnificent pedigree-pieces are among the world's mobiliary treasures. There are, for instance, the two famous *armoires*, which fetched £12,075 at the Hamilton Palace sale; the marqueterie commodes, enriched with bronze mounts, in the Bibliothèque Mazarine; various cabinets and commodes and tables in the Louvre, the Musée Cluny and the Mobilier National; the marriage coffers of the dauphin which were in the San Donato collection. There are several fine authenticated pieces in the Wallace collection at Hertford House, together with others consummately imitated, probably in the Louis Seize period. On the rare occasions when a pedigree example comes into the auction-room, it invariably commands a high price; but there can be little doubt that the most splendid and sumptuous specimens of Boulle are diminishing in number, while the second and third classes of his work are perhaps becoming more numerous. The truth is that this wonderful work, with its engraved or inlaid designs of Bérain, its myriads of tiny pieces of ivory and copper, ebony and tortoise-shell, all kept together with glue and tiny chased nails, and applied very often to a rather soft, white wood, is not meet to withstand the ravages of time and the variations of the atmosphere. Alternate heat and humidity are even greater enemies of inlaid furniture than time and wear—such delicate things are rarely much used, and

are protected from ordinary chances of deterioration. There is consequently reason to rejoice when a piece of real artistry in furniture finds its final home in a museum, where a degree of warmth is maintained which, however distressing it may be to the visitor, at least preserves the contents from one of the worst enemies of the collector. (J. P.-B.)

BOULOGNE, or **BOULLONGNE**, the name of a family of French painters. **LOUIS** (1609-1674), who was one of the original members of the Academy of Painting and Sculpture (1648), became celebrated under Louis XIV. His traditions were continued by his children: **GENEVÈVE** (1645-1708), who married the sculptor Jacques Clérion; **MADELEINE** (1646-1710), whose work survives in the *Trophées d'armes* at Versailles; **BON** (1649-1717), a successful teacher and decorative artist; and **LOUIS** the younger (1654-1733), who copied Raphael's cartoons for the Gobelin's tapestry, and besides taking a high place as a painter was also a designer of medals.

BOULOGNE-SUR-MER, a fortified seaport of northern France and chief town of an *arrondissement* in Pas-de-Calais, situated on the shore of the English Channel at the mouth of the river Liane, 157 m. N.N.W. of Paris on the Northern railway, and 28 m. by sea S.E. of Folkestone, Kent. Pop. (1906) 49,636. Boulogne occupies the summit and slopes of a ridge of hills skirting the right bank of the Liane; the industrial quarter of *Capécure* extends along the opposite bank, and is reached by two bridges, while the river is also crossed by a double railway viaduct. The town consists of two parts, the Haute Ville and the Basse Ville. The former, situated on the top of the hill, is of comparatively small extent, and forms almost a parallelogram, surrounded by ramparts of the 13th century, and, outside them, by boulevards, and entered by ancient gateways. In this part are the law court, the château and the hôtel de ville (built in the 18th century), and a belfry tower of the 13th and 17th centuries is in the immediate neighbourhood. In the château (13th century) now used as barracks, the emperor Napoleon III. was confined after the abortive insurrection of 1840. At some distance north-west stands the church of Notre-Dame, a well-known place of pilgrimage, erected (1827-1866) on the site of an old building destroyed in the Revolution, of which the extensive crypt still remains. The modern town stretches from the foot of the hill to the harbour, along which it extends, terminating in an expanse of sandy beach frequented by bathers, and provided with a bathing establishment and casino. It contains several good streets, some of which are, however, very steep. A main street, named successively *rue de la Lampe*, *St Nicolas* and *Grande rue*, extends from the bridge across the Liane to the promenade by the side of the ramparts. This is intersected first by the *Quai Gambetta*, and farther back by the *rue Victor Hugo* and the *rue Nationale*, which contain the principal shops. The public buildings include several modern churches, two hospitals and a museum with collections of antiquities, natural history, porcelain, &c. Connected with the museum is a public library with 75,000 volumes and a number of valuable manuscripts, many of them richly illuminated. There are English churches in the town, and numerous boarding-schools intended for English pupils. Boulogne is the seat of a sub-prefect, and has tribunals of first instance and of commerce, a board of trade-arbitrators, a chamber of commerce and a branch of the Bank of France. There are also communal colleges, a national school of music, and schools of hydrography, commerce and industry. Boulogne has for a long time been one of the most anglicized of French cities; and in the tourist season a continuous stream of English travellers reach the continent at this point.

The harbour is formed by the mouth of the Liane. Two jetties enclose a channel leading into the river, which forms a tidal basin with a depth at neap-tides of 24 ft. Alongside this is an extensive dock, and behind it an inner port. There is also a tidal basin opening off the entrance channel. The depth of water in the river-harbour is 33 ft. at spring-tide and 24 ft. at neap-tide; in the sluice of the dock the numbers are 29 and 23½ respectively. The commerce of Boulogne consists chiefly in the importation of jute, wool, woven goods of silk and wool, skins,

threads, coal, timber, and iron and steel, and the exportation of wine, woven goods, table fruit, potatoes and other vegetables, skins, motor-cars, forage and cement. The average annual value of the exports in the five years 1901-1905 was £10,953,000 (£11,704,000 in the years 1896-1900), and of the imports £6,064,000 (£7,003,000 in the years 1896-1900). From 1901 to 1905 the annual average of vessels entered, exclusive of fishing-smacks, was 2735, tonnage 1,747,699; and cleared 2750, tonnage 1,748,207. The total number of passengers between Folkestone and Boulogne in 1906 was 295,000 or 49% above the average for the years 1901-1905. These travelled by the steamers of the South-Eastern & Chatham railway company. The liners of the Dutch-American, Hamburg-American and other companies also call at the port. In the extent and value of its fisheries Boulogne is exceeded by no seaport in France. The most important branch is the herring-fishery; next in value is the mackerel. Large quantities of fresh fish are transmitted to Paris by railway, but an abundant supply is reserved to the town itself. The fishermen live for the most part in a separate quarter called *La Beurrière*, situated in the upper part of the town. In 1905 the fisheries of Boulogne and the neighbouring village of *Etaples* employed over 400 boats and 4500 men, the value of the fish taken being estimated at £1,025,000. Among the numerous industrial establishments in Boulogne and its environs may be mentioned foundries, cement-factories, important steel-plant manufactories, oil-works, dye-works, fish-curing works, flax-mills, saw-mills, and manufactories of cloth, fireproof ware, chocolate, boots and shoes; and soap. Shipbuilding is also carried on.

Among the objects of interest in the neighbourhood the most remarkable is the *Colonne de la Grande Armée*, erected on the high ground above the town, in honour of Napoleon I., on occasion of the projected invasion of England, for which he here made great preparations. The pillar, which is of the Doric order, 166 ft. high, is surmounted by a statue of the emperor by A. S. Bosio. Though begun in 1804, the monument was not completed till 1841. On the edge of the cliff to the east of the port are some rude brick remains of an old building called *Tour d'Ordre*, said to be the ruins of a tower built by Caligula at the time of his intended invasion of Britain.

Boulogne is identified with the *Gessoriacum* of the Romans, under whom it was an important harbour. It is suggested that it was the *Portus Itius* where Julius Caesar assembled his fleet (see *ITRUS PORTUS*). At an early period it began to be known as *Bononia*, a name which has been gradually modified into the present form. The town was destroyed by the Normans in 882, but restored about 912. During the Carolingian period Boulogne was the chief town of a countship that was for long the subject of dispute between Flanders and Ponthieu. From the year 965 it belonged to the house of Ponthieu, of which Godfrey of Bouillon, the first king of Jerusalem, was a scion. Stephen of Blois, who became king of England in 1135, had married Mahaut, daughter and heiress of Eustace, count of Boulogne. Their daughter Mary married Mathew of Alsace (d. 1173), and her daughter Ida (d. 1216) married Renaud of Dammartin. Of this last marriage was issue Mahaut, countess of Boulogne, wife of Philip Hurepel (d. 1234), a son of King Philip Augustus. To her succeeded the house of Brabant, issue of Mahaut of Boulogne, sister of Ida, and wife of Henry I. of Brabant; and then the house of Auvergne, issue of Alice, daughter of Henry I. of Brabant, inherited the Boulonnais. It remained in the possession of descendants of these families until Philip the Good, duke of Burgundy, seized upon it in 1419. In 1477 Louis XI. of France reconquered it, and reunited it to the French crown, giving Lauraguais as compensation to Bertrand IV. de la Tour, count of Auvergne, heir of the house of Auvergne. To avoid doing homage to Mary of Burgundy, suzerain of the Boulonnais and countess of Artois, Louis XI. declared the countship of Boulogne to be held in fee of Our Lady of Boulogne. In 1544 Henry VIII.—more successful in this than Henry III. had been in 1347—took the town by siege; but it was restored to France in 1550.

From 1566 to the end of the 18th century it was the seat of a bishopric.

BOULOGNE-SUR-SEINE, a town of northern France, in the department of Seine, on the right bank of the Seine, S.W. of Paris and immediately outside the fortifications. Pop. (1906) 49,412. The town has a Gothic church of the 14th and 15th centuries (restored in 1863) founded in honour of Notre-Dame of Boulogne-sur-Mer. To this fact is due the name of the place, which was previously called Menus-lès-St Cloud. Laundrying is extensively carried on as well as the manufacture of metal boxes, soap, oil and furniture, and there are numerous handsome residences. For the neighbouring Bois de Boulogne see PARIS.

BOULTON, MATTHEW (1728-1809), English manufacturer and engineer, was born on the 3rd of September 1728, at Birmingham, where his father, Matthew Boulton the elder, was a manufacturer of metal articles of various kinds. To this business he succeeded on his father's death in 1759, and in consequence of its growth removed his works in 1762 from Snowhill to what was then a tract of barren heath at Soho, 2 m. north of Birmingham. Here he undertook the manufacture of artistic objects in metal, as well as the reproduction of oil paintings by a mechanical process in which he was associated with Francis Eginton (1737-1805), who subsequently achieved a reputation as a worker in stained or enamelled glass. About 1767, Boulton, who was finding the need of improving the motive power for his machinery, made the acquaintance of James Watt, who on his side appreciated the advantages offered by the Soho works for the development of his steam-engine. In 1772 Watt's partner, Dr John Roebuck, got into financial difficulties, and Boulton, to whom he owed £1200, accepted the two-thirds share in Watt's patent held by him in satisfaction of the debt. Three years later Boulton and Watt formally entered into partnership, and it was mainly through the energy and self-sacrifice of the former, who devoted all the capital he possessed or could borrow to the enterprise, that the steam-engine was at length made a commercial success. It was also owing to Boulton that in 1775 an act of parliament was obtained extending the term of Watt's 1769 patent to 1790. In 1800 the two partners retired from the business, which they handed over to their sons, Matthew Robinson Boulton and James Watt junior. In 1788 Boulton turned his attention to coining machinery, and erected at Soho a complete plant with which he struck coins for the Sierra Leone and East India companies and for Russia, and in 1797 produced a new copper coinage for Great Britain. In 1797 he took out a patent in connexion with raising water on the principle of the hydraulic ram. He died at Birmingham on the 18th of August 1809.

BOUND, or **BOUNDARY** (from O. Fr. *bonde*, Med. Lat. *bodena* or *butina*, a frontier line), that which serves to indicate the limit or extent of land. It is usually defined by a certain mark, such as a post, ditch, hedge, dyke, wall of stones, &c., though on the other hand it may have to be ascertained by reference to a plan or by measurement. In law, the exact boundary of land is always a matter of evidence; where no evidence is available, the court acts on presumption. For example, the boundary of land on opposite sides of a road, whether public or private, is presumed to be the middle line of the road. Where two fields are separated by a hedge and ditch the boundary line will run between the hedge and the ditch. Boundaries of parishes, at common law, depended upon ancient and immemorial custom, and in many parishes great care was taken to perpetuate the boundaries of the parish by perambulations from time to time. The confusion of local boundaries in England was the subject of several commissions and committees in the 19th century, and much information will be found in their reports (1868, 1870, 1873, 1888). The Local Government Act 1888, ss. 50-63, contains provisions for the alteration of local areas.

BOUNDS, BEATING THE, an ancient custom still observed in many English parishes. In former times when maps were rare it was usual to make a formal perambulation of the parish boundaries on Ascension day or during Rogation week. The latter is in the north of England still called "Gang Week"

or "Ganging Days" from this "ganging" or procession. The priest of the parish with the churchwardens and the parochial officials headed a crowd of boys who, armed with green boughs, beat with them the parish border-stones. Sometimes the boys were themselves whipped or even violently bumped on the boundary-stones to make them remember. The object of taking boys was obviously to ensure that witnesses to the boundaries should survive as long as possible. In England the custom is as old as Anglo-Saxon days, as it is mentioned in laws of Alfred and Æthelstan. It is thought that it may have been derived from the Roman Terminalia, a festival celebrated on the 22nd of February in honour of Terminus, the god of landmarks, to whom cakes and wine were offered, sports and dancing taking place at the boundaries. In England a parish-ale or feast was always held after the perambulation, which assured its popularity, and in Henry VIII.'s reign the occasion had become an excuse for so much revelry that it attracted the condemnation of a preacher who declared "these solemn and accustomable processions and supplications be now grown into a right foule and detestable abuse." Beating the bounds had a religious side in the practice which originated the term Rogation, the accompanying clergy being supposed to beseech (*rogare*) the divine blessing upon the parish lands for the ensuing harvest. This feature originated in the 5th century, when Mamercus, bishop of Vienne, instituted special prayers and fasting and processions on these days. This clerical side of the parish bounds-beating was one of the religious functions prohibited by the Injunctions of Queen Elizabeth; but it was then ordered that the perambulation should continue to be performed as a quasi-secular function, so that evidence of the boundaries of parishes, &c. might be preserved (Gibson, *Codex juris Ecclesiastici Anglicani* (1761) pp. 213-214). Bequests were sometimes made in connexion with bounds-beating. Thus at Leighton Buzzard on Rogation Monday, in accordance with the will of one Edward Wilkes, a London merchant who died in 1646, the trustees of his almshouses accompanied the boys. The will was read and beer and plum rolls distributed. A remarkable feature of the bequest was that while the will is read one of the boys has to stand on his head.

BOUNTY (through O. Fr. *bonet*, from Lat. *bonitas*, goodness), a gift or gratuity; more usually, a premium paid by a government to encourage some branch of production or industry, as in England in the case of the bounty on corn, first granted in 1683 and abolished in 1814, the herring-fishery bounties, the bounties on sail-cloth, linen and other goods. It is admitted that the giving of bounties is generally impolitic, though they may sometimes be justified as a measure of state. The most striking modern example of a bounty was that on sugar (*q.v.*). Somewhat akin to bounties are the subsidies granted to shipping (*q.v.*) by many countries. Bounties or, as they may equally well be termed, grants are often given, more especially in new countries, for the destruction of beasts of prey; in the United States and some other countries, bounties have been given for tree-planting; France has given bounties to encourage the Newfoundland fisheries.

Bounty was also the name given to the money paid to induce men to enlist in the army or navy, and, in the United Kingdom, to the sum given on entering the militia reserve. During the American Civil War, many recruits joined solely for the sake of the bounty offered, and afterwards deserted; they were called "bounty-jumpers." The term bounty was also applied in the English navy to signify money payable to the officers and crew of a ship in respect of services on particular occasions.

Queen Anne's Bounty (*q.v.*) is a fund applied for the augmentation of poor livings in the established church.

King's Bounty is a grant made by the sovereign of his royal bounty to those of his subjects whose wives are delivered of three or more children at a birth.

BOURBAKI, CHARLES DENIS SAUTER (1816-1897), French general, was born at Pau on the 22nd of April 1816, the son of a Greek colonel who died in the War of Independence in 1827. He entered St Cyr, and in 1836 joined the Zouaves, becoming lieutenant of the Foreign Legion in 1838, and aide-de-camp to

King Louis Philippe. It was in the African expedition that he first came to the front. In 1842 he was captain in the Zouaves; 1847, colonel of the Turcos; in 1850, lieutenant-colonel of the 1st Zouaves; 1851, colonel; 1854, brigadier-general. In the Crimean War he commanded a portion of the Algerian troops; and at the Alma, Inkerman and Sevastopol Bourbaki's name became famous. In 1857 he was made general of division, commanding in 1859 at Lyons. His success in the war with Italy was only second to that of MacMahon, and in 1862 he was proposed as a candidate for the vacant Greek throne, but declined the proffered honour. In 1870 the emperor entrusted him with the command of the Imperial Guard, and he played an important part in the fighting round Metz.

A curious incident of the siege of Metz is connected with Bourbaki's name. A man who called himself Regnier,¹ about the 21st of September, appeared at Hastings, to seek an interview with the refugee empress Eugénie, and failing to obtain this he managed to get from the young prince imperial a signed photograph with a message to the emperor Napoleon. This he used, by means of a safe-conduct from Bismarck, as credentials to Marshal Bazaine, to whom he presented himself at Metz, telling him on the empress's alleged authority that peace was about to be signed and that either Marshal Canrobert or General Bourbaki was to go to Hastings for the purpose. Bourbaki at once went to England, with Prussian connivance, as though he had a recognized mission, only to discover from the empress at Hastings that a trick had been played on him; and as soon as he could manage he returned to France. He offered his services to Gambetta and received the command of the Northern Army, but was recalled on the 19th of November and transferred to the Army of the Loire. In command of the hastily-trained and ill-equipped Army of the East, Bourbaki made the attempt to raise the siege of Belfort, which, after the victory of Villersexel, ended in the repulse of the French in the three days' battle of the Lisaine. Other German forces under Manteuffel now closed upon Bourbaki, and he was eventually driven over the Swiss frontier with the remnant of his forces (see FRANCO-GERMAN WAR). His troops were in the most desperate condition, owing to lack of food; and out of 150,000 men under him when he started, only 8,000 escaped from the Germans into Swiss territory. Bourbaki himself, rather than submit to the humiliation of a probable surrender, on the 26th of January 1871 delegated his functions to General Clinchant, and in the night fired a pistol at his own head, but the bullet, owing to a deviation of the weapon, was flattened against his skull and his life was saved. General Clinchant carried Bourbaki into Switzerland, and he recovered sufficiently to return to France. In July 1871 he again took the command at Lyons, and subsequently became military governor. In 1881, owing to his political opinions, he was placed on the retired list. In 1885 he was an unsuccessful candidate for the senate. He died on the 27th of September 1897. A patriotic Frenchman and a brilliant soldier and leader, Bourbaki, like some other French generals of the Second Empire whose training had been obtained in Africa, was found wanting in the higher elements of command when the European conditions of 1870 were concerned.

BOURBON. The noble family of Bourbon, from which so many European kings have sprung, took its name from Bourbon l'Archambault, chief town of a lordship which in the 10th century was one of the largest baronies of the kingdom of France. The limits of the lordship, which was called the Bourbonnais, were approximately those of the modern department of Allier, being on the N. the Nivernais and Berry, on the E. Burgundy and Lyonnais, on the S. Auvergne and Marche and on the W. Berry.

¹The whole Regnier affair remained a mystery; the man himself—who on following Bourbaki to England made the impression on Lord Granville (see the *Life of Lord Granville*, by Lord Fitzmaurice, ii. 61) of being a "swindler" but honestly wishing to serve the empress—was afterwards mixed up in the Humbert frauds of 1908-1909; he published his own version of the affair in 1870 in a pamphlet, *Quel est votre nom?* It has been suspected that on the part either of Bazaine or of the German authorities some undisclosed intrigue was on foot.

The first of the long line of Bourbons known in history was Adhémar or Aimar, who was invested with the barony towards the close of the 9th century. Matilda, heiress of the first house of Bourbon, brought this lordship to the family of Dampierre by her marriage, in 1196, with Guy of Dampierre, marshal of Champagne (d. 1215). In 1272 Beatrix, daughter of Agnes of Bourbon-Dampierre, and her husband John of Burgundy, married Robert, count of Clermont, sixth son of Louis IX. (St Louis) of France. The elder branches of the family had become extinct, and their son Louis became duke of Bourbon in 1327. In 1488 the line of his descendants ended with Jean II., who died in that year. The whole estates passed to Jean's brother Pierre, lord of Beaujeu, who was married to Anne, daughter of Louis XI. Pierre died in 1503, leaving only a daughter, Suzanne, who, in 1505, married Charles de Montpensier, heir of the Montpensier branch of the Bourbon family. Charles, afterwards constable of France, who took the title of duke of Bourbon on his marriage, was born in 1480, and at an early age was looked upon as one of the finest soldiers and gentlemen in France. With the constable ended the direct line from Pierre I., duke of Bourbon (d. 1356). But the fourth in descent from Pierre's brother, Jacques, count of La Marche, Louis, count of Vendôme and Chartres (d. 1446), became the ancestor of the royal house of Bourbon and of the noble families of Condé, Conti and Montpensier. The fourth in direct descent from Louis of Vendôme was Antoine de Bourbon, who in 1548 married Jeanne d'Albret, heiress of Navarre, and became king of Navarre in 1554. Their son became king of France as Henry IV. Henry was succeeded by his son, Louis XIII., who left two sons, Louis XIV., and Philip, duke of Orleans, head of the Orleans branch. Louis XIV.'s son, the dauphin, died before his father, and left three sons, one of whom died without issue. Of the others the elder, Louis of Burgundy, died in 1712, and his only surviving son became Louis XV. The younger, Philip, duke of Anjou, became king of Spain, and founded the Spanish branch of the Bourbon family. Louis XV. was succeeded by his grandson, Louis XVI., who perished on the scaffold. At the restoration the throne of France was occupied by Louis XVIII., brother of Louis XVI., who in turn was succeeded by his brother Charles X. The second son of Charles X., the duc de Berry, left a son, Henri Charles Ferdinand Marie Dieudonné d'Artois, duc de Bordeaux, and comte de Chambord (q.v.). From Louis XIV.'s brother, Philip, descended another claimant of the throne. Philip's son was the regent Orleans, whose great-grandson, "Philippe Egalité," perished on the scaffold in 1793. Egalité's son, Louis Philippe, was king of the French from 1830 to 1848; his grandson, Louis Philippe, comte de Paris (1838-1894), inherited on the death of the comte de Chambord the rights of that prince to the throne of France, and was called by the royalists Philip VII. He had a son, Louis Philippe Robert, duc d'Orléans, called by his adherents Philip VIII.

Spanish Branch.—Philip, duke of Anjou, grandson of Louis XIV., became king of Spain as Philip V., in 1700. He was succeeded in 1746 by his son Ferdinand VI., who died in 1759 without family, and was followed by his brother Charles III. Charles III.'s eldest son became Charles IV. of Spain in 1788, while his second son, Ferdinand, was made king of Naples in 1759. Charles IV. was deposed by Napoleon, but in 1814 his son, Ferdinand VII., again obtained his throne. Ferdinand was succeeded by his daughter Isabella, who in 1870 abdicated in favour of her son, Alphonso XIII. (d. 1885). Alphonso's posthumous son became king of Spain as Alphonso XIII. Ferdinand's brother, Don Carlos (d. 1855), claimed the throne in 1833 on the ground of the Salic law, and a fierce war raged for some years in the north of Spain. His son Don Carlos, count de Montemolin (1818-1861), revived the claim, but was defeated and compelled to sign a renunciation. The nephew of the latter, Don Carlos Maria Juan Isidor, duke of Madrid, for some years carried on war in Spain with the object of attaining the rights contended for by the Carlist party.

Neapolitan Branch.—The first Bourbon who wore the crown of Naples was Charles III. of Spain, who on his succession to

GENEALOGICAL TABLE OF THE HOUSE OF BOURBON

I. The French Bourbons

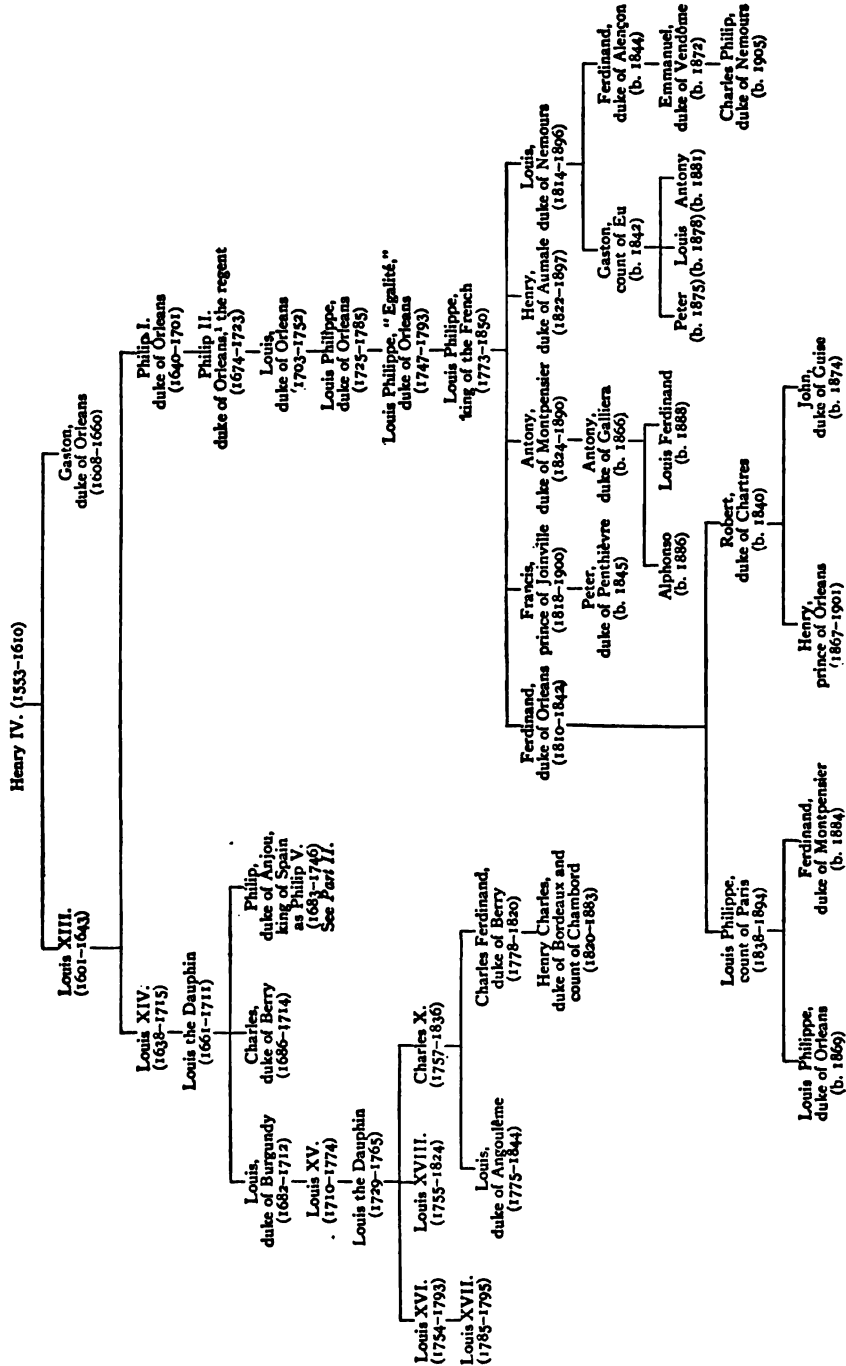

Philip married a natural daughter of Louis XIV., and in this way the later princes of Orleans are descended from the Grand Monarque.

II. The Spanish and Italian Bourbons.
Philip V., King of Spain (1683-1746)

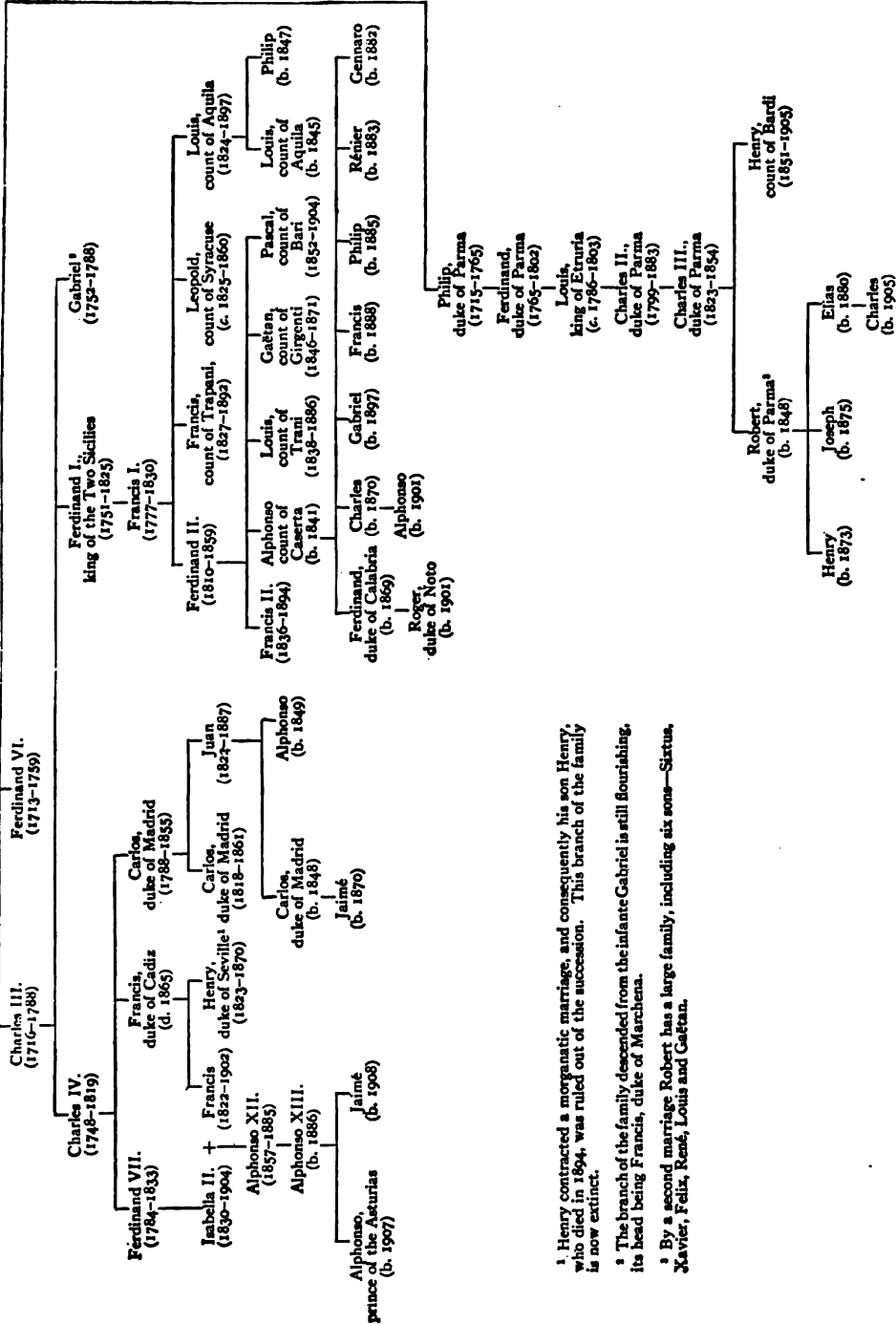

¹ Henry contracted a morganatic marriage, and consequently his son Henry, who died in 1894, was ruled out of the succession. This branch of the family is now extinct.

² The branch of the family, descended from the infante Gabriel is still flourishing, its head being Francis, duke of Marchena.

³ By a second marriage Robert has a large family, including six sons—Sixtus, Xavier, Felix, René, Louis and Gaetan.

the Spanish throne in 1759, resigned his kingdom of Naples to his son Ferdinand. Ferdinand was deposed by Napoleon, but afterwards regained his throne, and took the title of Ferdinand I., king of the Two Sicilies. In 1825 he was succeeded by his son Francis, who in turn was succeeded in 1830 by his son Ferdinand II. Ferdinand II. died in 1859, and in the following year his successor Francis II. was deprived of his kingdom, which was incorporated into the gradually-uniting Italy.

Duchies of Lucca and Parma.—In 1748 the duchy of Parma was conferred on Philip, youngest son of Philip V. of Spain. He was succeeded by his son Ferdinand in 1765. Parma was ceded to France in 1801, Ferdinand's son Louis being made king of Etruria, but the French only took possession of the duchy after Ferdinand's death in 1802. Louis's son Charles Louis was forced to surrender Etruria to France in 1807, and he was given the duchy of Lucca by the congress of Vienna in 1815. In 1847, on the death of Marie Louise, widow of Napoleon, who had received Parma and Piacenza in accordance with the terms of the treaty of Paris of 1814, Charles Louis succeeded to the duchies as Charles II., at the same time surrendering Lucca to Tuscany. In 1849 he abdicated in favour of his son, Charles III., who married a daughter of the duke of Berry, and was assassinated in 1854, being succeeded by his son Robert. In 1860 the duchies were annexed by Victor Emmanuel to the new kingdom of Italy.

Bastard Branches.—There are numerous bastard branches of the family of Bourbon, the most famous being the Vendôme branch, descended from Caesar, natural son of Henry IV., and the Maine and Toulouse branches, descended from the two natural sons of Louis XIV. and Madame de Montespan.

See Coiffier de Moret, *Histoire du Bourbonnais et des Bourbons* (2 vols., 1824); Berand, *Histoire des sires et ducs de Bourbon* (1835); Dtsormeaux, *Histoire de la maison de Bourbon* (5 vols., 1782-1788); Achainre, *Histoire généalogique et chronologique de la maison royale de Bourbon* (2 vols., 1825-1826); and Dussieux, *Généalogie de la maison de Bourbon* (1872).

BOURBON, CHARLES, DUKE OF (1490-1527), constable of France, second son of Gilbert, count of Montpensier and dauphin of Auvergne, was born on the 17th of February 1490, his mother being a Gonzaga. In 1505 he married Suzanne, heiress of Peter II., duke of Bourbon, by Anne of France, daughter of King Louis XI., and assumed the title of duke of Bourbon. The addition of this duchy to the numerous duchies, countships and other fiefs which he had inherited on the death of his elder brother Louis in 1507, made him at the age of fifteen the wealthiest noble in Europe. He gained his first military experience in the Italian campaigns of Louis XII., taking part in the suppression of the Genoese revolt (1507) and contributing to the victory over the Venetians at Agnadello (May 14, 1506). Shortly after the accession of Francis I. Bourbon received the office of constable of France, and for his brilliant services at the battle of Marignano (September 1515) he was made governor of the Milanese, which he succeeded in defending against an attack of the emperor Maximilian. But dissensions arose between Francis and the constable. Grave, haughty and taciturn, Bourbon was but ill suited to the levities of the court, and his vast wealth and influence kindled in the king a feeling of resentment, if not of fear. The duke was recalled from the government of the Milanese; his official salary and the sums he had borrowed for war expenses remained unpaid; and in the campaign in the Netherlands against the emperor Charles V. the command of the vanguard, one of the most cherished prerogatives of the constables, was taken from him. The death of his wife without surviving issue, on the 28th of April 1521, afforded the mother of the king, Louise of Savoy, a means to gratify her greed, and at the same time to revenge herself on Bourbon, who had slighted her love. A suit was instituted at her instance against the duke in the parlement of Paris, in which Louise, as grand-daughter of Charles, duke of Bourbon (d. 1456), claimed the female and some of the male fiefs of the duchy of Bourbon, while the king claimed those fiefs which were originally appanages, as escheating to the crown, and other claims were put forward. Before the parlement was able to arrive at a decision, Francis handed over

to his mother a part of the Bourbon estates, and ordered the remainder to be sequestered.

Smarting under these injuries, Bourbon, who for some time had been coquetting with the enemies of France, renewed his negotiations with the emperor and Henry VIII. of England. It was agreed that the constable should raise in his own dominions an armed force to assist the emperor in an invasion of France, and should receive in return the hand of Eleonora, queen dowager of Portugal, or of another of the emperor's sisters, and an independent kingdom comprising his own lands together with Dauphiné and Provence. He was required, too, to swear fidelity to Henry VIII. as king of France. But Bourbon's plans were hampered by the presence of the French troops assembling for the invasion of Italy, and for this reason he was unable to effect a junction with the emperor's German troops from the east. News of the conspiracy soon reached the ears of Francis, who was on his way to take command of the Italian expedition. In an interview with Bourbon at Moulins the king endeavoured to persuade him to accompany the French army into Italy, but without success. Bourbon remained at Moulins for a few days, and after many vicissitudes escaped into Italy. The joint invasion of France by the emperor and his ally of England had failed signally, mainly through lack of money and defects of combination. In the spring of 1524, however, Bourbon at the head of the imperialists in Lombardy forced the French across the Sesia (where the chevalier Bayard was mortally wounded) and drove them out of Italy. In August 1524 he invested Marseilles, but being unable to prevent the introduction of supplies by Andrea Doria, the Genoese admiral in the service of Francis, he was forced to raise the siege and retreat to the Milanese. He took part in the battle of Pavia (1525), where Francis was defeated and taken prisoner. But Bourbon's troops were clamouring for pay, and the duke was driven to extreme measures to satisfy their demands. Cheated of his kingdom and his bride after the treaty of Madrid (1526), Bourbon had been offered the duchy of Milan by way of compensation. He now levied contributions from the townsmen, and demanded 20,000 ducats for the liberation of the chancellor Girolamo Morone (d. 1529), who had been imprisoned for an attempt to realize his dream of an Italy purged of the foreigner. But the sums thus raised were wholly inadequate. In February 1527 Bourbon's army was joined by a body of German mercenaries, mostly Protestants, and the combined forces advanced towards the papal states. Refusing to recognize the truce which the viceroy of Naples had concluded with Pope Clement VII., Bourbon hastened to put into execution the emperor's plan of attaching Clement to his side by a display of force. But the troops, starving and without pay, were in open mutiny, and Spaniards and Lutherans alike were eager for plunder. On the 5th of May 1527 the imperial army appeared before the walls of Rome. On the following morning Bourbon attacked the Leonine City, and while mounting a scaling ladder fell mortally wounded by a shot, which Benvenuto Cellini in his *Life* claims to have fired. After Bourbon's death his troops took and sacked Rome.

See E. Armstrong, *Charles V.* (London, 1902); *Cambridge Med. Hist.* vol. ii., bibliography to chaps. i. ii. and iii.

BOURBON-LANCY, a watering-place of east-central France in the department of Saône-et-Loire, on a hill about 2 m. from the right bank of the Loire and on the Borne, 52 m. S.S.E. of Nevers by rail. Pop. (1906) town, 1896; commune, 4266. The town possesses thermal springs, resorted to in the Roman period, and ancient baths and other remains have been found. The waters, which are saline and ferruginous, are used for drinking and bathing, in cases of rheumatism, &c. Their temperature varies from 117° to 132° F. Cardinal Richelieu, Madame de Sévigné, James II. of England, and other celebrated persons visited the springs in the 17th and 18th centuries. The town has a well-equipped bathing establishment, a large hospital, and a church of the 11th and 12th centuries (used as an archaeological museum), and there are ruins of an old stronghold on a hill overlooking the town. A belfry pierced by a gateway of

the 15th century and houses of the 15th and 16th centuries also remain. The industries of the town include the manufacture of farm implements.

In the middle ages Bourbon-Lancy was an important stronghold and a fief of the Bourbon family, from the name of a member of which the suffix to its name is derived.

BOURBON L'ARCHAMBAULT, a town of central France in the department of Allier, on the Burge, 16 m. W. of Moulins by rail. Pop. (1906) 2306. The town has thermal springs known in Roman times, which are used in cases of scrofula and rheumatism. The bathing-establishment is owned by the state. A church dating from the 12th century, and ruins of a castle of the dukes of Bourbon (13th and 15th centuries), including a cylindrical keep, are of interest. There are a military and a civil hospital in the town. Stone is quarried in the vicinity. Bourbon (*Aquæ Borbonis* or *Bormonis*) was anciently the capital of the Bourbonnais and gave its name to the great Bourbon family. The affix Archambault is the name of one of its early lords.

BOURBONNE-LES-BAINS, a town of eastern France, in the department of Haute-Marne, 35½ m. by rail E.N.E. of Langres. Pop. (1906) 3738. It is much frequented on account of its hot saline springs, which were known to the Romans under the name *Aquæ Borbonis*. The heat of these springs varies from 110° to 155° F. The waters are used in cases of lymphatic affections, scrofula, rheumatism, wounds, &c. The principal buildings are a church of the 12th century, the state bathing-establishment and the military hospital; there are also the remains of a castle. Timber-sawing and plaster manufacture are carried on in the town. In the neighbourhood are the buildings of the celebrated Cistercian abbey of Morimond.

BOURCHIER, ARTHUR (1864—), English actor, was born in Berkshire in 1864, and educated at Eton and Christ Church, Oxford. At the university he became prominent as an amateur actor in connexion with the O.U.A.D.C., which he founded, and in 1880 he joined Mrs Langtry as a professional. He also acted with Charles Wyndham at the Criterion, and was for a while in Daly's company in America. In 1894 he married the actress Violet Vanbrugh, elder sister of the no less well-known actress Lillian Vanbrugh, and he and his wife subsequently took the leading parts under his management of the Garrick theatre. Both as tragedian and comedian Mr Bouchier took high rank on the London stage, and his career as actor-manager was remarkable for the production of a number of successful modern plays, by Mr Sutro and others.

BOURCHIER, THOMAS (c. 1404—1486), English archbishop, first chancellor and cardinal, was a younger son of William Bouchier, count of Eu (d. 1420), and through his mother, Anne, a daughter of Thomas of Woodstock, duke of Gloucester, was a descendant of Edward III. One of his brothers was Henry, earl of Essex (d. 1483), and his grand-nephew was John, Lord Bishops, the translator of Froissart. Educated at Oxford and then entering the church, he obtained rapid promotion, and after holding some minor appointments he became bishop of Worcester in 1434. In the same year he was chancellor of the university of Oxford, and in 1443 he was appointed bishop of Ely; then in April 1454 he was made archbishop of Canterbury, becoming lord chancellor of England in the following March. Bouchier's short term of office as chancellor coincided with the opening of the Wars of the Roses, and at first he was not a strong partisan, although he lost his position as chancellor when Richard, duke of York, was deprived of power in October 1456. Afterwards, in 1458, he helped to reconcile the contending parties, but when the war was renewed in 1459 he appears as a decided Yorkist; he crowned Edward IV. in June 1461, and four years later he performed a similar service for the queen, Elizabeth Woodville. In 1457 Bouchier took the chief part in the trial of Reginald Peacock, bishop of Chichester, for heresy; in 1467 he was created a cardinal; and in 1475 he was one of the four arbitrators appointed to arrange the details of the treaty of Picquigny between England and France. After the death of Edward IV. in 1483 Bouchier persuaded the queen to allow

her younger son, Richard, duke of York, to share his brother's residence in the Tower of London; and although he had sworn to be faithful to Edward V. before his father's death, he crowned Richard III. in July 1483. He was, however, in no way implicated in the murder of the young princes, and he was probably a participant in the conspiracies against Richard. The third English king crowned by Bouchier was Henry VII., whom he also married to Elizabeth of York in January 1486. The archbishop died on the 30th of March 1486 at his residence, Knole, near Sevenoaks, and was buried in Canterbury cathedral.

See W. F. Hook, *Lives of the Archbishops of Canterbury* (1860—1884).

BOURDALOUE, LOUIS (1632—1704), French Jesuit and preacher, was born at Bourges on the 20th of August 1632. At the age of sixteen he entered the Society of Jesus, and was appointed successively professor of rhetoric, philosophy and moral theology, in various colleges of the Order. His success as a preacher in the provinces determined his superiors to call him to Paris in 1669 to occupy for a year the pulpit of the church of St Louis. Owing to his eloquence he was speedily ranked in popular estimation with Cornille, Racine, and the other leading figures of the most brilliant period of Louis XIV.'s reign. He preached at the court of Versailles during the Advent of 1670 and the Lent of 1672, and was subsequently called again to deliver the Lenten course of sermons in 1674, 1675, 1680 and 1682, and the Advent sermons of 1684, 1689 and 1693. This was all the more noteworthy as it was the custom never to call the same preacher more than three times to court. On the revocation of the Edict of Nantes he was sent to Languedoc to confirm the new converts in the Catholic faith, and he had extraordinary success in this delicate mission. Catholics and Protestants were unanimous in praising his fiery eloquence in the Lent sermons which he preached at Montpellier in 1686. Towards the close of his life he confined his ministry to charitable institutions, hospitals and prisons, where his sympathetic discourses and conciliatory manners were always effective. He died in Paris on the 13th of May 1704. His peculiar strength lay in his power of adapting himself to audiences of every kind, and throughout his public career he was highly appreciated by all classes of society. His influence was due as much to his saintly character and to the gentleness of his manners as to the force of his reasoning. Voltaire said that his sermons surpassed those of Bossuet (whose retirement in 1669, however, practically coincided with Bourdaloue's early pulpit utterances); and there is little doubt that their simplicity and coherence, and the direct appeal which they made to hearers of all classes, gave them a superiority over the more profound sermons of Bossuet. Bourdaloue may be with justice regarded as one of the greatest French orators, and many of his sermons have been adopted as text-books in schools.

BIBLIOGRAPHY.—The only authoritative source for the Sermons is the edition of Père Bretonneau (14 vols., Paris, 1707—1721, followed by the *Pensées*, 2 vols., 1734). There has been much controversy both as to the authenticity of some of the sermons in this edition and as to the text in general. It is, however, generally agreed that the changes confessedly made by Bretonneau were merely formal. Other editions not based on Bretonneau are inferior; some, indeed, are altogether spurious (e.g. that of Abbé Sicard, 1810). Among critical works are: Anatole Feugère, *Bourdaloue, sa prédication et son temps* (Paris, 1874); Adrien Lézat, *Bourdaloue, théologien et orateur* (Paris, 1874); P. M. Lauras, *Bourdaloue, sa vie et ses œuvres* (2 vols., Paris, 1881); Abbe Blampignon, *Étude sur Bourdaloue* (Paris, 1886); Henri Chérot, *Bourdaloue inconnu* (Paris, 1898), and *Bourdaloue, sa correspondance et ses correspondants* (Paris, 1898—1904); L. Pauthe, *Bourdaloue (les maîtres de la chaire au XVII^e siècle)* (Paris, 1900); E. Grisel, *Bourdaloue, histoire critique de sa prédication* (2 vols., Paris, 1901), *Sermons inédits; bibliographie, &c.* (Paris, 1901), *Deux sermons inédits sur le royaume de Dieu* (Lille and Paris, 1904); Ferdinand Castets, *Bourdaloue, la vie et la prédication d'un religieux au XVII^e siècle*, and *La Revue Bourdaloue* (Paris, 1902—1904); C. H. Brooke, *Great French Preachers* (sermons of Bourdaloue and Bossuet, London, 1904); F. Brunetière, "L'Eloquence de Bourdaloue," in *Revue des deux mondes* (August 1904), a general inquiry into the authenticity of the sermons and their general characteristics.

BOURDON, FRANÇOIS LOUIS (d. 1797), known as **BOURDON DE L'OISE**, French revolutionist, was *procureur* at the parlement

of Paris. He ardently embraced the revolutionary doctrines and took an active part in the insurrection of the 10th of August 1792. Representing the department of the Oise in the Convention, he voted for the immediate death of the king. He accused the Girondists of relations with the court, then turned against Robespierre, who had him expelled from the Jacobin club for his conduct as commissioner of the Convention with the army of La Rochelle. On the 9th Thermidor he was one of the deputies delegated to aid Barras to repress the insurrection made by the commune of Paris in favour of Robespierre. Bourbon then became a violent reactionary, attacking the former members of the Mountain and supporting rigorous measures against the rioters of the 12th Germinal and the 1st Prairial of the year III. In the council of Five Hundred, Bourdon belonged to the party of "Clichyens," composed of disguised royalists, against whom the directors made the *coup d'état* of the 18th Fructidor. Bourdon was arrested and deported to French Guiana, where he died soon after his arrival.

BOURG-EN-BRESSE, a town of eastern France, capital of the department of Ain, and formerly capital of the province of Bresse, 36 m. N.N.E. of Lyons by the Paris-Lyon railway. Pop. (1906) town, 13,916; commune, 20,045. Bourg is situated at the western base of the Jura, on the left bank of the Reysouze, a tributary of the Saône. The chief of the older buildings is the church of Notre-Dame (16th century), of which the façade belongs to the Renaissance; other parts of the church are Gothic. In the interior there are stalls of the 16th century. The other public buildings, including a handsome prefecture, are modern. The hôtel de ville contains a library and the Lorin museum with a collection of pictures, while another museum has a collection of the old costumes and ornaments characteristic of Bresse. Among the statues in the town there is one of Edgar Quinet (1803-1875), a native of Bourg. Bourg is the seat of a prefect and of a court of *assises*, and has a tribunal of first instance, a tribunal and a chamber of commerce, and a branch of the Bank of France. Its educational establishments include lycées for boys and girls, and training colleges. The manufactures consist of iron goods, mineral waters, tallow, soap and earthenware, and there are flour mills and breweries; and there is considerable trade in grain, cattle and poultry. The church of Brou, a suburb of Bourg, is of great artistic interest. Marguerite of Bourbon, wife of Philibert II. of Savoy, had intended to found a monastery on the spot; but died before her intention could be carried into effect. The church was actually built early in the 16th century by her daughter-in-law Marguerite of Austria, wife of Philibert le Beau of Savoy, in memory of her husband. The exterior, especially the façade, is richly ornamented, but the chief interest lies in the works of art in the interior, which date from 1532. The most important are the three mausoleums with the marble effigies of Marguerite of Bourbon, Philibert le Beau, and Marguerite of Austria. All three are remarkable for perfection of sculpture and richness of ornamentation. The roof, loft, the oak stalls, and the reredos in the chapel of the Virgin are masterpieces in a similar style.

Roman remains have been discovered at Bourg, but little is known of its early history. Raised to the rank of a free town in 1250, it was at the beginning of the 15th century chosen by the dukes of Savoy as the chief city of the province of Bresse. In 1535 it passed to France, but was restored to Duke Philibert Emmanuel, who later built a strong citadel, which afterwards withstood a six months' siege by the soldiers of Henry IV. The town was finally ceded to France in 1601. In 1814 the inhabitants, in spite of the defenceless condition of their town, offered resistance to the Austrians, who put the place to pillage.

BOURGEOIS, LÉON VICTOR AUGUSTE (1851-), French statesman, was born at Paris on the 21st of May 1851, and was educated for the law. After holding a subordinate office (1876) in the department of public works, he became successively prefect of the Tarn (1882) and the Haute-Garonne (1885), and then returned to Paris to enter the ministry of the interior. He became prefect of police in November 1887, at the critical

moment of President Grévy's resignation. In the following year he entered the chamber, being elected deputy for the Marne, in opposition to General Boulanger, and joined the radical left. He was under-secretary for home affairs in the Floquet ministry of 1888, and resigned with it in 1889, being then returned to the chamber for Reims. In the Tirard ministry, which succeeded, he was minister of the interior, and subsequently, on the 18th of March 1890, minister of public instruction in the cabinet of M. de Freycinet, a post for which he had qualified himself by the attention he had given to educational matters. In this capacity he was responsible in 1890 for some important reforms in secondary education. He retained his office in M. Loubet's cabinet in 1892, and was minister of justice under M. Ribot at the end of that year, when the Panama scandals were making the office one of peculiar difficulty. He energetically pressed the Panama prosecution, so much so that he was accused of having put wrongful pressure on the wife of one of the defendants in order to procure evidence. To meet the charge he resigned in March 1893, but again took office, and only retired with the rest of the Freycinet ministry. In November 1895 he himself formed a cabinet of a pronouncedly radical type, the main interest of which was attached to its fall, as the result of a constitutional crisis arising from the persistent refusal of the senate to vote supply. The Bourgeois ministry appeared to consider that popular opinion would enable them to override what they claimed to be an unconstitutional action on the part of the upper house; but the public was indifferent and the senate triumphed. The blow was undoubtedly damaging to M. Bourgeois's career as an *homme de gouvernement*. As minister of public instruction in the Brisson cabinet of 1898 he organized courses for adults in primary education. After this short ministry he represented his country with dignity and effect at the Hague peace congress, and in 1903 was nominated a member of the permanent court of arbitration. He held somewhat aloof from the political struggles of the Waldeck-Rousseau and Combes ministries, travelling considerably in foreign countries. In 1902 and 1903 he was elected president of the chamber. In 1905 he replaced the duc d'Audiffret-Pasquier as senator for the department of Marne, and in May 1906 became minister of foreign affairs in the Sarrien cabinet. He was responsible for the direction of French diplomacy in the conference at Algiers.

BOURGEOIS, a French word, properly meaning a freeman of a *bourg* or borough in France; later the term came to have the wider significance of the whole class lying between the *ouvriers* or workmen and the nobility, and is now used generally of the trading middle-class of any country. In printing, the word (pronounced *burjoice*) is used of a type coming in size between longprimer and brevier; the derivation is supposed to be from the name of a French printer, otherwise unknown.

BOURGES, a city of central France, chief town of the department of Cher, 144 m. S. of Paris on the Orléans railway between Vierzon and Nevers. Pop. (1906) town, 34,581; commune, 44,133. Bourges is built amidst flat and marshy country on an eminence limited on three sides by the waters of the Canal of Berry, the Yèvre, the Auron, and other smaller streams with which they unite at this point. The older part of the town with its narrow streets and old houses forms a centre, to the south and east of which lie important engineering suburbs. Flourishing nurseries and market-gardens are situated in the marshy ground to the north and north-east. Bourges preserves portions of the Roman ramparts of the 4th century, which are for the most part built into the houses of the old quarter. They measure considerably less in circumference than the fortifications of the 13th century, remains of which in the shape of ruined walls and towers are still to be seen. The summit of the rise on which the city is built is crowned by the cathedral of St Étienne, one of the most important in France. Begun at the end of the 12th century, it was not completed till the 16th century, to which period belong the northernmost of the two unfinished towers flanking the façade and two of its five elaborately sculptured portals. The interior, which has double aisles, the inner aisles of remarkable height, and no transepts, contains, among many other

works of art, magnificent stained glass of the 13th century. Beneath the choir there is a crypt of Romanesque construction, where traces of the Roman fosses are to be found; the two lateral portals are also survivals of a Romanesque church. The Jardin de l'Archevêché, a pleasant terrace-garden, adjoins the choir of the cathedral. Bourges has many fine old houses. The hôtel Lallemand and the hôtel Cujas (now occupied by the museum) are of the Renaissance period. The hôtel de Jacques Cœur, named after the treasurer of Charles VII. and now used as the law-court, is of still greater interest, though it has been doubted whether Jacques Cœur himself inhabited it. The mansion is in the Renaissance style, but two towers of the Roman fortifications were utilized in the construction of the south-western façade (see HOUSE, Plate II. figs. 7 and 8). Its wings surround a courtyard into which three staircase turrets project; one of these leads to a chapel, the ceiling of which is decorated by fine frescoes.

Bourges is the seat of an archbishopric, a court of appeal, a court of assizes and a prefect; and is the headquarters of the VIII. army corps. It has tribunals of first instance and of commerce, a board of trade-arbitrators, and a chamber of commerce, and a branch of the Bank of France. Its educational institutions include an ecclesiastical seminary, a lycée for boys, and a college for girls, training colleges, and a school of industrial art. The industrial activity of Bourges depends primarily on its gunpowder and ammunition factories, its cannon-foundry and gun-carriage works. These all belong to the government, and, together with huge magazines, a school of pyrotechnics, and an artillery school, lie in the east of the town. The suburb of Mazières has large iron and engineering works, and there are manufactories of anvils, edge-tools, biscuits, woollen goods, oil-cloth, boots and shoes, fertilizers, brick and tile works, breweries, distilleries, tanneries, saw-mills and dye-works. The town has a port on the canal of Berry, and does a considerable trade in grain, wine, vegetables, hemp and fruit.

Bourges occupies the site of the Gallic town of *Avoricum*, capital of the Bituriges, mentioned by Caesar as one of the most important of all Gaul. In 52 B.C., during the war with Vercingetorix, it was completely destroyed by the Roman conqueror, but under Augustus it rose again into importance, and was made the capital of Aquitania Prima. About A.D. 250 it became the seat of a bishop, the first occupant of the see being Ursinus. Captured by the Visigoths about 475, it continued in their possession till about 507. In the middle ages it was the capital of Berry. During the English occupation of France in the 15th century it became the residence of Charles VII., who thus acquired the popular title of "king of Bourges." In 1463 a university was founded in the city by Louis XI., which continued for centuries to be one of the most famous in France, especially in the department of jurisprudence. On many occasions Bourges was the seat of ecclesiastical councils—the most important being the council of 1438, in which the Pragmatic Sanction of the Gallican church was established, and that of 1528, in which the Lutheran doctrines were condemned.

BOURGET, PAUL CHARLES JOSEPH (1852–), French novelist and critic, was born at Amiens on the 2nd of September 1852. His father, a professor of mathematics, was afterwards appointed to a post in the college at Clermont-Ferrand. Here Bourget received his early education. He afterwards studied at the Lycée Louis-le-Grand and at the Ecole des Hautes Études. In 1872–1873 he produced a volume of verse, *Au bord de la mer*, which was followed by others, the last, *Les Aveux*, appearing in 1882. Meanwhile he was making a name in literary journalism, and in 1883 he published *Essais de psychologie contemporaine*, studies of eminent writers first printed in the *Nouvelle Revue*, and now brought together. In 1884 Bourget paid a long visit to England, and there wrote his first published story (*L'Irréparable*). *Cruelle Énigme* followed in 1885; and *André Cornelis* (1886) and *Mensonges* (1887) were received with much favour. *Le Disciple* (1889) showed the novelist in a graver attitude; while in 1891 *Sensations d'Italie*, notes of a tour in that country, revealed a fresh phase of his powers. In the same year appeared

the novel *Cœur de femme*, and *Nouveaux Pastels*, types of the characters of men, the sequel to a similar gallery of female types (*Pastels*, 1890). His later novels include *La Terre promise* (1892); *Cosmopolis* (1892), a psychological novel, with Rome as a background; *Une Idylle tragique* (1896); *La Duchesse bleue* (1897); *Le Fantôme* (1901); *Les Deux Sœurs* (1905); and some volumes of shorter stories—*Complications sentimentales* (1896), the powerful *Drames de famille* (1898), *Un Homme fort* (1900), *L'Étape* (1902), a study of the inability of a family raised too rapidly from the peasant class to adapt itself to new conditions. This powerful study of contemporary manners was followed by *Un Divorce* (1904), a defence of the Roman Catholic position that divorce is a violation of natural laws, any breach of which inevitably entails disaster. *Études et portraits*, first published in 1888, contains impressions of Bourget's stay in England and Ireland, especially reminiscences of the months which he spent at Oxford; and *Outre-Mer* (1895), a book in two volumes, is his critical journal of a visit to the United States in 1893. He was admitted to the Academy in 1894, and in 1895 was promoted to be an officer of the Legion of Honour, having received the decoration of the order ten years before.

As a writer of verse Bourget was merely trying his wings, and his poems, which were collected in two volumes (1885–1887), are chiefly interesting for the light which they throw upon his mature method and the later products of his art. It was in criticism that his genius first found its true bent. The habit of close scientific analysis which he derived from his father, the sense of style produced by a fine ear and moulded by a classical education, the innate appreciation of art in all its forms, the taste for seeing men and cities, the keen interest in the oldest not less than the newest civilizations, and the large tolerance not to be learned on the *boulevard*—all these combined to provide him with a most uncommon equipment for the critic's task. It is not surprising that the *Sensations d'Italie* (1891), and the various psychological studies, are in their different ways scarcely surpassed throughout the whole range of literature. Bourget's reputation as a novelist has long been assured. Deeply impressed by the singular art of Henry Beyle (Stendhal), he struck out on a new course at a moment when the realist school reigned without challenge in French fiction. His idealism, moreover, had a character of its own. It was constructed on a scientific basis, and aimed at an exactness, different from, yet comparable to, that of the writers who were depicting with an astonishing faithfulness the environment and the actions of a person or a society. With Bourget observation was mainly directed to the secret springs of human character. At first his purpose seemed to be purely artistic, but when *Le Disciple* appeared, in 1889, the preface to that remarkable story revealed in him an unsuspected fund of moral enthusiasm. Since then he has varied between his earlier and his later manner, but his work in general has been more seriously conceived. From first to last he has painted with a most delicate brush the intricate emotions of women, whether wronged, erring or actually vicious; and he has described not less happily the ideas, the passions and the failures of those young men of France to whom he makes special appeal.

Bourget has been charged with pessimism, and with undue delineation of one social class. The first charge can hardly be sustained. The lights in his books are usually low; there is a certain lack of gaiety, and the characters move in a world of disenchantment. But there is no despair in his own outlook upon human destiny as a whole. As regards the other indictment, the early stories sometimes dwell to excess on the mere framework of opulence; but the pathology of moral irresolution, of complicated affairs of the heart, of the ironies of friendship, in which the writer revels, can be more appropriately studied in a cultured and leisured society than amid the simpler surroundings of humbler men and women. The style of all Bourget's writings is singularly graceful. His knowledge of the literature of other lands gives it a greater flexibility and a finer allusiveness than most of his contemporaries can achieve. The precision by which it is not less distinguished, though responsible for a certain over-refinement, and for some dull pages of the novels, is an

almost unmix'd merit in the critical essays. As a critic, indeed, either of art or letters, Bourget leaves little to be desired. If he is not in the very first rank of novelists, if his books display more ease of finished craftsmanship than joy in spontaneous creation, it must be remembered that the supreme writers of fiction have rarely succeeded as he has in a different field.

See also C. Lecigne, *L'Évolution morale et religieuse de M. Paul Bourget* (1903); Sargeret, *Les Grands Coméris* (1906). His *Œuvres complètes* began to appear in a uniform edition in 1899.

BOURIGNON, ANTOINETTE (1616-1680), Flemish mystic, was born at Lille on the 13th of January 1616. From an early age she was under the influence of religion, which took in course of time a mystical turn. Undertaking the work of a reformer, she visited France, Holland, England and Scotland. Her religious enthusiasm, peculiarity of views and disregard of all sects raised both zealous persecutors and warm adherents. On her death at Franeker, Friesland, on the 30th of October 1680, she left a large number of followers, who, however, dwindled rapidly away; but in the early 18th century her influence revived in Scotland sufficiently to call forth several denunciations of her doctrines in the various Presbyterian general assemblies of 1701, 1709 and 1710. So far as appears from her writings and contemporary records, she was a visionary of the ordinary type, distinguished only by the audacity and persistency of her pretensions.

Her writings, containing an account of her life and of her visions and opinions, were collected by her disciple, Pierre Poiret (10 vols., Amsterdam, 1679-1686), who also published her life (2 vols., 1679). For a critical account see Hauck, *Realencyclopædie* (Leipzig, 1897), and *Étude sur Antoinette Bourignon*, by M. E. S. (Paris, 1876). Three of her works at least have been translated into English:—*An Abridgment of the Light of the World* (London, 1786); *A Treatise of Solid Virtue* (1699); *The Restoration of the Gospel Spirit* (1707).

BOURKE, a town of Cowper county, New South Wales, Australia, 503 m. by rail N.W. from Sydney. Pop. (1901) 2614. It is situated on the south bank, and at the head of the ordinary winter navigation, of the Darling river. Very rich copper ore exists in the district in great abundance. Bourke is the centre of a large sheep-farming area, and the annual agricultural show is one of the best in the colony. On the west side of the Darling, 3 m. distant, is the small town of North Bourke, and at Pera, 10 m. distant, is an important irrigation settlement.

BOURMONT, LOUIS AUGUSTE VICTOR, COMTE DE GHAISNE DE (1773-1846), marshal of France, entered the *Gardes Françaises* of the royal army shortly before the Revolution, emigrated in 1789, and served with Condé and the army of the *émigrés* in the campaigns of 1792 and 1793, subsequently serving as chief of staff to Scépeaux, the royalist leader, in the civil war in lower Anjou (1794-1796). Bourmont, excepted from the amnesty of April 1796, fled into Switzerland, but soon afterwards, having been made by Louis XVIII. a *maréchal de camp* and a knight of St Louis, he headed a fresh insurrection, which after some preliminary successes collapsed (1799-1800). He then made his submission to the First Consul, married, and lived in Paris; but his thinly veiled royalism caused his arrest a few months later, and he remained a prisoner for more than three years, finally escaping to Portugal in 1804. Three years later the French army under General Junot invaded Portugal, and Bourmont offered his services to Junot, who made him chief of staff of a division. He returned to France with Junot after the convention of Cintra, and was promptly re-arrested. He was soon released, however, on Junot's demand, and was commissioned as an officer in the imperial army. He served in Italy for a time, then went on the staff of the viceroy Eugène (Beauharnais), whom he accompanied in the Moscow campaign. He was taken prisoner in the retreat, but escaped after a time and rejoined the French army. His conspicuous courage at the battle of Lützen in 1813 led Napoleon to promote him general of brigade, and in 1814 his splendid defence of Nogent (February 13) earned him the rank of general of division. At the first Restoration Bourmont was naturally employed by the Bourbons, to whose service he had devoted his life, but he rejoined Napoleon on his return from Elba. On the eve of the campaign of 1815, and at the urgent

request of Count Gérard, he was given a divisional command in the army of the north. On the first day of the Waterloo campaign Bourmont went over to the enemy. It is not probable that he gave information of French movements to the allies, but the best that can be said in exculpation of his treachery is that his old friends and comrades, the royalists of Anjou, were again in insurrection, and that he felt that he must lead them. He made no attempt to defend his conduct, and acted as the accuser of Marshal Ney. A year later he was given command of a division of the royal guard; and in 1823 he held an important position in the army which, under the command of the duc d'Angoulême, invaded Spain. He commanded the whole army in Spain for a time in 1824, became minister of war in 1829, and in 1830 was placed in command of the Algiers expedition. The landing of the French and the capture of Algiers were directed by him with complete success, and he was rewarded with the *baton* of marshal. But the revolution of 1830 put an end to his command, and, refusing to take the oath to Louis Philippe, he was forced to resign. In 1832 Marshal Bourmont took part in the rising of the duchesse de Berri, and on its failure retired to Portugal. Here, as always, on the side of absolutism, he commanded the army of Dom Miguel during the civil war of 1833-1834, and after the victory of the constitutional party he retired to Rome. At the amnesty of 1840 he returned to France. He died at the château of Bourmont on the 27th of October 1846.

Charles de Bourmont, a son of the marshal, wrote several pamphlets in vindication of his father's career.

BOURNE, VINCENT (1695-1747), English classical scholar, familiarly known as "Vinny" Bourne, was born at Westminster in 1695. In 1710 he became a scholar at Westminster school, and in 1714 entered Trinity College, Cambridge. He graduated in 1717, and obtained a fellowship three years later. Of his after-life exceedingly little is known. It is certain that he passed the greater portion of it as usher in Westminster school. He died on the 2nd of December 1747. During his lifetime he published three editions of his Latin poems, and in 1772 there appeared a very handsome quarto volume containing all Bourne's pieces, but also some that did not belong to him. The Latin poems are remarkable not only for perfect mastery of all linguistic niceties, but for graceful expression and genuine poetic feeling. A number of them are translations of English poems, and it is not too much to say that the Latin versions almost invariably surpass the originals. Cowper, an old pupil of Bourne's, Beattie and Lamb have combined in praise of his wonderful power of Latin versification.

See an edition (1840) of his *Poemata*, with a memoir by John Milford.

BOURNE, or **BOURN**, a market town in the S. Kesteven or Stamford parliamentary division of Lincolnshire, England; lying in a fenny district 95 m. N. by W. from London. Pop. of urban district (1901) 4361. The Stamford-Sleaford branch of the Great Northern railway here crosses the Saxby-Lynn joint line of the Great Northern and Midland companies. The church of St Peter and St Paul is Norman and Early English with later insertions; it is part of a monastic church belonging to a foundation of Augustinian canons of 1138, of which the other buildings have almost wholly disappeared. Trade is principally agricultural. Bourne is famous through its connexion with the ardent opponent of William the Conqueror, Hereward the Wake. Of his castle very slight traces remain. Bourne was also the birthplace of the Elizabethan statesman Cecil, Lord Burghley. The Red Hall, which now forms part of the railway station buildings, belonged to the family of Digby, of whom Sir Everard Digby was executed in 1606 for his connexion with the Gunpowder Plot.

BOURNE (southern form of burn, Teutonic *born*, *brunn*, *burne*), an intermittent stream frequent in chalk and limestone country where the rock becomes saturated with winter rain, that slowly drains away until the rock becomes dry, when the stream ceases. A heavy rainfall will cause streams to run in winter from the saturated soil. These are the winter bournes that have given name to several settlements upon Salisbury Plain, such as

Winterbourne Gunning. The "bourne" may also be a permanent "burn," but the word is usually applied to an intermittent stream. (2) (From the Fr. *borne*), a boundary; the first use of the word in English is in Lord Ferrers' translation of Forrest, 1553; the figurative meaning of limit, end or final destination comes from Shakespeare's *Hamlet*, "the undiscovered country, from whose bourne no traveller returns."

BOURNEMOUTH, a municipal and county borough and watering-place of Hampshire, England, in the parliamentary borough of Christchurch, 10½ m. S.W. by W. from London by the London & South-Western railway. Pop. (1901) 59,762. It is beautifully situated on Poole Bay. Considerable sandstone cliffs rise from the sandy beach, and are scored with deep picturesque dells or chines. The town itself lies in and about the valley of the Bourne stream. Its sheltered situation and desirable winter climate began to attract notice about 1840; in 1855 a national sanatorium for consumptive patients was erected by subscription; a pier was opened in 1861, and in 1870 railway communication was afforded. The climate is remarkably equable, being relatively warm in winter and cool in summer; the average temperature in July is 61.7° F., and in January 40.3°. The town contains numerous handsome buildings, including municipal buildings, churches, various places of entertainment, sanatoria and hospitals, a public library and a science and art school. Its suburbs have greatly extended along the sea front, and the beautiful chines of Boscombe, Alum and Branksome have attracted a large number of wealthy residents. There are piers at the town itself and at Boscombe, and the bathing is excellent. The parks, gardens and drives are extensive and pleasant. A service of electric tramways is maintained, notable as being the first system installed in England with a combination of the trolley and conduit principles of supplying current. There are golf links in Meyrick and Queen's parks, both laid out by the corporation, which has in other ways studied the entertainment of visitors. The two railway stations are the Central and West, and through communications with the north are maintained by the Somerset & Dorset and Midland, and the Great Western and Great Central railways. The town, which is of wholly modern and remarkably rapid growth (for in the middle of the 19th century the population was less than 1000), was incorporated in 1890, and became a county borough in 1900. The corporation consists of a mayor, 11 aldermen and 33 councillors. Area, 5760 acres.

BOURNONITE, a mineral species, a sulphantimonite of lead and copper with the formula $PbCuSb_2S_6$. It is of some interest on account of the twinning and the beautiful development of its crystals. It was first mentioned by Philip Rashleigh in 1797 as "an ore of antimony," and was more completely described by the comte de Bourmon in 1804, after whom it was named: the name given by Bourmon himself (in 1813) was *endellione*, since used in the form *endellionite*, after the locality in Cornwall where the mineral was first found. The crystals are orthorhombic, and are generally tabular in habit owing to the predominance of the basal pinacoid (*c*); numerous smooth bright faces are often developed on the edges and corners of the crystals. An untwinned crystal is represented in fig. 1. Usually, however, the

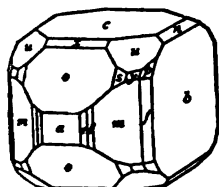

FIG. 1.—Crystal of Bournonite.



FIG. 2.—Twinning Crystal of Bournonite.

crystals are twinned, the twin-plane being a face of the prism (*m*); the angle between the faces of this prism being nearly a right angle ($86^\circ 20'$), the twinning gives rise to cruciform groups (fig. 2),

and when it is often repeated the group has the appearance of a cog-wheel, hence the name *Raddlers* (wheel-ore) of the Kapnik miners. The repeated twinning gives rise to twin-lamellae, which may be detected on the fractured surfaces, even of the massive material. The mineral is opaque, and has a brilliant metallic lustre with a lead-grey colour. The hardness is 2½, and the specific gravity 5.8.

At the original locality, Wheal Boys in the parish of Endellion in Cornwall, it was found associated with Jamesonite, blende and chalybite. Later, still better crystals were found in another Cornish mine, namely, Herodsfoot mine near Liskard, which was worked for argentiferous galena. Fine crystals of large size have been found with quartz and chalybite in the mines at Neudorf in the Harz, and with blende and tetrahedrite at Kapnik-Bánya near Nagy-Bánya in Hungary. A few other localities are known for this mineral. (L. J. S.)

BOURRIÈRE, a French name for a dance common in Auvergne and in Biscay in Spain; also a term for a musical composition or a dance-movement in a suite, somewhat akin to the gavotte, in quick time with two beats to the bar.

BOURRIENNE, LOUIS ANTOINE FAUVELET DE (1769–1834), French diplomatist, was born at Sens on the 9th of July 1769. He was educated at the military school of Brienne in Champagne along with Napoleon Bonaparte; and although the solitary habits of the latter made intimacy difficult, the two youths seem to have been on friendly terms. It must, however, be added that the stories of their very close friendship, as told in Bourrienne's memoirs, are open to suspicion. Leaving Brienne in 1787, and conceiving a distaste for the army, Bourrienne proceeded to Vienna. He was pursuing legal and diplomatic studies there and afterwards at Leipzig, when the French Revolution broke out and went through its first phases. Not until the spring of 1792 did Bourrienne return to France; at Paris he renewed his acquaintance with Bonaparte. They led a Bohemian life together, and among other incidents of that exciting time, they witnessed the mobbing of the royal family in the Tuileries (June 20) and the overthrow of the Swiss Guards at the same spot (August 10). Bourrienne next obtained a diplomatic appointment at Stuttgart, and soon his name was placed on the list of political *émigrés*, from which it was not removed until November 1797. Nevertheless, after the affair of 13th Vendémiaire (October 5, 1795) he returned to Paris and renewed his acquaintance with Bonaparte, who was then second in command of the Army of the Interior and soon received the command of the Army of Italy. Bourrienne did not proceed with him into Italy, but was called thither by the victorious general at the time of the long negotiations with Austria (May–October 1797), when his knowledge of law and diplomacy was of some service in the drafting of the terms of the treaty of Campo Formio (October 17). In the following year he accompanied Bonaparte to Egypt as his private secretary, and left a vivid, if not very trustworthy, account of the expedition in his memoirs. He also accompanied him on the adventurous return voyage to Fréjus (September–October 1799), and was of some help in the affairs which led up to the *coup d'état* of Brumaire (November) 1799. He remained by the side of the First Consul in his former capacity, but in the autumn of 1802 incurred his displeasure owing to his very questionable financial dealings. In the spring of 1805 he was sent as French envoy to the free city of Hamburg. There it was his duty to carry out the measures of commercial war against England, known as the Continental System; but it is known that he not only viewed those tyrannical measures with disgust, but secretly relaxed them in favour of those merchants who plied him with *douceurs*. In the early spring of 1807, when directed by Napoleon to order a large number of military cloaks for the army, then in East Prussia, he found that the only means of procuring them expeditiously was to order them from England. After gaining a large fortune while at Hamburg, he was recalled to France in disgrace at the close of 1810. In 1814 he embraced the royal cause, and during the Hundred Days (1815) accompanied Louis XVIII. to Ghent. The rest of his life was uneventful; he died at Caen on

the 7th of February 1834, after suffering from a mental malady for two years.

The fame of Bourrienne rests, not upon his achievements or his original works, which are insignificant, but upon his *Mémoires*, edited by C. M. de Villemarest (10 vols., Paris, 1829-1837), which have been frequently republished and translated. The best English edition is that edited by Colonel R. W. Phillips (4 vols., London, 1893); a new French edition has been edited by D. Lacroix (5 vols., Paris, 1899-1900). See *Bourrienne et ses erreurs, volontaires et involontaires* (Paris, 1830), by Generals Belliard, Gourgaud, &c., for a discussion of the genuineness of his *Mémoires*; also *Napoléon et ses détachés*, by Prince Napoleon (Paris, 1887; Eng. trans., London, 1888). (J. H. R.)

BOURRIT, MARC THÉODORE (1730-1816), Swiss traveller and writer, came of a family which was of French origin but had taken refuge at Geneva for reasons connected with religion. His father was a watchmaker there, and he himself was educated in his native city. He was a good artist and etcher, and also a pastor, so that by reason of his fine voice and love of music he was made (1768) rector of the church of St Peter (the former cathedral) at Geneva. This post enabled him to devote himself to the exploration of the Alps, for which he had conceived a great passion ever since an ascent (1761) of the Voirons, near Geneva. In 1775 he made the first ascent of the Buet (20,201 ft.) by the now usual route from the Pierre à Bérard, on which the great flat rock known as the *Table au Chamois* still preserves his memory. In 1784-1785 he was the first traveller to attempt the ascent of Mont Blanc (not conquered till 1786), but neither then nor later (1788) did he succeed in reaching its summit. On the other hand he reopened (1787) the route over the Col du Géant (11,060 ft.), which had fallen into oblivion, and travelled also among the mountains of the Valais, of the Bernese Oberland, &c. He received a pension from Louis XVI., and was named the *historiographe des Alpes* by the emperor Joseph II., who visited him at Geneva. His last visit to Chamonix was in 1812. His writings are composed in a naive, sentimental and rather pompous style, but breathe throughout a most passionate love for the Alps, as wonders of nature, and not as objects of scientific study. His chief works are the *Description des glaciers de Savoie*, 1773 (English translation, Norwich, 1775-1776), the *Description des Alpes pennines et rhétiennes* (2 vols., 1781) (reprinted in 1783 under the title of *Nouvelle Description des vallées de glace*, and in 1785, with additions, in 3 vols., under the name of *Nouvelle Description des glaciers*), and the *Descriptions des cols ou passages des Alpes*, (2 vols., 1803), while his *Itinéraire de Genève, Lausanne et Chamonix*, first published in 1791, went through several editions in his lifetime. (W. A. B. C.)

BOURSALT, EDMÉ (1638-1701), French dramatist and miscellaneous writer, was born at Mussy l'Évêque, now Mussy-sur-Seine (Aube), in October 1638. On his first arrival in Paris in 1651 his language was limited to a Burgundian patois, but within a year he produced his first comedy, *Le Mort vivant*. This and some other pieces of small merit secured for him distinguished patronage in the society ridiculed by Molière in the *École des femmes*. Boursault was persuaded that the "Lysidas" of that play was a caricature of himself, and attacked Molière in *Le Portrait du peintre ou la contre-critique de l'École des femmes* (1663). Molière retaliated in *L'Impromptu de Versailles*, and Boileau attacked Boursault in *Satires 7* and *9*. Boursault replied to Boileau in his *Satire des satires* (1669), but was afterwards reconciled with him, when Boileau on his side erased his name from his satires. Boursault obtained a considerable pension as editor of a rhyming gazette, which was, however, suppressed for ridiculing a Capuchin friar, and the editor was only saved from the Bastille by the interposition of Condé. In 1671 he produced a work of edification in *Ad usum Delphini: la véritable étude des souverains*, which so pleased the court that its author was about to be made assistant tutor to the dauphin when it was found that he was ignorant of Greek and Latin, and the post was given to Pierre Huet. Perhaps in compensation Boursault was made collector of taxes at Montluçon about 1672, an appointment that he retained until 1688. Among his best-known plays are *Le Mercure galant*, the title of which was changed to *La Comédie sans titre* (1683); *La Prin-*

cesse de Clèves (1676), an unsuccessful play which, when refurbished with fresh names by its author, succeeded as *Germanicus*; *Ésopé à la ville* (1690); and *Ésopé à la cour* (1701). His lack of dramatic instinct could hardly be better indicated than by the scheme of his *Ésopé*, which allows the fabulist to come on the stage in each scene and recite a fable. Boursault died in Paris on the 15th of September 1701.

The *Œuvres choisies* of Boursault were published in 1811, and a sketch of him is to be found in M. Saint-René Taillandier's *Études littéraires* (1881).

BOURSE (from the Med. Lat. *bursa*, a purse), the French equivalent of the Stock Exchange, and so used of the Paris Exchange, or of any foreign money-market. The English form "bursa," as in Sir Thomas Gresham's building, which was known as "Britain's Bourse," went out of use in the 18th century. The origin of the name is doubtful; it is not derived from any connexion between purse and money, but rather from the use of a purse as a sign. At Bruges a house belonging to the family de Bursa is said to have been first used as an Exchange, and to have had three purses as a sign on the front.

BOURSSE, ESAIAS (1630-1673), Dutch painter, was born in Amsterdam. He was a follower of Pieter de Hooch, in whose manner he worked for many years in his native town; then he took service with the Dutch East India Company, and died on a sea voyage. His paintings are exceedingly rare, perhaps because, in spite of their greater freedom and breadth, many of them pass under the names of Vermeer of Delft and Pieter de Hooch. Two of the paintings ascribed to the latter (one bears the false signature) at the Ryks museum in Amsterdam, are now recognized as being the work of Boursse. His subjects are interiors with figures, painted with great precision and with exquisite quality of colour. The Wallace collection has his masterpiece, an interior with a woman and a child in a cradle, almost as brilliant as on the day it was painted, and reflecting something of the feeling of Rembrandt, by whom he was influenced. Other important examples are at the Ryks museum and at Aix-la-Chapelle. Boursse's "Boy blowing Soap Bubbles," in the Berlin museum, was until lately attributed to Vermeer of Delft. More than one picture bearing the false signature of Boursse has been publicly shown of late years.

BOUSSINGAULT, JEAN BAPTISTE JOSEPH DIEUDONNÉ (1802-1887), French chemist, was born in Paris on the 2nd of February 1802. After studying at the school of mines at Saint-Étienne he went, when little more than twenty years old, to South America as a mining engineer on behalf of an English company. During the insurrection of the Spanish colonies he was attached to the staff of General Bolívar, and travelled widely in the northern parts of the continent. Returning to France he became professor of chemistry at Lyons, and in 1839 was appointed to the chair of agricultural and analytical chemistry at the Conservatoire des Arts et Métiers in Paris. In 1848 he was elected to the National Assembly, where he sat as a Moderate republican. Three years later he was dismissed from his professorship on account of his political opinions, but so much resentment at this action was shown by scientific men in general, and especially by his colleagues, who threatened to resign in a body, that he was reinstated. He died in Paris on the 11th of May 1887. His first papers were concerned with mining topics, and his sojourn in South America yielded a number of miscellaneous memoirs, on the cause of goitre in the Cordilleras, the gases of volcanoes, earthquakes, tropical rain, &c., which won the commendation of A. von Humboldt. From 1836 he devoted himself mainly to agricultural chemistry and animal and vegetable physiology, with occasional excursions into mineral chemistry. His work included papers on the quantity of nitrogen in different foods, the amount of gluten in different wheats, investigations on the question whether plants can assimilate free nitrogen from the atmosphere (which he answered in the negative), the respiration of plants, the function of their leaves, the action and value of manures, and other similar subjects. Through his wife he had a share in an estate at Bechebroann in Alsace, where he carried out many agricultural experiments. He

collaborated with J. B. A. Dumas in writing an *Essai de statique chimique des êtres organisés* (1841), and was the author of *Traité d'économie rurale* (1844), which was remodelled as *Agronomie, chimie agricole, et physiologie* (5 vols., 1860-1874; 2nd ed., 1884), and of *Études sur la transformation du fer en acier* (1875).

BOUTERWEK, FRIEDRICH (1766-1828), German philosopher and critic, was born at Oker, near Goslar in Lower Saxony, and studied law at Göttingen. From 1790, however, he became a disciple of Kant, published *Aphorismen nach Kants Lehre von der Vernunft* (1793), and became professor of philosophy at Göttingen (1802), where he died on the 9th of August 1828. As a philosopher, he is interesting for his criticism of the theory of the "thing-in-itself" (*Ding-an-sich*). For the pure reason, as described in the *Kritik*, the "thing-in-itself" can be only an inconceivable "something-in-general"; any statement about it involves the predication of Reality, Unity and Plurality, which belong not to the absolute thing but to phenomena. On the other hand, the subject is known by the fact of will, and the object by that of resistance; the cognizance of willing is the assertion of absolute reality in the domain of relative knowledge. This doctrine has since been described as absolute Virtualism. Following this train of thought, Bouterwek left the Kantian position through his opposition to its formalism. In later life he inclined to the views of F. H. Jacobi, whose letters to him (published at Göttingen, 1868) shed much light on the development of his thought. His chief philosophical works are *Ideen zu einer allgemeinen Aesthetik* (Göttingen and Halle, 1799); *Aesthetik* (Leipzig, 1806; Göttingen, 1815 and 1824); *Lehrbuch der philos. Vorkenntnisse* (Göttingen, 1810 and 1820); *Lehrbuch der philos. Wissenschaften* (Göttingen, 1813 and 1820). In these works he dissociated himself from the Kantian school. His chief critical work was the *Geschichte der neuern Poesie und Beredsamkeit* (Göttingen, 12 vols., 1801-1819), of which the history of Spanish literature has been published separately in French, Spanish and English. The *Geschichte* is a work of wide learning and generally sound criticism, but it is not of equal merit throughout. He also wrote three novels, *Paulus Septimus* (Halle, 1795), *Graf Donamar* (Göttingen, 1791) and *Esmero* (Leipzig, 1804), and published a collection of poems (Göttingen, 1802).

BOUTHILLIER, CLAUDE, SIEUR DE FOUILLETOUTTE (1581-1652), French statesman, began life as an advocate. In 1613 he was councillor in the parlement of Paris, and in 1619 became councillor of state and a secretary to the queen-mother, Marie de' Medici. The connexion of his father, Denis Bouthillier (d. 1622), with Cardinal Richelieu secured for him the title of secretary of state in 1628, and he was able to remain on good terms with both Marie de' Medici and Richelieu, in spite of their rivalry. In 1632 he became superintendent of finances. But his great rôle was in diplomacy. Richelieu employed him on many diplomatic missions, and the success of his foreign policy was due in no small degree to Bouthillier's ability and devotion. In 1630 he had taken part at Regensburg in arranging the abortive treaty between the emperor and France. From 1633 to 1640 he was continually busied with secret missions in Germany, sometimes alone, sometimes with Father Joseph. Following Richelieu's instructions, he negotiated the alliances which brought France into the Thirty Years' War. Meanwhile, at home, his tact and amiable disposition, as well as his reputation for straightforwardness, had secured for him a unique position of influence in a court torn by jealousies and intrigues. Trusted by the king, the confidant of Richelieu, the friend of Marie de' Medici, and through his son, Léon Bouthillier, who was appointed in 1635 chancellor to Gaston d'Orléans, able to bring his influence to bear on that prince, he was an invaluable mediator; and the personal influence thus exercised, combined with the fact that he was at the head of both the finances and the foreign policy of France, made him, next to the cardinal, the most powerful man in the kingdom. Richelieu made him executor of his will, and Louis XIII. named him a member of the council of regency which he intended should govern the kingdom after his death.

But the king's last plans were not carried out, and Bouthillier was obliged to retire into private life, giving up his office of superintendent of finances in June 1643. He died in Paris on the 13th of March 1652.

His son, LÉON BOUTHILLIER (1608-1652), comte de Chavigny, was early associated with his father, who took him with him from 1620 to 1632 to all the great courts of Europe, instructing him in diplomacy. In 1632 he was named secretary of state and seconded his father's work, so that it is not easy always to distinguish their respective parts. After the death of Louis XIII. he had to give up his office; but was sent as plenipotentiary to the negotiations at Münster. He showed himself incapable, however, giving himself up to pleasure and fêtes, and returned to France to intrigue against Mazarin. Arrested twice during the Fronde, and then for a short time in power during Mazarin's exile (April 1651), he busied himself with small intrigues which came to nothing.

BOUTS-RIMÉS, literally (from the French) "rhymed ends," the name given in all literatures to a kind of verses of which no better definition can be found than was made by Addison, in the *Spectator*, when he described them as "lists of words that rhyme to one another, drawn up by another hand, and given to a poet, who was to make a poem to the rhymes in the same order that they were placed upon the list." The more odd and perplexing the rhymes are, the more ingenuity is required to give a semblance of common-sense to the production. For instance, the rhymes *breeze, elephant, squeeze, pant, scant, please, hope, pope* are submitted, and the following stanza is the result:—

Escaping from the Indian breeze,
The vast, sententious elephant
Through groves of sandal loves to squeeze
And in their fragrant shade to pant;
Although the shelter there be scant,
The vivid odours soothe and please,
And while he yields to dreams of hope,
Adoring beasts surround their Pope.

The invention of bouts-rimés is attributed to a minor French poet of the 17th century, Dulot, of whom little else is remembered. According to the *Menagiana*, about the year 1648, Dulot was complaining one day that he had been robbed of a number of valuable papers, and, in particular, of three hundred sonnets. Surprise being expressed at his having written so many, Dulot explained that they were all "blank sonnets," that is to say, that he had put down the rhymes and nothing else. The idea struck every one as amusing, and what Dulot had done seriously was taken up as a jest. Bouts-rimés became the fashion, and in 1654 no less a person than Sarrasin composed a satire against them, entitled *La Défaite des bouts-rimés*, which enjoyed a great success. Nevertheless, they continued to be abundantly composed in France throughout the 17th century and a great part of the 18th century. In 1701 Etienne Mallemaus (d. 1716) published a collection of serious sonnets, all written to rhymes selected for him by the duchess of Maine. Neither Piron, nor Marmontel, nor La Motte disdained this ingenious exercise, and early in the 19th century the fashion was revived. The most curious incident, however, in the history of bouts-rimés is the fact that the elder Alexandre Dumas, in 1864, took them under his protection. He issued an invitation to all the poets of France to display their skill by composing to sets of rhymes selected for the purpose by the poet, Joseph Méry (1798-1866). No fewer than 350 writers responded to the appeal, and Dumas published the result, as a volume, in 1865.

W. M. Rossetti, in the memoir of his brother prefixed to D. G. Rossetti's *Collected Works* (1886), mentions that, especially in 1848 and 1849, he and Dante Gabriel Rossetti constantly practised their pens in writing sonnets to bouts-rimés, each giving the other the rhymes for a sonnet, and Dante Gabriel writing off these exercises in verse-making at the rate of a sonnet in five or eight minutes. Most of W. M. Rossetti's poems in *The Germ* were bouts-rimés experiments. Many of Dante Gabriel's, a little touched up, remained in his brother's possession, but were not included in the *Collected Works*. (E. G.)

BOUTWELL, GEORGE SEWALL (1818-1905), American statesman, was born in Brookline, Massachusetts, on the 28th of January 1818. He was reared on a farm, and at an early age began a mercantile career at Groton, Mass. There he studied law and in 1836 was admitted to the bar, but did not begin practice for many years. In 1842-1844 and again in 1847-1850 he served in the state house of representatives, and became the recognized leader on the Democratic side; he was thrice defeated for Congress, and was twice an unsuccessful candidate for governor. In 1851, however, by means of "Free-Soil" votes, he was chosen governor, and was re-elected by the same coalition in 1852. In the following year he took an active part in the state constitutional convention. He became a member of the Massachusetts Board of Education in 1853, and as its secretary in 1855-1861 prepared valuable reports and rendered much service to the state's school system. The passage of the Kansas-Nebraska Bill in 1854 had finally alienated him from the Democratic party, and he became one of the founders of the new Republican party in the state. He played an influential part in the Republican national convention in 1860, and in 1862 after the passage of the war tax measures he was appointed by President Lincoln the first commissioner of internal revenue, which department he organized. From 1863 to 1869 he was a representative in Congress, taking an influential part in debate, and acting as one of the managers of President Johnson's impeachment. From 1869 to 1873 he was secretary of the treasury in President Grant's cabinet, and from 1873 until 1877 was a United States senator from Massachusetts. Under an appointment by President Hayes, he prepared the second edition of the *United States Revised Statutes* (1878). In 1880 he represented the United States before the commission appointed in accordance with the treaty of that year, between France and the United States, to decide the claims brought by French citizens against the United States for acts of the American authorities during the Civil War, and the claims of American citizens against France for acts of French authorities during the war between France and Mexico, the Franco-German War and the Commune. He opposed the acquisition by the United States of the Philippine Islands, became president of the Anti-Imperialistic League, and was a presidential elector on the Bryan (Democratic) ticket in 1900. He died at Groton, Massachusetts, on the 28th of February 1905. He published various volumes, including *The Constitution of the United States at the End of the First Century* (1895), and *Reminiscences of Sixty Years in Public Affairs* (2 vols., New York, 1902).

BOUVARDIA, a genus of handsome evergreen greenhouse shrubs, belonging to the natural order Rubiaceae, and a native of tropical America. The flowers are in terminal generally many-flowered clusters; the corolla has a large tube and a spreading four-rayed limb. The cultivated forms include a number of hybrids. The plants are best increased by cuttings taken off in April, and placed in a brisk heat in a propagating frame with a close atmosphere. When rooted they should be potted singly into 3-in. pots in fibrous peat and loam, mixed with one-fourth leaf-mould and a good sprinkling of sand, and kept in a temperature of 70° by night and 80° during the day; shade when required; syringe overhead in the afternoon and close the house with sun-heat. The plants should be topped to ensure a bushy habit, and as they grow must be shifted into 6-in. or 7-in. pots. After midsummer move to a cool pit, where they may remain till the middle of September, receiving plenty of air and space. They should then be removed to a house, and some of the plants put at once in a temperature of about 70° at night, with a few degrees higher in the daytime, to bring them into flower. Others are moved into heat to supply flowers in succession through the winter and spring.

BOUVET, FRANÇOIS JOSEPH (1753-1832), French admiral, son of a captain in the service of the French East India Company, was born on the 23rd of April 1753. He went to sea at the age of twelve with his father. Bouvet served in the East Indies in the famous campaign of 1781-83 under the command of Suffren, but only in a subordinate rank. On the outbreak of the French

Revolution he very naturally took the anti-royalist side. Murder and exile had removed the great majority of the officers of the monarchy, and the services of a man of Bouvet's experience were valuable. He was promoted captain and received the command of the "Audacieux" (80) in the first great fleet collected by the republic. In the same year (1793) he was advanced to rear-admiral, and he commanded a division in the fleet which fought the battle of the 1st of June 1794 against Lord Howe. Until the close of 1796 he continued in command of a squadron in the French Channel fleet. In the December of that year he was entrusted with the van division of the fleet which was sent from Brest to attempt to land General Hoche with an expeditionary force in the south of Ireland. The stormy weather which scattered the French as soon as they left Brest gave Bouvet a prominence which he had not been designed to enjoy. Bouvet, who found himself at daybreak on the 17th of December separated with nine sail of the line from the rest of the fleet, opened his secret orders, and found that he was to make his way to Mizen Head. He took a wide course to avoid meeting British cruisers, and on the 19th had the good luck to fall in with a considerable part of the rest of the fleet and some of the transports. On the 21st of December he arrived off Dursey Island at the entry to Bantry Bay. On the 24th he anchored near Bear Island with part of his fleet. The continued storms which blew down Bantry Bay, and the awkwardness of the French crews, made it impossible to land the troops he had with him. On the evening of the 25th the storm increased to such a pitch of violence that the frigate in which Bouvet had hoisted his flag was blown out to sea. The wind moderated by the 29th, but Bouvet, being convinced that none of the ships of his squadron could have remained at the anchorage, steered for Brest, where he arrived on the 1st of January 1797. His fortune had been very much that of his colleagues in this storm-tossed expedition, and on the whole he had shown more energy than most of them. He was wrong, however, in thinking that all his squadron had failed to keep their anchorage in Bantry Bay. The government, displeased by his precipitate return to Brest, dismissed him from command soon afterwards. He was compelled to open a school to support himself. Napoleon restored him to the service, and he commanded the squadron sent to occupy Guadaloupe during the peace of Amiens, but he had no further service, and lived in obscurity till his death on the 21st of July 1832.

Tronde, *Batailles navales de la France*, vols. ii. and iii., and James, *Naval History*, vols. i. and ii., give accounts of the 1st of June and the expedition to Ireland. There is a vigorous account of the expedition in Tronde's *English in Ireland*, and it is dealt with in Admiral Colomb's *Naval Warfare*. (D. H.)

BOUVIER, JOHN (1787-1851), American jurist, was born in Codogno, France, in 1787. In 1802 his family, who were Quakers (his mother was a member of the well-known Benet family), emigrated to America and settled in Philadelphia, and after varied experiences as proprietor of a book shop and as a country editor he was admitted to the bar in 1818, having become a citizen of the United States in 1812. He attained high standing in his profession, was recorder of Philadelphia in 1836, and from 1838 until his death was an associate justice of the court of criminal sessions in that city. He is best known for his able legal writings. His *Law Dictionary Adapted to the Constitution and Laws of the United States of America and of the Several States of the American Union* (1839, revised and brought up to date by Francis Rawle, under the title of *Bowser's Law Dictionary*, 2 vols., 1897) has always been a standard. He published also an edition of *Bacon's Abridgment of the Law* (10 vols., 1842-1846), and a compendium of American law entitled *The Institutes of American Law* (4 vols., 1851; new ed. 2 vols., 1876).

BOUVINES, a village on the French-Belgian frontier between Lille and Tournay, the scene of one of the greatest battles of the middle ages, fought on the 27th of July 1214, between the forces of Philip Augustus, king of France, and those of the coalition formed against him, of which the principal members were the emperor and King John of England. The plan of campaign seems to have been designed by King John, who was the soul of the alliance; his general idea was to draw the French king to

the southward against himself, while the emperor Otto IV., the princes of the Netherlands and the main army of the allies should at the right moment march upon Paris from the north. John's part in the general strategy was perfectly executed; the allies in the north moved slowly. While John, after two inroads, turned back to his Guienne possessions on the 3rd of July, it was not until three weeks later that the emperor concentrated his forces at Valenciennes, and in the interval Philip Augustus had counter-marched northward and concentrated an army at Péronne. Philip now took the offensive himself, and in manoeuvring to get a good cavalry ground upon which to fight he offered battle (July 27), on the plain east of Bouvines and the river Marquie—the same plain on which in 1794 the brilliant cavalry action of Willem was fought. The imperial army accepted the challenge and drew up facing south-westward towards Bouvines, the heavy cavalry on the wings, the infantry in one great mass in the centre, supported by the cavalry corps under the emperor himself. The total force is estimated at 6500 heavy cavalry and 40,000 foot. The French army (about 7000 heavy cavalry and 30,000 infantry) took ground exactly opposite to the enemy and in a similar formation, cavalry on the wings, infantry, including the *milice des communes*, in the centre, Philip with the cavalry reserve and the Oriflamme in rear of the foot. The battle opened with a confused cavalry fight on the French right, in which individual feats of knightly gallantry were more noticeable than any attempt at combined action. The fighting was more serious between the two centres; the infantry of the Low Countries, who were at this time almost the best in existence, drove in the French; Philip led the cavalry reserve of nobles and knights to retrieve the day, and after a long and doubtful fight, in which he himself was unhorsed and narrowly escaped death, began to drive back the Flemings. In the meanwhile the French feudatories on the left wing had thoroughly defeated the imperialists opposed to them, and William Longsword, earl of Salisbury, the leader of this corps, was unhorsed and taken prisoner by the warlike bishop of Beauvais. Victory declared itself also on the other wing, where the French at last routed the Flemish cavalry and captured Count Ferdinand of Flanders, one of the leaders of the coalition. In the centre the battle was now between the two mounted reserves led respectively by the king and the emperor in person. Here too the imperial forces suffered defeat, Otto himself being saved only by the devotion of a handful of Saxon knights. The day was already decided in favour of the French when their wings began to close inwards to cut off the retreat of the imperial centre. The battle closed with the celebrated stand of Reginald of Boulogne, a revolted vassal of King Philip, who formed a ring of seven hundred Brabant pikemen, and not only defied every attack of the French cavalry, but himself made repeated charges or sorties with his small force of knights. Eventually, and long after the imperial army had begun its retreat, the gallant schiltron was ridden down and annihilated by a charge of three thousand men-at-arms. Reginald was taken prisoner in the *mêlée*; and the prisoners also included two other counts, Ferdinand and William Longsword, twenty-five barons and over a hundred knights. The killed amounted to about 170 knights of the defeated party, and many thousands of foot on either side, of whom no accurate account can be given.

See Oman, *History of the Art of War*, vii. pp. 457-480; also Köhler, *Kriegsgeschichte*, &c., i. 140, and Delpech, *Tactique au XIII^e siècle*, 127.

BOVEY BEDS, in geology, a deposit of sands, clays and lignite, 200-300 ft. thick, which lies in a basin extending from Bovey Tracey to Newton Abbot in Devonshire, England. The deposit is evidently the result of the degradation of the neighbouring Dartmoor granite; and it was no doubt laid down in a lake. O. Heer, who examined the numerous plant remains from these beds, concluded that they belonged to the same geological horizon as the Molasse or Oligocene of Switzerland. Starkie Gardiner, however, who subsequently examined the flora, showed that it bore a close resemblance to that of the Bournemouth Beds or Lower Bagshot; in this view he is supported by C. Reid. Large excavations have been made for the

extraction of the clays, which are very valuable for pottery and similar purposes. The lignite or "Bovey Coal" has at times been burned in the local kilns, and in the engines and workmen's cottages, but it is not economical.

See S. Gardiner, *Q. J. G. S. London*, xxxv., 1879; W. Pengelly and O. Heer, *Phil. Trans.*, 1862; C. Reid, *Q. J. G. S.* lii., 1896, p. 490, and *loc. cit.* liv., 1898, p. 234. An interesting general account is given by A. W. Clayden, *The History of Devonshire Scenery* (London, 1906), pp. 159-168.

BOVIANUM, the name of two ancient Italian towns. (1) **UNDECIMANORUM** [*Boiano*], the chief city of the Pentri Samnites, 9 m. N.W. of Saepinum and 18 m. S.E. of Aesernia, on the important road from Beneventum to Corfinium, which connected the Via Appia and the Via Valeria. The original city occupied the height (*Civita*) above the modern town, where remains of Cyclopean walls still exist, while the Roman town (probably founded after the Social War, in which Bovianum was the seat of the Samnite assembly) lay in the plain. It acquired the name *Undecimanorum* when Vespasian settled the veterans of the *Legio XI. Claudia* there. Its remains have been covered by over 30 ft. of earth washed down from the mountains. Comparatively few inscriptions have been discovered. (2) **VETUS** (near Pietrabbondante, 5 m. S. of Agnone and 19 m. N.W. of Campobasso), according to Th. Mommsen (*Corpus Inscript. Lat.* ix. Berlin, 1883, p. 257) the chief town of the Caraceni. It lay in a remote situation among the mountains, and where Bovianum is mentioned the reference is generally to Bovianum Undecimanorum. Remains of fortifications and lower down of a temple and a theatre (*cf. Römische Mitteilungen*, 1903, 154)—the latter remarkable for the fine preservation of the stone seats of the three lowest rows of the auditorium—are to be seen. No less than eight Oscan inscriptions have been found. (T. A.)

BOVIDÆ, the name of the family of hollow-horned ruminant mammals typified by the common ox (*Bos taurus*), and specially characterized by the presence on the skulls of the males or of both sexes of a pair of bony projections, or cores, covered in life with hollow sheaths of horn, which are never branched, and at all events after a very early stage of existence are permanently retained. From this, which is alone sufficient for diagnostic purposes, the group is often called the *Cavicornia*. For other characteristics see *PECORA*. The *Bovidae* comprise a great number of genera and species, and include the oxen, sheep, goats, antelopes and certain other kinds which come under neither of these designations. In stature they range from the size of a hare to that of a rhinoceros; and their horns vary in size and shape from the small and simple spikes of the oribi and duiker antlers to the enormous and variously shaped structures borne respectively by buffaloes, wild sheep and kudu and other large antelopes. In geographical distribution the *Bovidae* present a remarkable contrast to the deer tribe, or *Cervidae*. Both of these families are distributed over the whole of the northern hemisphere, but whereas the *Cervidae* are absent from Africa south of the Sahara and well represented in South America, the *Bovidae* are unknown in the latter area, but are extraordinarily abundant in Africa. Neither group is represented in Australasia; Celebes being the eastern limit of the *Bovidae*. The present family doubtless originated in the northern half of the Old World, whence it effected an entrance by way of the Bering Strait route into North America, where it has always been but poorly represented in the matter of genera and species.

The *Bovidae* are divided into a number of sections, or sub-families, each of which is briefly noticed in the present article, while fuller mention of some of the more important representatives of these is made in other articles.

The first section is that of the *Bovinae*, which includes buffaloes, bison and oxen. The majority of these are large and heavily-built ruminants, with horns present in both sexes, the muzzle broad, moist and naked, the nostrils lateral, no face-glands, and a large dewlap often developed in the males; while the tail is long and generally tufted, although in one instance long-haired throughout. The horns are of nearly equal size in both sexes, are placed on or near the vertex of the skull, and may be either rounded or angulated, while their direction is more or

less outwards, with an upward direction near the tips, and conspicuous knobs or ridges are never developed on their surface. The tall upper molars have inner columns. The group is represented throughout the Old World as far east as Celebes, and has one living North American representative. All the species may be included in the genus *Bos*, with several subgeneric divisions (see ANOA, AUROCHS, BANTIN, BISON, BUFFALO, GAUR, GAYAL, OX and YAK).

The second group, or *Caprinae*, includes the sheep and goats, which are smaller animals than most of the *Bovidae*, generally with horns in both sexes, but those of the females small. In the males the horns are usually compressed and triangular, with transverse ridges or knobs, and either curving backwards or spiral. The muzzle is narrow and hairy; and when face-glands are present, these are small and insignificant; while the tail is short and flattened. Unlike the *Bovinae*, there are frequently glands in the feet; and the upper molar teeth differ from those of that group in their narrower crowns, which lack a distinct inner column. When a face-pit is present in the skull it is small. The genera are *Ovis* (sheep), *Capra* (goats) and *Hemitragus* (tahr). Sheep and goats are very nearly related, but the former never have a beard on the chin of the males, which are devoid of a strong odour; and their horns are typically of a different type. There are, however, several more or less transitional forms. Tahr are short-horned goats. The group is unknown in America, and in Africa is only represented in the mountains of the north, extending, however, some distance south into the Sudan and Abyssinia. All the species are mountain-dwellers. (See UNAD, ARGALI, GOAT, IBEX, MOUNTAIN SHEEP and TAHR.)

The musk-ox (*Ovibos moschatus*) alone represents the family *Ovibovinae*, which is probably most nearly related to the next group (see MUSK-OX).

Next come the *Rupicaprinae*, which include several genera of mountain-dwelling ruminants, typified by the European chamois (*Rupicapra*); the other genera being the Asiatic serow, goral and takin, and the North American Rocky Mountain goat. These ruminants are best described as goat-like antelopes. (See ANTELOPE, CHAMOIS, GORAL, ROCKY MOUNTAIN GOAT, SEROW and TAKIN.)

Under the indefinable term "antelope" (*q.v.*) may be included the seven remaining sections, namely *Tragelaphinae* (kudu and eland), *Hippotraginae* (sable antelope and oryx), *Antilopinae* (black-buck, gazelles, &c.), *Cervicaprinae* (reedbuck and waterbuck), *Neotraginae* (klipspringer and steinbok), *Cephalophinae* (duikers and four-horned antelopes) and *Bubalinae* (hartbeests and gnus). (R. L.)*

BOVILL, SIR WILLIAM (1814-1873), English judge, a younger son of Benjamin Bovill, of Wimbledon, was born at Allhallows, Barking, on the 26th of May 1814. On leaving school he was articled to a firm of solicitors, but entering the Middle Temple he practised for a short time as a special pleader below the bar. He was called in 1841 and joined the home circuit. His special training in a solicitor's office, and its resulting connexion, combined with a thorough knowledge of the details of engineering, acquired through his interest in a manufacturing firm in the east end of London, soon brought him a very extensive patent and commercial practice. He became Q.C. in 1855, and in 1857 was elected M.P. for Guildford. In the House of Commons he was very zealous for legal reform, and the Partnership Law Amendment Act 1865, which he helped to pass, is always referred to as Bovill's Act. In 1866 he was appointed solicitor-general, an office which he vacated on becoming chief justice of the common pleas in succession to Sir W. Erle in November of the same year. He died at Kingston, Surrey, on the 1st of November 1873. As a barrister he was unsurpassed for his remarkable knowledge of commercial law; and when promoted to the bench his painstaking labour and unwavering uprightness, as well as his great patience and courtesy, gained for him the respect and affection of the profession.

BOVILLÆ, an ancient town of Latium, a station on the Via Appia (which in 293 B.C. was already paved up to this point),

11 m. S.E. of Rome. It was a colony of Alba Longa, and appears as one of the thirty cities of the Latin league; after the destruction of Alba Longa the *sacra* were, it was held, transferred to Bovillæ, including the cult of Vesta (in inscriptions *virginis Vestales Albanæ* are mentioned, and the inhabitants of Bovillæ are always spoken of as *Albanii Longani Bovillenses*) and that of the *gens Julia*. The existence of this hereditary worship led to an increase in its importance when the Julian house rose to the highest power in the state. The knights met Augustus's dead body at Bovillæ on its way to Rome, and in A.D. 16 the shrine of the family worship was dedicated anew,¹ and yearly games in the circus instituted, probably under the charge of the *sodales Augustales*, whose official calendar has been found here. In history Bovillæ appears as the scene of the quarrel between Milo and Clodius, in which the latter, whose villa lay above the town on the left of the Via Appia, was killed. The site is not naturally strong, and remains of early fortifications cannot be traced. It may be that Bovillæ took the place of Alba Longa as a local centre after the destruction of the latter by Rome, which would explain the deliberate choice of a strategically weak position. Remains of buildings of the imperial period—the circus, a small theatre, and edifices probably connected with the post-station—may still be seen on the south-west edge of the Via Appia.

See L. Canina, *Via Appia* (Rome, 1853), l. 202 seq.; T. Ashby in *Mémoires de l'école française de Rome* (1903), p. 395. (T. AS.)

BOW (pronounced "bō"), a common Teutonic word for anything bent² (O. Eng. *bōza*; cf. O. Sax. and O.H.G. *boga*, M.H.G. *boge*, Mod. Ger. *bogen*; from O. Teut. stem *bug-*, *began*, Mod. Ger. *biegen*, to bend). Thus it is found in English compound words, e.g. "elbow," "rainbow," "bow-net," "bow-window," "bow-knot," "saddle-bow," and by itself as the designation of a great variety of objects. The Old English use of "bow" or stone-bow, for "arch," now obsolete, survives in certain names of churches and places, e.g. Bow church (St Mary-in-Arctubus) in Cheapside, and Stratford-le-Bow (the "Stratford-atte-Bowe" of Chaucer). "Bow," however, is still the designation of objects so various as an appliance for shooting arrows (see ARCHERY), a necktie in the form of a bow-knot (i.e. a double-looped knot), a ring or hoop forming a handle (e.g. the bow of a watch), certain instruments or tools consisting of a bent piece of wood with the ends drawn together by a string, used for drilling, turning, &c., in various crafts, and the stick strung with horsehair by means of which the strings of instruments of the violin family are set in vibration. It is with this last that the present article is solely concerned.

Bow in Music.—The modern bow (Fr. *archet*; Ger. *Bogen*; Ital. *arco*) consists of five parts, i.e. the "stick," the screw or "ferrule," the "nut," the "hair," and the "head." The stick, in high-grade bows, is made of Pernambuco wood (*Caesalpinia brasiliensis*), which alone combines the requisite lightness, elasticity and power of resistance; for the cheaper bows American oak is used, and for the double-bass bow beech. A billet rich in colouring matter and straight in the grain is selected, and the stick is usually cut from a tamplet so as to obtain the accurate taper, which begins about 4½ in. from the nut, decreasing according to regular proportions from ½ in. at the screw to ⅓ at the back of the head. The stick is cut absolutely straight and parallel along its whole length with the fibre of the wood; it is then bent by heat until it is slightly convex to the hair and has assumed the elegant *cambrure* first given to it by François Tourte (1747-1835). This process requires the greatest care, for if the fibres be not heated right through, they offer a continual resistance to the curve, and return after a time to the rigid

¹ It is not likely that any remains of it now exist.

² "Bow," the forepart or head of a ship, must be distinguished from this word. It is the same word, and pronounced in the same way as "bough," an arm or limb of a tree, and represents a common Teutonic word, seen in O. Eng. *bog*, Ger. *Bug*, shoulder, and cognate with Gr. *ἄξω*, forearm. The sense of "shoulder" of a ship is not found in O. Eng. *bog*, but was probably borrowed from Dutch or Danish. "Bow," an inclination of the head or body, though pronounced as "bough," is of the same origin as "bow," to bend.

straight line, a defect often observed in cheap bows. The sticks are now of either cylindrical or octagonal section, and are lapped or covered with gold thread or leather for some inches beyond the nut in order to afford a firm grip. The length of the stick was definitely and finally fixed by François Tourte at 29.34 to 29.28 in.

The centre of gravity in a well-balanced violin bow should be at 19 cm. (7½ to 7⅓ in.) from the nut; in the violoncello bow the hair measures from 60 to 62 cm. (24 to 25 in.), and the centre of gravity is at from 175 to 180 mm. (7 to 7½ in.) from the nut. In consequence of the flexure given to the stick, Tourte found it necessary to re-adjust the proportions and relative height of head and nut, in order to keep the hair at a satisfactory distance from the stick, and at the necessary angle in attacking the strings so as to avoid contact between stick and strings in bowing. In order to counterbalance the consequent increased weight of the head and to keep the centre of gravity nearer the hand, Tourte loaded the nut with metal inlays or ornamental designs.

The screw or ferrule, at the cylindrical end of the stick held by the hand, provides the means of tightening or loosening the tension of the hair. This screw, about 3½ in. long, hidden within the stick, runs through the eye of another little screw at right angles to it, which is firmly embedded in the nut.

The nut is a wooden block at the screw end of the stick, the original purpose of which was to keep the hair at a proper distance from the stick and to provide a secure attachment for the hair. The whole nut slides up and down the stick in a groove in answer to the screw, thus tightening or relaxing the tension of the hair. In the nut is a little cavity or chamber, into which the knotted end of the hair is firmly fixed by means of a little wedge, the hair being then brought out and fattened over the front of the nut like a ribbon by the pressure of a flat ferrule. The mother-of-pearl slide which runs along a mortised groove further protects the hair on the outside of the nut. Bows having these attachments of ferrule and slide, added by Tourte at the instigation of the violinist Giovanni Battista Viotti, were known as *archets à recouvrements*.

The hair is chosen from the best white horsehair, and each of the 150 to 200 hairs which compose the half-inch wide ribbon of the bow must be perfectly cylindrical and smooth. It is bought by the pound, and must be very carefully sorted, for not more than one hair in ten is perfectly cylindrical and fit for use on a high-grade bow. Experience determines the right number of hairs, for if the ribbon be too thick it hinders the vibration of the strings; if too thin the friction is not strong enough to produce a good tone. Fétis gives 175 to 250 as the number used in the modern bow,¹ and Julius Rühlmann 110 to 120.² Tourte attached the greatest importance to the hairing of the bow, and bestowed quite as much attention upon it as upon the stick. He subjected the hair to the following process of cleansing: first it was thoroughly scoured with soap and water to remove all grease, then steeped in bran-water, freed from all heterogeneous matter still adhering to it, and finally rinsed in pure water slightly blueed. When passed between the fingers in the direction from root to tip, the hair glides smoothly and offers no resistance, but passed in the opposite direction it feels rough, suggesting a regular succession of minute projections. The outer epithelium or sheath of the hair is composed of minute scales which produce a succession of infinitesimal shocks when the hair is drawn across the strings; the force and uniformity of these shocks, which produce series of vibrations of equal persistency, is considerably brightened by the application of rosin to the hair. The particles of rosin cling to the scales of the epithelium, thus accentuating the projections and the energy of the attack or "bite" upon the strings. With use, the scales of the epithelium wear off, and then no matter how much rosin is applied, the bow fails to elicit musical sounds—it is then "played out" and must be re-haired. The organic construction of horsehair makes it necessary, in hairing the bow, to lay the hairs in opposite directions, so that the up and down strokes may be equal and a pure and even tone obtained. Waxed silk is wound round both ends of the hair to form a strong knot, which is afterwards covered with melted rosin and hardens with the hair into a solid mass.

The head, 1 in. long and ¾ in. wide at the plate, is cut in one piece with the stick, an operation which requires delicate workmanship; otherwise the head is liable to snap at this point during a *sfzando* passage. The head has a chamber and wedge contrivance similar to that of the nut, in which the other end of the hair is immovably fixed. The hair on the face of the head is protected by a metal or ivory plate.

The model bow here described, elaborated by François Tourte as long ago as between 1775 and 1780 according to Fétis,³ or between 1745 and 1790 according to Vidal,⁴ has not since been surpassed.

¹ See F. J. Fétis, *Antoines Stradivari*, pp. 120-121 (Paris, 1856).

² Fétis, *op. cit.* p. 123.

³ J. Rühlmann, *Die Geschichte der Bogensinstrumente* (Brunswick, 1822), p. 143.

⁴ Fétis, *op. cit.* p. 119.

⁵ Antoine Vidal, *Les Instruments à archet* (Paris, 1876-1878), tome i. p. 269.

That the violin and the bow form one inseparable whole becomes evident when we consider the history of the forerunners of the viol family: without the bow the ancestor of the violin would have remained a guitar; the bow would not have reached its present state of perfection had it been required only for instruments of the *rebec* and *vielle* type. As soon as the possibilities of the violin were realized, as a solo instrument capable, through the agency of the bow, of expressing the emotions of the performer, the perfecting of the bow was prosecuted in earnest until it was capable of responding to every shade of delicate thought and feeling. This accounts in a measure for the protracted development of the bow, which, although used long before the violin had been evolved, did not reach a state of perfection at the hands of Tourte until more than a century and a half after the Cremona master had given us the violin.

The question of the origin of the bow still remains a matter of conjecture. Its appearance in western Europe seems to have coincided with the conquest of Spain by the Moors in the 8th century, and the consequent impetus their superior culture gave to arts and sciences in the south-west of Europe. We have, however, no well-authenticated representation of the bow before the 9th century in Europe; the earliest is the bow illustrated along with the *Lyra Teutonica* by Martin Gerbert,⁶ the representation being taken from a MS. at the monastery of St Blaise, dating in his opinion from the 9th century. On the other hand, Byzantine art of the 9th and 11th centuries⁷ reveals acquaintance with a bow far in advance of most of the crude contemporary specimens of western Europe. The bow undoubtedly came from the East, and was obviously borrowed by the Greeks of Asia Minor and the Arabs from a common source—probably India, by way of Persia. The earliest representation of a bow yet discovered is to be found among the fine frescoes in one of the chapels of the monastery of Bawit⁸ in Egypt. The mural paintings in question were the work of many artists, covering a considerable period of time. The only non-religious subject depicted is a picture of a youthful Orpheus, assigned by Jean Clédat to some date not later than the 8th century A.D., but more probably the work of a 6th-century artist. Orpheus is holding an instrument, which appears to be a rebab, against his chin, in the act of bowing and stopping the strings. The bow is similar in shape to one shown in the Psalter of Labeo Notker, Leipzig, 10th century, mentioned farther on. On Indian sculptures of the first centuries of our era, such as the Buddhist stupas of Amaravati, the risers of the topes of Jamal-Garhi, in the Yusufzai district of Afghanistan (both in the British Museum), on which stringed instruments abound, there is no bow. The bow has remained a primitive instrument in India to this day; a Hindu tradition assigns its invention to Ravanon, a king of Ceylon, and the instrument for which it was invented was called *ravanastron*; a primitive instrument of that name is still in use in Hindustan.⁹ F. J. Fétis,¹⁰ Antoine Vidal,¹¹ Edward Heron-Allen,¹² and others have given the question some consideration, and readers who wish to pursue the matter farther are referred to their works.

There is thus no absolute proof of the existence of the bow in primitive times. The earliest bow known in Europe was associated with the rebab (*q.v.*), the most widely used bowed instrument until the 12th century. The development of this

⁶ *De Cantu et Musica Sacra* (1774), tome ii. pl. xxxiii. No. 18; the MS. has since perished by fire.

⁷ See for an illustration of the bowed instrument on one of the sides of a Byzantine ivory casket, 9th century, in the Carand Collection, Florence, A. Venturi, *Gallerie Nazionali Italiane*, iii. (Rome, 1897), plate, p. 263; and *Add. MS. 19, 352, British Museum*, Greek Psalter, dated 1066.

⁸ See Jean Clédat, "Le Monastère et la nécropole de Baout," in *Mém. de l'Inst. franç. d'archéol. orient. du Caire*, vol. xii. (1904), chap. xviii. pl. liv. (2); also Fernand Cabrol, *Dict. d'archéol. chrétienne*, s.v. "Baout."

⁹ For an illustration, see Sonnerat, *Voyage aux Indes orientales* (Paris, 1806), vol. i. p. 182.

¹⁰ *Op. cit.* pp. 4-10.

¹¹ *Op. cit.* vol. i. p. 3 and pl. ii.

¹² Edward Heron-Allen, *Violin-making as it was and is* (London, 1884), pp. 37-42, figs. 5-10.

instrument can be traced with some degree of certainty, but it is quite impossible to decide at what date or in what place the use of the bow was introduced. The bow developed very slowly in Europe and remained a crude instrument as long as it was applied to the rebab and its hybrids. Its progress became marked only from the time when it was applied to the almost perfect guitar (*q.v.*), which then became the guitar fiddle (*q.v.*), the immediate forerunner of the viols.

The first improvement on the primitive arched bow was to provide some sort of handle in a straight line with the hair or string of the bow, such as is shown in the MS. translation of the Psalms by Labeo Notker, late 10th century, in the University library, Leipzig.¹ The length of the handle was often greatly exaggerated, perhaps by the fancy of the artist. Another handle (see Bodleian Library MS., N.E.D. 2, 12th century) was in the form of a hilt with a knob, possibly a screw-nut, in which the arched stick and the hair were both fixed. The first development of importance influencing the technique of stringed instruments was the attempt to find some device for controlling the tension of the hair.



Drawn from the ivory cover of the *Lethair Psalter*, by permission of Sir Thomas Brooke.

FIG. 1.—Earliest Bow of the *Crémaillère* Type (c. 11th century).

Forming an obtuse angle with the handle of the bow is a contrivance shaped like a spear-head which presumably served some useful purpose; if it had notches (which would be too small to show in the drawing), and the hair of the bow was finished with a loop, then we have here an early example of a device for controlling the tension. Another bow in the same MS. has two round knobs on the stick which may be assumed to have served the same purpose.

A very early example of the *crémaillère* bow (fig. 1) occurs on a carved ivory plate ornamenting the binding of the fine Carolingian MS. *Psalter of Lothair* (A.D. 825), for some time known as the *Ellis and White Psalter*, but now in the library of Sir Thomas Brooke at Armitage Bridge House. The carved figure of King David, assigned from its characteristic pose and the treatment of the drapery to the 11th century, holds a stringed

The artist has added a bow with *crémaillère* attachment, which is startling if the carving be accurately placed in the 11th century. The earliest representation of a *crémaillère* bow, with this exception, dates from the 15th century, according to Viollet-le-Duc, who merely states that it was copied from a painting.² Fétis (*op. cit.*, p. 117) figures a *crémaillère* bow which he styles "Bassani, 1680." Sebastian Virdung draws a bow for a *tromba marina*, with the hair and stick bound together with waxed cord. The hair appears to be kept more or less tense by means of a wedge of wood or other material forced in between stick and hair, the latter bulging slightly at this point like the string of an archery bow when the arrow is in position; this contrivance may be due to the fancy of the artist.

The invention of a movable nut propelled by a screw is ascribed to the elder Tourte (fig. 2); had we not this information on the best authority (Vuillaume and Fétis), it might be imagined that some of the bows figured by Mersenne,³ e.g. the bass viol bow KL (p. 184), and another KLM (p. 192), had a movable nut and screw; the nut is clearly drawn astride the stick as in the modern bow. Mersenne explains (p. 178) the construction of the bow, which consists of three parts: the *bois*, *déton* or *bris*, the *soye*, and the *demi-roule* or *hausse*. The term "half-wheel" clearly indicates that the base of the nut was cut round so as to fit round the stick. In the absence of any allusion to such ingenious mechanism as that of screw and nut, we must infer that the drawing is misleading and that the very decided button was only meant for an ornamental finish to the stick. We are informed further that *la soye* was in reality hairs from the horse or some other animal, of which from 80 to 100 were used for each bow. The up-stroke of the bow was used on the weak beats, 2, 4, 6, 8, and the down-stroke on the strong beats, 1, 3, 5, 7 (p. 185). The same practice prevailed in England in 1667, when Christopher Simpson wrote the *Division Viol*. He gives information concerning the construction of the bow in these words: "the viol-bow for division should be stiff but not heavy. The length (betwixt the two places where the hairs are fastened at each end) about seven-and-twenty inches. The nut should be short, the height of it about a finger's breadth or a little more" (p. 2).

As soon as Corelli (1653-1713) formulated the principles of the technique of the violin, marked modifications in the construction of the bow became noticeable. Tartini, who began during the second decade of the 18th century to gauge the capabilities of the bow, introduced further improvements, such as a lighter wood for the stick, a straight contour, and a shorter head, in order to give better equilibrium. The Tourtes, father and son, accomplished the rest.

After François Tourte, the following makers are the most esteemed: J. B. Vuillaume, who was directly inspired by Tourte and rendered an inestimable service to violinists by working out on a scientific basis the empirical taper of the Tourte stick, which was found in all his bows to conform to strict ratio;⁴ Dominique Peccate, apprenticed to J. B. Vuillaume; Henry, 1812-1870, who signs his

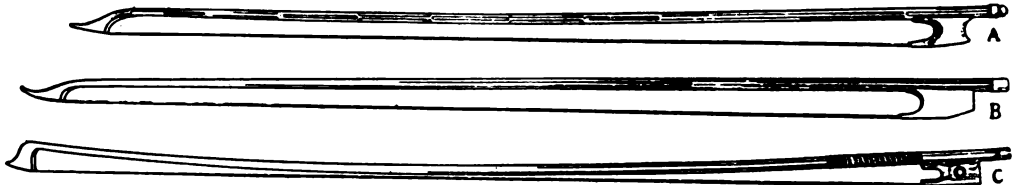

Drawn from bows the property of William E. Hill & Sons.

FIG. 2.—A, B, Tartini Bows; C, Tourte Bow.

instrument, a *rotta* of peculiar shape, which occurs twice in other Carolingian MSS.⁵ of the 9th century, but copied here without understanding, as though it were a lyre with many strings.

¹ MS. 774, fol. 30. For an illustration of it see Hyacinth Abele, *Die Violine, ihre Geschichte und ihr Bow* (Neuburg-a-D., 1874), pl. 5, No. 7.

² See *Crown* for fig. from the Bible of Charles le Chauve; and also King David in the Bible of St Paul *extra muros*, Rome (photographic facsimile by J. O. Westwood, Oxford, 1876).

name and "Paris" on the stick near the nut; Jacques Lefeur, 1760-1832; François Lupot, 1774-1837, the first to line the angular cutting of the nut, where it slides along the stick, with a plate of

³ See *Dictionnaire raisonné du mobilier français* (Paris, 1871), vol. ii. part iv. pp. 265 D. and 266 note.

⁴ Marin Mersenne, *L'Harmonie universelle* (Paris, 1636-1637), pp. 184 and 192.

⁵ Vuillaume's diagram and explanation are reproduced by Fétis *op. cit.* pp. 125-128.

metal; Simon, born 1808, who also signs his bows on the stick near the nut; John Dodd of Richmond, the greatest English bow-maker, who was especially renowned for his violoncello bows, though his violin bows had the defect of being rather short.

The violoncello bow is a little shorter than those used for violin and viola, and the head and nut are deeper.

The principal models of double-bass bows in vogue at the beginning of the 19th century were the *Dragonetti*, maintaining the arch of the medieval bows, and the *Botterini*, shaped and held like the violin bow; the former was held over-hand with the hair inclining towards the bridge, and was adopted by the Paris Conservatoire under Habeneck about 1830; the great artist himself sent over the model from London. Illustrations of both bows are given by Vidal (*op. cit.* pl. xviii.).

Messrs W. E. Hill & Sons probably possess the finest and most representative collection of bows in the world. (K. S.)

BOWDICH, THOMAS EDWARD (1790-1824), English traveller and author, was born at Bristol in 1790. In 1814, through his uncle, J. Hope-Smith, governor of the British Gold Coast Settlements, he obtained a writership in the service of the African Company of Merchants and was sent to Cape Coast. In 1817 he was sent, with two companions, to Kumasi on a mission to the king of Ashanti, and chiefly through his skillful diplomacy the mission succeeded in its object of securing British control over the coast natives (see *ASHANTI: History*). In 1818 Bowdich returned to England, and in 1819 published an account of his mission and of the study he had made of the barbaric court of Kumasi, entitled *Mission from Cape Coast Castle to Ashantee, &c.* (London, 1819). His African collections were presented to the British Museum. Bowdich publicly attacked the management of the African committee, and his strictures were instrumental in leading the British government to assume direct control over the Gold Coast. From 1820 to 1822 Bowdich lived in Paris, studying mathematics and the natural sciences, and was on intimate terms with Cuvier, Humboldt and other savants. During his stay in France he edited several works on Africa, and also wrote scientific works. In 1822, accompanied by his wife, he went to Lisbon, where, from a study of historic MSS, he published *An Account of the Discoveries of the Portuguese in . . . Angola and Mozambique* (London, 1824). In 1823 Bowdich and his wife, after some months spent in Madeira and Cape Verde Islands, arrived at Bathurst at the mouth of the Gambia, intending to go to Sierra Leone and thence explore the interior. But at Bathurst Bowdich died on the 10th of January 1824. His widow published an account of his last journey, entitled *Excursions in Madeira and Porto Santo . . . to which is added . . . A Narrative of the Continuance of the Voyage to its Completion, &c.* (London, 1825). Bowdich's daughter, Mrs Hutchinson Hale, republished in 1873, with an introductory preface, her father's *Mission from Cape Coast Castle to Ashantee*.

BOWDITCH, NATHANIEL (1773-1838), American mathematician, was born at Salem, Massachusetts. He was bred to his father's business as a cooper, and afterwards apprenticed to a ship-chandler. His taste for mathematics early developed itself; and he acquired Latin that he might study Newton's *Principia*. As clerk (1795) and then as supercargo (1796, 1798, 1799) he made four long voyages; and, being an excellent navigator, he afterwards (1802) commanded a vessel, instructing his crews in lunar and other observations. He edited two editions of Hamilton Moore's *Navigation*, and in 1802 published a valuable work, *New American Practical Navigator*, founded on the earlier treatise by Moore. In 1804 he became president of a Salem insurance company. In the midst of his active career he undertook a translation of the *Mécanique céleste* of P. S. Laplace, with valuable annotations (vol. 1, 1829). He was offered, but declined, the professorship of mathematics and astronomy at Harvard. Subsequently he became president of the Mechanics' Institute in Boston, and also of the American Academy of Arts and Sciences. He died at Boston on the 16th of March 1838.

A life of Bowditch was written by his son Nathaniel Ingersoll Bowditch (1805-1861), and was prefixed to the fourth volume (1839) of the translation of Laplace. In 1865 this was elaborated into a separate biography by another son, Henry Ingersoll Bowditch (1806-1892), a famous Boston physician.

BOWLER, THOMAS (1754-1825), editor of the "family" Shakespeare, younger son of Thomas Bowdler, a gentleman of

independent fortune, was born at Ashley, near Bath, on the 11th of July 1754. He studied medicine at the universities of St Andrews and Edinburgh, graduating M.D. in 1776. After four years spent in foreign travel, he settled in London, where he became intimate with Mrs Montague and other learned ladies. In 1800 he left London to live in the Isle of Wight, and later on he removed to South Wales. He was an energetic philanthropist, and carried on John Howard's work in the prisons and penitentiaries. In 1818 he published *The Family Shakespeare* "in ten volumes, in which nothing is added to the original text; but those words and expressions are omitted which cannot with propriety be read aloud in a family." Criticisms of this edition appeared in the *British Critic* of April 1822. Bowdler also expurgated Edward Gibbon's *History of the Decline and Fall of the Roman Empire* (published posthumously, 1826); and he issued a selection from the Old Testament for the use of children. He died at Rhyddings, near Swansea, on the 24th of February 1825.

From Bowdler's name we have the word to "bowdlerize," first known to occur in General Perronet Thompson's *Letters of a Representative to his Constituents during the Session of 1836*, printed in Thompson's *Exercises*, iv. 126. The official interpretation is "to expurgate (a book or writing) by omitting or modifying words or passages considered indelicate or offensive." Both the word and its derivatives, however, are associated with false squeamishness. In the ridicule poured on the name of Bowdler it is worth noting that Swinburne in "Social Verse" (*Studies in Prose and Poetry*, 1894, p. 98) said of him that "no man ever did better service to Shakespeare than the man who made it possible to put him into the hands of intelligent and imaginative children," and stigmatized the talk about his expurgations as "nauseous and foolish cant."

BOWDOIN, JAMES (1726-1790), American political leader, was born of French Huguenot descent, in Boston, Massachusetts, on the 7th of August 1726. He graduated at Harvard in 1745, and was a member of the lower house of the general court of Massachusetts in 1753-1756, and from 1757 to 1774 of the Massachusetts council, in which, according to Governor Thomas Hutchinson, he "was without a rival," and, on the approach of the War of Independence, was "the principal supporter of the opposition to the government." From August 1775 until the summer of 1777 he was the president of the council, which had then become to a greater extent than formerly an executive as well as a legislative body. In 1770-1780 he was president of the constitutional convention of Massachusetts, also serving as chairman of the committee by which the draft of the constitution was prepared. Immediately afterward he was a member of a commission appointed "to revise the laws in force in the state; to select, abridge, alter and digest them, so as to be accommodated to the present government." From 1785 to 1787 he was governor of Massachusetts, suppressing with much vigour Shays' Rebellion, and failing to be re-elected largely because it was believed that he would punish the insurrectionists with more severity than would his competitor, John Hancock. Bowdoin was a member of the state convention which in February 1788 ratified for Massachusetts the Federal Constitution, his son being also a member. He died in Boston on the 6th of November 1790. He took much interest in natural philosophy, and presented various papers before the American Academy of Arts and Sciences, of which he was one of the founders and, from 1780 to 1790, the first president. Bowdoin College was named in his honour.

His son, JAMES BOWDOIN (1752-1811), was born in Boston on the 22nd of September 1752, graduated at Harvard in 1771, and served, at various times, as a representative, senator and councillor of the state. From 1805 until 1808 he was the minister plenipotentiary of the United States in Spain. He died on Nausubon Island, Dukes county, Massachusetts, on the 11th of October 1811. To Bowdoin College he gave land, money and apparatus; and he made the college his residuary legatee, bequeathing to it his collection of paintings and drawings, then considered the finest in the country.

BOWELL, SIR MACKENZIE (1823—), Canadian politician, son of John Bowell, carpenter and builder, was born at Rickinghall, England, on the 27th of December 1823. In 1833 he moved with his family to Belleville, Canada, where he finally became editor and proprietor of the *Intelligencer*. He was elected grand master of the Orange Association of British America, and was long the exponent in the Canadian parliament of the claims of that order. From 1867 till 1892 he represented North Hastings in the House, after which he retired to the senate. From 1878 till 1891 he was minister of customs in the cabinet of Sir John Macdonald; then minister of militia; and under the premiership of Sir John Thompson, minister of trade and commerce. From December 1894 till April 1896 he was premier of Canada, and endeavoured to enforce remedial legislation in the question of the Manitoba schools. But his policy was unsuccessful, and he retired from the government. From 1896 till 1906 he led the Conservative party in the senate. In 1894 he presided over the colonial conference held in Ottawa, and in 1895 was created K.C.M.G.

BOWEN, CHARLES SYNGE CHRISTOPHER BOWEN, BARON (1835—1894), English judge, was born on the 1st of January 1835, at Woolston in Gloucestershire, his father, the Rev. Christopher Bowen of Hollymount, Co. Mayo, being then curate of the parish. He was educated at Lille, Blackheath and Rugby schools, leaving the latter with a Balliol scholarship in 1853. At Oxford he made good the promise of his earlier youth, winning the principal classical scholarships and prizes of his time. He was made a fellow of Balliol in 1858. From Oxford Bowen went to London, where he was called to the bar at Lincoln's Inn in 1861, and while studying law he wrote regularly for the *Saturday Review*, and also later for the *Spectator*. For a time he had little success at the bar, and came near to exchanging it for the career of a college tutor, but he was induced by his friends, who recognized his talents, to persevere. Soon after he had begun to make his mark he was briefed against the claimant in the famous "Tichborne Case." Bowen's services to his leader, Sir John Coleridge, helped to procure for him the appointment of junior counsel to the treasury when Sir John had passed, as he did while the trial proceeded, from the office of solicitor-general to that of attorney-general; and from this time his practice became a very large one. The strain, however, of the Tichborne trials had been great, so that his physical health became unequal to the tasks which his zeal for work imposed upon it, and in 1879 his acceptance of a judgeship in the queen's bench division, on the retirement of Mr Justice Mellor, gave him the opportunity of comparative rest. The character of Charles Bowen's intellect hardly qualified him for some of the duties of a puisne judge; but it was otherwise when, in 1882, in succession to Lord Justice Holker, he was raised to the court of appeal. As a lord justice of appeal he was conspicuous for his learning, his industry and his courtesy to all who appeared before him; and in spite of failing health he was able to sit more or less regularly until August 1893, when, on the retirement of Lord Hennen, he was made a lord of appeal in ordinary, and a baron for life, with the title of Baron Bowen of Colwood. By this time, however, his health had finally broken down; he never sat as a law lord to hear appeals, and he gave but one vote as a peer, while his last public service consisted in presiding over the commission which sat in October 1893 to inquire into the Featherstone riots. He died on the 10th of April 1894.

Lord Bowen was regarded with great affection by all who knew him either professionally or privately. He had a polished and graceful wit, of which many instances might be given, although such anecdotes lose force in print. For example, when it was suggested on the occasion of an address to Queen Victoria, to be presented by her judges, that a passage in it, "conscious as we are of our shortcomings," suggested too great humility, he proposed the emendation "conscious as we are of one another's shortcomings"; and on another occasion he defined a jurist as "a person who knows a little about the laws of every country except his own." Lord Bowen's judicial reputation will rest upon the series of judgments delivered by him in the court of

appeal, which are remarkable for their lucid interpretation of legal principles as applied to the facts and business of life. Among good examples of his judgment may be cited that given in advising the House of Lords in *Angus v. Dalton* (6 App. Cas. 740), and those delivered in *Abrath v. North Eastern Railway* (11 Q.B.D. 440); *Thomas v. Quartermaine* (18 Q.B.D. 685); *Vagliano v. Bank of England* (23 Q.B.D. 243) (in which he prepared the majority judgment of the court, which was held to be wrong in its conclusion by the majority of the House of Lords); and the *Mogul Steamship Company v. M'Gregor* (23 Q.B.D. 598). Of Lord Bowen's literary works besides those already indicated may be mentioned his translation of Virgil's *Ecloques*, and *Aeneid*, books i.-vi., and his pamphlet, *The Alabama Claim and Arbitration considered from a Legal Point of View*. Lord Bowen married in 1862 Emily Frances, eldest daughter of James Meadows Rendel, F.R.S., by whom he had two sons and a daughter.

See *Lord Bowen*, by Sir Henry Stewart Cunningham.

BOWEN, FRANCIS (1811—1890), American philosophical writer and educationalist, was born in Charlestown, Massachusetts, on the 8th of September 1811. He graduated at Harvard in 1833, taught for two years at Phillips Exeter Academy, and then from 1835 to 1839 was a tutor and instructor at Harvard. After several years of study in Europe, he settled in Cambridge, Massachusetts, and was editor and proprietor of the *North American Review* from 1843 to 1854. In 1859 he was appointed professor of history at Harvard; but his appointment was disapproved by the board of overseers on account of reactionary political opinions he had expressed in a controversy with Robert Carter (1819—1879) concerning the Hungarian revolution. In 1853 his appointment as Alford professor of natural religion, moral philosophy and civil polity was approved, and he occupied the chair until 1889. In 1876 he was a member of the Federal commission appointed to consider currency reform, and wrote (1877) the minority report, in which he opposed the restoration of the double standard and the re-monetization of silver. He died in Boston, Massachusetts, on the 22nd of January 1890. His writings include lives of Sir William Phipps, Baron von Steuben, James Otis and Benjamin Lincoln in Jared Sparks' "Library of American Biography"; *Critical Essays on the History and Present Condition of Speculative Philosophy* (1842); *Lowell Lectures on the Application of Metaphysical and Ethical Science to the Evidences of Religion* (1849); *The Principles of Political Economy applied to the Condition, Resources and Institutions of the American People* (1856); *A Treatise on Logic* (1864); *American Political Economy* (1870); *Modern Philosophy from Descartes to Schopenhauer and Hartmann* (1877); and *Gleanings from a Literary Life, 1838—1880* (1880).

BOWEN, SIR GEORGE FERGUSON (1821—1899), British colonial governor, eldest son of the Rev. Edward Bowen, afterwards rector of Taughboyne, Co. Donegal, was born on the 2nd of November 1821. Educated at Charterhouse school and Trinity College, Oxford, he took a first class in classics in 1844, and was elected a fellow of Brasenose. In 1847 he was chosen president of the university of Corfu. Having served as secretary of government in the Ionian Islands, he was appointed in 1859 the first governor of Queensland, which colony had just been separated from New South Wales. He was interested in the exploration of Queensland and in the establishment of a volunteer force, but incurred some unpopularity by refusing to sanction the issue of inconvertible paper money during the financial crisis of 1865. In 1867 he was made governor of New Zealand, in which position he was successful in reconciling the Maoris to the English rule, and saw the end of the struggle between the colonists and the natives. Transferred to Victoria in 1872, Bowen endeavoured to reduce the expenses of the colony, and in 1879 became governor of Mauritius. His last official position was that of governor of Hong-Kong, which he held from 1882 to 1887. He was made a K.C.M.G. in 1856, a privy councillor in 1886, and received honorary degrees from both Oxford and Cambridge. In December 1887 he was appointed chief of the royal commission which was sent to Malta with regard to the new constitution for

the island, and all the recommendations made by him were adopted. He died at Brighton on the 21st of February 1899, having been married twice, and having had a family of one son and four daughters. Bower wrote *Ithaca in 1850* (London, 1854), translated into Greek in 1859; and *Mount Athos, Thessaly and Epirus* (London, 1852); and he was the author of Murray's *Handbook for Greece* (London, 1854).

A selection of his letters and despatches, *Thirty Years of Colonial Government* (London, 1889), was edited by S. Lane-Poole.

BOWER, WALTER (1385-1449), Scottish chronicler, was born about 1385 at Haddington. He was abbot of Inchcolm (in the Firth of Forth) from 1418, was one of the commissioners for the collection of the ransom of James I., king of Scots, in 1423 and 1424, and in 1433 one of the embassy to Paris on the business of the marriage of the king's daughter to the dauphin. He played an important part at the council of Perth (1432) in the defence of Scottish rights. During his closing years he was engaged on his work the *Scotchichronicon*, on which his reputation now chiefly rests. This work, undertaken in 1440 by desire of a neighbour, Sir David Stewart of Rosyth, was a continuation of the *Chronica Gratia Scotorum* of Fordun. The completed work, in its original form, consisted of sixteen books, of which the first five and a portion of the sixth (to 1163) are Fordun's—or mainly his, for Bower added to them at places. In the later books, down to the reign of Robert I. (1371), he was aided by Fordun's *Gesta Annalia*, but from that point to the close the work is original and of contemporary importance, especially for James I., with whose death it ends. The task was finished in 1447. In the two remaining years of his life he was engaged on a reduction or "abridgment" of this work, which is known as the *Book of Cuppar*, and is preserved in the Advocates' library, Edinburgh (MS. 35. 1. 7). Other abridgments, not by Bower, were made about the same time, one about 1450 (perhaps by Patrick Russell, a Carthusian of Perth) preserved in the Advocates' library (MS. 35. 6. 7) and another in 1461 by an unknown writer, also preserved in the same collection (MS. 35. 5. 2). Copies of the full text of the *Scotchichronicon*, by different scribes, are extant. There are two in the British Museum, in *The Black Book of Paisley*, and in Harl. MS. 712; one in the Advocates' library, from which Walter Goodall printed his edition (Edin., 1759), and one in the library of Corpus Christi, Cambridge.

Goodall's is the only complete modern edition of Bower's text. See also W. F. Skene's edition of Fordun in the series of *Historians of Scotland* (1871). Personal references are to be found in the *Esquisse des Rois de Scotland*, iii, and iv. The best recent account is that by T. A. Archer in the *Dict. of Nat. Biog.*

BOWERBANK, JAMES SCOTT (1797-1877), English naturalist and palaeontologist, was born in Bishopgate, London, on the 14th of July 1797, and succeeded in conjunction with his brother to his father's distillery, in which he was actively engaged until 1847. In early years astronomy and natural history, especially botany, engaged much of his attention; he became an enthusiastic worker at the microscope, studying the structure of shells, corals, moss-ages, flints, &c., and he also formed an extensive collection of fossils. The organic remains of the London Clay attracted particular attention, and about the year 1836 he and six other workers founded "The London Clay Club"—the members comprising Dr Bowerbank, Frederick E. Edwards (1799-1875), author of *The Eocene Mollusca* (Palaeontograph. Soc.), Searles V. Wood, John Morris, Alfred White (zoologist), N. T. Wetherell, surgeon of Highgate (1800-1875), and James de Carle Sowerby. In 1840 Bowerbank published *A History of the Fossil Fruits and Seeds of the London Clay*, and two years later he was elected F.R.S. In 1847 he suggested the establishment of a society for the publication of undescribed British Fossils, and thus originated the Palaeontographical Society. From 1844 until 1864 he did much to encourage a love of natural science by being "at home" every Monday evening at his residence in Park Street, Islington, and afterwards in Highbury Grove, where the treasures of his museum, his microscopes, and his personal assistance were at the service of every earnest student. In the study of sponges he became specially interested, and he was author of *A Monograph*

of the British Spongiadae in 4 vols., published by the Ray Society, 1864-1882. He retired in 1864 to St Leonards, where he died on the 8th of March 1877.

BOWIE, JAMES (1796-1836), American pioneer, was born in Logan county, Kentucky. He was taken to Louisiana about 1802, and in 1818-1820 was engaged with his brothers, John J. and Rezin P., in smuggling negro slaves into the United States from the headquarters of the pirates led by Jean Lafitte on Galveston Island. Bowie removed to Texas in 1828 and took a prominent part in the revolt against Mexico, being present at the battles of Nacogdoches (1832), Concepcion (1835) and the Grass Fight (1835). He was one of the defenders of the Alamo (see SAN ANTONIO), but was ill of pneumonia at the time of the final assault on the 6th of March 1836, and was among the last to be butchered. Bowie's name is now perpetuated by a county in north-eastern Texas, and by its association with that of the famous hunting-knife, which he used, but probably did not invent.

BOW-LEG (*Genu Varum*), a deformity characterized by separation of the knees when the ankles are in contact. Usually there is an outward curvature of both femur and tibia, with at times an interior bend of the latter bone. At birth all children are more or less bandy-legged. The child lies on its nurse's knee with the soles of the feet facing one another; the tibiae and femora are curved outwards; and, if the limbs are extended, although the ankles are in contact, there is a distinct space between the knee-joints. During the first year of life a gradual change takes place. The knee-joints approach one another; the femora slope downwards and inwards towards the knee-joints; the tibiae become straight; and the sole of the foot faces almost directly downwards. While these changes are occurring, the bones, which at first consist principally of cartilage, are gradually becoming ossified, and in a normal child by the time it begins to walk the lower limbs are prepared, both by their general direction and by the rigidity of the bones which form them, to support the weight of the body. If, however, the child attempts either as the result of imitation or from encouragement to walk before the normal bandy condition had passed off, the result will necessarily be either an arrest in the development of the limbs or an increase of the bandy condition. If the child is weakly, either rachitic or suffering from any ailment which prevents the due ossification of the bones, or is improperly fed, the bandy condition may remain persistent. Thus the chief cause of this deformity is rickets (*q.v.*). The remaining causes are occupation, especially that of a jockey, and traumatism, the condition being very likely to supervene after accidents involving the condyles of the femur. In the rickety form the most important thing is to treat the constitutional disease, at the same time instructing the mother never to place the child on its feet. In many cases this is quite sufficient in itself to effect a cure, but matters can be hastened somewhat by applying splints. When in older patients the deformity arises either from traumatism or occupation, the only treatment is that of operation.

A far commoner deformity than the preceding is that known as *knock-knee* (or *Genu Valgum*). In this condition there is close approximation of the knees with more or less separation of the feet, the patient being unable to bring the feet together when standing. Occasionally only one limb may be affected, but the double form is the more common. There are two varieties of this deformity: (i.) that due to rickets and occurring in young children (the rachitic form), and (ii.) that met with in adolescents and known as the static form. In young children it is practically always due to rickets, and the constitutional disease must be most rigorously dealt with. It is, however, especially in these cases that cod-liver oil is to be avoided, since it increases the body weight and so may do harm rather than good. The child if quite young must be kept in bed, and the limbs manipulated several times a day. Where the child is a little older and it is more difficult to keep him off his feet, long splints should be applied from the axilla or waist to a point several inches below the level of the foot. It is only by making the splints sufficiently long

that a naturally active child can be kept at rest. The little patient should live in the open air as much as possible.

The static form of Genu Valgum usually occurs in young adolescents, especially in anaemic nurse-girls, young bricklayers, and young people who have outgrown their strength, yet have to carry heavy weights. Normally in the erect posture the weight of the body is passed through the outer condyle of the femur rather than the inner, and this latter is lengthened to keep the plane of the knee-joint horizontal. This throws considerable strain on the internal lateral ligament of the knee-joint, and after standing of long duration or with undue weight the muscles of the inner side of the limb also become over-fatigued. Thus the ligament gradually becomes stretched, giving the knee undue mobility from side to side. If the condition be not attended to, the outer condyle becomes gradually atrophied, owing to the increased weight transmitted through it, and the inner condyle becomes lengthened. These changes are the direct outcome of a general law, namely, that diminished pressure results in increased growth, increased pressure in diminished growth. The best example of the former principle is the rapid growth that takes place in the child that is confined to bed during a prolonged illness. The distorted, stunted, shortened and fashionable foot of the Chinese lady is an example of the latter. Flat-foot (see CLUB-FOOT) and lateral curvature of the spine, scoliosis, are often associated with this form of Genu Valgum, the former being due to relaxation of ligaments, the latter being compensatory where the deformity only affects one leg, though often found merely in association with the more common bilateral variety. In the early stages of the static form attention to general health, massage and change of air, will often effect a cure. But in the more aggravated forms an apparatus is needed. This usually consists of an outside iron rod, jointed at the knee, attached above to a pelvic band and below to the heel of the boot. By the gradual tightening of padded straps passing round the limbs the bones can be drawn by degrees into a more natural position. But if the patient has reached such an age that the deformity is fixed, then the only remedy is that of operation.

BOWLES, SAMUEL (1826-1878), American journalist; was born in Springfield, Massachusetts, on the 9th of February 1826. He was the son of Samuel Bowles (1779-1851) of the same city, who had established the weekly *Springfield Republican* in 1824. The daily issue was begun in 1844, as an evening newspaper, afterwards becoming a morning journal. To its service Samuel Bowles, junior, devoted his life (with the exception of a brief period during which he was in charge of a daily in Boston), and he gave the paper a national reputation by the vigour, incisiveness and independence of its editorial utterances, and the concise and convenient arrangement of its local and general news-matter. During the controversies affecting slavery and resulting in the Civil War, Bowles supported, in general, the Whig and Republican parties, but in the period of Reconstruction under President Grant his paper represented anti-administration or "Liberal Republican" opinions, while in the disputed election of 1876 it favoured the claims of Tilden, and subsequently became independent in politics. Bowles died at Springfield on the 16th of January 1878. During his lifetime, and subsequently, the *Republican* office was a sort of school for young journalists, especially in the matter of pungency and conciseness of style, one of his maxims being "put it all in the first paragraph." Bowles published two books of travel, *Across the Continent* (1865) and *The Switzerland of America* (1866), which were combined into one volume under the title *Ours New West* (1869). He was succeeded as publisher and editor-in-chief of the *Republican* by his son Samuel Bowles (b. 1851).

A eulogistic *Life and Times of Samuel Bowles* (2 vols., New York, 1885), by George S. Merriam, is virtually a history of American political movements after the compromise of 1850.

BOWLES, WILLIAM LISLE (1762-1850), English poet and critic, was born at King's Sutton, Northamptonshire, of which his father was vicar, on the 24th of September 1762. At the age of fourteen he entered Winchester school, the head-master at

the time being Dr Joseph Warton. In 1781 he left as captain of the school, and proceeded to Trinity College, Oxford, where he had gained a scholarship. Two years later he won the chancellor's prize for Latin verse. In 1789 he published, in a small quarto volume, *Fourteen Sonnets*, which met with considerable favour at the time, and were hailed with delight by Coleridge and his young contemporaries. The *Sonnets* even in form were a revival, a return to the older and purer poetic style, and by their grace of expression, melodious versification, tender tone of feeling and vivid appreciation of the life and beauty of nature, stood out in strong contrast to the elaborated commonplaces which at that time formed the bulk of English poetry. After taking his degree at Oxford he entered the Church, and was appointed in 1792 to the vicarage of Chicklade in Wiltshire. In 1797 he received the vicarage of Dumbleton in Gloucestershire, and in 1804 was presented to the vicarage of Bremhill in Wiltshire. In the same year he was collated by Bishop Douglas to a prebendal stall in the cathedral of Salisbury. In 1818 he was made chaplain to the prince regent, and in 1828 he was elected residentiary canon of Salisbury. He died at Salisbury on the 7th of April 1850, aged 88.

The longer poems published by Bowles are not of a very high standard, though all are distinguished by purity of imagination, cultured and graceful diction, and great tenderness of feeling. The most extensive were *The Spirit of Discovery* (1804), which was mercilessly ridiculed by Byron; *The Missionary of the Andes* (1815); *The Grave of the Last Saxon* (1822); and *St John in Palmos* (1833). Bowles is perhaps more celebrated as a critic of poetry than as a poet. In 1806 he published an edition of Pope's works with notes and an essay on the poetical character of Pope. In this essay he laid down certain canons as to poetic imagery which, subject to some modification, have been since recognized as true and valuable, but which were received at the time with strong opposition by all admirers of Pope and his style. The "Pope and Bowles" controversy brought into sharp contrast the opposing views of poetry, which may be roughly described as the natural and the artificial. Bowles maintained that images drawn from nature are poetically finer than those drawn from art; and that in the highest kinds of poetry the themes or passions handled should be of the general or elemental kind, and not the transient manners of any society. These positions were vigorously assailed by Byron, Campbell, Roscoe and others of less note, while for a time Bowles was almost solitary. Hazlitt and the *Blackwood* critics, however, came to his assistance, and on the whole Bowles had reason to congratulate himself on having established certain principles which might serve as the basis of a true method of poetical criticism, and of having inaugurated, both by precept and by example, a new era in English poetry. Among other prose works from his prolific pen was a *Life of Bishop Ken* (2 vols., 1830-1831).

His *Poetical Works* were collected in 1855, with a memoir by G. Gilfillan.

BOWLINE (a word found in most Teutonic languages, probably connected with the "bow" of a ship), a nautical term for a rope leading from the edge of a sail to the bows, for the purpose of steadying the sail when sailing close to the wind—"on a bowline."

BOWLING (Lat. *bulia*, a globe, through O. Fr. *bowle*, ball), an indoor game played upon an alley with wooden balls and nine or ten wooden pins. It has been played for centuries in Germany and the Low Countries, where it is still in high favour, but attains its greatest popularity in the United States, whence it was introduced in colonial times from Holland. The Dutch inhabitants of New Amsterdam, now New York, were much addicted to it, and up to the year 1840 it was played on the green, the principal resort of the bowlers being the square just north of the Battery still called Bowling Green. The first covered alleys were made of hardened clay or of slate, but those in vogue at present are built up of alternate strips of pine and maple wood, about 1 x 3 in. in size, set on edge, and fastened together and to the bed of the alley with the nicest art of the cabinet-maker.

The width of the alley is 41½ in.; and its whole length about 80 ft. From the head, or apex, pin to the foul-line, over which the player may not step in delivering the ball, the distance is 60 ft. On each side of the alley is a 9-in. "gutter" to catch any balls that are bowled wide. Originally nine pins, set up in the diamond form, were used, but during the first part of the 19th century the game of "nine-pins" was prohibited by law, on account of the excessive betting connected with it. This ordinance, however, was soon evaded by the addition of a tenth pin, resulting in the game of "ten-pins," the pastime in vogue to-day. The ten pins are set up at the end of the alley in the form of a right-angled triangle in four rows, four pins at the back, then three, then two and one as head pin. The back row is placed 3 in. from the alley's edge, back of which is the pin-pit, 10 in. deep and about 3 ft. wide. The back wall is heavily padded (often with a heavy, swinging cushion), and there are safety corners for the pin-boys, who set up the pins, call the scores and place the balls in the sloping "railway" which returns them to the players' end of the alley. The pins are made of hard maple and are 15 in. high, 2½ in. in diameter at their base and 1½ in. in circumference at the thickest point. The balls, which are made of some very hard wood, usually lignum vitæ, may be of any size not exceeding 27 in. in circumference and 16½ lb in weight. They are provided with holes for the thumb and middle finger. As many may play on a side as please, five being the number for championship teams, though this sometimes varies. Each player rolls three balls, called a *frame*, and ten frames constitute a game, unless otherwise agreed upon. In first-class matches two balls only are rolled. If all ten pins are knocked down by the first ball the player makes a *strike*, which counts him 10 plus whatever he may make with the first two balls of his next frame. If, however, he should then make another strike, 10 more are added to his score, making 20, to which are added the pins he may knock down with his first ball of the third frame. This may also score a strike, making 30 as the score of the first frame, and, should the player keep up this high average, he will score the maximum, 300, in his ten frames. If all the pins are knocked down with two balls it is called a *split*, and the player may add the pins made by the first ball of his second frame. This seemingly complicated mode of scoring is comparatively simple when properly lined score-boards are used. Of course, if all three balls are used no strike or spare is scored, but the number of pins overturned is recorded. The tens of thousands of bowling clubs in the United States and Canada are under the jurisdiction of the American Bowling Congress, which meets once a year to revise the rules and hold contests for the national championships.

Several minor varieties of bowling are popular in America, the most in vogue being "Cocked Hat," which is played with three pins, one in the head-pin position and the others on either corner of the back row. The pins are usually a little larger than those used in the regular game, and smaller balls are used. The maximum score is 90, and all balls, even those going into the gutter, are in play. "Cocked hat and Feather" is similar, except that a fourth pin is added, placed in the centre. Other variations of bowling are "Quintet," in which five pins, set up like an arrow pointed towards the bowler, are used; the "Battle Game," in which 12 can be scored by knocking down all but the centre, or king, pin; "Head Pin and Four Back," in which five pins are used, one in the head-pin position and the rest on the back line; "Four Back"; "Five Back"; "Deck Pin"; "Head Pin," with nine pins set up in the old-fashioned way, and "Candle Pin," in which thin pins tapering towards the top and bottom are used, the other rules being similar to those of the regular game.

The American bowling game is played to a slight extent in Great Britain and Germany. In the latter country, however, the old-fashioned game of nine-pins (*Kegelspiel*) with solid balls and the pins set up diamond-fashion, obtains universally. The alleys are made with less care than the American, being of cement, asphalt, slate or marble.

BOWLING GREEN, a city and the county-seat of Warren county, Kentucky, U.S.A., on the Barren river, 113 m. S. by W. of Louisville. Pop. (1890) 7803; (1900) 8226, of whom 2903 were negroes; (1910) 9173. The city is served by the Louisville & Nashville railway (which maintains car shops here), and by steamboats navigating the river. Macadam-

ized or gravel roads also radiate from it; to all parts of the surrounding country, a rich agricultural and live-stock raising region, in which there are deposits of coal, iron ore, oil, natural gas, asphalt and building stone. The city is the seat of Potter College (for girls; non-sectarian, opened 1889); of Ogden College (non-sectarian, 1877), a secondary school, endowed by the bequest of Major Robert W. Ogden (1796-1873); of the West Kentucky State Normal School, opened (as the Southern Normal School and Business College) at Glasgow in 1875 and removed to Bowling Green in 1884; and of the Bowling Green Business University, formerly a part of the Southern Normal School and Business College. Bowling Green has two parks, a large horse and mule market, and a trade in other live-stock, tobacco and lumber; among its manufactures are flour, lumber, tobacco and furniture. The municipality owns and operates the water-works and the electric lighting plant. Bowling Green was incorporated in 1812. During the early part of the Civil War Bowling Green was on the right flank of the first line of Confederate defence in the West, and was for some time the headquarters of General Albert Sidney Johnston. It was abandoned, however, after the capture by the Federals of Forts Henry and Donelson.

BOWLING GREEN, a city and the county-seat of Wood county, Ohio, U.S.A., 20 m. S. by W. of Toledo, of which it is a residential suburb. Pop. (1890) 3467; (1900) 5067 (264 foreign-born); (1910) 5222. Bowling Green is served by the Cincinnati, Hamilton & Dayton and the Toledo & Ohio Central railways, and by the Toledo Urban & Interurban and the Lake Erie, Bowling Green & Napoleon electric lines, the former extending from Toledo to Dayton. It is situated in a rich agricultural region which abounds in oil and natural gas. Many of the residences and business places of Bowling Green are heated by a privately owned central hot-water heating plant. Among the manufactures are cut glass, stoves and ranges, kitchen furniture, guns, thread-cutting machines, brooms and agricultural implements. Bowling Green was first settled in 1832, was incorporated as a town in 1855, and became a city in 1904.

BOWLS, the oldest British outdoor pastime, next to archery, still in vogue. It has been traced certainly to the 13th, and conjecturally to the 12th century. William Fitzstephen (d. about 1190), in his biography of Thomas Becket, gives a graphic sketch of the London of his day and, writing of the summer amusements of the young men, says that on holidays they were "exercised in Leaping, Shooting, Wrestling, Casting of Stones [*in jactu lapidum*], and Throwing of Javelins fitted with Loops for the Purpose, which they strive to fling before the Mark; they also use Bucklers, like fighting Men." It is commonly supposed that by *jactus lapidum* Fitzstephen meant the game of bowls, but though it is possible that round stones may sometimes have been employed in an early variety of the game—and there is a record of iron bowls being used, though at a much later date, on festive occasions at Nairn,—nevertheless the inference seems unwarranted. The *jactus lapidum* of which he speaks was probably more akin to the modern "putting the weight," once even called "putting the stone." It is beyond dispute, however, that the game, at any rate in a rudimentary form, was played in the 13th century. A MS. of that period in the royal library, Windsor (No. 20, E iv.), contains a drawing representing two players aiming at a small cone instead of an earthenware ball or jack. Another MS. of the same century has a picture—crude, but spirited—which brings us into close touch with the existing game. Three figures are introduced and a jack. The first player's bowl has come to rest just in front of the jack; the second has delivered his bowl and is following after it with one of those eccentric contortions still not unusual on modern greens, the first player meanwhile making a repressive gesture with his hand, as if to urge the bowl to stop short of his own; the third player is depicted as in the act of delivering his bowl. A 14th-century MS. *Book of Prayers* in the Francis Douce collection in the Bodleian library at Oxford contains a drawing in which two persons are shown, but they bowl to no mark. Strutt (*Sports*

and Pastimes) suggests that the first player's bowl may have been regarded by the second player as a species of jack; but in that case it is not clear what was the first player's target. In these three earliest illustrations of the pastime it is worth noting that each player has one bowl only, and that the attitude in delivering it was as various five or six hundred years ago as it is to-day. In the third he stands almost upright; in the first he kneels; in the second he stoops, halfway between the upright and the kneeling position.

As the game grew in popularity it came under the ban of king and parliament, both fearing it might jeopardize the practice of archery, then so important in battle; and statutes forbidding it and other sports were enacted in the reigns of Edward III., Richard II. and other monarchs. Even when, on the invention of gunpowder and firearms, the bow had fallen into disuse as a weapon of war, the prohibition was continued. The discredit attaching to bowling alleys, first established in London in 1455, probably encouraged subsequent repressive legislation, for many of the alleys were connected with taverns frequented by the dissolute and gamblers. The word "bowls" occurs for the first time in the statute of 1511 in which Henry VIII confirmed previous enactments against unlawful games. By a further act of 1541—which was not repealed until 1845—artificers, labourers, apprentices, servants and the like were forbidden to play bowls at any time save Christmas, and then only in their master's house and presence. It was further enjoined that any one playing bowls outside of his own garden or orchard was liable to a penalty of 6s. 8d., while those possessed of lands of the yearly value of £100 might obtain licences to play on their own private greens. But though the same statute absolutely prohibited bowling alleys, Henry VIII. had them constructed for his own pleasure at Whitehall Palace, and was wont to back himself when he played. In Mary's reign (1555) the licences were withdrawn, the queen or her advisers deeming the game an excuse for "unlawful assemblies, conventicles, seditious and conspiracies." The scandals of the bowling alleys grew rampant in Elizabethan London, and Stephen Gosson in his *School of Abuse* (1579) says, "Common bowling alleys are privy moths that eat up the credit of many idle citizens; whose gains at home are not able to weigh down their losses abroad; whose shops are so far from maintaining their play, that their wives and children cry out for bread, and go to bed supperless often in the year."

Biased bowls were introduced in the 16th century. "A little altering of the one side," says Robert Recorde, the mathematician, in his *Castle of Knowledge* (1556), "maketh the bowl to run *blasse waies*." And Shakespeare (*Richard II.*, Act. III. Sc. 4) causes the queen to remonstrate, in reply to her lady's suggestion of a game at bowls to relieve her ennui, "'Twill make me think the world is full of rubs, and that my fortune runs against the bias." This passage is interesting also as showing that women were accustomed to play the game in those days. It is pleasant to think that there is foundation for the familiar story of Sir Francis Drake playing bowls on Plymouth Hoe as the Armada was beating up Channel, and finishing his game before tackling the Spaniards. Bowls, at that date, was looked upon as a legitimate amusement for Sundays,—as, indeed, were many other sports. When John Knox visited Calvin at Geneva one Sunday, it is said that he discovered him engaged in a game; and John Aylmer (1521-1594), though bishop of London, enjoyed a game of a Sunday afternoon, but used such language "as justly exposed his character to reproach." The pastime found favour with the Stuarts. In the *Book of Sports* (1618), James I. recommended a moderate indulgence to his son, Prince Henry, and Charles I. was an enthusiastic bowler, unfortunately encouraging by example wagering and playing for high stakes, habits that ultimately brought the green into as general disrepute as the alley. It is recorded that the king occasionally visited Richard Shute, a Turkey merchant who owned a beautiful green at Barking Hall, and that after one bout his losses were £1000. He was permitted to play his favourite game to beguile the tedium of his captivity. The signboard of a wayside inn near Goring Heath in Oxfordshire long bore a portrait of the king with

couplets reciting how his majesty "drank from the bowl, and bowl'd for what he drank." During his stay at the Northamptonshire village of Holdenby or Holmby—where Sir Thomas Herbert complains the green was not well kept—Charles frequently rode over to Lord Vaux's place at Harrowden, or to Lord Spencer's at Althorp, for a game, and, according to one account, was actually playing on the latter green when Cornet Joyce came to Holmby to remove him to other quarters. During this period gambling had become a mania. John Aubrey, the antiquary, chronicles that the sisters of Sir John Suckling, the courtier-poet, once went to the bowling-green in Piccadilly, crying, "for fear he should lose all their portions." If the Puritans regarded bowls with no friendly eye, as Lord Macanlay asserts, one can hardly wonder at it. But even the Puritans could not suppress betting. So eminently respectable a person as John Evelyn thought no harm in bowling for stakes, and once played at the Durdans, near Epsom, for £10, winning match and money, as he triumphantly notes in his *Diary* for the 14th of August 1657. Samuel Pepys repeatedly mentions finding great people "at bowls." But in time the excesses attending the game rendered it unfashionable, and after the Revolution it became practically a pothouse recreation, nearly all the greens, like the alleys, having been constructed in the grounds and gardens attached to taverns.

After a long interval salvation came from Scotland, somewhat unexpectedly, because although, along with its winter analogue of curling, bowls may now be considered, much more than golf, the Scottish national game, it was not until well into the 19th century that the pastime acquired popularity in that country. It had been known in Scotland since the close of the 16th century (the Glasgow kirk session fulminated an edict against Sunday bowls in 1595), but greens were few and far between. There is record of a club in Haddington in 1709, of Tom Bicket's green in Kilmarnock in 1740, of greens in Candleriggs and Gallowgate, Glasgow, and of one in Lanark in 1750, of greens in the grounds of Heriot's hospital, Edinburgh, prior to 1768, and of one in Peebles in 1775. These are, of course, mere infants compared with the Southampton Town Bowling Club, founded in 1299, which still uses the green on which it has played for centuries and possesses the quaint custom of describing its master, or president, as "sir," and are younger even than the Newcastle-on-Tyne club established in 1657. But the earlier clubs did nothing towards organizing the game. In 1848 and 1849, however, when many clubs had come into existence in the west and south of Scotland (the Willowbank, dating from 1816, is the oldest club in Glasgow), meetings were held in Glasgow for the purpose of promoting a national association. This was regarded, by many, as impracticable, but a decision of final importance was reached when a consultative committee was appointed to draft a uniform code of laws to govern the game. This body delegated its functions to its secretary, W. W. Mitchell (1803-1884), who prepared a code that was immediately adopted in Scotland as the standard laws. It was in this sense that Scottish bowlers saved the game. They were, besides, pioneers in laying down level greens of superlative excellence. Not satisfied with seed-sown grass or meadow turf, they experimented with seaside turf and found it answer admirably. The 13th earl of Eglinton also set an example of active interest which many magnates emulated. Himself a keen bowler, he offered for competition, in 1854, a silver bowl and, in 1857, a gold bowl and the Eglinton Cup, all to be played for annually. These trophies excited healthy rivalry in Ayrshire and Lanarkshire, and the enthusiasm as well as the skill with which the game was conducted in Scotland at length proved contagious. Clubs in England began to consider the question of legislation, and to improve their greens. Moreover, Scottish emigrants introduced the game wherever they went, and colonists in Australia and New Zealand established many clubs which, in the main, adopted Mitchell's laws; while clubs were also started in Canada and in the United States, in South Africa, India (Calcutta, Karachi), Japan (Kobe, Yokohama, Kumamoto) and Hong-Kong. In Ireland the game took root very gradually, but in Ulster, owing doubtless to constant

intercourse with Scotland, such clubs as have been founded are strong in numbers and play.

On the European continent the game can scarcely be said to be played on scientific principles. It has existed in France since the 17th century. When John Evelyn was in Paris in 1644 he saw it played in the gardens of the Luxembourg Palace. In the south of France it is rather popular with artisans, who, however, are content to pursue it on any flat surface and use round instead of biased bowls, the bowler, moreover, indulging in a preliminary run before delivering the bowl, after the fashion of a bowler in cricket. A rude variety of the game occurs in Italy, and, as we have seen, John Calvin played it in Geneva, where John Evelyn also noticed it in 1646. There is evidence of its vogue in Holland in the 17th century, for the painting by David Teniers (1610-1690), in the Scottish National Gallery at Edinburgh, is wrongly described as "Peasants playing at Skittles." In this picture three men are represented as having played a bowl, while the fourth is in the act of delivering his bowl. The game is obviously bowls, the sole difference being that an upright peg, about 4 in. high, is employed instead of a jack,—recalling, in this respect, the old English form of the game already mentioned.

Serious efforts to organize the game were made in the last quarter of the 19th century, but this time the lead came from Australia. The Bowling Associations of Victoria and New South Wales were established in 1880, and it was not until 1892 that the Scottish Bowling Association was founded. Then in rapid succession came several independent bodies—the Midland Counties (1895), the London and Southern Counties (1896), the Imperial (1899), the English (1903) and the Irish and Welsh (1904). These institutions were concerned with the task of regularizing the game within the territories indicated by their titles, but it soon appeared that the multiplicity of associations was likely to prove a hindrance rather than a help, and with a view, therefore, to reducing the number of clashing jurisdictions and bringing about the establishment of a single legislative authority, the Imperial amalgamated with the English B.A. in 1905. The visits to the United Kingdom of properly organized teams of bowlers from Australia and New Zealand in 1901 and from Canada in 1904 demonstrated that the game had gained enormously in popularity. The former visit was commemorated by the institution of the Australia Cup, presented to the Imperial Bowling Association (and now the property of the English B.A.) by Mr Charles Wood, president of the Victorian Bowling Association. An accredited team of bowlers from the mother country visited Canada in 1906, and was accorded a royal welcome. Perhaps the most interesting proof that bowls is a true *Volksspiel* is to be found in the fact that it has become municipalized. In Edinburgh, Glasgow, and elsewhere in Scotland, and in London (through the county council), Newcastle and other English towns, the corporations have laid down greens in public parks and open spaces. In Scotland the public greens are self-supporting, from a charge, which includes the use of bowls, of one penny an hour for each player; in London the upkeep of the greens falls on the rates, but players must provide their own bowls.

There are two kinds of bowling green, the level and the crown. The crown has a fall which may amount to as much as 18 in. all round from the centre to the sides. This type of green is confined almost wholly to certain of the northern and midland counties of England, where it is popular for single-handed, gate-money contests. But although the crown-green game is of a sporting character, it necessitates the use of bowls of narrow bias and affords but limited scope for the display of skill and science. It is the game on the perfectly level green that constitutes the historical game of bowls. Subject to the rule as to the shortest distance to which the jack must be thrown (25 yds.), there is no prescribed size for the lawn; but 42 yds. square forms an ideal green. The Queen's Park and Titwood clubs in Glasgow have each three greens, and as they can quite comfortably play six rinks on each, it is not uncommon to see 144 players making their game simultaneously. An under-sized lawn is really a poor pitch, because it involves playing from corner to corner instead of up and down—the orthodox

direction. For the scientific construction of a green, the whole ground must be excavated to a depth of 18 in. or so, and thoroughly drained, and layers of different materials (gravel, cinders, moulds, silver-sand) laid down before the final covering of turf, 2½ or 3 in. thick. Seaside turf is the best. It wears longest and keeps its "spring" to the last. Surrounding the green is a space called a ditch, which is nearly but not quite on a level with the green and slopes gently away from it, the side next the turf being lined with boarding, the ditch itself bottomed with wooden spars resting on the foundation. Beyond the ditch are banks generally laid with turf. A green is divided into spaces usually from 18 to 21 ft. in width, commonly styled "rinks"—a word which also designates each set of players—and these are numbered in sequence on a plate fixed in the bank at each end opposite the centre of the space. The end ditch within the limits of the space is, according to Scottish laws, regarded as part of the green, a regulation which prejudices the general acceptance of those laws. In match play each space is further marked off from its neighbour by thin string securely fastened flush with the turf.

Every player uses four *hignuss vilas* bowls in single-handed games and (as a rule) in friendly games, but only two in matches. Every bowl must have a certain amount of bias, which was formerly obtained by loading one side with lead, but is now imparted by the turner making one side more convex than the other, the bulge showing the side of the bias. No bowl must have less than No. 3 bias—that is, it should draw about 6 ft. to a 30 yd. jack on a first-rate green: it follows that on an inferior green the bowler, though using the same bowl, would have to allow for a narrower draw. It is also a rule that the diameter of the bowl shall not be less than 4½ in. nor more than 5½ in., and that its weight must not exceed 3½ lb. The jack or kitty, as the white earthenware ball to which the bowler bowls is called, is round and 2½ to 2½ in. in diameter. On crown-greens it is customary to use a small biased wooden jack to give the bowler some clue to the run of the green. The bowler delivers his bowl with one foot on a mat or footer, made of india-rubber or cocconut fibre, the size of which is also prescribed by rule as 24 by 16 in., though, with a view to protecting the green, Australasian clubs employ a much larger size, and require the bowler to keep both feet on the mat in the act of delivery.

In theory the game of bowls is very simple, the aim of the player being to roll his bowl so as to cause it to rest nearer to the jack than his opponent's, or to protect a well-placed bowl, or to dialodge a better bowl than his own. But in practice there is every opportunity for skill. On all good greens the game is played in rinks of four a side, there being, however, on the part of many English clubs still an adherence to the old-fashioned method of two and three a side rinks. Ordinarily a match team consists of four rinks of four players each, or sixteen men in all. The four players in a rink are known as the leader, second player, third player and skip (or driver, captain or director), and their positions, at least in matches, are unchangeable. Great responsibility is thus thrown on the skip in the choice of his players, who are selected for well-defined reasons. The leader has to place the mat, to throw the jack, to count the game, and to call the result of each end or head to the skip who is at the other end of the green. He is picked for his skill in playing to the jack. It is, therefore, his business to "be up." There is no excuse for short play on his part, and his bowls would be better off the green than obstructing the path of subsequent bowls. So he will endeavour to be "on the jack" the ideal position being a bowl at rest immediately in front of or behind it. The skip plays last, and directs his men from the end that is being played to. The weakest player in the four is invariably played in the second place (the "soft second"). Most frequently he will be required either to protect a good bowl or to rectify a possible error of the leader. His official duty is to mark the game on the scoring card when the leader announces the result. He keeps a record of the play of both sides. The third player, who does any measuring that may be necessary to determine which bowl or bowls may be nearest the jack, holds almost as responsible

a position as the captain, whose place, in fact, he takes whenever the skip is temporarily absent. The duties of the skip will already be understood by inference. Before he leaves the jack to play, he must observe the situation of the bowls of both sides. It may be that he has to draw a shot with the utmost nicety to save the end, or even the match, or to lay a cunningly contrived block, or to "fire"—that is, to deliver his bowl almost dead straight at the object, with enough force to kill the bias for the moment. The score having been counted, the leader then places the mat, usually within a yard of the spot where the jack lay at the conclusion of the head, and throws the jack in the opposite direction for a fresh end. On small greens play, for obvious reasons, generally takes place from each ditch. The players play in couples—the first on both sides, then the second and so on. The leader having played his first bowl, the opposing leader will play his first and so on. As a rule, a match consists of 21 points, or 21 ends (or a few more, by agreement).

Certain points in the play call for notice. In throwing the jack, the leader is bound to throw (i.e. roll) a legal jack. A legal jack must travel at least 25 yds. from the footer and not come to rest within 2 yds. of either side boundary; but it may be thrown as far beyond this as the leader chooses, provided that it does not run within 2 yds. of the end ditch or either side boundary. In English practice the leader is entitled to a second throw if he fail to roll a

On Scottish greens the game of points is frequently played, but it is rarely seen on English greens. Its main object is to perfect the proficiency of players in certain departments of bowls proper. There are four sections in the game, namely, drawing, guarding, trailing and driving. In *drawing* (fig. 1), the object is to draw as near as possible to the jack, the player's bowl passing outside of two other bowls placed 5 ft. apart in a horizontal line 15 ft. from the jack, without touching either of them. Three points are scored if the bowl come to rest within 1 ft. of the jack, two points if within 2 ft., and one point if within 3 ft. Circles of these radii are usually marked around the jack for convenience sake. In *guarding* (fig. 2), two jacks are laid at the far end of the green 12 ft. apart in a vertical line. A thread is then pinned down between them, and on each side of this thread three others are pinned down parallel with it and 6 in. apart from each other. A bowl that comes to rest on the central line, or within 6 in. of it, counts three points, a bowl 12 in. away two points, and a bowl 18 in. off one point. In *trailing* (fig. 3), two bowls are laid on the turf 3 ft. apart, and straight lines are chalked from bowl to bowl across their back and front faces, and a jack is then deposited equidistant from each bowl and immediately before the front line. A semicircle is then drawn behind the bowls with a radius of 9 ft. from the jack. Three points are given to the bowl that trails the jack over both lines into the semicircle and goes over them itself. If a bowl trail the jack over both lines, but only itself cross the first; or if it pass both lines, but the jack cross only the first, two points are awarded. A bowl passing between the jack and either of the stationary bowls, and passing over the back line; or touching the jack, yet not trailing it past the first line, but itself crossing the back line;

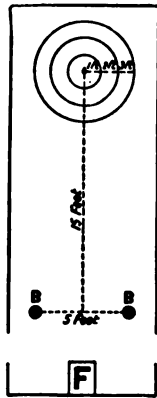

FIG. 1.—Drawing.

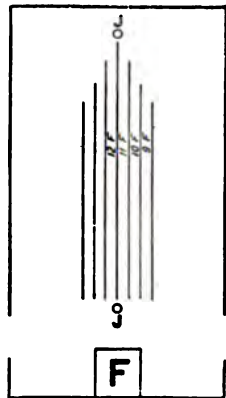

FIG. 2.—Guarding.

(In every case F is the Footer, B the Bowl, J the Jack.)

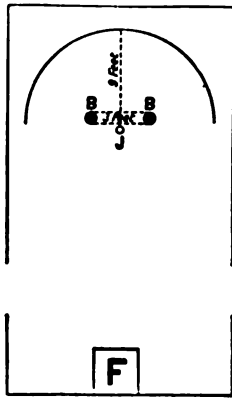

FIG. 3.—Trailing.

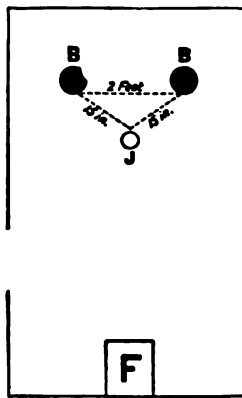

FIG. 4.—Driving.

legal jack at his first attempt; should he fail again, the right to throw passes to his opponent, but not the right of playing first. On Scottish greens the leader has only a single throw. A legal jack should not be interfered with except by the course of play. Should the jack be driven towards the side boundary, it is legitimate for a player to cause his bowl to draw outside of the dividing string, provided that when it has ceased running it shall have come to rest entirely within his own space. If it stop on the string, or outside of it, the bowl is "dead" and must be removed to the bank. A "toucher" bowl is a characteristic of the Scottish game to which great exception is taken by many English clubs. Should a bowl running jackwards touch the jack, however slightly, it is called a toucher and must be marked by the skip with a chalk cross as soon as it is at rest. Such a bowl is alive until the end is finished wherever it may lie, within the limits of the space. Even if it run into the ditch or be driven in by another bowl, it will yet count as alive. A bowl, however, that is forced on to the jack by another is not a toucher. The feat of hitting the jack is so common that it really calls for no special reward. Difference of opinion prevails as to the condition of the jack after it has been driven into the ditch. According to Scottish rules, unless it has been forced clean out of bounds, such a jack is still alive. On most English greens it is a "dead" jack and the end void. Every bowler should learn both forehand and backhand play. In forehand play the bowl as it courses to the jack describes its segment of a circle on the right, in backhand play on the left. In both styles the biased side must always be the inner.

In the United Kingdom the regular bowling season extends from May till the end of September or the middle of October. At its close the green must be carefully examined, weeds uprooted, worn patches re-turfed, and the whole laid under a winter blanket of silver-sand.

or trailing the jack over the front line without crossing it itself, receives one point. In no case must the stationary bowls be touched, or the semicircle crossed by the trailed jack or played bowls. In *driving* (fig. 4), two bowls are laid down 2 ft. apart, and then a jack is placed in front of them, 15 ft. apart from each, and occupying the position of the apex of an inverted pyramid. The player who drives the jack into the ditch between the two bowls scores three. If he moves the jack, but does not carry it through to the ditch, he scores two. If he pass between the jack and either bowl he scores one, although it is not easy to see what driving he has done. The played bowl must itself run into the ditch without touching either of the stationary bowls. It is obvious that the points game demands as ideally perfect green.

See W. W. Mitchell, *Manual of Bowl-playing* (Glasgow, 1880); *Laws of the Game issued by the Scottish B.A.* (1893, et seq.); H. J. Dingley, *Touchers and Rubs* (Glasgow, 1893); Sam Aylwin, *The Gentle Art of Bowling*, with 26 diagrams (London, 1904); James A. Manson, *The Bowler's Handbook* (London, 1906). (J. A. M.)

BOWNESS-ON-WINDERMERE, an urban district in the Appleby parliamentary division of Westmorland, England, on the east shore of Windermere, 1½ m. S.W. of Windermere station on the London & North-Western railway. Together with the town of Windermere it forms an urban district (pop. 5061 in 1901), but the two towns were separate until 1905. Its situation is fine, the lake-shore here rising sharply, while at this point the lake narrows and is studded with islands. The low surrounding hills are richly wooded, and a number of country seats stand upon them. Bowness lies at the head of a small bay, is served by the lake-steamers of the Furness Railway Company, and is a

favourite yachting, boating, fishing and tourist centre. The church of St Martin is ancient, and contains stained glass from Cartmel priory in Furness. (See WINDERMERE.)

BOWRING, SIR JOHN (1792-1872), English linguist, political economist and miscellaneous writer, was born at Exeter, on the 17th of October 1792, of an old Puritan family. In early life he came under the influence of Jeremy Bentham. He did not, however, share his master's contempt for *belles-lettres*, but was a diligent student of literature and foreign languages, especially those of eastern Europe. As a linguist he ranked with Mezzofanti and von Gabelentz among the greatest of the world. The first-fruits of his study of foreign literature appeared in *Specimens of the Russian Poets* (1821-1823). These were speedily followed by *Belavian Anthology* (1824), *Ancient Poetry and Romances of Spain* (1824), *Specimens of the Polish Poets*, and *Serbian Popular Poetry*, both in 1827. During this period he began to contribute to the newly founded *Westminster Review*, of which he was appointed editor in 1825. By his contributions to the *Review* he obtained considerable reputation as political economist and parliamentary reformer. He advocated in its pages the cause of free trade long before it was popularized by Richard Cobden and John Bright. He pleaded earnestly in behalf of parliamentary reform, Catholic emancipation and popular education. In 1828 he visited Holland, where the university of Groningen conferred on him the degree of doctor of laws. In the following year he was in Denmark, preparing for the publication of a collection of Scandinavian poetry. Bowring, who had been the trusted friend of Bentham during his life, was appointed his literary executor, and was charged with the task of preparing a collected edition of his works. This appeared in eleven volumes in 1843. Meanwhile Bowring had entered parliament in 1835 as member for Kilmarnock; and in the following year he was appointed head of a government commission to be sent to France to inquire into the actual state of commerce between the two countries. He was engaged in similar investigations in Switzerland, Italy, Syria and some of the German states. The results of these missions appeared in a series of reports laid before the House of Commons. After a retirement of four years he sat in parliament from 1841 till 1849 as member for Bolton. During this busy period he found leisure for literature, and published in 1843 a translation of the *Manuscript of the Queen's Court*, a collection of old Bohemian lyrics, &c. In 1849 he was appointed British consul at Canton, and superintendent of trade in China, a post which he held for four years. After his return he distinguished himself as an advocate of the decimal system, and published a work entitled *The Decimal System in Numbers, Coins and Accounts* (1854). The introduction of the florin as a preparatory step was chiefly due to his efforts. Knighted in 1854, he was again sent the same year to Hong-Kong as governor, invested with the supreme military and naval power. It was during his governorship that a dispute broke out with the Chinese; and the irritation caused by his "spirited" or high-handed policy led to the second war with China. In 1855 he visited Siam, and negotiated with the king a treaty of commerce. After the usual five years of service he retired and received a pension. His last employment by the English government was as a commissioner to Italy in 1861, to report on British commercial relations with the new kingdom. Sir John Bowring subsequently accepted the appointment of minister plenipotentiary and envoy extraordinary from the Hawaiian government to the courts of Europe, and in this capacity negotiated treaties with Belgium, Holland, Italy, Spain and Switzerland. In addition to the works already named he published—*Poetry of the Magyars* (1830); *Czechian Anthology* (1832); *The Kingdom and People of Siam* (1857); a translation of *Peter Schlemihl* (1824); translations from the Hungarian poet, Alexander Petöfi (1866); and various pamphlets. He was elected F.R.S. and F.R.G.S., and received the decorations of several foreign orders of knighthood. He died at Claremont, near Exeter, on the 23rd of November 1872. His valuable collection of coleoptera was presented to the British Museum by his second son, Lewin Bowring, a well-known Anglo-Indian administrator; and his third son, E. A. Bowring, member of

parliament for Exeter from 1868 to 1874, became known in the literary world as an able translator.

Sir John Bowring's *Recollections* were edited by Lewin Bowring (d. 1910) in 1877.

BOWTELL, a medieval term in architecture for a round or corniced moulding; the word is a variant of "boltel," which is probably the diminutive of "bolt," the shaft of an arrow or javelin. A "roving" bowtell is one which passes up the side of a bench end and round a final, the term "roving" being applied to that which follows the line of a curve.

BOWYER, WILLIAM (1663-1737), English printer, was born in 1663, apprenticed to a printer in 1679, made a liveryman of the Stationers' Company in 1700, and nominated as one of the twenty printers allowed by the Star Chamber. He was burned out in the great fire of 1712, but his loss was partly made good by the subscription of friends and fellow craftsmen, as recorded on a tablet in Stationers' Hall, and in 1713 he returned to his Whitefriars shop and became the leading printer of his day. He died on the 27th of December 1737.

His son, **WILLIAM BOWYER** (1690-1777), was born in London on the 19th of December 1699. He was educated at St John's College, Cambridge, and in 1722 became a partner in his father's business. In 1729 he was appointed printer of the votes of the House of Commons, and in 1736 printer to the Society of Antiquaries, of which he was elected a fellow in 1737. In 1737 he took as apprentice John Nichols, who was to be his successor and biographer. In 1761 Bowyer became printer to the Royal Society, and in 1767 printer of the rolls of the House of Lords and the journals of the House of Commons. He died on the 13th of November 1777, leaving unfinished a number of large works and among them the reprint of Domesday Book. He wrote a great many tracts and pamphlets, edited, arranged and published a host of books, but perhaps his principal work was an edition of the New Testament in Greek, with notes. His generous bequests in favour of his own profession are administered by the Stationers' Company, of which he became liveryman in 1738, and in whose hall is his portrait bust and a painting of his father. He was known as "the learned printer."

BOX (Gr. *πίξος*, Lat. *boxus*, box-wood; cf. *πίξ*, a pyx), the most varied of all receptacles. A box may be square, oblong, round or oval, or of an even less normal shape; it usually opens by raising, sliding or removing the lid, which may be fastened by a catch, hasp or lock. Whatever its shape or purpose or the material of which it is fashioned, it is the direct descendant of the chest, one of the most ancient articles of domestic furniture. Its uses are infinite, and the name, preceded by a qualifying adjective, has been given to many objects of artistic or antiquarian interest.

Of the boxes which possess some attraction beyond their immediate purpose the feminine work-box is the commonest. It is usually fitted with a tray divided into many small compartments, for needles, reels of silk and cotton and other necessities of stitchery. The date of its introduction is in considerable doubt, but 17th-century examples have come down to us, with covers of silk, stitched with beads and adorned with embroidery. In the 18th century no lady was without her work-box, and, especially in the second half of that period, much taste and elaborate pains were expended upon the case, which was often exceedingly dainty and elegant. These boxes are ordinarily portable, but sometimes form the top of a table.

But it is as a receptacle for snuff that the box has taken its most distinguished and artistic form. The snuff-box, which is now little more than a charming relic of a disagreeable practice, was throughout the larger part of the 18th century the indispensable companion of every man of birth and breeding. It long survived his sword, and was in frequent use until nearly the middle of the 19th century. The jeweller, the enameller and the artist bestowed infinite pains upon what was quite as often a delicate bijou as a piece of utility; fops and great personages possessed numbers of snuff-boxes, rich and more ordinary, their selection being regulated by their dress and by the relative splendour of the occasion. From the cheapest wood

that was suitable—at one time potato-pulp was extensively used—to a frame of gold encased with diamonds, a great variety of materials was employed. Tortoise-shell was a favourite, and owing to its limpid lustre it was exceedingly effective. Mother-of-pearl was also used, together with silver, in its natural state or gilded. Costly gold boxes were often enriched with enamels or set with diamonds or other precious stones, and sometimes the lid was adorned with a portrait, a classical vignette, or a tiny miniature, often some choice work by an old master. After snuff-taking had ceased to be general it lingered for some time among diplomatists, either because—as Talleyrand explained—they found a ceremonious pinch to be a useful aid to reflection in a business interview, or because monarchs retained the habit of bestowing snuff-boxes upon ambassadors and other intermediaries, who could not well be honoured in any other way. It is, indeed, to the cessation of the habit of snuff-taking that we may trace much of modern lavishness in the distribution of decorations. To be invited to take a pinch from a monarch's snuff-box was a distinction almost equivalent to having one's ear pulled by Napoleon. At the coronation of George IV. of England, Messrs Rundell & Bridge, the court jewellers, were paid £8205 for snuff-boxes for foreign ministers. Now that the snuff-box is no longer used it is collected by wealthy amateurs or deposited in museums, and especially artistic examples command large sums. George, duke of Cambridge (1810-1904), possessed an important collection; a Louis XV. gold box was sold by auction after his death for £2000.

A jewel-box is a receptacle for trinkets. It may take a very modest form, covered in leather and lined with satin, or it may reach the monumental proportions of the jewel cabinets which were made for Marie Antoinette, one of which is at Windsor, and another at Versailles, the work of Scherzinger as cabinet-maker, Degault as miniature-painter, and Thomire as chaser.

A strong-box is a receptacle for money, deeds and securities. Its place has been taken in modern life by the safe. Some of those which have survived, such as that of Sir Thomas Bodley in the Bodleian library, possess locks with an extremely elaborate mechanism contrived in the under-side of the lid.

The knife-box is one of the most charming of the minor pieces of furniture which we owe to the artistic taste and mechanical ingenuity of the English cabinet-makers of the last quarter of the 18th century. Some of the most elegant were the work of Adam, Hepplewhite and Sheraton. Occasionally flat-topped boxes, they were most frequently either vase-shaped, or tall and narrow with a sloping lid necessitated by a series of raised stages for exhibiting the handles of knives and the bowls of spoons. Mahogany and satinwood were the woods most frequently employed, and they were occasionally inlaid with marqueterie or edged with boxwood. These graceful receptacles still exist in large numbers; they are often converted into stationery cabinets.

The Bible-box, usually of the 17th century, but now and again more ancient, probably obtained its name from the fact that it was of a size to hold a large Bible. It often has a carved or incised lid.

The powder-box and the patch-box were respectively receptacles for the powder and the patches of the 18th century; the former was the direct ancestor of the puff-box of the modern dressing-table.

The *thui* is a cylindrical box or case of very various materials, often of pleasing shape or adornment, for holding sewing materials or small articles of feminine use. It was worn on the châteline.

BOXING (*M.E. box*, a blow, probably from Dan. *bask*, a buffet), the art of attack and defence with the fists protected by padded gloves, as distinguished from pugilism, in which the bare fists, or some kind of light gloves affording little moderation of the blow, are employed. The ancient Greeks used a sort of glove in practice, but, although far less formidable than the terrible caestus worn in serious encounters, it was by no means so mild an implement as the modern boxing-glove, the invention of which is traditionally ascribed to Jack Broughton (1705-1789), "the father of British pugilism." In any case gloves were first used

in his time, though only in practice, all prize-fights being decided with bare fists. Broughton, who was for years champion of England, also drew up the rules by which prize-fights were for many years regulated, and no doubt, with the help of the newly invented gloves, imparted instruction in boxing to the young aristocrats of his day. The most popular teacher of the art was, however, John Jackson (1769-1845), called "Gentleman Jackson," who was champion from 1795 to 1800, and who is credited with imparting to boxing its scientific principles, such as countering, accurate judging of distance in hitting, and agility on the feet. Tom Moore, the poet, in his *Memoirs*, asserted that Jackson "made more than a thousand a year by teaching sparring." Among his pupils was Lord Byron, who, when chided for keeping company with a pugilist, insisted that Jackson's manners were "infinitely superior to those of the fellows of the college whom I meet at the high table," and referred to him in the following lines in *Hints from Horace*:—

"And men unpractised in exchanging knocks
Must go to Jackson ere they dare to box."

His rooms in Bond Street were crowded with men of birth and distinction, and when the allied monarchs visited London he was entrusted with the management of a boxing carnival with which they were vastly pleased. In 1814 the Pugilistic Club, the meeting-place of the aristocratic sporting element, was formed, but the high-water mark of the popularity of boxing had been reached, and it declined rapidly, although throughout the country considerable interest continued to be manifested in prize-fighting.

The sport of modern boxing, as distinguished from pugilism, may be said to date from the year 1866, when the public had become disgusted with the brutality and unfair practices of the professional "bruisers," and the laws against prize-fighting began to be more rigidly enforced. In that year the "Amateur Athletic Club" was founded, principally through the efforts of John G. Chambers (1843-1883), who, in conjunction with the 8th marquess of Queensberry, drew up a code of laws (known as the Queensberry Rules) which govern all glove contests in Great Britain, and were also authoritative in America until the adoption of the boxing rules of the Amateur Athletic Union of America. In 1867 Lord Queensberry presented cups for the British amateur championships at the recognized weights.

For the history of pugilism in classic antiquity and an account of modern prize-fighting see PUGILISM. At present two kinds of boxing contests are in vogue, that for a limited number of rounds (as in the amateur championships) and that for endurance, in which the one who cannot continue the fight loses. Endurance contests, which contain the essential element of the old prize-fights, are now indulged in only by professionals. Among amateurs boxing is far less popular than it once was, owing to the importance placed upon brute strength, and the prevailing ambition of the modern boxer to "knock out" his opponent, i.e. reduce him to a state of insensibility. Even in 3-round matches between gentlemen, in which points win, and there is therefore no need to knock an opponent senseless, it is nevertheless a common practice to strike a dazed and reeling adversary a heavy blow with a view to ending the battle at once. During the annual boxing competitions between Oxford and Cambridge more than half the bouts have been known to end in this manner. Undoubtedly the prettiest boxing is seen when two men proficient in the art indulge in a practice bout—or "sparring."

Boxing is the art of hitting without getting hit. The boxers face each other just out of reach and balanced equally on both feet, the left from 10 to 20 in. in advance of the right. The left foot is planted flat on the floor, while the right heel is raised slightly from it. The left side of the body is turned a little towards the opponent and the right shoulder slightly depressed. When the hands are clenched inside the gloves the thumb is doubled over the second and third fingers to avoid a sprain when hitting. The general position of the guard is a matter of individual taste. In the "crouch," affected by many American professionals, the right hip is thrust forward and the body bent over towards the right, while the left arm is kept well stretched

out to keep the opponent at a distance. No good master, however, teaches a beginner any other than the upright position. Some boxers stand with the right foot forward, a practice common in the 18th century, which gives freer play with the right hand but is rather unstable. A boxer should stand lightly on his feet, ready to advance or retreat on the instant, using short steps, advancing with the left foot first and retreating with the right. Attacks are either simple or secondary. Simple attacks consist in straight leads, *i.e.* blows aimed with or without preliminary feints, at some part of the opponent's body or head. All other attacks are either "counters" or returns after a guard or "block." A counter is a lead carried out just as one is attacked, the object being to block (parry) the blow and land on the opponent at the same time. Counters are often carried out in connexion with a side-step, a slip or a crouch. In hitting, a boxer seeks to exert the greatest force at the instant of impact. Blows may be either straight, with or without the weight of the body behind them ("straight from the shoulder" hits); jabs, short blows (usually with the left hand when at close quarters); hooks, or side-blows with bent arm; upper cuts (short swinging blows from beneath to the adversary's chin); chops (short blows from above); punches (usually at close quarters, with the right hand); or swings (round-arm blows, usually delivered with a partial twist of the body to augment the force of the blow). Of the dangerous blows, which often result in a knock-out, or in seriously weakening an adversary, the following may be mentioned:—on the pit of the stomach, called the solar plexus, from the sensitive network of nerves situated there; a blow on the point of the chin, having a tendency slightly to paralyse the brain; a blow under the ear, painful and often resulting in partial helplessness; and one directly over the heart, kidney or liver. As a boxer is allowed ten seconds after being knocked down in which to rise, an experienced ring-fighter will drop on one knee when partially stunned, remaining in that position in order to recover until the referee has counted nine.

Guarding is done with the arm or hand, either open or shut. If a blow is caught or stopped short it is called *blocking*, but a blow may also be shoved aside, or avoided altogether by *slipping*, *i.e.* moving the head quickly to one side, or by ducking and allowing the adversary's swing to pass harmlessly over the head. Still another method of avoiding a blow without guarding is to bend back the head or body so as narrowly to escape the opponent's glove.

The rules of the Amateur Boxing Association (founded 1884) contain the following provisions. "An amateur is one who has never competed for a money prize or staked bet with or against a professional for any prize, except with the express sanction of the A.B.A., and who has never taught, pursued or assisted in the practice of athletic exercises as a means of obtaining a livelihood." The ring shall be roped and between 12 and 24 ft. square. No spikes shall be worn on shoes. Boxers are divided into the following classes by weight:—Bantam, not exceeding 8 st. 4 lb (116 lb); Feather, not exceeding 9 st. (126 lb); Light, not exceeding 10 st. (140 lb); Middle, not exceeding 12 st. 4 lb (158 lb); and Heavy, any weight above. There shall be two judges, a referee and a timekeeper. The votes of the judges decide the winner of a bout, unless they disagree, in which case the referee has the deciding vote. In case of doubt he may order an extra round of two minutes' duration. Each match is for three rounds, the first two lasting three minutes and the third four, with one minute rest between the rounds. A competitor failing to come up at the call of time loses the match. When a competitor draws a bye he must box for a specified time with an opponent chosen by the judges. A competitor is allowed one assistant (second) only, and no advice or coaching during the progress of a round is permitted. Unless one competitor is unable to respond to the call of time, or is obliged to stop before the match is over, the judges decide the winner by *points*, which are for attack, comprising successful hits cleanly delivered, and defence, comprising guarding, slipping, ducking, counter-hitting and getting away in time to avoid a return. When the points are equal the decision is given in favour of the boxer who has done the most leading, *i.e.*

has been the more aggressive. Fouls are hitting below the belt, kicking, hitting with the open hand, the side of the hand, the wrist, elbow or shoulder, wrestling or "roughing" on the ropes, *i.e.* unnecessary shouldering and jostling.

The boxing rules of the American Amateur Athletic Association differ slightly from the British. The ring is roped but must be from 16 to 24 ft. square. Gloves must not be worn more than 8 oz. in weight. The recognized classes by weight are: Bantam, 105 lb and under; Feather, 115 lb and under; Light, 135 lb and under; Welter, 145 lb and under; Middle, 158 lb and under; and Heavy, over 158 lb. The rules for officials and rounds are identical with the British, except that only in final bouts does the last round last four minutes. Two "seconds" are allowed. The rules for points and fouls coincide with the British. The amateur rules are very strict, and any one who competes in a boxing contest of more than four rounds is suspended from membership in the Athletic Association.

Glossary of terms not mentioned above:—Break away, to get away from the adversary, usually a command from the referee when the men clinch. *Break ground*, retire diagonally to right or left. *Calch-weight*, any weight. *Corners*, the opposite angles of the square "ring," in which the boxers rest between the rounds. *Cross-counter*, a blow in which the right or left arm crosses that of the adversary as he leads off; the arm is slightly curved to get round that of the opponent but is straightened at the moment of impact. *Clinching*, grappling after an exchange of blows; when breaking from a clinch one tries to pin the adversary's hands in order to prevent his hitting at close quarters. *Drawing* an opponent, enticing him by leaving an apparent opening into making an attack for which a counter is prepared. *Fiddling*, forward and back movements of the arms at the beginning of a round, a part of sparring for an opening. *Foot-work*, the manner in which a boxer uses his feet. *Finishing*, boxing at very close quarters. *Mark*, the pit of the stomach. *Side-step*, springing quickly to one side to avoid a blow, the movement being usually followed up by a counter attack. *Timing*, a blow delivered on the enemy's preparation of an attack of his own, but more quickly.

See *Boxing*, by R. Allanson-Winn (Isthmian Library, London, 1897); *Boxing*, by Wm. Elder (Spalding's Athletic Library, New York, 1902) (these two books are excellent for the technicalities of boxing). The article "Boxing," by B. Jno. Angle and G. W. Barroll, in the *Encyclopaedia of Sport*; *Boxing*, by J. C. Trotter (Oval Series, London, 1896); *Fencing, Boxing and Wrestling*, in the Badminton Library (London, 1892).

FRENCH BOXING (*la boxe française*) dates from about 1830. It is more like the ancient Greek *pankration* (see PUGILISM) than is British boxing, as not only striking with the fists, but also kicking with the feet, butting with the head and wrestling are allowed. It is a development of the old sport of *savate*, in which the feet, and not the hands, were used in attack. Lessons in *savate*, which was practised especially by roughs, were usually given in some low resort, and there were no respectable teachers. While Paris was restricted to *savate*, another sport, called *chaousson* or *jeu marseillais*, was practised in the south of France, especially among the soldiers, in which blows of the fist as well as kicks were exchanged, and the kicks were given higher than in *savate*, in the stomach or even the face. It was an excellent exercise, but could hardly be reckoned a serious means of defence, for the high kicks usually fell short, and the upward blows of the fist could not be compared with the terrible sledge-hammer blows of the English boxers. Alexandre Dumas père says that Charles Lecour first conceived the idea of combining English boxing with *savate*. For this purpose he went to England, and took lessons of Adams and Smith, the London boxers. He then returned to Paris, about 1852, and opened a school to teach the sport since called *la boxe française*. Around him, and two provincial instructors who came to Paris about this time with similar ideas, there grew up a large number of sportsmen, who between 1845 and 1855 brought French boxing to its highest development. Among others who gave public exhibitions was Lecour's brother Hubert, who although rather undersized, was quick as lightning, and had an English blow and a French kick that were truly terrible. Charles Ducros was another whose style of boxing, more in the English fashion, but with low kicks about his opponent's shins, made a name for himself. Later came Vigneron, a "strong man," whose style, though slow, was severe in its punishment. About 1856 the police interfered in these fights, and Lecour and Vigneron had to cease giving public

exhibitions and devote themselves to teaching. Towards 1861 a new boxer, J. Charlemont, was not only very clever with his fists and feet, but an excellent teacher, and the author of a treatise on the art. Lecour, Vignerone and Charlemont may be said to have created the *boxe française*, which, for defence at equal weights, the French claim to be better than the English.

See *L'Art de la boxe française et de la course*, by J. Charlemont (Paris, 1899); *The French Method of the Noble Art of Self Defence*, by Georges d'Amoric (London, 1898).

BOXWOOD, the wood obtained from the genus *Buxus*, the principal species being the well-known tree or shrub, *B. sempervirens*, the common box, in general use for borders of garden walks, ornamental parterres, &c. The other source of the ordinary boxwood of commerce is *B. balearica*, which yields the variety known as Turkey boxwood. The common box is grown throughout Great Britain (perhaps native in the chalk-hills of the south of England), in the southern part of the European continent generally, and extends through Persia into India, where it is found growing on the slopes of the western Himalayas. There has been much discussion as to whether it is a true native of Britain. Writing more than 200 years ago, John Ray, the author of the important *Historia Plantarum*, says, "The Box grows wild on Boxhill, hence the name; also at Boxwell, on the Cotteswood Hills in Gloucestershire, and at Boxley in Kent. . . . It grows plentifully on the chalk hills near Dunstable." On the other hand the box is not wild in the Channel Islands, and in the north of France, Holland and Belgium is found mainly in hedgerows and near cultivation, and it may have been one of the many introductions owed to the Romans. Only a very small proportion of the wood suitable for industrial uses is now obtained in Great Britain. The box is a very slow-growing plant, adding not more than 1½ or 2 in. to its diameter in twenty years, and on an average attaining only a height of 16 ft., with a mean diameter of 10½ in. The leaves of this species are small, oval, leathery in texture and of a deep glossy green colour. *B. balearica* is a tree of considerable size, attaining to a height of 80 ft., with leaves three times larger than those of the common box. It is a native of the islands of the Mediterranean, and grows in Turkey, Asia Minor, and around the shores of the Black Sea, and is supposed to be the chief source of the boxwood which comes into European commerce by way of Constantinople. The wood of both species possesses a delicate yellow colour; it is very dense in structure and has a fine uniform grain, which has given it unique value for the purposes of the wood-engraver. A large amount is used in the manufacture of measuring rules, various mathematical instruments, flutes and other musical instruments, as well as for turning into many minor articles, and for inlaying, and it is a favourite wood for small carvings. The use of boxwood for turnery and musical instruments is mentioned by Pliny, Virgil and Ovid.

BOYACÁ, or **BOYACÁ**, an inland department of Colombia, bounded by the departments of Santander and Cundinamarca on the N., W. and S., and the republic of Venezuela on the E., and having an area of 33,321 sq. m., including the Casanare territory. Pop. (1899, estimate) 508,940. The department is very mountainous, heavily forested and rich in minerals. The famous Muso emerald mines are located in the western part of Boyacá. The capital, Tunja (pop. 1902, 10,000), is situated in the Eastern Cordilleras, 9054 ft. above sea-level, and has a cool, temperate climate, though only 5½° N. of the equator. It was an important place in colonial times, and occupies the site of one of the Indian towns of this region (Hunsa), which had acquired a considerable degree of civilization before the discovery of America. Other towns of note in the department are Chiquinquirá (20,000), Moniquira (18,000), Sogamoso (10,787), and Boyacá (7000), where on the 7th of August 1819 Bolívar defeated the Spanish army and secured the independence of New Granada.

BOYAR (Russ. *boyarin*, plur. *boyare*), a dignity of Old Russia conterminous with the history of the country. Originally the boyars were the intimate friends and confidential advisers of the Russian prince, the superior members of his *drushina* or bodyguard, his comrades and champions. They were divided into classes according to rank, most generally determined by

personal merit and service. Thus we hear of the "oldest," "elder" and the "younger" boyars. At first the dignity seems to have been occasionally, but by no means invariably, hereditary. At a later day the boyars were the chief members of the prince's *duma*, or council, like the *senatores* of Poland and Lithuania. Their further designation of *luchskie lyudi* or "the best people" proves that they were generally richer than their fellow subjects. So long as the princes, in their interminable struggles with the barbarians of the Steppe, needed the assistance of the towns, "the best people" of the cities and of the *drushinas* proper mingled freely together both in war and commerce; but after Yaroslav's crushing victory over the Petchenegs in 1036 beneath the walls of Kiev, the two classes began to draw apart, and a political and economical difference between the members of the princely *drushina* and the aristocracy of the towns becomes discernible. The townsmen devote themselves henceforth more exclusively to commerce, while the *drushina* asserts the privileges of an exclusively military caste with a primary claim upon the land. Still later, when the courts of the northern grand dukes were established, the boyars appear as the first grade of a full-blown court aristocracy with the exclusive privilege of possessing land and serfs. Hence their title of *dvoryane* (courtiers), first used in the 12th century. On the other hand there was no distinction, as in Germany, between the *Dienst Adel* (nobility of service) and the simple *Adel*. The Russian boyardom had no corporate or class privileges, (1) because their importance was purely local (the dignity of the principality determining the degree of dignity of the boyars), (2) because of their inalienable right of transmigration from one prince to another at will, which prevented the formation of a settled aristocracy, and (3) because birth did not determine but only facilitated the attainment of high rank, e.g. the son of a boyar was not a boyar born, but could more easily attain to boyardom, if of superior personal merit. It was reserved for Peter the Great to transform the *boyarstvo* or boyardom into something more nearly resembling the aristocracy of the West.

See Alexander Markevich, *The History of Rank-priority in the Realm of Muscovy in the 15th-18th Centuries* (Rusn.) (Odessa, 1888); V. Klyuchevsky, *The Boyar Duma of Ancient Russia* (Rusn.) (Moscow, 1888). (R. N. B.)

BOY-BISHOP, the name given to the "bishop of the boys" (*episcopus puerorum* or *innocentium*, sometimes *episcopus scholariorum* or *choreslarum*), who, according to a custom very wide-spread in the middle ages, was chosen in connexion with the festival of Holy Innocents. For the origin of the curious authority of the boy-bishop and of the rites over which he presided, see **FOOLS, FEAST OF**. In England the boy-bishop was elected on December 6, the feast of St Nicholas, the patron of children, and his authority lasted till Holy Innocents' day (December 28). The election made, the lad was dressed in full bishop's robes with mitre and crozier and, attended by comrades dressed as priests, made a circuit of the town blessing the people. At Salisbury the boy-bishop seems to have actually had ecclesiastical patronage during his episcopate, and could make valid appointments. The boy and his colleagues took possession of the cathedral and performed all the ceremonies and offices except mass. Originally, it seems, confined to the cathedrals, the custom spread to nearly all the parishes. Several ecclesiastical councils had attempted to abolish or to restrain the abuses of the custom, before it was prohibited by the council of Basel in 1431. It was, however, too popular to be easily suppressed. In England it was abolished by Henry VIII. in 1542, revived by Mary in 1552 and finally abolished by Elizabeth. On the continent it survived longest in Germany, in the so-called *Gregoriusfest*, said to have been founded by Gregory IV. in 838 in honour of St Gregory, the patron of schools. A school-boy was elected bishop, duly vested, and, attended by two boy-deacons and the town clergy, proceeded to the parish church, where, after a hymn in honour of St Gregory had been sung, he preached. At Meiningen this custom survived till 1799.

See Brand, *Pop. Antiquities of Great Britain* (1905); Gasquet, *Parish Life in Medieval England* (1906); Du Cange, *Glossarium* (London, 1884), s.s. "Episcopus puerorum."

BOYCE, WILLIAM (1710-1770), English musical composer, the son of a cabinet-maker, was born in London on the 7th of February 1710. As a chorister in St Paul's he received his early musical education from Charles King and Dr Maurice Greene, and he afterwards studied the theory of music under Dr Pepusch. In 1734, having become organist of Oxford chapel, Vere Street, Cavendish Square, he set Lord Lansdowne's masque of *Peleus and Thetis* to music. In 1736 he left Oxford chapel and was appointed organist of St Michael's church, Cornhill, and in the same year he became composer to the chapel royal, and wrote the music for John Lockman's oratorio *David's Lamentation over Saul and Jonathan*. In 1737 he was appointed to conduct the meetings of the three choirs of Gloucester, Worcester and Hereford. In 1743 was written the serenata *Solomon*, in which occurs the favourite song "Softly rise, O southern breeze." In 1749 he received the degree of doctor of music from the university of Cambridge, as an acknowledgment of the merit of his setting of the ode performed at the installation of Henry Pelham, duke of Newcastle, as chancellor; and in this year he became organist of All-hallows the Great and Less, Thames Street. A musical setting to *The Chapelet*, an entertainment by Moses Mendez, was Boyce's most successful achievement in this year. In 1750 he wrote songs for Dryden's *Secular Masque* and in 1751 set another piece (*The Shepherd's Lottery*) by Mendez. He became master of the king's band in succession to Greene in 1757, and in 1758 he was appointed principal organist to the chapel royal. As an ecclesiastical composer Boyce ranks among the best representatives of the English school. His two church services and his anthems, of which the best specimens are *By the Waters of Babylon* and *O, Where shall Wisdom be found*, are frequently performed. It should also be remembered that he wrote additional accompaniments and choruses for Purcell's *Te Deum* and *Jubilate*, which the earlier musician had composed for the St Cecilia's day of 1694. Boyce did this in his capacity of conductor at the annual festivals of the Sons of the Clergy at St Paul's cathedral, an office which he had taken in succession to Greene. His twelve trios for two violins and a bass were long popular. One of his most valuable services to musical art was his publication in three volumes quarto of a work on *Cathedral Music*. The collection had been begun by Greene, but it was mainly the work of Boyce. The first volume appeared in 1760 and the last in 1778. On the 7th of February 1779 Boyce died from an attack of gout. He was buried under the dome of St Paul's cathedral.

BOYCOTT, the refusal and incitement to refusal to have commercial or social dealings with any one on whom it is wished to bring pressure. As merely a form of "sending to Coventry" or (in W. E. Gladstone's phrase) "exclusive dealing," boycotting may be, from a legal point of view, unassailable, and as such has frequently been justified by its original political inventors. But in practice it has usually taken the form of what is undoubtedly an illegal conspiracy to injure the person, property or business of another by unwarrantably putting pressure on all and sundry to withdraw from him their social or business intercourse. The word was first used in Ireland, and was derived from the name of Captain Charles Cunningham Boycott (1832-1897), agent for the estates of the earl of Erne in Co. Mayo. For refusing in 1880 to receive rents at figures fixed by the tenants, Captain Boycott had his life threatened, his servants compelled to leave him, his fences torn down, his letters intercepted and his food supplies interfered with. It took a force of 900 soldiers to protect the Ulster Orangemen ("Emergency Men") who succeeded finally in getting in his crops. He was hooted and mobbed in the streets, and hanged and burnt in effigy. The system of boycotting was an essential part of the Irish Nationalist "Plan of Campaign," and was dealt with under the Crimes Act of 1887. The term soon came into common English use, and was speedily adopted by the French, Germans, Dutch and Russians. In the United States this method of "persuasion" was taken up by the trade unions about 1886, an employer who refused their demands being brought to terms by a combination

to refuse to buy his product or do his work, or to deal with any who did. Various cases have occurred in America in which labour organizations have pronounced such a boycott against a firm; and its illegal nature has been established in the law-courts, notably in the case of the Bucks Stove Company v. The American Federation of Labor (1907) in the Supreme Court of the district of Columbia, and in a suit against the Hatters' Union (February 1908) in the U.S. Supreme Court. A boycott has also been held by the U.S. Supreme Court to be a violation of the Sherman Anti-Trust law.

BOYD, ANDREW KENNEDY HUTCHINSON (1825-1890), Scottish author and divine, was born at Auchinleck manse in Ayrshire on the 3rd of November 1825. He studied at King's College, London, and at the Middle Temple, with the idea of practising at the English bar. Returning to Scotland, however, he entered Glasgow University and there qualified for the Scottish ministry, being licensed as a preacher by the presbytery of Ayr. He served in succession the parishes of Newton-on-Ayr, Kirkpatrick-Irongray near Dumfries, St Bernard's, Edinburgh, and finally, in 1865, became minister of the first charge at St Andrews. Here he advocated an improved ritual in the Scottish church, his action resulting in the appointment by the general assembly of a committee, with Boyd as convener, to prepare a new hymnal. In 1890 he was appointed moderator of the general assembly, and fulfilled the duties of the position with admirable dignity and tact. He died at Bournemouth on the 1st of March 1890. Dr Boyd was a very famous preacher and talker, and his desultory essays have very much of the charm of his conversation. Among his numerous publications may be specially mentioned the two works (each in three series), *Recreations of a Country Parson* (1859, 1861 and 1878), and *Graver Thoughts of a Country Parson* (1862-1865 and 1875); he also wrote *Twenty-five Years at St Andrews* (1892), and *St Andrews and Elsewhere* (1894). He was familiarly known to the public as a writer by his initials "A.K.H.B."

BOYD, ROBERT BOYD, LORD (d. c. 1470), Scottish statesman, was a son of Sir Thomas Boyd (d. 1439), and belonged to an old and distinguished family, one member of which, Sir Robert Boyd, had fought with Wallace and Robert Bruce. Boyd, who was created a peer about 1454, was one of the regents of Scotland during the minority of James III., but, in 1466, with some associates he secured the person of the young king and was appointed his sole governor. As ruler of Scotland he was instrumental in reforming some religious foundations; he arranged the marriage between James III. and Margaret, daughter of Christian I., king of Denmark and Norway, and secured the cession of the Orkney Islands by Norway. However, when in 1467 he obtained the offices of chamberlain and justiciary for himself, and the hand of the king's sister Mary, with the title of earl of Arran for his eldest son Thomas, his enemies became too strong for him, and he was found guilty of treason and sentenced to death. He escaped to England, and the date of his death is unknown. His brother and assistant, Sir Alexander Boyd, was beheaded on the 22nd of November 1469.

Boyd's son Thomas, earl of Arran, was in Denmark when his father was overthrown. However, he fulfilled his mission, that of bringing the king's bride, Margaret, to Scotland, and then, warned by his wife, escaped to the continent of Europe. He is mentioned very eulogistically in one of the Paston Letters, but practically nothing is known of his subsequent history.

Lord Boyd's grandson Robert (d. c. 1550), a son of Alexander Boyd, was confirmed in the possession of the estates and honours of his grandfather in 1549, and is generally regarded as the 3rd Lord Boyd. His son Robert, 4th Lord Boyd (d. 1590), took a prominent part in Scottish politics during the troubled time which followed the death of James V. in 1542. At first he favoured the reformed religion, but afterwards his views changed and he became one of the most trusted advisers of Mary, queen of Scots, whom he accompanied to the battle of Langside in 1568. During the queen's captivity he was often employed on diplomatic errands; he tried to stir up insurrections in her favour, and he was suspected of participation in the murder

of the regent Murray. He enjoyed a high and influential position under the regent James Douglas, earl of Morton, but was banished in 1583 for his share in the seizure of King James VI., a plot known as the Raid of Ruthven. He retired to France, but was soon allowed to return to Scotland. He died on the 3rd of January 1590.

William, 8th or 9th Lord Boyd (d. 1692), was created earl of Kilmarnock in 1661, and this nobleman's grandson William, the 3rd earl (d. 1717), was a partisan of the Hanoverian kings and fought for George I. during the rising of 1715. His son William, the 4th earl (1704-1746), was educated in the same principles, but in 1745, owing either to a personal affront or to the influence of his wife or to his straitened circumstances, he deserted George II. and joined Charles Edward, the Young Pretender. The 4th earl fought at Falkirk and Culloden, where he was made prisoner, and was beheaded on the 18th of August 1746. The title of earl of Kilmarnock is now merged in that of earl of Erroll.

BOYD, ZACHARY (1585?-1653), Scottish divine, was educated at the universities of Glasgow and St Andrews. He was for many years a teacher in the Protestant college of Saumur in France, but returned to Scotland in 1621, to escape the Huguenot persecution. In 1623 he was appointed minister of the Barony church in Glasgow, and he was rector of the university in 1634, 1635 and 1645. He bequeathed to the university the half of his fortune, a sum amounting to £20,000 Scots, besides his library and twelve volumes of MSS. His poetical compositions, though often eccentric, have some merit. The common statement that he made the printing of his metrical version of the Gospels and other Biblical narratives a condition of the reception of his grant to the university is a mistake. In later years he was a staunch Covenanter, and though for a time opposed to Oliver Cromwell, afterwards became friendly with him. His best-known works are *The Battel of the Soul in Death* (1629), of which a new edition, with a biography by G. Neil, was published in Glasgow in 1831; *Zion's Flowers*—often called "Boyd's Bible" (1644); *Four Letters of Comfort* (1640, reprinted, Edinburgh, 1878).

BOYDELL, JOHN (1719-1804), English alderman and publisher, was born at Dorrington, and at the age of twenty-one came to London and was apprenticed for seven years to an engraver. In 1746 he published a volume of views in England and Wales, and started in business as a print-seller. By his good taste and liberality he managed to secure the services of the best artists, and his engravings were executed with such skill that his business became extensive and lucrative. He succeeded in his plan of a Shakespeare gallery, and obtained the assistance of the most eminent painters of the day, whose contributions were exhibited publicly for many years. The engravings from these paintings form a splendid companion volume to his large illustrated edition of Shakespeare's works. Towards the close of his life Boydell sustained severe losses through the French Revolution, and was compelled to dispose of his Shakespeare gallery by lottery. Boydell had previously become an alderman, and rose to be lord mayor of London.

BOYER, ALEXIS (1757-1833), French surgeon, was born on the 1st of March 1757 at Uzèrches (Corrèze). The son of a tailor, he obtained his first medical knowledge in the shop of a barber-surgeon. Removing to Paris he had the good fortune to attract the notice of Antoine Louis (1723-1792) and P. J. Desault (1744-1795); and his perseverance, anatomical skill and dexterity as an operator, became so conspicuous, that at the age of thirty-seven he obtained the appointment of second surgeon to the Hôtel Dieu of Paris. On the establishment of the École de Santé he gained the chair of operative surgery, but soon exchanged it for the chair of clinical surgery. In 1805 Napoleon nominated him imperial family surgeon, and, after the brilliant campaigns of 1806-7, conferred on him the legion of honour, with the title of baron of the empire and a salary of 25,000 francs. On the fall of Napoleon the merits of Boyer secured him the favour of the succeeding sovereigns of France, and he was consulting surgeon to Louis XVIII., Charles X., and Louis Philippe. In 1825 he succeeded J. F. L. Deschamps (1740-1824) as surgeon-in-chief to the Hôpital de la Charité, and was chosen a member of

the Institute. He died in Paris on the 23rd of November 1833. Perhaps no French surgeon of his time thought or wrote with greater clearness and good sense than Boyer; and while his natural modesty made him distrustful of innovation, and somewhat tenacious of established modes of treatment, he was as judicious in his diagnosis and as cool and skilful in manipulating, as he was cautious in forming his judgment on individual cases. His two great works are:—*Traité complet de l'anatomie* (in 4 vols., 1797-1799), of which a fourth edition appeared in 1815; and *Traité des maladies chirurgicales et des opérations qui leur conviennent* (in 11 vols., 1814-1826), of which a new edition in 7 vols. was published in 1844-1853, with additions by his son, Philippe Boyer (1801-1858).

BOYER, JEAN PIERRE (1776-1850), president of the republic of Haiti, a mulatto, was born at Port au-Prince on the 28th of February 1776. He received a good education in France, and, returning to St Domingo, joined the army in 1792. In 1794 he was already in command of a battalion, and fought with distinction under General Rigaud against the English. The negroinsurrection under Toussaint l'Ouverture, which was directed against the mulattoes as well as the whites, ultimately forced him to take refuge in France. He was well received by Napoleon, and in 1802 obtained a commission in Leclerc's expedition. Being opposed to the reinstatement of slavery, he turned against the French and succeeded in producing an alliance between the negroes and mulattoes by which they were driven from the island. Dessalines, a negro, was proclaimed king, but his cruelty and despotism were such that Boyer combined with A. A. S. Pétion and General Christophe to overthrow him (1806). Christophe now seized the supreme power, but Pétion set up an independent republic in the southern part of the island, with Boyer as commander-in-chief. Christophe's efforts to crush this state were defeated by Boyer's gallant defence of Port-au-Prince, and a series of brilliant victories, which, on Pétion's death in 1818, led to Boyer's election as president. Two years later the death of Christophe removed his only rival, and he gained almost undisputed possession of the whole island. During his presidency Boyer did much to set the finances and the administration in order, and to encourage the arts and sciences, and in 1825 obtained French recognition of the independence of Haiti, in return for a payment of 150,000 francs. The weight of this debt excited the greatest discontent in Haiti. Boyer was able to carry on his government for some years longer, but in March 1843 a violent insurrection overthrew his power and compelled him to take refuge in Jamaica. He resided there till 1848, when he removed to Paris, where he died in 1850.

See Wallace, *Précis historique des négociations entre la France et Saint-Domingue, avec une notice biographique sur le général Boyer* (Paris, 1826).

BOYLE, JOHN J. (1851-), American sculptor, was born in New York City. He studied in the Pennsylvania Academy of Fine Arts, Philadelphia, and in the École des Beaux Arts, Paris. He is particularly successful in the portrayal of Indians. Among his principal works are: "Stone Age," Fairmount Park, Philadelphia; "The Alarm," Lincoln Park, Chicago; and, a third study in primitive culture, the two groups, "The Savage Age" at the Pan-American Exposition of 1901. His work also includes the seated "Franklin," in Philadelphia; and "Bacon" and "Plato" in the Congressional library, Washington, D.C.

BOYLE, ROBERT (1627-1691), English natural philosopher, seventh son and fourteenth child of Richard Boyle, the great earl of Cork, was born at Lismore Castle, in the province of Munster, Ireland, on the 25th of January 1627. While still a child he learned to speak Latin and French, and he was only eight years old when he was sent to Eton, of which his father's friend, Sir Henry Wotton, was then provost. After spending over three years at the college, he went to travel abroad with a French tutor. Nearly two years were passed in Geneva; visiting Italy in 1641, he remained during the winter of that year in Florence, studying the "paradoxes of the great star-gazer" Galileo, who died within a league of the city early in 1642. Returning to

England in 1644 he found that his father was dead and had left him the manor of Stalbridge in Dorsetshire, together with estates in Ireland. From that time he gave up his life to study and scientific research, and soon took a prominent place in the band of inquirers, known as the "Invisible College," who devoted themselves to the cultivation of the "new philosophy." They met frequently in London, often at Gresham College; some of the members also had meetings at Oxford, and in that city Boyle went to reside in 1654. Reading in 1657 of Otto von Guericke's air-pump, he set himself with the assistance of Robert Hooke to devise improvements in its construction, and with the result, the "machina Boyleana" or "Pneumatical Engine," finished in 1659, he began a series of experiments on the properties of air. An account of the work he did with this instrument was published in 1660 under the title *New Experiments Physico-Mechanical touching the spring of air and its effects*. Among the critics of the views put forward in this book was a Jesuit, Franciscus Linus (1595-1675), and it was while answering his objections that Boyle enunciated the law that the volume of a gas varies inversely as the pressure, which among English-speaking peoples is usually called after his name, though on the continent of Europe it is attributed to E. Mariotte, who did not publish it till 1676. In 1663 the "Invisible College" became the "Royal Society of London for improving natural knowledge," and the charter of incorporation granted by Charles II. named Boyle a member of the council. In 1680 he was elected president of the society, but declined the honour from a scruple about oaths. In 1668 he left Oxford for London where he resided at the house of his sister, Lady Ranelagh, in Pall Mall. About 1669 his health, never very strong, began to fail seriously and he gradually withdrew from his public engagements, ceasing his communications to the Royal Society, and advertising his desire to be excused from receiving guests, "unless upon occasions very extraordinary," on Tuesday and Friday forenoon, and Wednesday and Saturday afternoon. In the leisure thus gained he wished to "recruit his spirits, range his papers," and prepare some important chemical investigations which he proposed to leave "as a kind of Hermetic legacy to the studious disciples of that art," but of which he did not make known the nature. His health became still worse in 1691, and his death occurred on the 30th of December of that year, just a week after that of the sister with whom he had lived for more than twenty years. He was buried in the churchyard of St Martin's in the Fields, his funeral sermon being preached by his friend Bishop Burnet.

Boyle's great merit as a scientific investigator is that he carried out the principles which Bacon preached in the *Novum Organum*. Yet he would not avow himself a follower of Bacon or indeed of any other teacher: on several occasions he mentions that in order to keep his judgment as unprepossessed as might be with any of the modern theories of philosophy, till he was "provided of experiments" to help him judge of them, he refrained from any study of the Atomical and the Cartesian systems, and even of the *Novum Organum* itself, though he admits to "transiently consulting" them about a few particulars. Nothing was more alien to his mental temperament than the spinning of hypotheses. He regarded the acquisition of knowledge as an end in itself, and in consequence he gained a wider outlook on the aims of scientific inquiry than had been enjoyed by his predecessors for many centuries. This, however, did not mean that he paid no attention to the practical application of science nor that he despised knowledge which tended to use. He himself was an alchemist; and believing the transmutation of metals to be a possibility, he carried out experiments in the hope of effecting it: and he was instrumental in obtaining the repeal, in 1689, of the statute of Henry IV. against multiplying gold and silver. With all the important work he accomplished in physics—the enunciation of Boyle's law, the discovery of the part taken by air in the propagation of sound, and investigations on the expansive force of freezing water, on specific gravities and refractive power, on crystals, on electricity, on colour, on hydrostatics, &c.—chemistry was his peculiar and favourite study. His first book on the subject was *The Sceptical Chemist*, published in 1661,

in which he criticized the "experiments whereby vulgar Spagyrist are wont to endeavour to evince their Salt, Sulphur and Mercury to be the true Principles of Things." For him chemistry was the science of the composition of substances, not merely an adjunct to the arts of the alchemist or the physician. He advanced towards the modern view of elements as the undecomposable constituents of material bodies; and understanding the distinction between mixtures and compounds, he made considerable progress in the technique of detecting their ingredients, a process which he designated by the term "analysis." He further supposed that the elements were ultimately composed of particles of various sorts and sizes, into which, however, they were not to be resolved in any known way. Applied chemistry had to thank him for improved methods and for an extended knowledge of individual substances. He also studied the chemistry of combustion and of respiration, and made experiments in physiology, where, however, he was hampered by the "tenderness of his nature" which kept him from anatomical dissections, especially of living animals, though he knew them to be "most instructing."

Besides being a busy natural philosopher, Boyle devoted much time to theology, showing a very decided leaning to the practical side and an indifference to controversial polemics. At the Restoration he was favourably received at court, and in 1665 would have received the provostship of Eton, if he would have taken orders; but this he refused to do, on the ground that his writings on religious subjects would have greater weight coming from a layman than a paid minister of the Church. He spent large sums in promoting the spread of Christianity, contributing liberally to missionary societies, and to the expenses of translating the Bible or portions of it into various languages. By his will he founded the Boyle lectures, for proving the Christian religion against "notorious infidels, viz. atheists, theists, pagans, Jews and Mahomedans," with the proviso that controversies between Christians were not to be mentioned.

In person Boyle was tall, slender and of a pale countenance. His constitution was far from robust, and throughout his life he suffered from feeble health and low spirits. While his scientific work procured him an extraordinary reputation among his contemporaries, his private character and virtues, the charm of his social manners, his wit and powers of conversation, endeared him to a large circle of personal friends. He was never married. His writings are exceedingly voluminous, and his style is clear and straightforward, though undeniably prolix.

The following are the more important of his works in addition to the two already mentioned:—*Considerations touching the Usefulness of Experimental Natural Philosophy* (1663); followed by a second part in 1671; *Experiments and Considerations upon Colours, with Observations on a Diamond that Shines in the Dark* (1663); *New Experiments and Observations upon Cold* (1665); *Hydrostatical Paradoxes* (1666); *Origin of Forms and Qualities according to the Corpuscular Philosophy* (1666); a continuation of his work on the spring of air (1669); tracts about the *Cosmical Qualities of Things*, the *Temperature of the Subterranean and Submarine Regions*, the *Bottom of the Sea*, &c. with an *Introduction to the History of Particular Qualities* (1670); *Origin and Virtues of Gems* (1672); *Essays of the strange Subtlety, great Efficacy, determinate Nature of Effluvioms* (1673); two volumes of tracts on the *Saltness of the Sea*, the *Hidden Qualities of the Air*, *Cold*, *Celestial Magnets*, *Animadversions on Hobbes's Problemata de Vacuo* (1674); *Experiments and Notes about the Mechanical Origin or Production of Particular Qualities*, including some notes on electricity and magnetism (1676); *Observations upon an artificial Substance that Shines without any Preceding Illustration* (1678); the *Aerial Noctiluca* (1680); *New Experiments and Observations upon the Icy Noctiluca* (1682); a further continuation of his work on the air; *Memoirs for the Natural History of the Human Blood* (1684); *Short Memoirs for the Natural Experimental History of Mineral Waters* (1685); *Medicina Hydrostatica* (1690); and *Experimenta et Observationes Physicæ* (1691). Among his religious and philosophical writings were:—*Seraphic Love*, written in 1648, but not published till 1660; an *Essay upon the Style of the Holy Scriptures* (1663); *Occasional Reflections upon Several Subjects* (1665), which was ridiculed by Swift in *A Pious Meditation upon a Broomstick*, and by Butler in *An Occasional Reflection on Dr Charlton's Feeling a Dog's Pulse at Gresham College*; *Excellence of Theology compared with Natural Philosophy* (1664); *Some Considerations about the Reconcilableness of Reason and Religion*, with a *Discourse about the Possibility of the Resurrection* (1675); *Discourse*

of *Things above Reason* (1681); *High Veneration Man owes to God* (1685); *A Free Inquiry into the vulgarly received Notion of Nature* (1686); and the *Christian Virtuoso* (1690). Several other works appeared after his death, among them *The General History of the Air designed and begun* (1692); a "collection of choice remedies," *Medicinal Experiments* (1692-1698); and *A Free Discourse against Customary Swearing* (1695). An incomplete and unauthorized edition of Boyle's works was published at Geneva in 1677, but the first complete edition was that of Thomas Birch, with a life, published in 1744, in five folio volumes, a second edition appearing in 1772 in six volumes, 4to. Boyle bequeathed his natural history collections to the Royal Society, which also possesses a portrait of him by the German painter, Friedrich Kerseboom (1632-1690).

BOYLE, a market town of Co. Roscommon, Ireland, in the north parliamentary division, on the Sligo line of the Midland Great Western railway, 106½ m. N.W. by W. from Dublin and 28 m. S. by E. from Sligo. Pop. (1901) 2477. It is beautifully situated on both banks of the river Boyle, an affluent of the Shannon, between Lough Gara and Key. Three bridges connect the two parts of the town. There is considerable trade in agricultural produce. To the north of the town stand the extensive ruins of a Cistercian abbey founded in 1161, including remains of a cruciform church, with a fine west front, and Norman and Transitional arcades with carving of very beautiful detail. The offices of the monastery are well preserved, and an interesting feature is seen in the names carved on the door of the lodge, attributed in Cromwell's soldier, who occupied the buildings. Neighbouring antiquities are Asselyn church near Lough Key, and a large cromlech by the road towards Lough Gara. Boyle was incorporated by James I., and returned two members to the Irish parliament.

BOYNE, a river of Ireland, which, rising in the Bog of Allen, near Carbery in Co. Kildare, and flowing in a north-easterly direction, passes Trim, Navan and Drogheda, and enters the Irish Sea, 4 m. below the town last named. It is navigable for barges to Navan, 19 m. from its mouth. Much of the scenery on its banks is beautiful, though never grand. About 2 m. west of Drogheda, an obelisk, 150 ft. in height, marks the spot where the forces of William III. gained a celebrated victory over those of James II., on the 1st of July 1690, known as the battle of the Boyne.

BOYS' BRIGADE, an organization founded in Glasgow by Mr (afterwards Sir) W. A. Smith in 1883 to develop Christian manliness by the use of a semi-military discipline and order, gymnastics, summer camps and religious services and classes. There are about 2200 companies connected with different churches throughout the United Kingdom, the British Empire and the United States, with 10,000 officers and 100,000 boys. A similar organization, confined to the Anglican communion, is the Church Lads' Brigade. Boys' and girls' life brigades are a more recent movement; they teach young people how to save life from fire and from water, and hold classes in hygiene, ambulance and elementary nursing.

BOZDAR, a Baluch tribe of Rind (Arab) extraction, usually associated with the mountain districts of the frontier near Dera Ghazi Khan. They are also to be found in Zhob, Thal-Chotiali and Las Bela, whilst the majority of the population are said to live in the Punjab. They are usually graziers, and the name Bozdar is probably derived from Buz, the Persian name for goat. Within the limits of their mountain home on the outer spurs of the Suliman hills they have always been a turbulent race, mustering about 2700 fighting men, and they were formerly constantly at feud with the neighbouring Ustarana and Sherani tribes. In 1857 their raids into the Punjab drew upon them an expedition under Brigadier-General Sir N. B. Chamberlain. The Sanghar pass was captured and the Bozdars submitted. Since Baluchistan has been taken over they have given but little trouble.

¹ This was the "old style" date, which in the new style (see CALENDAR) would be July 11th (not 12th, as Lecky says, *Hist. of Ireland*, iii. p. 427). The 12th of July is annually celebrated by the Orangemen in the north of Ireland as the anniversary, but this is a confusion between the supposed new style for July 1st and the old style date of the battle of Aughrim, July 12th; the intention being to commemorate both.

BOZRAH. (1) A capital of Edom (Gen. xxxiv. 33; Amos 1. 12; Is. xxxiv. 6, lxiii. 1), doubtfully identified with *el-Buseirah*, S.E. of the Dead Sea, in the broken country N. of Petra; the ruins here are comparatively unimportant. It is the centre of a pastoral district, and its inhabitants, who number between 100 and 200, are all shepherds. (2) A city in the *Mishor* or plain country of Moab, denounced by Jeremiah (xlviii. 24). It has been identified (also questionably) with a very extensive collection of ruins of various ages, now called Bosra (the Roman *Bostra*), situated in the Hauran, about 80 m. south of Damascus. The area within the walls is about 1½ m. in length, and nearly 1 m. in breadth, while extensive suburbs lie to the east, north and west. The principal buildings which can still be distinguished are a temple, an aqueduct, a large theatre (enclosed by a castle of much more recent workmanship), several baths, a triumphal and other arches, three mosques, and what are known as the church and convent of the monk Boheira. In A.D. 106 the city was beautified and perhaps restored from ruin by Trajan, who made it the capital of the new province of Arabia. In the reign of Alexander Severus it was made a colony, and in 244, a native of the place, Philippus, ascended the imperial throne. By the time of Constantine the Great it seems to have been Christianized, and not long after it was the seat of an extensive bishopric. It was one of the first cities of Syria to be subjected to the Mahomedans, and it successfully resisted all the attempts of the Crusaders to wrest it from their hands. As late as the 14th century it was a populous city, after which it gradually fell into decay. It is now inhabited by thirty or forty families only. Another suggested identification is with Kusur el-Besheir, equidistant (2 m.) from Dibon and Aroer. This is perhaps the same as the Bezer mentioned in Deuteronomy and Joshua as a levitical city and a city of refuge.

In 1 Macc. v. 26 there is mention of Bosor and of Bosora. The latter is probably to be identified with Bosra, the former perhaps with the present Busr el-Hariri in the south-east corner of the Lejā. (R. A. S. M.)

BRABANT, a duchy which existed from 1190 to 1430, when it was united with the duchy of Burgundy, the name being derived from Brabo, a semi-mythical Frankish chief.

The history of Brabant is connected with that of the duchy of Lower Lorraine (*q.v.*), which became in the course of the 11th century split up into a number of small feudal states. The counts of Hainaut, Namur, Luxemburg and Limburg asserted their independence, and the territory of Liège passed to the bishops of that city. The remnant of the duchy, united since 1100 with the margraviate of Antwerp, was conferred in 1106 by the emperor Henry V., with the title of duke of Lower Lorraine, upon Godfrey (Godefroid) I., "the Bearded," count of Louvain and Brussels. His title was disputed by Count Henry of Limburg, and for three generations the representatives of the rival houses contested the possession of the ducal dignity in Lower Lorraine. The issue was decided in favour of the house of Louvain by Duke Godfrey III. in 1159. His son, Henry I., "the Warrior" (1183-1235), abandoned the title of duke of Lower Lorraine and assumed in 1190 that of duke of Brabant. His successors were Henry II., "the Magnanimous" (1235-1248), Henry III., "le Debonnaire" (1248-1261), and John I., "the Victorious" (1261-1294). These were all able rulers. Their usual place of residence was Louvain. John I., in 1283 bought the duchy of Limburg from Adolf of Berg, and secured his acquisition by defeating and slaying his competitor, Henry of Luxemburg, at the battle of Woeringen (June 5, 1288). His own son, John II., "the Pacific" (1294-1312), bestowed liberties upon his subjects by the charter of Cortenberg. This charter laid the foundation of Brabantine freedom. By it the imposition of grants (*bedes*) and taxes was strictly limited and regulated, and its execution was entrusted to a council appointed by the duke for life (four nobles, ten burghers) whose duty it was to consider all complaints and to see that the conditions laid down by the charter concerning the administration of justice and finance were not infringed. He was succeeded by his son, John III., "the Triumphant" (1312-1355), who succeeded in maintaining his position in spite of formidable risings in Louvain and Brussels,

and a league formed against him by his princely neighbours, but he had a hard struggle to face, and many ups and downs of fortune. He it was to whom Brabant owed the great charter of its liberties, called *La joyeuse entrée*, because it was granted on the occasion of the marriage of his daughter Johanna (Jeanne) with Wenzel (Wenceslaus) of Luxemburg, and was proclaimed on their state entry into Brussels (1356).

Henry, the only legitimate son of John III., having died in 1349, the ducal dignity passed to his daughter and heiress, the above-named Johanna (d. 1406). She had married in first wedlock William IV., count of Holland (d. 1345). Wenzel of Luxemburg, her second husband, assumed in right of his wife, and by the sanction of the charter *La joyeuse entrée*, the style of duke of Brabant. Johanna's title was, however, disputed by Louis II., count of Flanders (d. 1384), who had married her sister Margaret. The question had been compromised by thecession to Margaret in 1347 of the margraviate of Antwerp by John III., but a war broke out in 1356 between Wenzel supported by the guilds, and Louis, who upheld the burgher-patrician party in the Brabant cities. The democratic leaders were Everhard Tserclaes at Brussels and Peter Coutercel at Louvain. In the course of a stormy reign Wenzel was taken prisoner in 1371 by the duke of Gelderland, and had to be ransomed by his subjects. After his death (1383) his widow continued to rule over the two duchies for eighteen years, but was obliged to rely on the support of the house of Burgundy in her contests with the turbulent city guilds and with her neighbours, the dukes of Jülich and Gelderland. In 1390 she revoked the deed which secured the succession to Brabant to the house of Luxemburg, and appointed her niece, Margaret of Flanders (d. 1405), daughter of Louis II. and Margaret of Brabant (see FLANDERS), and her husband, Philip the Bold of Burgundy, her heirs. Margaret of Flanders had married (1) Philip I. de Rouve of Burgundy (d. 1361) and (2) Philip II., the Bold, (d. 1404), son of John II., king of France (see BURGUNDY). Of her three sons by her second marriage John succeeded to Burgundy, and Anthony to Brabant on the death of Johanna in 1406. Anthony was killed at the battle of Agincourt in 1415 and was succeeded by his eldest son by Jeanne of Luxemburg St Pol, John IV. (d. 1427). He is chiefly memorable for the excitement caused by his divorce from his wife Jacoba (q.v.), countess of Holland. John IV. left no issue, and the succession passed to his brother Philip I., who also died without issue in 1430.

On the extinction of the line of Anthony the duchy of Brabant became the inheritance of the elder branch of the house of Burgundy, in the person of Philip III., "the Good," of Burgundy, II. of Brabant, son of John. His grand-daughter Mary (d. 1482), daughter and heiress of Charles I., "the Bold," (d. 1477) married the archduke Maximilian of Austria (afterwards emperor) and so brought Brabant with the other Burgundian possessions to the house of Habsburg. The chief city of Brabant, Brussels, became under the Habsburg régime the residence of the court and the capital of the Netherlands. In the person of the emperor Charles V. the destinies of Brabant and the other Netherland states were linked with those of the Spanish monarchy. The attempt of Philip II. of Spain to impose despotic rule upon the Netherlands led to the outbreak of the Netherland revolt, 1568 (see NETHERLANDS).

In the course of the eighty years' war of independence the province of Brabant became separated into two portions. In the southern and larger part Spanish rule was maintained, and Brussels continued to be the seat of government. The northern (smaller) part was conquered by the Dutch under Maurice and Frederick Henry of Orange. The latter captured 's Hertogenbosch (1629), Maastricht (1632) and Breda (1637). At the peace of Münster this portion, which now forms the Dutch province of North Brabant, was ceded by Philip IV. to the United Provinces and was known as Generality Land, and placed under the direct government of the states-general. The southern portion, now divided into the provinces of Antwerp and South Brabant, remained under the rule of the Spanish Habsburgs until the death of Charles II., the last of his race in 1700. After the War of the Spanish Succession the southern Netherlands

passed by the treaty of Utrecht (1713) to the Austrian branch of the Habsburgs. During the whole period of Austrian rule the province of Brabant succeeded in maintaining, to a very large extent unimpaired, the immunities and privileges to which it was entitled under the provisions of its ancient charter of liberty, the Joyous Entry. An ill-judged attempt by the emperor Joseph II., in his zeal for reform, to infringe these inherited rights stirred up the people under the leadership of Henry van der Noot to armed resistance in the Brabançon revolt of 1780-1790.

Since the French conquest of 1794 the history of Brabant is merged in that of Belgium (q.v.). The revolt against Dutch rule in 1830 broke out at Brussels and was in its initial stages largely a Brabançon movement. The important part played by Brabant at this crisis of the history of the southern Netherlands was marked in 1831 by the adoption of the ancient Brabançon colours to form the national flag, and of the lion of Brabant as the armorial bearings of Belgium. The title of duke of Brabant has been revived as the style of the eldest son of the king of the Belgians. (G. E.)

BRABANT, the central and metropolitan province of Belgium, is formed out of part of the ancient duchy. From 1815 to 1830, that is to say, during the existence of the kingdom of the Netherlands, Belgian Brabant was distinguished from Dutch by the employment of the geographical terms South and North. The surface of Brabant is undulating, and the highest points, some 400 ft. in altitude, are to be found at and near Mont St Jean. The province is well cultivated, and the people are well known for their industry. There are valuable stone quarries, and many manufactures flourish in the smaller towns, such as Ottignies, as well as in the larger cities of Brussels and Louvain. Brabant contains 820,740 acres or 1268 sq. m. Its principal towns are Brussels, Louvain, Nivelles, Hal, Ottignies, and its three administrative divisions are named after the first three of those towns. They are subdivided into 50 cantons and 344 communes. In 1904 the population of the province was 1,366,389 or a proportion of 1077 per sq. m.

BRABANT, NORTH, the largest province in Holland, bounded S. by Belgium, W. and N.W. by the Scheldt, the Eendracht, the Volkerak and the Hollandsch Diep, which separate it from Zeeland and South Holland, N. and N. E. by the Merwede and Maas, which separate it from South Holland and Gelderland, and E. by the province of Limburg. It has an area of 231 sq.m. and a pop. (1900) of 553,842. The surface of the province is a gentle slope from the south-east (where it ranges between 80 and 160 ft. in height) towards the north and north-west, and the soil is composed of diluvial sand, here and there mixed with gravel, but giving place to sea-clay along the western boundary and river-clay along the banks of the Maas and smaller rivers. The watershed is formed by the north-eastern edge of the Belgian plateau of Campine, and follows a curved line drawn through Bergen-op-Zoom, Turnhout and Maastricht. The landscape consists for the most part of waste stretches of heath, occasionally slightly overlaid with high fen. Between the valleys of the Aa and the Maas lies the long stretch of heavy high-fen called the Peel ("marsh land"). Deurne, a few miles east of Helmond, the site of a prehistoric burial-ground, was an early fen colony. The work of reclamation was removed farther eastwards to Helenaveen in the second half of the 19th century. Agriculture (potatoes, buckwheat, rye) is the main industry, generally combined with cattle-raising. On the clay lands wheat and barley are the principal products, and in the western corner of the province beetroot is largely cultivated for the beet sugar industry, factories being found at Bergen-op-Zoom, Steenberg and Oudenbosch. There is a special cultivation of hops in the district north-west of 's Hertogenbosch. The large majority of the population is Roman Catholic. The earliest development of towns and villages took place along the river Maas and its tributaries, and the fortified Roman camps which were the origin of many such afterwards developed in the hands of feudal lords. The chief town of the province, 's Hertogenbosch, may be cited as an interesting historical example. Geerttruidenberg,

Heusden, Ravestein and Grave are all similarly situated. Breda is the next town in importance to the capital. Bergen-op-Zoom had originally a more maritime importance. Rozendaal, Eindhoven and Bokstel (or Bostel) are important railway junctions. Bokstel was formerly the seat of an independent barony which came into the possession of Philip the Good in 1439. The castle was restored in modern times. The precarious position of the province on the borders of the country doubtless militated against an earlier industrial development, but since the separation from Belgium and the construction of roads, railways and canals there has been a general improvement, Tilburg, Eindhoven and Helmond all having risen into prominence in modern times as industrial centres. Leather-tanning and shoe-making are especially associated with the district called Langstraat, which is situated between Geert-ruidenberg and 's Hertogenbosch, and consists of a series of industrial villages along the course of the Old Maas.

BRACCIANO, a town in the province of Rome, Italy, 25 m. N.W. of Rome by rail, situated on the S.W. shore of the Lake of Bracciano, 915 ft. above sea-level. Pop. (1901) 3987. It is chiefly remarkable for its fine castle (built by the Orsini in 1460, and since 1696 the property of the Odescalchi) which has preserved its medieval character. The beautiful lake is the ancient *Lacus Sabatinus*, supposed to derive its name from an Etruscan city of the name of Sabate, which is wrongly thought to be mentioned in the Itineraries; the reference is really to the lake itself, which bore this name and gave it to one of the Roman tribes, the *tribus Sabatina*, founded in 387 B.C. (O. Cuntz in *Jahreshefte des Oesterr. Arch. Instituts*, II, 1899, 85). It is 22 sq. m. in area, 538 ft. above sea-level, and 530 ft. deep; it is almost circular, but is held to be, not an extinct crater, but the result of a volcanic subsidence. The tufa deposits which radiate from it extend as far as Rome; various small craters surround it, while the existence of warm springs in the district (especially those of Vicarello, probably the ancient *Aquae Apollinares*) may also be noted. Many remains of ancient villas may be seen round the lake: above its west bank is the station of Forum Clodii, and on its north shore the village of Trevignano, which retains traces of the fortifications of an ancient town of unknown name. About half-a-mile east of it was a post station called Ad Novas. The site of Anguillara, on the south shore, was occupied by a Roman villa. The water of the lake partly supplies the Acqua Paola, a restoration by Paul V. of the Acqua Traiana. (T. As.)

BRACCIOLINI, FRANCESCO (1566-1645), Italian poet, was born at Pistoia, of a noble family, in 1566. On his removing to Florence he was admitted into the academy there, and devoted himself to literature. At Rome he entered the service of Cardinal Maffeo Barberini, with whom he afterwards went to France. After the death of Clement VIII. he returned to his own country; and when his patron Barberini was elected pope, under the name of Urban VIII., Bracciolini repaired to Rome, and was made secretary to the pope's brother, Cardinal Antonio. He had also the honour conferred on him of taking a surname from the arms of the Barberini family, which were bees; whence he was afterwards known by the name of *Bracciolini dell' Api*. During Urban's pontificate the poet lived at Rome in considerable reputation, though at the same time he was censured for his sordid avarice. On the death of the pontiff he returned to Pistoia, where he died in 1645. There is scarcely any species of poetry, epic, dramatic, pastoral, lyric or burlesque, which Bracciolini did not attempt; but he is principally noted for his mock-heroic poem *Lo Scherno degli Dei*, published in 1618, similar but confessedly inferior to the contemporary work of Tassoni, *Secchia Rapita*. Of his serious heroic poems the most celebrated is *La Croce Racquistata*.

For the Italian humanist Poggio Bracciolini see POGGIO.

BRACE, CHARLES LORING (1826-1890), American philanthropist, was born on the 19th of June 1826 in Litchfield, Connecticut. He graduated at Yale in 1846, studied theology there in 1847-1848, and graduated from Union Theological Seminary in 1849. From this time he practically devoted his life to social

work among the poor of New York, and to Christian propaganda among the criminal classes; and he became well known as a social reformer, at home and abroad. He started in 1852 to hold "boys' meetings," and in 1853 helped to found the Children's Aid Society, establishing workshops, industrial schools and lodging-houses for newsboys. In 1872 he was a delegate to the international prison congress which met in London. He died at Campfer, in Tirol, on the 11th of August 1890. He published from time to time several volumes embodying his views on practical Christianity and its application to the improvement of social conditions.

See *The Life and Letters of Charles Loring Brace* (New York, 1894), edited by his daughter, Emma Brace.

BRACE, JULIA (1806-1884), American blind deaf-mute, was born at Newington, Connecticut, on the 13th of June 1806. In her fifth year she became blind and deaf, and lost the power of speech. At the age of eighteen she entered the asylum for the deaf and dumb at Hartford. The study of blind deaf-mutes and their scientific training was then in its infancy; but she learnt to sew well, was neat in her dress, and had a good memory. Dr S. G. Howe's experiments with her were interesting as leading to his success with Laura Bridgman. She died at Bloomington, Conn., on the 12th of August 1884.

BRACE (through the Fr. from the plural of the Lat. *bracchium*, the arm), a measure of length, being the distance between the extended arms. From the original meaning of "the two arms" comes that of something which secures, connects, tightens or strengthens, found in numerous uses of the word, as a carpenter's tool with a crank handle and socket to hold a bit for boring; a beam of wood or metal used to strengthen any building or machine; the straps passing over the shoulders to support the trousers; the leathern thong which slides up and down the cord of a drum, and regulates the tension and the tone; a writing and printing sign (|) for uniting two or more lines of letterpress or music; a nautical term for a rope fastened to the yard for trimming the sails (cf. the corresponding French term *bras de vergue*). As meaning "a couple" or "pair" the term was first applied to dogs, probably from the leash by which they were coupled in coursing. In architecture "brace mould" is the term for two ressaunts or ogees united together like a brace in printing, sometimes with a small bead between them.

BRACEGIRDLE, ANNE (c. 1674-1748), English actress, is said to have been placed under the care of Thomas Betterton and his wife, and to have first appeared on the stage as the page in *The Orphan* at its first performance at Dorset Garden in 1680. She was Lucia in Shadwell's *Squire of Alsatia* at the Theatre Royal in 1688, and played similar parts until, in 1693, as Araminta in *The Old Bachelor*, she made her first appearance in a comedy by Congreve, with whose works and life her name is most closely connected. In 1695 she went with Betterton and the other seceders to Lincoln's Inn Fields, where, on its opening with Congreve's *Love for Love*, she played Angelica. This part, and those of Belinda in Vanbrugh's *Provoked Wife*, and Almira in Congreve's *Mourning Bride*, were among her best impersonations, but she also played the heroines of some of Nicholas Rowe's tragedies, and acted in the contemporary versions of Shakespeare's plays. In 1705 she followed Betterton to the Haymarket, where she found a serious competitor in Mrs Oldfield, then first coming into public favour. The story runs that it was left for the audience to determine which was the better comedy actress, the test being the part of Mrs Brittle in Betterton's *Amorous Widow*, which was played alternately by the two rivals on successive nights. When the popular vote was given in favour of Mrs Oldfield, Mrs Bracegirdle quitted the stage, making only one reappearance at Betterton's benefit in 1709. Her private life was the subject of much discussion. Colley Cibber remarks that she had the merit of "not being unguarded in her private character," while Macaulay does not hesitate to call her "a cold, vain and interested coquette, who perfectly understood how much the influence of her charms was increased by the fame of a severity which cost her nothing." She was certainly the object of the adoration of many men.

and she was the innocent cause of the killing of the actor William Mountfort (q.v.), whom Captain Hill and Lord Mohun regarded as a rival for her affections. During her lifetime she was suspected of being secretly married to Congreve, whose mistress she is also said to have been. He was at least always her intimate friend, and left her a legacy. Rightly or wrongly, her reputation for virtue was remarkably high, and Lord Halifax headed a subscription list of 800 guineas, presented to her as a tribute to her virtue. Her charity to the poor in Clare Market and around Drury Lane was conspicuous, "insomuch that she would not pass that neighbourhood without the thankful acclamations of people of all degrees." She died in 1748, and was buried in the cloisters of Westminster Abbey.

See *Genest, History of the Stage*; Colley Cibber, *Apology* (edited by Belchambers); Egerton, *Life of Anne Oldfield*; Downes, *Roscius Anglicanus*.

BRACELET, or ARMLET, a personal ornament for the arm or wrist, made of different materials, according to the fashion of the age and the rank of the wearer. The word is the French *braclet*, a diminutive of *bracel*, from *brac(c)iale*, formed from the Latin *bracchium*, the arm, on which it was usually worn. By the Romans it was called *armilla*, *brachiale*, *occulus*; and in the middle ages *bauga*, *armispalka*.

In the Bible there are three different words which the authorized version renders by "bracelet." These are—(1) *תַּסְסָן 'eš'adāh*, which occurs in Num. xxxi. 50, 2 Sam. i. 10, and which being used with reference to men only, may be taken to be the *armlet*; (2) *צַדִּיקִים 'sōdīqīm*, which is found in Gen. xxiv. 22, Num. xxxi. 50, Ezek. xvi. 11;—where these two words occur together (as in Num. xxxi. 50) the first is rendered by "chain," and the second by "bracelet"; (3) *מַשְׂרֵתִים 'māšerōtīm*, which occurs only in Isa. iii. 19. The first probably meant armlets worn by men; the second, bracelets worn by women and sometimes by men; and the third a peculiar bracelet of chain-work worn only by women.



From *La Grande Encyclopédie*.

FIG. 1.—Egyptian Bracelet, Louvre.

In 2 Sam. i. 10 the first word denotes the royal ornament which the Amalekite took from the arm of the dead Saul, and brought with the other regalia to David. There is little question that this was such a distinguishing band of jewelled metal as we still find worn as a mark of royalty from the Tigris to the Ganges. The Egyptian kings are represented with armlets, which were also worn by the Egyptian women. These, however, are not jewelled, but of plain or enamelled metal, as was in all likelihood the case among the Hebrews.

In modern times the most celebrated armlets are those which form part of the regalia of the Persian kings and formerly belonged to the Mogul emperors of India, being part of the spoil carried to Persia from Delhi by Nadir Shah in 1739. These ornaments are of dazzling splendour, and the jewels in them are of such large size and immense value that the pair have been reckoned to be worth a million sterling. The principal stone of the right armlet is famous in the East under the name of the *Dary-i-nūr*, "sea (or river) of light." It weighs 186 carats,

and is considered the diamond of finest lustre in the world. The principal jewel of the left armlet, although of somewhat inferior size (146 carats) and value, is renowned as the *Tāj-e-mah*, "crown of the moon." The imperial armlets, generally set with jewels, may also be observed in most of the portraits of the Indian emperors.

Bracelets have at all times been much in use among barbaric nations, and the women frequently wear several on the same arm. The finer kinds are of mother-of-pearl, fine gold or silver; others of less value are made of plated steel, horn, brass, copper, beads, &c. Chinese bracelets are sometimes cut out of single pieces of jade.

This species of personal ornament has been exceedingly common in Europe from prehistoric times onward. The bracelets of the Bronze Age were of either gold or bronze, silver being then unknown. In shape they were oval and penannular with expanding or trumpet-shaped ends, having an opening between them of about half an inch to enable them to be easily slipped over the wrist. Those of gold were generally plain, hammered rods, bent to the requisite shape, but those of bronze were often chased with decorative designs. Some forms of spiral armlets of bronze, peculiar to Germany and Scandinavia, covered the whole fore-arm, and were doubtless intended as much for defence against a sword-stroke as for ornament. Among the nations of classical antiquity, bracelets were worn by both sexes of the Etruscans; by women only among the Greeks, except in orientalized communities. Among the Romans they were worn by women only as a rule, but they are also recorded to have been used during the empire by *novissima riches*, and by some of the emperors. It should also be mentioned that bracelets were conferred as a military decoration in the field.

The bracelets of the Greeks are of two leading types, both of which were also familiar to the Assyrians. The one

class were in the form of coiled spirals, usually in the form of snakes, a term which Pol-lux gives as a synonym for bracelet. The other class were stiff penannular hoops, capable of being slightly opened. In such examples the terminals are finely finished as rams' heads, lions' heads, or (as in the accompanying figure from a bracelet found at Kul-oba) as enamelled sphinxes. In late Etruscan art the bracelet may be formed of consecutive panels, as often in modern jewelry.

The spiral forms were common in the Iron Age of northern Europe, while silver bracelets of great elegance, formed of plaited and intertwisted strands of silver wire, and plain penannular



From *La Grande Encyclopédie*.

FIG. 2.—Greek Bracelet, Hermitage.



From *La Grande Encyclopédie*.

FIG. 3.—Etruscan Bracelet, Louvre.

hoops, round or lozenge-shaped in section and tapering to the extremities, became common towards the close of the pagan period. The late Celtic period in Britain was characterized by serpent-shaped bracelets and massive armlets, with projecting ornaments of solid bronze and perforations filled with enamel. In the middle ages bracelets were much less commonly used in Europe.

but the custom has continued to prevail among Eastern nations to the present time, and many of the types that were common in Europe in prehistoric times are still worn in central Asia.

A treatise, *De Armillis Veterum*, by Thomas Bartholinus, was published at Amsterdam in 1676.

BRACHIOPODA, an important and well-defined but extremely isolated class of invertebrates. The group may be defined as follows: Sessile solitary *Coelomata* with bivalved shells usually of unequal size and arranged dorso-ventrally. The head is produced into ciliated arms bearing tentacles. They reproduce sexually, and with doubtful exceptions are of separate sexes.

The name Brachiopod (*Braxylon*, an arm, and *podis, podis*, a foot) was proposed for the class by F. Cuvier in 1805, and by A. M. C. Dumeril in 1809, and has since been very extensively adopted. The division of the group into *Ecardines* (*Inarticulata*),

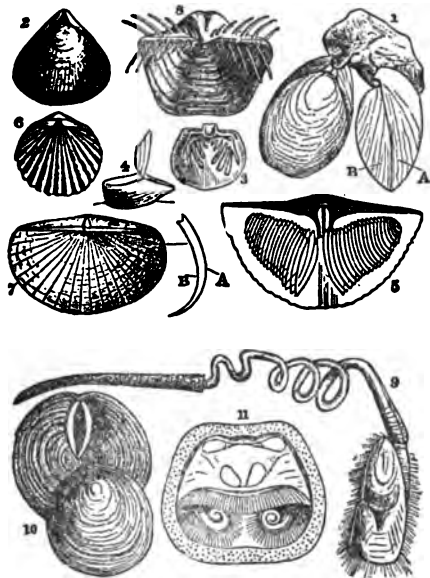

FIGS. 1-11.—Various forms of Brachiopoda.

- | | |
|--|--|
| 1. <i>Magellania</i> [<i>Waldheimia</i>]
<i>cranium</i> . A, ventral, B,
dorsal valve. | 7. <i>Leptaena transversalis</i> . A,
ventral, B, dorsal valve. |
| 2. <i>Rhynchonella</i> (<i>Hemithyris</i>)
<i>prillacea</i> . | 8. <i>Productus horridus</i> . |
| 3 and 4. <i>Thecidea</i> . | 9. <i>Lingula pyramidalis</i> (after
Morse). |
| 5. <i>Spirifer</i> . Dorsal valve,
showing calcareous spiral
coils. | 10. <i>Disciniscia lamellosa</i> . |
| 6. <i>Orthis calligramma</i> . | 11. <i>Crania anomala</i> . Interior of
dorsal valve, showing muscular
impressions and labial
appendages. |

with no hinge to the shell and with an alimentary canal open at both ends, and *Testicardines* (*Articulata*), with a hinge between the dorsal and ventral valves and with no anus, was proposed by Owen and has been adopted by nearly all authors. In a later scheme based on our increased knowledge of fossil forms, the Brachiopoda are divided into four primary groups (orders). This is given at the end of the article, but it must not be forgotten that the existing forms with an anus (*Ecardines*) differ markedly from the apterous members of the group (*Testicardines*).

The soft body of the Brachiopod is in all cases protected by a shell composed of two distinct valves; these valves are always, except in cases of malformation, equal-sided, but not equivalent. The valves are, consequently, essentially symmetrical, which is not the case with the Lamellibranchiata,—so much so, that certain Brachiopod shells were named *Lampades*, or lamp shells, by some early naturalists; but while such may bear a kind of

resemblance to an antique Etruscan lamp, by far the larger number in no way resemble one. The shell is likewise most beautiful in its endless shapes and variations. In some species it is thin, semi-transparent and glassy, in others massive. Generally the shell is from a quarter of an inch to about 4 in. in size, but in certain species it attains nearly a foot in breadth by something less in length, as is the case with *Productus giganteus*. The valves are also in some species very unequal in their respective thickness, as may be seen in *Productus* (*Daviesiella*) *llangollenis*, *Davidsonia vernouilii*, &c., and while the space allotted to the animal is very great in many species, as in *Terebratula sphaeroidalis*, it is very small in others belonging to *Strophomena*, *Leptaena*, *Chonetes*, &c. The ventral valve is usually the thickest, and in some forms is six or seven times as great as the opposite one. The outer surface of many of the species presents likewise the most exquisite sculpture, heightened by brilliant shades, or spots of green, red, yellow and bluish black. Traces of the original colour have also been preserved in some of the fossil forms; radiating bands of a reddish tint have been often seen in well-preserved examples of *Terebratula* (*Dielasma*) *hastata*, *T. (Dielasma) sacculus*, *T. communis*, *T. biplicata*, and of several others. Some specimens of *T. carnea* are of a beautiful pale pink colour when first removed from their matrix, and E. Deslongchamps has described the tint of several Jurassic species.

The valves are distinguished as *dorsal* and *ventral*. The ventral valve is usually the larger, and in many genera, such as *Terebratula* and *Rhynchonella*, has a prominent beak or umbo, with a circular or otherwise shaped foramen at or near its extremity, partly bounded by one or two plates, termed a deltidium. Through the foramen passes a peduncle, by which the animal is in many species attached to submarine objects during at least a portion of its existence. Other forms show no indication of ever having been attached, while some that had been moored by means of a peduncle during the early portion of their existence have become detached at a more advanced stage of life, the opening becoming gradually cicatrized, as is so often seen in *Leptaena rhomboidalis*, *Orthis anomala*, &c. Lastly, some species adhere to submarine objects by a larger or smaller portion of their ventral valve, as is the case with many forms of *Crania*, *Thecidium*, *Davidsonia*, &c. Some *Cranias* are always attached by the whole surface of their lower or ventral valve, which models itself and fills up all the projections or depressions existing on either the rock, shell or coral to which it adhered. These irregularities are likewise, at times, reproduced on the upper or dorsal valve. Some species of *Strophalosia* and *Productus* seem also to have been moored during life to the sandy or muddy bottoms on which they lived, by the means of tubular spines often of considerable length. The interior of the shell varies very much according to families and genera. On the inner surface of both valves several well-defined muscular, vascular and ovarian impressions are observable; they form either indentations of greater or less size and depth, or occur as variously shaped projections. In the *Trimerellidae*, for example, some of the muscles are attached to a massive or vaulted platform situated in the medio-longitudinal region of the posterior half or umbonal portion of both valves. In addition to these, there exists in the interior of the *dorsal* valve of some genera a variously modified, thin, calcified, ribbon-shaped skeleton for the support of the ciliated arms, and the form of this ribbon serves as one of the chief generic characters of both recent and extinct forms. This brachial skeleton is more developed in some genera than in others. In certain forms, as in *Terebratula* and *Terebratulina*, it is short and simple, and attached to a small divided hinge-plate, the two riband-shaped lamina being bent upwards in the middle (fig. 15). The cardinal process is prominent, and on each side of the hinge-plate are situated the dental sockets; the loop in *Terebratulina* becomes annular in the adult by the union of its crural processes (fig. 16). In *Magellania* (*Waldheimia*) it is elongated and reflected; the hinge-plate large, with four depressions, under which originates a median septum, which extends more or less into the interior of the shell (figs. 13 and 14).

¹ Subgenera are indicated by round, synonyms by square brackets.

In *Terebratella* the loop is attached to the hinge-plate and to the septum (fig. 17). In *Megerlia* it is three times attached, first to the hinge-plate, and then to the septum by processes from the diverging and reflected positions of the loop. In *Magas* the brachial skeleton is composed of an elevated longitudinal septum reaching from one valve to the other, to which are affixed two pairs of calcareous lamellae, the lower ones riband-shaped; attached first to the hinge-plate, they afterwards proceed by a gentle curve near to the anterior portion of the septum, to the sides of which they are affixed; the second pair originate on both sides of the upper edge of the septum, extending in the form of two triangular anchor-shaped lamellae (fig. 18). In *Bouchardia* the septum only is furnished with two short anchor-shaped lamellae. Many more modifications are observable in different groups of which the great family *Terebratulidae* is composed. In *Theridism* (figs. 3, 4) the interior of the dorsal valve is variously furrowed to receive the lophophore folded in two or more lobes.

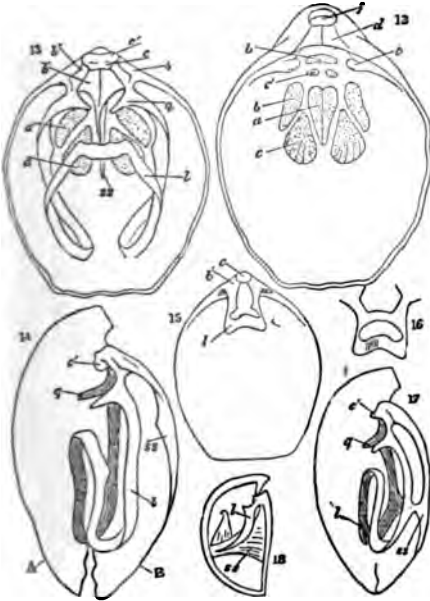

FIGS. 12-18.

12. *Magellania* [*Waldheimia*] *flavescens*. Interior of ventral valve. *f*, foramen; *d*, deltidium; *t*, teeth; *a*, adductor impressions (=occlusors, Hancock); *c*, divaricator (=cardinal muscles, King, = muscles diducteurs principaux, Gratulet); *c'*, accessory divaricators (muscles diducteurs accessoires, Gratulet); *b*, ventral adjustor (=ventral peduncular muscles, or muscles du pedoncule paire supérieure, Gratulet); *b'*, peduncular muscle.
13. *Magellania* [*Waldheimia*] *flavescens*. Interior of dorsal valve. *c*, cardinal process; *b*, *b'*, hinge-plate; *s*, dental sockets; *l*, loop; *g*, crura; *a*, *a'*, adductor impressions; *c*, accessory divaricator; *b*, peduncle muscles; *ss*, septum.
14. *Magellania* [*Waldheimia*] *flavescens*. Longitudinal section of valves. *A*, ventral, *B*, dorsal valves; *l*, loop; *g*, crura; *ss*, septum; *c*, cardinal process.
15. *Terebratula* (*Lianthyrus*) *nitrea*. Interior of dorsal valve. *l*, loop; *b*, hinge-plate; *c*, cardinal process.
16. Loop of *Terebratulina caput serpentis*.
17. Longitudinal section of *Terebratella dorsata*. (References as in fig. 14.)
18. Longitudinal section of *Magas pamilus*.

In the family *Spiriferidae* there are two conical spires directed outwards, and nearly filling the cavity of the shell (fig. 5); while in *Atrypa* the broad spirally coiled lamellae are vertical, and directed toward the centre of the dorsal valve. In the

Rhynchonellidae there are two short slender curved laminae, while in many genera and even families, such as the *Productidae*, *Strophomenidae*, *Lingulidae*, *Discinidae*, &c., there exists no calcified support for the labial appendages. The ventral valve in many of the genera is provided with two curved hinge-teeth, which fit into corresponding sockets in the opposite valve, so that the valves cannot be separated without breaking one of the teeth.

Each valve of the shell is lined by a mantle which contains prolongations of the body cavity. The outer surfaces of the mantle secrete the shell, which is of the nature of a cuticle impregnated by calcareous salts. These often have the form of prisms of calcite surrounded by a cuticular meshwork; the whole is nourished and kept alive by processes, which in *Crania* are branched; these perforate the shell and permit the access of the coelomic fluid throughout its substance. These canals are closed externally and are absent in *Rhynchonella*, where the amount of calcareous deposit is small. In *Lingula* the shell is composed of alternate layers of chitin and of phosphate of lime. The free edges of the mantle often bear chitinous bristles or setae which project beyond the shell.

As in the case of the Lamellibranchiata, the shell of the adult is not a direct derivative of the youngest shell of the larva. The young Brachiopod in all its species is protected by an embryonic shell called the "protegulum," which sometimes persists in the umbones of the adult shells but is more usually worn off. In all species it has the same shape, a shape which has been retained in the adult by the Lower Cambrian genus *Iphidea*.

The body of the Brachiopod usually occupies about the posterior half of the space within the shell. The anterior half of this space is lined by the inner wall of the mantle and is called the mantle cavity. This cavity lodges the arms, which are curved and coiled in different ways in different genera. The water which bears the oxygen for respiration and the minute organisms upon which the Brachiopod feeds is swept into the mantle cavity by the action of the cilia which cover the arms, and the eggs and excreta pass out into the same cavity. The mouth lies in the centre of the anterior wall of the body. Its two lips fusing together at the corners of the mouth are prolonged into the so-called arms. These arms, which together form the lophophore,

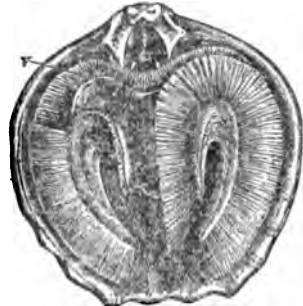

FIG. 19.—*Magellania* [*Waldheimia*] *flavescens*. Interior of dorsal valve, to show the position of the labial appendages. *m*, Mouth. (A portion of the fringe of cirri is removed to show the brachial membrane and a portion of the spiral extremities of the arms.)

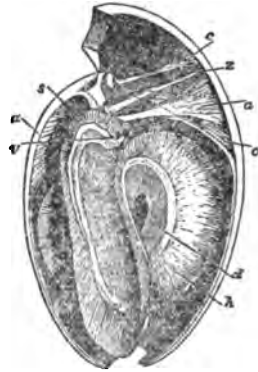

FIG. 20.—*Magellania* [*Waldheimia*] *flavescens*. Longitudinal section with a portion of the animal.

- d*, *d*, Brachial appendages.
a, Adductor.
c, *c'*, Divaricator muscles.
s, Septum.
m, Mouth.
z, Extremity of alimentary tube.
 The peduncular muscles have been purposely omitted.

may be, as in *Cistella*, applied flat to the inner surface of the dorsal mantle fold, but more usually they are raised free from the body like a pair of moustaches, and as they are usually far too long to lie straight in the mantle cavity, they are folded or coiled up. The brachial skeleton which in many cases supports the arms has been mentioned above.

A transverse section through the arm (fig. 22) shows that it consists of a stout base, composed of a very hyaline connective tissue not uncommon in the tissues of the Brachiopoda, which is traversed by certain canals whose nature is considered below under the section (*The Body Cavity*) devoted to the coelom. Anteriorly this base supports a gurry or gutter, the pre-oral rim of which is formed by a simple lip, but the post-oral rim is composed of a closely set row of tentacles.

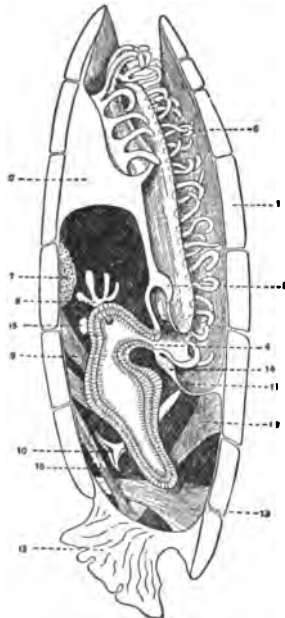

FIG. 21.—A diagram of the left half of an *Argiope* (*Megathyris*), which has been bisected in the median plane.

1. The ventral valve.
2. The dorsal valve.
3. The pedicle.
4. The mouth.
5. Lip which overhangs the mouth heart, numerous muscles and runs all round the lophophore.
6. Tentacles.
7. Ovary in dorsal valve.
8. Liver diverticula.
9. Oculous muscle—its double origin is shown.
10. Internal opening of left nephridium.
11. External opening of the same.
12. Ventral adjustor.
13. Divaricator muscle.
14. Sub-oesophageal nerve ganglion.
15. The heart.
16. Dorsal adjustor muscle.

the nature of a true coelom. The coelom then is a spacious chamber surrounding the alimentary canal, and is continued dorsally and ventrally into the sinuses of the mantle (fig. 21). Some of the endothelial cells lining the coelom are ciliated, the cilia keeping the corpusculated fluid contents in movement. Others of the endothelial cells show a great tendency to form muscle fibres. Besides this main coelomic cavity there are certain other spaces which F. Blochmann regards as coelomic, but it must be remembered that his interpretation rests

largely on histological grounds, and at present embryological confirmation is wanting. These spaces are as follows:—(i.) the great arm-sinus; (ii.) the small arm-sinus together with the central sinus and the peri-oesophageal sinus, and in *Discinisca* and *Lingula*, and, to a less extent, in *Crania*, the lip-sinus; (iii.) certain portions of the general body cavity which in *Crania* are separated off and contain muscles, &c.; (iv.) the cavity of the stalk when such exists. The great arm-sinus of each side of the lophophore lies beneath the fold or lip which together with the tentacles forms the ciliated groove in which the mouth opens. These sinuses are completely shut off from all other cavities, they do not open into the main coelomic space nor into the small arm-sinus, nor does the right sinus communicate with the left. The small arm-sinus runs along the arms of the lophophore at the base of the tentacles, and gives off a blind diverticulum into each of these. This diverticulum contains the blood-vessel and muscle-fibres (fig. 22). In the region of the mouth where the two halves of the small arm-sinus approach one another they open into a central sinus lying beneath the oesophagus and partly walled in by the two halves of the ventral mesentery. This sinus is continued round the oesophagus as the peri-oesophageal sinus, and thus the whole complex of the small arm-sinus has the relations of the so-called vascular system of a Sipunculus. In *Crania* it is completely shut off from the main coelom, but in *Lingula* it communicates freely with this cavity. In *Discinisca* and *Lingula* there is further a lip-sinus or hollow system of channels which traverses the supporting tissue of the edge of the mantle and contains muscle-fibres. It opens into the peri-oesophageal sinus. It is better developed and more spacious in *Lingula* than in *Discinisca*. In *Crania*, where only indications of the lip-sinus occur, there are two other closed spaces. The posterior oclous muscles lie in a special closed space which Blochmann also regards as coelomic. The posterior end of the intestine is similarly surrounded by a closed coelomic space known as the peri-anal sinus in which the rectum lies freely, unsupported by mesenteries. All these spaces contain a similar coagulable fluid with sparse corpuscles, and all are lined by ciliated cells. There is further a great tendency for the endothelial cells to form muscles, and this is especially pronounced in the small arm-sinus, where a conspicuous muscle is built up. The mantle-sinuses which form the chief spaces in the mantle are diverticula of the main coelomic cavity. In *Discinisca* they are provided with a muscular valve placed at their point of origin. They contain the same fluid as the general coelom. The stalk is an extension of the ventral body-wall, and contains a portion of the coelom which, in *Discinisca* and *Lingula*, remains in communication with the general body cavity.

The Alimentary Canal.—The mouth, which is quite devoid of armature, leads imperceptibly into a short and dorsally directed oesophagus. The latter enlarges into a spherical stomach into which open the broad ducts of the so-called liver. The stomach then passes into an intestine, which in the Testicardines (*Articulata*) is short, finger-shaped and closed, and in the Ecardines (*Inarticulata*) is longer, turned back upon its first course, and ends in an anus. In *Lingula* and *Discina* the anus lies to the right in the mantle-cavity, but in *Crania* it opens medianly into a posterior extension of the same. Apart from the asymmetry of the intestine caused by the lateral position of the anus in the two genera just named, Brachiopods are bilaterally symmetrical animals.

The liver consists of a right and left half, each opening by a broad duct into the stomach. Each half consists of many lobes which may branch, and the whole takes up a considerable proportion of

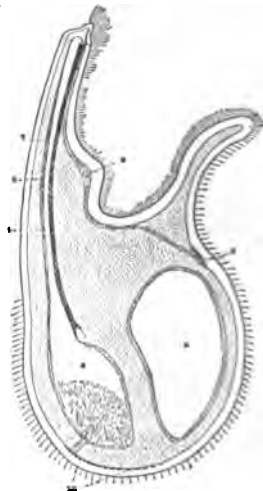

FIG. 22.—Diagrammatic section through an arm of the lophophore of *Cranialia*. Magnified; after Blochmann.

1. The lip.
2. The base of a tentacle bisected in the middle line.
3. Great arm-sinus.
4. Small arm-sinus, containing muscle-fibres.
5. Tentacular canal.
6. External tentacular muscle.
7. Tentacular blood-vessel arising from the cut arm-vessel in the small arm-sinus.
8. Chief arm-nerve.
9. Secondary arm-nerve.
10. Under arm-nerve.

the nature of a true coelom. The coelom then is a spacious chamber surrounding the alimentary canal, and is continued dorsally and ventrally into the sinuses of the mantle (fig. 21). Some of the endothelial cells lining the coelom are ciliated, the cilia keeping the corpusculated fluid contents in movement. Others of the endothelial cells show a great tendency to form muscle fibres. Besides this main coelomic cavity there are certain other spaces which F. Blochmann regards as coelomic, but it must be remembered that his interpretation rests

largely on histological grounds, and at present embryological confirmation is wanting. These spaces are as follows:—(i.) the great arm-sinus; (ii.) the small arm-sinus together with the central sinus and the peri-oesophageal sinus, and in *Discinisca* and *Lingula*, and, to a less extent, in *Crania*, the lip-sinus; (iii.) certain portions of the general body cavity which in *Crania* are separated off and contain muscles, &c.; (iv.) the cavity of the stalk when such exists. The great arm-sinus of each side of the lophophore lies beneath the fold or lip which together with the tentacles forms the ciliated groove in which the mouth opens. These sinuses are completely shut off from all other cavities, they do not open into the main coelomic space nor into the small arm-sinus, nor does the right sinus communicate with the left. The small arm-sinus runs along the arms of the lophophore at the base of the tentacles, and gives off a blind diverticulum into each of these. This diverticulum contains the blood-vessel and muscle-fibres (fig. 22). In the region of the mouth where the two halves of the small arm-sinus approach one another they open into a central sinus lying beneath the oesophagus and partly walled in by the two halves of the ventral mesentery. This sinus is continued round the oesophagus as the peri-oesophageal sinus, and thus the whole complex of the small arm-sinus has the relations of the so-called vascular system of a Sipunculus. In *Crania* it is completely shut off from the main coelom, but in *Lingula* it communicates freely with this cavity. In *Discinisca* and *Lingula* there is further a lip-sinus or hollow system of channels which traverses the supporting tissue of the edge of the mantle and contains muscle-fibres. It opens into the peri-oesophageal sinus. It is better developed and more spacious in *Lingula* than in *Discinisca*. In *Crania*, where only indications of the lip-sinus occur, there are two other closed spaces. The posterior oclous muscles lie in a special closed space which Blochmann also regards as coelomic. The posterior end of the intestine is similarly surrounded by a closed coelomic space known as the peri-anal sinus in which the rectum lies freely, unsupported by mesenteries. All these spaces contain a similar coagulable fluid with sparse corpuscles, and all are lined by ciliated cells. There is further a great tendency for the endothelial cells to form muscles, and this is especially pronounced in the small arm-sinus, where a conspicuous muscle is built up. The mantle-sinuses which form the chief spaces in the mantle are diverticula of the main coelomic cavity. In *Discinisca* they are provided with a muscular valve placed at their point of origin. They contain the same fluid as the general coelom. The stalk is an extension of the ventral body-wall, and contains a portion of the coelom which, in *Discinisca* and *Lingula*, remains in communication with the general body cavity.

the space in the body cavity. The food passes into these lobes, which may be found crowded with diatoms, and without doubt a large part of the digestion is carried on inside the liver. The stomach, oesophagus and intestine are ciliated on their inner surface. The intestine is slung by a median dorsal and ventral mesentery, which divides the body cavity into two symmetrically shaped halves; it is "stayed" by two transverse septa, the anterior or gastro-parietal band running from the stomach to the body wall and the posterior or ileoparietal band running from the intestine to the body wall. None of these septa is complete, and the various parts of the central body cavity freely communicate with one another. In *Rhynchonella*, where there are two pairs of kidneys, the internal opening of the anterior pair is supported by the gastroparietal band and that of the posterior pair by the ileoparietal band. The latter pair alone persists in all other genera.

The kidneys or nephridia open internally by wide funnel-shaped nephridiostomes and externally by small pores on each side of the mouth near the base of the arms. Each is short, gently curved and devoid of convolutions. They are lined by cells charged with a yellow or brown pigment, and besides their excretory functions they act as ducts through which the reproductive cells leave the body.

Circulatory System.—The structures formerly regarded as pseudo-hearts have been shown by Huxley to be nephridia; the true heart was described and figured by A. Hancock, but has in many cases escaped the observation of later zoologists. F. Blochmann in 1884, however, observed this organ in the living animal in species of the following genera:—*Terebratulina*, *Magellania* (*Waldheimia*), *Rhynchonella*, *Megathyris* (*Argiope*), *Lingula* and *Crania* (fig. 21). It consists of a definite contractile sac or sacs lying on the dorsal side of the alimentary canal near the oesophagus, and in preparations of *Terebratulina* made by quickly removing the viscera and examining them in sea-water under a microscope, he was able to count the pulsations, which followed one another at intervals of 30-40 seconds.



FIG. 23.—*Rhynchonella* (*Hemithyris*) *psittacula*. Interior of dorsal valve. *s*, Sockets; *b*, dental plates; *Y*, mouth; *de*, labial appendage in its natural position; *d*, appendage extended or unrolled.

A vessel—the dorsal vessel—runs forward from the heart along the dorsal surface of the oesophagus. This vessel is nothing but a split between the right and left folds of the mesentery, and its cavity is thus a remnant of the blastocoel. A similar primitive arrangement is thought by F. Blochmann to obtain in the genital arteries. Anteriorly the dorsal vessel splits into a right and a left half, which enter the small arm-sinus and, running along it, give off a blind branch to each tentacle (fig. 21). The right and left halves are connected ventrally to the oesophagus by a short vessel which supplies these tentacles in the immediate neighbourhood of the mouth.

There is thus a vascular ring around the oesophagus. The heart gives off posteriorly a second median vessel which divides almost at once into a right and a left half, each of which again divides into two vessels which run to the dorsal and ventral mantles respectively. The dorsal branch sends a blind twig into each of the diverticula of the dorsal mantle-sinus, the ventral branch supplies the nephridia and neighbouring parts before reaching the ventral lobe of the mantle. Both dorsal and ventral branches supply the generative organs.

The blood is a coagulable fluid. Whether it contains corpuscles is not yet determined, but if so they must be few in number. It is a remarkable fact that in *Disciniza*, although the vessels to the lophophore are arranged as in other Brachiopoda, no trace of a heart or of the posterior vessels has as yet been discovered.

Muscles.—The number and position of the muscles differ materially in the two great divisions into which the Brachiopoda have been grouped, and to some extent also in the different genera of which each division is composed. Unfortunately almost every anatomist who has written on the muscles of the Brachiopoda has proposed different names for each muscle, and the confusion thence arising is much to be regretted. In the Testicardines, of which the genus *Terebratula* may be taken as an example, five or six pairs of muscles are stated by A. Hancock, Gratiolet and others to be connected with the opening and closing of the valves, or with their attachment to or movements upon the peduncle. First of all, the adductors or occlusors consist of two muscles, which, bifurcating near the centre of the shell cavity, produce a large quadruple impression on the internal surface of the small valve (fig. 13, *a, a'*), and a single divided one towards the centre of the large or ventral valve (fig. 12, *a*). The function of this pair of muscles is the closing of the valves. Two other pairs have been termed *divaricators* by Hancock, or *cardinal muscles* ("muscles ductores" of Gratiolet), and have for function the opening of the valves. The divaricators proper are stated by Hancock to arise from the ventral valve, one on each side, a little in advance of and close to the adductors, and after

rapidly diminishing in size become attached to the cardinal process, a space or prominence between the sockets in the dorsal valve. The *accessory divaricators* are, according to the same authority, a pair of small muscles which have their ends attached to the ventral valve, one on each side of the median line, a little behind the united basis of the adductors, and again to the extreme point of the cardinal process. Two pairs of muscles, apparently connected with the peduncle and its limited movements, have been minutely described by Hancock as having one of their extremities attached to this organ. The *dorsal adjustors* are fixed to the ventral surface of the peduncle, and are again inserted into the hinge-plate in the smaller valve. The *ventral adjustors* are considered to pass from the inner extremity

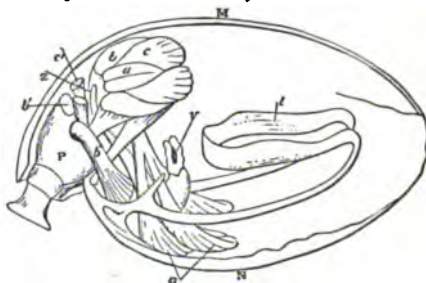
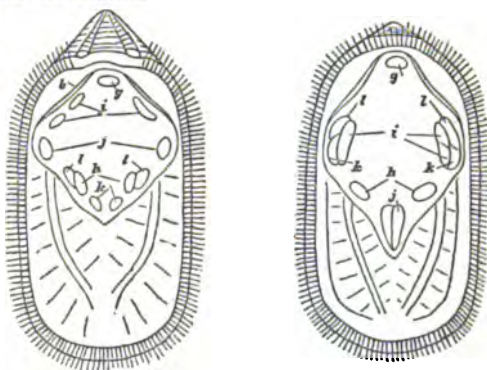

FIG. 24.—*Magellania* [*Waldheimia*] *flavescoens*. Diagram showing the muscular system. (After Hancock.)

M, Ventral. Z, Extremity of intestine. *b*, Ventral adjustors. N, Dorsal valve. *a*, Adductor. *b'*, Peduncular muscles. I, Loop. *c*, Divaricators. *b'*, Dorsal adjustors. V, Mouth. *c'*, Accessory divaricators. P, Peduncle.

of the peduncle, and to become attached by one pair of their extremities to the ventral valve, one on each side and a little behind the expanded base of the divaricators. The function of these muscles, according to the same authority, is not only that of erecting the shell; they serve also to attach the peduncle to the shell, and thus effect the steadying of it upon the peduncle. By alternate contracting they can cause a slight rotation of the animal in its stalk.

Such is the general arrangement of the shell muscles in the division composing the articulated Brachiopoda, making allowance for certain unimportant modifications observable in the animals composing the different families and genera thereof. Owing to the strong and tight interlocking of the valves by the means of curved teeth



FIGS. 25, 26. *Lingula anatina*.

25, Interior of ventral valve. *j, k, l*, Lateral muscles (*j*, anterior; *k*, middle; *l*, outsiders), enabling the valves to move forward and backward on each other. *e*, Umbonal muscular impressions (open valves). *b*, Central muscles (close valves). *f*, Transmedian or sliding muscles. *b*, Parietal band. (After King.)

and sockets, many species of Brachiopoda could open their valves but slightly. In some species, such as *Thecidea*, the animal could raise its dorsal valve at right angles to the plane of the ventral one (fig. 4).

In the Ecardines, of which *Lingula* and *Discina* may be quoted as examples, the myology is much more complicated. Of the shell

or valvular muscles *W. King* makes out five pairs and an odd one, and individualizes their respective functions as follows:—Three pairs are *lateral*, having their members limited to the sides of the shell, one pair are *transmedian*, each member passing across the middle of the reverse side of the shell, while the odd muscle occupies the umbonal cavity. The *central* and *subnodal* muscles effect the direct opening and closing of the shell, the *laterals* enable the valves to move forward and backward on each other, and the *transmedians* allow the similar extremities (the rostral) of the valves to turn from each other to the right or the left on an axis subcentrically situated, that is, the medio-transverse region of the dorsal valve. It was long a matter in discussion whether the animal could displace its valves sideways when about to open its shell, but this has been actually observed by Professors *K. Semper* and *E. S. Morse*, who saw the animal perform the operation. They mention that it is never done suddenly or by jerks, as the valves are at first always pushed to one side several times and back again on each other, at the same time opening gradually in the transverse direction till they rest opposite to one another and widely apart. Those who have not seen the animal in life, or who did not believe in the possibility of the valves crossing each other with a slight obliquity, would not consent to

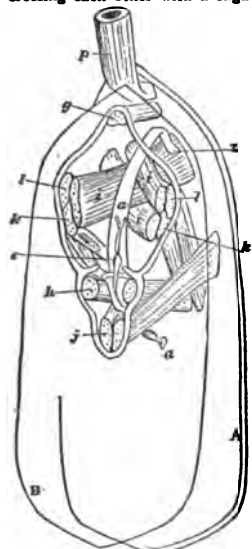

FIG. 27.—*Lingula anatina*. Diagram showing the muscular system. (After Hancock.) The letters indicate the muscles as in figs. 25 and 26.

A, Dorsal. a, Alimentary tube.
B, Ventral valve. s, Anal aperture.
p, Peduncle.

to that purpose, and consequently attributing to all the lateral muscles the simple function of keeping the valves in an opposite position, or holding them adjusted. We have not only the observations of *Semper* and *Morse*, but the anatomical investigations of *King*, to confirm the sliding action or lateral divarication of the valves of *Lingula*. In the *Testicardines*, where no such sliding action of the valves was necessary or possible, no muscles for such an object were required, consequently none took rise from the lateral portions of the valves as in *Lingula*; but in an extinct group, the *Trimerellidae*, which seems to be somewhat intermediate in character between the *Ecardines* and *Testicardines*, have been found certain scars, which appear to have been produced by rudimentary lateral muscles, but it is doubtful (considering the shells are furnished with teeth, though but rudely developed) whether such muscles enabled the valves, as in *Lingula*, to move forward and backward upon each other. *Crasia* in life opens its valves by moving upon the straight hinge, without sliding the valve.

The nervous system of Brachiopods has, as a rule, maintained its primitive connection with the external epithelium. In a few places it has sunk into the connective-tissue supporting layer beneath the ectoderm, but the chief centres still remain in the ectoderm, and the fibrils forming the nerves are for the most part at the base of the ectodermal cells. Above the oesophagus is a thin commissure which passes laterally into the chief arm-nerve. This latter includes in its course numerous ganglion cells, and forms, according to *F. Blochmann*, the immensely long drawn out supra-oesophageal ganglion. The chief arm-nerve traverses the lophophore, being situated between the great arm-sinus and the base of the lip (figs. 22 and 28); it gives off a branch to each tentacle, and these all anastomose at the base of the tentacles with the second nerve of the arm, the so-called secondary arm-nerve. Like the chief arm-nerve, this strand runs through the lophophore, parallel indeed with the former except near the middle line, where it passes ventrally to the oesophagus. The lophophore is supplied by yet a third nerve, the under arm-nerve, which is less clearly defined than the others, and resembles a moderate aggregation of the nerve fibrils, which seem everywhere to underlie the ectoderm, and which in a few cases are gathered up into nerves. The under arm-nerve, which lies between the small arm-sinus and the surface, supplies nerves to the muscles of both arm-sinuses (figs. 22 and 28). Medianly, it has its origin in the sub-oesophageal ganglion, which, like the supra-oesophageal, is drawn out laterally, though not to the same extent. In the middle line the sub-oesophageal nerve mass is small; the ganglion is in fact drawn out into two halves placed on either side of the body. From each of these sub-oesophageal ganglia numerous nerves arise.

Passing from the middle line outwards they are—(i.) the median pallial nerve to the middle of the dorsal mantle; (ii.) numerous small nerves—the circum-oesophageal commissures—which pass round the oesophagus to the chief arm-nerve or supra-oesophageal ganglion; (iii.) the under arm-nerve to the lophophore and its muscles; (iv.) the lateral pallial nerve to the sides of the dorsal mantle. Laterally, the sub-oesophageal ganglia give off (v.) nerves to the ventral mantle, and finally they supply (vi.) branches to the various muscles. There is a special marginal nerve running round the edge of the mantle, but the connexion of this with the rest of the nervous system is not clear; probably it is merely another concentration of the diffused sub-ectodermal nervous fibrils.

The above account applies more particularly to *Crasia*, but in the main it is applicable to the other Inarticulata which have been investigated. In *Disciniscia* and *Lingula*, however, the sub-oesophageal ganglion is not drawn out, but lies medianly; it gives off two posteriorly directed nerves to the stalk, which in *Lingula* unite and form a substantial nerve. Sense organs are unknown in the adult. The larval forms are provided with eye-spots, but no very specialized sense organs are found in the adult.

The histology of Brachiopods presents some peculiar and many primitive features. As a rule the cells are minute, and this has especially stood in the way of embryological research. The pieces of nerve-fibrils which underlie the ectoderm and are in places gathered up into nerves, and the great development of connective hyaline supporting tissue, embedded in which are scattered cells and fibres. The lophophore and stalk are largely composed of this tissue. The ectodermal cells are large, ciliated, and amongst the ciliated cells glandular cells are scattered. The chitinous chaetae have their origin in special ectodermal pits, at the base of which is one large cell which is thought to secrete the chaeta, as in *Chaetopoda*. These pits are not isolated, but are connected by an ectodermal ridge, which grows in at the margin of the mantle and forms a continuous band somewhat resembling the ectodermal primordium of vertebrate teeth.

The ovary and testes are heaped-up masses of red or yellow cells due to a proliferation of the cells lining the coelom. There are four of such masses, two dorsal and two ventral, and as a rule they extend between the outer and inner layer of the mantle lining the shells. The ova and the spermatozoa dehisce into the body cavity and pass to the exterior through the nephridia. Fertilization takes place outside the body, and in some species the early stages of development take place in a brood-pouch which is essentially a more or less deep depression of the body-wall median in *Thecidia*, while in *Cistella* (? *Argiope*) there is one such pouch on each side, just below the base of the arms, and into these the nephridia open. The developing ova are attached by little stalks to the walls of these pouches.

In spite of some assertions to the contrary, all the Brachiopods which have been carefully investigated have been found to be male or female. Hermaphrodite forms are unknown.

Embryology.—With the exception of *Yatsu's* article on the development of *Lingula* (*J. Coll. Sci., Japan*, xvii., 1901-1903) and *E. G. Conklin's* on "Terebratulina septentrionalis" (*P. Amer. Phil. Soc.*, xii., 1902), little real advance has been made in our knowledge of the embryology of the Brachiopoda within recent years. *Kovalevsky's* researches (*Izv. Obshch. Moskov.* xiv., 1874) on *Megathyris* (*Argiope*) and *Yatsu's* just mentioned are the most complete as

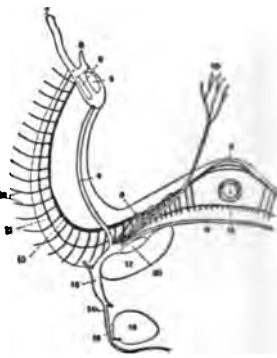

FIG. 28.—Diagram of nervous system of *Crasia*; from the dorsal side. The nerves running to the dorsal parts are white, with black edges; those running to the ventral parts are solid black. Magnified. (After Blochmann.)

1. Oesophagus.
2. Supra-oesophageal commissure.
3. Circum-oesophageal commissures.
4. Under arm-nerve.
5. Great arm-nerve.
6. Small arm-nerve.
7. Tentacle.
8. Lip of lophophore.
9. Infra-oesophageal commissure.
10. Chief arm-nerve.
11. Secondary arm-nerve.
12. Nerves to tentacles.
13. Supra-oesophageal ganglion.
14. Dorsal lateral nerve.
15. Sub-oesophageal portion of the secondary arm-nerve.
16. Median pallial nerve of dorsal lobe of mantle.
17. Anterior ocluctor muscle.
18. Posterior ocluctor muscle.
19. Obliquus superior muscle.
20. Levator brachii muscle.

regards the earlier stages. Segmentation is complete, a gastrula is formed, the blastopore closes, the archenteron gives off two coelomic sacs which, as far as is known, are unaffected by the super-

lophophore has begun to appear as an outgrowth of the dorsal mantle lobe. The protegulum has been found in members of almost all the families of Brachiopod, and it is thought to occur throughout the group. It resembles the shell of the Cambrian genus *Iphidea* [Paterina], and the Phylembryo is frequently referred to as the Paterina stage. In some orders the Phylembryo is succeeded by an *Obolella* stage with a nearly circular outline, but this is not universal. The larva now assumes specific characters and is practically adult.

Classification.—Beecher's division of the Brachiopoda into four orders is based largely on the character of the aperture through which the stalk or pedicle leaves the shell. To appreciate his diagnoses it is necessary to understand certain terms, which unfortunately are not used in the same sense by all authors. The triangular pedicle-opening seen in *Orthis*, &c., has been named by James Hall and J. M. Clarke the delthyrium. In some less primitive genera, e.g. *Terebratula*, that type of opening is found in the young stages only; later it becomes partly closed by two plates which grow out from the sides of the delthyrium. These plates are named by von Buch in 1834 the "deltidium." The form of the deltidium varies in different genera. The two plates may meet in the middle line, and leave only a small oval opening near the centre for the pedicle, as in *Rhynchonella*; or they may meet only near the base of the delthyrium forming the lower boundary of the circular pedicle-opening, as in *Terebratula*; or the right plate may remain quite distinct from the left plate, as in *Terebratula*. The pro-deltidium, a term introduced by Hall and Clarke, signifies a small embryonic plate originating on the dorsal side of the body. It subsequently becomes attached

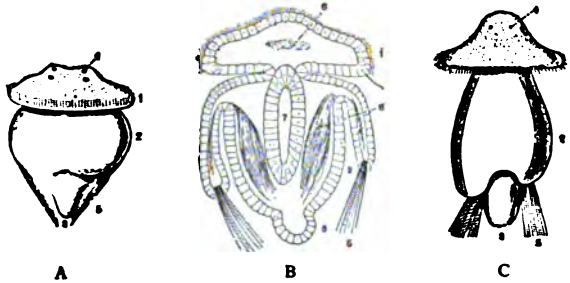

FIG. 29.—Three larval stages of *Megathyris* (*Argiopo*). A, Larva which has just left brood-pouch; B, longitudinal section through a somewhat later stage; C, the fully formed embryo just before fixing—the neo-embryo of Beecher. Highly magnified.

1. Anterior segment.
2. Second or mantle-forming segment.
3. Third or stalk-forming segment.
4. Eye-spots.
5. Setae.
6. Nerve mass (?).
7. Alimentary canal.
8. Muscles.

facial segmentation of the body that divides the larva into three segments. The walls of these sacs give rise at an early stage to muscles which enable the parts of the larva to move actively on one another (fig. 29, B). About this stage the larvae leave the brood-pouch, which is a lateral or median cavity in the body of the female, and lead a free swimming life in the ocean. The anterior segment broadens and becomes umbrella-shaped; it has a powerful row of cilia round the rim and smaller cilia on the general surface. By the aid of these cilia the larva swims actively, but owing to its minute size it covers very little distance, and this probably accounts for the fact that where brachiopods occur there are, as a rule, a good many in one spot. The head bears four eye-spots, and it is continually testing the ground (fig. 29, A, C). The second segment grows downwards like a skirt surrounding the third segment, which is destined to form the stalk. It bears at its rim four bundles of very pronounced chaetae. After a certain time the larva fixes itself by its stalk to some stone or rock, and the skirt-like second segment turns forward over the head and forms the mantle. What goes on within the mantle is unknown, but presumably the head is absorbed. The chaetae drop off, and the lophophore is believed to arise from thickenings which appear in the dorsal mantle lobe. The Plankton Expedition brought back, and H. Simroth (*Ergeb. Plankton Expedition, ii.*, 1897) has described, a few larval brachiopods of undetermined genera, two of which at least were pelagic, or at any rate taken far from the coast. These larvae, which resemble those described by Fritz Müller (*Arch. Naturg.*, 1861-1862), have their mantle turned over their head and the larval shell well developed. No stalk has been seen by Simroth or Fritz Müller, but in other respects the larva resembles the stages in the development of *Megathyris* and *Terebratulina*, which immediately precede fixation. The cirri or tentacles, of which three or four pairs are present, are capable of being protruded, and the minute larva swims by means of the ciliary action they produce. It can retract the tentacles, shut its shell, and sink to the bottom.

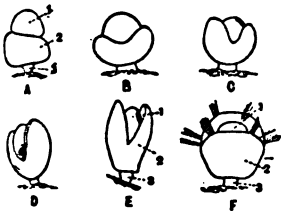

FIG. 30.—Stages in the fixing and metamorphosis of *Terebratulina*. Highly magnified. (From Morse.)

A. Larva (neo-embryo) just come to rest.
 B, C, D, Stages showing the turning forward of the second or mantle segment.
 E, Completion of this.
 F, Young Brachiopod.
 1, 2, 3, The first, second and third segments.
 C. E. E. Beecher (*Amer. Jour. Sci.* ser. 3, xli. and xlii.) has classified with appropriate names the various stages through which Brachiopod larvae pass. The last stage, that in which the folds of the second segment are already reflected over the first, he calls the Tyembryo. Either before or just after turning, the mantle develops a larval shell termed the protegulum, and when this is completed the larva is termed the Phylembryo. By this time the eyes have disappeared, the four bundles of chaetae have dropped off, and the

pro-deltidium, a term introduced by Hall and Clarke, signifies a small embryonic plate originating on the dorsal side of the body. It subsequently becomes attached

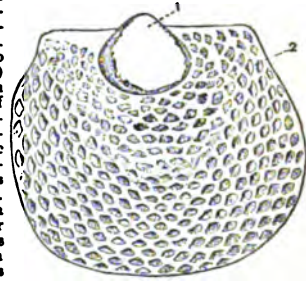

FIG. 31.—Shell of larval Brachiopod. Phylembryo stage. (From Simroth.) 1, Protegulum; 2, permanent shell.

The American use of the term deltidium for the structure which Europeans call the pseudo-deltidium makes for confusion. The development of the brachial supports has been studied by Friele, Fischer and Oehlert. A summary of the results is given by Beecher (*Trans. Connect. Acad.* ix., 1893; reprinted in *Studies in Evolution*, 1901).

The orders *Atremata* and *Neotremata* are frequently grouped together, as the sub-class *Inarticulata* or *Ecardines*—the *Treterata* of Davidson—and the orders *Protremata* and *Telotremata*, as the *Articulata* or *Testicardines*—the *Clistenterata* of Davidson. The following scheme of classification is based on Beecher's and Schubert's. Recent families are printed in italic type.

Class I. ECARDINES (INARTICULATA)
ORDER I. Atremata (Beecher).—Inarticulate Brachiopoda, with the pedicle passing out between the umbones, the opening being shared by both valves. Pro-deltidium attached to dorsal valves. **FAMILIES.**—*PATERINIDAE*, *OBOLIDAE*, *TRIMEURELLIDAE*, *LINGULELLIDAE*, *LINGULIDAE*, *LIGULASMATIDAE*.

ORDER II. Neotremata (Beecher).—More or less circular, cone-shaped, inarticulate Brachiopoda. The pedicle passes out at right angles to the plane of junction of the valves of the shell; the opening is confined to the ventral valve, and may take the form of a slit, or may be closed by the development of a special plate called the listrium, or by a pseudo-deltidium. Pro-deltidium attached

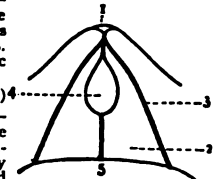

FIG. 32.—Diagram of the pedicle-opening of *Rhynchonella*. Magnified.

to ventral valve. FAMILIES.—ACROTRETIDAE, SIPHONOTRETIDAE, TREMATIDAE, DISCINIDAE, CRANIIDAE.

Class II. TESTICARDINES (ARTICULATA)

ORDER III. Protremata (Beecher).—Articulate Brachiopoda, with pedicle-opening restricted to ventral valve, and either open at the hinge line or more or less completely closed by a pseudo-deltidium, which may disappear in adult. The pro-deltidium originating on the dorsal surface later becomes ankylosed with the ventral valve. FAMILIES.—KUTORGINIDAE, EICHWALDIDAE, BILLINGSIDAE, STROPHOMENIDAE, THECIDIIDAE, PROCTIDAE, RICHTHOFENIDAE, ORTHIDAE, CLITAMBONITIDAE, SYNTROPHIIDAE, FORAMBONITIDAE, PENTAMERIDAE.

ORDER IV. Tetotremata (Beecher).—Articulate Brachiopoda, with the pedicle-opening, confined in later life to the ventral valve, and placed at the umbo or beneath it. Deltidium present, but no pro-deltidium. Lophophore supported by calcareous loops, &c. FAMILIES.—PRORHYNCHIDAE, REYNSCHONELLIDAE, CENTRONELLIDAE, TEREBRATULIDAE, STRINGOCEPHALIDAE, MEGALANTERIDAE, TEREBRATELLIDAE, ATRYPIDAE, SPIRIFERIDAE, ATHYRIDAE.

Affinities.—Little light has been thrown on the affinities of the Brachiopoda by recent research, though speculation has not been wanting. Brachiopods have been at various times placed with the Mollusca, the Chaetopoda, the Chaetognatha, the Phoronidea, the Polyzoa, the Hemichordata, and the Urochordata. None of these alliances has borne close scrutiny. The suggestion to place Brachiopods with the Polyzoa, *Phoronis*, *Rhabdopleura* and *Cephalodiscus*, in the Phylum Podaxonia made in *Ency. Brit.* (vol. xix, ninth edition, pp. 440-441) has not met with acceptance, and until we have a fuller account of the embryology of some one form, preferably an inarticulate, it is wiser to regard the group as a very isolated one. It may, however, be pointed out that Brachiopods seem to belong to that class of animal which commences life as a larva with three segments, and that tri-segmented larvae have been found now in several of the larger groups.

Distribution.—Brachiopods first appear in the Lower Cambrian, and reached their highest development in the Silurian, from which upwards of 2000 species are known, and were nearly as numerous in the Devonian period; at present they are represented by some 140 recent species. The following have been found in the British area, as defined by A. M. Norman, *Terebratulina caput-serpentis* L., *Terebratula (Gwynia) capsula* Jeff., *Magellana (Macandrewia) cranium* Mull., *M. septifera* Lovén, *Terebratella spitzbergenensis* Dav., *Megakylis decollata* Chemn., *Cistella cistellula* S. Wood, *Cryptopora guononi* Jeff., *Rhynchonella (Hemithyris) pitulacea* Gmel., *Crania anomala* Mull., and *Discinella atlantica* Keil. About one-half the 120 existing species are found above the 100-fathoms line. Below 150 fathoms they are rare, but a few such as *Terebratulina weyillei* are found down to 2000 fathoms. *Lingula* is essentially a very shallow water form. As a rule the genera of the northern hemisphere differ from those of the southern. A large number of specimens of a species are usually found together, since their only mode of spreading is during the ciliated larval stage, which although it swims vigorously can only cover a few millimetres an hour; still it may be carried some little distance by currents.

Undue stress is often laid on the fact that *Lingula* has come down to us apparently unchanged since Cambrian times, whilst *Crania*, and forms very closely resembling *Discina* and *Rhynchonella*, are found from the Ordovician strata onwards. The former statement is, however, true of animals from other classes at least as highly organized as Brachiopods, e.g. the Gasteropod *Capulus*, whilst most of the invertebrate classes were represented in the Ordovician by forms which do not differ from their existing representatives in any important respect.

A full bibliography of Brachiopoda (recent and fossil) is to be found in Davidson's Monograph of British Fossil Brachiopods, *Pal. Soc. Mon. vi.*, 1886. The Monograph on Recent Brachiopoda, by the same author, *Tr. Linn. Soc. London, Zool. ser. ii. vol. iv.*, 1886-1888, must on no account be omitted. (A. E. S.)

BRACHISTOCHROME (from the Gr. *βραχυστος*, shortest, and *χρονος*, time), a term invented by John Bernoulli in 1694 to denote the curve along which a body passes from one fixed point to another in the shortest time. When the directive force is constant, the curve is a cycloid (q.v.); under other conditions, spirals and other curves are described (see MECHANICS).

BRACHYCEPHALIC (Gr. for short-headed), a term invented by Andreas Retzius to denote those skulls of which the width from side to side was little less than the length from front to back, their ratio being as 80 to 100, as in those of the Mongolian type. Thus taking the length as 100, if the width exceeds 80, the skull is to be classed as brachycephalic. The prevailing form of the head of civilized races is brachycephalic. It is supposed that a brachycephalic race inhabited Europe before the Celts. Among those peoples whose heads show marked brachycephaly

are the Indo-Chinese, the Savoyards, Croats, Bavarians, Lapps, Burmese, Armenians and Peruvians. (See CRANIOMETRY.)

BRACHYLOGUS (from Gr. *βραχίς*, short, and *λόγος*, word), title applied in the middle of the 16th century to a work containing a systematic exposition of the Roman law, which some writers have assigned to the reign of the emperor Justinian, and others have treated as an apocryphal work of the 16th century. The earliest extant edition of this work was published at Lyons in 1549, under the title of *Corpus Legum per modum Institutionum*; and the title *Brachylogus totius Juris Civilis* appears for the first time in an edition published at Lyons in 1553. The origin of the work may be referred with great probability to the 12th century. There is internal evidence that it was composed subsequently to the reign of Louis le Débonnaire (778-840), as it contains a Lombard law of that king's, which forbids the testimony of a clerk to be received against a layman. On the other hand its style and reasoning is far superior to that of the law writers of the 10th and 11th centuries; while the circumstance that the method of its author has not been in the slightest degree influenced by the school of the Gloss-writers (Glossatores) leads fairly to the conclusion that he wrote before that school became dominant at Bologna. Savigny, who traced the history of the *Brachylogus* with great care, is disposed to think that it is the work of Irenaeus himself (*Geschichte des röm. Rechts im Mittelalter*). Its value is chiefly historical, as it furnishes evidence that a knowledge of Justinian's legislation was always maintained in northern Italy. The author of the work has adopted the *Institutes* of Justinian as the basis of it, and draws largely on the *Digest*, the *Code* and the *Novels*; while certain passages, evidently taken from the *Sententiae Receptae* of Julius Paulus, imply that the author was also acquainted with the Visigothic code of Roman law compiled by order of Alaric II.

An edition by E. Bocking was published at Berlin in 1829, under the title of *Corpus Legum sive Brachylogus Juris Civilis*. See also H. Fitting, *Über die Heimath und das Alter des sogenannten Brachylogus* (Berlin, 1880).

BRACKET, in architecture and carpentering, a projecting feature either in wood or metal for holding things together or supporting a shelf. The same feature in stone is called a "console" (q.v.). In furniture it is a small ornamental shelf for a wall or a corner, to bear knick-knacks, china or other bric-à-brac. The word has been referred to "brace," Lat. *bracchium*, arm, but the earliest form "bragget" (1580) points to the true derivation from the Fr. *braguete*, or Span. *bragueta* (Lat. *bracae*, breeches), used both of the front part of a pair of breeches and of the architectural feature. The sense development is not clear, but it has no doubt been influenced by the supposed connexion with "brace."

BRACKET-FUNGI. The term "bracket" has been given to those hard, woody fungi that grow on trees or timber in the form of semicircular brackets. They belong to the order *Polyporaceae*, distinguished by the layer of tubes or pores on the under surface within which the spores are borne. The mycelium, or vegetable part of the fungus, burrows in the tissues of the tree, and often destroys it; the "bracket" represents the fruiting stage, and produces innumerable spores which gain entrance to other trees by some wound or cut surface; hence the need of careful forestry. Many of these woody fungi persist for several years, and a new layer of pores is superposed on the previous season's growth.

BRACKLESHAM BEDS, in geology, a series of clays and marls, with sandy and lignitic beds, in the Middle Eocene of the Hampshire Basin, England. They are well developed in the Isle of Wight and on the mainland opposite; and receive their name from their occurrence at Bracklesham in Sussex. The thickness of the deposit is from 100 to 400 ft. Fossil mollusca are abundant, and fossil fish are to be found, as well as the *Palaeophis*, a sea-snake. Nummulites and other foraminifera also occur. The Bracklesham Beds lie between the Barton Clay above and the Bournemouth Beds, Lower Bagshot, below. In the London Basin these beds are represented only by thin

sandy clays in the Middle Bagshot group. In the Paris Basin the "Calcaire grossier" lies upon the same geological horizon.

See F. Dixon, *Geology of Sussex* (new ed., 1878); F. E. Edwards and S. V. Wood, "Monograph of Eocene Mollusca," *Palaontographica* Ser. vol. 1. (1847-1877); "Geology of the Isle of Wight," *Ann. Geol. Survey* (2nd ed., 1889); C. Reid, "The Geology of the Country around Southampton," *Mem. Geol. Survey* (1902).

BRACKLEY, THOMAS EGERTON, VISCOUNT (c. 1540-1617), English lord chancellor, was a natural son of Sir Richard Egerton of Ridley, Cheshire. The exact date of his birth is unrecorded, but, according to Wood,¹ when he became a commoner at Brasenose College, Oxford, in 1556, he was about seventeen. He entered Lincoln's Inn in 1559, and was called to the bar in 1572, being chosen a governor of the society in 1580, Lent reader in 1582, and treasurer in 1588. He early obtained legal renown and a large practice, and tradition relates that his skilful conduct of a case against the crown gained the notice of Elizabeth, who is reported to have declared: "In my troth he shall never plead against me again." Accordingly, on the 26th of June 1581, he was made solicitor-general. He represented Cheshire in the parliaments of 1585 and 1586, but in his official capacity he often attended in the House of Lords. On the 3rd of March 1589 the Commons desired that he should return to their house, the Lords refusing on the ground that he was called by the queen's writ to attend in the Lords before his election by the House of Commons.² He took part in the trial of Mary, queen of Scots, in 1586, and advised that in her indictment she should only be styled "commonly called queen of Scots," to avoid scruples about judging a sovereign. He conducted several other state prosecutions. On the 2nd of June 1592 he was appointed attorney-general, and was knighted and made chamberlain of Chester in 1593. On the 10th of April 1594 he became master of the rolls, and on the 6th of May 1596 lord keeper of the great seal and a privy councillor, remaining, however, a commoner as Sir Thomas Egerton, and presiding in the Lords as such during the whole reign of Elizabeth. He kept in addition the mastership of the rolls, the whole work of the chancery during this period falling on his shoulders and sometimes causing inconvenience to suitors.³ His promotion was welcomed from all quarters. "I think no man," wrote a contemporary to Essex, "ever came to this dignity with more applause than this worthy gentleman."⁴

Egerton became one of the queen's most trusted advisers and one of the greatest and most striking figures at her court. He was a leading member of the numerous special commissions, including the ecclesiastical commission, and was the queen's interpreter in her communications to parliament. In 1598 he was employed as a commissioner for negotiating with the Dutch, obtaining great credit by the treaty then effected, and in 1600 in the same capacity with Denmark. In 1597, in consequence of his unlawful marriage with his second wife, in a private house without banns, the lord keeper incurred a sentence of excommunication, and was obliged to obtain absolution from the bishop of London.⁵ He was a firm friend of the noble but erratic and unfortunate Essex. He sought to moderate his violence and rashness, and after the scene in the council in July 1598, when the queen struck Essex and bade him go and be hanged, he endeavoured to reconcile him to the queen in an admirable letter which has often been printed.⁶ On the arrival of Essex in London without leave from Ireland, and his consequent disgrace, he supported the queen's just authority, avoiding at the same time any undue severity to the offender. Essex was committed to his custody in York House from the 1st of October 1599 till the 5th of July 1600, when the lord keeper used his influence to recover for him the queen's favour and gave him kindly warnings concerning the necessity for caution in his conduct. On the 5th of June 1600 he presided over the court held at his house, which deprived Essex of his offices except that of master of the horse, treating him with

leniency, not pressing the charge of treason but only that of disobedience, and interrupting him with kind intentions when he attempted to justify himself. After the trial he tried in vain to bring Essex to a sense of duty. On the 8th of February 1601, the day fixed for the rebellion, the lord keeper with other officers of state visited Essex at Essex House to demand the reason of the tumultuous assemblage. His efforts to persuade Essex to speak with him privately and explain his "griets," and to refrain from violence, and his appeal to the company to depart peacefully on their allegiance, were ineffectual, and he was imprisoned by Essex for six hours, the mob calling out to kill him and to throw the great seal out of the window. Subsequently he abandoned all hope of saving Essex, and took an active part in his trial. On the 13th of February he made a speech in the Star Chamber, exposing the wickedness of the rebellion, and of the plot of Thomas Lea to surprise Elizabeth at her chamber door.⁷ In July 1602, a few months before her death, Elizabeth visited the lord keeper at his house at Harefield in Middlesex, and he was one of those present during her last hours who received her faltering intimation as to her successor.

On the accession of James I., Sir Thomas Egerton was re-appointed lord keeper, resigning the mastership of the rolls in May 1603, and the chamberlainship of Chester in August. On the 21st of July he was created Baron Ellesmere, and on the 24th lord chancellor. His support of the king's prerogative was too faithful and indiscriminating. He approved of the harsh penalty inflicted upon Oliver St John in 1615 for denying the legality of benevolences, and desired that his sentencing of the prisoner "might be his last work to conclude his services."⁸ In May 1613 he caused the committal of White Locke to the Fleet for questioning the authority of the earl marshal's court. In 1604 he came into collision with the House of Commons. Sir Francis Goodwin, an outlaw, having been elected for Buckinghamshire contrary to the king's proclamation, the chancellor cancelled the return when made according to custom into chancery, and issued writs for a new election. The Commons, however, considering their privileges violated, restored Goodwin to his seat, and though the matter was in the present instance compromised by the choice of a third party, they secured for the future the right of judging in their own elections. He was at one with James in desiring to effect the union between England and Scotland, and served on the commission in 1604; and the English merchants who opposed the union and community of trade with the Scots were "roundly shaken by him." In 1608, in the great case of the Post Nati, he decided, with the assistance of the fourteen judges, that those born after the accession of James I. to the throne of England were English subjects and capable of holding lands in England; and he compared the two dissentient judges to the apostle Thomas, whose doubts only confirmed the faith of the rest. He did not, however, always show obedience to the king's wishes. He opposed the latter's Spanish policy, and in July 1615, in spite of James's most peremptory commands and threats, refused to put the great seal to the pardon of Somerset. In May 1616 he officiated as high steward in the trial of the latter and his countess for the murder of Overbury. He was a rigid churchman, hostile to both the Puritans and the Roman Catholics. He fully approved of the king's unfriendly attitude towards the former, adopted at the Hampton Court conference in 1604, and declared, in admiration of James's theological reasoning on this occasion, that he had never understood before the meaning of the legal maxim, *Rex est mixta persona cum sacerdote*. In 1605 he opposed the petition for the restitution of deprived Puritan ministers, and obtained an opinion from the judges that the petition was illegal. He supported the party of Abbot against Laud at Oxford, and represented to the king the unfitness of the latter to be president of St John's College. In 1605 he directed the judges to enforce the penal laws against the Roman Catholics.

His vigorous and active public career closed with a great victory gained over the common law and his formidable

¹ *Athenae Oxon.* (Bliss), ii. 197.

² D'Ewes's *Parliaments of Elizabeth*, 441, 442.

³ *Cal. of St. Pap., Dom.*, 1601-1603, p. 191.

⁴ Birch's *Mem. of Queen Elizabeth*, i. 479.

⁵ *Hist. MSS. Comm.* 11th Rep. p. 24.

⁶ Birch's *Mem. of Queen Elizabeth*, ii. 384.

⁷ *Cal. of St. Pap., Dom.*, 1598-1601, pp. 554, 583.

⁸ *State Trials*, ii. 909.

antagonist, Sir Edward Coke. The chancellor's court of equity had originated in the necessity for a tribunal to decide cases not served by the common law, and to relax and correct the rigidity and insufficiency of the latter's procedure. The two jurisdictions had remained bitter rivals, the common-law bar complaining of the arbitrary and unrestricted powers of the chancellor, and the equity lawyers censuring and ridiculing the failures of justice in the courts of common law. The disputes between the courts, concerning which the king had already in 1615 remonstrated with the chancellor and Sir Edward Coke,¹ the lord chief justice, came to a crisis in 1616, when the court of chancery granted relief against judgments at common law in the cases of *Heath v. Rydley* and *Courtney v. Granvil*. This relief was declared by Coke and other judges sitting with him to be illegal, and a counter-attack was made by a praemunire, brought against the parties concerned in the suit in chancery. The grand jury, however, refused to bring in a true bill against them; in spite of Coke's threats and assurances that the chancellor was dead, and the dispute was referred to the king himself, who after consulting his counsel and on Bacon's advice decided in favour of equity. The chancellor's triumph was a great one, and from this time the equitable jurisdiction of the court of chancery was unquestioned. In June 1616 he supported the king in his dispute with and dismissal of Coke in the case of the *commendams*, agreeing with Bacon that it was the judge's duty to communicate with the king, before giving judgments in which his interests were concerned, and in November warned the new lord chief justice against imitating the errors of his predecessor and especially his love of "popularity."² Writing in 1609 to Salisbury, the chancellor had described Coke (who had long been a thorn in his flesh) as a "frantic, turbulent and idle broken brayned fellow," apologizing for so often troubling Salisbury on this subject, "no fit exercise for a chancellor and a treasurer."³ He now summoned Coke before him and communicated to him the king's dissatisfaction with his *Reports*, desiring, however, to be spared further service in his disgracing. After several petitions for leave to retire through failing health, he at last, on the 3rd of March 1617, delivered up to James the great seal, which he had held continuously for the unprecedented term of nearly twenty-one years. On the 7th of November 1616 he had been created Viscount Brackley, and his death took place on the 15th of March 1617. Half an hour before his decease James sent Bacon, then his successor as lord keeper, with the gift of an earldom, and the presidentship of the council with a pension of £3000 a year, which the dying man declined as earthly vanities with which he had no more concern. He was buried at Dodleston in Cheshire.

As Lord Chancellor Ellesmere he is a striking figure in the long line of illustrious English judges. No instance of excessive or improper use of his jurisdiction is recorded, and the famous case which precipitated the contest between the courts was a clear travesty of justice, undoubtedly fit for the chancellor's intervention. He refused to answer any communications from suitors in his court,⁴ and it was doubtless to Ellesmere (as weeding out the "enormous sin" of judicial corruption)⁵ that John Donne, who was his secretary, addressed his fifth satire. He gained Camden's admiration, who records an anagram on his name, "Gestat Honorem." Bacon, whose merit he had early recognized, and whose claims to the office of solicitor-general he had unavailingly supported both in 1594 and 1606, calls him "a true sage, a salvia in the garden of the state," and speaks with gratitude of his "fatherly kindness." Ben Jonson, among the poets, extolled in an epigram his "wing'd judgements," "purest hands," and constancy. Though endowed with considerable oratorical gifts he followed the true judicial tradition and affected to despise eloquence as "not decorum for judges, that ought to respect the Matter and not the Humours of the

Hearers."⁶ Like others of his day he hoped to see a codification of the laws,⁷ and appears to have had greater faith in judge-made law than in statutes of the realm, advising the parliament (October 27, 1601) "that laws in force might be revised and explained and no new laws made," and describing the Statute of Wills passed in Henry VIII.'s reign as the "ruin of ancient families" and "the nurse of forgeries." In the thirty-eighth year of Elizabeth he drew up rules for procedure in the Star Chamber,⁸ restricting the fees, and in the eighth of James I. ordinances for remedying abuses in the court of chancery. In 1609 he published his judgment in the case of the *Post Nati*, which appears to be the only certain work of his authorship. The following have been ascribed to him:—*The Privileges and Prerogatives of the High Court of Chancery* (1641); *Certain Observations concerning the Office of the Lord Chancellor* (1651)—denied by Lord Chancellor Hardwicke in *A Discourse of the Judicial Authority of the Master of the Rolls* (1728) to be Lord Ellesmere's work; *Observations on Lord Coke's Reports*, ed. by G. Paul (about 1710), the only evidence of his authorship being apparently that the MS. was in his handwriting; four MSS., bequeathed to his chaplain, Bishop Williams, viz. *The Prerogative Royal, Privileges of Parliament, Proceedings in Chancery and The Power of the Star Chamber; Notes and Observations on Magna Charta, &c.*, Sept. 1615 (Harl. 4265, f. 35), and *An Abridgment of Lord Coke's Reports* (see MS. note by F. Hargrave in his copy of *Certain Observations concerning the Office of Lord Chancellor*, Brit. Mus. 510 a 5, also *Life of Egerton*, p. 80, note T, catalogue of Harleian collection, and Walpole's *Royal and Noble Authors*, 1806, ii. 170).

He was thrice married. By his first wife, Elizabeth, daughter of Thomas Ravenscroft of Bretton, Flintshire, he had two sons and a daughter. The elder son, Thomas, predeceased him, leaving three daughters. The younger, John, succeeded his father as 2nd Viscount Brackley, was created earl of Bridgewater, and marrying Lady Frances Stanley (daughter of his father's third wife, widow of the 5th earl of Derby), was the ancestor of the earls and dukes of Bridgewater (q.v.), whose male line became extinct in 1829. In 1846 the titles of Ellesmere and Brackley were revived in the person of the 1st earl of Ellesmere (q.v.), descended from Lady Louisa Egerton, daughter and co-heir of the 1st duke of Bridgewater.

No adequate life of Lord Chancellor Ellesmere has been written, for which, however, materials exist in the Bridgewater MSS., very scantily calendared in *Hist. MSS. Comm.* 11th Rep. p. 24, and app. pt. vii. p. 126. A small selection, with the omission, however, of personal and family matters intended for a separate projected *Life* which was never published, was edited by J. P. Collier for the Camden Society in 1840.

BRACKLEY, a market town and municipal borough in the southern parliamentary division of Northamptonshire, England, 59 m. N.W. by W. from London by the Great Central railway; served also by a branch of the London & North-Western railway. Pop. (1901) 2467. The church of St Peter, the body of which is Decorated and Perpendicular, has a beautiful Early English tower. Magdalen College school was founded in 1447 by William of Waynflete, bishop of Winchester, bearing the name of his great college at Oxford. Of a previous foundation of the 12th century, called the Hospital of St John, the transitional Norman and Early English chapel remains. Brewing is carried on. The borough is under a mayor, 4 aldermen and 12 councillors. Area, 3489 acres.

Brackley (Brachelai, Brackele) was held in 1086 by Earl Alberic, from whom it passed to the earl of Leicester and thence to the families of De Quinci and Holand. Brilliant tournaments were held in 1249 and 1267, and others were prohibited in 1223 and 1244. The market, formerly held on Sunday, was changed in 1218 to Wednesday, and in answer to a writ of *Quo Warranto* Maud de Holand claimed in 1330 that her family had held a fair on St Andrew's day from time immemorial. In 1553 Mary granted two fairs to the earl of Derby. By charter of 1686

¹ *Cal. St. Pap., Dom.*, 1611-1618, p. 381.

² *Cal. St. Pap., Dom.*, 1611-1618, p. 407.

³ *Lansdowne MS.* 91, f. 41.

⁴ *Hist. MSS. Comm.* app. pt. vii. p. 156.

⁵ *Life of Donne*, by E. Gosse, i. 43.

⁶ Judgment on the *Post Nati*.

⁷ Speech to the parliament, 24th of October 1597.

⁸ *Harleian MS.* 2310, f. i.; Gardiner's *Hist. of England*, ix. 56.

James II. incorporated the town under a mayor, 6 aldermen, and 26 burgesses, granted three new fairs and confirmed the old fair and market. In 1708 Anne granted four fairs to the earl of Bridgewater, and in 1886 the borough had a new charter of incorporation under a mayor, 4 aldermen and 12 councillors under the Municipal Corporations Act of 1882. Camden (*Brit. p. 430*) says that Brackley was formerly a famous staple for wool. It first sent members to parliament in 1547, and continued to send two representatives till disfranchised by the Reform Act of 1832. The town formerly had a considerable woollen and lace-making trade.

BRACQUEMOND, FÉLIX (1833-), French painter and etcher, was born in Paris. He was trained in early youth as a trade lithographer, until Guichard, a pupil of Ingres, took him to his studio. His portrait of his grandmother, painted by him at the age of nineteen, attracted Théophile Gautier's attention at the Salon. He applied himself to engraving and etching about 1853, and played a leading and brilliant part in the revival of the etcher's art in France. Altogether he has produced over eight hundred plates, comprising portraits, landscapes, scenes of contemporary life, and bird-studies, besides numerous interpretations of other artists' paintings, especially those of Meissonier, Gustave Moreau and Corot. After having been attached to the Sèvres porcelain factory in 1870, he accepted a post as art manager of the Paris *atelier* of the firm of Haviland of Limoges. He was connected by a link of firm friendship with Manet, Whistler, and all the other fighters in the Impressionist cause, and received all the honours that await the successful artist in France, including the grade of officer of the Legion of Honour in 1889.

BRACTON, HENRY DE (d. 1268), English judge and writer on English law. His real name was Bratton, and in all probability he derived it either from Bratton Fleming or from Bratton Clovelly, both of them villages in Devonshire. It is only after his death that his name appears as "Bracton." He seems to have entered the king's service as a clerk under the patronage of William Raleigh, who after long service as a royal justice died bishop of Winchester in 1250. Bracton begins to appear as a justice in 1245, and from 1248 until his death in 1268 he was steadily employed as a justice of assize in the south-western counties, especially Somerset, Devon and Cornwall. During the earlier part of this period he was also sitting as a judge in the king's central court, and was there hearing those pleas which "followed the king"; in other words, he was a member of that section of the central tribunal which was soon to be distinguished as the king's bench. From this position he retired or was dismissed in or about the year 1257, shortly before the meeting of the Mad Parliament at Oxford in 1258. Whether his disappearance is to be connected with the political events of this turbulent time is uncertain. He continued to take the assizes in the south-west, and in 1267 he was a member of a commission of prelates, barons and judges appointed to hear the complaints of the disinherited partisans of Simon de Montfort. In 1259 he became rector of Combe-in-Teignhead, in 1261 rector of Barnstaple, in 1264 archdeacon of Barnstaple, and, having resigned the archdeaconry, chancellor of Exeter cathedral; he also held a prebend in the collegiate church at Bosham. Already in 1245 he enjoyed a dispensation enabling him to hold three ecclesiastical benefices. He died in 1268 and was buried in the nave of Exeter cathedral, and a chantry for his soul was endowed out of the revenues of the manor of Thorverton.

His fame is due to a treatise on the laws and customs of England which is sufficiently described elsewhere (see ENGLISH LAW). The main part of it seems to have been compiled between 1250 and 1256; but apparently it is an unfinished work. This may be due to the fact that when he ceased to be a member of the king's central court Bracton was ordered to surrender certain judicial records which he had been using as raw material. Even though it be unfinished his book is incomparably the best work produced by any English lawyer in the middle ages.

The treatise was published in 1569 by Richard Tottel. This text was reprinted in 1640. An edition (1878-1883) with English

translation was included in the Rolls Series. Manuscript copies are numerous, and a critical edition is a desideratum. See Bracton's *Note-Book* (ed. Maitland, 1887); *Bracton and Azo* (Selden Society, 1895). (F. W. M.)

BRADAWL (from "brad," a flat nail, and "awl," a piercing tool), a small tool used for boring holes (see TOOL).

BRADDOCK, EDWARD (1695?-1755), British general, was born in Perthshire, Scotland, about 1695. He was the son of Major-General Edward Braddock (d. 1725), and joined the Coldstream Guards in 1710. In 1747 as a lieutenant-colonel he served under the prince of Orange in Holland during the siege of Bergen-op-Zoom. In 1753 he was given the colonelcy of the 14th foot, and in 1754 he became a major-general. Being appointed shortly afterwards to command against the French in America, he landed in Virginia in February 1755. After some months of preparation, in which he was hampered by administrative confusion and want of resources, he took the field with a picked column, in which George Washington served as a volunteer officer, intended to attack Fort Duquesne (Pittsburg, Pa.). The column crossed the Monongahela river on the 9th of July and almost immediately afterwards fell into an ambushade of French and Indians. The troops were completely surprised and routed, and Braddock, rallying his men time after time, fell at last mortally wounded. He was carried off the field with difficulty, and died on the 13th. He was buried at Great Meadows, where the remnant of the column halted on its retreat to reorganize. (See SEVEN YEARS' WAR.)

BRADDOCK, a borough of Allegheny county, Pennsylvania, U.S.A., on the Monongahela river, 10 m. S.E. of Pittsburg. Pop. (1890) 8561; (1900) 15,654, of whom 5111 were foreign-born; (1910 census) 19,357. Braddock is served by the Pennsylvania, the Baltimore & Ohio, and the Pittsburg & Lake Erie railways. Its chief industry is the manufacture of steel—especially steel rails; among its other manufactures are pig-iron, wire rods, wire nails, wire bale ties, lead pipe, brass and electric signs, cement and plaster. In 1905 the value of the borough's factory products was \$4,199,079. Braddock has a Carnegie library. Kennwood Park, near by, is a popular resort. The municipality owns and operates the water-works. Braddock was named in honour of the English general Edward Braddock, who in 1755 met defeat and death near the site of the present borough at the hands of a force of French and Indians. The borough was first settled at the close of the 18th century, and was incorporated in 1867.

BRADDON, MARY ELIZABETH (1837-), English novelist, daughter of Henry Braddon, solicitor, of Skirton Lodge, Cornwall, and sister of Sir Edward Braddon, prime minister of Tasmania, was born in London in 1837. She began at an early age to contribute to periodicals, and in 1861 produced her first novel, *The Trail of the Serpent*. In the same year appeared *Garibaldi*, accompanied by *Olivia*, and other poems, chiefly narrative, a volume of extremely spirited verse, deserving more notice than it has received. In 1862 her reputation as a novelist was made by a favourable review in *The Times* of *Lady Audley's Secret*. *Aurora Floyd*, a novel with a strong affinity to *Madame Bovary*, followed, and achieved equal success. Its immediate successors, *Eleanor's Victory*, *John Marchmont's Legacy*, *Henry Dunbar*, remain with her former works the best-known of her novels, but all her numerous books have found a large and appreciative public. They give, indeed, the great body of readers of fiction exactly what they require; melodramatic in plot and character, conventional in their views of life, they are yet distinguished by constructive skill and opulence of invention. For a considerable time Miss Braddon conducted *Belgravia*, in which several of her novels appeared. In 1874 she married Mr John Maxwell, publisher, her son, W. B. Maxwell, afterwards becoming known as a clever novelist and newspaper correspondent.

BRADFORD, JOHN (1510?-1555), English Protestant martyr, was born at Manchester in the early part of the reign of Henry VIII., and educated at the local grammar school. Being a good penman and accountant, he became secretary to Sir John

Harrington, paymaster of the English forces in France. Bradford at this time was gay and thoughtless, and to support his extravagance he seems to have appropriated some of the money entrusted to him; but he afterwards made full restitution. In April 1547 he took chambers in the Inner Temple, and began to study law; but finding divinity more congenial, he removed, in the following year, to St Catharine's Hall, Cambridge, where he studied with such assiduity that in little more than a year he was admitted by special grace to the degree of master of arts, and was soon after made fellow of Pembroke Hall, the fellowship being "worth seven pound a year." One of his pupils was John Whitgift. Bishop Ridley, who in 1550 was translated to the see of London, sent for him and appointed him his chaplain. In 1553 he was also made chaplain to Edward VI., and became one of the most popular preachers in the kingdom, earning high praise from John Knox. Soon after the accession of Mary he was arrested on a charge of sedition, and confined in the Tower and the king's bench prison for a year and a half. During this time he wrote several epistles which were dispersed in various parts of the kingdom. He was at last brought to trial (January 1554/5) before the court in which Bishop Gardiner sat as chief, and, refusing to retract his principles, was condemned as a heretic and burnt, with John Leaf, in Smithfield on the 1st of July 1555.

His writings, which consist chiefly of sermons, meditations, tracts, letters and prayers, were edited by A. Townsend for the Parker Society (2 vols. 8vo, Cambridge, 1848-1853).

BRADFORD, WILLIAM (1590-1657), American colonial governor and historian, was born in Austerfield, Yorkshire, England, probably in March 1590. He became somewhat estranged from his family, which was one of considerable importance in the locality, when in early youth he joined the Puritan sect known as Separatists, and united in membership with the congregation at Scrooby. He prepared in 1607, with other members of the church, to migrate to Holland, but the plan was discovered and several of the leaders, among them Bradford, were imprisoned. In the year following, however, he joined the English colony at Amsterdam, where he learned the trade of silk weaving. He subsequently sold his Yorkshire property and embarked in business on his own account at Leiden, where the English refugees had removed. He became an active advocate of the proposed emigration to America, was one of the party that sailed in the "Mayflower" in September 1620, and was one of the signers of the compact on shipboard in Cape Cod Bay. After the death of Governor John Carver in April 1621, Bradford was elected governor of Plymouth Colony, and served as such, with the exception of five years (1633, 1634, 1636, 1638 and 1644) until shortly before his death. After 1624, at Bradford's suggestion, a board of five and later seven assistants was chosen annually to share the executive responsibility. Bradford's rule was firm and judicious, and to his guidance more than to that of any other man the prosperity of the Plymouth Colony was due. His tact and kindness in dealing with the Indians helped to relieve the colony from the conflicts with which almost every other settlement was afflicted. In 1630 the council for New England granted to "William Bradford, his heirs, associates, and assigns," a new patent enlarging the original grant of territory made to the Plymouth settlers. This patent Bradford in the name of the trustees made over to the body corporate of the colony in 1641. Bradford died in Plymouth on the 9th of May 1657. He was the author of a very important historical work, the *History of Plimouth Plantation* (until 1646), first published in the *Proceedings of the Massachusetts Historical Society* for 1856, and later by the state of Massachusetts (Boston, 1898), and in facsimile, with an introduction by John A. Doyle, in 1896. The manuscript disappeared from Boston during the War of Independence, was discovered in the Fulham library, London, in 1855, and was returned by the bishop of London to the state of Massachusetts in 1897. This work has been of inestimable value to writers on the history of the Pilgrims, and was freely used, in manuscript, by Morton, Hubbard, Mather, Prince and Hutchinson. Bradford was also undoubtedly part author,

with Edward Winslow, of the "Diary of Occurrences" published in Mourt's *Relation*, edited by Dr H. M. Dexter (Boston, 1865). He also wrote a series of *Dialogues*, on church government, published in the Massachusetts Historical Society's Publications (1870.)

For Bradford's ancestry and early life see Joseph Hunter, *Collections concerning the Founders of New Plymouth*, in Massachusetts Historical Society's Collections (Boston, 1852); also the quaint sketch in Cotton Mather's *Magnalia* (London, 1702), and a chapter in Williston Walker's *Ten New England Leaders* (New York, 1901).

BRADFORD, WILLIAM (1663-1752), American colonial printer, was born in Leicestershire, England, on the 20th of May 1663. He learned the printer's trade in London with Andrew Sowle, and in 1682 emigrated with William Penn to Pennsylvania, where in 1685 he introduced the "art and mystery" of printing into the Middle Colonies. His first imprint was an almanac, *Kalendarium Pennsylvaniaense or America's Messenger* (1685). At the outset he was ordered "not to print anything but what shall have licence from ye council," and in 1692, the colony then being torn by schism, he issued a tract for the minority sect of Friends, whereupon his press was seized and he was arrested. He was released, however, and his press was restored on his appeal to Governor Benjamin Fletcher. In 1690, with William Rittenhouse (1644-1708) and others, he established in Roxboro, Pennsylvania, now a part of Philadelphia, the first paper mill in America. In the spring of 1693 he removed to New York, where he was appointed royal printer for the colony, a position which he held for more than fifty years; and on the 8th of November 1725 he issued the first number of the *New York Gazette*, the first paper established in New York and from 1725 to 1733 the only paper in the colony. Bradford died in New York on the 23rd of May 1752.

His son, **ANDREW SOWLE BRADFORD** (1686-1742), removed from New York to Philadelphia in 1712, and there on the 22nd of December 1719 issued the first number of the *American Weekly Mercury*, the first newspaper in the Middle Colonies. Benjamin Franklin, for a time a compositor in the office, characterized the paper as "a paltry thing, in no way interesting"; but it was continued for many years and was edited by Bradford until his death.

The latter's nephew, **WILLIAM BRADFORD** (1722-1791), established in December 1742 the *Pennsylvania Journal and Weekly Advertiser*, which was for sixty years under his control or that of his son, and which in 1774-1775 bore the oft-reproduced device of a divided serpent with the motto "Unite or Die." He served in the War of American Independence, rising to the rank of colonel. His son, **WILLIAM BRADFORD** (1755-1795), also served in the War of Independence, and afterwards was attorney-general of Pennsylvania (1791), a judge of the supreme court of the state, and in 1794-1795 attorney-general of the United States.

BRADFORD, WILLIAM (1827-1892), American marine painter, was born at New Bedford, Massachusetts. He was a Quaker, and was self-taught, painting the ships and the marine views he saw along the coast of Massachusetts, Labrador and Nova Scotia; he went on several Arctic expeditions with Dr Hayes, and was the first American painter to portray the frozen regions of the north. His pictures attracted much attention by reason of their novelty and gorgeous colour effects. His "Steamer 'Panther' in Melville Bay, under the Light of the Midnight Sun" was exhibited at the Royal Academy in London in 1875. Bradford was a member of the National Academy of Design, New York, and died in that city on the 25th of April 1892. His style was somewhat influenced by Albert van Beest, who worked with Bradford at Fairhaven for a time; but Bradford is minute and observant of detail where van Beest's aim is general effect.

BRADFORD, a city, and municipal, county and parliamentary borough, in the West Riding of Yorkshire, England, 192 m. N.N.W. of London and 8 m. W. of Leeds. Pop. (1891) 265,728; (1901) 279,767. It is served by the Midland and the North Eastern railways (Midland station), and by the Great Northern and the Lancashire & Yorkshire railways (Exchange station). It lies in a small valley opening southward from that of the

Aire, and extends up the hills on either side. Most of the principal streets radiate from a centre between the Midland and Exchange stations and the town hall. This last is a handsome building, opened in 1873, surmounted by a bell tower. The exterior is ornamented with statues of English monarchs. The council-chamber contains excellent wood-carving. The extension of the building was undertaken in 1905. The parish church of St Peter is Perpendicular, dating from 1485, and occupies the site of a Norman church. Its most noteworthy feature is the fine original roof of oak. There was no other church in the town until 1815, but modern churches and chapels are numerous. Among educational institutions, the grammar school existed in the 16th century, and in 1663 received a charter of incorporation from Charles II. It occupies a building erected in 1873, and is largely endowed, possessing several scholarships founded by prominent citizens. The technical college, under the corporation since 1899, was opened in 1882. A mechanics' institute was founded in 1832, and in 1871 the handsome mechanics' hall, close to the town hall, was opened. Other establishments are the Airedale College of students for the Independent ministry, and the United Independent College (1888). The general infirmary is the principal of numerous charitable institutions. The most noteworthy public buildings beside the town hall are St George's hall (1853), used for concerts and public meetings, the exchange (1867), extensive market buildings, and two court-houses. The Cartwright memorial hall, principally the gift of Lord Masham, opened in 1904 and containing an art gallery and museum, commemorates Dr Edmund Cartwright (1743-1823) as the inventor of the power-loom and the combing-machine. The hall stands in Lister Park, and was opened immediately before, and used in connexion with, the industrial exhibition held here in 1904. The Temperance hall is of interest inasmuch as the first hall of this character in England was erected at Bradford in 1837. Some of the great warehouses are of considerable architectural merit. Statues commemorate several of those who have been foremost in the development of the city, such as Sir Titus Salt, Mr S. C. Lister (Lord Masham), and W. E. Forster. Of several parks the largest are Lister, Peel, and Bowling parks, each exceeding fifty acres. In the last is an ancient and picturesque mansion, which formerly belonged to the Bowling or Bolling family. A large acreage of high-lying moorland near the city is maintained by the corporation as a public recreation ground.

As a commercial centre Bradford is advantageously placed with regard to both railway communication and connexion with the Humber and with Liverpool by canal, and through the presence in its immediate vicinity of valuable deposits of coal and iron. The principal textile manufactures in order of importance are worsted, employing some 36,000 hands, females considerably outnumbering males; woollens, employing some 8000, silk and cotton. The corporation maintains a conditioning-hall for testing textile materials. A new hall was opened in 1902. Engineering and iron works (as at Bowling and Low Moor) are extensive; and the freestone of the neighbourhood is largely quarried, and in Bradford itself its use is general for building. It blackens easily under the influence of smoke, and the town has consequently a somewhat gloomy appearance. The trade of Bradford, according to an official estimate, advanced between 1836 and 1884 from a total of five to at least thirty-five millions sterling, and from not more than six to at least fifty staple articles. The annual turn-over in the staple trade is estimated at about one hundred millions sterling.

Bradford was created a city in 1897. The parliamentary borough returned two members from 1832 until 1885, when it was divided into three divisions, each returning one member. The county borough was created in 1888. Its boundaries include the suburbs, formerly separate urban districts, of Eccleshill, Idle and others. The corporation consists of a lord mayor (this dignity was conferred in 1907), 21 aldermen, and 63 councillors. One feature of municipal activity in Bradford deserves special notice—there is a municipal railway, opened in 1907, extending from Pateley Bridge to Lofthouse (6 m.)

and serving the Nidd valley, the district from which the main water-supply of the city is obtained. Area of the city, 22,879 acres.

Bradford, which is mentioned as having belonged before 1066, with several other manors in Yorkshire, to one Gamel, appears to have been almost destroyed during the conquest of the north of England and was still waste in 1086. By that time it had been granted to Ilbert de Lacy, in whose family it continued until 1311. The inquisition taken after the death of Henry de Lacy, earl of Lincoln, in that year gives several interesting facts about the manor; the earl had there a hall or manor-house, a fulling mill, a market every Sunday, and a fair on the feast of St Andrew. There were also certain burgesses holding twenty-eight burgages. Alice, only daughter and heiress of Henry de Lacy, married Thomas Plantagenet, earl of Lancaster, and on the attainder of her husband she and Joan, widow of Henry, were obliged to release their rights in the manor to the king. The earl of Lancaster's attainder being reversed in 1327, Bradford, with his other property, was restored to his brother and heir, Henry Plantagenet, but again passed to the crown on the accession of Henry IV., through the marriage of John of Gaunt with Blanche, one of the daughters and heirs of Henry Plantagenet. Bradford was evidently a borough by prescription and was not incorporated until 1847. Previous to that date the chief officer in the town had been the chief constable, who was appointed annually at the court leet of the manor. Before the 19th century Bradford was never represented in parliament, but in 1832 it was created a parliamentary borough returning two members. A weekly market on Thursdays was granted to Edward de Lacy in 1251 and confirmed in 1294 to Henry de Lacy, earl of Lincoln, with the additional grant of a fair on the eve and day of St Peter ad Vincula and three days following. In 1481 Edward IV. granted to certain feeoffees in whom he had vested his manor of Bradford a market on Thursday every week and two yearly fairs, one on the feast of the Deposition of St William of York and two days preceding, the other on the feast of St Peter in Cathedra and two days preceding.

From the mention of a fulling mill in 1311 it is possible that woollen manufacture had begun at that time. By the reign of Henry VIII. it had become an important industry and added much to the status of the town. Towards the end of the 17th and beginning of the 18th century the woollen trade decreased and worsted manufacture began to take its place. Leland in his *Itinerary* says that Bradford is "a praty quik Market Tounne. It standith much by clothing." In 1773 a piece hall was erected and for many years served as a market-place for the manufacturers and merchants of the district. On the introduction of steam-power and machinery the worsted trade advanced with great rapidity. The first mill in Bradford was built in 1798; there were 20 mills in the town in 1820, 34 in 1833, and 70 in 1841; and at the present time there are over 300, of much greater magnitude than the earlier factories. In 1836 Mr (afterwards Sir) Titus Salt developed the alpaca manufacture in the town; mohair was shortly afterwards introduced; and the great works at Saltaire were opened (see *SNIPLEY*). Later, Mr S. C. Lister (Lord Masham) introduced the silk and velvet manufacture, having invented a process of manipulating silk waste, whereby what was previously treated as refuse is made into goods that will compete with those manufactured from the perfect cocoon.

See John James, *History of Bradford* (1844, new and enlarged ed., 1866); A. Holroyd, *Collectanea Bradfordiana* (1873); *Victoria County History—Yorkshire*.

BRADFORD, a city of McKean county, Pennsylvania, U.S.A., near the N. border of the state, about 80 m. E. by S. of Erie. Pop. (1890) 10,514; (1900) 15,029, of whom 2211 were foreign-born; (1910 census) 14,544. It is served by the Pennsylvania, the Erie, and the Buffalo, Rochester & Pittsburg railways, and is connected with Olean, New York, by an electric line. Bradford is situated 1427 ft. above sea-level in the valley of the Tuna, and is shut in by hills on either side. Since 1876 it has been one

of the most important oil centres of the state, and it has been connected by pipe lines with cities along the Atlantic coast; petroleum refining is an important industry. Among the city's manufactures are boilers, machines, glass, chemicals, terra cotta, brick, iron pipes and couplings, gas engines, cutlery and silk. The place was first settled about 1827; in 1838 it was laid out as a town and named Littleton; in 1858 the present name, in honour of William Bradford (1755-1795), was substituted; and Bradford was incorporated as a borough in 1873, and was chartered as a city in 1879. Kendall borough was annexed to Bradford in 1893.

BRADFORD CLAY, in geology, a thin, rather inconstant bed of clay or marl situated in England at the base of the Forest Marble, the two together constituting the Bradfordian group in the Bathonian series of Jurassic rocks. The term "Bradford Clay" appears to have been first used by J. de C. Sowerby in 1823 (*Mineral Conchology*, vol. v.) as an alternative for W. Smith's "Clay on Upper Oolite." The clay came into notice late in the 18th century on account of the local abundance of the crinoid *Apiocrinus Parkinsoni*. It takes its name from Bradford-on-Avon in Wiltshire, whence it is traceable southward to the Dorset coast and northward towards Cirencester. It may be regarded as a local phase of the basement beds of the Forest Marble, from which it cannot be separated upon either stratigraphical or palaeontological grounds. It is seldom more than 10 ft. thick, and it contains as a rule a few irregular layers of limestone and calcareous sandstone. The lowest layer is often highly fossiliferous; some of the common forms being *Arca minuta*, *Ostrea gregaria*, *Waldheimia digona*, *Terebratula coarctata*, *Cidaris bradfordensis*, &c.

See H. B. Woodward, "Jurassic Rocks of Britain," *Mem. Geol. Survey*, vol. iv. (1904).

BRADFORD-ON-AVON, a market town in the Westbury parliamentary division of Wiltshire, England, on the rivers Avon and Kennet, and the Kennet & Avon Canal, 98 m. W. by S. of London by the Great Western railway. Pop. of urban district (1901) 4514. Its houses, all built of grey stone, rise in picturesque disorder up the steep sides of the Avon valley, here crossed by an ancient bridge of nine arches, with a chapel in the centre. Among many places of worship may be mentioned the restored parish church of Holy Trinity, which dates from the 12th century and contains some interesting monuments and brasses; and the Perpendicular Hermitage or Tofy chapel, with a 15th or 16th century chantry-house. But most notable is the Saxon church of St Lawrence, the foundation of which is generally attributed, according to William of Malmesbury (1125), to St Aldhelm, early in the 8th century. It consists of a chancel, nave and porch, in such unchanged condition that E. A. Freeman considered it "the most perfect surviving church of its kind in England, if not in Europe." It has more lately, however, been held that the present building is not Aldhelm's, but a restoration, dating from about 975, and attributable to the influence of Dunstan, archbishop of Canterbury. Kingston House, long the seat of the dukes of Kingston, is a beautiful example of early 17th-century domestic architecture. The local industries include the manufacture of rubber goods, brewing, quarrying and iron-founding.

Bradford (Bradauford, Bradedford) was the site of a battle in 652 between Kenwal and his kinsman Cuthred. A monastery existed here in the 8th century, of which St Aldhelm was abbot at the time of his being made bishop of Sherborne in A.D. 705. In 1001 Æthelred gave this monastery and the town of Bradford to the nunnery of Shaftesbury, in order that the nuns might have a safe refuge against the insults of the Danes. No mention of the monastery occurs after the Conquest, but the nunnery of Shaftesbury retained the lordship of the manor until the dissolution in the reign of Henry VIII. In a synod held here in 954, Dunstan was elected bishop of Winchester. Bradford appears as a borough in the Domesday survey, and is there assessed at 42 hides. No charter of incorporation is recorded, however, and after returning two members to the parliament of 1295 the town does not appear to have enjoyed any of the privileges of a borough. The market is of ancient origin, and was formerly held on Monday; in the survey the tolls are assessed at 45 shillings. Bradford was at one time the centre of the clothing industry in the west of England, and was especially famous for its

broadoths and mixtures, the waters of the Avon being especially favourable to the production of good colours and superior dyes. The industry declined in the 18th century, and in 1740 we find the woolen merchants of Bradford petitioning for an act of parliament to improve their trade and so re-establish their credit in foreign markets.

BRADLAUGH, CHARLES (1833-1891), English free-thinker and politician, was born at Hoxton, London, on the 26th of September 1833. His father was a poor solicitor's clerk, who also had a small business as a law stationer, and his mother had been a nursemaid. At twelve years old he became office-boy to his father's employer, and at fourteen wharf-clerk and cashier to a coal merchant in the City Road. He had been baptized and brought up in the Church of England, but he now came into contact with a group of free-thinkers who were disciples of Richard Carlile. He was hastily labelled an "atheist," and was turned out of his situation. Thus driven into the arms of the secularists, he managed to earn a living by odd jobs, and became further immersed in the study of free-thought. At the end of 1850 he enlisted as a soldier, but in 1853 was bought out with money provided by his mother. He then found employment as a lawyer's clerk, and gradually became known as a free-thought lecturer, under the name of "Iconoclast." From 1860 he conducted the *National Reformer* for several years, and displayed much resource in legal defence when the paper was prosecuted by the government on account of its alleged blasphemy and sedition in 1868-1869. Bradlaugh became notorious as a leading "infidel," and was supported by the sympathy of those who were enthusiasts at that time for liberty of speech and thought. He was a constant figure in the law courts; and his competence to take the oath was continually being called in question, while his atheism and republican opinions were adduced as reasons why no jury should give damages for attacks on his character. In 1874 he became acquainted with Mrs Annie Besant (b. 1847), who afterwards became famous for her gifts as a lecturer on socialism and theosophy. She began by writing for the *National Reformer* and soon became co-editor. In 1876 the Bristol publisher of an American pamphlet on the population question, called *Fruits of Philosophy*, was indicted for selling a work full of indecent physiological details, and, pleading guilty, was lightly sentenced; but Bradlaugh and Mrs Besant took the matter up, in order to vindicate their ideas of liberty, and aggressively republished and circulated the pamphlet. The prosecution which resulted created considerable scandal. They were convicted and sentenced to a heavy fine and imprisonment, but the sentence was stayed and the indictment ultimately quashed on a technical point. The affair, however, had several side issues in the courts and led to much prejudice against the defendants, the distinction being ignored between a protest against the suppression of opinion and the championship of the particular opinions in question. Mrs Besant's close alliance with Bradlaugh eventually terminated in 1886, when she drifted from secularism, first into socialistic and labour agitation and then into theosophy as a pupil of Mme Blavatsky. Bradlaugh himself took up politics with increasing fervour. He had been unsuccessful in standing for Northampton in 1868, but in 1880 he was returned by that constituency to parliament as an advanced Radical. A long and sensational parliamentary struggle now began. He claimed to be allowed to affirm under the Parliamentary Oaths Act, and the rejection of this pretension, and the refusal to allow him to take the oath on his professing his willingness to do so, terminated in Bradlaugh's victory in 1886. But this result was not obtained without protracted scenes in the House, in which Lord Randolph Churchill took a leading part. When the long struggle was over, the public had gradually got used to Bradlaugh, and his transparent honesty and courageous contempt for mere popularity gained him increasing respect. Experience of public life in the House of Commons appeared to give him a more balanced view of things; and before he died, on the 30th of January 1891, the progress of events was such that it was beginning to be said of him that he was in a fair way to end as a Conservative. Hard, arrogant and dogmatic, with a powerful physique and a real gift for popular oratory, he was a natural

leader in causes which had society against them, but his sincerity was as unquestionable as his combativeness.

His *Life* was written, from a sympathetic point of view, with much interesting detail as to the history of secularism, by his daughter, Mrs Bradlaugh Bonner, and J. M. Robertson (1894).

BRADLEY, GEORGE GRANVILLE (1821-1903), English divine and scholar, was born on the 11th of December 1821, his father, Charles Bradley, being at that time vicar of Glasbury, Brecon. He was educated at Rugby under Thomas Arnold, and at University College, Oxford, of which he became a fellow in 1844. He was an assistant master at Rugby from 1846 to 1853, when he succeeded G. E. L. Cotton as headmaster at Marlborough. In 1870 he was elected master of his old college at Oxford, and in August 1881 he was made dean of Westminster in succession to A. P. Stanley, whose pupil and intimate friend he had been, and whose biographer he became. Besides his *Recollections of A. P. Stanley* (1883) and *Life of Dean Stanley* (1892), he published *Aids to writing Latin Prose Composition* and *Lectures on Job* (1884) and *Ecclesiastes* (1885). He took part in the coronation of Edward VII., resigned the deanery in 1902, and died on the 13th of March 1903.

Dean Bradley's family produced various other members distinguished in literature. His half-brother, ANDREW CECIL BRADLEY (b. 1851), fellow of Balliol, Oxford, became professor of modern literature and history (1881) at University College, Liverpool, and in 1889 regius professor of English language and literature at Glasgow University; and he was professor of poetry at Oxford (1901-1906). Of Dean Bradley's own children the most distinguished in literature were his son, ARTHUR GRANVILLE BRADLEY (b. 1850), author of various historical and topographical works; and especially his daughter, MRS MARGARET LOUISA WOODS (b. 1856), wife of the Rev. Henry George Woods, president of Trinity, Oxford (1887-1897), and master of the Temple (1904), London. Mrs Woods became well known for her accomplished verse (*Lyrics and Ballads*, 1889), largely influenced by Robert Bridges, and for her novels, of which her *Village Tragedy* (1887) was the earliest and strongest.

BRADLEY, JAMES (1693-1762), English astronomer, was born at Sherborne in Gloucestershire in March 1693. He entered Balliol College, Oxford, on the 15th of March 1711, and took degrees of B.A. and M.A. in 1714 and 1717 respectively. His early observations were made at the rectory of Wanstead in Essex, under the tutelage of his uncle, the Rev. James Pound (1669-1724), himself a skilled astronomer, and he was elected a fellow of the Royal Society on the 6th of November 1718. He took orders on his presentation to the vicarage of Bristow in the following year, and a small sinecure living in Wales was besides procured for him by his friend Samuel Molyneux (1689-1728). He, however, resigned his ecclesiastical preferments in 1721, on his appointment to the Savilian professorship of astronomy at Oxford, while as reader on experimental philosophy (1729-1760) he delivered 79 courses of lectures in the Ashmolean museum. His memorable discovery of the aberration of light (see ABBERRATION) was communicated to the Royal Society in January 1729 (*Phil. Trans.* xxxv. 637). The observations upon which it was founded were made at Molyneux's house on New Green. He refrained from announcing the supplementary detection of nutation (*q.v.*) until the 14th of February 1748 (*Phil. Trans.* xlv. 1), when he had tested its reality by minute observations during an entire revolution (18.6 years) of the moon's nodes. He had meantime (in 1742) been appointed to succeed Edmund Halley as astronomer royal; his enhanced reputation enabled him to apply successfully for an instrumental outfit at a cost of £1000; and with an 8-foot quadrant completed for him in 1750 by John Bird (1709-1776), he accumulated at Greenwich in ten years materials of inestimable value for the reform of astronomy. A crown pension of £250 a year was conferred upon him in 1752. He retired in broken health, nine years later, to Chalford in Gloucestershire, and there died on the 13th of July 1762. The printing of his observations was delayed by disputes about their ownership; but they were finally issued from the Clarendon Press, Oxford, in two folio

volumes (1798, 1805). The insight and industry of F. W. Bessel were, however, needed for the development of their fundamental importance.

Rigaud's Memoir prefixed to *Miscellaneous Works and Correspondence of James Bradley, D.D.* (Oxford, 1832), is practically exhaustive. Other sources of information are: *New and General Biographical Dictionary*, xii. 54 (1767); *Biog. Brit.* (Kippis); Foucher's "Eloge," *Paris Memoirs* (1762), p. 231 (Histoire); Delambre's *Hist. de l'Astronomie au 18^{me} siècle*, p. 413.

BRADSHAW, GEORGE (1801-1853), English printer and publisher, was born at Windsor Bridge, Pendleton, Lancashire, on the 29th of July 1801. On leaving school he was apprenticed to an engraver at Manchester, eventually setting up on his own account in that city as an engraver and printer—principally of maps. His name was already known as the publisher of *Bradshaw's Maps of Inland Navigation*, when in 1839, soon after the introduction of railways, he published, at sixpence, *Bradshaw's Railway Time Tables*, the title being changed in 1840 to *Bradshaw's Railway Companion*, and the price raised to one shilling. A new volume was issued at occasional intervals, a supplementary monthly time-sheet serving to keep the book up to date. In December 1841, acting on a suggestion made by his London agent, Mr W. J. Adams, Bradshaw reduced the price of his time-tables to the original sixpence, and began to issue them monthly under the title *Bradshaw's Monthly Railway Guide*. In June 1847 was issued the first number of *Bradshaw's Continental Railway Guide*, giving the time-tables of the Continental railways just as *Bradshaw's Monthly Railway Guide* gave the time-tables of the railways of the United Kingdom. Bradshaw, who was a well-known member of the Society of Friends, and gave considerable time to philanthropic work, died in 1853.

BRADSHAW, HENRY (c. 1450-1513), English poet, was born at Chester. In his boyhood he was received into the Benedictine monastery of St Werburgh, and after studying with other novices of his order at Gloucester (afterwards Worcester) College, Oxford, he returned to his monastery at Chester. He wrote a Latin treatise *De antiquitate et magnificentia Urbis Cestriae*, which is lost, and a life of the patron saint of his monastery in English seven-lined stanza. This work was completed in the year of its author's death, 1513, mentioned in "A balade to the auctour" printed at the close of the work. A second ballad describes him as "Harry Braddeshaa, of Chestre abbey monke." Bradshaw disclaims the merit of originality and quotes the authorities from which he translates—Bede, William of Malmesbury, Giraldus Cambrensis, Alfred of Beverley, Henry of Huntingdon, Ranulph Higden, and especially the "Passionary" or life of the saint preserved in the monastery. The poem, therefore, which is defined by its editor, Dr Carl Horstmann, as a "legendary epic," is rather a compilation than a translation. It contains a good deal of history beside the actual life of the saint. St Werburgh was the daughter of Wulfere, king of Mercia, and Bradshaw gives a description of the kingdom of Mercia, with a full account of its royal house. He relates the history of St Ermenilde and St Sexburge, mother and grandmother of Werburgh, who were successively abbesses of Ely. He does not neglect the miraculous elements of the story, but he is more attracted by historical fact than legend, and the second book narrates the Danish invasion of 875, and describes the history and antiquities of Chester, from its foundation by the legendary giant Leon Gaur, from which he derives the British name of Caerleon, down to the great fire which devastated the city in 1180, but was suddenly extinguished when the shrine of St Werburgh was carried in procession through the streets. *The Holy Lyfe and History of saynt Werburge very fruefull for all Christen people to rede* (printed by Richard Pynson, 1521) has been very variously estimated. Thomas Warton, who deals with Bradshaw at some length,¹ quotes as the most splendid passage of the poem the description of the feast preceding Werburgh's entry into the religious life. He considered Bradshaw's versification "infinitely inferior to Lydgate's worst manner." Dr Horstmann, on the other hand, finds in the poem "original genius, of a truly epic tone, with a

¹ *History of English Poetry* (ed. W. C. Hazlitt, 1871; ii. pp. 140-149).

native simplicity of feeling which sometimes reminds the reader of Homer." Most readers will probably adopt a view between these extremes. Bradshaw expresses the humblest opinion of his own abilities, and he certainly had no delicate ear for rhythm. His sincerity is abundantly evident, and his piety is admitted even by John Bale,¹ hostile as he was to monkish writers. W. Herbert² thought that a *Life of Saynt Radegunde*, also printed by Pynson, was certainly by Bradshaw. The only extant copy is in the Britwell library.

Pynson's edition of the *Holy Life* is very rare, only five copies being known. A reprint copying the original type was edited by Mr Edward Hawkins for the Chetham Society in 1848, and by Dr Carl Hortmann for the Early English Text Society in 1887.

BRADSHAW, HENRY (1831-1886), British scholar and librarian, was born in London on the 2nd of February 1831, and educated at Eton. He became a fellow of King's College, Cambridge, and after a short scholastic career in Ireland he accepted an appointment in the Cambridge university library as an extra assistant. When he found that his official duties absorbed all his leisure he resigned his post, but continued to give his time to the examination of the MSS. and early printed books in the library. There was then no complete catalogue of these sections, and Bradshaw soon showed a rare faculty for investigations respecting old books and curious MSS. In addition to his achievements in black-letter bibliography he threw great light on ancient Celtic language and literature by the discovery, in 1857, of the *Book of Deer*, a manuscript copy of the Gospel in the Vulgate version, in which were inscribed old Gaelic charters. This was published by the Spalding Club in 1860. Bradshaw also discovered some Celtic glosses on the MS. of a metrical paraphrase of the Gospels by Juvenius. He made another find in the Cambridge library of considerable philological and historical importance. Cromwell's envoy, Sir Samuel Morland (1625-1695), had brought back from Piedmont MSS. containing the earliest known Waldensian records, consisting of translations from the Bible, religious treatises and poems. One of the poems referred the work to the beginning of the 11th century, though the MSS. did not appear to be of earlier date than the 15th century. On this Morland had based his theory of the antiquity of the Waldensian doctrine, and, in the absence of the MSS., which were supposed to be irretrievably lost, the conclusion was accepted. Bradshaw discovered the MSS. in the university library, and found in the passage indicated traces of erasure. The original date proved to be 1400. Incidentally the correct date was of great value in the study of the history of the language. He had a share in exposing the frauds of Constantine Simonides, who had asserted that the *Codex Sinaiticus* brought by Tischendorf from the Greek monastery of Mount Sinai was a modern forgery of which he was himself the author. Bradshaw exposed the absurdity of these claims in a letter to the *Guardian* (January 26, 1863). In 1866 he made a valuable contribution to the history of Scottish literature by the discovery of 2200 lines on the siege of Troy incorporated in a MS. of Lydgate's *Troye Booke*, and of the *Legends of the Saints*, an important work of some 40,000 lines. These poems he attributed, erroneously, as has since been proved, to Barbour (q.v.). Unfortunately Bradshaw allowed his attention to be distracted by a multiplicity of subjects, so that he has not left any literary work commensurate with his powers. The strain upon him was increased when he was elected (1867) university librarian, and as dean of his college (1857-1865) and pralector (1865-1868) he was involved in further routine duties. Besides his brilliant isolated discoveries in bibliography, he did much by his untiring zeal to improve the standard of library administration. He died very suddenly on the 10th of February 1886. His fugitive papers on antiquarian subjects were collected and edited by Mr F. Jenkinson in 1880.

An excellent *Memoir of Henry Bradshaw*, by Mr G. W. Prothero, appeared in 1888. See also C. F. Newcombe, *Some Aspects of the Work of Henry Bradshaw* (1905).

¹ *Scriptorium Illustratum*, cant. ix. No. 17.

² Ames, *Typographical Antiquities* (ed. W. Herbert, 1785; i. p. 294).

BRADSHAW, JOHN (1602-1659), president of the "High Court of Justice" which tried Charles I., was the second son of Henry Bradshaw, of Marple and Wibberley in Cheshire. He was baptized on the 10th of December 1602, was educated at Banbury in Cheshire and at Middleton in Lancashire, studied subsequently with an attorney at Congleton, was admitted into Gray's Inn in 1620, and was called to the bar in 1627, becoming a bencher in 1647. He was mayor of Congleton in 1637, and later high steward or recorder of the borough. According to Milton he was assiduous in his legal studies and acquired considerable reputation and practice at the bar. On the 21st of September 1643 he was appointed judge of the sheriff's court in London. In October 1644 he was counsel with Pryne in the prosecution of Lord Maguire and Hugh Macmahon, implicated in the Irish rebellion, in 1645 for John Lilburne in his appeal to the Lords against the sentence of the Star Chamber, and in 1647 in the prosecution of Judge Jenkins. On the 8th of October 1646 he had been nominated by the Commons a commissioner of the great seal, but his appointment was not confirmed by the Lords. In 1647 he was made chief justice of Chester and a judge in Wales, and on the 12th of October 1648 he was presented to the degree of serjeant-at-law. On the 2nd of January 1649 the Lords threw out the ordinance for bringing the king to trial, and the small remnant of the House of Commons which survived Pride's Purge, consisting of 53 independents, determined to carry out the ordinance on their own authority. The leading members of the bar, on the parliamentary as well as on the royalist side, having refused to participate in proceedings not only illegal and unconstitutional, but opposed to the plainest principles of equity, Bradshaw was selected to preside, and, after some protestations of humility and unfitness, accepted the office. The king refused to plead before the tribunal, but Bradshaw silenced every legal objection and denied to Charles an opportunity to speak in his defence. He continued after the king's death to conduct, as lord president, the trials of the royalists, including the duke of Hamilton, Lord Capel, and Henry Rich, earl of Holland, all of whom he condemned to death, his behaviour being especially censured in the case of Eusebius Andrews, a royalist who had joined a conspiracy against the government. He received large rewards for his services. He was appointed in 1649 attorney-general of Cheshire and North Wales, and chancellor of the duchy of Lancaster, and was given a sum of £1000, together with confiscated estates worth £3000 a year. He had been nominated a member of the council of state on the 14th of February 1649, and on the 10th of March became president. He disapproved strongly of the expulsion of the Long Parliament, and on Cromwell's coming subsequently to dismiss the council Bradshaw is said, on the authority of Ludlow, to have confronted him boldly, and denied his power to dissolve the parliament. An ardent republican, he showed himself ever afterwards an uncompromising adversary of Cromwell. He was returned for Stafford in the parliament of 1654, and spoke strongly against vesting power in a single person. He refused to sign the "engagement" drawn up by Cromwell, and in consequence withdrew from parliament and was subsequently suspected of complicity in plots against the government. He failed to obtain a seat in the parliament of 1656, and in August of the same year Cromwell attempted to remove him from the chief-justiceship of Cheshire. After the abdication of Richard Cromwell, Bradshaw again entered parliament, became a member of the council of state, and on the 3rd of June 1659 was appointed a commissioner of the great seal. His health, however, was bad, and his last public effort was a vehement speech, in the council, when he declared his abhorrence of the arrest of Speaker Lenthall. He died on the 31st of October 1659, and was buried in Westminster Abbey. His body was disinterred at the Restoration, and exposed on a gibbet along with those of Cromwell and Ireton. Bradshaw married Mary, daughter of Thomas Marbury of Marbury, Cheshire, but left no children.

BRADWARDINE, THOMAS (c. 1290-1340), English archbishop, called "the Profound Doctor," was born either at Hartfield in Sussex or at Chichester. He was educated at Merton

College, Oxford, where he took the degree of doctor of divinity, and acquired the reputation of a profound scholar, a skillful mathematician and an able divine. He was afterwards raised to the high offices of chancellor of the university and professor of divinity. From being chancellor of the diocese of London, he became chaplain and confessor to Edward III., whom he attended during his wars in France. On his return to England, he was successively appointed prebendary of Lincoln, archdeacon of Lincoln (1347), and in 1349 archbishop of Canterbury. He died of the plague at Lambeth on the 26th of August 1349, forty days after his consecration. Chaucer in his *Nun's Priest's Tale* ranks Bradwardine with St Augustine. His great work is a treatise against the Pelagians, entitled *De causa Dei contra Pelagium et de virtute causarum*, edited by Sir Henry Savile (London, 1618). He wrote also *De Geometria speculativa* (Paris, 1530); *De Arithmetica practica* (Paris, 1502); *De Proportionibus* (Paris, 1495; Venice, 1595); *De Quadratura Circuli* (Paris, 1495); and an *Ars Memorativa*, Sloane MSS. No. 3974 in the British Museum.

See Quétil-Echard, *Script. Praedict.* (1719), i. 744; W. F. Hook, *Lives of the Archbishops of Canterbury*, vol. iv.

BRADY, NICHOLAS (1659-1726), Anglican divine and poet, was born at Bandon, Co. Cork, on the 28th of October 1659. He received his education at Westminster school, and at Christ Church, Oxford; but he graduated at Trinity College, Dublin. He took orders, and in 1688 was made a prebendary of Cork. He was a zealous promoter of the Revolution and suffered in consequence. When the troubles broke out in Ireland in 1690, Brady, by his influence, thrice prevented the burning of the town of Bandon, after James II. had given orders for its destruction; and the same year he was employed by the people of Bandon to lay their grievances before the English parliament. He soon afterwards settled in London, where he obtained various preferments. At the time of his death, on the 20th of May 1726, he held the livings of Clapham and Richmond. Brady's best-known work is his metrical version of the Psalms, in which Nahum Tate collaborated with him. It was licensed in 1696, and largely ousted the old version of T. Sternhold and J. Hopkins. He also translated Virgil's *Aeneid*, and wrote several smaller poems and dramas, as well as sermons.

BRACKELER, HENRI JEAN AUGUSTIN DE (1840-1888), Belgian painter, was born at Antwerp. He was trained by his father, a genre painter, and his uncle, Baron Henri Leys, and devoted himself to scenes of everyday Antwerp life. The first pictures he exhibited, "The Laundry" (Van Cutsem collection, Brussels), and "The Coppermith's Workshop" (Vleeshovwer collection, Antwerp), were shown at the Antwerp exhibition in 1861. He received the gold medal at Brussels in 1872 for "The Geographer" and "The Lesson" (both in the Brussels gallery); the gold medal at Vienna in 1873 for "The Painter's Studio" and "Grandmother's Birthday"; and the medal of honour at the Exposition Universelle at Amsterdam for "The Pilot House." Among his more notable works are "A Shoemaker" (1862), "A Tailor's Workroom" (1863), "A Gardener" (1864, Antwerp gallery), "Interior of a Church" (1866), "Interior, Flanders" (1867), "Woman spinning" (1869), "Man reading" (1871), "The rue du Serment, Antwerp" (1873), "A Copperplate Printer," "The Sailor's Return," "The Man at the Window" (Couteaux collection, Brussels), "The Horn-blower" (Couteaux collection), "Man retouching a Picture" (Couteaux collection), "The Potters" (Marlier collection, Brussels), "Staircase in the Hydraulic House at Antwerp" (Marlier collection), and "The Brewer's House at Antwerp" (Marlier collection). The last, better known as "A Man sitting," is generally regarded as his masterpiece. As a lithographer and etcher, his work resembles that of Henri Leys. Towards the end of his life de Brackeler did some dot painting (*pointillisme*), in which he achieved admirable effects of light.

BRARMAR, a district in S.W. Aberdeenshire, Scotland, extending from Ballater in the E. to Glen Dee in the W., a distance of 24 m. with a breadth varying from 3 to 6 m. It is drained throughout by the river Dee, both banks of which are bounded by hills varying from 1000 to nearly 3000 ft. in height.

The whole area is distinguished by typical Highland scenery, and is a resort alike for sportsmen and tourists. The villages and clachans (Gaelic for hamlet) being situated at an altitude of from 600 to more than 1000 ft. above the sea, the air is everywhere pure and bracing. The deer forests comprise the royal forests of Balmoral and Ballochbuie, Glen Ey Forest, Mar Forest and Invercauld Forest. At various points on either side of the Dee, granite castles, mansions and lodges have been built, mostly in the Scottish baronial style, and all effectively situated with reference to the wooded hills or the river. The chief of these are Balmoral and Abergeldie Castles belonging to the crown, Invercauld House, Braemar Castle, Mar Lodge and Old Mar Lodge. Castleton of Braemar is the foremost of the villages, being sometimes styled the capital of the Deeside Highlands. Its public buildings include halls erected by the duke of Fife and Colonel Farquharson of Invercauld to commemorate the Victorian jubilee of 1887. Not far from the spot where the brawling Clunie joins the Dee the earl of Mar raised the standard of revolt in 1715. His seat, Braemar Castle, reputed to be a hunting-lodge of Malcolm Canmore, was forfeit along with the estates. The new castle built by the purchasers in 1720 was acquired at a later date by Farquharson of Invercauld, who gave government the use of it during the pacification of the Highlands after the battle of Culloden in 1746. Population of Crathie and Braemar (1901) 1452.

BRAG, a very old game of cards, probably evolved from the ancient Spanish *primero*, played by five or six, or more players. It is the ancestor of poker. A full pack is used, the cards ranking as at whist, with certain exceptions. There are no trumps. Each player receives three cards and puts up three stakes. The last round is dealt face upwards; the holder of the highest card irrespective of suits wins the first stake from all the players. In the case of equality the elder hand wins, but the ace of diamonds is always a winning card. For the second stake the players *brag* or bet against each other, if they hold either a pair, or a pair-royal (three cards of the same rank). Pairs and pair-royals take precedence according to the value of the cards composing them, but any pair-royal beats any pair. The knave of clubs may be counted as any card, e.g. two twos and the knave of clubs rank as a pair-royal in twos; two aces and the knave as a pair-royal in aces. Sometimes the knave of diamonds is allowed the same privilege, but is inferior to the club knave; e.g. two threes and the club would beat the other two threes and the diamond. Players who accept another's brag must cover his bet and offer another. The third stake is won by the player whose cards make 31 or are nearest to 31 by their pips, aces and court counting ten; but the ace may by arrangement count as 1 or 11. Players may draw from the stock, losing if they over-draw. If one player wins all three stakes, he may receive the value of another stake, or of two or three stakes, all round, as arranged. The deal passes as at whist. Each player should have the same number of deals before the game is abandoned.

BRAGA, a city of northern Portugal, formerly included in the province of Entre Minho e Douro, situated on the right bank of the small river Deste near its source, and at the head of a railway from Oporto. Pop. (1900) 24,302. Braga, which ranks after Lisbon and Oporto as the third city of the kingdom, is the capital of an administrative district, and an archiepiscopal see. Its cathedral, founded in the 12th century, was rebuilt during the 16th century in the blend of Moorish and florid Gothic styles known as Manoellian. It contains several tombs of considerable historical interest, some fine woodwork carved in the 15th century, and a collection of ancient vestments, plate and other objects of art. Among the other churches Santa Cruz is noteworthy for its handsome façade, which dates from 1642. There are several convents, an archiepiscopal palace, a library, containing many rare books and manuscripts, an orphan asylum, and a large hospital; also the ruins of a theatre, a temple and an aqueduct of Roman workmanship, and a great variety of minor antiquities of different ages. The principal manufactures are firearms, jewelry, cutlery, cloth and felt hats. Large cattle fairs are held in June and September, for cattle-breeding and

dairy-farming are among the foremost local industries. On a hill about 3 m. E. by S. stands the celebrated sanctuary of Bom Jesus, or Bom Jesus do Monte, visited at Whitsuntide by many thousands of pilgrims, who do public penance as they ascend to the shrine; and about 1 m. beyond it is Mount Sameiro (2535 ft.), crowned by a colossal statue of the Virgin Mary, and commanding a magnificent view of the mountainous country which culminates in the Serra do Gerez, on the north-east.

Braga is the Roman *Bracara Augusta*, capital of the *Callaici Bracarii*, or *Bracarenses*, a tribe who occupied what is now Galicia and northern Portugal. Early in the 5th century it was taken by the Suevi; but about 485 it passed into the hands of the Visigothic conquerors of Spain, whose renunciation of the Arian and Priscillianist heresies, at two synods held here in the 6th century, marks the origin of its ecclesiastical greatness. The archbishops of Braga retain the title of primate of Portugal, and long claimed supremacy over the Spanish church also; but their authority was never accepted throughout Spain. From the Moors, who captured Braga early in the 8th century, the city was retaken in 1040 by Ferdinand I., king of Castile and Leon; and from 1093 to 1147 it was the residence of the Portuguese court.

The administrative district of Braga coincides with the central part of the province of Entre Minho e Douro (q.v.). Pop. (1900) 357,150. Area, 1040 sq. m.

BRAGANZA (*Bragança*), the capital of an administrative district formerly included in the province of Traz-os-Montes, Portugal; situated in the north-eastern extremity of the kingdom, on a branch of the river Sabor, 8 m. S. of the Spanish frontier. Pop. (1900) 5535. Braganza is an episcopal city. It consists of a walled upper town, containing the cathedral college and hospital, and of a lower or modern town. Large tracts of the surrounding country are uncultivated, partly because railway communication is lacking and the roads are bad. Except farming, the chief local industry is silk-worm-rearing and the manufacture of silk. The administrative district of Braganza coincides with the eastern part of Traz-os-Montes (q.v.). Pop. (1900) 185,162; area, 2513 sq. m.

The city gave its name to the family of Braganza, members of which were rulers of Portugal from 1640 to 1853, and emperors of Brazil from 1822 to 1889. This family is descended from Alphonso (d. 1461), a natural son of John I., king of Portugal (d. 1433), who was a natural son of King Peter I., and consequently belonged to the Portuguese branch of the Capetian family. Alphonso was made duke of Braganza in 1442, and in 1483 his grandson, Duke Ferdinand II., lost his life through heading an insurrection against King John II. In spite of this Ferdinand's descendants acquired great wealth, and several of them held high office under the kings of Portugal. Duke John I. (d. 1583) married into the royal family, and when King Henry II. died without direct heirs in 1580, he claimed the crown of Portugal in opposition to Philip II. of Spain. John, however, was unsuccessful, but, when the Portuguese threw off the Spanish dominion in 1640, his grandson, John II., duke of Braganza, became king as John IV. In 1807, when Napoleon declared the throne of Portugal vacant, King John VI. fled to Brazil; but he regained his inheritance after the fall of Napoleon in 1814, although he did not return to Europe until 1821, when he left his elder son Peter to govern Brazil. In 1822 a revolution established the independence of Brazil with Peter as emperor. In 1826 Peter became king of Portugal on the death of his father; but he at once resigned the crown to his young daughter Maria, and appointed his brother Miguel to act as regent. Miguel soon declared himself king, but after a stubborn struggle was driven from the country in 1833, after which Maria became queen. Maria married for her second husband Ferdinand (d. 1851), son of Francis, duke of Saxe-Coburg; and when she died in 1853 the main Portuguese branch of the family became extinct. Maria was succeeded by her son Louis I., father of Charles I., who ascended the throne of Portugal in 1889. The empire of Brazil descended on the death of Peter I. to his son Peter II., who was expelled from the country in 1890. When Peter died in 1891 this branch of the family also became extinct

in the male line. His only child, Isabella, married Louis Gaston of Orleans, count of Eu. The exiled king, Miguel, founded a branch of the family of Braganza which settled in Bavaria, and various noble families in Portugal are descended from cadets of this house. The title of duke of Braganza is now borne by the eldest son of the king of Portugal.

BRAGG, BRAXTON (1817-1876), American soldier, was born in Warren county, North Carolina, on the 22nd of March 1817. He graduated at the United States military academy in 1837, and as an artillery officer served in the Seminole wars of 1837 and 1841, and under General Taylor in Mexico. For gallant conduct at Fort Brown, Monterey and Buena Vista, he received the brevets of captain, major and lieutenant-colonel. He resigned from the regular army on the 3rd of January 1856, and retired to his plantation in Louisiana. From 1859 to 1861 he was commissioner of the board of public works of the state. When in 1861 the Civil War began, Bragg was made a brigadier-general in the Confederate service, and assigned to command at Pensacola. In February 1862, having meanwhile become major-general, he took up a command in the Army of the Mississippi, and he was present at the battle of Shiloh (April). The vacancy created by the death of Sidney Johnston at that battle was filled by the promotion of Bragg to full general's rank, and he succeeded General Beauregard when that officer retired from the Western command. In the autumn of 1862 he led a bold advance from Eastern Tennessee across Kentucky to Louisville, but after temporary successes he was forced to retire before Buell, and after the battle of Perryville (8th October) retired into Tennessee. Though the material results of his campaign were considerable, he was bitterly censured, and his removal from his command was urged. But the personal favour of Jefferson Davis kept him, as it had placed him, at the head of the central army, and on the 31st of December 1862 and 2nd of January 1863 he fought the indecisive battle of Murfreesboro (or Stone river) against Rosecrans, Buell's successor. In the campaign of 1863 Rosecrans constantly outmanoeuvred the Confederates, and forced them back to the border of Georgia. Bragg, however, inflicted a crushing defeat on his opponent at Chickamauga (September 19-20) and for a time besieged the Union forces in Chattanooga. But enormous forces under Grant were concentrated upon the threatened spot, and the great battle of Chattanooga (November 23-25) ended in the rout of the Confederates. Bragg was now deprived of his command, but President Davis made him his military adviser, and in that capacity he served during 1864. In the autumn of that year he led an inferior force from North Carolina to Georgia to oppose Sherman's march. In February 1865 he joined Johnston, and he was thus included in the surrender of that officer to Sherman. After the war he became chief engineer to the state of Alabama, and supervised improvements in Mobile harbour. He died suddenly at Galveston, Texas, on the 27th of September 1876. General Bragg, in spite of his want of success, was unquestionably a brave and skilful officer. But he was a severe martinet, and rarely in full accord with the senior officers under his orders, the consequent friction often acting unfavourably on the conduct of the operations.

His brother, **THOMAS BRAGG** (1810-1872), was governor of North Carolina 1855-1859, U.S. senator 1859-1861, and attorney-general in the Confederate cabinet from Nov. 1861 to March 1862.

BRAGI, in Scandinavian mythology, the son of Odin, and god of wisdom, poetry and eloquence. At the Scandinavian sacrificial feasts a horn consecrated to Bragi was used as a drinking-cup by the guests, who then vowed to do some great deed which would be worthy of being immortalized in verse.

BRAHAM, JOHN (c. 1774-1856), English vocalist, was born in London about 1774, of Jewish parentage, his real name being Abraham. His father and mother died when he was quite young. Having received lessons in singing from an Italian artist named Leoni, he made his first appearance in public at Covent Garden theatre on the 21st of April 1787, when he sang "The soldier tired of war's alarms" and "*Ma chère arrive*." On the breaking of his voice, he had to support himself by teaching the

pianoforte. In a few years, however, he recovered his voice, which proved to be a tenor of exceptionally pure and rich quality. His second début was made in 1794 at the Bath concerts, to the conductor of which, Rauzzini, he was indebted for careful training extending over a period of more than two years. In 1796 he reappeared in London at Drury Lane in Storace's opera of *Mahmond*. Such was his success that he obtained an engagement the next year to appear in the Italian opera house in Grétry's *Asor et Zémire*. He also sang in oratorios and was engaged for the Three Choir festival at Gloucester. With the view of perfecting himself in his art he set out for Italy in the autumn of 1797. On the way he gave some concerts at Paris, which proved so successful that he was induced to remain there for eight months. His career in Italy was one of continuous triumph; he appeared in all the principal opera-houses, singing in Milan, Genoa, Leghorn and Venice. His compass embraced about nineteen notes, his management of the falsetto being perfect. In 1801 he returned to his native country, and appeared once more at Covent Garden in the opera *Chains of the Heart*, by Mazzinghi and Reeve. So great was his popularity that an engagement he had made when abroad to return after a year to Vienna was renounced, and he remained henceforward in England. In 1824 he sang the part of Max in the English version of Weber's *Der Freischütz*, and he was the original Sir Huon in that composer's *Oberon* in 1826. Braham made two unfortunate speculations on a large-scale, one being the purchase of the Colosseum in the Regent's Park in 1831 for £40,000, and the other the erection of the St James's theatre at a cost of £26,000 in 1836. In 1838 he sang the part of William Tell at Drury Lane, and in 1839 the part of Don Giovanni. His last public appearance was at a concert in March 1852. He died on the 17th of February 1856. There is, perhaps, no other case upon record in which a singer of the first rank enjoyed the use of his voice so long; between Braham's first and last public appearances considerably more than sixty years intervened, during forty of which he held the undisputed supremacy alike in opera, oratorio and the concert-room. Braham was the composer of a number of vocal pieces, which being sung by himself had great temporary popularity, though they had little intrinsic merit, and are now deservedly forgotten. A partial exception must be made in favour of "The Death of Nelson," originally written in 1811 as a portion of the opera *The American*; this still keeps its place as a standard popular English song.

BRAHE, PER, COUNT (1602-1680), Swedish soldier and statesman, was born on the island of Rydholm, near Stockholm, on the 18th of February 1602. He was the grandson of Per Brahe (1520-1590), one of Gustavus I.'s senators, created count of Visingsborg by Eric XIV., known also as the continuator of Peder Svart's chronicle of Gustavus I., and author of *Oeconomia* (1583), a manual for young noblemen. Per Brahe the younger, after completing his education by several years' travel abroad, became in 1626 chamberlain to Gustavus Adolphus, whose lasting friendship he gained. He fought with distinction in Prussia during the last three years of the Polish War (1626-1629) and also, as colonel of a regiment of horse, in 1630 in Germany. After the death of Gustavus Adolphus in 1632 his military yielded to his political activity. He had been elected president (*Landsmarskalk*) of the diet of 1629, and in the following year was created a senator (*Riksråd*). In 1635 he conducted the negotiations for an armistice with Poland. In 1637-1640 and again in 1648-1654 he was governor-general in Finland, to which country he rendered inestimable services by his wise and provident rule. He reformed the whole administration, introduced a postal system, built ten new towns, improved and developed commerce and agriculture, and very greatly promoted education. In 1640 he opened the university of Åbo, of which he was the founder, and first chancellor. After the death of Charles X. in 1660, Brahe, as *rikskansler* or chancellor of Sweden, became one of the regents of Sweden for the second time (he had held a similar office during the minority of Christina, 1632-1644), and during the difficult year 1660 he had entire control of both foreign and domestic affairs. He died on the 2nd of September

1680, at his castle at Visingsborg, where during his lifetime he had held more than regal pomp.

His brother, NILS BRAHE (1604-1632), also served with distinction under Gustavus Adolphus. He took part in the siege and capture of Riga in 1621, served with distinction in Poland (1626-1627) and assisted in the defence of Stralsund in 1628. In 1630 he accompanied Gustavus into Germany, and in 1631 was appointed colonel of "the yellow regiment," the king's world-renowned life-guards, at the head of which he captured the castle of Würzburg on the 8th of October 1631. He took part in the long duel between Gustavus and Wallenstein round Nuremberg as general of infantry, and commanded the left wing at Lützen (November 6, 1632), where he was the only Swedish general officer present. At the very beginning of the fight he was mortally wounded. The king regarded Brahe as the best general in the Swedish army after Lennart Torstensen.

A direct descendant of Nils, MAGNUS BRAHE (1700-1844), fought in the campaign of 1813-14, under the crown prince Bernadotte, with whom, after his accession to the throne as Charles XIV., he was in high favour. He became marshal of the kingdom, and, especially from 1828 onwards, exercised a preponderant influence in public affairs.

See Martin Veibull, *Sveriges Storhetstid*, vol. iv. (Stockholm, 1881); *Letters to Axel Ozensternus* (Swed.) 1832-1851 (Stockholm, 1890); Petrus Nordmann, *Per Brahe* (Helsingfors, 1904). (R. N. B.)

BRAHE, TYCHO (1546-1601), Danish astronomer, was born on the 14th of December 1546 at the family seat of Knudstrup in Scania, then a Danish province. Of noble family, he was early adopted by his uncle, Jörgen Brahe, who sent him, in April 1559, to study philosophy and rhetoric at Copenhagen. The punctual occurrence at the predicted time, August 21st, 1560, of a total solar eclipse led him to regard astronomy as "something divine"; he purchased the *Ephemerides* of Johann Stadius (3rd ed., 1570), and the works of Ptolemy in Latin, and gained some insight into the theory of the planets. Entered as a law-student at the university of Leipzig in 1562, he nevertheless secretly prosecuted celestial studies, and began continuous observations with a globe, a pair of compasses and a "cross-staff." He quitted Leipzig on the 17th of May 1565, but his uncle dying a month later, he repaired to Wittenberg, and thence to Rostock, where, in 1566, he lost his nose in a duel, and substituted an artificial one made of a copper alloy. In 1569 he matriculated at Augsburg, and devoted himself to chemistry for two years (1570-1572). On his return to Denmark, in 1571, he was permitted by his maternal uncle, Steno Belle, to instal a laboratory at his castle of Herritzvad, near Knudstrup; and there, on the 11th of November 1572, he caught sight of the famous "new star" in Cassiopeia. He diligently measured its position, and printed an account of his observations in a tract entitled *De Nova Stella* (Copenhagen, 1573), a facsimile of which was produced in 1901, as a tercentenary tribute to the author's memory.

Tycho's marriage with a peasant-girl in 1573 somewhat strained his family relations. He delivered lectures in Copenhagen by royal command in 1574; and in 1575 travelled through Germany to Venice. The execution of his design to settle at Basel was, however, anticipated by the munificence of Frederick II., king of Denmark, who bestowed upon him for life the island of Hveen in the Sound; together with a pension of 500 thalers, a canonry in the cathedral of Roskilde, and the income of an estate in Norway. The first stone of the magnificent observatory of Uraniborg was laid on the 8th of August 1576; it received the finest procurable instrumental outfit; and was the scene, during twenty-one years, of Tycho's labours in systematically collecting materials—the first made available since the Alexandrian epoch—for the correction of astronomical theories. James VI. of Scotland, afterwards James I. of England, visited him at Uraniborg on the 20th of March 1590. But by that time his fortunes were on the wane; for Frederick II. died in 1588, and his successor, Christian IV., was less tolerant of Tycho's arrogant and insubordinate behaviour. His pension and fief having been withdrawn, he sailed for Rostock in June 1597, and re-commenced observing before the close of the year, in the castle

of Wandsbeck near Hamburg. He spent the following winter at Wittenberg, and reached Prague in June 1599, well assured of favour and protection from the emperor Rudolph II. That monarch, accordingly, assigned him the castle of Benatky for his residence, with a pension of 3000 florins; his great instruments were moved thither from Hveen, and Johannes Kepler joined him there in January 1600. But this phase of renewed prosperity was brief. After eleven days' illness, Tycho Brahe died on the 24th of October 1601, at Benatky, and was buried in the Teynkirche, Prague.

Tycho's principal work, entitled *Astronomiæ Instauratæ Progymnasmatæ* (2 vols., Prague, 1602-1603) was edited by Kepler. The first volume treated of the motions of the sun and moon, and gave the places of 777 fixed stars (this number was increased to 1005 by Kepler in 1627 in the "Rudolphine Tables"). The second, which had been privately printed at Uraniborg in 1588 with the heading *De Mundi Aetherei recentioribus Phaenomenis*, was mainly concerned with the comet of 1577, demonstrated by Tycho from its insensible parallax to be no terrestrial exhalation, as commonly supposed, but a body traversing planetary space. It included, besides, an account of the Tychonic plan of the cosmos, in which a *via media* was sought between the Ptolemaic and Copernican systems. The earth retained its immobility; but the five planets were made to revolve round the sun, which, with its entire cortège, annually circuted the earth, the sphere of the fixed stars performing meanwhile, as of old, its all-inclusive diurnal rotation (see *ASTRONOMY: History*). Under the heading *Astronomiæ Instauratæ Mechanicæ*, Tycho published at Wandsbeck, in 1598, a description of his instruments, together with an autobiographical account of his career and discoveries, including the memorable one of the moon's "variation" (see *MOON*). The book was reprinted at Nuremberg in 1602 (cf. Hasselberg, *Vierteljahrsschrift Astr. Ges.* xxxix. iii. 180). His *Epistolæ Astronomicæ*, printed at Uraniborg in 1596 with a portrait engraved by Geyn of Amsterdam in 1586, were embodied in a complete edition of his works issued at Frankfort in 1648. Tycho vastly improved the art of astronomical observation. He constructed a table of refractions, allowed for instrumental inaccuracies, and eliminated by averaging accidental errors. He, moreover, corrected the received value of nearly every astronomical quantity; but the theoretical purpose towards which his practical reform was directed, was foiled by his premature death.

See J. L. E. Dreyer's *Tycho Brahe* (Edinburgh, 1890), which gives full and authentic information regarding his life and work. Also Cassendi's *Vita* (Paris, 1654); *Lebensbeschreibung*, collected from various Danish sources, and translated into German by Philander von der Weistritz (Copenhagen and Leipzig, 1756); *Tyge Brahe*, by F. R. Friis (Copenhagen, 1871); *Præter Tychoniana*, collected by Dr F. I. Studnicka (Prague, 1901), a description of the scanty Tychonian relics which survived the Thirty Years' War and are still preserved at Prague. (A. M. C.)

BRAHMAN, a Sanskrit noun-stem which, differently accented, yields in the two nominatives *Brahmā* (neut.) and *Brahmā* (masc.), the names of two deities which occupy prominent places in the orthodox system of Hindu belief. *Brahmā* (n.) is the designation generally applied to the Supreme Soul (*paramātmā*), or impersonal, all-embracing divine essence, the original source and ultimate goal of all that exists; *Brahmā* (m.), on the other hand, is only one of the three hypostases of that divinity whose creative activity he represents, as distinguished from its preservative and destructive aspects, ever apparent in life and nature, and represented by the gods Vishnu and Śiva respectively. The history of the two cognate names reflects in some measure the development of Indian religious speculation generally.

The neuter term *Brahmā* is used in the *Rigveda* both in the abstract sense of "devotion, worship," and in the concrete sense of "devotional rite, prayer, hymn." The spirit of Vedic worship is pervaded by a devout belief in the efficacy of invocation and sacrificial offering. The earnest and well-expressed prayer or hymn of praise cannot fail to draw the divine power to the worshipper and make it yield to his supplication; whilst offerings, so far from being mere acts of devotion calculated to give pleasure

to the god, constitute the very food and drink which render him vigorous and capable of battling with the enemies of his mortal friend. It is this intrinsic power of fervent invocation and worship which found an early expression in the term *brahmā*; and its independent existence as an active moral principle in shaping the destinies of man became recognized in the Vedic pantheon in the conception of a god *Brihaspati* or *Brahmanaspati*, "lord of prayer or devotion," the divine priest and the guardian of the pious worshipper. By a natural extension of the original meaning, the term *brahmā*, in the sense of sacred utterance, was subsequently likewise applied to the whole body of sacred writ, the *tri-vidyā* or "triple lore" of the Veda; whilst it also came to be commonly used as the abstract designation of the priestly function and the Brāhmanical order generally, in the same way as the term *kshatra*, "sway, rule," came to denote the aggregate of functions and individuals of the Kshatriyas or Rājanyas, the nobility or military class.

The universal belief in the efficacy of invocation as an indispensable adjunct to sacrifices and religious rites generally, could not fail to engender and maintain in the minds of the people feelings of profound esteem and reverence towards those who possessed the divine gift of inspired utterance, as well as for those who had acquired an intimate knowledge of the approved forms of ritual worship. A common designation of the priest is *brahman* (nom. *brahmo*), originally denoting, it would seem, "one who prays, a worshipper," perhaps also "the composer of a hymn" (*brahman*, n.); and the same term came subsequently to be used not only for one of the sacerdotal order generally, but also, and more commonly, as the designation of a special class of priests who officiated as superintendents during sacrificial performances, the complicated nature of which required the co-operation of a whole staff of priests, and who accordingly were expected to possess a competent knowledge of the entire course of ritual procedure, including the correct form and mystic import of the sacred texts to be repeated or chanted by the several priests. The Brahman priest (*brahmā*) being thus the recognized head of the sacerdotal order (*brahmā*), which itself is the visible embodiment of sacred writ and the devotional spirit pervading it (*brahmā*), the complete realization of theocratic aspirations required but a single step, which was indeed taken in the theosophic speculations of the later Vedic poets and the authors of the Brāhmanas (q.v.), viz. the recognition of this abstract notion of the Brahma as the highest cosmic principle and its identification with the pantheistic conception of an all-pervading, self-existent spiritual substance, the primary source of the universe; and subsequently coupled therewith the personification of its creative energy in the form of Brahmā, the divine representative of the earthly priest, who was made to take the place of the earlier conception of *Prajāpati*, "the lord of creatures" (see *BRAHMANISM*). By this means the very name of this god expressed the essential oneness of his nature with that of the divine spirit as whose manifestation he was to be considered. In the later Vedic writings, especially the Brāhmanas, however, *Prajāpati* still maintains throughout his position as the paramount personal deity; and *Brahmā*, in his divine capacity, is rather identified with *Brihaspati*, the priest of the gods. Moreover, the exact relationship between *Prajāpati* and the *Brahmā* (n.) is hardly as yet defined with sufficient precision; it is rather one of simple identification: in the beginning the Brahma was the All, and *Prajāpati* is the Brahma. It is only in the institutes of Manu, where we find the system of castes propounded in its complete development, that *Brahmā* has his definite place assigned to him in the cosmogony. According to this work, the universe, before undiscerned, was made discernible in the beginning by the sole, self-existent lord *Brahmā* (n.). He, desirous of producing different beings from his own self, created the waters by his own thought, and placed in them a seed which developed into a golden egg; therein was born *Brahmā* (m.), the parent of all the worlds; and thus "that which is the undiscrete Cause, eternal, which is and is not, from it issued that male who is called in the world *Brahmā*." Having dwelt in that egg for a year, that lord spontaneously by his own

thought split that egg in two; and from the two halves he fashioned the heaven and the earth, and in the middle, the sky, and the eight regions (the points of the compass), and the perpetual place of the waters. This theory of Brāhmā being born from a golden egg is, however, a mere adaptation of the Vedic conception of *Hiranyagarbha* ("golden embryo"), who is represented as the supreme god in a hymn of the tenth (and last) book of the *Rigveda*. Another still later myth, which occurs in the epic poems, makes Brāhmā be born from a lotus which grew out of the navel of the god Vishnu whilst floating on the primordial waters. In artistic representations, Brāhmā usually appears as a bearded man of red colour with four heads crowned with a pointed, tiara-like head-dress, and four hands holding his sceptre, or a sacrificial spoon, a bundle of leaves representing the Veda, a bottle of water of the Ganges, and a string of beads or his bow Parivṛta. His vehicle (*vāhana*) is a goose or swan (*hamsa*), whence he is also called *Hamsavāhana*; and his consort is Sarasvatī, the goddess of learning.

One could hardly expect that a colourless deity of this description, so completely the product of priestly speculation, could ever have found a place in the hearts of the people generally. And indeed, whilst in theoretic theology Brāhmā has retained his traditional place and function down to our own days, his practical cult has at all times remained extremely limited, the only temple dedicated to the worship of this god being found at Peshkar (Pokhar) near Ajmir in Rājputāna. On the other hand, his divine substratum, the impersonal Brahma, the world-spirit, the one and only reality, remains to this day the ultimate element of the religious belief of intelligent India of whatever sect. Being devoid of all attributes, it can be the object only of meditation, not of practical devotional rites; and philosophy can only attempt to characterize it in general and vague terms, as in the favourite formula which makes it to be *sacchidānanda*, i.e. being (*sa*), thinking (*chi*), and bliss (*anda*). (J. E.)

BRĀHMĀNA, the Sanskrit term applied to a body of prose writings appended to the collections (*samhitā*) of Vedic texts, the meaning and ritual application of which they are intended to elucidate, and like them regarded as divinely revealed. From a linguistic point of view, these treatises with their appendages, the more mystic and recondite *Āraṇyaka*s and the speculative *Upanishad*s, have to be considered as forming the connecting link between the Vedic and the classical Sanskrit. The exact derivation and meaning of the name is somewhat uncertain. Whilst the masculine term *brāhmana* (nom. *brāhmanas*), the ordinary Sanskrit designation of a man of the Brāhminical caste, is clearly a derivative of *brahman* (nom. *brahmā*), a common Vedic term for a priest (see BRAHMAN), thus meaning the son or descendant of a Brahman, the neuter word *brāhmana* (nom. *brāhmanam*) on the other hand, with which we are here concerned, admits of two derivations: either it is derived from the same word *brahmā*, and would then seem to mean a *dictum* or observation ascribed to, or intended for the use of, a Brahman, or superintending priest; or it has rather to be referred to the neuter noun *brahman* (nom. *brahmā*), in the sense of "sacred utterance or rite," in which case it might mean a comment on a sacred text, or explanation of a devotional rite, calculated to bring out its spiritual or mystic significance and its bearing on the Brahma, the world-spirit embodied in the sacred writ and ritual. This latter definition seems on the whole the more probable one, and it certainly would fit exactly the character of the writings to which the term relates. It will thus be seen that the term *brāhmanam* applies not only to complete treatises of an exegetic nature, but also to single comments on particular texts or rites of which such a work would be made up.

The gradual elaboration of the sacrificial ceremonial, as the all-sufficient expression of religious devotion, and a constantly growing tendency towards theosophic and mystic speculation on the significance of every detail of the ritual, could not fail to create a demand for explanatory treatises of this kind, which, to enhance their practical utility, would naturally deal with the special texts and rites assigned in the ceremonial to the several

classes of officiating priests. At a subsequent period the demand for instruction in the sacrificial science called into existence a still more practical set of manuals, the so-called *Kalpa-sūtras*, or ceremonial rules, detailing, in succinct aphorisms, the approved course of sacrificial procedure, without reference to the supposed origin or import of the several rites. These manuals are also called *Srauta-sūtras*, treating as they do, like the Brāhmanas, of the Śrauta rites—i.e. the rites based on the *śruti* or revelation—requiring at least three sacrificial fires and a number of priests, as distinguished from the *grīhya* (domestic) or *smṛta* (traditional) rites, supposed to be based on the *smṛiti* or tradition, which are performed on the house-fire and dealt with in the *Grīhya-sūtras*.

The ritual recognizes four principal priests (*ṛtvij*), each of whom is assisted by three subordinates: viz. the *Brahman* or superintending priest; the *Hotri* or reciter of hymns and verses; the *Udgātri* or chanter; and the *Adhvaryu* or offerer, who looks after the details of the ceremonial, including the preparation of the offering-ground, the construction of fire-places and altars, the making of oblations and muttering of the prescribed formulae. Whilst the two last priests have assigned to them special liturgical collections of the texts to be used by them, the *Sāmaveda-samhitā* and *Yajurveda-samhitā* respectively, the *Hotri* has to deal entirely with hymns and verses taken from the *Rigveda-samhitā*, of which they would, however, form only a comparatively small portion. As regards the Brahman, he would doubtless be chosen from one of those other three classes, but would be expected to have made himself thoroughly conversant with the texts and ritual details appertaining to all the officiating priests. It is, then, to one or other of those three collections of sacred texts and the respective class of priests, that the existing Brāhmanas attach themselves. At a later period, when the Atharvan gained admission to the Vedic canon, a special connexion with the Brahman priest was sometimes claimed, though with scant success, for this fourth collection of hymns and spells, and the comparatively late and unimportant *Gopatha-brāhmana* attached to it.

The *Udgātri*'s duties being mainly confined to the chanting of hymns made up of detached groups of verses of the *Rigveda*, as collected in the *Sāmaveda-samhitā*, the more important Brāhmanas of this sacerdotal class deal chiefly with the various modes of chanting, and the modifications which the verses have to undergo in their musical setting. Moreover, the performance of chants being almost entirely confined to the Soma-sacrifice, it is only a portion, though no doubt the most important portion, of the sacrificial ceremonial that enters into the subject matter of the *Sāmaveda Brāhmanas*.

As regards the Brāhmanas of the *Rigveda*, two of such works have been handed down, the *Aitareya* and the *Kaushiki* (or *Sankhśyona*)-*Brāhmanas*, which have a large amount of their material in common. But while the former work (transl. into English by M. Haug) is mainly taken up with the Soma-sacrifice, the latter has in addition thereto chapters on the other forms of sacrifice. Being intended for the *Hotri*'s use, both these works treat exclusively of the hymns and verses recited by that priest and his assistants, either in the form of connected litanies or in detached verses invoking the deities to whom oblations are made, or uttered in response to the solemn hymns chanted by the *Udgātri*s.

It is, however, to the Brāhmanas and *Sūtras* of the *Yajurveda*, dealing with the ritual of the real offering-priest, the *Adhvaryu*, that we have to turn for a connected view of the sacrificial procedure in all its material details. Now, in considering the body of writings connected with this Veda, we are at once confronted by the fact that there are two different schools, an older and a younger one, in which the traditional body of ritualistic matter has been treated in a very different way. For while the younger school, the *Vājasaneyins*, have made a clear severance between the sacred texts or mantras and the exegetic discussions thereon—as collected in the *Vājasaneyi-samhitā* and the *Satapatha-Brāhmana* (trans. by J. Eggeling, in *Sacred Books of the East*) respectively—arranged systematically in accordance with the ritual divisions, the older school on the

other hand present their materials in a hopelessly jumbled form; for not only is each type of sacrifice not dealt with continuously and in orderly fashion, but short textual sections of mantras are constantly followed immediately by their dogmatic exegesis; the term *brāhmaṇa* thus applying in their case only to these detached comments and not to the connected series of them. Thus the most prominent subdivision of the older school, the *Taittirīyas*, in their *Samhitā*, have treated the main portion of the ceremonial in this promiscuous fashion, and to add to the confusion they have, by way of supplement, put forth a so-called *Taittirīya-brāhmaṇa*, which, so far from being a real *Brāhmaṇa*, merely deals with some additional rites in the same confused mixture of sacrificial formulae and dogmatic explanations. It is not without reason, therefore, that those two schools, the older and the younger, are commonly called the Black (*kṛishka*) and the White (*śukla*) *Yajus* respectively.

Although the ritualistic discussions of the *Brāhmaṇas* are for the most part of a dry and uninteresting nature to an even greater degree than is often the case with exegetic theological treatises, these works are nevertheless of considerable importance both as regards the history of Indian institutions and as "the oldest body of Indo-European prose, of a generally free, vigorous, simple form, affording valuable glimpses backwards at the primitive condition of unfettered Indo-European talk" (Whitney). Of especial interest in this respect are the numerous myths and legends scattered through these works. From the archaic style in which these mythological tales are usually composed, as well as from the fact that not a few of them are found in *Brāhmaṇas* of different schools and *Vedas*, though often with considerable variations, it seems pretty evident that the groundwork of them must go back to times preceding the composition or final redaction of the existing *Brāhmaṇas*. In the case of some of these legends—as those of *Sunah-Śepha*, and the fetching of *Soma* from heaven—we can even see how they have grown out of germs contained in some of the Vedic hymns. If the literary style in which the exegetic discussion of the texts and rites is carried on in the *Brāhmaṇas* is, as a rule, of a very bald and uninviting nature, it must be borne in mind that these treatises are of a strictly professional and esoteric character, and in no way lay claim to being considered as literary compositions in any sense of the word. And yet, notwithstanding the general emptiness of their ritualistic discussions and mystic speculations, "there are passages in the *Brāhmaṇas* full of genuine thought and feeling, and most valuable as pictures of life, and as records of early struggles, which have left no trace in the literature of other nations" (M. Müller).

The chief interest, however, attaching to the *Brāhmaṇas* is doubtless their detailed description of the sacrificial system as practised in the later Vedic ages; and the information afforded by them in this respect should be all the more welcome to us, as the history of religious institutions knows of no other sacrificial ceremonial: with the details of which we are acquainted to anything like the same extent. An even more complete and minutely detailed view of the sacrificial system is no doubt obtained from the ceremonial manuals, the *Kalpa-sūtras*; but it is just by the speculative discussions of the *Brāhmaṇas*—the mystic significance and symbolical colouring with which they invest single rites—that we gain a real insight into the nature and gradual development of this truly stupendous system of ritual worship.

The sacrificial ritual recognizes two kinds of *śrauta* sacrifices, viz. *haviryajnas* (meat-offerings), consisting of oblations (*ishiti*) of milk, butter, cereals or flesh, and *somayajnas* or oblations of the juice of the soma plant. The setting up, by a householder, of a set of three sacrificial fires of his own constitutes the first ceremony of the former class, the *Agny-ādihāna* (or (?) *Agny-ādheya*). The first of the three fires laid down is the *gṛhkapatyā*, or householder's fire, so called because, though not taken from his ordinary house-fire, but as a rule specially produced by friction, it serves for cooking the sacrificial food, and thus, as it were, represents the domestic fire. From it the other two fires, the *śraoṣṭryā*, or offering fire, and the *dakṣhiṇyā*, or southern fire,

used for certain special purposes, are taken. The principal other ceremonies of this class are the new and full moon offerings, the oblations made at the commencement of the three seasons, the offering of first-fruits, the animal sacrifice, and the *Agnikūtra*, or daily morning and evening oblation of milk, which, however, is also included amongst the *gṛhyas*, or domestic rites, as having to be performed daily on the domestic fire by the householder who keeps no regular set of sacrificial fires.

Of a far more complicated nature than these offerings are the Soma-sacrifices, which, besides the simpler ceremonies of this class, such as the *Agnikūtra* or "Praise of Agni," also include great state functions, such as the *Rājasya* or consecration of a king, and the *Asvamedha* or horse-sacrifice, which, in addition to the sacrificial rites, have a considerable amount of extraneous, often highly interesting, ceremonial connected with them, which makes them seem to partake largely of the nature of public festivals. Whilst the oblations of Soma-juice, made thrice on each offering-day, amidst chants and recitations, constitute the central rites of those services, their ritual also requires numerous single oblations of the *ishiti* kind, including at least three animal offerings, and in some cases the immolation of many hecatombs of victims. Moreover, a necessary preliminary to every Soma-sacrifice is the construction, in five layers, of a special fire-altar of large dimensions, consisting of thousands of bricks, formed and baked on the spot, to each, or each group, of which a special symbolic meaning is attached. The building of this altar is spread over a whole year, during which period the sacrificer has to carry about the sacrificial fire in an earthen pan for at least some time each day, until it is finally deposited on the completed altar to serve as the offering-fire for the Soma oblations. The altar itself is constructed in the form of a bird, because Soma was supposed to have been brought down from heaven by the metre *Gāyatrī* which had assumed the form of an eagle. Whilst the Soma-sacrifice has been thus developed by the *Brāhmaṇas* in an extraordinary degree, its essential identity with the Avestan *Haoma*-cult shows that its origin goes back at all events to the Indo-Iranian period.

Among the symbolic conceits in which the authors of the *Brāhmaṇas* so freely indulge, there is one overshadowing all others—if indeed they do not all more or less enter into it—which may be considered as the sum and substance of these speculations, and the esoteric doctrine of the sacrifice, involved by the *Brāhmaṇical* ritualists. This is what may conveniently be called the *Prajāpati* theory, by which the "Lord of Creatures," the efficient cause of the universe, is identified with both the sacrifice (*yajña*) and the sacrificer (*yajamāna*). The origin of this theory goes back to the later Vedic hymns. In the so-called *Purusha-sūkta* (*Rīgs. x. 90*) in which the supreme spirit is conceived of as the person or man (*puruṣha*), born in the beginning, and consisting of "whatever hath been and whatever shall be," the creation of the visible and invisible universe is represented as originating from an "all-offered" (holocaust) sacrifice in which the *Purusha* himself forms the offering-material (*haviḥ*), or, as we might say, the victim. In this primeval, or rather timeless because ever-proceeding, sacrifice, time itself, in the shape of its unit the year, is made to take its part, inasmuch as the three seasons—spring, summer and autumn—of which it consists, constitute the ghee (clarified butter), the offering-fuel and the oblation respectively. These speculations may be said to have formed the foundation on which the theory of the sacrifice, as propounded in the *Brāhmaṇas*, has been reared. *Prajāpati*—who (probably for practical considerations, as better representing the sacrificer, the earthly ruler, or "lord of the creatures") here takes the place of the *Purusha*, the world-man or all-embracing personality—is offered up anew in every sacrifice; and inasmuch as the very dismemberment of the lord of creatures, which took place at that archetypal sacrifice, was in itself the creation of the universe, so every sacrifice is also a repetition of that first creative act. Thus the periodical sacrifice is nothing else than a microcosmic representation of the ever-proceeding destruction and renewal of all cosmic life and matter. The ritualistic theologians, however, go an important step

further by identifying Prajāpati with the performer, or patron, of the sacrifice, the sacrificer; every sacrifice thus becoming invested—in addition to its cosmic significance—with the mystic power of regenerating the sacrificer by cleansing him of all guilt and securing for him a seat in the eternal abodes.

Whilst forming the central feature of the ritualistic symbolism, this triad—Prajāpati, sacrifice (oblation, victim), sacrificer—is extended in various ways. An important collateral identification is that of Prajāpati (and the sacrificer) with Agni, the god of fire, embodied not only in the offering-fire, but also in the sacred Soma-altar, the technical name of which is *agni*. For this reason the altar, as representative of the universe, is built in five layers, representing earth, air and heaven, and the intermediate regions; and in the centre of the altar-site, below the first layer, on a circular gold plate (the sun), a small golden man (*purusha*) is laid down with his face looking upwards. This is Prajāpati, and the sacrificer, who when regenerated will pass upwards through the three worlds to the realms of light, naturally perforated bricks being for this purpose placed in the middle of the three principal altar-layers. One of the fourteen sections of the Śatapatha-brāhmaṇa, the tenth, called *Agni-rakṣya* or “the mystery of Agni (the god and altar),” is entirely devoted to this feature of the sacrificial symbolism. Similarly the sacrificer, as the human representative of the Lord of Creatures, is identified with Soma (as the supreme oblation), with Time, and finally with Death: by the sacrificer thus becoming Death himself, the fell god ceases to have power over him and he is assured of everlasting life. And now we get the Supreme Lord in his last aspect; nay, his one true and real aspect, in which the sacrificer, on shuffling off this mortal coil, will himself come to share—that of pure intellectuality, pure spirituality—he is Mind: such is the ultimate source of being, the one Self, the Purusha, the Brahman. As the sum total of the wisdom propounded in the mystery of Agni, the searcher after truth is exhorted to meditate on that Self, made up of intelligence, endowed with a body of spirit, a form of light, and of an ethereal nature; holding sway over all the regions and pervading this All, being itself speechless and devoid of mental states; and by so doing he shall gain the assurance that “even as a grain of rice, or the smallest granule of millet, so is the golden Purusha in my heart; even as a smokeless light, it is greater than the sky, greater than the ether, greater than the earth, greater than all existing things—that Self of the Spirit is my Self; on passing away from hence, I shall obtain that Self. And, verily, whosoever has this trust, for him there is no uncertainty.” (J. E.)

BRAHMANISM, a term commonly used to denote a system of religious institutions originated and elaborated by the *Brāhmins*, the sacerdotal and, from an early period, the dominant caste of the Hindū community (see **BRAHMAN**): In like manner, as the language of the Āryan Hindūs has undergone continual processes of modification and dialectic division, so their religious belief has passed through various stages of development broadly distinguished from one another by certain prominent features. The earliest phases of religious thought in India of which a clear idea can now be formed are exhibited in a body of writings, looked upon by later generations in the light of sacred writ, under the collective name of *Veda* (“knowledge”) or *Śruti* (“revelation”). The Hindū scriptures consist of four separate collections, or *Saṃhitās*, of sacred texts, or *mantras*, including hymns, incantations and sacrificial forms of prayer, viz. the *Rīch* (nom. sing. *ṛiḥ*) or *Rīgveda*, the *Sāman* or *Sāmaveda*, the *Yajus* or *Yajurveda*, and the *Atharvan* or *Atharvaveda*. Each of these four text-books has attached to it a body of prose writings, called *Brāhmayas* (see **BRAHMAṆYA**), intended to explain the ceremonial application of the texts and the origin and import of the sacrificial rites for which these were supposed to have been composed. Usually attached to these works, and in some cases to the *Saṃhitās*, are two kinds of appendages, the *Āraṇyakas* and *Upanishads*, the former of which deal generally with the more recondite rites, while the latter are taken up chiefly with speculations on the problems of the universe and the religious aims of man—

subjects often touched upon in the earlier writings, but here dealt with in a more mature and systematic way. Two of the *Saṃhitās*, the *Sāman* and the *Yajus*, owing their existence to purely ritual purposes, and being, besides, the one almost entirely, the other partly, composed of verses taken from the *Rīgveda*, are only of secondary importance for our present inquiry. The hymns of the *Rīgveda* constitute the earliest lyrical effusions of the Āryan settlers in India which have been handed down to posterity. They are certainly not all equally old; on the contrary they evidently represent the literary activity of many generations of bards, though their relative age cannot as yet be determined with anything like certainty. The tenth (and last) book of the collection, however, at any rate has all the characteristics of a later appendage, and in language and spirit many of its hymns approach very nearly to the level of the contents of the *Atharvan*. Of the latter collection about one-sixth is found also in the *Rīgveda*, and especially in the tenth book; the larger portion peculiar to it, though including no doubt some older pieces, appears to owe its origin to an age not long anterior to the composition of the *Brāhmayas*.

The state of religious thought among the ancient bards, as reflected in the hymns of the *Rīgveda*, is that of a worship of the grand and striking phenomena of nature regarded in the light of personal conscious beings, endowed with a power beyond the control of man, though not insensible to his praises and actions. It is a nature worship purer than that met with in any other polytheistic form of belief we are acquainted with—a mythology still comparatively little affected by those systematizing tendencies which, in a less simple and primitive state of thought, lead to the construction of a well-ordered pantheon and a regular organization of divine government. To the mind of the early Vedic worshipper the various departments of the surrounding nature are not as yet clearly defined, and the functions which he assigns to their divine representatives continually flow into one another. Nor has he yet learned to care to determine the relative worth and position of the objects of his adoration; but the temporary influence of the phenomenon to which he addresses his praises bears too strongly upon his mind to allow him for the time to consider the claims of rival powers to which at other times he is wont to look up with equal feelings of awe and reverence. It is this immediateness of impulse under which the human mind in its infancy strives to give utterance to its emotions that imparts to many of its outpourings the ring of monotheistic fervour.

The generic name given to these impersonations, viz. *deva* (“the shining ones”), points to the conclusion, sufficiently justified by the nature of the more prominent objects of Vedic adoration as well as by common natural occurrences, that it was the striking phenomena of light which first and most powerfully swayed the Āryan mind. In the primitive worship of the manifold phenomena of nature it is not, of course, so much their physical aspect that impresses the human heart as the moral and intellectual forces which are supposed to move and animate them. The attributes and relations of some of the Vedic deities, in accordance with the nature of the objects they represent, partake in a high degree of this spiritual element; but it is not improbable that in an earlier phase of Āryan worship the religious conceptions were pervaded by it to a still greater and more general extent, and that the Vedic belief, though retaining many of the primitive features, has on the whole assumed a more sensuous and anthropomorphic character. This latter element is especially predominant in the attributes and imagery applied by the Vedic poets to *Indra*, the god of the atmospheric region, the favourite figure in their pantheon.

While the representatives of the prominent departments of nature appear to the Vedic bard as co-existing in a state of independence of one another, their relation to the mortal worshipper being the chief subject of his anxiety, a simple method of classification was already resorted to at an early time, consisting in a triple division of the deities into gods residing in the sky in the air, and on earth. It is not, however, until a later stage,—the first clear indication being conveyed in a passage of the

tenth book of the *Rigveda*—that this attempt at a polytheistic system is followed up by the promotion of one particular god to the dignity of chief guardian for each of these three regions. On the other hand, a tendency is clearly traceable in some of the hymns towards identifying gods whose functions present a certain degree of similarity of nature; attempts which would seem to show a certain advance of religious reflection, the first steps from polytheism towards a comprehension of the unity of the divine essence. Another feature of the old Vedic worship tended to a similar result. The great problems of the origin and existence of man and the universe had early begun to engage the Hindū mind; and in celebrating the praises of the gods the poet was frequently led by his religious, and not wholly disinterested, zeal to attribute to them cosmical functions of the very highest order. At a later stage of thought, chiefly exhibited in the tenth book of the *Rigveda* and in the *Atharvaveda*, inquiring sages could not but perceive the inconsistency of such concessions of a supremacy among the divine rulers, and tried to solve the problem by conceptions of an independent power, endowed with all the attributes of a supreme deity, the creator of the universe, including the gods of the pantheon. The names under which this monotheistic idea is put forth are mostly of an attributive character, and indeed some of them, such as *Prajāpati* ("lord of creatures"), *Vishvakarman* ("all-worker"), occur in the earlier hymns as mere epithets of particular gods. But to other minds this theory of a personal creator left many difficulties unsolved. They saw, as the poets of old had seen, that everything around them, that man himself, was directed by some inward agent; and it needed but one step to perceive the essential sameness of these spiritual units, and to recognize their being but so many individual manifestations of one universal principle or spiritual essence. Thus a pantheistic conception was arrived at, put forth under various names, such as *Purusha* ("soul"), *Kāma* ("desire"), *Brahman* (neutr.; nom. sing. *brāhma*) ("devotion, prayer"). Metaphysical and theosophic speculations were thus fast undermining the simple belief in the old gods, until, at the time of the composition of the *Brāhmaṇas* and *Upanishads*, we find them in complete possession of the minds of the theologians. Whilst the theories crudely suggested in the later hymns are now further matured and elaborated, the tendency towards catholicity of formula favours the combination of the conflicting monotheistic and pantheistic conceptions; this compromise, which makes *Prajāpati*, the personal creator of the world, the manifestation of the impersonal *Brahma*, the universal self-existent soul, leads to the composite pantheistic system which forms the characteristic dogma of the Brāhmanical period (see BRAHMAN).

In the Vedic hymns two classes of society, the royal (or military) and the priestly classes, were evidently recognized as being raised above the level of the *Viś*, or bulk of the Āryan community. These social grades seem to have been in existence even before the separation of the two Asiatic branches of the Indo-Germanic race, the Āryans of Iran and India. It is true that, although the *Atharva*, *Rakhalśāo*, and *Vāstya* of the *Zend Avesta* correspond in position and occupation to the *Brāhman*, *Rājān* and *Viś* of the Veda, there is no similarity of names between them; but this fact only shows that the common vocabulary had not yet definitely fixed on any specific names for these classes. Even in the Veda their nomenclature is by no means limited to a single designation for each of them. Moreover, *Atharvan* occurs not infrequently in the hymns as the personification of the priestly profession, as the proto-priest who is supposed to have obtained fire from heaven and to have instituted the rite of sacrifice; and although *rakshishā* ("standing on a car") is not actually found in connexion with the *Rājān* or *Kshatriya*, its synonym *rathin* is in later literature a not unusual epithet of men of the military caste. At the time of the hymns, and even during the common Indo-Persian period, the sacrificial ceremonial had already become sufficiently complicated to call for the creation of a certain number of distinct priestly offices with special duties attached to them. While this shows clearly that the position and occupation of the priest were those of a profession, the fact that the terms *brāhmaṇa*

and *brāhmaṇa*, both denoting "the son of a brahman," are used in certain hymns as synonyms of *brāhman*, seems to justify the assumption that the profession had already, to a certain degree, become hereditary at the time when these hymns were composed. There is, however, with the exception of a solitary passage in a hymn of the last book, no trace to be found in the *Rigveda* of that rigid division into four castes separated from one another by insurmountable barriers, which in later times constitutes the distinctive feature of Hindū society. The idea of caste is expressed by the Sanskrit term *varṇa*, originally denoting "colour," thereby implying differences of complexion between the several classes. The word occurs in the Veda in the latter sense, but it is used there to mark the distinction, not between the three classes of the Āryan community, but between them on the one hand and a dark-coloured hostile people on the other. The latter, called *Dāsas* or *Dasyus*, consisted, no doubt, of the indigenous tribes, with whom the Āryans had to carry on a continual struggle for the possession of the land. The partial subjection of these comparatively uncivilized tribes as the rule of the superior race was gradually spreading eastward, and their submission to a state of serfdom under the name of *Sūdras*, added to the Āryan community an element, totally separated from it by colour, by habits, by language, and by occupation. Moreover, the religious belief of these tribes being entirely different from that of the conquering people, the pious Āryas, and especially the class habitually engaged in acts of worship, could hardly fail to apprehend considerable danger to the purity of their own faith from too close and intimate a contact between the two races. What more natural, therefore, than that measures should have been early devised to limit the intercourse between them within as narrow bounds as possible? In course of time the difference of vocation, and the greater or less exposure to the scorching influence of the tropical sky, added, no doubt, to a certain admixture of *Sūdra* blood, especially in the case of the common people, seem to have produced also in the Āryan population different shades of complexion, which greatly favoured a tendency to rigid class-restrictions originally awakened and continually fed by the lot of the servile race. Meanwhile the power of the sacerdotal order having been gradually enlarged in proportion to the development of the minutiae of sacrificial ceremonial and the increase of sacred lore, they began to lay claim to supreme authority in regulating and controlling the religious and social life of the people. The author of the so-called *Purusha-sūkta*, or hymn of *Purusha*, above referred to, represents the four castes—the *Brāhmaṇa*, *Kshatriya*, *Vaiśya* and *Sūdra*—as having severally sprung respectively from the mouth, the arms, the thighs and the feet of *Purusha*, a primary being, here assumed to be the source of the universe. It is very doubtful, however, whether at the time when this hymn was composed the relative position of the two upper castes could already have been settled in so decided a way as this theory might lead one to suppose. There is, on the contrary, reason to believe that some time had yet to elapse, marked by fierce and bloody struggles for supremacy, of which only imperfect ideas can be formed from the legendary and frequently biased accounts of later generations, before the *Kshatriyas* finally submitted to the full measure of priestly authority.

The definitive establishment of the Brāhmanical hierarchy marks the beginning of the Brāhmanical period properly so called. Though the origin and gradual rise of some of the leading institutions of this era can, as has been shown, be traced in the earlier writings, the chain of their development presents a break at this juncture which no satisfactory materials as yet enable us to fill up. A considerable portion of the literature of this time has apparently been lost; and several important works, the original composition of which has probably to be assigned to the early days of Brāhmanism, such as the institutes of *Manu* and the two great epics, the *Mahābhārata* and *Rāmāyaṇa*, in the form in which they have been handed down to us, show manifest traces of a more modern redaction. Yet it is sufficiently clear from internal evidence that *Manu's Code of Laws*, though

merely a metrical recast of older materials, reproduces on the whole pretty faithfully the state of Hindū society depicted in the sources from which it was compiled. The final overthrow of the Kshatriya power was followed by a period of jealous legislation on the part of the Brāhmins. For a time their chief aim would doubtless be to improve their newly gained vantage-ground by surrounding everything relating to their order with a halo of sanctity calculated to impress the lay community with feelings of awe. In the Brāhmanas and even in the Puruṣa Hymn, and the Atharvan, divine origin had already been ascribed to the Vedic Saṃhitās, especially to the three older collections. The same privilege was now successfully claimed for the later Vedic literature, so imbued with Brāhmanic aspirations and pretensions; and the authority implied in the designation of *Śruti* or revelation removed henceforth the whole body of sacred writings from the sphere of doubt and criticism. This concession necessarily involved an acknowledgment of the new social order as a divine institution. Its stability was, however, rendered still more secure by the elaboration of a system of conventional precepts, partly forming the basis of Manu's Code, which clearly defined the relative position and the duties of the several castes, and determined the penalties to be inflicted on any transgressions of the limits assigned to each of them. These laws are conceived with no sentimental scruples on the part of their authors. On the contrary, the offences committed by Brāhmins against other castes are treated with remarkable demerency, whilst the punishments inflicted for trespasses on the rights of higher classes are the more severe and inhuman the lower the offender stands in the social scale.

The three first castes, however unequal to each other in privilege and social standing, are yet united by a common bond of sacramental rites (*samskāras*), traditionally connected from ancient times with certain incidents and stages in the life of the Āryan Hindū, as conception, birth, name-giving, the first taking out of the child to see the sun, the first feeding with boiled rice, the rites of tonsure and hair-cutting, the youth's investiture with the sacrificial thread, and his return home on completing his studies, marriage, funeral, &c. The modes of observing these family rites are laid down in a class of writings called *Grihya-sūtras*, or domestic rules. The most important of these observances is the *upanayana*, or rite of conducting the boy to a spiritual teacher. Connected with this act is the investiture with the sacred cord, ordinarily worn over the left shoulder and under the right arm, and varying in material according to the class of the wearer. This ceremony being the preliminary act to the youth's initiation into the study of the Veda, the management of the consecrated fire and the knowledge of the rites of purification, including the *sāvitrī*, a solemn invocation to *Sāvitrī*, the sun (probl. Saturnus),—as a rule the verse *Rigv.* iii. 62. 10, also called *gāyatrī* from the metre in which it is composed—which has to be repeated every morning and evening before the rise and after the setting of that luminary, is supposed to constitute the second or spiritual birth of the Ārya. It is from their participation in this rite that the three upper classes are called the twice-born. The ceremony is enjoined to take place some time between the eighth and sixteenth year of age in the case of a Brāhman, between the eleventh and twenty-second year of a Kshatriya, and between the twelfth and twenty-fourth year of a Vaiśya. He who has not been invested with the mark of his class within this time is for ever excluded from uttering the sacred *sāvitrī* and becomes an outcast, unless he is absolved from his sin by a council of Brāhmins, and after due performance of a purificatory rite resumes the badge of his caste. With one not duly initiated no righteous man is allowed to associate or to enter into connexions of affinity. The duty of the Sūdra is to serve the twice-born classes, and above all the Brāhmins. He is excluded from all sacred knowledge, and if he performs sacrificial ceremonies he must do so without using holy mantras. No Brāhman must recite a Vedic text where a man of the servile caste might overhear him, nor must he even teach him the laws of expiating sin. The occupations of the Vaiśyas are those connected with trade, the cultivation of the land and the breeding

of cattle; while those of a Kshatriya consist in ruling and defending the people, administering justice, and the duties of the military profession generally. Both share with the Brāhman the privilege of reading the Veda, but only so far as it is taught and explained to them by their spiritual preceptor. To the Brāhman belongs the right of teaching and expounding the sacred texts, and also that of interpreting and determining the law and the rules of caste. Only in exceptional cases, when no teacher of the sacerdotal class is within reach, the twice-born youth, rather than forego spiritual instruction altogether, may reside in the house of a non-Brāhmanical preceptor; but it is specially enjoined that a pupil, who seeks the path to heaven, should not fail, as soon as circumstances permit, to resort to a Brāhman well versed in the Vedas and their appendages.

Notwithstanding the barriers placed between the four castes, the practice of intermarrying appears to have been too prevalent in early times to have admitted of measures of so stringent a nature as wholly to repress it. To marry a woman of a higher caste, and especially of a caste not immediately above one's own, is, however, decidedly prohibited, the offspring resulting from such a union being excluded from the performance of the *śrāddha* or obsequies to the ancestors, and thereby rendered incapable of inheriting any portion of the parents' property. On the other hand, a man is at liberty, according to the rules of Manu, to marry a girl of any or each of the castes below his own, provided he has besides a wife belonging to his own class, for only such a one should perform the duties of personal attendance and religious observance devolving upon a married woman. As regards the children born from unequal marriages of this description, they have the rights and duties of the twice-born, if their mother belong to a twice-born caste, otherwise they, like the offspring of the former class of intermarriages, share the lot of the Sūdra, and are excluded from the investiture and the *sāvitrī*. For this last reason the marriage of a twice-born man with a Sūdra woman is altogether discountenanced by some of the later law books. At the time of the code of Manu the intermixture of the classes had already produced a considerable number of intermediate or mixed castes, which were carefully defined, and each of which had a specific occupation assigned to it as its hereditary profession.

The self-exaltation of the first class was not, it would seem, altogether due to priestly arrogance and ambition; but, like a prominent feature of the post-Vedic belief, the transmigration of souls, it was, if not the necessary, yet at least a natural consequence of the pantheistic doctrine. To the Brāhmanical speculator who saw in the numberless individual existences of animate nature but so many manifestations of the one eternal spirit, to union with which they were all bound to tend as their final goal of supreme bliss, the greater or less imperfection of the material forms in which they were embodied naturally presented a continuous scale of spiritual units from the lowest degradation up to the absolute purity and perfection of the supreme spirit. To prevent one's sinking yet lower, and by degrees to raise one's self in this universal gradation, or, if possible, to attain the ultimate goal immediately from any state of corporeal existence, there was but one way—subjection of the senses, purity of life and knowledge of the deity. "He" (thus ends the code of Manu) "who in his own soul perceives the supreme soul in all beings and acquires equanimity toward them all, attains the highest state of bliss." Was it not natural then that the men who, if true to their sacred duties, were habitually engaged in what was most conducive to these spiritual attainments, that the Brāhmanical class early learnt to look upon themselves, even as a matter of faith, as being foremost among the human species in this universal race for final beatitude? The life marked out for them by that stern theory of class duties which they themselves had worked out, and which, no doubt, must have been practised in early times at least in some degree, was by no means one of ease and amenity. It was, on the contrary, singularly calculated to promote that complete mortification of the instincts of animal nature which they considered as indispensable to the

final deliverance from *samsāra*, the revolution of bodily and personal existence.

The pious Brāhman, longing to attain the *summum bonum* on the dissolution of his frail body, was enjoined to pass through a succession of four orders or stages of life, viz. those of *brahmachārin*, or religious student; *grihastha* (or *grihamadhin*), or householder; *sannyāsīn* (or *vīnaprastha*), or anchorite; and *sannyāsīn* (or *bhikkhu*), or religious mendicant. Theoretically this course of life was open and even recommended to every twice-born man, his distinctive class-occupations being in that case restricted to the second station, or that of married life. Practically, however, those belonging to the Kshatriya and Vaiśya castes were, no doubt, contented, with few exceptions, to go through a term of studentship in order to obtain a certain amount of religious instruction before entering into the married state, and plying their professional duties. In the case of the sacerdotal class, the practice probably was all but universal in early times; but gradually a more and more limited proportion even of this caste seem to have carried their religious zeal to the length of self-mortification involved in the two final stages. On the youth having been invested with the badge of his caste, he was to reside for some time in the house of some religious teacher, well read in the Veda, to be instructed in the knowledge of the scriptures and the scientific or theoretic treatises attached to them, in the social duties of his caste, and in the complicated system of purificatory and sacrificial rites. According to the number of Vedas he intended to study, the duration of this period of instruction was to be, probably in the case of Brāhmanical students chiefly, of from twelve to forty-eight years; during which time the virtues of modesty, duty, temperance and self-control were to be firmly implanted in the youth's mind by his unremitting observance of the most minute rules of conduct. During all this time the student had to subsist entirely on food obtained by begging from house to house; and his behaviour towards the preceptor and his family was to be that prompted by respectful attachment and implicit obedience. In the case of girls no investiture takes place, but for them the nuptial ceremony is considered as an equivalent to that rite. On quitting the teacher's abode, the young man returns to his family and takes a wife. To die without leaving legitimate offspring, and especially a son, capable of performing the periodical rite of obsequies (*śrāddha*), consisting of offerings of water and balls of rice, to himself and his two immediate ancestors, is considered a great misfortune by the orthodox Hindū. There are three sacred "debts" which a man has to discharge in life, viz. that which is due to the gods, and of which he acquits himself by daily worship and sacrificial rites; that due to the *rishis*, or ancient sages and inspired seers of the Vedic texts, discharged by the daily study of the scripture; and the "final debt" which he owes to his *manes*, and of which he relieves himself by leaving a son. To these three some authorities add a fourth, viz. the debt owing to humankind, which demands his continually practising kindness and hospitality. Hence the necessity of a man's entering into the married state. When the bridegroom leads the bride from her father's house to his own home, and becomes a *griha-pati*, or householder, the fire which has been used for the marriage ceremony accompanies the couple to serve them as their *gṛhapatya*, or domestic fire. It has to be kept up perpetually, day and night, either by themselves or their children, or, if the man be a teacher, by his pupils. If it should at any time become extinguished by neglect or otherwise, the guilt incurred thereby must be atoned for by an act of expiation. The domestic fire serves the family for preparing their food, for making the five necessary daily and other occasional offerings, and for performing the sacramental rites above alluded to. No food should ever be eaten that has not been duly consecrated by a portion of it being offered to the gods, the beings and the *manes*. These three daily offerings are also called by the collective name of *vaitvādasa*, or sacrifice "to all the deities." The remaining two are the offering to Brahṁā, i.e. the daily lecture of the scriptures, accompanied by certain rites, and that to men, consisting in the entertainment of guests.

The domestic observances—many of them probably ancient Aryan family customs, surrounded by the Hindūs with a certain amount of adventitious ceremonial—were generally performed by the householder himself, with the assistance of his wife. There is, however, another class of sacrificial ceremonies of a more pretentious and expensive kind, called *brahma* rites, or rites based on *śrīṣṭi*, or revelation, the performance of which, though not indispensable, were yet considered obligatory under certain circumstances (see BRAHMANA). They formed a very powerful weapon in the hands of the priesthood, and were one of the chief sources of their subsistence. However great the religious merit accruing from these sacrificial rites, they were obviously a kind of luxury which only rich people could afford to indulge in. They constituted, as it were, a tax, voluntary perhaps, yet none the less compulsory, levied by the priesthood on the wealthy laity.

When the householder is advanced in years, "when he perceives his skin become wrinkled and his hair grey, when he sees the son of his son," the time is said to have come for him to enter the third stage of life. He should now disengage himself from all family ties—except that his wife may accompany him, if she chooses—and repair to a lonely wood, taking with him his sacred fires and the implements required for the daily and periodical offerings. Clad in a deer's skin, in a single piece of cloth, or in a bark garment, with his hair and nails uncut, the hermit is to subsist exclusively on food growing wild in the forest, such as roots, green herbs, and wild rice and grain. He must not accept gifts from any one, except of what may be absolutely necessary to maintain him; but with his own little hoard he should, on the contrary, honour, to the best of his ability, those who visit his hermitage. His time must be spent in reading the metaphysical treatises of the Veda, in making oblations, and in undergoing various kinds of privation and austerities, with a view to mortifying his passions and producing in his mind an entire indifference to worldly objects. Having by these means succeeded in overcoming all sensual affections and desires, and in acquiring perfect equanimity towards everything around him, the hermit has fitted himself for the final and most exalted order, that of devotee or religious mendicant. As such he has no further need of either mortifications or religious observances; but "with the sacrificial fires reposit in his mind," he may devote the remainder of his days to meditating on the divinity. Taking up his abode at the foot of a tree in total solitude, "with no companion but his own soul," clad in a coarse garment, he should carefully avoid injuring any creature or giving offence to any human being that may happen to come near him. Once a day, in the evening, "when the charcoal fire is extinguished and the smoke no longer issues from the fire-places, when the pestle is at rest, when the people have taken their meals and the dishes are removed," he should go near the habitations of men, in order to beg what little food may suffice to sustain his feeble frame. Ever pure of mind he should thus bide his time, "as a servant expects his wages," wishing neither for death nor for life, until at last his soul is freed from its fetters and absorbed in the eternal spirit, the impersonal self-existent Brahṁā.

The tendency towards a comprehension of the unity of the divine essence had resulted in some minds, as has been remarked before, in a kind of monotheistic notion of the origin of the universe. In the literature of the Brāhmana period we meet with this conception as a common element of speculation; and so far from its being considered incompatible with the existence of a universal spirit, *Prajāpati*, the personal creator of the world, is generally allowed a prominent place in the pantheistic theories. Yet the state of theological speculation, reflected in these writings, is one of transition. The general drift of thought is essentially pantheistic, but it is far from being reduced to a regular system, and the ancient form of belief still enters largely into it. The attributes of *Prajāpati*, in the same way, have in them elements of a purely polytheistic nature, and some of the attempts at reconciling this new-fangled deity with the traditional belief are somewhat awkward. An ancient classification of the gods represented them as being thirty-three

number, eleven in each of the three worlds or regions of nature. These regions being associated each with the name of one principal deity, this division gave rise at a later time to the notion of a kind of triple divine government, consisting of *Āgni* (fire), *Indra* (sky) or *Vāyu* (wind), and *Sūrya* (sun), as presiding respectively over the gods on earth, in the atmosphere, and in the sky. Of this Vedic triad mention is frequently made in the Brāhmaṇa writings. On the other hand the term *prajāpati* (lord of creatures), which in the *Rigveda* occurs as an epithet of the sun, is also once in the *Atharvaveda* applied jointly to Indra and Agni. In the Brāhmaṇas Prajapati is several times mentioned as the thirty-fourth god; whilst in one passage he is called the fourth god, and made to rule over the three worlds. More frequently, however, the writings of this period represent him as the maker of the world and the father or creator of the gods. It is clear from this discordance of opinion on so important a point of doctrine, that at this time no authoritative system of belief had been agreed upon by the theologians. Yet there are unmistakable signs of a strong tendency towards constructing one, and it is possible that in yielding to it the Brāhmins may have been partly prompted by political considerations. The definite settlement of the caste system and the Brāhmanical supremacy must probably be assigned to somewhere about the close of the Brāhmaṇa period. Division in their own ranks was hardly favourable to the aspirations of the priests at such a time; and the want of a distinct formula of belief adapted to the general drift of theological speculation, to which they could all rally, was probably felt the more acutely, the more determined a resistance the military class was likely to oppose to their claims. Side by side with the conception of the Brahmā, the universal spiritual principle, with which speculative thought had already become deeply imbued, the notion of a supreme personal being, the author of the material creation, had come to be considered by many as a necessary complement of the pantheistic doctrine. But, owing perhaps to his polytheistic associations and the attributive nature of his name, the person of Prajapati seems to have been thought but insufficiently adapted to represent this abstract idea. The expedient resorted to for solving the difficulty was as ingenious as it was characteristic of the Brāhmanical aspirations. In the same way as the abstract denomination of sacerdotalism, the neuter *brahmā*, had come to express the divine essence, so the old designation of the individual priest, the masculine term *brahma*, was raised to denote the supreme personal deity which was to take the place and attributes of the Prajapati of the Brāhmaṇas and Upanishads (see BRAHMAN).

However the new dogma may have answered the purposes of speculative minds, it was not one in which the people generally were likely to have been much concerned; an abstract, colourless deity like Brahmā could awake no sympathies in the hearts of those accustomed to worship gods of flesh and blood. Indeed, ever since the primitive symbolical worship of nature had undergone a process of disintegration under the influence of metaphysical speculation, the real belief of the great body of the people had probably become more and more distinct from that of the priesthood. In different localities the principal share of their affection may have been bestowed on one or another of the old gods who was thereby raised to the dignity of chief deity; or new forms and objects of belief may have sprung up with the intellectual growth of the people. In some cases even the worship of the indigenous population could hardly have remained without exercising some influence in modifying the belief of the Aryan race. In this way a number of local deities would grow up, more or less distinct in name and characteristics from the gods of the Vedic pantheon. There is, indeed, sufficient evidence to show that, at a time when, after centuries of theological speculations, some little insight into the life and thought of the people is afforded by the literature handed down to us, such a diversity of worship did exist. Under these circumstances the policy which seems to have suggested itself to the priesthood, anxious to retain a firm hold on the minds of the people, was to recognize and incorporate into their system some of the most prominent objects of popular devotion, and thereby to establish

a kind of catholic creed for the whole community subject to the Brāhmanical law. At the time of the original composition of the great epics two such deities, *Śiva* or *Mahādeva* ("the great god") and *Vishnu*, seem to have been already admitted into the Brāhmanical system, where they have ever since retained their place; and from the manner in which they are represented in those works, it would, indeed, appear that both, and especially the former, enjoyed an extensive worship. As several synonyms are attributed to each of them, it is not improbable that in some of these we have to recognize special names under which the people in different localities worshipped these gods, or deities of a similar nature which, by the agency of popular poetry, or in some other way, came to be combined with them. The places assigned to them in the pantheistic system were co-ordinate with that of Brahmā; the three deities, *Brahmā*, *Vishnu* and *Śiva*, were to represent a triple impersonation of the divinity, as manifesting itself respectively in the creation, preservation and destruction of the universe. Śiva does not occur in the Vedic hymns as the name of a god, but only as an adjective in the sense of "kind, auspicious." One of his synonyms, however, is the name of a Vedic deity, the attributes and nature of which show a good deal of similarity to the post-Vedic god. This is *Rudra*, the god of the roaring storm, usually portrayed, in accordance with the element he represents, as a fierce, destructive deity, "terrible as a wild beast," whose fearful arrows cause death and disease to men and cattle. He is also called *kapardin* ("wearing his hair spirally braided like a shell"), a word which in later times became one of the synonyms of Śiva. The *Atharvaveda* mentions several other names of the same god, some of which appear even placed together, as in one passage *Bhava*, *Sarva*, *Rudra* and *Paśupati*. Possibly some of them were the names under which one and the same deity was already worshipped in different parts of northern India. This was certainly the case in later times, since it is expressly stated in one of the later works of the Brāhmaṇa period, that Sarva was used by the Eastern people and Bhava by a Western tribe. It is also worthy of note that in the same work (the *Satapatha-brāhmaṇa*), composed at a time when the Vedic triad of Agni, Indra-Vāyu and Sūrya was still recognized, attempts are made to identify this god of many names with Agni; and that in one passage in the *Mahābhārata* it is stated that the Brāhmins said that Agni was Śiva. Although such attempts at an identification of the two gods remained isolated, they would at least seem to point to the fact that, in adapting their speculations to the actual state of popular worship, the Brāhmins kept the older triad distinctly in view, and by means of it endeavoured to bring their new structure into harmony with the ancient Vedic belief. It is in his character as destroyer that Śiva holds his place in the triad, and that he must, no doubt, be identified with the Vedic Rudra. Another very important function appears, however, to have been early assigned to him, on which much more stress is laid in his modern worship—that of destroyer being more especially exhibited in his consort—viz. the character of a generative power, symbolized in the phallic emblem (*linga*) and in the sacred bull (*Nandi*), the favourite attendant of the god. This feature being entirely alien from the nature of the Vedic god, it has been conjectured with some plausibility, that the *linga*-worship was originally prevalent among the non-Aryan population, and was thence introduced into the worship of Śiva. On the other hand, there can, we think, be little doubt that Śiva, in his generative faculty, is the representative of another Vedic god whose nature and attributes go far to account for this particular feature of the modern deity, viz. *Pṛṣṇa*. This god, originally, no doubt, a solar deity, is frequently invoked, as the lord of nourishment, to bestow food, wealth and other blessings. He is once, jointly with Soma, called the progenitor of heaven and earth, and is connected with the marriage ceremony, where he is asked to lead the bride to the bridegroom and make her prosperous (*Sivatamā*). Moreover, he has the epithet *kapardin* (spirally braided), as have Rudra and the later Śiva, and is called *Paśupa*, or guardian of cattle, whence the latter derives his name *Paśupati*. But he is also a

strong, powerful, and even fierce and destructive god, who, with his goad or golden spear, smites the foes of his worshipper, and thus in this respect offers at least some points of similarity to Rudra, which may have favoured the fusion of the two gods. As regards *Vishnu*, this god occupies already a place in the Vedic mythology, though by no means one of such prominence as would entitle him to that degree of exaltation implied in his character as one of the three hypostases of the divinity. Moreover, although in his general nature, as a benevolent, genial being, the Vedic god corresponds on the whole to the later Vishnu, the preserver of the world, the latter exhibits many important features for which we look in vain in his prototype, and which most likely resulted from sectarian worship or from an amalgamation with local deities. In one or two of them, such as his names *Vāsudeva* and *Vaikuntha*, an attempt may again be traced to identify Vishnu with Indra, who, as we have seen, was one of the Vedic triad of gods. The characteristic feature of the elder Vishnu is his measuring the world with his three strides, which are explained as denoting either the three stations of the sun at the time of rising, culminating and setting, or the triple manifestation of the luminous element, as the fire on earth, the lightning in the atmosphere and the sun in the heavens.

The male nature of the triad was supposed to require to be supplemented by each of the three gods being associated with a female energy (*Sakti*). Thus *Vāch* or *Sarasvatī*, the goddess of speech and learning, came to be regarded as the *sakti*, or consort of Brahmā; *Śrī* or *Lakṣmī*, "beauty, fortune," as that of Vishnu; and *Uṃdā* or *Pārvatī*, the daughter of *Himavat*, the god of the Himalāya mountain, as that of Śiva. On the other hand, it is not improbable that *Pārvatī*—who has a variety of other names, such as *Kālī* ("the black one"), *Durgā* ("the inaccessible, terrible one"), *Māhā-devī* ("the great goddess")—enjoyed already a somewhat extensive worship of her own, and that there may thus have been good reason for assigning to her a prominent place in the Brāhmanical system.

A compromise was thus effected between the esoteric doctrine of the metaphysician and some of the most prevalent forms of popular worship, resulting in what was henceforth to constitute the orthodox system of belief of the Brāhmanical community. Yet the Vedic pantheon could not be altogether discarded, forming part and parcel, as it did, of that sacred revelation (*śruti*), which was looked upon as the divine source of all religious and social law (*smṛiti*, "tradition"), and being, moreover, the foundation of the sacrificial ceremonial on which the priestly authority so largely depended. The existence of the old gods is, therefore, likewise recognized, but recognized in a very different way from that of the triple divinity. For while the triad represents the immediate manifestation of the eternal, infinite soul—while it constitutes, in fact, the Brahmā itself in its active relation to mundane and seemingly material occurrences, the old traditional gods are of this world, are individual spirits or portions of the Brahmā like men and other creatures, only higher in degree. To them an intermediate sphere, the heaven of Indra (the *svarloka* or *svarga*), is assigned to which man may raise himself by fulfilling the holy ordinances; but they are subject to the same laws of being; they, like men, are liable to be born again in some lower state, and, therefore, like them, yearn for emancipation from the necessity of future individual existence. It is a sacred duty of man to worship these superior beings by invocations and sacrificial observances, as it is to honour the *pitris* ("the fathers"), the spirits of the departed ancestors. The spirits of the dead, on being judged by *Yama*, the Pluto of Hindū mythology, are supposed to be either passing through a term of enjoyment in a region midway between the earth and the heaven of the gods, or undergoing their measure of punishment in the nether world, situated somewhere in the southern region, before they return to the earth to animate new bodies. In Vedic mythology *Yama* was considered to have been the first mortal who died, and "espied the way to" the celestial abodes, and in virtue of precedence to have become the ruler of the departed; in some passages, however, he is already regarded as the god of

death. Although the pantheistic system allowed only a subordinate rank to the old gods, and the actual religious belief of the people was probably but little affected by their existence, they continued to occupy an important place in the affections of the poet, and were still represented as exercising considerable influence on the destinies of man. The most prominent of them were regarded as the appointed *Lohapādas*, or guardians of the world; and as such they were made to preside over the four cardinal and (according to some authorities) the intermediate points of the compass. Thus *Indra*, the chief of the gods, was regarded as the regent of the east; *Agni*, the fire (*ignis*), was in the same way associated with the south-east; *Yama* with the south, *Surya*, the sun ("Hæus"), with the south-west; *Varūṇa*, originally the representative of the all-embracing heaven (*Ōpavāis*) or atmosphere, now the god of the ocean, with the west; *Vāya* (or *Pavana*), the wind, with the north-west; *Kubera*, the god of wealth, with the north; and *Soma* (or *Chandra*) with the north-east. In the institutes of Manu the *Lohapādas* are represented as standing in close relation to the ruling king, who is said to be composed of particles of these his tutelary deities. The retinue of Indra consists chiefly of the *Gandharvas* (probably etym. connected with *ἀνθρώπος*), a class of genii, considered in the epics as the celestial musicians; and their wives, the *Apsaras*, lovely nymphs, who are frequently employed by the gods to make the pious devotee desist from carrying his austere practices to an extent that might render him dangerous to their power. *Nārada*, an ancient sage (probably a personification of the cloud, the "water-giver"), is considered as the messenger between the gods and men, and as having sprung from the forehead of Brahmā. The interesting office of the god of love is held by *Kāśmadra*, also called *Ananga*, the bodyless, because, as the myth relates, having once tried by the power of his mischievous arrow to make Śiva fall in love with Pārvatī, whilst he was engaged in devotional practices, the urchin was reduced to ashes by a glance of the angry god. Two other mythological figures of some importance are considered as sons of Śiva and Pārvatī, viz. *Kārtikeya* or *Skanda*, the leader of the heavenly armies, who was supposed to have been fostered by the six *Kṛittikās* or Pleiades; and *Gaṇeśa* ("lord of troops"), the elephant-headed god of wisdom, and at the same time the leader of the *śiṣi minorum gentium*.

Orthodox Brāhmanical scholasticism makes the attainment of final emancipation (*mukti*, *moksha*) dependent on perfect knowledge of the divine essence. This knowledge can only be obtained by complete abstraction of the mind from external objects and intense meditation on the divinity, which again presupposes the total extinction of all sensual instincts by means of austere practices (*tapas*). The chosen few who succeed in gaining complete mastery over their senses and a full knowledge of the divine nature become absorbed into the universal soul immediately on the dissolution of the body. Those devotees, on the other hand, who have still a residuum, however slight, of ignorance and worldliness left in them at the time of their death, pass to the world of Brahmā, where their souls, invested with subtle corporeal frames, await their reunion with the Eternal Being.

The pantheistic doctrine which thus forms the foundation of the Brāhmanical system of belief found its most complete exposition in one of the six orthodox *darsanas*, or philosophical systems, the *Vedānta* philosophy. These systems are considered as orthodox inasmuch as they recognize the Veda as the revealed source of religious belief, and never fail to claim the authority of the ancient seers for their own teachings, even though—as in the case of Kapila, the founder of the materialistic Sāṅkhya system—they involve the denial of so essential a dogmatic point as the existence of a personal creator of the world. So much, indeed, had freedom of speculative thought become a matter of established habit and intellectual necessity, that no attempt seems ever to have been made by the leading theological party to put down such heretical doctrines, so long as the sacred character of the privileges of their caste was not openly called in question. Yet internal dissensions on such cardinal points of belief could not but weaken the authority of the hierarchical

body; and as they spread beyond the narrow bounds of the Brahmanical schools, it wanted but a man of moral and intellectual powers, and untrammelled by class prejudices, to render them fatal to priestly pretensions. Such a man arose in the person of a Sākya prince of Kapilavastu, Gotama, the founder of Buddhism (about the 6th century B.C.). Had it only been for the philosophical tenets of Buddha, they need scarcely have caused, and probably did not cause, any great uneasiness to the orthodox theologians. He did, indeed, go one step beyond Kapila, by altogether denying the existence of the soul as a substance, and admitting only certain intellectual faculties as attributes of the body, perishable with it. Yet the conception which Buddha substituted for the transmigratory soul, viz. that of *karma* ("work"), as the sum total of the individual's good and bad actions, being the determinative element of the form of his future existence, might have been treated like any other speculative theory, but for the practical conclusions he drew from it. Buddha recognized the institution of caste, and accounted for the social inequalities attendant thereon as being the effects of *karma* in former existences. But, on the other hand, he altogether denied the revealed character of the Veda and the efficacy of the Brahmanical ceremonies deduced from it, and rejected the claims of the sacerdotal class to be the repositories and divinely appointed teachers of sacred knowledge. That Buddha never questioned the truth of the Brahmanical theory of transmigration shows that this early product of speculative thought had become firmly rooted in the Hindū mind as a tenet of belief amounting to moral conviction. To the Hindū philosopher this doctrine seemed alone to account satisfactorily for the apparent essential similarity of the vital element in all animate beings, no less than for what elsewhere has led honest and logical thinkers to the stern dogma of predestination. The belief in eternal bliss or punishment, as the just recompense of man's actions during this brief term of human life, which their less reflective forefathers had at one time held, appeared to them to involve a moral impossibility. The equality of all men, which Buddha preached with regard to the final goal, the *nirvāna*, or extinction of *karma* and thereby of all future existence and pain, and that goal to be reached, not by the performance of penance and sacrificial worship, but by practising virtue, could not fail to be acceptable to many people. It would be out of place here to dwell on the rapid progress and internal development of the new doctrine. Suffice it to say that, owing no doubt greatly to the sympathizing patronage of ruling princes, Buddhism appears to have been the state religion in most parts of India during the early centuries of our era. To what extent it became the actual creed of the body of the people it will probably be impossible ever to ascertain. One of the chief effects it produced on the worship of the old gods was the rapid decline of the authority of the orthodox Brahmanical dogma, and a considerable development of sectarianism. (See HINDUISM.)

See H. H. Wilson, *Essays on the Religion of the Hindus*; J. Muir, *Original Sanskrit Texts*; M. Müller, *History of Ancient Sanskrit Literature*; C. Lassen, *Indische Alterthumskunde*; Elphinstone, *History of India*, ed. by E. B. Cowell. (J. E.)

BRAHMAPUTRA, a great river of India, with a total length of 1800 m. Its main source is in a great glacier-mass of the northernmost chain of the Himalayas, called Kubianganri, about 82° N., and receives various tributaries including one formerly regarded as the true source from the pass of Mariam La (15,500 ft.), which separates its basin from the eastern affluents of the Mansarwar lakes, at least 100 m. south-east of those of the Indus. It flows in a south-easterly direction for 170 m., and then adheres closely to a nearly easterly course for 500 m. more, being at the end of that distance in 29°10' N. lat. It then bends north-east for 150 m. before finally shaping itself southwards towards the plains of Assam. Roughly speaking, the river may be said so far to run parallel to the main chain of the Himalaya at a distance of 100 m. therefrom. Its early beginnings take their rise amidst a mighty mass of glaciers which cover the northern slopes of the watershed, separating them from the sources of the Gogra on the south; and there is evidence that

two of its great southern tributaries, the Shorta Tsampo (which joins about 150 m. from its source), and the Nyang Chu (the river of Shigatse and Gyantse), are both also of glacial origin. From the north it receives five great tributaries, namely, the Chu Nago, the Chachu Tsampo and the Charta Tsampo (all within the first 200 m. of its course), and the Raka Tsampo and Kyi-chu (or river of Lhasa) below. The Chachu and the Charta are large clear streams, evidently draining from the great central lake district. Both of them measure more than 200 yds. in width at the point of junction, and they are clearly non-glacial. The Raka Tsampo is a lateral affluent, flowing for 200 m. parallel to the main river course and some 20 to 30 m. north of it, draining the southern slopes of a high snowy range. It is an important feature as affording foothold for the Janglam (the great high road of southern Tibet connecting Ladakh with China), which is denied by the actual valley of the Brahmaputra. The great river itself is known in Tibet by many names, being generally called the Nari Chu, Maghang Tsampo or Yaro Tsampo, above Lhasa; the word "tsampo" (tsang-po) meaning (according to Waddell) the "pure one," and applying to all great rivers. Fifty miles from its source the river and the Janglam route touch each other, and from that point past Tadam (the first important place on its banks) for another 130 m., the road follows more or less closely the left bank of the river. Then it diverges northwards into the lateral valley of the Raka, until the Raka joins the Brahmaputra below Janglache. The upper reaches are nowhere fordable between Tadam and Lhasa, but there is a ferry at Likhe (opposite Tadam on the southern bank), where wooden boats covered with hide effect the necessary connexion between the two banks and ensure the passage of the Nepal trade. From Janglache (13,800 ft.) to Shigatse the river is navigable, the channel being open and wide and the course straight. This is probably the most elevated system of navigation in the world. From Shigatse, which stands near the mouth of the Nyang Chu, to the Kyi-chu, or Lhasa river, there is no direct route, the river being unnavigable below Shigatse. The Janglam takes a circuitous course southwards to Gyantse and the Yamdok Cho before dropping again over the Khambala pass to the ferry at Khamba barje near Chushul. Thence the valley of the Kyi-chu (itself navigable for small boats for about 30 m.) leads to Lhasa northwards. At Chushul there is an iron chain-and-rope suspension bridge over the deepest part of the river, but it does not completely span the river, and it is too insecure for use. The remains of a similar bridge exist at Janglache; but there are no wooden or twig suspension bridges over the Tsampo. At Tadam the river is about one half as wide again as the Ganges at Hardwar in December, i.e. about 250 to 300 yds. At Shigatse it flows in a wide extended bed with many channels, but contracts again at Chushul, where it is no wider than it is at Janglache, i.e. from 600 to 700 yds. At Chushul (below the Kyi-chu) the discharge of the river is computed to be about 35,000 cub. ft. per second, or seven times that of the Ganges at Hardwar.

For about 250 m. below Kyi-chu to a point about 20 m. below the great southerly bend (in 94° E. long.) the course of the Brahmaputra has been traced by native surveyors. Then it is lost amidst the jungle-covered hills of the wild Mishmi and Abor tribes to the east of Bhutan for another 100 m., until it is again found as the Dihong emerging into the plains of Assam. About the intervening reaches of the river very little is known except that it drops through 7000 ft. of altitude, and that in one place, at least, there exist some very remarkable falls. These are placed in 29° 40' N. lat., between Kongbu and Pema-Koi. Here the river runs in a narrow precipitous defile along which no path is practicable. The falls can only be approached from below, where a monastery has been erected, the resort of countless pilgrims. Their height is estimated at 70 ft., and by Tibetan report the hills around are enveloped in perpetual mist, and the Sangdong (the "lion's face"), over which the waters rush, is demon-haunted and full of mystic import. Up to comparatively recent years it was matter for controversy whether the Tsampo formed the upper reaches of the Dihong or of the Irrawaddy. From the north-eastern extremity of Assam

where, near Sadya, the Lohit, the Dihong and the Dihong unite to form the wide placid Brahmaputra of the plains—one of the grandest rivers of the world—its south-westerly course to the Bay of Bengal is sufficiently well known. It still retains the proud distinction of being unbridged, and still the River Flotilla Company appoints its steamers at regular intervals to visit all the chief ports on its banks as far as Dibrugarh. Here, however, a new feature has been introduced in the local railway, which extends for some 80 m. to Sadya, with a branch to the Buri Dihing river at the foot of the Patkoi range. The Patkoi border the plains of Upper Assam to the south-east, and across these hills lies the most reasonable probability of railway extension to Burma.

The following are the "lowest level" discharges of the principal affluents of the Brahmaputra in Upper Assam, estimated in cubic feet per second:—

Lohit river, 9 m. above Sadya	38,800
Dihong, 1 m. above junction with Dihong	27,200
Dihong " " " " " " " "	53,400
Subansiri " " " " " " " "	16,900

The basins of the Dihong and Subansiri are as yet very imperfectly known. That of the Lohit has been fairly well explored. Near Goalpara the discharge of the river in January 1828 was computed to be 140,000 cub. ft., or nearly double that of the Ganges. The length of the river is 700 m. to the Dihong junction, and about 1000 in Tibet and eastern Bhutan, above the Dihong. The Brahmaputra, therefore, exceeds the Ganges in length by about 400 m. The bed of the great river maintains a fairly constant position between its extreme banks, but the channels within that bed are so constantly shifting as to require close supervision on the part of the navigation authorities; so much detritus is carried down as to form a perpetually changing series of obstructions to steamer traffic.

An enormous development of agricultural resources has taken place within the Brahmaputra basin of late years, chiefly in the direction of tea cultivation, as well as in the production of jute and silk. Gold is found in the sands of all its upper tributaries, and coal and petroleum are amongst the chief mineral products which have been brought into economic prominence. During the rains the Brahmaputra floods hundreds of square miles of country, reaching a height of 30 to 40 ft. above its usual level. This supersedes artificial irrigation, and the plains so watered yield abundantly in rice, jute and mustard.

See *Reports of the native explorers of the Indian Survey*, edited by Montgomery and Harman; *Imperial Gazetteer of India* (1908); Sir T. H. Holdich, *India* ("Regions of the World" series, 1903); Ryder, *Geographical Journal*, 1905; Rawlings, *The Great Plateau* (1906). (T. H. H.)

BRAHMA SAMAJ, a religious association in India which owes its origin to (Raja) Ram Mohan Roy, who began teaching and writing in Calcutta soon after 1800. The name means literally the "Church of the One God," and the word *Samaj*, like the word Church, bears both a local and a universal, or an individual and a collective meaning. Impressed with the perversions and corruptions of popular Hinduism, Ram Mohan Roy investigated the Hindu Shastras, the Koran and the Bible, repudiated the polytheistic worship of the Shastras as false, and inculcated the reformed principles of monotheism as found in the ancient Upanishads of the Vedas. In 1816 he established a society, consisting only of Hindus, in which texts from the Vedas were recited and theistic hymns chanted. This, however, soon died out through the opposition it received from the Hindu community. In 1830 he organized the society known as the Brahma Samaj.

The following extract from the trust-deed of the building dedicated to it will show the religious belief and the purposes of its founder. The building was intended to be "a place of public meeting for all sorts and descriptions of people, without distinction, who shall behave and conduct themselves in an orderly, sober, religious and devout manner, for the worship and adoration of the eternal, unsearchable and immutable Being, who is the author and preserver of the universe, but not under and by any other name, designation or title, peculiarly used

for and applied to any particular being or beings by any man or set of men whatsoever; and that no graven image, statue or sculpture, carving, painting, picture, portrait or the likeness of anything shall be admitted within the said message, building, land, tenements, hereditament and premises; and that no sacrifice, offering or oblation of any kind or thing shall ever be permitted therein; and that no animal or living creature shall within or on the said message, &c., be deprived of life either for religious purposes or food, and that no eating or drinking (except such as shall be necessary by any accident for the preservation of life), feasting or rioting be permitted therein or thereon; and that in conducting the said worship or adoration, no object, animate or inanimate, that has been or is or shall hereafter become or be recognized as an object of worship by any man or set of men, shall be reviled or slightly or contemptuously spoken of or alluded to, either in preaching or in the hymns or other mode of worship that may be delivered or used in the said message or building; and that no sermon, preaching, discourse, prayer or hymns be delivered, made or used in such worship, but such as have a tendency to the contemplation of the Author and Preserver of the universe or to the promotion of charity, morality, piety, benevolence, virtue and the strengthening of the bonds of union between men of all religious persuasions and creeds."

The new faith at this period held to the Vedas as its basis. Ram Mohan Roy soon after left India for England, and took up his residence in Bristol, where he died in 1835. The Brahma Samaj maintained a bare existence till 1841, when Baba Debendra Nath Tagore, a member of a famous and wealthy Calcutta family, devoted himself to it. He gave a printing-press to the Samaj, and established a monthly journal called the *Tattvobodhini Patrika*, to which the Bengali language now owes much for its strength and elegance. About 1850 some of the followers of the new religion discovered that the greater part of the Vedas is polytheistic, and a schism took place,—the advanced party holding that nature and intuition form the basis of faith. Between 1847 and 1858 branch societies were formed in different parts of India, especially in Bengal, and the new society made rapid progress, for which it was largely indebted to the spread of English education and the work of Christian missionaries. In fact the whole Samaj movement is as distinct a product of the contest of Hinduism with Christianity in the 19th century, as the *Panth* movement was of its contest with Islam 300 years earlier.

The Brahma creed was definitely formulated as follows:— (1) The book of nature and intuition supplies the basis of religious faith. (2) Although the Brahmans do not consider any book written by man the basis of their religion, yet they do accept with respect and pleasure any religious *truth* contained in any book. (3) The Brahmans believe that the religious condition of man is progressive, like the other departments of his condition in this world. (4) They believe that the fundamental doctrines of their religion are also the basis of every true religion. (5) They believe in the existence of one Supreme God—a God endowed with a distinct personality, moral attributes worthy of His nature and an intelligence befitting the Governor of the universe, and they worship Him alone. They do not believe in any of His incarnations. (6) They believe in the immortality and progressive state of the soul, and declare that there is a state of conscious existence succeeding life in this world and supplementary to it as respects the action of the universal moral government. (7) They believe that repentance is the only way to salvation. They do not recognize any other mode of reconciliation to the offended but loving Father. (8) They pray for *spiritual* welfare and believe in the *efficacy* of such prayers. (9) They believe in the providential care of the divine Father. (10) They avow that love towards Him and the performances of the works which He loves, constitute His worship. (11) They recognise the necessity of public worship, but do not believe that communion with the Father depends upon meeting in any fixed place at any fixed time. They maintain that they can adore Him at any time and at any place, provided that the time and the place are

calculated to compose and direct the mind towards Him. (12) They do not believe in pilgrimages and declare that holiness can only be attained by elevating and purifying the mind. (13) They put no faith in rites or ceremonies, nor do they believe in penances as instrumental in obtaining the grace of God. They declare that moral righteousness, the gaining of wisdom, divine contemplation, charity and the cultivation of devotional feelings are their rites and ceremonies. They further say, govern and regulate your feelings, discharge your duties to God and to man, and you will gain everlasting blessedness; purify your heart, cultivate devotional feelings and you will see Him who is unseen. (14) Theoretically there is no distinction of caste among the Brahmas. They declare that we are all the children of God, and therefore must consider ourselves as brothers and sisters.

For long the Brahmas did not attempt any social reforms. But about 1865 the younger section, headed by Babu Keshub Chunder Sen, who joined the Samaj in 1857, tried to carry their religious theories into practice by demanding the abandonment of the external signs of caste distinction. This, however, the older members opposed, declaring such innovations to be premature. A schism resulted, Keshub Chunder Sen and his followers founding the Progressive Samaj, while the conservative stock remained as the Adi (i.e. original) Samaj, their aim being to "fulfil" rather than to abrogate the old religion. The vitality of the movement, however, had left it, and its inconsistencies, combined with the lack of strong leadership, landed it in a position scarcely distinguishable from orthodox Hinduism. Debendra Nath Tagore sought refuge from the difficulty by becoming an ascetic. The "Brahma Samaj of India," as Chunder Sen's party styled itself, made considerable progress extensively and intensively until 1878, when a number of the most prominent adherents, led by Anand Mohan Bose, took umbrage at Chunder Sen's despotic rule and at his disregard of the society's regulations concerning child marriage. This led to the formation of the Sadharana (Universal) Brahma Samaj, now the most popular and progressive of the three sections of the movement and conspicuous for its work in the cause of literary culture, social reform and female education in India. But even when we add all sections of the Brahma Samaj together, the total number of adherents is only about 4000, mostly found in Calcutta and its neighbourhood. A small community (about 130) in Bombay, known as the Prarthna (Prayer) Samaj, was founded in 1867 through Keshub Chunder's influence; they have a similar creed to that of the Brahma Samaj, but have broken less decisively with orthodox and ceremonial Hinduism.

See the articles on ARYA SAMAJ, KESHUB CHUNDER SEN, RAM MOHAN ROY. Also John Robson, *Hinduism and Christianity*; and the *Theistic Quarterly Review* (the organ of the Society since 1880).

BRAHMS, JOHANNES (1833-1897), German composer, was born in Hamburg on the 7th of May 1833. He was the son of a double-bass player in the Hamburg city theatre and received his first musical instruction from his father. After some lessons from O. Cossel, he went to Cossel's master, Eduard Marxsen of Altona, whose experience and artistic taste directed the young man's genius into the highest paths. A couple of public appearances as a pianist were hardly an interruption to the course of his musical studies, and these were continued nearly up to the time when Brahms accepted an engagement as accompanist to the Hungarian violinist, Remenyi, for a concert tour in 1853. At Göttingen there occurred a famous *contretemps* which had a most important though indirect influence on the whole after-life of the young player. A piano on which he was to play the "Kreutzer" sonata of Beethoven with Remenyi turned out to be a semitone below the required pitch; and Brahms played the part by heart, transposing it from A to B flat, in such a way that the great violinist, Joachim, who was present and discerned what the feat implied, introduced himself to Brahms, and laid the foundation of a life-long friendship. Joachim gave him introductions to Liszt at Weimar and to Schumann at Düsseldorf; the former hailed him for a time as a member of the advanced party in music, on the strength of his E flat minor scherzo, but the misapprehension was not of long continuance. The intro-

duction to Schumann impelled that master, now drawing near the tragic close of his career, to write the famous article "Neue Bahnen," in which the young Brahms was proclaimed to be the great composer of the future, "he who was to come." The critical insight in Schumann's article is all the more surprising when it is remembered how small was the list of Brahms's works at the time. A string quartet, the first pianoforte sonata, the scherzo already mentioned, and the earliest group of songs, containing the dramatic "Liebestreu," are the works which drew forth the warm commendations of Schumann. In December 1853 Brahms gave a concert at Leipzig, as a result of which the firms of Breitkopf & Haertel and of Senff undertook to publish his compositions. In 1854 he was given the post of choir-director and music-master to the prince of Lippe-Deilmold, but he resigned it after a few years, going first to Hamburg, and then to Zürich, where he enjoyed the friendship and artistic counsel of Theodor Kirchner. The unfavourable verdict of the Leipzig Gewandhaus audience upon his pianoforte concerto in D minor op. 15, and several remarkably successful appearances in Vienna, where he was appointed director of the Singakademie in 1863, were the most important external events of Brahms's life, but again he gave up the conductorship after a few months of valuable work, and for about three years had no fixed place of abode. Concert tours with Joachim or Stockhausen were undertaken, and it was not until 1867 that he returned to Vienna, or till 1872 that he chose it definitely as his home, his longest absence from the Austrian capital being between 1874 and 1878, when he lived near Heidelberg. From 1871 to 1874 he conducted the concerts of the "Gesellschaft der Musikfreunde," but after the later date he occupied no official position of any kind. With the exception of journeys to Italy in the spring, or to Switzerland in the summer, he rarely left Vienna. He refused to come to England to take the honorary degree of Mus.D. offered by the university of Cambridge; the university of Breslau made him Ph.D. in 1881; in 1886 he was created a knight of the Prussian order *Pour le mérite*, and in 1889 was presented with the freedom of his native city. He died in Vienna on the 3rd of April 1897.

The works of Brahms may be summarized as follows:—*Various sacred compositions for chorus*, op. 12, 13, 22, 27, 29, 30, 37, leading up to op. 45, the "German Requiem" first performed at Bremen in 1868, and subsequently completed by a soprano solo with chorus; the "Triumphlied" in commemoration of the German victories of 1870-71; and some choral songs and motets, op. 74, 109 and 110. *Secular choral works*, op. 17, 41, 42, 44, 50 ("Ripaldo" for tenorsolo and male choir), 53 ("Rhapsodie," alto solo and male choir), 54 ("Schicksalslied"), 62, 82 (Schiller's Nänie), 89 ("Gesang der Parzen"), 93, 104, 113. *Concerted vocal works*, op. 20, 28, 31, 52 ("Liebeslieder-Walzer") 61, 64, 65 ("Neue Liebeslieder"), 75, 92, 103, 112. *Solo songs*, nearly 300. *Orchestral works*: four symphonies, op. 68, 73, 90 and 98; two serenades, op. 11 and 16; two pianoforte concertos, op. 15 and 83, one violin concerto, op. 77; concerto for violin and violoncello, op. 102; variations on a theme by Haydn, op. 56; two overtures, "Academische Festouvertüre," op. 80, and "Tragic Overture," op. 81. *Chamber music*: two sextets, op. 18 and 36; quintet, piano and strings, op. 34, strings, op. 88 and 111; clarinet and strings, op. 115; three string quartets, op. 51 and 67, three quartets for piano and strings, op. 25, 26 and 60. Three trios for piano and strings, op. 8, 87 and 101; trio for piano, violin and horn, op. 40; piano, clarinet and violoncello, op. 114. Duet sonatas, three for piano and violin, op. 78, 100 and 108; two for piano and violoncello, op. 38 and 99; two for piano and clarinet, op. 120. *Pianoforte solos*: three sonatas, op. 1, 2 and 5; scherzo, op. 4; variations, op. 9, 21, 23, 24, 35; 4 ballads, op. 10; waltzes, op. 39; two rhapsodies, op. 79; caprices and intermezzi, op. 76, 116, 117, 118 and 119. 5 *studies* and 51 *Übungen* without opus-number, and a *chorale-prelude and fugue* for organ, besides four books of *Hungarian Dances* arranged for pianoforte duet.

Brahms has often been called the last of the great classical masters, in a sense wider than that of his place in the long line of

the great composers of Germany. Though only the most superficial observers could deny him the possession of qualities which distinguish the masters of the romantic school, it is as a classicist that he must be ranked among modern musicians. From the beginning of his career until its close, his ideas were clothed by preference in the forms which had sufficed for Beethoven, and the instances in which he departed from structural precedent are so rare that they might be disregarded, were they not of such high value that they must be considered as the signs of a logical development of musical form, and not as indicating a spirit of rebellion against existing modes of structure. His practice, more frequent in later than in earlier life, of welding together the "working-out" and the "recapitulation" sections of his movements in a closer union than any of his predecessors had attempted, is an innovation which cannot fail to have important results in the future; and if the skill of younger writers is not adequate to such a display of ingenuity as occurs in the finale of the fourth symphony, where the "passacaglia" form has been used with an effect that is almost bewildering to the ordinary listener, that at least stands as a monument of inventiveness finely subordinated to the emotional and intellectual purport of the thoughts expressed. His themes are always noble, and even from the point of view of emotional appeal their deep intensity of expression is of a kind which grows upon all who have once been awakened to their beauty, or have been at the pains to grasp the composer's characteristics of utterance. His vocal music, whether for one voice or many, is remarkable for its fidelity to natural inflection and accentuation of the words, and for its perfect reflection of the poet's mood. His songs, vocal quartets and choral works abound in passages that prove him a master of effects of sound; and throughout his chamber music, in his treatment of the piano, of the strings, or of the solo wind instruments he employs, there are numberless examples which sufficiently show the irrelevance of a charge sometimes brought against his music, that it is deficient in a sense of what is called "tone-colour." It is perfectly true that the mere acoustic effect of a passage was of far less importance to him than its inherent beauty, poetic import, or logical fitness in a definite scheme of development; and that often in his orchestral music the casual hearer receives an impression of complexity rather than of clearness, and is apt to imagine that the "thickness" of instrumentation is the result of clumsiness or carelessness. Such instances as the introduction to the finale of the first symphony, the close of the first movement of the second, what may be called the epilogue of the third, or the whole of the variations on a theme of Haydn, are not only marvels of delicate workmanship in regard to structure, but are instinct with the sense of the peculiar beauty and characteristics of each instrument. The "Academic Festival" overture proves Brahms a master of musical humour, in his treatment of the student songs which serve as its themes; and the companion piece, the "Tragic" overture, reaches a height of sublimity which is in no way lessened because no particular tragedy has ever been named in conjunction with the work.

As with all creative artists of supreme rank, the work of Brahms took a considerable time before it was very generally appreciated. The change in public opinion is strikingly illustrated in regard to the songs, which, once voted ineffective and unvocal, have now taken a place in every eminent singer's repertory. The outline in his greater works must be grasped with some definiteness before the separate ideas can be properly understood in their true relation to each other; and while it is his wonderful power of handling the recognized classical forms, so as to make them seem absolutely new, which stamps him as the greatest musical architect since Beethoven, the necessity for realizing in some degree what musical form signifies has undoubtedly been a bar to the rapid acceptance of his greater works by the uneducated lovers of music. These are of course far more easily moved by effects of colour than by the subtler beauties of organic structure, and Brahms's attitude towards tone-colour was scarcely such as would endear him to the large number of musicians in whose view tone-colour is pre-eminent. His mastery of form, again, has been attacked as formalism by superficial critics, blind to the real

inspiration and distinction of his ideas, and to their perfection in regard to style and the appropriateness of every theme to the exact emotional state to be expressed. In his larger vocal works there are some which treat of emotional conditions far removed from the usual stock of subjects taken by the average composer; to compare the ideas in the "German Requiem" with those of the "Schicksalslied" or "Nänic" is to learn a lesson in artistic style which can never be forgotten. In the songs, too, it is scarcely too much to say that the whole range of human emotion finds expression in noble lyrics that yield to none in actual musical beauty. The four "Ernste Gesänge," Brahms's last composition, must be considered as his supreme achievement in dignified utterance of noble thoughts in a style that perfectly fits them. The choice of words for these as well as for the "Requiem" and others of his serious works reveals a strong sense of the vanity and emptiness of human life, but at least as strong a confidence in the divine consolations.

It has been the misfortune of the musical world in Germany that every prominent musician is ranged by critics and amateurs in one of two hostile camps, and it was probably due in the main to the misrepresentations of the followers of Wagner that the idea was so generally held that Brahms was a man of narrow sympathies and hard, not to say brutal manners. The latter impression was fostered, no doubt, by the master's natural detestation of the methods by which the average lionizer seeks to gain his object, and both alike are disproved in the *Recollections* of J. V. Widmann, an intimate friend for many years, which throw a new light on the master, revealing him as a man of the widest artistic sympathies, neither intolerant of excellence in a line opposed to his own, nor weakly enthusiastic over mediocre productions by composers whose views were in complete sympathy with him. His admiration for Verdi and Wagner is enough to show that the absence of any operatic work from his list of compositions was simply due to the difficulty of finding a libretto which appealed to him, not to any antagonism to the lyric stage in its modern developments. How far he stood from the prejudices of the typical pedant may be seen in the passionate love he showed throughout his life for national music, especially that of Hungary. Not only were his arrangements of Hungarian dances the first work by which his name was known outside his native land, but his first pianoforte quartet, op. 25 in G minor, incurred the wrath of the critics of the time by its introduction of some characteristics of Hungarian music into the finale. His arrangement of a number of children's traditional songs was published without his name, and dedicated to the children of Robert and Clara Schumann in the earliest years of his creative life; and among the last of his publications was a collection of forty-nine German Volklieder, arranged with the utmost skill, taste and simplicity. He had a great admiration for the waltzes of Strauss, and in many passages of his own works the *entrain* that is characteristic of the Viennese dance-writers is present in a striking degree.

See also W. H. Hadow, *Studies in Modern Music* (2nd series, 1908); and the articles MUSIC, SONG. (J. A. F. M.)

BRAHUI, a people of Baluchistan, inhabiting the Brahui mountains, which extend continuously from near the Bolan Pass to Cape Monze on the Arabian Sea. The khan of Kalat, the native ruler of Baluchistan, is himself a Brahui, and a lineal descendant of Kumbar, former chief of the Kumbarini, a Brahui tribe. The origin of the Brahuis is an ethnological mystery. Bishop Robert Caldwell and other authorities declare them Dravidian, and regard them as the western borderers of Dravidian India. Others believe them to be Scythians,¹ and others again connect them with Tatar

¹ Compare Mountstuart Elphinstone's *History of India*, 9th ed., 1805, p. 249) description of Scythians with physique of Brahuis. A relationship between the Jats (*q.v.*) and the Brahuis has been suggested, and it is generally held that the former were of Scythic stock. The Mengals, Bizanjogs and Zehris, the three largest Brahui tribes, are called Jaldal or Jagdal, *i.e.* Jats, by some of their neighbours. The Zaghar Mengal, a superior division of the Mengal tribe, believe they themselves came from a district called Zughd, somewhere near Samarkand in central Asia. *Gal* appears to be a collective

mountaineers who early settled in southern parts of Asia. The origin of the word itself is in doubt. It is variously derived as a corruption of the Persian *Ba Rokhi* (literally "of the hills"); as an eponym from Braho, otherwise Brahmin or Ibrahim, a legendary hero of alleged Arab descent who led his people "out of the west," while Dr Gustav Oppert believes that the name is in some way related to, if not identical with, that of the Baluchis. He recognizes in the name of the Paratas and Paradas, who dwell in north-eastern Baluchistan, the origin of the modern Brahui. He gives reasons for regarding the *Bra* as a contraction of *Bara* and obtains "thus in Barahui a name whose resemblance to that of the ancient Barrhai (the modern Bhars), as well as to that of the Paratas and Parava and their kindred the Maratha Paravari and Dravidian Parheyas of Palaman, is striking." The Brahuis declare themselves to be the aborigines of the country they now occupy, their ancestors coming from Aleppo. For this there seems little foundation, and their language, which has no affinities with Persian, Pashtu or Baluchi, must be, according to the most eminent scholars, classed among the Dravidian tongues of southern India. Probably the Brahuis are of Dravidian stock, a branch long isolated from their kindred and much Arabized, and thus exhibiting a marked hybridism.

Whatever their origin, the Brahuis are found in a position of considerable power in Baluchistan from earliest times. Their authentic history begins with Mir Ahmad, who was their chief in the 17th century. The title of "khan" was assumed by Nasir the Great in the middle of the 18th century. The Brahuis are a confederacy of tribes possessing common lands and uniting from time to time for purposes of offence or defence. At their head is the khan, who formerly seems to have been regarded as semi-divine, it being customary for the tribesmen on visiting Kalat to make offerings at the Ahmadzai gate before entering. The Brahuis are a nomadic race, who dwell in tents made of goats' hair, black or striped, and live chiefly on the products of their herds. They are Sunnite Mahomedans, but are not fanatical. In physique they are very easily distinguished from their neighbours, the Baluchis and Pathans, being a smaller, sturdier people with rounder faces characterized by the flat, blunt and coarse features of the Dravidian races. They are of a dark brown colour, their hair and beards being often brown not black. They are an active, hardy race, and though as avaricious as the Pathans, are more trustworthy and less turbulent. Their ordinary dress is a tunic or shirt, trousers gathered in at the ankles and a cloak usually of brown felt. A few wear turbans, but generally their headgear is a round skullcap with tassel or button. Their women are not strictly veiled. Sandals of deer or goat skin are worn by all classes. Their weapons are rifles, swords and shields. They do not use the Afghan knife or any spears. Some few Brahuis are enlisted in the Bombay Native Infantry.

See Dr Bellew, *Indus to Euphrates* (London, 1874); Gustav Oppert, *The Original Inhabitants of India* (1893); Dr Theodore Duka, *Essay on the Brahui Grammar* (after the German of Dr Trumpp of Munich University).

BRAID (from the O. Eng. *bregdan*, to move quickly to and fro, hence to weave), a plait, especially a plait of hair, also a plaited tape woven of wool, silk, gold thread, &c., used for trimming or binding. A particular use is for the narrow bands, bordered with open work, used in making point lace.

BRAIDWOOD, THOMAS (1715-1806), British teacher of the deaf and dumb, was born in Scotland in 1715, and educated at Edinburgh University. He became a school teacher, and in 1760 opened in Edinburgh, with one pupil, the first school in Great Britain for the deaf and dumb, following the system of Dr John Wallis, described in *Philosophical Transactions* suffix in Baluchi, and *Men or Min* occurs on the lists of the Behistun inscriptions as the name of one of the Scythian tribes deported by Darius, the Achaemenian, for their turbulence (see *Kalat, A Memoir on the County and Family of the Ahmadzai Khans of Kalat*, by G. P. Tate). Sajdi, another Brahui tribal name, is Scythian; the principal clan of which tribe is the Saga, both names being identifiable with the Sagetae and Saki of ancient writers. Thus there seems some reason for believing that the former occupants of at least some portions of the Brahui domain were of Scythian blood.

nearly a hundred years before. This school was the model for all of the early English institutions of the kind. Dr Johnson visited it in 1773, and describes it as "a subject of philosophical curiosity . . . which no other city has to show," and Braidwood's dozen pupils as able "to hear with the eye." In 1783 Braidwood moved to Hackney, where he died on the 24th of October 1806.

BRAILA (in Rumanian *Braila*, formerly *IBRAILA*), the capital of the department of Braila, Rumania; situated amid flat and dreary country on the left bank of the river Danube, about 100 m. from its mouth at Sulina. Pop. (1900) 58,392, including 10,811 Jews. Southward, the Danube encircles a vast fen, tenanted only by waterfowl and herds of half-wild swine, while the plain which extends to the north-east and east only grows fertile at some distance inland. Braila itself is mainly built on a bank rising about 50 ft. above sea-level; but partly on a narrow strip of ground which separates this bank from the water's edge. Along the crest of the bank a public park is laid out, commanding a view of the desolate Dobrudja hills, across the river.

On the landward side, Braila has the shape of a crescent, the curve of its outer streets following the line of the old fortifications, dismantled in 1829. Few houses, among the older quarters, exceed two storeys in height, but the main streets are paved, and there is a regular supply of filtered water. A wide avenue, the *Strada Bulivarului*, divides the town proper from the suburbs. The principal church, among many, is the cathedral of St Michael, a large, ungainly building of grey sandstone. Electric tramways intersect the town, and are continued for 3 m. to Lacul Sărat (Salt Lake), where there are mineral springs and mud-baths, owned by the state. The waters, which contain over 45% of salt, iodine and sulphur, are among the strongest of their kind in Europe; and are of high repute, being annually visited by more than a thousand patients. Braila is the seat of a chamber of commerce. It is the chief port of entry for Walachia, and the headquarters of the grain trade; for, besides its advantageous position on the river, it is connected with the central Walachian railways by a line to Buzeu, and with the Russian and Moldavian systems by a line to Galatz. Quays, where ships drawing 15 ft. of water can discharge, line the river front; and there are large docks, grain elevators and warehouses, besides paper mills, roperies, and soap and candle works. Over 20 steamers, maintained by the state, ply between Braila and Rotterdam. Among the vessels of all nations, the British are first in numbers and tonnage, the Greek second. Grain and timber form the chief articles of export; textiles, machinery, iron goods and coal being most largely imported.

Many events connected with the history of Walachia took place in the neighbourhood of Braila. In 1475 Stephen the Great, having dethroned the voivode Radu, burned the town. In 1573 another Moldavian prince took the city by storm, and massacred the Turkish garrison. In 1659 it was again burned by the Walachian prince Mircea, and for the time the Turks were expelled, but afterwards returned. In the latter part of the 18th century Braila was several times captured by the Russians, and in 1770 it was burned. By the peace of Bucharest (1812) the Turks retained the right of garrisoning Braila. In 1828 it was gallantly defended by Soliman Pasha, who, after holding out from the middle of May until the end of June, was allowed to march out with the honours of war. At the peace of Adrianople (1829) the place was definitely assigned to Walachia; but before giving it up, the grand-duke Michael of Russia razed the citadel, and in this ruinous condition it was handed over to the Walachians. Braila was the spot chosen by the Russian general Gorchakov for crossing the Danube with his division in 1854. On the banks of the Danube, a little above the city, are some remains of the piles of a bridge said by a very doubtful tradition to have been built by Darius (c. 500 B.C.).

BRAIN (A.S. *brægen*), that part of the central nervous system which in vertebrate animals is contained within the cranium or skull; it is divided into the great brain or cerebrum, the hind brain or cerebellum, and the medulla oblongata, which is the transitional part between the spinal cord and the other

two parts already named. Except where stated, we deal here primarily with the brain in man.

I. ANATOMY

Membranes of the Human Brain.

Three membranes named the *dura mater*, *arachnoid* and *pia mater* cover the brain and lie between it and the cranial cavity. The most external of the three is the *dura mater*, which consists of a cranial and a spinal portion. The cranial part is in contact with the inner table

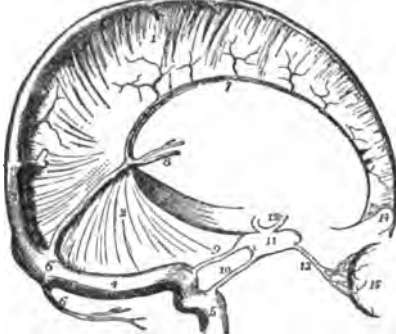

FIG. 1.—Dura Mater and Cranial Sinuses.

- 1. Falx cerebri.
- 2. Tentorium.
- 3,3. Superior longitudinal sinus.
- 4. Lateral sinus.
- 5. Internal jugular vein.
- 6. Occipital sinus.
- 6'. Torcular Herophili.
- 7. Inferior longitudinal sinus.
- 8. Veins of Galen.
- 9 and 10. Superior and inferior petrosal sinus.
- 11. Cavernous sinus.
- 12. Circular sinus which connects the two cavernous sinuses together.
- 13. Ophthalmic vein, from 15, the eyeball.
- 14. Crista galli of ethmoid bone.

of the skull, and is adherent along the lines of the sutures and to the margins of the foramina, which transmit the nerves, more especially to the foramen magnum. If forms, therefore, for these bones an internal periosteum, and the meningeal arteries which ramify in it are the nutrient arteries of the inner table. As the growth of bone is more active in infancy and youth than in the adult, the adhesion between the *dura mater* and the cranial bones is greater in early life than at maturity. From the inner surface of the *dura mater* strong bands pass into the cranial cavity, and form partitions between certain of the subdivisions of the brain. A vertical longitudinal mesial band, named, from its sickle shape, *falx cerebri*, dips between the two hemispheres of the cerebrum. A smaller sickle-shaped vertical mesial band, the *falx cerebelli*, attached to the internal occipital crest, passes between the two hemispheres of the cerebellum. A large band arches forward in the horizontal plane of the cavity, from the transverse groove in the occipital bone to the clinoid processes of the sphenoid, and is attached laterally to the upper border of the petrous part of each temporal bone. It separates the cerebrum from the cerebellum, and, as it forms a tent-like covering for the latter, is named *tentorium cerebelli*. Along certain lines the cranial *dura mater* splits into two layers to form tubular passages for the transmission of venous blood. These passages are named the *venous blood sinuses* of the *dura mater*, and they are lodged in the grooves on the inner surface of the skull referred to in the description of the cranial bones. Opening into these sinuses are numerous veins which convey from the brain the blood that has been circulating through it; and two of these sinuses, called *cavernous*, which lie at the sides of the body of the sphenoid bone, receive the ophthalmic veins from the eyeballs situated in the orbital cavities. These blood sinuses pass usually from before backwards: a *superior longitudinal* along the upper border of the falx cerebri as far as the internal occipital protuberance; an *inferior longitudinal* along its lower border as far as the tentorium, where it joins the *straight sinus*, which passes back as far as the same protuberance. One or two small *occipital sinuses*, which lie in the falx cerebelli, also pass to join the straight and longitudinal sinuses opposite this protuberance; several currents of blood meet, therefore, at this spot, and as Herophilus supposed that a sort of whirlpool was formed in the blood, the name *torcular Herophili* has been used to express the meeting of these sinuses. From the torcular the blood is drained away by two large sinuses, named *lateral*, which curve forward and downward to the jugular foramina to terminate in the internal jugular veins. In its course each lateral sinus receives two *petrosal sinuses*, which pass from the cavernous sinus backwards along the upper and lower borders of the petrous part of the temporal bone. The *dura mater*

consists of a tough, fibrous membrane, somewhat flocculent externally, but smooth, glistening, and free on its inner surface. The inner surface has the appearance of a serous membrane, and when examined microscopically is seen to consist of a layer of squamous endothelial cells. Hence the *dura mater* is sometimes called a fibro-serous membrane. The *dura mater* is well provided with lymph vessels, which in all probability open by stomata on the free inner surface. Between the *dura mater* and the subjacent *arachnoid* membrane is a fine space containing a minute quantity of limpid serum, which moistens the smooth inner surface of the *dura* and the corresponding smooth outer surface of the *arachnoid*. It is regarded as equivalent to the cavity of a serous membrane, and is named the *sub-dural space*.

Arachnoid Mater.—The *arachnoid* is a membrane of great delicacy and transparency, which loosely envelops both the brain and spinal cord. It is separated from these organs by the *pia mater*; but between it and the latter membrane is a distinct space, called *sub-arachnoid*. The sub-arachnoid space is more distinctly marked beneath the spinal than beneath the cerebral parts of the membrane, which forms a looser investment for the cord than for the brain. At the base of the brain, and opposite the fissures between the convolutions of the cerebrum, the interval between the *arachnoid* and the *pia mater* can, however, always be seen, for the *arachnoid* does not, like the *pia mater*, clothe the sides of the fissures, but passes directly across between the summits of adjacent convolutions. The sub-arachnoid space is subdivided into numerous freely-communicating loculi by bundles of delicate areolar tissue, which bundles are invested, as Key and Retzius have shown, by a layer of squamous endothelium. The space contains a limpid cerebro-spinal fluid, which varies in quantity from 2 drachms to 2 oz., and is most plentiful in the dilatations at the base of the brain known as *cisternae*. It should be clearly understood that there is no communication between the subdural and sub-arachnoid spaces, but that the latter communicates with the ventricles through openings in the roof of the fourth, and in the descending cornua of the lateral ventricles.

When the skull cap is removed, clusters of granular bodies are usually to be seen imbedded in the *dura mater* on each side of the superior longitudinal sinus; these are named the *Pachionian bodies*. When traced through the *dura mater* they are found to spring from the *arachnoid*. The observations of Luschka and Cleland have proved that villous processes invariably grow from the free surface of that membrane, and that when these villi greatly increase in size they form the bodies in question. Sometimes the *Pachionian* bodies greatly hypertrophy, occasioning absorption of the bones of the cranial vault and depressions on the upper surface of the brain.

Pia Mater.—This membrane closely invests the whole outer surface of the brain. It dips into the fissures between the convolutions, and

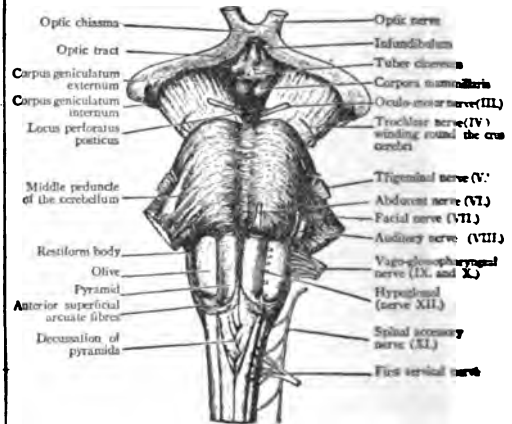

After D. J. Cunningham's *Text-book of Anatomy*.

FIG. 2.—Front View of the Medulla, Pons and Mesencephalon of a full-time Human Foetus.

a wide prolongation, named *velum interpositum*, lies in the interior of the cerebrum. With a little care it can be stripped off the brain without causing injury to its substance. At the base of the brain the *pia mater* is prolonged on to the roots of the cranial nerves. This membrane consists of a delicate connective tissue, in which the arteries of the brain and spinal cord ramify and subdivide into small branches before they penetrate the nervous substance, and in which the veins conveying the blood from the nerve centres lie before they open into the blood sinuses of the cranial *dura mater* and the extradural venous plexus of the spinal canal.

Medulla Oblongata.

The *Medulla Oblongata* rests upon the basi-occipital. It is somewhat pyramidal in form, about 1½ in. long, and 1 in. broad part. It is a bilateral organ, and is divided into a right and a left half by shallow anterior and posterior median fissures, continuous with the corresponding fissures in the spinal cord; the posterior fissure ends above in the fourth ventricle. Each half is subdivided into elongated tracts of nervous matter. Next to, and parallel with the anterior fissure is the *anterior pyramid* (see fig. 2). This pyramid is continuous below with the cord, and the place of continuity is marked by the passage across the fissure of three or four bundles of nerve fibres, from each half of the cord to the opposite anterior pyramid; this crossing is called the *decussation of the pyramids*. To the side of the pyramid, and separated from it by a faint fissure, is the *olivary fasciculus*, which at its upper end is elevated into the projecting oval-shaped *olivary body*. Behind the olivary body in the lower half of the medulla are three tracts named from before backward the *funiculus of Rolando*, the *funiculus cuneatus* and the *funiculus gracilis* (see fig. 3). The two *funiculi graciles* of opposite sides are in contact in the mid dorsal line and have between them the *postero median* fissure. When the fourth ventricle is reached they diverge to form the lower limit of that diamond-shaped space and are slightly swollen to form the *clavae*. All these three bundles appear to be continued up into the cerebellum as the restiform bodies or inferior cerebellar peduncles, but really the continuity is very slight, as the restiform bodies are formed from the direct cerebellar tracts of the spinal cord joining with the superficial arcuate fibres which curve back just below the olivary bodies. The upper part of the fourth ventricle is bounded by the superior cerebellar peduncles which meet just before the inferior quadrigeminal bodies are reached. Stretching across between them is the superior medullary velum or valve of Vieussens, forming the upper part of the roof, while the inferior velum forms the lower part, and has an opening called the *foramen of Majendie*, through which the sub-arachnoid space communicates with the ventricle. The floor (see fig. 3) has two triangular depressions on each side of a median furrow; these are the superior and inferior *fossae*, the significance of which will be noticed in the development of the rhombencephalon. Running horizontally across the middle of the floor are the *striæ acusticæ* which are continued into the auditory nerve. The floor of the fourth ventricle is of special

most anterior is the pyramid or motor tract, the decussation of which has been seen. Behind this is the mesial fillet or sensory tract, which has also decussated a little below the point of section, while farther back still is the posterior longitudinal bundle which is coming

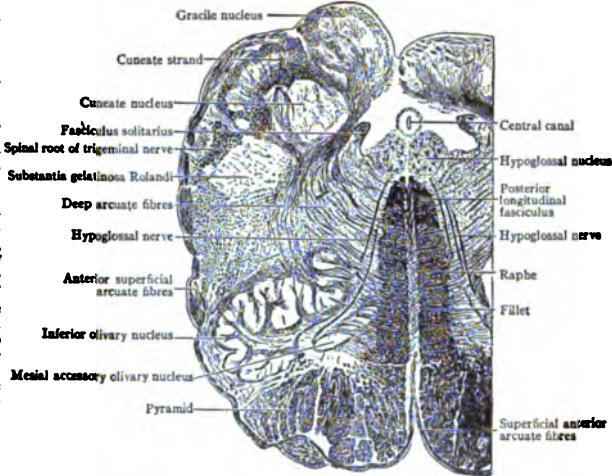

From Cunningham, *Text-book of Anatomy*.

FIG. 4.—Transverse Section through the Human Medulla in the Lower Olivary Region.

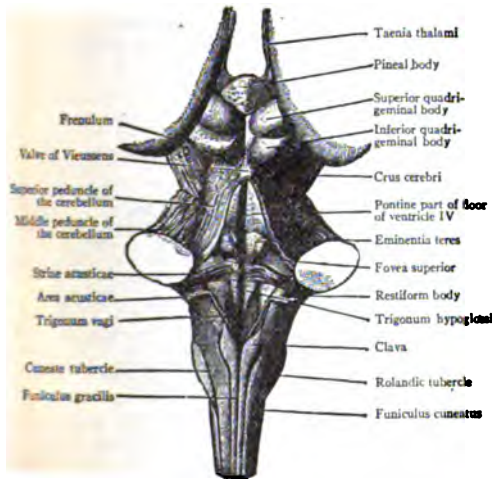

From Cunningham, *Text-book of Anatomy*.

FIG. 3.—Back View of the Medulla, Pons and Mesencephalon of a full-time Human Foetus.

interest because a little way from the surface are the deep origins of all the cranial nerves from the fifth to the twelfth. (See NERVE: cranial). If a section is made transversely through the medulla about the apex of the fourth ventricle three important bundles of fibres are cut close to the mid line on each side (see fig. 4). The

up from the anterior basis bundle of the cord. External to and behind the pyramid is the crenated section of the olivary nucleus, the surface bulging of which forms the olivary body.

The grey matter of the medulla oblongata, which contains numerous multipolar nerve cells, is in part continuous with the grey matter of the spinal cord, and in part consists of independent masses. As the grey matter of the cord enters the medulla it loses its crescentic arrangement. The posterior cornua are thrown outwards towards the surface, lose their pointed form, and dilate into rounded masses named the *grey tubercles of Rolando*. The grey matter of the anterior cornua is cut off from the rest by the decussating pyramids and finally disappears. The *formatio reticularis* which is feebly developed in the cord becomes well developed in the medulla. In the lower part of the medulla a central canal continuous with that of the cord exists, but when the clavae on the opposite sides of the medulla diverge from each other, the central canal loses its posterior boundary, and dilates into the cavity of the fourth ventricle. The grey matter in the interior of the medulla appears, therefore, on the floor of the ventricle and is continuous with the grey matter near the central canal of the cord. This grey matter forms collections of nerve cells, which are the centres of origin of several cranial nerves. Crossing the anterior surface of the medulla oblongata, immediately below the pons, in the majority of mammals is a transverse arrangement of fibres forming the *trapezium*, which contains a grey nucleus, named by van der Kolk the *superior olive*. In the human brain the trapezium is concealed by the lower transverse fibres of the pons, but when sections are made through it, as L. Clarke pointed out, the grey matter of the superior olive can be seen. These fibres of the *trapezium* come from the cochlear nucleus of the auditory nerve, and run up as the lateral fillet.

The *Pons Varolii* or *BRIDGE* is cuboidal in form (see fig. 2): its anterior surface rests upon the dorsum sellæ of the sphenoid, and is marked by a median longitudinal groove; its inferior surface receives the pyramidal and olivary tracts of the medulla oblongata; at its superior surface are the two *crura cerebri*; each lateral surface is in relation to a hemisphere of the cerebellum, and a peduncle passes from the pons into the interior of each hemisphere; the posterior surface forms in part the upper portion of the floor of the fourth ventricle, and in part is in contact with the corpora quadrigemina.

The pons consists of white and grey matter: the nerve fibres of the white matter pass through the substance of the pons, in either a transverse or a longitudinal direction. The transverse fibres go from one hemisphere of the cerebellum to that of the opposite side; some are situated on the anterior surface of the pons, and form its superficial transverse fibres, whilst others pass through its substance and form the deep transverse fibres. The longitudinal fibres ascend from the medulla oblongata and leave the pons by emerging from its upper surface as fibres of the two *crura cerebri*. The pons possesses a median raphe continuous with that of the medulla oblongata, and formed like it by a decussation of fibres in the mesial plane.

In a horizontal section through the pons and upper part of the fourth ventricle the superficial transverse fibres are seen most anteriorly; then come the anterior pyramidal fibres, then the deep transverse

lobes, of which the most important are the *amygdala* or *tonsil*, which forms the lateral boundary of the anterior part of the vallicula, and the *flocculus*, which is situated immediately behind the middle peduncle of the cerebellum. The inferior vermiciform process is subdivided into a posterior part or *pyramid*; an elevation or *uvula*, situated between the two tonsils; and an anterior pointed process or *sodula*. Stretching between the two flocculi, and attached midway to the sides of the nodule, is a thin, white, semilunar-shaped plate of nervous matter, called the *inferior medullary velum*.

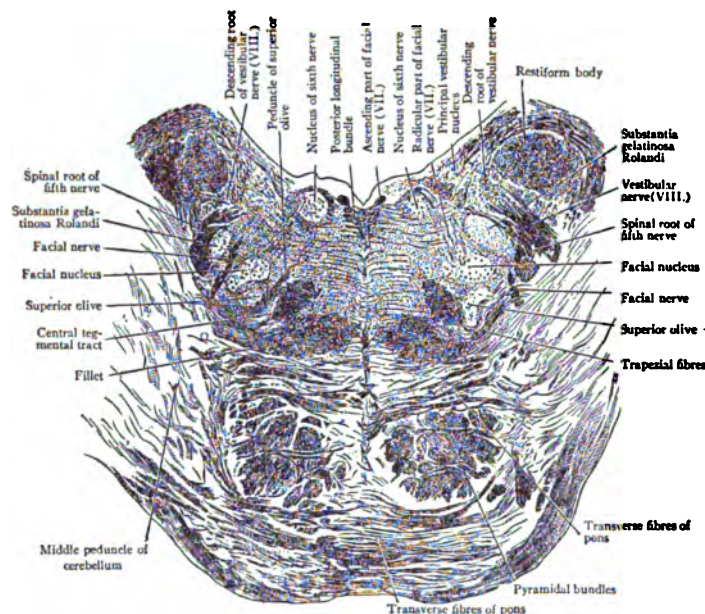

From Cunningham, *Text-book of Anatomy*.

FIG. 5.—Section through the Lower Part of the Human Pons Varolii immediately above the Medulla.

pontine fibres, then the fillet, while most posteriorly and close to the floor of the fourth ventricle the posterior longitudinal bundle is seen (see fig. 5).

The grey matter of the pons is scattered irregularly through its substance, and appears on its posterior surface; but not on the anterior surface, composed exclusively of the superficial transverse fibres.

The Cerebellum.

The *Cerebellum*, **LITTLE BRAIN**, or **AFTER BRAIN** occupies the inferior pair of occipital fossae, and lies below the plane of the tentorium cerebelli. It consists of two hemispheres or lateral lobes, and of a median or central lobe, which in human anatomy is called the vermis. It is connected below with the medulla oblongata by the two restiform bodies which form its *inferior peduncles*, and above with the corpora quadrigemina of the cerebrum by two bands, which form its *superior peduncles*; whilst the two hemispheres are connected together by the transverse fibres of the pons, which form the *middle peduncles* of the cerebellum. On the superior or tentorial surface of the cerebellum the median or vermiciform lobe is a mere elevation, but on its inferior or occipital surface this lobe forms a well-defined process, which lies at the bottom of a deep fossa or *vallecula*; this fossa is prolonged to the posterior border of the cerebellum, and forms there a deep notch which separates the two hemispheres from each other; in this notch the falx cerebelli is lodged. Extending horizontally backwards from the middle cerebellar peduncle, along the outer border of each hemisphere is the *great horizontal fissure*, which divides the hemisphere into its tentorial and occipital surfaces. Each of these surfaces is again subdivided by fissures into smaller

is for the most part directly continuous with the fibres of the peduncles of the cerebellum. Thus the restiform or inferior peduncles pass from below upward through the white core, to end in the grey matter of the tentorial surface of the cerebellum, more especially in that of the central lobe; on their way they are connected with the

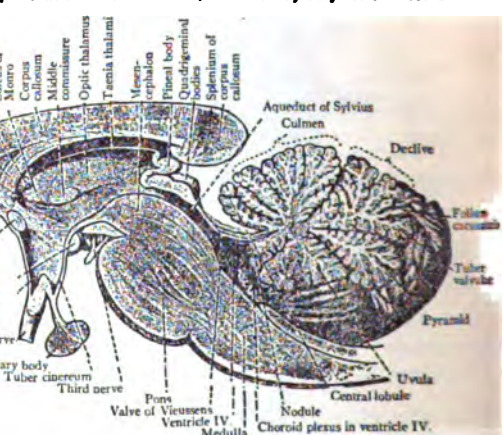

From Cunningham, *Text-book of Anatomy*.

FIG. 6.—Mesial Section through the Corpus Callosum, the Mesencephalon, the Pons, Medulla and Cerebellum. Showing the third and fourth ventricles joined by the aqueduct of Sylvius.

grey matter of the corpus dentatum. The superior peduncles, which descend from the corpora quadrigemina of the cerebrum form connexions mainly with the corpus dentatum. The middle peduncles form a large proportion of the white core, and their fibres terminate

in the grey matter of the foliated cortex of the hemispheres. It has been noticed that those fibres which are lowest in the pons go to the upper surface of the cerebellum and vice versa.

Histology of the Cerebellum.—The white centre of the cerebellum is composed of numbers of medullated nerve fibres coursing to and from the grey matter of the cortex. These fibres are supported in a groundwork of neuroglial tissue, their nutrition being supplied by a small number of blood vessels.

The cortex (see fig. 7) consists of a thin layer of grey material forming an outer coat of somewhat varying thickness over the whole external surface of the laminae of the organ. When examined microscopically it is found to be made up of two layers, an outer "molecular" and an inner "granular" layer. Forming a layer lying at the junction of these two are a number of cells, the *cells of Purkinje*, which constitute the most characteristic feature of the cerebellum. The bodies of these cells are pear-shaped. Their inner rods taper and finally end in a nerve fibre which may be traced into the white centre. In their course through the granule layer they give off a number of branching collaterals, some turning back and passing between the cells of Purkinje into the molecular layer. Their inner ends terminate in one or sometimes two stout processes which repeatedly branch dichotomously, thus forming a very elaborate dendron in the molecular layer. The branchings of this dendron



From Cunningham, *Text-book of Anatomy*.

FIG. 7.—Transverse Section through a Cerebellar Folium (after Kölliker). Treated by the Golgi method.

- | | |
|--|--|
| P. Axon of cell of Purkinje. | GR'. Axons of granule cells in molecular layer cut transversely. |
| F. Moss fibres. | M'. Basket-cells. |
| K and K'. Fibres from white core of folium ending in molecular layer in connexion with the dendrites of the cells of Purkinje. | ZK. Basket-work around the cells of Purkinje. |
| M. Small cell of the molecular layer. | G.L. Neuroglial cell. |
| GR. Granule cell. | M. Axon of an association cell. |

are also highly characteristic in that they are approximately restricted to a single plane like an espalier fruit tree, and those for neighbouring cells are all parallel to one another and at right angles to the general direction of the folium to which they belong. In the molecular layer are found two types of cells. The most abundant are the so-called *basket cells* which are distributed through the whole thickness of the layer. They have a rounded body giving off many branching dendrons to their immediate neighbourhood and one long neuraxon which runs parallel to the surface and to the long axis of the lamina. In its course, this gives off numerous collaterals which run downward to the bodies of Purkinje's cells. Their terminal branchings together with similar terminals of other collaterals form the basket-work around the bodies of these cells.

The granular layer is sometimes termed the rust-coloured layer from its appearance to the naked eye. It contains two types of nerve cells, the small granule cells and the large granule cells. The former are the more numerous. They give off a number of short dendrites with claw-like endings, and a fine non-medullated neuraxon process. This runs upward to the cortex, where it divides into two branches in the form of a Y. The branches run for some distance parallel to the axis of the folium and terminate in unbranched ends.

The large granule cells are multipolar cells, many of the branchings penetrating well into the molecular layer. The neuraxon process turns into the opposite direction and forms a richly branching system through the entire thickness of the granular layer. There is also an abundant plexus of fine medullated fibres within the granule layer.

The fibres of the white central matter are partly centrifugal, the neuraxons of the cells of Purkinje, and partly centripetal. The position of the cells of these latter fibres is not known. The fibres give rise to an abundant plexus of fibrils in the granular layer, and many reaching into the molecular layer ramify there, especially in the immediate neighbourhood of the dendrites of Purkinje's cells. From the appearance of their plexus of fibrils these are sometimes called *moss fibres*.

The *Fourth Ventricle* is the dilated upper end of the central canal of the medulla oblongata. Its shape is like an heraldic lozenge. Its floor is formed by the grey matter of the posterior surfaces of the medulla oblongata and pons, already described (see figs. 3 and 6); its roof partly by the inferior vermis of the cerebellum, the *nodule* of which projects into its cavity, and partly by a thin layer, called *saïne of Vieussens*, or superior *medullary velum*; its lower lateral boundaries by the divergent clavae and restiform bodies; its upper lateral boundaries by the superior peduncles of the cerebellum. The *inferior medullary velum*, a reflection of the pia mater and epithelium from the back of the medulla to the inferior vermis, closes it in below. Above, it communicates with the *aqueduct of Sylvius*, which is tunnelled below the substance of the corpora quadrigemina. Along the centre of the floor is the median furrow, which terminates below in a pen-shaped form, the so-called *calamus scriptorius*. Situated on its floor are the fasciculi *teretes*, *striae acusticae*, and deposits of grey matter described in connexion with the medulla oblongata. Its epithelial lining is continuous with that of the central canal.

The Cerebrum.

The *Cerebrum* or *GREAT BRAIN* lies above the plane of the tentorium, and forms much the largest division of the encephalon. It is customary in human anatomy to include under the name of cerebrum, not only the convolutions, the corpora striata, and the optic thalami, developed in the anterior cerebral vesicle, but also the corpora quadrigemina and crura cerebri developed in the mesencephalon or middle cerebral vesicle. The cerebrum is ovoid in shape, and presents superiorly, anteriorly and posteriorly a deep *median longitudinal fissure*, which subdivides it into two hemispheres. Inferiorly there is a continuity of structure between the two hemispheres across the mesial plane, and if the two hemispheres be drawn asunder by opening out the longitudinal fissure, a broad white band, the *corpus callosum*, may be seen at the bottom of the fissure passing across the mesial plane from one hemisphere to the other. The outer surface of each hemisphere is convex, and adapted in shape to the concavity of the inner table of the cranial bones; its inner surface, which bounds the longitudinal fissure, is flat and is separated from the opposite hemisphere by the *fals cerebri*; its under surface, where it rests on the tentorium, is concave, and is separated by that membrane from the cerebellum and pons. From the front of the pons two strong white bands, the *crura cerebri*, or *cerebral peduncles*, pass forward and upward (see fig. 2). Winding round the outer side of each crus is a flat white band, the *optic tract*. These tracts converge in front, and join to form the *optic commissure*, from which the two *optic nerves* arise. The crura cerebri, optic tracts, and optic commissure enclose a lozenge-shaped space, which includes—(a) a grey layer, which, from being perforated by several small arteries, is called *locus perforatus posticus*; (b) two white mammillae, the *corpora albicansia*; (c) a grey nodule, the *tuber cinereum*, from which (d) the *infundibulum* projects to join the *pituitary body*. Immediately in front of the optic commissure is a grey layer, the *lamina cinerea* of the third ventricle; and between the optic commissure and the inner end of each Sylvian fissure is a grey spot perforated by small arteries, the *locus perforatus anticus*.

If a transverse section is made at right angles to the surface of the crura cerebri it will pass right through the mesencephalon and come out on the dorsal side through the corpora quadrigemina (see fig. 8). The ventral part of each crus forms the *crusta*, which is the continuation forward of the anterior pyramidal fibres of the medulla and pons, and is the great motor path from the brain to the cord. Dorsal to this is a layer of pigmented grey matter, called the *substantia nigra*, and dorsal to this again is the tegmentum, which is a continuation upward of the formatio reticularis of the medulla, and passing through it are seen three important nerve bundles. The superior cerebellar peduncle is the most internal of these and decussates with its fellow of the opposite side so that the two tegmenta are continuous across the middle line. More externally the mesial fillet is seen, while dorsal to the cerebellar peduncle is the posterior longitudinal bundle. If the section happens to pass through the superior corpus quadrigeminum a characteristic circular area appears between the cerebellar peduncle and the fillet, which, from its tint, is called the red nucleus. More dorsally still the section will pass through the Sylvian aqueduct or passage from the third to the fourth ventricle, and this is surrounded by a mass of grey matter in the ventral part of which are the nuclei of the third and fourth

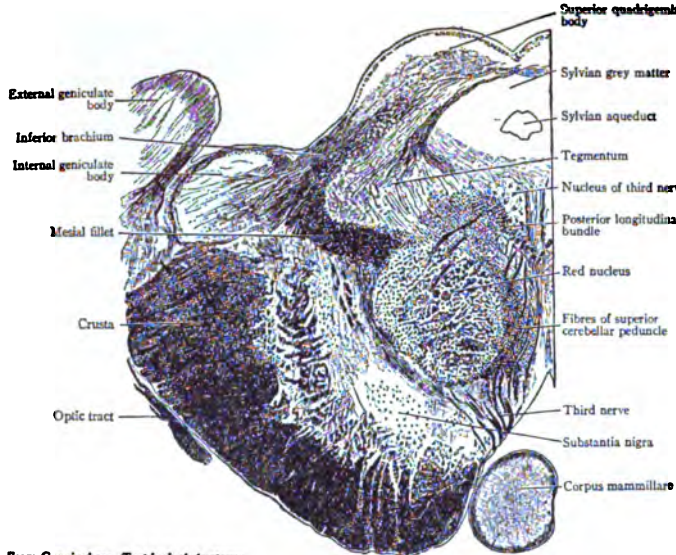

From Cunningham, *Text-book of Anatomy*.
 FIG. 8.—Transverse Section through the Human Mesencephalon at the level of the superior Quadrigeminal Body.

nerves. The third nerve is seen at the level of the superior corpus quadrigeminum running from its nucleus of origin, through the red nucleus, to a groove on the inner side of the crus called the *oculo-motor groove*, which marks the separation between the crista and tegmentum. Dorsal to the Sylvian aqueduct is a layer called the *lamina quadrigemina* and on this the corpora quadrigemina rest. The superior pair of these bodies is overlapped by the pineal body and forms part of the lower visual centres. Connexions can be traced to the optic tract, the higher visual centre on the mesial surface of the occipital lobe, the deep origin of the third or oculo-motor nerve as well as to the mesial and lateral fillet. The inferior pair of quadrigeminal bodies are more closely in touch with the organs of hearing, and are connected by the lateral fillet with the cochlear nucleus of the auditory nerve.

Surface of the Brain.

The peripheral part of each hemisphere, which consists of grey matter, exhibits a characteristic folded appearance, known as gyri (or convolutions) of the cerebrum. These gyri are separated from each other by *fissures* and *sulci*, some of which are considered to subdivide the hemisphere into lobes, whilst others separate the gyri in each lobe from each other. In each hemisphere of the human brain five lobes are recognized: the temporo-sphenoidal, frontal, parietal, occipital, and the central lobe or Island of Reil; it should, however, be realized that these lobes do not exactly correspond to the outlines of the bones after which they are named. Passing obliquely on the outer face of the hemisphere from before, upward and backward, is the well marked *Sylvian fissure* (fig. 9, *s*), which is the first to appear in the development of the hemisphere. Below it lies the temporo-sphenoidal lobe, and above and in front of it, the parietal and frontal lobes. As soon as it appears on the external surface of the brain the fissure divides into three limbs, anterior horizontal (*s*¹), ascending (*s*²), and posterior horizontal (*s*³), the latter being by far the longest. The place whence these diverge is the Sylvian point and corresponds to the pterion on the surface of the skull (see ANATOMY: *Superficial and Artistic*). Between these three limbs and the vallicula or main stem of the fissure are four triangular tongues or opercula; these are named, according to their position, orbital (fig. 9, C), frontal (pars triangularis) (B), fronto-parietal (pars

basilaris) (A) and temporal. The frontal lobe is separated from the parietal by the *fissure of Rolando* (fig. 9, *r*) which extends on the outer face of the hemisphere from the longitudinal fissure obliquely downward and forward towards the Sylvian fissure. About 2 in. from the hinder end of the hemisphere is the *parieto-occipital fissure*, which, commencing at the longitudinal fissure, passes down the inner surface of the hemisphere, and transversely outwards for a short distance on the outer surface of the hemisphere; it separates the parietal and occipital lobes from each other.

The *Temporo-Sphenoidal Lobe* presents on the outer surface of the hemisphere three convolutions, arranged in parallel tiers from above downward, and named *superior, middle and inferior temporal gyri*. The fissure which separates the superior and middle of these convolutions is called the *parallel fissure* (fig. 9, *f*). The *Occipital Lobe* also consists from above downwards of three parallel gyri, named *superior, middle and inferior occipital*. The *Frontal Lobe* is more complex; immediately in front of the fissure of Rolando, and forming indeed its anterior boundary, is a convolution named *ascending frontal* or pre-central, which ascends obliquely backward and upward from the Sylvian to the longitudinal fissure. Springing from the front of this gyrus, and passing forward to the anterior end of the cerebrum, are three gyri, arranged in parallel tiers from above downwards, and named *superior, middle and inferior frontal gyri*, which are also prolonged on to the orbital face of the frontal lobe. The *Parietal Lobe* is also complex; its most anterior gyrus, named *ascending parietal* or post-central, ascends parallel to and immediately behind the fissure of Rolando. Springing from the upper end of the back of this gyrus is the *supra-parietal lobe*, which, forming the boundary of the longitudinal fissure, extends as far back as the parieto-occipital fissure; springing from the lower end of the back of this gyrus is the *supra-marginal*, which forms the

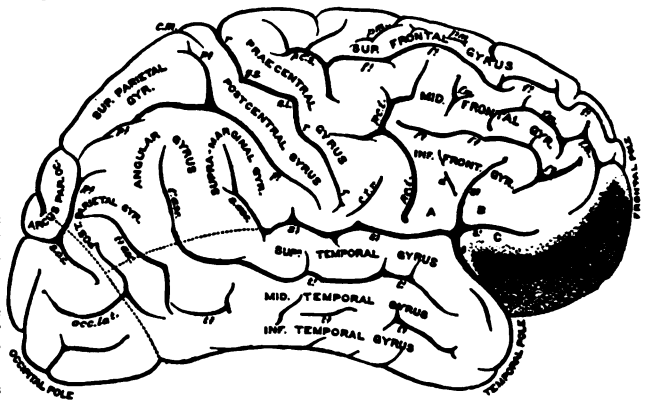

From Cunningham, *Text-book of Anatomy*.
 FIG. 9.—Gyri and Sulci, on the outer surface of the Cerebral Hemisphere.

- s*, Sulcus frontalis superior.
- s*¹, Sulcus frontalis inferior.
- f.m.*, Sulcus frontalis medius.
- p.m.*, Sulcus paramedialis.
- A, Pars basilaris.
- B, Pars triangularis.
- C, Pars orbitalis.
- S, Sylvian fissure.
- s*¹, Anterior horizontal limb (Sylvian fissure).
- s*², Ascending limb (Sylvian fissure).
- s*³, Posterior horizontal limb (Sylvian fissure).
- s.asc.*, Ascending terminal part of the posterior horizontal limb of the Sylvian fissure.
- p.c.t.*, Inferior precentral sulcus.
- p.c.s.*, Superior precentral sulcus.
- r.*, Fissure of Rolando.
- g.s.*, Superior genu.
- g.i.*, Inferior genu.
- d.*, Sulcus diagonalis.
- st.*, Superior temporal sulcus (parallel sulcus).
- it.*, Inferior temporal sulcus (sulcus).
- pt.*, Inferior postcentral sulcus.
- ps.*, Superior postcentral sulcus.
- ph.*, Ramus horizontalis.
- po.*, Ramus occipitalis.
- s.o.t.*, Sulcus occipitalis transversus.
- occ. lat.*, Sulcus occipitalis lateralis (the sulcus lunatus of Elliot Smith).
- c.m.*, Calloso-marginal sulcus.
- c.t.r.*, Inferior transverse furrow.

upper boundary of the hinder part of the Sylvian fissure; as this gyrus occupies the hollow in the parietal bone, which corresponds to the eminence, it may appropriately be named the *gyrus of the parietal eminence*. Above and behind

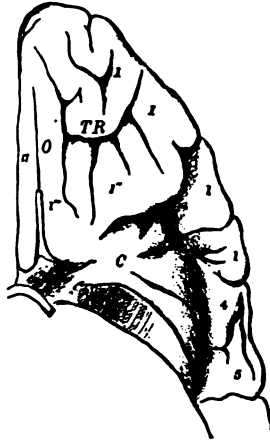

FIG. 10.—Orbital surface of the left frontal lobe and the island of Reil; the tip of the tempo-sphenoidal lobe has been removed to display the latter.

- 17. Convolution of the margin of the longitudinal fissure.
- O. Olfactory fissure, over which the olfactory peduncle and lobe are situated.
- TR. Orbital sulcus. [surface, 1" 1".] Convolutions on the orbital
- 1, 1, 1. Under surface of infero-frontal convolution.
- 4. Under surface of ascending frontal; and 5, of ascending parietal convolutions.
- C. Central lobe or insula.

antero-posterior sulcus (*s. rectus*), beneath which lies the olfactory lobe, bulbous in front, for the olfactory nerves to arise from.

On the mesial surface of the hemisphere, as seen when the brain is longitudinally bisected and the cerebellum and medulla removed by the cutting through the crus cerebri (see fig. 11), the divided corpus callosum is the most central object, while below it are seen the fornix, septum lucidum and third ventricle, the description of which will follow. The cerebral surface, above and in front of the corpus callosum, is divided into two by a sulcus, the contour of which closely resembles that of the upper margin of the corpus callosum. This is the *calloso-marginal sulcus*, so called because it separates the callosal gyrus, which lies between it and the corpus callosum, from the marginal gyri nearer the margin of the brain. When the sulcus reaches a point vertically above the hind end of the corpus callosum it turns sharply upward and so forms the hinder limit of the marginal gyri, the posterior inch or two of which is more or less distinctly marked off to form the *paracentral lobule*, where the upper part of the central fissure of Rolando turns over the margin of the brain. The callosal gyrus, which is also called the *gyrus fornicatus* from its arched appearance, is continued backward round the posterior end of the corpus callosum, and so to the mesial surface of the calloso-marginal sulcus there is a square area which is called the *precuneus* or *quadrate lobe*; it is bounded behind by the deeply cut internal parieto-occipital fissure and this runs from the margin of the brain downward and forward to join another fissure, the calcarine; at an acute angle, thus enclosing a wedge-shaped piece of brain called the *cuneus* between them. The calcarine fissure is fairly horizontal, and is joined about its middle by the internal parieto-occipital, so that the

part in front of the junction is called the *pre-calcarine*, and that behind the *post-calcarine* fissure. The internal parieto-occipital and calcarine are real fissures, because they cause an elevation in the interior of the brain, known as the hippocampus minor. Just in front of the anterior end of the calcarine fissure the callosal gyrus is constricted to form the isthmus which connects it with the hippocampal or uncinatè gyrus. Below the calcarine fissure is a gyrus called the *gyrus lingualis*, and this is bounded below by another true fissure, the *collateral*, which runs parallel to the calcarine, but is continued much farther forward into the temporal lobe and so forms the lower boundary of the hippocampal gyrus. It will thus be seen that the hippocampal gyrus is continuous posteriorly with the callosal gyrus above by means of the isthmus, and with the *gyrus lingualis* below. The hippocampal gyrus is bounded above by the dentate or hippocampal fissure which causes the hippocampus major in the descending cornu and so is a complete fissure. If its lips are separated the fascia dentata or *gyrus dentatus* and the fimbria continued from the posterior pillar of the fornix are seen. Anteriorly the fissure is arrested by the recurved process of the upper part of the hippocampal gyrus, called the *uncus*, and in front of this a slight sulcus, the *incisura temporalis*, marks off the temporal pole or tip of the temporal lobe from the region of the uncus. It will be seen that the callosal gyrus, isthmus, and hippocampal gyrus form nearly a complete ring, and to this the name of *limbic lobe* is given.

Interior of the Cerebrum.

If a horizontal slice be removed from the upper part of each hemisphere (see fig. 12), the peripheral grey matter of the gyri will be seen to follow their various windings, whilst the core of each gyrus consists of white matter continuous with a mass of white matter in the interior of the hemisphere. If a deeper slice be now made down to the plane of the corpus callosum, the white matter of that structure will be seen to be continuous with the white centre of each hemisphere known as the *centrum ovale*. The *corpus callosum* does not equal the hemispheres in length, but approaches nearer to their anterior than their posterior ends. It terminates behind in a free rounded end, named the *splenium* (see fig. 11), whilst in front it forms a knee-shaped bend, and passes downwards and backwards as far as the lamina cinerea. If the dissection be performed on a brain which has been hardened in spirit, the corpus callosum is seen to consist almost entirely of bundles of nerve fibres, passing transversely across the mesial plane between the two hemispheres; these fibres may be traced into the white cores and grey matter of the gyri, and connect the gyri, though by no means always corresponding ones, in the opposite hemispheres. Hence the corpus callosum is a connecting or commissural structure, which brings the gyri of the two hemispheres into anatomical and physiological relation with each other. On the surface of the corpus callosum a few fibres, the *striae longitudinales*, run in the antero-posterior or longitudinal direction (see fig. 12, b). Their morphological interest is referred to in the section below on *Comparative Anatomy*. In the sulcus between the corpus callosum and the limbic lobe a narrow band of fibres called the *cingulum* is seen, most of its fibres only run a short distance in it and link together adjacent parts of the brain. If the corpus callosum be now cut through on each side of its mesial line, the large cavity or *lateral ventricle* in each hemisphere will be opened into.

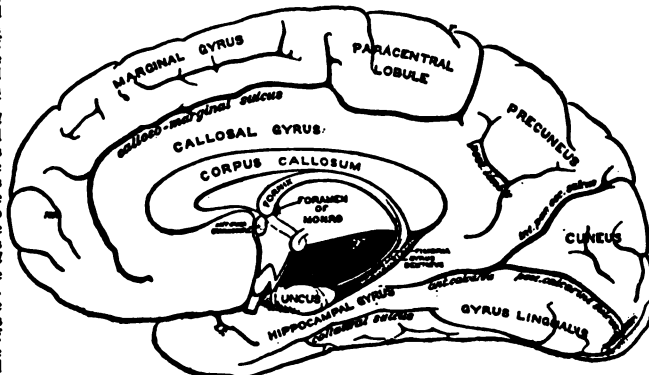

From Cunningham, *Text-book of Anatomy*.

FIG. 11.—The Gyri and Sulci on the Mesial Aspect of the Cerebral Hemisphere. r, Fissure of Rolando. r, ρ, Rostral sulcus. i, f, Incisura temporalis.

The lateral ventricle is subdivided into a *central space* or *body*, and three bent prolongations or *cornua*; the *anterior cornu* extends forward, outward and downward into the frontal lobe; the *posterior cornu* curves backward, outward and inward into the occipital lobe;

the descending cornu curves backward, outward, downward, forward and inward, behind and below the optic thalamus into the temporo-sphenoidal lobe. On the floor of the central space may be seen from before backward the grey upper surface of the pear-shaped caudate nucleus of the *corpus striatum* (figs. 12 and 13, *f*), and to its inner and posterior part a small portion of the *optic thalamus*, whilst between the two is the curved flat band, the *taenia semicircularis* (figs. 12 and 13, *g*). Resting on the upper surface of the thalamus

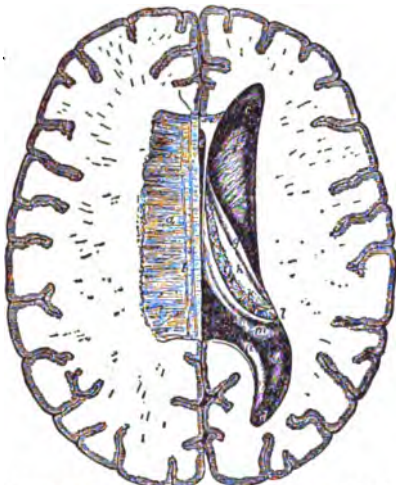

FIG. 12.—To show the Right Ventricle and the left half of the Corpus Callosum.

- | | |
|--|----------------------------|
| a, Transverse fibres, and | g, Taenia semicircularis. |
| b, Longitudinal fibres of corpus callosum. | h, Optic thalamus. |
| c, Anterior, and [ventricle. | i, Taenia hippocampi. |
| d, Posterior cornua of lateral | m, Hippocampus major. |
| e, Septum lucidum. | n, Hippocampus minor. |
| f, Corpus striatum. | o, Eminentia collateralis. |

is the vascular fringe of the velum interpositum, named *choroid plexus*, and immediately internal to this fringe is the free edge of the white *posterior pillar of the fornix*. The anterior cornu has the anterior end of the corpus striatum projecting into it. The posterior cornu has an elevation on its floor, the *hippocampus minor* (fig. 12, *n*), and between this cornu and the descending cornu is the elevation called *eminentia collateralis*, formed by the collateral fissure (fig. 12, *o*).

Extending down the descending cornu and following its curvature is the *hippocampus major*, which terminates below in a nodular end, the *pes hippocampi*; on its inner border is the white *taenia hippocampi*, continuous above with the posterior pillar of the fornix. If the taenia be drawn to one side the hippocampal fissure is exposed, at the bottom of which the grey matter of the gyrus hippocampi may be seen to form a well-defined dentated border (the so-called *fascia dentata*). The choroid plexus of the pia mater turns round the gyrus hippocampi, and enters the descending cornu through the lateral part of the great transverse fissure between the taenia hippocampi and optic thalamus. The lateral ventricle is lined by a ciliated epithelium called the *ependyma*. This lining is continuous through the foramen of Monro with that of the third ventricle, which again is continuous with the lining of the fourth ventricle through the aqueduct of Sylvius. A little fluid is contained in the cerebral ventricles, which, under some pathological conditions, may increase greatly in quantity, so as to occasion considerable dilatation of the ventricular cavities.

If the corpus callosum be now divided about its middle by a transverse incision, and the posterior half of this structure be turned back (see fig. 13), the body of the fornix on which the corpus callosum rests is exposed. If the anterior half of the corpus callosum be now turned forward, the grey partition, or *septum lucidum*, between the two lateral ventricles is exposed. This septum fits into the interval between the under surface of the corpus callosum and the upper surface of the anterior part of the fornix. It consists of two layers of grey matter, between which is a narrow vertical mesial space, the *fifth ventricle* (fig. 13, *e*), and this space does not communicate with the other ventricles nor is it lined with ependyma. If the septum be now removed, the anterior part of the fornix is brought into view.

The *fornix* is an arch-shaped band of nerve fibres extending in the

antero-posterior direction. Its anterior end forms the *anterior pillars* of the arch, its posterior end the *posterior pillars*, whilst the intermediate *body* of the fornix forms the crown of the arch. It consists of two lateral halves, one belonging to each hemisphere. At the summit of the arch the two lateral halves are joined to form the *body*; but in front the two halves separate from each other, and form two anterior pillars, which descend in front of the third ventricle to the base of the cerebrum, where they form the *corpus albicans*, and from these some white fibres called the bundle of Vicq d'Azyr ascend to the optic thalamus (see fig. 11). Behind the body the two halves diverge much more from each other, and form the *posterior pillars*, in the triangular interval between which is a thin lamina of commissural fibres called the *lyra* (fig. 13, *a*). Each posterior pillar curves downward and outward into the descending cornu of the ventricle, and, under the name of *taenia hippocampi*, forms the mesial free border of the hippocampus major (fig. 13, *i*). Eventually it ends in the substance of the hippocampus and in the uncus of the temporal lobe. If the body of the fornix be now divided by a transverse incision, its anterior part thrown forward, and its posterior part backward, the great transverse fissure of the cerebrum is opened into, and the velum interpositum lying in that fissure is exposed.

The *velum interpositum* is an expanded fold of pia mater, which passes into the anterior of the hemispheres through the great transverse fissure. It is triangular in shape; its base is a line with the posterior end of the corpus callosum, where it is continuous with the external pia mater; its lateral margins are fringed by the choroid plexuses, which are seen in the bodies and descending cornua of the lateral ventricles, where they are invested by the endothelial lining of those cavities. Its apex, where the two choroid plexuses blend with each other, lies just behind the anterior pillars of the fornix. The interval between the apex and these pillars is the aperture of communication between the two lateral ventricles and the third, already referred to as the foramen of Monro. The choroid plexuses contain the small *choroidal arteries*; and the blood from these is returned by small veins, which join to form the *veins of Galen*. These veins pass along the centre of the velum, and, as is shown in fig. 1, open into the straight sinus. If the velum interpositum be now carefully raised from before backward, the optic thalamus, third ventricle, pineal body and corpora quadrigemina are exposed.

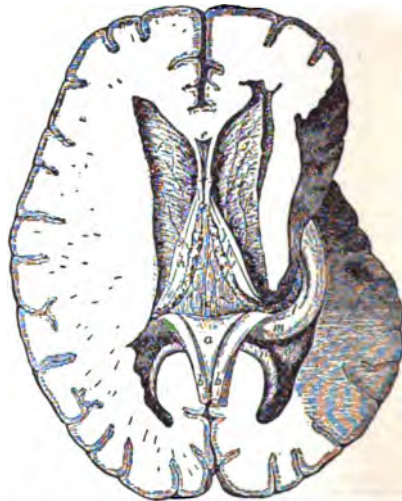

FIG. 13.—A deeper dissection of the Lateral Ventricle, and of the Velum Interpositum.

- | | |
|---|--|
| a, Lyra, turned back. | g, Taenia semicircularis. |
| b, b, Posterior pillars of the fornix, turned back. | h, Optic thalamus. |
| c, c, Anterior pillars of the fornix. | i, Choroid plexus. |
| d, Velum interpositum and veins of Galen. | l, Taenia hippocampi. |
| e, Fifth ventricle. | m, Hippocampus major, in descending cornu. |
| f, f, Corpus striatum. | n, Hippocampus minor. |
| | o, Eminentia collateralis. |

The *optic thalamus* is a large, somewhat ovoid body situated behind the corpus striatum, and above the crus cerebri. Its upper surface is partly seen in the floor of the body of the lateral ventricle, but is for the most part covered by the fornix and velum interpositum. Its postero-inferior surface forms the roof of the descending cornu

of the ventricle, whilst its inner surface forms the side wall of the third ventricle. At its outer and posterior part are two slight elevations, in close relation to the optic tract, and named respectively *corpus geniculatum internum* and *externum*.

The posterior knob-like extremity of the thalamus is called the *putamen*; this, as well as the two *corpora geniculata* and the superior *corpus quadrigeminum*, is connected with the optic tract.

The *third ventricle* (see fig. 6) is a cavity situated in the mesial plane between the two optic thalami. Its roof is formed by the *velum interpositum* and body of the fornix; its floor by the posterior perforated space, *corpora albicantia*, *tuber cinereum*, *Infundibulum*, and optic commissure; its anterior boundary by the anterior pillars of the fornix, anterior commissure and *lamina cinerea*; its posterior boundary by the *corpora quadrigemina* and posterior commissure. The cavity of this ventricle is of small size in the living head, for the inner surfaces of the two thalami are connected together

and posteriorly at the splenium, but the body is above the plane of section. Behind the genu the fifth ventricle is cut, and behind that the two pillars of the fornix which here form the anterior boundary of the third ventricle. At the posterior end of this is the pineal body, which the section has just escaped. To the outer side of the fornix is seen the foramen of Munro, leading into the front of the body and anterior horn of the lateral ventricle. It will be seen that the lateral boundary of this horn is the cut caudate nucleus of the corpus striatum, while the lateral boundary of the third ventricle is the cut optic thalamus, both of which bodies have been already described, but external to these is a third triangular grey mass, with its apex directed inward, which cannot be seen except in a section. This is the lenticular nucleus of the corpus striatum, the inner or apical half of which is of a light colour and is called the *globus pallidus*, while the basal half is redder and is known as the *putamen*. External to the putamen is a long narrow strip of grey matter called the *claustrum*, which is sometimes regarded as a third nucleus of the corpus striatum. These masses of grey matter, taken together, are the basal nuclei of the brain. Internal to the lenticular nucleus, and between it and the caudate nucleus in front and the thalamus behind, is the *internal capsule*, through which run most of the fibres connecting the cerebral cortex with the *crus cerebri*. The capsule adapts itself to the contour of the lenticular nucleus and has an anterior limb, a bend or genu, and a posterior limb. Just behind the genu of the internal capsule is a very important region, for here the great motor tract from the Rolandic region of the cortex passes on its way to the *crusta* and spinal cord. Besides this there are fibres passing from the cortex to the deep origins of the facial and hypo-glossal nerves. Behind the motor tracts are the sensory, including the fillet, the superior cerebellar peduncle and the inferior quadrigeminal tract, while quite at the back of the capsule are found the auditory and optic radiations linking up the higher (cortical) and lower auditory and visual centres. Between the putamen and the claustrum is the *external capsule*, which is smaller and of less importance than the internal, while on the lateral side of the claustrum is the white and then the grey matter of the central lobe. As the fibres of the internal capsule run up toward the cortex they decussate with the transverse fibres of the corpus callosum and spread out to form the *corona radiata*. It has only been possible to deal with a few of the more important bundles of fibres here, but it should be mentioned that much of the white matter of the brain is formed of association fibres which link up different cortical areas, and which become medullated and functional after birth.

Weight of the Brain.

This has been the subject of a great deal of research, but the results are not altogether conclusive; it seems, however, that, although the male brain is 4 to 5 oz. heavier than that of the female, its relative weight to that of the body is about the same in the two sexes. An average male brain weighs about 48 oz. and a female 43½ oz. The greatest absolute weight is found between twenty-five and thirty-five years of age in the male and a little later in the female. At birth the brain weighs comparatively much more than it does later on, its proportion to the body weight being about 1 to 6. At the tenth year it is about 1 to 14, at the twentieth 1 to 30, and after that about 1 to 36.5. In old age there is a further slight decrease in proportion. In many men of great intellectual eminence the brain weight has been large—Cuvier's brain weighed 64½ oz., Gooden's 57½, for instance—but the exceptions are numerous. Brains over 60 oz. in weight are frequently found in quite undistinguished people, and even in idiots 60 oz. has been recorded. On the other hand, microcephalic idiots may have a brain as low as 10 or even 8½ oz., but it is doubtful whether normal intelligence is possible with a brain weighing less than 32 oz. The taller the individual the greater is his brain weight, but short people have proportionally heavier brains than tall. The weight of the cerebellum is usually one-eighth of that of the entire brain. Attempts have been made to estimate the surface area of the grey matter by dissecting it off and measuring it, and also by covering it with gold leaf and measuring that. The results, however, have not been conclusive.

Further details of the brain, abundantly illustrated, will be found in the later editions of any of the standard text-books on anatomy, references to which will be found in the article on ANATOMY: *Modern Human. Das Menschenhirn*, by G. Retzius (Stockholm, 1896), and numerous recent memoirs by C. Elliot Smith and D. J. Cunningham in the *Journ. Anat. and Phys.* and *Anatomisch Anzeig.*, may be consulted.

Histology of Cerebral Cortex.

The cerebral cortex (see fig. 15) consists of a continuous sheet of grey matter completely enveloping the white matter of the hemispheres. It varies in thickness in different parts, and becomes thinner in old age, but all parts show a somewhat similar microscopic structure. Thus, in vertical section, the following layers may be made out:—

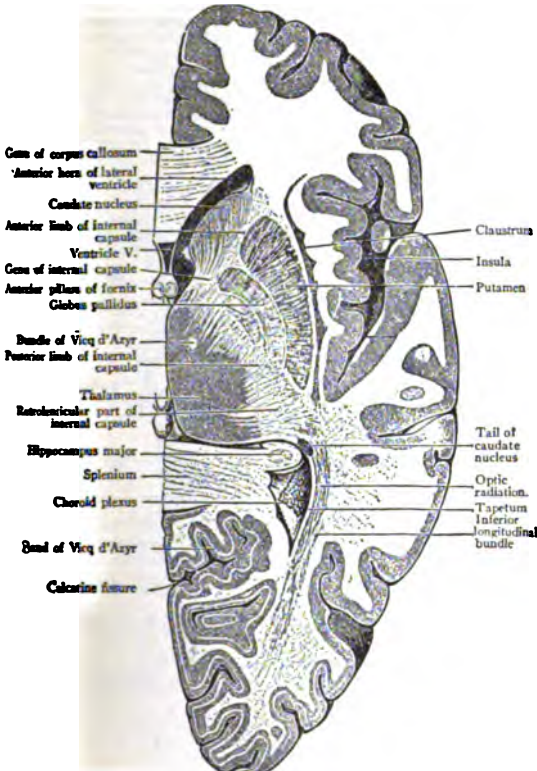

From Cunningham, *Text-book of Anatomy*.

FIG. 14.—Horizontal Section through the Right Cerebral Hemisphere at the Level of the Widest Part of the Lenticular Nucleus.

by intermediate grey matter, named the *middle or soft commissure*. Immediately in front of the *corpora quadrigemina*, the white fibres of the *posterior commissure* pass across between the two optic thalami. If the anterior pillars of the fornix be separated from each other, the white fibres of the *anterior commissure* may be seen lying in front of them.

The *pineal body* is a reddish cone-shaped body situated upon the anterior pair of the *corpora quadrigemina* (see figs. 3 and 6). From its broad anterior end two white bands, the *peduncles of the pineal body*, pass forward, one on the inner side of each optic thalamus. Each peduncle joins, along with the *taenia semicircularis*, the anterior pillar of the fornix of its own side. In its structure this body consists of tubular gland tissue containing gritty calcareous particles, constituting the *brain sand*. Its morphology will be referred to later.

A general idea of the internal structure of the brain is best obtained by studying a horizontal section made just below the level of the Sylvian point and just above the great transverse fissure (see fig. 14). Such a section will cut the corpus callosum anteriorly at the genu

1. *The Molecular Layer (Stratum zonale).*—This is made up of a large number of fine nerve branchings both medullated and non-medullated. The whole forms a close network, the fibres of which run chiefly a tangential course. The cells of this layer are the so-called *cells of Cajal*. They possess an irregular body, giving off 4 or 5 dendrites, which terminate within the molecular layer and a long nerve fibre process or neuraxon which runs parallel to the surface of the convolution.

2. *The Layer of small Pyramidal Cells.*—The typical cells of this layer are pyramid-shaped, the apices of the pyramids being directed towards the surface. The apex terminates in a dendron which reaches into the molecular layer, giving off several collateral horizontal branches in its course. The final branches in the molecular layer take a direction parallel to the surface. Smaller dendrites arise from the lateral and basal surfaces of these cells, but do not extend far from the body of the cell. The neuraxon always arises from the base of the cell and passes towards the central white

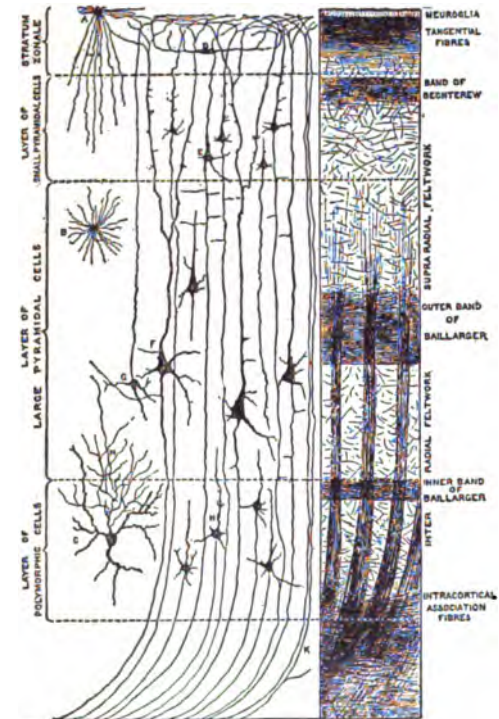

From Cunningham, *Text-book of Anatomy*

FIG. 15.—Diagram to illustrate Minute Structure of the Cerebral Cortex.

- | | |
|---|--------------------------|
| A. } Neuroglia cells. | E. Small pyramidal cell. |
| B. } Cell with short axon (N) which breaks up in a free arborization. | F. Large pyramidal cell. |
| C. } Spindle-shaped cell in stratum zonale. | G. Cell of Martinotti. |
| | H. Polymorphic cell. |
| | K. Corticifugal fibres. |

matter, thus forming one of the nerve-fibres of that substance. In its path it gives off a number of collaterals at right angles, which are distributed to the adjacent grey matter.

3. *The Layer of large Pyramidal Cells.*—This is characterized by the presence of numbers of cells of the same type as those of the preceding layer, but of larger size. The nerve-fibre process becomes a medullated fibre of the white matter.

4. *The Layer of Polymorphous Cells.*—The cells of this layer are irregular in outline, and give off several dendrites branching into the surrounding grey matter. The neuraxon gives off a number of collaterals, and then becomes a nerve-fibre of the central white matter.

Scattered through these three layers there are also a number of cells (*cells of Golgi*) whose neuraxon divides at once, the divisions terminating within the immediate vicinity of the cell-body. Some cells are also found in which the neuraxon, instead of running into

the white matter of the brain, passes toward the surface; these are called *cells of Martinotti*.

The medullated nerve-fibres of the white matter when traced into the cortex are seen to enter in bundles set vertically to the surface. These bundles taper and are resolved into isolated fibres in the upper parts of the pyramidal layers. The fibres constituting the bundles form two sets. (a) The centrifugal fibres consist as above described of the fibre processes of the pyramidal and polymorphous cells. (b) The centripetal fibres ascend through the cortex to terminate within the molecular layer by horizontally running branches. As they pass through they give off a number of collaterals. The position of the cells from which these fibres arise is not known. In addition to the radially arranged bundles of fibres, networks are formed by the interlacement with them of large numbers of fine medullated fibres running tangentially to the surface. These are derived chiefly from the collaterals of the pyramidal cells and of the centripetal fibres. They form two specially marked bundles, one within the layer of the polymorphous cells known as the *inner band of Baillarger*, and another in the layer of large pyramidal cells called the *outer band of Baillarger*. This latter is very thick in the calcarine region, and forms the *white stria of Gennep*, while the inner band is best seen in the precentral gyrus. As both these strands cross the already mentioned radial bundles at right angles, they are regarded as specialized parts of an *interradial reticulum* of fibres, but, nearer the surface than the radial bundles penetrate, tangential fibres are found, and here they are called the *supraradial reticulum*. In certain parts of the brain the fibres of this reticulum are more

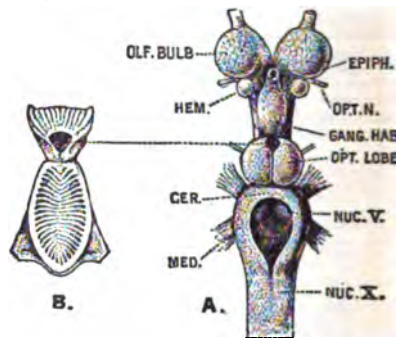

From *The Museum Catalogue of the Royal College of Surgeons of England*.

FIG. 16.—Brain of *Petromyzon marinus* (dorsal view). A, Brain; B, choroid plexus removed.

closely set, and form the *band of Beckerlew* in the superficial part of the small pyramidal cell zone.

For further information on the structure of the cerebral cortex, see A. W. Campbell, *Proc. R. Soc. vol. lxxii. and lxxiv.*

Comparative Anatomy.

A useful introduction to the study of the vertebrate brain is that of the Amphioxus, one of the lowest of the Chordata or animals having a notochord. Here the brain is a very slightly modified part of the dorsal tubular nerve-cord, and, on the surface, shows no distinction from the rest of that cord. When a section is made the central canal is seen to be enlarged into a cavity, the neurocoele, which, in the young animal, communicates by an opening, the neuropore, with the bottom of the olfactory pit, and so with the exterior. More ventrally another slight diverticulum probably represents the infundibulum. The only trace of an eye is a patch of pigment at the anterior end of the brain, and there are no signs of any auditory apparatus. There are only two pairs of cerebral nerves, both of which are sensory (Willcy, *Amphioxus*, 1894). In the Cyclostomata, of which the lamprey (*Petromyzon*) is an example, the minute brain is much more complex, though it is still only a very slight enlargement of the anterior end of the cord. The single cavity seen in *Amphioxus* is here subdivided into three: an anterior or prosencephalon, a middle or mesencephalon, and a hinder or rhombencephalon. The rhombencephalon has a very slight transverse thickening in the fore-part of its roof; this is the rudimentary cerebellum (*Cer.*); the rest of this part of the brain is taken up by the large medulla, the cavity of which is the *fossa rhomboidalis* or fourth ventricle. This fossa is roofed over by the epithelium lining the cavity of the ventricle, by pia mater and blood-vessels constituting a choroid plexus (fig. 16, B). The fourth ventricle communicates with the parts in front by means of a passage known as the aqueduct of Sylvius.

The mesencephalon or mid-brain, when looked at from the dorsal surface, shows a pair of large hollow swellings, the optic lobes or *corpora bigemina*. Their cavities open out from the aqueduct of

Sylvius, and from the nervous tissue in their walls the optic nerves derive their fibres. From the front of the prosencephalon or anterior vesicle the olfactory nerves come off, and at the base of each of these are two hollow swellings; the larger and more anterior is the olfactory bulb, the smaller and more posterior the cerebral hemisphere. Both these swellings must be regarded as lateral outgrowths from the blind front end of the original single vesicle of the brain as seen in Amphioxus, and from the anterior subdivision or prosencephalon in the lamprey. The anterior vesicle, however, is now again subdivided, and that part from which the cerebral hemispheres bud out, and the hemispheres themselves, is called the telencephalon, while the posterior part of the original prosencephalon is known as the thalamencephalon, or more rarely the diencephalon. On the dorsal surface of the thalamencephalon are two nervous masses called the ganglia habenulae; the right is much larger than the left, and from it a stalk runs forward and upward to end in the vestigial pineal body (or epiphysis), which contains rudiments of a pigmented retina and of a lens, and which is usually regarded as the remains of one of a pair of median eyes, though it has been suggested that it may be an organ for the appreciation of temperature. From the small left ganglion habenulae a still more rudimentary pineal stalk projects, and there are signs of a third outgrowth (paraphysis) in front of these. On the floor of the thalamencephalon the blind pouch-like infundibulum is in contact with the pituitary body, an outgrowth from the combined pituitary and olfactory pouch, which in the adult opens on to the top of the head just in front of the pineal area. The anterior closed end of the nerve-tube, in front of the foramina of Munro or openings from which the hemispheres have grown out, is known as the *lamina terminalis*, and in this is seen a little white commissure, connecting the hemispheres of opposite sides and belonging entirely to the telencephalon, known as the anterior commissure. The roof of the telencephalon is mainly epithelial, and contains no traces of cortical structure. In the posterior part of the roof of the thalamencephalon is the small posterior commissure (Abel, *Zoöl. wiss. Zool. Bd. xxxix.*, 1883, p. 191). In the Elasmobranch Fish, such as the sharks and rays, the cerebellum (*Cer. fig. 17*) is very large and contains the layers found in all the higher vertebrates. In the mesencephalon fibres corresponding with those of the fillet of higher vertebrates can be seen, and there is a nucleus in the hinder part of the *corpora bigemina* foreshadowing the separation into corpora quadrigemina. There is only one pineal stalk in the roof of the thalamencephalon, and the ganglia habenulae—very constant structures in the vertebrate brain—are not so marked as in Petromyzon, but are, as usual, connected with the olfactory parts of the cerebrum, with the surface of the optic lobes (*tractus opticus*), and with the *corpus interpedunculare* (Meynert's bundle). They are united across the middle lobe by a small *superior or habenular commissure*. In the floor of the thalamencephalon are two masses of ganglionic tissue, the optic thalami. The infundibulum dilates into two rounded bodies, the *lobi inferiores*, while the pituitary body or *hypophysis cerebri* has two lateral diverticula known as *sacculi vasculosi*. Ganglia geniculata are found for the first time in connexion with the optic tracts in the lower part of the thalamus. The olfactory lobes (*fig. 17, Olf. Bulb*) are very large and often separated by long stalks from the cerebral hemispheres, which are comparatively much larger than those of the Cyclostomata; their roof or pallium is nervous, but devoid of cortical

anterior pineal organ or paraphysis is large (Saunders, *Ann. and Mag. Nat. Hist.* ser. 6, vol. iii., 1889, p. 157; Burkhardt, *Centralnervensystem v. Protopteren*, Berlin, 1892).

In the Amphibia the brain is of a low type, the most marked advances on that of the fish being that the anterior commissure is divided into a dorsal and ventral part, of which the ventral is the true anterior commissure of higher vertebrates, while the dorsal is a hippocampal commissure and coincides in its appearance with the presence of a small mass of cells in the outer layer of the medias

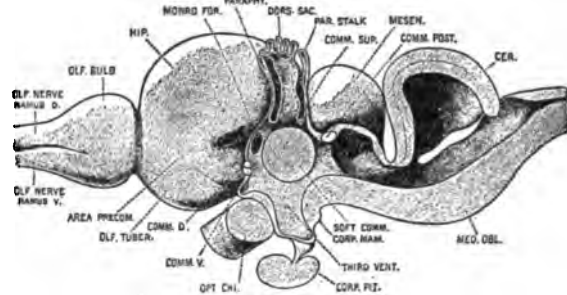

From *Cat. R.C.S. England*.

FIG. 18.—Section of Brain of Turtle (*Chelonia*).

wall of the pallium, which is probably the first indication of a hippocampal cortex or cortex of any kind (Osborn, *Journ. Morph.* vol. ii., 1889, p. 51).

In the Reptilia the medulla has a marked flexure with a ventral convexity, and an undoubted cerebral cortex for the first time makes its appearance. The mesial wall of the cerebral hemisphere is divided into a large dorsal hippocampal area (*fig. 18, Hip.*) and a smaller ventral olfactory tubercle. Between these two a narrow area of ganglionic matter runs forward from the side of the *lamina terminalis* and is known as the paraterminal or precommissural area (Elliot Smith, *Journ. Anat. and Phys.* vol. xxxii, p. 411). To the upper lateral part of the hemisphere Elliot Smith has given the name of *neopallium*, while the lower lateral part, imperfectly separated from it, is called the *pyriform lobe*. In the Lacertilia the pineal eye, if it be an eye, is better developed than in any existing vertebrate, though even in them there is no evidence of its being used for sight. Behind the so-called pineal eye and its stalk is the *epiphysis* or pineal body, and sometimes there is a dorsal sac between them (see *fig. 18*).¹ The middle or soft commissure appears in certain reptiles (*Crocodylia* and *Chelonia*), as does also the *corpus mammillare* (Edinger, *Senckenberg. Naturf. Gesell. Bd. dix.*, 1896, and *Bd. xxii.*, 1899; Haller, *Morph. Jahrb. Bd. xxviii.*, 1900, p. 252). Among the birds there is great unity of type, the cerebellum is large and, by its forward projection, presses the optic lobes down toward the ventro-lateral part of the brain. The cerebral hemispheres are also large, owing chiefly to the great size of the *corpora striata*, which already show a differentiation into caudate nucleus, putamen and globus pallidus. The pallium is reptilian in character, though its cortical area is more extensive. The geniculate bodies are very large (Bumm, *Zoöl. wiss. Zool. Bd. xxxviii.*, 1883, p. 430; Brandis, *Arch. mikr. Anat. Bd. xli.*, 1893, p. 623, and *xliii.*, 1894, p. 96, and *xliv.*, 1895, p. 534; Boyce and Warrington, *Phil. Trans.* vol. cxcii., 1899, p. 293).

Among the Mammalia the Monotremata have a cerebellum which shows, in addition to the central lobe of the lower vertebrates, a foveolus on each side, and the two halves of the cerebellum are united by a ventral commissure, the *pons varolii*. The pallium is reptilian in its arrangement, but that part of it which Elliot Smith has named the *neopallium* is very large, both in the Ornithorynchus and Echidna, a fact very difficult to account for. In the latter animal the cortical area is so extensive as to be thrown into many and deep sulci, and yet the Echidna is one of the lowliest of mammals in other respects. A well-marked rhinal fissure separates the pyriform lobe from the neopallium, while, on the mesial surface, the hippocampal fissure separates the neopallium from the hippocampal area. Just below the hippocampal fissure a specially coloured tract indicates

¹The literature of the pineal region is enormous. Studnicka (in *Oppels Vergleichende mikrosk. Anat. Teile 4-5*, 1904, 1905) gives 285 references. The present conception of the generalized arrangement is: (a) A single glandular median organ from the fore-brain called the paraphysis. (b) A pouch of the ependymal roof of the ventricle called the dorsal sac. (γ) A right and left epiphysis, one of which may be wholly or partially suppressed. These may change their position to anterior and posterior in some animals.

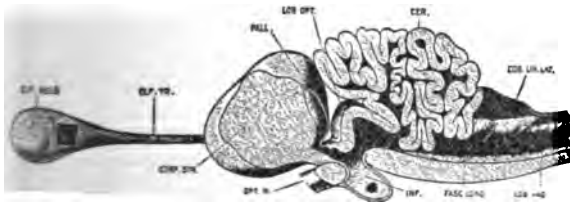

From *Cat. R. C. S. England*.

FIG. 17.—Section of the Brain of Porbeagle Shark (*Lamna*).

structure, while in the floor in some species large anterior basal ganglia or *corpora striata* are found (Miklucho-Maclay, *Beiträge s. wiss. Neurol.*, 1870; Edinger, *Arch. mikr. Anat. Bd. lviii.*, 1901, p. 661. "Cerebellum"). The Teleostean Fish are chiefly remarkable for the great development of the optic lobes and suppression of the olfactory apparatus. The pallium is non-nervous, and the optic tracts merely cross one another instead of forming a commissure. A process of the cerebellum called *subula cerebelli* projects into the cavity of each optic lobe (Rabl, *Ruckhard, Arch. Anat. u. Phys.*, 1898, p. 245 [Pallium]; Haller, *Morph. Jahrb. Bd. xxvi.*, 1898, p. 632 [Histology and Bibliography]). The brain of the Dipnoi, or mud fish, shows no very important developments, except that the

the first appearance of the fascia dentata (see fig. 20). The anterior commissure is divided, as in reptiles, into dorsal and ventral parts, of which the latter is the larger (fig. 20, *Comm. V. and D.*), while just behind the dorsal part is the first appearance of the fimbria or fornix. In addition to the two fissures already named, there is, in the Echinida, one which in position and mode of formation corresponds with the Sylvian fissure of higher mammals. Elliot Smith, however, wisely refuses to homologize it absolutely with that fissure, and proposes the name of pseudosylvian for it. The pineal body is rudimentary, and the optic lobes are now, and throughout the Mammalia, subdivided into four *corpora quadripinnata*.

Among the Marsupialia the Tasmanian devil (*Sarcophilus*) gives a very good idea of a generalized mammalian brain, and shows a large development of the parts concerned in the sense of smell.

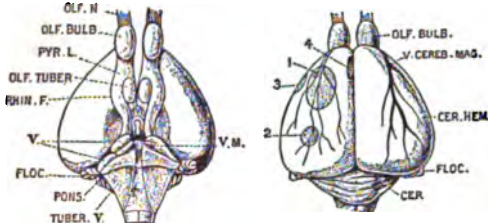

From *Cat. R.C.S. England*.

FIG. 19.—Ventral and Dorsal Views of the Brain of Ornithorynchus.

The most important advance on the monotreme brain is that the calcarine fissure has now appeared on the posterior part of the mesial surface and causes a bulging into the ventricle, called the *calcar avis* or hippocampus minor, just as the hippocampal fissure causes the *hippocampus major* (Gervais, *Nouv. Arch. Mus.* tom. v., 1869; Ziehen, *Jenaische Denkschr.* Bd. vi., 1897).

In the Eutheria or mammals above the marsupials, the cerebellum gradually becomes more complex, owing to the appearance of lateral lobes between the floculus and the vermis, as well as the parafloculus on the outer side of the floculus. The corpus callosum now first appears as a bridge between the neopallia, and its development leads to the stretching of the hippocampal formation, so that in the higher mammals the hippocampus is only found in the lower



From *Cat. R.C.S. England*.

FIG. 20.—Mesial and Lateral Views of the Brain of Ornithorynchus

and back part of the ventricle, while the rudiments of the dorsal part remain as the *striae longitudinales* on the corpus callosum. The dorsal part of the original anterior commissure becomes the fornix, and the paraterminal area is modified to form the septum lucidum. The first appearance of the fissure of Rolando is probably in some of the Carnivora, in which, as the *sulcus crucialis*, it forms the posterior boundary of the "urine lozenge" described by Mivart (*Journ. Linn. Soc.* vol. xix., 1886) (see fig. 22, *Sulc. Cru.*). In the

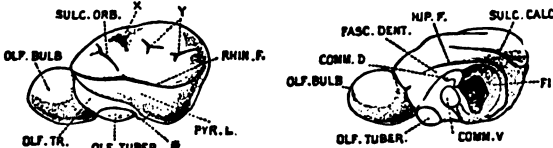

From *Cat. R.C.S. England*.

FIG. 21.—Mesial and Lateral Views of the Brain of the Tasmanian Devil (*Sarcophilus*).

higher apes or Anthropoidea the human fissures and sulci are largely recognizable, so that a gibbon's brain, apart from all question of comparative anatomy, forms a useful means of demonstrating to a junior class the main gyri and sulci of Man in a simple and diagrammatic way. The main points of difference, apart from greater simplicity, are that the central lobe or island of Reil is exposed on the surface of the brain, as it is in the human foetus, and that the

anterior part of the occipital lobe has a well-marked vertical sulcus, called the simian sulcus or *Affenpalte*; this often has a semilunar shape with its convexity forward, and is then called the *sulcus*

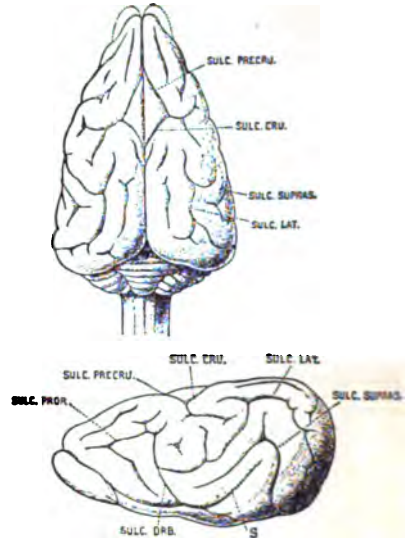

From *Cat. R.C.S. England*.

FIG. 22.—Dorsal and Lateral Views of the Brain of a Ratel (*Mellivora indica*).

lunatus. It is usually concealed in European brains by the overgrowth of the surrounding gyri, but it occasionally remains, though less frequently than in the brains of Egyptian fellahen. Its relation to the *white stria* of *Genaris* is especially interesting, and is recorded by Elliot Smith in the *Anatomischer Anzeiger*. Bd. xxiv., 1904, p. 436. The rhinal fissure, which is so characteristic a feature of the lower mammals, almost disappears in Man, and is only represented by the *stria temporalis* (see fig. 11, *i.t.*). The hippocampal fissure persists with little modification all through the mammalian class. The calcarine fissure remains with many modifications from the marsupials to man, and in view of the famous controversy of 1864, in which Owen, Huxley and the then bishop of Oxford took part, it is interesting to note that its hippocampus minor can now be clearly demonstrated, even in the Marsupialia. Another very ancient and stable sulcus is the *orbital*, which is a simple antero-posterior line until Man is reached (see fig. 23, *Sulc. Orb.*). The great point of importance, however, in the evolution of the mammalian brain is the gradual suppression of the olfactory region, and the development of the neopallium, a development which takes a sudden stride between the Anthropoid apes and Man. (For further particulars of this and other points in the comparative anatomy of the brain, see *Catalogue of the Physiological Series of the Museum of the Royal College of Surgeons of England*, vol. ii. 2nd ed., by R. H. Burne and G. Elliot Smith, London, 1902.)

Embryology.

The brain, like the rest of the nervous system, is developed from the ectoderm or outer layer of the embryo by the formation of a groove in the mid-dorsal line. The lips of this *medullary groove* unite to form a canal beginning at the place where the neck of the embryo is to be. The part of the neural canal in front of the earliest union forms the brain and very early becomes constricted into three vesicles, to which the names of *prosencephalon*, *mesencephalon* and *rhombencephalon* are now usually given. The simple tubular brain we have seen as a permanent arrangement in Amphioxus, but the stage of the three vesicles is a transitory one, and is not found in the adult of any existing animal. From the sides of the prosencephalon, the optic vesicles grow out before the neural tube is completely closed, and eventually form the optic nerves and retinae, while, soon after this, the cerebral hemispheres bulge from the antero-dorsal part of the first primary vesicle, their points of evagination being the *fontanella of Meurer*. From the ventral parts of these cerebral hemispheres the olfactory lobes are

constricted off, while just behind the openings of the foramina of Munro a constriction occurs which divides the prosencephalon into two secondary vesicles, the anterior of which, containing the foramina of Munro, is called the *telencephalon*, while the posterior is the *thalamencephalon* or *diencephalon*. A constriction also occurs in the hind vesicle or *rhombencephalon*, dividing it into an anterior part, the *metencephalon*, from which the cerebellum is developed, and a posterior or *myelencephalon*, the primitive *medulla oblongata*. At this stage the general resemblance of the brain to that of the lamprey is striking.

Before the secondary constrictions occur three vertical flexures begin to form. The first is known as the *cephalic*, and is caused by the prosencephalon bending sharply downward, below and in front of the mesencephalon. The second is the *cervical*, and marks the place where the brain ends and the spinal cord begins; the concavity of this flexure is ventral. The third to appear has a ventral convexity and is known as the *postine*, since it marks the site of the future *pons Varolii*; it resembles the permanent flexure in the reptilian brain.

It will now be seen that the original neural canal, which is lined by ciliated epithelium, forms the ventricles of the brain, while superficial to this epithelium (*ependyma*) the grey and white matter is subsequently formed. It has been shown by His that the whole neural tube may be divided into *dorsal* or *alar*, and *ventral* or *basal* laminae, and, as the cerebral hemispheres bud out from the dorsal part of the anterior primary vesicle, they consist entirely of alar laminae. The most characteristic feature of the human and anthropoid brain is the rapid and great expansion of these hemispheres, especially in a backward direction, so that the mesencephalon and metencephalon are hidden by them from above at the seventh month of intra-uterine life. At first the foramina of Munro form

cinerea, the *corpus callosum*, *fornix* and *septum lucidum*. The roof largely remains epithelial and is invaginated into the ventricle by the mesoderm to form the *choroid plexuses* of the third ventricle, but at the posterior part it develops the *ganglia habenulae* and the pineal body, from a structure just in front of which both a lens and retinal elements are derived in the lower forms. This is one great difference between the development of this organ and that of the true eyes; indeed it has been suggested that the pineal is an organ of thermal sense and not the remains of a median eye at all. The floor of the third ventricle is developed from the basal laminae, which here are very important and from which the *tuber cinereum* and, until the fourth month, single *corpus mammillare* are developed. The *infundibulum* or stalk of the posterior part of the pituitary body at first grows down in front of the *tuber cinereum* and, according to Gaskell's theory, represents an ancestral mouth to which the ventricles of the brain and the central canal of the cord acted as the stomach and intestine (*Quart. Journ. of Mic. Sci.* 31, p. 379; and *Journ. of Phys.* v. 10, p. 153). The reason why the basal lamina is here small is because it contains the nuclei of no cranial nerves. The anterior and posterior commissures appear before the middle and the middle before the *corpus callosum*, as they do in phylogeny. In connexion with the thalamencephalon, though not really belonging to it, may be mentioned the anterior lobes of the pituitary body; these begin as an upward *dimericulum* from the posterior wall of the primitive pharynx or *stomatodaeum* about the fourth week. This *pouch of Rathke*, as it is called, becomes nipped off by the developing base of the skull, and its bifid blind end meets and becomes applied to the posterior part of the body, which comes down from the brain. In the mesencephalon the alar laminae form the *corpora quadrigemina*; these at first are bigeminal and hollow as they are in the lower vertebrates. The basal laminae thicken to form the *crura cerebri*. In the rhombencephalon the division into basal and alar laminae is better marked than in any other part; there is a definite groove inside the fourth ventricle, which remains in the adult as the superior and inferior *fossae* and which marks the separation between the two laminae. In the basal laminae are found the deep origins of most of the motor cranial nerves, while those of the sensory are situated in the alar laminae. The roof of the fourth ventricle widens out very much and remains largely epithelial as the superior and inferior medullary vela. The cerebellum develops in the anterior part of the roof of the rhombencephalon as two lateral rudiments which unite in the mid line and so form a transverse bar similar to that seen in the adult lamprey; at the end of the second month the flocculus and paraflocculus become marked, and later on a series of transverse fissures occur dividing the various lobes. Of the cerebellar peduncles the inferior develops first (third month), then the middle forming the *pons* (fourth month), and lastly the *superior* (fifth month) (Elliot Smith, *Review of Neurology and Psychiatry*, October 1903; W. Kuitman, "Die Entwicklung des Kleinhirns bei Säugtieren," *Münchener Med. Abhandl.*, 1895; B. Stroud, "Mammalian cerebellum," *Journ. of Comp. Neurology*, 1895). Much of our knowledge of the tracts of fibres in the brain is due to the fact that they acquire their white sheaths at different stages of development, some long after birth.

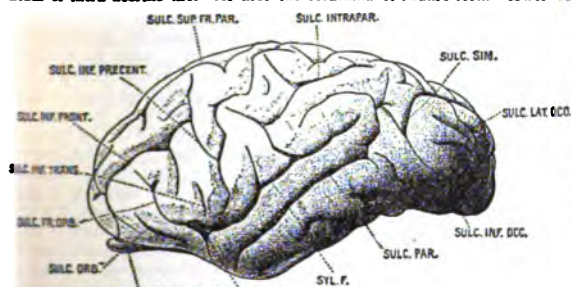

From Col. R.C.S. England.

FIG. 23.—Lateral view of cerebral hemisphere of Gorilla (*Anthropopithecus gorilla*).

a communication not only between the third and lateral ventricles, but between the two lateral ventricles, so that the cavity of each hemisphere is continuous with that of the other; soon, however, a median longitudinal fissure forms, into which the mesoderm grows to form the *falk*, and so the foramina of Munro are constricted into a V-shaped canal. In the floor of the hemispheres the *corpora striata* are developed at an early date by a multiplication of nerve cells, and on the external surface a depression, called the *Sylvian fossa*, marks the position of the future central lobe, which is afterwards hidden as the lips of the *fossa opercularis* gradually close in on it to form the *Sylvian fissure*. The real fissures are complete indentings of the whole thickness of the vesicular wall and produce swellings in the cavity. Some of them, like the choroidal on the mesial surface, are developed very early, while the vesicle is little more than epithelial, and contain between their walls an inpushing of mesoderm to form the *choroid plexus*. Others, like the hippocampal and calcarine, appear in the second and third months and correspond to invaginations of the nervous tissue, the hippocampus major and minor. The sulci appear later than the fissures and do not affect the internal cavity; they are due to the rapid growth of the cortex in certain areas. The *corpus callosum* and *fornix* appear about the third month and their development is somewhat doubtful; they are probably modifications of the *lamina terminalis*, but they may be secondary adhesions between the adjacent surfaces of the cerebral hemispheres where the cortical grey matter has not covered the white. They begin at their antero-ventral part near the genu of the *corpus callosum* and the anterior pillars of the *fornix*, and these are the parts which first appear in the lower mammals. The original anterior vesicle from which the hemispheres evaginate is composed, as already shown, of an anterior part or *telencephalon* and a posterior or *thalamencephalon*; the whole forming the third ventricle in the adult. Here the alar and basal laminae are both found, but the former is the more important; from it the optic thalami are derived, and more posteriorly the geniculate bodies. The anterior wall, of course, is the *lamina terminalis*, and from it are formed the *laminae*

of development, some long after birth.

For further details and references see Quain's *Anat.* vol. i. (1908); Minot's *Human Embryology* (New York); W. His, *Anal. menschlicher Embryonen* (Leipzig, 1881); Marshall's *Vertebrate Embryology*; Kölliker, *Grundriss der Entwicklungsgeschichte* (Leipzig, 1880); A. Keith, *Human Embryology and Morphology* (London, 1904); O. Hertwig, *Handbuch der vergleichenden und experimentellen Entwicklungslehre der Wirbeltiere*, Bd. 2, part 3 (Jena, 1902-1906); *Development of the Human Body*, J. P. McMurrich (1906).

(F. G. P.)

2. PHYSIOLOGY

The nervous system has as its function the co-ordinating of the activities of the organs one with another. It puts the organs into such mutual relation that the animal reacts as a whole with speed, accuracy and self-advantage, in response to the environmental agencies which stimulate it. For this office of the nervous system there are two fundamental conditions. The system must be thrown into action by agencies at work in the environment. Light, gravity, mechanical impacts, and so on, which are conditions significant for animal existence, must find the system responsive and through it evoke appropriate activity in the animal organs. And in fact there have been evolved in the animal a number of structures called receptive organs which are selectively excitable by different environmental agencies. Connected with these receptive organs lies that division of the nervous system which is termed *afferent* because it conducts impulses inwards towards the nervous centres. This division consists of elongated nerve-cells, in man some two

million in number for each half of the body. These are living threads of microscopic tenuity, each extending from a receptive organ to a central nervous mass. These central nervous masses are in vertebrates all fused into one, of which the part which lies in the head is especially large and complex, because directly connected with particularly important and delicate receptive organs. The part of the central nervous organ which lies in the head has, in consequence of its connexion with the most important receptive organs, evolved a dominant importance in the nervous system, and this is especially true of the higher animal forms. This head part of the central nervous organ is sufficiently different from the rest, even to anatomical examination, to have received a separate name, the *brain*. But the fact of its having received a separate name ought not to obscure the singleness and solidarity of the whole central nervous organ as one entity. The functions of the whole central nervous organ from region to region are essentially similar throughout. One of its essential functions is reception, via afferent nerves, of nervous impulses generated in the receptive organs by environmental agents as stimuli. In other words, whatever the nature of the agent, its result on the receptive organs enters the central nervous organ as a nervous impulse, and all segments of the central nervous organ receive impulses so generated. Further, it is not known that nervous impulses present qualitative differences among themselves. It is with these impulses that the central nervous organ whether spinal cord or brain has to deal.

Material and Psychological Signs of Cerebral Activity.—In the central nervous organ the action resulting from entrant impulses has issue in three kinds of ways. The reaction may die out, be suppressed, and so far as discoverable lead to nothing; or the impulses may evoke effect in either or both of two forms. Just as from the receptive organs, nerves lead into the central nervous organ, so conversely from the central organ other nerves, termed *efferent*, lead to various organs of the body, especially glands and muscles. The reaction of the central nervous organ to impulses poured into it commonly leads to a discharge of impulses from it into glands and muscles. These centrifugal impulses are, so far as is known, qualitatively like the centripetal impulses. On reaching the glands and muscles they influence the activity of those organs. Since those organs are therefore the mechanisms in which the ultimate effect of the nervous reaction takes place, they are often termed from this point of view *effector organs*. A change ensuing in effector organs is often the only sign an observer has that a nervous reaction has occurred, unless the nervous system under observation be the observer's own.

If the observer turns to his own nervous system for evidence of reaction, he meets at once in numberless instances with *sensation* as an outcome or sign of its reaction. This effect he cannot show to any being beside himself. He can only describe it, and in describing it he cannot strictly translate it into any term of material existence. The unbridged gulf between sensation and the changes produced in effector organs necessitates a separate handling of the functions of the nervous system according as their office under consideration is sensation or material effect. This holds especially in the case of the brain, and for the following reasons.

Psychosis and the Fore-Brain.—Hippocrates wrote, "It is through the brain that we become mad, that delirium seizes us, that fears and terrors assail us." "We know that pleasure and joy on the one hand and pain and grief on the other are referable to the brain. It is in virtue of it that we think, understand, see, hear, know ugliness and beauty, evil and good, the agreeable and the disagreeable." Similarly and more precisely Descartes indicated the brain, and the brain alone, as the seat of consciousness. Finally, it was Flourens who perhaps first definitely insisted on the restriction of the seat of consciousness in higher animals to that part of the brain which is the fore-brain. A functional distinction between the fore-brain and the remainder of the nervous system seems, in fact, that consciousness and physical reactions are adjunct to the fore-brain in a way in which they are not to the rest of the system. After transection of the

spinal cord, or of the brain behind the fore-brain, psychical phenomena do not belong to the reactions of the nervous arcs posterior to the transection, whereas they do still accompany reactions of the nervous arcs in front and still connected with the fore-brain. A man after severance of the spinal cord does not possess in the strict sense consciousness of the limbs whose afferent nerves lie behind the place of spinal severance. He can see them with his eyes, and if the severance lie between the arms and the legs, can feel the latter with his hands. He knows them to be a part of his body. But they are detached from his consciousness. Sensations derived from them through all other channels of sense than their own do not suffice to restore them in any adequate measure to his consciousness. He must have the sensations so called "resident" in them, that is, referred to them, without need of any logical inference. These can be yielded only by the receptive organs resident in the part itself, its skin, its joints, its muscles, &c., and can only be yielded by those receptive organs so long as the nerve impulses from them have access to the fore-brain. Consciousness, therefore, does not seem to attach to any portion of the nervous system of higher animals from which the fore-brain has been cut off. In the dog it has been found that no sign of memory, let alone intelligence, has been forthcoming after removal of the greater part of the fore-brain.

In lower vertebrates it is not clear that consciousness in primitive form requires always the co-operation of the fore-brain. In them the fore-brain does not seem a *conditio sine qua non* for psychosis—so far as we may trust the rather hazardous inferences which study of the behaviour of fish, &c., allows. And the difference between higher and lower animal forms in respect of the fore-brain as a condition for psychosis becomes more marked when the Arthropoda are examined. The behaviour of some Insecta points strongly to their possessing memory rudimentary in kind though it may be. But in them no homologue of the fore-brain of vertebrates can be indisputably made out. The head ganglia in these Invertebrates may, it is true, be analogous in function in certain ways to the brain of vertebrates. Some experiments, not plentiful, indicate that destruction of these head ganglia induces deterioration of behaviour such as follows loss of psychical functions in cases of destruction of the fore-brain in vertebrates. Though, therefore, we cannot be clear that the head ganglia of these Invertebrates are the same structure morphologically as the brain of vertebrates, they seem to hold a similar office, exercising analogous functions, including psychosis of a rudimentary kind. We can, therefore, speak of the head ganglia of Arthropods as a brain, and in doing so must remember that we define by physiological evidence rather than by morphological.

Cerebral Control over Lower Nervous Centres.—There accrues to the brain, especially to the fore-brain of higher Vertebrates, another function besides that of grafting psychical qualities upon the reactions of the nervous system. This function is exhibited as power to control in greater or less measure the pure reflexes enacted by the system. These pure reflexes have the character of fatality, in the sense that, given a particular stimulus, a particular reaction unvaryingly follows; the same group of muscles or the same gland is invariably thrown into action in the same way. Removal of the fore-brain, *i.e.* of that portion of the central nervous organ to which psychosis is adjunct, renders the nervous reactions of the animal more predictable and less variable. The animal, for instance, a dog, is given over more completely to simple reflexes. Its skin is touched and it scratches the spot, its jaw is stroked and it yawns, its rump is rubbed and it shakes itself, like a dog coming out of water; and these reactions occur fatally and inopportunistly, for instance, when food is being offered to it, when the dog normally would allow no such insignificant skin stimuli as the above to defer his appropriate reaction. Goltz relates the behaviour of a dog from which almost the whole fore-brain had been removed. The animal lived healthily under the careful treatment accorded it. At feeding time a little quinine (bitter) added to its soup of meat and milk led to the morsels, after being taken into the

mouth, being at once and regularly rejected. None was ever swallowed, nor was the slightest hesitation in their rejection ever obtained by any coaxing or command, or encouragement of the animal by the attendant who constantly had charge of it. On the other hand, directly an undoctored piece had entered the mouth it was swallowed at once. Goltz threw to his own house-dog a piece of the same doctored meat. The creature wagged its tail and took it eagerly, then after receiving it into its mouth pulled a wry face and hesitated, astonished. But on encouragement to go on eating it the dog did so. Perhaps it deemed it unseemly to appear ungrateful to the giver and reject the gift. It overcame its reflex of rejection, and by its self-control gave proof of the intact cerebrum it possessed.

There seems a connexion between consciousness and the power to modify reflex action to meet the exigencies of the occasion. Pure reflexes are admirably adapted to certain ends. They are reactions which have long proved advantageous to the phylum of which the existent animal is the representative embodiment. But the reflexes have a machine-like fatality, and conscious aim does not forerun their execution. The subject as active agent does not direct them. Yet they lie under the control of higher centres. The cough, the eye-closure, the impulse to smile, all these can be suppressed. The innate respiratory rhythm can be modified to meet the requirements of vocal utterance. In other words, the reaction of reflex arcs is controllable by the mechanism to whose activity consciousness is adjunct. The reflexes controlled are often reactions but slightly affecting consciousness, but consciousness is very distinctly operative with the centres which exert the control. It may be that the primary aim, object and purpose of consciousness is control. "Consciousness in a mere automaton," writes Professor Lloyd Morgan, "is a useless and unnecessary epiphenomenon." As to how this conscious control is operative on reflexes, how it intrudes its influence on the running of the reflex machinery, little is known.

The Cerebrum an Organ giving Adaptation and Readjustment of Motor Acts.—The exercise of this control and the acquirement of skilled actions have obviously elements in common. By skilled actions, we understand actions not innately given, actions acquired by training in individual experience. The controlling centres pick out from an ancestral motor action some part, and isolate and enhance that until it becomes a skilled act. The motor co-ordination ancestrally provided for the ring finger gives an extending of it only in company with extension of the fingers on either side of it. The isolated lifting of the ring finger can, however, soon be acquired by training. In such cases the higher centre with conscious effort is able to dissociate a part from an ancestral co-ordination, and in that way to add a skilled adapted act to the powers of the individual.

The nervous organs of control form, therefore, a special instrument of adaptation and of readjustment of reaction, for better accommodation to requirements which may be new. The attainment of more precision and speed in the use of a tool, or the handling of a weapon, means a process in which nervous organs of control modify activities of reflex centres themselves already perfected ancestrally for other though kindred actions. This process of learning is accompanied by conscious effort. The effort consists not so much in any course of reasoning but rather in the acquiring of new sensorimotor experience. To learn swimming or skating by simple cogitation or mere visual observation is of course impossible. The new ideas requisite cannot be constructed without motor experience, and the training must include that motor experience. Hence the training for a new skilled motor manoeuvre must be simply *ad hoc*, and is of itself no training for another motor co-ordination.

The more complex an organism the more points of contact does it have with its environment, and the more does it need readjustment amid an environment of shifting relationships. Hence the organs of consciousness and control, being organs of adaptation and readjustment of reaction, will be more pronounced the farther the animal scale is followed upward to its crowning species, man. The cerebrum and especially the cerebral

cortex may be regarded as the highest expression of the nervous organ of individual adaptation of reactions. Its high development in man makes him the most successful animal on earth's surface at the present epoch. The most important part of all this adjustment in his case, as he stands now, consists doubtless in that nervous activity which is intellectual. The mentality attached to his cerebrum includes reason in higher measure than is possessed by the mentality of other animals. He, therefore, more than they, can profitably forecast the future and act suitably to meet it from memory of the past. The cerebrum has proved itself by his case the most potent weapon existent for extending animal dominance over the environment.

Means and Present Aims of Physiological Study of the Brain.—The aspects of cerebral activity are therefore twofold. There is the contribution which it makes to the behaviour of the animal as seen in the creature's doings. On the other hand there is its product in the psychical life of the animal. The former of these is subject matter for physiology; the latter is especially the province of psychology. Physiology does, however, concern itself with the psychical aspect of cerebral functions. Its scope, embracing the study of the bodily organs in regard to function, includes the psychic as well as the material, because as just shown the former inextricably interlace with the latter. But the relation between the psychic phenomena and the working of the brain in regard to any data of fundamental or intimate character connecting the two remains practically as unknown to us as to the Greek philosophers. What physiology has at present to be content with in this respect is the mere assigning of certain kinds of psychic events to certain local regions of the cerebrum. This primitive quest constitutes the greater part of the "neurology" of our day, and some advance has been made along its lines. Yet how meagre are really significant facts will be clear from the brief survey that follows. Before passing finally from these general considerations, we may note that it becomes more and more clear that the brain, although an organ than can be treated as a whole, is complex in the sense that separable functions belong in some measure to its several parts.

The means principally adopted in studying the functions of the brain—and it must be remembered that this study in its present phase is almost exclusively a mere search for localization—are four. These are the physiological, the clinico-pathological, the histological and the zoological. The first named proceeds by observing the effects of artificial excitation, chiefly electric, of various parts of the brain, and the defects produced by destruction or removal of circumscribed portions. The clinico-pathological proceeds by observing the disturbances of body and mind occurring in disease or injury, and ascertaining the extent of the disease or injury, for the most part *post mortem*. The histological method examines the microscopic structure of the various regions of the brain and the characters and arrangement of the nerve-cells composing it. The zoological follows and compares the general features of the brain, as represented in the various types of animal creation.

It is on the functions of the fore-brain that interest now mainly focuses, for the reasons mentioned above. And the interest in the fore-brain itself chiefly attaches to the functions of its cortex. This is due to several causes. In man and the animals nearest him the cortex forms by far the larger part of the whole cerebral hemisphere. More than any other part it constitutes the distinctively human feature. It lies accessible to various experimental observations, as also to traumatic lesions and to the surgeon's art. It is composed of a great unbroken sheet of grey matter; for that reason it is a structure wherein processes of peculiar interest for the investigation in view are likely to occur. To make this last inference more clear a reference to the histology of nervous tissue must be made. The whole physiological function of the nervous system may be summed up in the one word "conduction." This "conduction" may be defined as the transmission of states of excitement (nerve-impulses) along the neural arcs composing the system. The whole nervous system is built up of chains of nerve-cells (neurones) which are nervous conductors, the chains often

being termed arcs. Each neurone is an elongated cell which transmits nerve-impulses from its one end to its other, without so far as is known modifying the impulses in transit, unless in that part of the nerve-cell where the nucleus lies. That part of the neurone or nerve-cell is called the perikaryon or cell-body, and from that part usually many branches of the cell (each branch being a nerve-fibre) ramify. There is no evidence that impulses are modified in transit along a branch of a nerve-cell, but there is clear evidence of manifold modification of nerve-impulses in transit along the nerve-arcs of the nervous system. These nerve-arcs are neurone-chains. In them one neurone continues the line of conduction where the immediately foregoing neurone left it. That is, the neurones are laid in conductive series, the far end of one apposed to the near end of its precursor. The place of juxtaposition of the end of one neurone against the beginning of another is called the *synapse*. At it the conduction which has so far been wholly intra-neuronic is replaced by an inter-neuronic process, in which the nerve impulse passes from one neurone to the next. The process there, it is natural to think, must be physiologically different from that conductive process that serves for transmission merely within the neurone itself. It may be that to this inter-neuronic conduction are due the differences between conduction in nerve-arcs and nerve-trunks (nerve-fibres) respectively. Significant of the former are changes in rhythm, intensity, excitability and modifications by summation and inhibition; in fact a number of the main features of nervous reaction. These characters impressed upon conduction in nerve arcs (neurone-chains) would therefore be traceable to the intercalation of perikarya and synapses, for both these structures are absent from nerve-trunks. It is therefore probably to perikarya and synapses that the greater part of the co-ordination, elaboration and differentiation of nervous reactions is due. Now, perikarya and synapses are not present in the *white* matter of the central nervous organ, any more than they are in nerve-trunks. They are confined exclusively to those portions of the central organ which consist of *grey matter* (so called from its naked-eye appearance). Hence it is to the great sheet of grey matter which enfolds the cerebrum that the physiologist turns, as to a field where he would expect to find evidences of the processes of cerebral co-ordination at work. It is therefore to items regarding the functions of the great sheet of cerebral cortex that we may now pass.

The Cerebral Cortex and its Functions.—The main question which vexed the study of the physiology of the cerebral hemispheres in the 19th century was whether differences of function are detectible in the different regions of the hemisphere and especially in those of its cortex. One camp of experimenters and observers held that the cortex was identical in function throughout its extent. These authorities taught that the various faculties and senses suffer damage in proportion to the amount of cortex removed or injured, and that it is a matter of indifference what may be the particular region wherein the destruction takes place. Against this an opposed set of observers held that different regions perform different functions, and this latter "differential" view was raised in two wholly dissimilar forms in the first and last quarters of the 19th century respectively. In the first quarter of the century, a school, with which the name of Gall is prominently associated, held that each faculty of a set of particular so-called "faculties," which it assumed constituted intelligence, has in the brain a spatially separate organ proper to itself. Gall's doctrine had two fundamental propositions. The first was that intelligence resides exclusively in the brain: the second, that intelligence consists of twenty-seven "faculties," each with a separate local seat in the brain. The first proposition was not new. It is met with in Hippocrates, and it had been elaborated by Descartes and others. But Bichat in his *Anatomie generale* had partly wandered from the gradually established truth and referred the emotions to the visceral organs, returning to a naive view popularly prevalent. Gall's first proposition was probably raised especially in reaction against Bichat. But Gall's proposition was retrograde from the true position of the science of his time. Flourens

and others of his contemporaries had already shown not only that intelligence was resident exclusively in the brain, but that it was resident exclusively in that part of the brain which is the fore-brain. Now Gall placed certain of his twenty-seven intellectual faculties in the cerebellum, which is part of the hind-brain.

Phrenology.—As to Gall's second proposition, the set of faculties into which he analysed intelligence shows his power of psychological analysis to have been so weak that it is matter of surprise his doctrine could obtain even the ephemeral vogue it actually did. Among his twenty-seven faculties are, for instance, "*l'amour de la progéniture, l'instinct carnassier, l'amitié, la ruse, la sagacité comparative, l'esprit métaphysique, le talent poétique, la mimique,*" &c. Such crudity of speculation is remarkable in one who had undoubtedly considerable insight into human character. Each of the twenty-seven faculties had its seat in a part of the brain, and that part of the brain was called its "organ." The mere spatial juxtaposition or remoteness of these organs one from another in the brain had, according to Gall, an influence on the constitution of the mind. "*Comme l'organe des arts est placé loin de l'organe du sens des couleurs, cette circonstance explique pourquoi les peintres d'histoire ont été rarement coloristes.*" All these "faculty-organs" were placed by Gall at the surface of the brain. "This explains the correspondence which exists between craniology and the doctrine of the functions of the brain (cerebral physiology), the single aim of my researches." Gall wrote that he found the bump of pride (*la bosse de l'orgueil*) as far down in the animal series as the goat. Broussais traced the "organ" of veneration as far down as the sheep. Gall found the bump of murder (*bosse du meurtre*) in the carnivora. Later it was traced also in herbivora. Broussais added apologetically that "the herbivora cause a real destruction of plants."

Gall's doctrine enjoyed enormous vogue. He himself had the gifts and the demerits of quackery. His doctrine possessed, apart from its falsity, certain other mischievous qualities. "*Que ces hommes si glorieux, qui font égorgé les nations par millions, sachent qu'ils n'agissent point de leur propre chef, que c'est la nature qui a placé dans leur cœur la rage de la destruction.*" One of his scientific opponents rejoined, "Nay, it is not that which they should know. What they should know is that providence has allowed to man the possibility of doing evil, it has also endowed him with the power to do good." The main cause of the success of phrenology (*q.v.*) has been no doubt the common desire of men to read the characters and hidden thoughts of others by external signs. Each bump or "bosse" on the cranium was supposed to indicate the existence and degree of development of one or other of the twenty-seven "faculties." One such "bosse" showed the development of the organ of "goodness," and another the development of the organ of "murder." Such an easy means to arrive at information so curious delighted many persons, and they were not willingly undeceived.

Modern Localisation Doctrines.—The crude localization of the phrenologists is therefore too clumsy to possess an interest it might otherwise have had as an early expression of belief in cerebral localization, a belief which other labours have subsequently justified, although on facts and lines quite different from these imagined by Gall and his followers. Patient scientific toil by the hands of E. Hitzig and D. Ferrier and their followers has slowly succeeded in obtaining certain facts about the *cortex cerebri* which not only show that different regions of it are concerned with different functions, but, for some regions at least, outline to some extent the kind of function exercised. It is true that the greater part of the cortex remains still *terra incognita* unless we are content with mere descriptive features concerning its coarse anatomy. For several scattered regions some knowledge of their function has been gained by physiological investigation. These scattered regions are the *visual, the auditory, the olfactory and the precentral*.

The grey matter of the cerebral cortex is broadly characterized histologically by the perikarya (nerve-cells bodies) which lie in it

possessing a special shape; they are pyramidal. The dendrite fibres of these cells—that is, their fibres which conduct *towards* the perikarya—are branches from the apex and corners of the pyramid. From the base often near its middle arises one large fibre—the axone fibre, which conducts impulses away from the perikaryon. The general appearance and arrangement of the neurones in a particle of cortical grey matter are shown in fig. 15, above. The apices of the pyramidal perikarya are turned towards the free surface of the cortex. The figure as interpreted in terms of functional conduction means that the cortex is beset with conductors, each of which collects nerve-impulses, from a minute but relatively wide field by its branched dendrites, and that these nerve-impulses converge through its perikaryon, issue by its axone, and are carried whithersoever the axone runs. In some few cells the axone breaks up into branches in the immediate neighbourhood of its own perikaryon in the cortex. In most cases, however, the axone runs off into the subjacent white matter, leaving the cortex altogether. On reaching the subjacent white matter it mingles with other fibres and takes one of the following courses:—(1) to the grey matter of the cortex of the same hemisphere, (2) to the grey matter of the cortex of the opposite hemisphere, (3) to the grey matter of the pons, (4) to the grey matter of the bulb or spinal cord. It is noteworthy that the dendrite fibres of these cortical neurones do not transgress the limits of the grey cortex and the immediate neighbourhood of the perikaryon to which they belong; whereas the discharging or axone fibre does in the vast majority of cases transgress the limits of the grey matter wherein its perikaryon lies. The cortical neurone therefore collects impulses in the region of cortex just about its perikaryon and discharges them to other regions, some not cortical or even cerebral, but spinal, &c. One question which naturally arises is, do these cells spontaneously generate their impulses or are they stirred to activity by impulses which reach them from without? The tendency of physiology is to regard the actions of the cortex as reactions to impulses communicated to the cortical cells by nerve-channels reaching them from the sense organs. The neurone conductors in the cortex are in so far considered to resemble those of reflex centres, though their reactions are more variable and complex than in the use of the spinal. The chains of neurones passing through the cortex are more complex and connected with greater numbers of associate complex chains than are those of the spinal centres. But just as the reflex centres of the cord are each attached to afferent channels arriving from this or that receptive-organ, for instance, tactile-organs of the skin, or spindles of muscle-sense, &c., so the regions of cortex whose function is to-day with some certainty localized seem to be severally related each to some particular sense-organ. The localization, so far as ascertained, is a localization which attaches separate areas of cortex to the several species of sense, namely the visual, the auditory, the olfactory, and so on. This being so, we should expect to find the sensual representation in the cortex especially marked for the organs of the great distance-receptors, the organs which—considered as *sense* organs—initiate sensations having the quality of profluence into the sensible environment. The organs of distance-receptors are the olfactory, the visual and the auditory. The environmental agent which acts as stimulus in the case of the first named is chemical, in the second is radiant, and in the last is mechanical.

Olfactory Region of Cortex.—There is phylogenetic evidence that the development of the *cortex cerebri* first occurred in connexion with the distance-receptors for chemical stimuli—that is, expressed with reference to psychosis, in connexion with olfaction. The olfactory apparatus even in mammals still exhibits a neural architecture of primitive pattern. The cell which conducts impulses to the brain from the olfactory membrane in the nose resembles cells in the skin of the earthworm, in that its cell-body lies actually amid the epithelium of the skin-surface and is not deeply buried near or in the central nervous organ. Further, it has at its external end tiny hairlets such as occur in specially receptive-cells but not usually in purely nervous cells. Hence we must think that one and the same cell by its external end

receives the environmental stimulus and by its deep end excites the central nervous organ. The cell under the stimulation of the environmental agent will therefore generate in itself a nervous impulse. This is the clearest instance we have of a neurone being actually excited under natural circumstances by an agent of the environment *directly*, not indirectly. The deep ends of these olfactory neurones having entered the central nervous organ come into contact with the dendrites of large neurones, called, from their shape, mitral. In the dog, an animal with high olfactory sense, the axone of each olfactory neurone is connected with five or six mitral cells. In man each olfactory neurone is connected with a single mitral cell only. We may suppose that the former arrangement conduces to intensification of the central reaction by summation. At the same time it is an arrangement which could tend to smother sharp differentiation of the central reaction in respect to locality of stimulus at the receptive surface. Considering the diffuse way in which olfactory stimuli are applied in comparison, for instance, with visual, the exact localization of the former can obviously yield little information of use for locating the exact position of their source. On the other hand, in the case of visual stimuli the locus of incidence, owing to the rectilinear propagation of light, can serve with extraordinary exactitude for inferences as to the position of their source. The adaptation of the neural connexions of the two organs in this respect is therefore in accord with expectation.

The earliest cerebral cortex is formed in connexion with the neurone-chains coming into the central nervous organ from the patch of olfactory cells on the surface of the head. The region of cerebrum thus developed is the so-called olfactory lobe and hippocampal formation. The greater part of the cerebral hemisphere is often termed the *pallium*, because as its development extends it folds cloak-wise over the older structures at the base of the brain. The olfactory lobe, from its position, is sometimes called the *pallium basale*, and the hippocampal formation the *pallium marginale*; and these two parts of the pallium form what, on account of their phylogenetic history, Elliott Smith well terms the *archipallium*. A fissure, the limbic fissure, marks off more or less distinctly this archipallium from the rest of the pallium, a remainder which is of later development and therefore designated by Elliott Smith the *neopallium*. Of the archipallium, the portion which constitutes the olfactory lobe is well formed in the selachian fish. In the reptilian cerebrum the hippocampal region, the *pallium marginale*, coexists in addition. These are both of them olfactory in function. Even so high up in the animal scale as the lowest mammals they still form one half of the entire pallium. But in the higher apes and in man the olfactory portion of the pallium is but a small fraction of the pallium as a whole. It is indeed so relatively dwarfed and obscured as to be invisible when the brain is regarded from the side or above. The olfactory part of the pallium exhibits little variation in form as traced up through the higher animals. It is of course small in such animals as Cetaceans, which are *anosmatic*. In highly osmatic such as the dog it is large. The *uncus*, and *subiculum cornu ammonis* of the human brain, belong to it. Disease of these parts has been accompanied by disturbance of the sense of smell. When stimulated electrically (in the rabbit) the olfactory pallium occasions peculiar torsion of the nose and lips (Ferrier), and change, often slowing or arrested, of the respiratory rhythm. P. E. Flechsig has shown that the nerve-fibres of this part of the pallium attain the final stage of their growth, that is to say, acquire their sheaths of myelin, early in the ontogenetic development of the brain. In the human brain they are myelinate before birth. This is significant from the point of view of function, for reasons which have been made clear especially by the researches of Flechsig himself.

The completion of the growth of the nerve-fibres entering and leaving the cortex occurs at very various periods in the growth of the brain. Study of the development of the fibres entering and leaving the various regions of the pallium in the human brain, discovers that the regions may be conveniently grouped into those whose fibres are perfected before birth and those whose fibres are perfected during the first post-natal month,

and those whose fibres are perfected after the first but before the end of the fourth post-natal month. The regions thus marked out by completion before birth are five in number, and are each connected, as also shown by collateral evidence, with one or other particular species of sense-organ. And these regions have another character in common recognizable in the nerve-fibres entering and leaving them, namely, they possess fibres projected to or from parts of the nervous system altogether outside the cortex itself. These fibres are termed "projection" fibres. Other regions of the cortex possess fibres coming from or going to various regions of the cortex itself, but do not possess in addition, as do the five primitive cortical fields, the fibres of projection. So that the facts established by Flechsig for the regions of pallium, which other evidence already indicated as connected with the sense-organ, find support that evidence and bring the olfactory region of cortex into line with certain other regions of cortex similarly primarily connected with organs of sense.

It will be noted that what has been achieved by these various means of study in regard to the region of the cortex to which olfactory functions are attributed amounts at present to little more than the bare ascertainment of the existence there of nervous mechanisms connected with olfaction, and to the delimiting roughly of their extent and of their ability to influence certain movements, and in man sensations, habitually associated with exercise of the olfactory organ. As to what part the cortical mechanism has in the elaboration or association of mental processes to which olfaction contributes, no evidence worth the name seems as yet forthcoming. In this respect our knowledge, or rather our want of knowledge, of the functions of the olfactory region of the cortex, is fairly typical of that to which we have to confess in regard to the other regions of the cortex, even the best known.

Visual Region of the Cortex.—There is a region of the cortex especially connected with vision. The *optic nerve and tract* constitute the second link in the chain of neurones joining the retina to the brain. They may therefore be regarded as the equivalent of an intraspinal tract connecting the deep ends of the afferent neurones from the skin with higher nervous centres. In the bony fishes the optic tract reaches the grey matter of the optic lobe, a part of the mid-brain, to which the so-called anterior colliculus is equivalent in the mammalian brain. In the optic lobe the axones of the neurones of the optic tract meet neurones whose axones pass in turn to the motor neurones of the muscles moving the eyeballs, and also to other motor neurones. But in these fish the optic tract has no obvious connexion with the fore-brain or with any cerebral pallium. Ascending, however, to the reptilian brain is found an additional arrangement: a small portion of the optic tract passes to grey matter in front of the optic lobe. This grey matter is the lateral geniculate body. From this geniculate body a number of neurones extend to the pallial portion of the cerebrum, for in the reptilian brain the pallium is present. The portion of pallium connected with the lateral geniculate body lies above and behind the olfactory or archipallium. It is a part of what was mentioned above as neopallium.

In the mammalian brain the portion of the optic tract which goes to the optic lobe (*ant. colliculus* of the mammal) is dwarfed by great development of the part which goes to the geniculate body and an adjoining grey mass, the pulvinar (part of the optic thalamus). From these latter pass large bands of fibres to the occipital region of the neopallium. In mammals this visual region of the cortex is distinguished in its microscopic features from the cortex elsewhere by a layer of myelinated nerve-fibres, many of which are the axones of neurones of the geniculate body and pulvinar. Thus, whereas in the bony fishes all the third links of the conductive chain from the retina lead exclusively to the final neurones of motor centres for muscles, in the mammal the majority of the third links conduct to grey matter of the cortex cerebri.

The application of electric stimuli to the surface of the cortex does not for the greater part of the extent of the cortex evoke

in higher mammalian brains any obvious effect; no muscular act is provoked. But from certain limited regions of the cortex such stimulation does evoke muscular acts, and one of these regions is that to which the neurones forming the third link of the conductive chain from the retina pass. The muscular acts thus provoked from that region are movements of the eyeballs and of the neck turning the head. In the monkey the movement is the turning of both eyeballs and the head away from the side stimulated. In short, the gaze is directed as to an object on the opposite side. The newer conductive chain traceable through the cortex does therefore, after all, like the older one through the optic lobe, lead ultimately to the motor neurones of the eye muscles and the neck, only it takes a longer course thither and is undoubtedly much more complex. What gain is effected by this new and as it were alternative and longer route, which takes a path up to the cerebral cortex and down again, we can only conjecture, but of one point we may rest well assured, namely, that a much richer inter-connexion with other arcs of the nervous system is obtained by the path that passes via the cortex. The functional difference between the old conductive circuit and the new can at present hardly indeed be stated even in outline. A natural inference might be that the phylogenetically older and less complex path is concerned with functions purely reflex-motor, not possessing sensation as an attribute. But fish, which possess only the older path, can be trained to seize bait of one colour and not of another colour, even against what appeared to be an original colour-preference in them. Such discrimination individually acquired seems to involve memory, though it may be rudimentary in kind. Where motor reaction to visual stimuli appears to involve memory—and without memory the training could hardly be effective—some germ of consciousness can hardly be denied to the visual reactions, although the reactions occurred in complete absence of a cortical path and indeed of a visual cortex altogether.

Removal of the visual pallium in the tortoise produces little or no obvious defect in vision; but in the bird such a lesion greatly impairs the vision of the eye of the side opposite to the lesion. The impairment does not, however, amount to absolute blindness. Schrader's hawk, after removal of the pallium, reacted to movements of the mice with which it was caged. But the reactions were impaired: they lacked the sustained purpose of the normal reactions. The bird saw the mice; that was certain, for their movements across its field of vision made it turn its gaze towards them. But on their ceasing to move, the reaction on the part of the bird lapsed. Neither did their continuing to move excite the attack upon them which would have been the natural reaction on the part of the bird of prey towards its food. The bird apparently did not recognize them as prey, but saw them merely as moving objects. It saw them perhaps as things to which mental association gave no significance. Similarly, a dog after ablation of the occipital lobes of the cortex is able to see, for it avoids obstacles in its path; but if food is offered to it or the whip held up to it, it does not turn towards the food or away from the whip. It sees these things as if it saw them for the first time, but without curiosity, and as if it had no experience of their meaning. It gives no hint that it any longer understands the meaning of even familiar objects so long as these are presented to it through the sense of vision. Destruction of the visual cortex of one hemisphere alone produces in the dog impairment of vision, not as in the bird practically exclusively in the opposite eye, but in one lateral half of each eye, and that half the half opposite the hemisphere injured. Thus when the cortex destroyed is of the right cerebral hemisphere, the resultant visual defect is in the left half of the field of vision of both eyes. And this is so in man also.

In man disturbances of sensation can be better studied because it is possible to obtain from him his description of his condition. The relation of the *cortex cerebri* to human vision can be summarized briefly as follows. The visual cortex is distinguishable in higher mammals by a thin white stripe, the stripe of Gennari, seen in its grey matter when that is sectioned. This stripe results from a layer of nerve-fibres, many of which are

axons from the neurones of the lateral geniculate body and the pulvinar, the grey masses directly connected with the optic nerve-fibres. In the dog, and in such monkeys as the Macaque, the region of cortex containing this stripe traceable to optic fibres forms practically the whole occipital lobe. But in the man-like apes and in man this kind of cortex is confined to one region of the occipital lobe, namely, that of the calcarine fissure and the *cuneus* behind that. This region of cortex thus delimited in man is one of Flechsig's areas of earlier myelination. It is also one of his areas possessing projection fibres; and this last fact agrees with the yielding by this area, when under electrical stimulation, of movements indicating that impulses have been discharged from it into the motor neurones of the muscles of the eyes and neck. Evidence from cases of disease show that destruction of the cortex of the upper lip of the calcarine fissure, say in the right half of the brain, causes in man impairment in the upper right-hand quadrant of both retinæ: destruction of the lower lip of the fissure causes impairment in the lower right-hand quadrants. Destruction of the calcarine region of one hemisphere produces therefore "crossed hemianopia," that is, loss of the opposite half of the field of vision. But in this hemianopia the region of central vision is always spared. That is, the piece of visual field which corresponds with the yellow spot of the retina is not affected in either eye, unless the calcarine regions of both hemispheres are destroyed. This central point of vision is connected therefore not with one side of the brain only but with both.

The impairment of sight is more severe in men than in lower animals. Where the destruction of the visuo-sensory cortex in one calcarine region is complete, a candle-flame offered in the hemianopic field cannot even be perceived. It may hardly excite a reflex contraction of the pupil. In such cases the visual defect amounts to blindness. But this is a greater defect than is found in the dog even after entire removal of both occipital lobes. The dog still avoids obstacles as it walks. Its defect is rather, as said above, a complete loss of interest in the visual images of things. But a dog or monkey after loss of the visual cortex hesitates more and avoids obstacles less well in a familiar place than it does when entirely blind from loss of the peripheral organ of vision. In man extensive destruction of the visual cortex has as one of its symptoms loss of memory of localities, thus, of the paths of a garden, of the position of furniture, and of accustomed objects in the patient's own room. This loss of memory of position does not extend to spatial relations ordinarily appreciated by touch, such as parts of the patient's own person or clothing. There is nothing like this in the symptoms following blindness by loss of the eye itself. Those who lose their sight by disease of the retina retain good memorial pictures of positions and directions appreciated primarily by vision.

Cases of disease are on record in which loss of visual memory has occurred without hemianopia. Visual hallucinations referred to the hemianopic side have been observed. This suggests that the function of visual memory in regard to certain kinds of percepts must belong to localities of cortex different from those pertaining to other visual percepts. The area of cortex characterized by the stripe of Gennari occupies in man, as mentioned, the calcarine and cuneate region. It is surrounded by a cortical field which, though intimately connected with it by manifold conducting fibres, &c., is yet on various grounds distinct from it. This field of cortex surrounding the visuo-sensory of the calcarine-cuneate region is a far newer part of the neopallium than the region it surrounds. Both in the individual (Flechsig) and in the phylum (Bolton, Campbell, Mott) its development occurs far later than that of the visuo-sensory which it surrounds. Flechsig finds that it has no "projection" fibres, that is, that it receives none of the optic radiations from the lower visual centres and gives no centrifugal fibres in the reverse direction. This field encompassing the visuo-sensory region differs from the latter in its microscopic structure by absence of the lower layer of stellate cells and by the presence in it of a third or deep layer of pyramidal cells (Mott). Its fibres are on the average smaller than are those of the visuo-sensory

(W. A. Campbell). This zonal field is small in the lower apes, and hardly discoverable in the dog. In the anthropoid apes it is much larger. In man it is relatively much larger still. The impairment of visual memory and visual understanding in regard to direction and locality is said to be observed in man only when the injury of the cortex includes not only the calcarine-cuneate region but a wide area of the occipital lobe. From this it is argued that the zonal field is concerned with memories and recognitions of a kind based on visual perceptions. It has therefore been termed the *visuo-psychic* area. It is one of Flechsig's "association-areas" of the cortex.

Adjoining the antero-lateral border of the just-described *visuo-psychic* area lies another region separate from it and yet related to it. This area is even later in its course of development than is the visuo-psychic. It is one of Flechsig's "terminal fields" and its fibres are among the last to ripen in the whole cortex. This terminal field is large in man. It runs forward in the parietal lobe above and in the temporal lobe below. Its wide extent explains, in the opinion of Mott, the displacement of the visuo-sensory field from the outer aspect of the hemisphere in the lower monkeys to the median aspect in man. To this terminal field all the more interest attaches because it includes the angular gyrus, which authorities hold to be concerned with the visual memory of words. Study of diseased conditions of speech has shown that the power to understand *written* words may be lost or severely impaired although the words may be perfectly distinct to the sight and although the power to understand *heard* words remains good. This condition is asserted by many physicians to be referable to destruction of part of the angular gyrus. Close beneath the cortex of the angular gyrus runs a large tract of long fibres which pass from the visual cortex (see above) to the auditory cortex (see below) in the superior temporal gyrus and to the lower part of the frontal lobe. This lower part of the frontal lobe is believed—and has long been believed—to be concerned intimately with the production of the movements of speech. A difficulty besetting the investigation of the function of the angular gyrus is the fact that lesion of the cortex there is likely to implicate the underlying tract of fibres in its damage. It cannot be considered to have been as yet clearly ascertained whether the condition of want of recognition of seen words—"word-blindness"—is due to cortical injury apart from subcortical, to the angular gyrus itself apart from the underlying tract. Word-blindness seems, in the right-handed, to resemble the aphasia believed to be connected with the lower part of the frontal lobe, in that it ensues upon lesions of the left hemisphere, not of the right. In left-handed persons, on the contrary, it seems to attach to the right hemisphere.

Auditory Region of the Cortex.—Besides the two great organs of distance-receptors, namely, the nose and eye, whose cerebral apparatus for sensation has just been mentioned, those of a third great distance-receptor have to be considered. The agents of stimulation of the two former are respectively chemical (olfactory) and radiant (visual); the mode of stimulation of the third is mechanical, and the sensations obtained by it are termed auditory. Their cerebral localization is very imperfectly ascertained. Electric stimuli applied to a part of the uppermost temporal gyrus excites movements of the ears and eyes in the dog. Destruction of the same region when executed on both hemispheres is argued by several observers to impair the sense of hearing. To this region of cortex fibres have been traced from the lower centres connected with the nerve-fibres coming from the cochlea of the ear. From each cochlear nerve a path has been traced which passes to the *insulae* and the above-mentioned *temporal* region of cortex of both the cerebral hemispheres. The insula is a deeper-seated area of cortex adjoining the uppermost temporal convolution. To it Flechsig's chronological studies also impute a connexion with the nerves of the ear. Early myelination of fibres, presence of ascending and descending "projection" tracts to and from lower centres outside the cortex, calibre of fibres, microscopic characters of its cortical cells, all those kinds of indirect items of evidence that obtain

for the visual cortex likewise mark out this insular-temporal area as connected fairly directly with a special sense-organ, as in fact a sensory field of the cortex; and the suspicion is that it is auditory. Clinical observation supports the view in a striking way, but one requiring, in the opinion of some, further confirmation. It is widely believed that destruction of the upper and middle part of the uppermost temporal convolution produces "word-deafness," that is, an inability to recognize familiar words when heard, although the words are recognized when seen.

More precise information regarding this auditory region of the cortex has recently been obtained by the experiments of Kalischer. These show that after removal of this region from both sides of the brain in the dog the animal shows great defect in answering to the call of its master. Whereas prior to the operation the animal will prick its ears and attend at once to the lightest call, it requires after the removal of the auditory regions great loudness and insistence of calling to make it attend and react as it did. This is the more striking in view of other experimental results obtained. Kalischer trained a number of his dogs not to take meat offered them except at the sound of a particular note given by an organ pipe or a harmonium. The dogs rapidly learned not to take the food on the sounding of notes of other pitch than the one taught them as the permissive signal. This reaction on the part of the animal was not impaired by the removal of the so-called auditory regions of the cortex. Kalischer suggests that this reaction taught by training is not destroyed by the operation which so greatly impairs the common reaction to the master's call, because the former is a simpler process more allied to reflex action. In it the attention of the dog is already fastened upon the object, namely the food, and the stimulus given by the note excites a reaction which simply allows the act of seizing the food to take place, or on the other hand stops it. In the case of answering the call of the master the stimulus has to excite attention, to produce perception of the locality whence it comes, and to invoke a complicated series of movements of response. He finds that destruction of the posterior colliculi of the mid-brain, which have long been known to be in some way connected with hearing, likewise destroys the response to the call of the master, but did not destroy the trick taught to his dogs of taking meat offered at the sound of a note of one particular pitch but not at notes of other pitch given by the same instrument.

Other Senses and Localization in the Cortex Cerebri.—Turning now to the connexion between the function of the cortex and the senses other than those of the great distance-receptors just dealt with, even less is known. Disturbance and impairment of skin sensations are observable both in experiments on the cerebrum of animals and in cases of cerebral disease in man. But the localization in the cortex of regions specially or mainly concerned with cutaneous sensation has not been made sufficiently clear to warrant statement here. Still less is there satisfactory knowledge regarding the existence of cortical areas concerned with sensations originated in the alimentary canal. The least equivocal of such evidence regards the sense of taste. There is some slight evidence of a connexion between this sense and a region of the hippocampal gyrus near to but behind that related to smell.

As to the sensations excited by the numerous receptors which lie not in any of the surface membranes of the body but embedded in the masses of the organs and between them, the *proprioceptors*, buried in muscles, tendons and joints, there is little doubt that these sensations may be disturbed or impaired by injury of the *cortex cerebri*. They may probably also be excited by cortical stimulation. But evidence of localization of their seat in, and their details of connexion with, the cortex, is at present uncertain. Many authorities consider it probable that sensations of touch and the sensations initiated by the proprioceptors of muscles and joints (the organs of the so-called muscular sense) are specially related to the post-central gyrus and perhaps to the pre-central gyrus also. The clearest items on this point are perhaps the following.

Besides the regions instanced above, in the limbic (olfactory),

occipital (visual), and temporal (auditory) lobes, as exhibiting precocity of development, there is a region showing similar precocity in the fronto-parietal portion of the hemisphere. This is the region which in the Primates includes the large *central fissure* (sometimes called the fissure of Rolando). To it fibres are traced which seem to continue a path of conduction that began with afferent tracts belonging to the spinal cord, and tracts which there is reason to think conduct impulses from the receptor-organs of skin and muscles. The part of the cortex immediately behind the *central fissure* seems to be the main cortical goal for these upward-conducting paths. That *post-central* strip of cortex would in this view bear to these paths a relation similar to that which the occipital and temporal regions bear to afferent tracts from the retina and the cochlea. There are observations which associate impaired tactual sense and impaired perception of posture and movement of a limb with injury of the *central region* of the cortex. But there are a number also which show that the motor defect which is a well-ascertained result of injury of the *pre-central gyrus* is sometimes unaccompanied by any obvious defect either of touch or of muscular sense. It seems then that the motor centres of this region are closely connected with the centres for cutaneous and muscular sense, yet are not so closely interwoven with them that mechanical damage inflicted on the one of necessity heavily damages the other as well. There is evidence that the sensory cortex in this region lies posterior to that which has been conveniently termed the "motor." These latter in the monkey and the man-like apes and man lie in front of the central fissure: the sensory lie probably behind it. A. W. Campbell has found changes in the cortex of the post-central convolution ensuing in the essentially sensory disease, *leber dorsalis*, a disease in which degeneration of sensory nerve-fibres of the muscular sense and of the skin senses is prominent. He considers that in man and the man-like apes the part of the post-central gyrus which lies next to and enters into the *central fissure* is concerned with simpler sensual recognitions, while the adjoining part of that convolution farther back is a "psychic region" concerned with more complex psychosis connected with the senses of skin and muscle. His subdivision of the post-central gyrus is based on histological differences which he discovers between its anterior and its posterior parts and on the above-described analogous differentiation of a "sensory" from a "psychic" part in the visual region of cortex.

It will be noted that although certain regions of the cortex are found connected closely with certain of the main sense organs, there are important receptive organs which do not appear to have any special region of cortex assigned to their sensual products. Thus, there is the "vestibular labyrinth" of the ear. This great receptive organ, so closely connected in function with the movements and adjustment of the postures of the head and eyes, and indeed of the whole body, is prominent in the co-ordination necessary for the equilibrium of the body, an essential part of the fundamental acts of progression, standing, &c. Yet neither structural nor functional connexion with any special region of the cortex has been traced as yet for the labyrinthine receptors. Perceptions of the position of the head and of the body are of course part of our habitual and everyday experience. It may perhaps be that these perceptions are almost entirely obtained through sense organs which are not labyrinthine, but: visual, muscular, tactual, and so on. The labyrinth may, though it controls and adjusts the muscular activities which maintain the balance of the body, operate reflexly without in its operation exciting of itself sensations. The results of the unconscious reflexes it initiated and guided would be perceptible through other organs of sense. But against this purely unconscious functioning of the labyrinth and its nervous apparatus stands the fact that galvanic stimulation of the labyrinth is accompanied by well-known distinctive sensations—including giddiness, &c. Moreover, the prominent factor in sea-sickness, a disorder richly suffused with sensations, is probably the labyrinth. Yet there is marked absence of evidence of any special and direct connexion between the *cortex cerebri* and the labyrinth organs.

Also there is curiously little evidence of connexion of the cortex

with the nervous paths of conduction concerned with pain. As far as the present writer can find from reference to books and from the clinical experience of others, "pain" is unknown as an *aura* in cortical epilepsy, or at most is of equivocal occurrence.

The preceding brief exposition of some of the main features of the localization of function in the *cortex cerebri*, gradually deciphered by patient inquiry, shows that the scheme of partition of function so far perceptible does not follow the quaint lines of analysis of the phrenologists with their supposed mental entities, so-called "faculties." On the contrary it is based, as some of those who early favoured a differential arrangement of function in the cerebrum had surmised, on the *separateness of the incoming channels from peripheral organs of sense*. These organs fall into groups separate one from another not only by reason of their spatial differentiation at the surface and in the thickness of the body, but also because each group generates sensations which introspection tells us are of a species unbridgeably separate from those generated by the other groups. Between sensations of bearing and sensations of sight there is a dissimilarity across which no intermediate series of sensual phenomena extend. The two species of sensations are wholly disparate. Similarly there is a total and impassable gap between sensations of touch and sensations of sight and sound. In other words the sensations fall into groups which are wholly disparate and are hence termed species. But within each species there exist multifold varieties of the specific sensation, e.g. sensations of red, of yellow, &c. We should expect, therefore, that the conducting paths from the receptive organs which in their function as sense-organs yield wholly disparate sensations would in so far as subserving sensation diverge and pass to separate neural mechanisms. That these sense-organs should in fact be found to possess in the cortex of the cerebrum separate fields for their sensual nervous apparatus is, therefore, in harmony with what would be the *a priori* supposition.

But, as emphasized at the beginning of this article, the receptive organs belonging to the surfaces and the depths of the body and forming the starting-points for the whole system of the afferent nerves, have two functions more or less separate. One of these functions is to excite sensations and the other is to excite movements, by reflex action, especially in glands and muscles. In this latter function, namely the reflex function, all that the receptive organs effect is effected by means of the efferent nerves. They all have to use the efferent, especially the motor, nerves of the body. So rich is the connexion of the receptive organs with the efferent nerves that it is not improbable that, through the central nervous organ, each receptive organ is connected with every motor nerve of the whole nervous system,—the facts of strychnine poisoning show that if this is not literally true it is at least approximately so. Hence one of the goals to which each afferent fibre from a receptive organ leads is a number of motor nerves. Their conducting paths must, therefore, converge in passing to the starting-points of the motor nerves; because these latter are instruments common to the use of a number of different receptive organs in so far as they excite reflex actions. On the other hand those of their conducting paths which are concerned in the genesis of sensation, instead of converging, diverge, at least as far as the *cortex cerebri*, or if not divergent, remain separate. These considerations would make it appear likely that the conducting path from each receptive organ divides in the central nervous system into two main lines, one of which goes off to its own particular region of the *cortex cerebri* whither run conductors only of similar sensual species to itself, while the other main line passes with many others to a great motor station where, as at a telephone exchange, co-ordinate use of the outgoing lines is assured to them all. Now there is in fact a portion of the cortex in mammals the functions of which are so pre-eminently motor, as judged by our present methods, that it is commonly designated the *motor cortex* (see

fig. 24). This region of the cortex occupies in the Primates, including Man, the pre-central gyrus. Among the items of evidence which reveal its motor capabilities are the following.

The Precentral or Motor Region of the Cortex.—The application to it of electric currents excites movements in the skeletal muscles. The movements occur in the half of the body of the side crossed from that of the hemisphere excited. The "motor representation," as it is termed, is in the cortex better described as a representation of definite actions than of particular muscles. The actions "represented" in the top part of the gyrus, namely next the great longitudinal fissure, move the leg; those in the lowest part of the gyrus belong to the tongue and mouth. The topical distribution along the length of the gyrus may be described in a general way as following a sequence resembling that of the motor representation in the spinal cord, the top of the gyrus being taken as corresponding with the caudal end of the spinal cord. The sequence as the gyrus is followed downwards runs: perineum, foot, knee, hip, abdomen, chest, shoulder, elbow, wrist, hand, eyelids and ear, nose, mouth and tongue. The nature of the movement is very fairly constant for separate

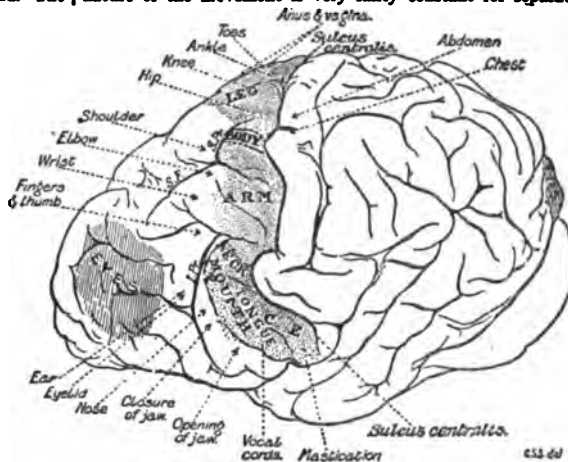

FIG. 24.—Diagram of the Topography of the Main Groups of Foci in the Motor Field of Chimpanzee.

points of this motor cortex as observed both in the same and in similar experiments. Thus flexion of the arm will be excitable from one set of points, and extension of the arm from another set of points; opening of the jaw from one set and closure from another, and so on. These various movements if excited strongly tend to have characters like those of the movements seen in an epileptic convulsion. Strong stimulation excites in fact a convulsion like that of epilepsy, beginning with the movement usual for the point stimulated and spreading so as to assume the proportions of a convulsion affecting the entire skeletal musculature of one half or even of the whole body. The resemblance to an epileptic seizure is the closer because the movement before it subsides becomes clonic (rhythmic) as in epilepsy. The determination of the exact spots of cortex in which are represented the various movements of the body has served a useful practical purpose in indicating the particular places in the cortex which are the seat of disease. These the physician can localize more exactly by reason of this knowledge. Hence the surgeon, if the nature of the disease is such as can be dealt with by surgical means, can without unnecessarily damaging the skull and brain, proceed directly to the point which is the seat of the mischief.

The motor representation of certain parts of the body is much more liberal than is that of others. There is little correspondence between the mere mass of musculature involved and the area of the cortex devoted to its representation. Variety of movement

rather than force or energy of movement seems to demand extent of cortex. The cortical area for the thumb is larger than those for the whole abdomen and chest combined. The cortical area for the tongue is larger than that for the neck. Different movements of one and the same part are very unequally represented in the cortex. Thus, flexion of the leg is more extensively represented than is extension, opening of the jaw has a much larger cortical area than has closure of the jaws. It is interesting that certain agents, for instance strychnine, and the poison of the bacilli which cause the disease known as tetanus or lock-jaw, upset this normal topography, and replace in the cortex flexion of the limb by extension of the limb, and opening of the jaw by closure of the jaw. There is, however, no evidence that they do this by changing in any way the cortical mechanisms themselves. It is more likely that their action is confined to the lower centres, bulbar and spinal, upon which the discharge excited from the cortex plays. The change thus induced in the movement excited by the cortex does, however, show that the point of cortex which causes for instance opening of the mouth is connected with the motor nerves to the closing muscles as well as with those of the opening muscles. This is an item of evidence that the "centres" of the cortex are connected with the motor nerves of antagonistic muscles in such a way that when the "centre" excites one set of the muscles to contract, it simultaneously under normal circumstances causes inhibition of the motor neurones of the opposed set of muscles (reciprocal innervation). In the great majority of movements excited from the motor cortex of a single hemisphere of the cerebrum, the movement evoked is confined to one side of the body, namely to that opposite to the hemisphere stimulated. There are, however, important exceptions to this. Thus, adduction of both vocal cords is excited from the cortex of either hemisphere. The movement of closure of the eyelids is usually bilateral, unless the stimulation be very weak; then the movement is of the eyelids of the opposite side only. The same holds true for the movements of the jaw. It, therefore, seems clear that with many movements which are usually bilaterally performed in ordinary life, such as opening of the jaw, blinking, &c., the symmetrical areas of the motor regions of both hemispheres are simultaneously in action.

In regard to all these movements elicitable by artificial stimuli from the motor cortex it is obvious that were there clearer evidence that the pallid region from which they are elicitable is fairly directly connected with corticopetal paths subserving cutaneous sensation or "muscular sense," the movements might be regarded as falling into the category of higher reflexes connected with the organs of touch, muscular sense, &c., just as the movements of the eyeball excitable from the visual cortex may be regarded as higher reflexes connected with vision. The evidence of the connexion of the reactions of the motor cortex with cutaneous and muscular senses appears, however, scarcely sufficient to countenance at present this otherwise plausible view, which has on general grounds much to commend it.

It is remarkable that movements of the eyeball itself, *i.e.* apart from movement of the lids, are not in the category of movements elicitable from the precentral gyrus, the "motor" cortex. They are found represented in a region farther forward, namely in front of the precentral gyrus altogether, and occupying a scattered set of points in the direction frontal from the areas for movements of arm and face. This frontal area yields on excitation conjugate movements of both eyeballs extremely like if not exactly similar to those yielded by excitation of the occipital (visual) region of the cortex. It is supposed by some that this frontal area yielding eye-movements has its function in this respect based upon afferent conductors from other parts of the eyeball than the retina, for instance upon kinaesthetic (Bastian) impressions or upon sensual impressions derived from the cornea and the coats of the eyeball including the ciliary and iris muscles. The ocular muscles are certainly a source of centripetal impulses, but their connexion with the cortex is not clear as to either their nature or their seat. The question seems for the present to allow no clearer answer. It is certain, however, that the frontal area of eye movements has corticofugal paths

descending from it to the lower motor centres of the eyeballs quite independent of those descending from the occipital (visual) area of eye-movements. Further, it seems clear that in many animals there is another cortical region, a third region, the region which we saw above might be considered auditory, where movements of the eyeball similar to those elicitable in the occipital and frontal cortex can be provoked. A. Tschermak is inclined to give the eyeball movements of the frontal region the significance of reflex movements which carry the visual field in various directions in answer to demands made by sensory data derived from touch, &c., as for instance from the hand. The movements of the eyeballs elicitable from the occipital region of the cortex he regards as probably concerned with directing the gaze toward something seen, for instance, in the peripheral field of vision. The occipital movement would, therefore, be excited through the retina, and would result in bringing the yellow spot region of the retinae of both eyes to bear upon the object. This view has much to justify it. The movements of the eyeballs excited from the cortex of the auditory region would in a similar way be explicable as bringing the gaze to bear upon a direction in which a sound had been located, auditory initiation replacing the visual and tactual of the occipital and the frontal regions respectively.

Turning from these still speculative matters to others less suggestive but of actual ascertainment, we find that the motor nature of the precentral cortex as ascertained by electric stimuli is further certified by the occurrence of disturbance and impairment of motor power and adjustment following destruction of that region of the cortex. The movements which such a part as a limb executes are of course manifold in purpose. The hind limb of a dog is used for standing, for stepping, for scratching, for squatting, and, where a dog, for instance, has been trained to stand or walk on its hind legs alone, for skilled acts requiring a special training for their acquisition. It is found that when the motor area of the brain has been destroyed, the limb is at first paralysed for all these movements, but after a time the limb recovers the ability to execute some of them, though not all. The scratching movement suffers little, and rapid improvement after cerebral injury soon effaces the impairment, at first somewhat pronounced, in the use of the limb for walking, running, &c., and ordinary movements of progression. Even when both hemispheres have been destroyed the dog can still stand and walk and run. Destruction of the motor region of the cortex renders the fore limbs of the dog unable to execute such skilled movements as the steadying of a bone for gnawing or the trained act of offering the paw in answer to the command of the master. Skilled acts of the limb, apart from conjoined movements in which it, together with all the other limbs, takes part, assume of course a larger share of the office of the limb in the Primates than in the dog; and this is especially true for the fore limb. It is when the fore-foot becomes a hand that opportunity is given for its more skilled individual use and for its training in movements as a tool, or for the handling of tools and weapons. It is these movements which suffer most heavily and for the longest period after injury of the motor region of the cortex. Hence the disablement ensuing upon injury to the cortex would be expected to be most apparent in the Primates; and it is so, and most of all in Man. Further, in Man there ensues a condition called "contracture," which is not so apparent or frequent a result in other animals,—indeed, does not occur at all in other animals except the monkey. In contracture the muscles of the paretic limb are not flaccid, as they are usually in paralysis, but they are tense and the limb is more or less rigidly fixed by them in a certain position, usually one of flexion at elbow and wrist. This condition does not occur at first, but gradually supervenes in the course of a number of weeks. In Man the destruction of the motor area of the cortex cripples the limb even for the part it should play in the combined limb movements of walking, &c., and cripples it to an extent markedly contrasting with the slight disturbances seen in the lower mammals, *e.g.* the dog.

As regards the recovery of motor power after lesions of the

motor cortex, two processes seem at work which are termed respectively *restitution* and *compensation*. By the former is understood the recovery obtained when a part of a "centre" is destroyed, and the rest of the centre, although thrown out of function at first, recovers and supplements the deficiency later. An example of restitution would be the recovery from temporary hemianopia caused by a small injury in one occipital lobe. By compensation is understood the improvement of an impaired nervous function, traceable to other centres different from those destroyed supplying means to compass the reaction originally dependent on the centres subsequently destroyed. Instances of such compensation are the recovery of taxis for equilibrium subsequent to destruction of the labyrinth of the ear, where the recovery is traceable to assistance obtained through the eye. It will be noted that these instances of recovery by restitution and by compensation respectively are taken from cases of injury inflicted on receptive rather than on motor centres. It is doubtful how far they really apply to the undoubted improvement that does within certain limits progress and succeed in partially effacing the paresis immediately consequent on lesions of the motor area. It has to be remembered that in all cases of traumatic injury to the nervous system, especially where the trauma implicates the central nervous organ, the first effects and impairment of function resulting are due to a mixed cause, namely on the one hand the mechanical rupture of conducting paths actually broken by solution of their continuity, and on the other hand the temporary interruption of conducting paths by "shock." Shock effects are not permanent: they pass off. They are supposed to be due to a change at the synapses connecting neurone with neurone in the grey matter. They amount in effect to a long-lasting and gradually subsiding inhibition.

For diseases of the brain see NEUROPATHOLOGY, INSANITY, SKULL (Surgery), &c. (C. S. S.)

BRAINERD, DAVID (1718-1747), American missionary among the Indians, was born at Haddam, Connecticut, on the 20th of April 1718. He was orphaned at fourteen, and studied for nearly three years (1739-1742) at Yale. He then prepared for the ministry, being licensed to preach in 1742, and early in 1743 decided to devote himself to missionary work among the Indians. Supported by the Scottish "Society for Promoting Christian Knowledge," he worked first at Kaunaumeeek, an Indian settlement about 20 m. from Stockbridge, Massachusetts, and subsequently, until his death, among the Delaware Indians in Pennsylvania (near Easton) and New Jersey (near Cranbury). His heroic and self-denying labours, both for the spiritual and for the temporal welfare of the Indians, wore out a naturally feeble constitution, and on the 19th of October 1747 he died at the house of his friend, Jonathan Edwards, in Northampton, Massachusetts.

His *Journal* was published in two parts in 1746 by the Scottish Society for Promoting Christian Knowledge; and in 1749, at Boston, Jonathan Edwards published *An Account of the Life of the Late Rev. David Brainerd, chiefly taken from his own Diary and other Private Writings*, which has become a missionary classic. A new edition, with the *Journal* and Brainerd's letters embodied, was published by Sereno E. Dwight at New Haven in 1822; and in 1884 was published what is substantially another edition, *The Memoirs of David Brainerd*, edited by James M. Sherwood.

BRAINERD, a city and the county-seat of Crow Wing county, Minnesota, U.S.A., on the E. bank of the Mississippi river, about 127 m. N.W. of Minneapolis. Pop. (1890) 5703; (1900) 7524, of whom 2193 were foreign-born; (1905) 8133; (1910) 8526. It is served by the Minnesota & International and the Northern Pacific railways. The latter maintains here large car and repair shops, and a sanatorium for its employees. There are also the Sisters of St Joseph hospital, a county court house, a public library and a Y.M.C.A. building. A dam across the Mississippi provides water power (about 60,000 H.P.) which is utilized extensively for manufacturing purposes. Lumbering is an important industry, and there are saw mills and planing mills, and an extensive crosscut plant for treating railway ties and timber. There are also flour mills, paper and pulp mills, cigar factories, a brewery, a large foundry and a grain elevator. In

1906 large quantities of iron ore were discovered in the vicinity, the new range, the Cuyuna, running through the city from north-east to south-west. Brainerd, named in honour of David Brainerd, was settled in 1870, and chartered as a city in 1883.

BRAINTREE, a market town in the Maldon parliamentary division of Essex, England; 45 m. N.E. of London by a branch line from Witham of the Great Eastern railway. Pop. of urban district, 5330. The parish church of St Michael is a fine edifice of Early English work with later additions. A corn exchange, mechanics' institute and public hall may also be mentioned. The bishops of London had formerly a palace in the town, but there are no remains of the building. The manufactures of silk and crape have superseded that of woollen cloth, which was introduced by the Flemings who fled to England to escape the persecution of the duke of Alva. Matting and brushes are also made. On the north lies the large village of **BOCKING**, with the Perpendicular parish church of St Mary, similar industries, and a population of 3347.

BRAINTREE, a township of Norfolk county, Massachusetts, U.S.A., on the Monaquot river about 10 m. S. of Boston. Pop. (1890) 4848; (1900) 5981, including 1250 foreign-born; (1905, state census) 6879; (1910) 8066. The New York, New Haven & Hartford railway crosses the town and has stations at its villages of Braintree, South Braintree and East Braintree, which are also served by suburban electric railways. In South Braintree are the Thayer Academy (co-educational; opened 1877) and the Thayer public library, both founded by and named in honour of General Sylvanus Thayer (1785-1872), a well-known military engineer born in Braintree, who was superintendent of the United States Military Academy in 1817-1833 and has been called the "father of West Point." There are large shoe factories and other manufactories. Bog iron was early found in Braintree, and iron-works, among the first in America, were established here in 1644. Braintree was first incorporated in 1640 from land belonging to Boston and called Mount Wollaston, and was named from the town in England. At Merry Mount, in that part of Braintree which is now Quincy, a settlement was established by Thomas Morton in 1625, but the gay life of the settlers and their selling rum and firearms to the Indians greatly offended the Pilgrims of Plymouth, who in 1627 arrested Morton; soon afterward Governor John Endecott of Massachusetts Bay visited Merry Mount, rebuked the inhabitants and cut down their Maypole. Later the place was abandoned, and in 1634 a Puritan settlement was made here. In 1708 the town was divided into the North Precinct and the South Precinct, and it was in the former, now Quincy, that John Adams, John Hancock and John Quincy Adams were born. Quincy was separated from Braintree in 1792 (there were further additions to Quincy from Braintree in 1856), and Randolph in 1793.

See D. M. Wilson, *Quincy, Old Braintree and Merry Mount* (Boston, 1906); C. F. Adams, Jr., *Three Episodes of Massachusetts History* (Boston, 1892 and 1896); W. S. Pattee, *History of Old Braintree and Quincy* (Quincy, 1878).

BRAKE, a town of Germany, in the grand duchy of Oldenburg, on the left bank of the Weser, about halfway between Bremen and the mouth of the river. Pop. 5000. It was for centuries the port of Bremen; and though, since the founding of Bremerhaven, it no longer possesses a monopoly of the river traffic as before, it still continues to flourish. Large docks have been constructed, and the place has a considerable import trade in English coal. Shipbuilding and weaving are carried on to some extent.

Brake in Oldenburg must be distinguished from the village of the same name in the principality of Lippe, known as Brake bei Limgo, which gave its name to the cadet line of the counts of Lippe-Brake (1621-1700).

BRAKE (1) A term for rough-tangled undergrowth, connected, according to the *New English Dictionary*, with "break," to separate. The "brake-fern" (*Pteris aquilina*) is the common "bracken," and is a shortened form of that northern Eng. word, derived from a Scand. word for "fern" (cf. Swed. *bråken*), though often confused with "brake," undergrowth. (2) A term

applied to many implements and mechanical and other appliances, often spelled "break." Here there are probably several words, difficult to separate in origin, connected either with "break," to separate, and its derived meanings, or with the *Fr. braquer* (appearing in such expressions as *braquer un canon*, to turn or point a gun), from *O. Fr. bras*, modern *bras*, an arm, Lat. *bracchium*. The word is thus used of a toothed instrument for separating the fibre of flax and hemp; of the "break-rolls" employed in flax manufacture; of a heavy wheeled vehicle used for "breaking in" horses, and hence of a large carriage of the wagonette type; of an arm or lever, and so of the winch of a crossbow and of a pump handle, cf. "brake-pump"; of a curb or bridle for a horse; and of a mechanical appliance for checking the speed of moving vehicles, &c. It is noteworthy that the two last meanings are also possessed by the *Fr. frein* and the *Ger. Bremse*.

Brakes, in engineering, are instruments by means of which mechanical energy may be expended in overcoming friction. They are used for two main classes of purpose: (1) to limit or decrease the velocity of a moving body, or to bring it completely to rest; and (2) to measure directly the amount of frictional resistance between two bodies, or indirectly the amount of energy given out by a body or bodies in motion. Machines in which brakes are employed for purposes of the second class are commonly known as dynamometers (*q.v.*). The other class is exemplified in the brakes used on wheeled vehicles and on cranes, lifts, &c. Here a body, or system of bodies, originally at rest, has been set in motion and has received acceleration up to a certain velocity, the work which has been done in that acceleration being stored up as "actual energy" in the body itself. Before the body can be brought to rest it must part with this energy, expending it in overcoming some external resistance. If the energy be great in proportion to the usual resistance tending to stop the body, the motion will continue for a long time, or through a long distance, before the energy has been completely expended and the body brought to rest. But in certain cases considerations of safety or convenience require that this time or distance be greatly shortened, and this is done by artificially increasing the external resistance for the time being, by means of a brake.

A simple method of obtaining this increased resistance is by pressing a block or shoe of metal or wood against the rim of a moving wheel, or by tightening a flexible strap or band on a rotating pulley or drum. In wheeled road vehicles, a wheel may be prevented from rotating by a chain passed through its spokes and attached to the body of the vehicle, when the resistance is increased by the substitution of a rubbing for a rolling action; or the same effect may be produced by fixing a slipper or skid under the wheel. Other forms of brake depend, not on the friction between two solid bodies, but on the frictional resistance of a fluid, as in "fan" and "pump" brakes. Thus the motion of revolving blades may be opposed by the resistance of the air or of a liquid in which they are made to work, or the motion of a plunger fitting tightly in a cylinder filled with a fluid may be checked by the fluid being prevented from escape except through a narrow orifice. The fly used to regulate the speed of the striking train in a clock is an example of a fan brake, while a pump brake is utilized for controlling the recoil of guns and in the hydraulic buffers sometimes fitted at terminal railway stations to stop trains that enter at excessive speed. On electric tramcars a braking effect is sometimes obtained by arranging the connexions of the motors so that they act as generators driven by the moving car. In this way a counter-torque is exerted on the axles. The current produced is expended by some means, as by being made to operate some frictional braking device, or to magnetize iron shoes carried on the car just over, but clear of, the running rails, to which they are then magnetically attracted (see TRACTION).

The simplest way of applying a brake is by muscular force, exerted through a hand or foot lever or through a screw, by which the brake block is pressed against the rim of the wheel or the band brake tightened on its drum. This method is sufficient in the case of most road vehicles, and is largely used on railway

vehicles. But the power thus available is limited, and becomes inadequate for heavy vehicles moving at high speeds. Moreover, on a train consisting of a number of vehicles, the hand brakes on each of which are independent of all others, either a brakeman must be carried on each, or a number of the brakes must be left unused, with consequent loss of stopping power; while even if there is a brakeman on every vehicle it is impossible to secure that all the brakes throughout the train are applied with the promptness that is necessary in case of emergency.

Considerations of this sort led to the development of power brakes for railway trains. Of these there are five main classes:—

(1) Mechanical brakes, worked by springs, friction wheels on the axle, chains wound on drums, or other mechanical devices, or by the force produced when, by reason of a sudden checking of the speed of the locomotive, the momentum of the cars causes pressure on the draw-bars or buffing devices. (2) Hydraulic brakes, worked by means of water forced through pipes into proper mechanism for transmitting its force to the brake-shoes. (3) Electric brakes. (4) Air and vacuum brakes, worked by compressed air or by air at atmospheric pressure operating on a vacuum. (5) Brakes worked by steam or water from the boiler of the engine, operating by means of a cylinder; the use of these is generally limited to the locomotive. Of this kind is the counter-pressure or water brake of L. le Chatelier. If the valve gear of a locomotive in motion be reversed and the steam regulator be left open, the cylinders act as compressors, pumping air from the exhaust pipe into the boiler against the steam pressure. A retarding effect is thus exercised, but at the cost of certain inconveniences due to the passage of hot air and cinders from the smoke box through the cylinders. To remedy these, le Chatelier arranged that a jet of hot water from the boiler should be delivered into the exhaust pipe, so that steam and not the hot flue gases should be pumped back.

Power brakes may be either continuous or independent—continuous if connected throughout the train and with the locomotive by pipes, wires, &c., as the compressed air, vacuum and electric brakes; independent if not so connected, as the buffer-brakes and hand-brakes. Continuous brakes may be divided into two other great classes—automatic and non-automatic. The former are so arranged that they are applied automatically on all the coaches of the train if any important part of the apparatus is broken, or the couplings between cars are ruptured; in an emergency they can be put on by the guard, or (in some cases) by a passenger. Non-automatic brakes can be applied only by the person (usually the engine-driver) to whom the management of them is given; they may become inoperative on all the coaches, and always on those which have become detached, if a coupling or other important and generally essential part is broken. Many mechanical and several hydraulic and electrical continuous brakes have been invented and tried; but experience has shown them so inadequate in practice that they have all practically disappeared, leaving the field to the air and the vacuum brakes. At first these were non-automatic, but in 1872 the automatic air-brake was invented by George Westinghouse, and the automatic vacuum-brake was developed a few years later.

Those respects in which non-automatic brakes are inadequate will be understood from the following summary of the requirements most important in a train-braking apparatus: (1) It must be capable of application to every wheel throughout the train. (2) It must be so prompt in action that the shortest possible time shall elapse between its first application and the moment when the full power can be exerted throughout the train. (3) It must be capable of being applied by the engine-driver or by any of the officials in charge of the train, either in concert or independently. (4) The motion of the train must be arrested in the shortest possible distance. (5) The failure of a vital part must declare itself by causing the brake to be applied and to remain applied until the cause of failure is removed. (6) The breaking of the train in two or more parts must cause immediate automatic application of the brakes on all the coaches. (7)

When used in ordinary service stops it must be capable of gradual and uniform application (followed, if necessary, by a full emergency application at any part of the service application) and of prompt release under all conditions of application. (8) It must be simple in operation and construction, not liable to derangement, and inexpensive in maintenance.

The Westinghouse non-automatic or "straight" air-brake, patented in 1859, consists in its simplest form of a direct-acting, steam-driven air-pump, carried on the locomotive, which forces compressed air into a reservoir, usually placed under the foot-plate of the locomotive. From this reservoir a pipe is led through the engine cab, where it is fitted with a three-way cock, to the rear of the locomotive tender, where it terminates in a flexible hose, on the end of which is a coupling. The coaches are furnished with a similar pipe, having hose and coupling at each end, which communicates with one end of a cylinder containing a piston, to the rod of which the brake-rods and levers are connected. The application of the brakes is effected by the engine-driver turning the three-way cock, so that compressed air flows through the pipe and, acting against one side of the brake-cylinder piston, applies the brake-shoes to the wheels by the movement of this piston and the rods and levers connected to it. To release the brakes the three-way cock is turned to cut off communication between the main reservoir and the train-pipe, and to open a port permitting the escape of the compressed air in the train-pipe and brake-cylinders. This brake was soon found defective and inadequate in many ways. An appreciable time was required for the air to flow through the pipes from the locomotive to the car-cylinders, and this time increased quickly with the length of the trains. Still

discharges air from the train-pipe, this equilibrium is destroyed, and the greater pressure in the auxiliary reservoir forces the triple-valve to a position which allows air from the auxiliary reservoir to pass directly into the brake-cylinder. This air forces out the piston of the brake-cylinder and applies the brakes, connection being made with the brake-rigging at R. The purpose of the small groove *s* which establishes communication between the two sides of the piston when the brakes are off, is to prevent their unintended application through slight leakage from the train-pipe. To release the brakes, the driver, by moving the handle of his valve to the release position, admits air from the main reservoir to the train-pipe, the pressure in which thus becomes greater than that in the auxiliary reservoir; the piston and slide-valve of the triple-valve are thereby forced back to their normal position, the compressed air in the brake-cylinder is discharged, and the piston is brought back by the coiled spring, thus releasing the brakes. At the same time the auxiliary reservoir is recharged.

With this "ordinary" brake, since an appreciable time is required for the reduction of pressure to travel along the train-pipe from the engine, the brakes are applied sensibly sooner at the front than at the end of the train, and with long trains this difference in the time of application becomes a matter of importance. The "quick-acting" brake was introduced to remedy this defect. For it the triple valve is provided with a supplementary mechanism, which, when the air pressure in the train-pipe is suddenly or violently reduced, opens a passage whereby air from the train-pipe is permitted to enter the brake-cylinder directly. The result is twofold: not only is the pressure from the auxiliary reservoir acting in the brake-cylinder reinforced by the pressure in the train-pipe, but the pressure in the train-pipe is reduced locally in every vehicle in extremely rapid succession instead of at the engine only, and

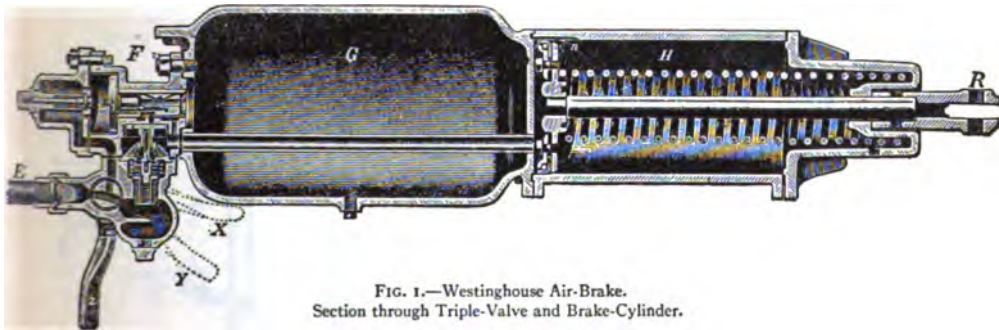

FIG. 1.—Westinghouse Air-Brake.
Section through Triple-Valve and Brake-Cylinder.

more objectionable, however, was the fact that on detached coaches the air-brakes could not be applied, the result being sometimes serious collisions between the front and rear portions of the train.

In the Westinghouse "ordinary" automatic air-brake a main air reservoir on the engine is kept charged with compressed air at 80 lb per sq. in. by means of the steam-pump, which may be controlled by an automatic governor. On electric railways a pump, driven by an electric motor, is generally employed; but occasionally, on trains which run short distances, no pump is carried, the main reservoir being charged at the terminal points with sufficient compressed air for the journey. Conveniently placed to the driver's hand is the driver's valve, by means of which he controls the flow of air from the main reservoir to the train-pipe, or from the train-pipe to the atmosphere. A reducing-valve is attached to the driver's valve, and in the normal or running position of the latter reduces the pressure of the air flowing from the main reservoir to the train-pipe by 10 or 15 lb per sq. in. From the engine a train-pipe runs the whole length of the train, being rendered continuous between each vehicle and between the engine and the rest of the train by flexible hose couplings. Each vehicle is provided with a brake-cylinder H (fig. 1), containing a piston, the movement of which applies the brake blocks to the wheels, an "auxiliary air-reservoir" G, and an automatic "triple-valve" F. The auxiliary reservoir receives compressed air from the train-pipe and stores it for use in the brake-cylinder of its own vehicle, and both the auxiliary reservoir and the triple-valve are connected directly or indirectly with the train-pipe through the pipe E. The automatic action of the brake is due to the construction of the triple-valve, the principal parts of which are a piston and slide-valve, so arranged that the air in the auxiliary reservoir acts at all times on the side of the piston to which the slide-valve is attached, while the air in the train-pipe exerts its pressure on the opposite side. So long as the brakes are not in operation, the pressures in the train-pipe, triple-valve and auxiliary reservoir are all equal, and there is no compressed air in the brake-cylinder. But when, in order to apply the brake, the driver

in consequence all the brakes are applied almost simultaneously throughout the train. The same effect is produced should the train break in two, or a hose or any part of the train-pipe burst; but during ordinary or "service" stops the triple-valve acts exactly as in the ordinary brake, the quick-acting portion, that is, the vertical piston and valve seen in fig. 1, not coming into operation. When the handle Z is turned to the position X the quick-acting mechanism is rendered inoperative, and when it is at Y the brake on the vehicle concerned is wholly cut out of action.

A further improvement introduced in the Westinghouse brake in 1906 was designed to give quick action for service as well as emergency stops. In this the triple-valve is substantially the same as in the ordinary brake. The additional mechanism of the quick-acting portion is dispensed with, but instead, a small chamber, normally containing air at atmospheric pressure, is provided on each vehicle, and is so arranged that it is put into communication with the train-pipe by the first movement of the triple-valve. As soon, therefore, as the driver, by lowering the pressure in the train-pipe, causes the triple-valve in the foremost vehicle of the train to operate, a certain quantity of air rushes out of the train-pipe into the small chamber; a further local reduction in the pressure of the train-pipe in that vehicle is thereby effected, and this almost instantaneously actuates the triple-valve of the succeeding vehicle, and so on throughout the train. In this way, on a train 1800 ft. long, consisting of sixty 30-ft. vehicles, the brake-blocks may be applied, with equal force, on the last vehicle about 24 seconds later than on the first.

Brake-blocks can be applied, without skidding the wheels, with greater pressure at high speeds than at low. Advantage is taken of this fact in the design of the Westinghouse "high-speed" brake, invented in 1894, which consists of attachments enabling the pressure in the train-pipe and reservoirs to be increased at the will of the driver. The increased pressure acting in the brake-cylinder increases in the same proportion the pressure of the brake-shoes against the wheels. Attached to the brake cylinder is a valve for automatically reducing

Automatic
air-brake.

High-
speed air-
brake.

the pressure therein proportionately to the reduction in speed, until the maximum pressure under which the brakes are operated in making ordinary stops is reached, when this valve closes and the maximum safe pressure for operating the brakes at ordinary speeds is retained until a stop is made.

In the automatic vacuum-brake, the exhausting apparatus generally consists of a combined large and small ejector (a form of jet-pump) worked by steam and under the control of the driver, though sometimes a mechanical air-pump, driven from the crosshead of the locomotive, is substituted for the small ejector. These ejectors, of which the small one is at work continuously while the large one is only employed when it is necessary to create vacuum quickly, e.g. to take off the brakes after a short stop, produce in the train-pipe a vacuum equal to about 20 in. of mercury, or in other words reduce the pressure within it to about one-third of an atmosphere. The train-pipe extends the whole length of the train and communicates under each vehicle with a cylinder, to the piston of which, by suitable rods and levers, the brake-shoes are connected. The communication between the train-pipe and the cylinder is controlled by a ball-valve, one form of which is shown in fig. 2. The release-valve is for the purpose of

unmoved; but with a sudden one the vacuum below the valve is destroyed more quickly, and with the difference of pressure the diaphragm lifts the valve and admits air. A rapid-acting valve (fig. 3) is sometimes interposed between the train-pipe and the cylinder on each vehicle. In the normal or running position, a vacuum is maintained below the valve A and above the diaphragm B, while the chamber below B and above A is at atmospheric pressure. For an emergency application of the brake, air is suddenly admitted to the train-pipe and thus to the lower side of A, and the pressure acting on the under side of B is sufficient to cause it to lift the valve A, and to admit air from the atmosphere, both to the brake-cylinder and the train-pipe, through the clappet-valve D, which also rises because of the difference of pressure on its two sides. In a graduated application, neither D nor A rises from its seat, but air from the train-pipe finds access to the brake-cylinder by passing around the peg C, which is so proportioned as to allow the necessary amount of air to enter the brake-cylinder, and so obtain simultaneous action of the brake throughout the train. When the handle E is turned so as to prevent the clappet D from rising, the rapid action is cut out and the brake acts as an ordinary vacuum automatic brake. A modification of the device for obtaining accelerated action, described

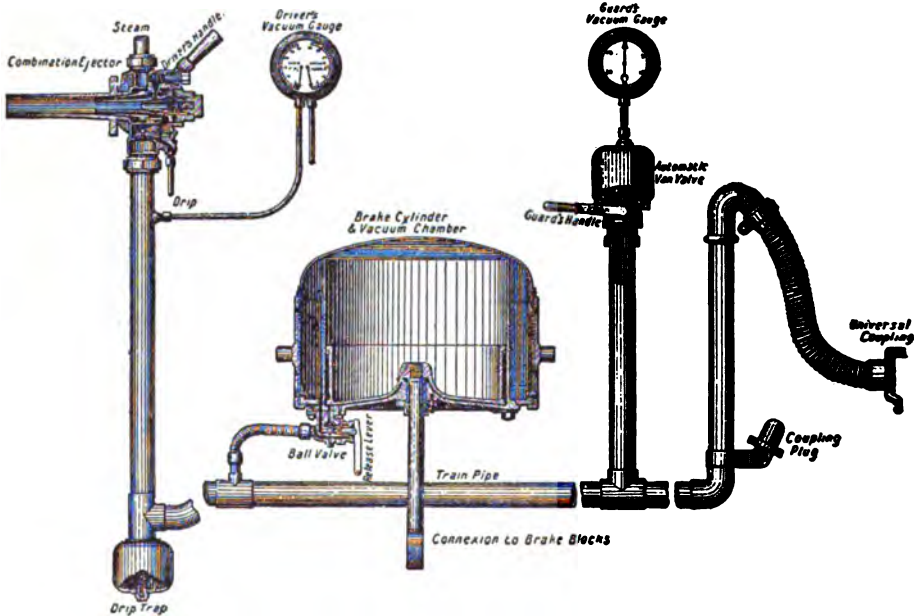

FIG. 2.—Automatic Vacuum-Brake, showing its general arrangement.

withdrawing the ball from its seat when it is necessary to take off the brakes by hand; it is made air-tight by a small diaphragm, the pressure of which, when there is vacuum in the pipe, pulls in the spindle and allows the ball to fall freely into its seat. When air is exhausted through the train-pipe it travels out from below the piston direct, and from above it past the ball, which is thus forced off its seat, to roll back again when the exhaustion is complete. In this state of affairs the piston is held in equilibrium and the brake-blocks are free of the wheels. To apply them, air is admitted to the train-pipe, either purposely by the guard or driver, or accidentally by the rupture of the train-pipe or coupling-hose between the vehicles. The air passes to the lower side of the piston, but is prevented from gaining access to the upper side by the ball-valve which blocks the passage; hence the pressure becomes different on the two sides of the piston, which in consequence is forced upwards and thus applies the brakes. They are released by the re-establishment of equilibrium (by the use of the large ejector if necessary); when this is done the piston falls and the brakes drop off. The general arrangement of the apparatus is shown in fig. 2. To render the application of the brakes nearly simultaneous throughout a long train, the valve in the guard's van is arranged to open automatically when the driver suddenly lets in air to the train-pipe. This valve has a small hole through its stem, and is secured at the top by a diaphragm to a small dome-like chamber, which is exhausted when a vacuum is created in the train-pipe. A gradual application destroys the vacuum in the chamber as quickly as in the pipe and the diaphragm remains

above in connexion with the Westinghouse brake, is also applicable. Accelerating chambers, again containing air at atmospheric pressure, are provided on each vehicle and are connected with the train-pipe by valves which open as the vacuum in the latter begins to decrease with the operation of the driver's valve. The air thus admitted into the train-pipe effects a still further local reduction of the vacuum, which is sufficient to actuate the accelerating valve of each next succeeding vehicle and is thus rapidly propagated throughout the train.

Famous tests of railway brakes were those made by Sir Douglas Galton and Mr George Westinghouse on the London, Brighton and South Coast railway, in England, in 1878, and by a committee of the Master Car Builders' Association, near Burlington, Iowa, in 1886 and 1887. The object of the former series (for accounts of which see *Proc. Inst. Mech. Eng.*, 1878, 1879) was to determine the co-efficient of friction between the brake-shoe and the wheel, and between the wheel and rail at different velocities when the wheels were revolving and when skidded, i.e. stopped in their rotation and caused to slide. These experiments were the first of their kind ever undertaken, and for many years their results furnished most of the trustworthy data obtainable on the friction of motion. It was found that the co-efficient of friction between cast-iron shoes and steel-tired wheels increased as the speed of the train decreased, varying from 0.111 at 55 m. an hour to 0.33 when the train was just moving. It also decreased with the time during which the brakes were applied; thus at 20 m. an hour the

co-efficient was at the beginning 0.182, after ten seconds 0.133, after twenty seconds 0.099. Generally speaking, especially at moderate speeds, the decrease in the co-efficient of friction due to time is less than the increase due to decrease of speed, although when the time is long the reverse may be true. When the wheels are skidded the retardation of the train is always reduced; therefore, for the greatest braking effect, the pressures on the brake-shoes should never be sufficient to cause the wheels to slide on the rails. The Burlington brake tests were undertaken to determine the practicability of using power brakes on long and heavy freight trains. In the 1886 tests there were five competitors—three buffer-brakes, one compressed-air brake, and one vacuum-brake. The tests compared stops with trains of twenty-five and fifty vehicles, at 20 and

TABLE III.—Stops of a Train of Fifty Empty Cars—Electric Application of Air-Brakes.

Speed in Miles.	Distance in Feet.	Time in Seconds.	Equivalent Distance at 20 m. and 40 m.	
21½	160	7	139	..
23	183	8	138	..
38	475	14½	..	519
36½	460	14	..	545

Although the same levers, shoes, rods and other connexions were used, there were no shocks in the fiftieth car of the train on any stop, whether on the level or on a gradient. The committee in charge reported that the best type of brake for long freight trains was one operated by air, in which the valves were actuated by electricity, but they expressed doubt of the practicability of using electricity on freight trains. The Westinghouse Company then proceeded to quicken the action of the triple-valve, operated by air only, so that stops with fifty-car trains could be made without shock, and without electrically operated valves; and they were so successful in this respect that, towards the end of the same year, 1887, with a train of fifty vehicles, stops were made without shock, fully equalling in quickness and shortness of distance run any that had been made at the trials by the electrically operated brakes.

In 1889 some further tests were made by Sir Douglas Galton with the automatic vacuum-brake, on a practically level portion of the Manchester, Sheffield & Lincolnshire railway (now the Great Central). The train was composed of an engine, tender and forty carriages, the total length over buffers being 1464 ft., and the total weight 574 tons, of which 423 tons were braked. At a speed of about 32 m. an hour this train was brought to a standstill in twelve seconds after the application of the brakes, in a distance of 342 ft.

BRAKELOND, JOCELYN DE (fl. 1200), English monk, and author of a chronicle narrating the fortunes of the monastery of Bury St Edmunds between 1173 and 1202. He is only known to us through his own work. He was a native of Bury St Edmunds; he served his novitiate under Samson of Tottington, who was at that time master of the novices, but afterwards sub-sacrist, and, from 1182, abbot of the house. Jocelyn took the habit of religion in 1173, during the time of Abbot Hugo (1157-1180), through whose improvidence and laxity the abbey had become impoverished and the inmates dead to all respect for discipline. The fortunes of the abbey changed for the better with the election of Samson as Hugo's successor. Jocelyn, who became abbot's chaplain within four months of the election, describes the administration of Samson at considerable length. He tells us that he was with Samson night and day for six years; the picture which he gives of his master, although coloured by enthusiastic admiration, is singularly frank and intimate. It is all the more convincing since Jocelyn is no stylist. His Latin is familiar and easy, but the reverse of classical. He thinks and writes as one whose interests are wrapped up in his house; and the unique interest of his work lies in the minuteness with which it describes the policy of a monastic administrator who was in his own day considered as a model.

Jocelyn has also been credited with an extant but unprinted tract on the election of Abbot Hugo (Harleian MS. 1005, fo. 165); from internal evidence this appears to be an error. He mentions a (non-extant) work which he wrote, before the *Cronica*, on the miracles of St Robert, a boy whom the Jews of Bury St Edmunds were alleged to have murdered (1181).

See the editions of the *Cronica Jocelini de Brakelonda* by T. Arnold (in *Memorials of St Edmund's Abbey*, vol. i. Rolls series, 1890), and by J. G. Rokewood (Camden Society, 1840); also Carlyle's *Past and Present*, book ii. A translation and notes are given in T. E. Tomlin's *Monastic and Social Life in the Twelfth Century in the Chronicle of Jocelyn de Brakelond* (1844). There is also a translation of Jocelyn by Sir E. Clarke (1907).

BRAMAH, JOSEPH (1748-1814), English engineer and inventor, was the son of a farmer, and was born at Stainborough, Yorkshire, on the 13th of April 1748. Incapacitated for agricultural labour by an accident to his ankle, on the expiry of his indentures he worked as a cabinet-maker in London, where he subsequently started business on his own account. His first patent for some improvements in the mechanism of water-closets was taken out in 1778. In 1784 he patented the lock known by his name, and in 1795 he invented the hydraulic press. For an important part of this, the collar which secured water-tightness between the plunger and the cylinder in which it

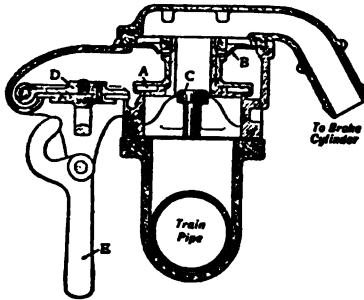

FIG. 3.—Rapid-acting Vacuum-Brake Valve.

40 m. an hour, on the level and on gradients of 1 in 100. They demonstrated that the buffer-brakes were inadequate for long trains, and that considerable improvements in the continuous brakes, both compressed-air and vacuum, would be needed to make them act quickly enough to avoid excessive shocks in the rear vehicles. In 1887 the trials of the year before were repeated by the same committee, and at the same place. Trains of fifty vehicles, about 2000 ft. long and fitted with each brake, were again provided, and there were again five competitors, but they all entered continuous brakes—three compressed-air brakes, one vacuum and one electric. The results of the first day's test of the train equipped with Westinghouse brakes are shown in Table I., the distances in which are the feet run by the train after the brakes were set, and the times the seconds that elapsed from the application of the brakes to full stop.

TABLE I.—Stops of a Train of Fifty Empty Cars, 1887—Automatic Air-Brakes.

Speed in Miles per Hour.	Distance in Feet.	Time in Seconds.	Equivalent Distance at 20 m. and 40 m.	
19½	186	9½	196	..
19½	215	11	233	..
36½	588	17	..	693

The remarkable shortness of these stops is the more evident when they are compared with the best results obtained in 1886, as shown in Table II.

TABLE II.—Stops of a Train of Fifty Empty Cars, 1886—Automatic Air-Brakes.

Speed in Miles.	Distance in Feet.	Time in Seconds.	Equivalent Distance at 20 m. and 40 m.	
23.5	424	17½	307	..
20.3	354	16	340	..
40	922	22½	..	922
40	927	22½	..	927

The time that elapsed between the application of the brakes on the engine and on the fiftieth vehicle was almost twice as great in 1886 as in 1887, being in the latter tests only five to six seconds, and in 1887 the stops were made in less than two-thirds the distance required in 1886. Still, violent shocks were caused by the rear vehicles running against those in front, before the brakes on the former were applied with sufficient force to hold them, and these shocks were so severe as to make the use of the brakes in practice impossible on long trains. When the triple-valves were actuated electrically, however, the stops were still further improved, as shown on Table III.

worked, he was indebted to Henry Maudslay, one of his workmen, who also helped him in designing machines for the manufacture of his locks. In 1806 he devised for the Bank of England a numerical printing machine, specially adapted for bank-notes. Other inventions of his included the beer-engine for drawing beer, machinery for making aerated waters, planing machines, and improvements in steam-engines and boilers and in paper-making machinery. In 1785 he suggested the possibility of screw propulsion for ships, and in 1802 the hydraulic transmission of power; and he constructed waterworks at Norwich in 1790 and 1793. He died in London on the 9th of December 1814.

BRAMANTE, or **BRAMANTE LAZZARI** (c. 1444-1514), Italian architect and painter, whose real name was Donato d'Agnolo, was born at Monte-Asdrualdo in Urbino, in July 1444. He showed a great taste for drawing, and was at an early age placed under Fra Bartolommeo, called Fra Carnavale. But though he afterwards gained some fame as a painter, his attention was soon absorbed by architecture. He appears to have studied under Scirro Scirri, an architect in his native place, and perhaps under other masters. He then set out from Urbino, and proceeded through several of the towns of Lombardy, executing works of various magnitudes, and examining patiently all remains of ancient art. At last, attracted by the fame of the great Duomo, he reached Milan, where he remained from 1476 to 1499. He seems to have left Milan for Rome about 1500. He painted some frescoes at Rome, and devoted himself to the study of the ancient buildings, both in the city and as far south as Naples. About this time the Cardinal Caraffa commissioned him to rebuild the cloister of the Convent della Pace. Owing to the celebrity and skill with which Bramante did this, the cardinal introduced him to Pope Alexander VI. He began to be consulted on nearly all the great architectural operations in Rome, and executed for the pope the palace of the Cancelleria or chancery. Under Julius II., Alexander's successor, Bramante's talents began to obtain adequate sphere of exercise. His first large work was to unite the straggling buildings of the palace and the Belvedere. This he accomplished by means of two long galleries or corridors enclosing a court. The design was only in part completed before the death of Julius and of the architect. So impatient was the pope and so eager was Bramante, that the foundations were not sufficiently well attended to; great part of it had, therefore, soon to be rebuilt, and the whole is now so much altered that it is hardly possible to decipher the original design.

Besides executing numerous smaller works at Rome and Bologna, among which is specially mentioned by older writers a round temple in the cloister of San Pietro-a-Montorio, Bramante was called upon by Pope Julius to take the first part in one of the greatest architectural enterprises ever attempted—the rebuilding of St Peter's. Bramante's designs were complete, and he pushed on the work so fast that before his death he had erected the four great piers and their arches, and completed the cornice and the vaulting in of this portion. He also vaulted in the principal chapel. After his death on the 11th of March 1514, his design was much altered, in particular by Michelangelo.

See Pungileoni, *Memoire intorno alla vita ed alle opere di Bramante* (Rome, 1836); H. Semper, *Donato Bramante* (Leipzig, 1879).

BRAMPTON, HENRY HAWKINS, BARON (1817-1907), English judge, was born at Hitchin, on the 14th of September 1817. He received his education at Bedford school. The son of a solicitor, he was early familiarized with legal principles. Called to the bar at the Middle Temple in 1843, he at once joined the old home circuit, and after enjoying a lucrative practice as a junior, took silk in 1859. His name is identified with many of the famous trials of the reign of Queen Victoria. He was engaged in the Simon Bernard case (of the Orsini plot celebrity), in that of *Roupeil v. Waite*, and in the Overend-Gurney prosecutions. The two causes *célèbres*, however, in which Hawkins attained his highest legal distinction were the Tichborne trials and the great will case of *Sugden v. Lord St Leonards*. In both of these he was victorious. In the first his masterly cross-examination of the witness Baigent was one of the great features

of the trial. He did a lucrative business in references and arbitrations, and acted for the royal commissioners in the purchase of the site for the new law courts. Election petitions also formed another branch of his extensive practice. Hawkins was raised to the bench in 1876, and was assigned to the then exchequer division of the High Court, not as baron (an appellation which was being abolished by the Judicature Act), but with the title of Sir Henry Hawkins. He was a great advocate rather than a great lawyer. His searching voice, his manner, and the variety of his facial expression, gave him an enormous influence with juries, and as a cross-examiner he was seldom, if ever, surpassed. He was an excellent judge in chambers, where he displayed a clear and vigorous grasp of details and questions of fact. His knowledge of the criminal law was extensive and intimate, the reputation he gained as a "hanging" judge making him a terror to evil-doers; and the court for crown cases reserved was never considered complete without his assistance. In 1898 he retired from the bench, and was raised to the peerage under the title of Baron Brampton. He frequently took part in determining House of Lords appeals, and his judgments were distinguished by their lucidity and grasp. He held for many years the office of counsel to the Jockey Club, and as an active member of that body found relaxation from his legal and judicial duties at the leading race meetings, and was considered a capable judge of horses. In 1898 he was received into the Roman Catholic Church, and in 1903 he presented, in conjunction with Lady Brampton (his second wife), the chapel of SS. Augustine and Gregory to the Roman Catholic cathedral of Westminster, which was consecrated in that year. In 1904 he published his *Reminiscences*. He died in London on the 6th of October 1907, and Lady Brampton in the following year.

BRAMPTON, a market town in the Eskdale parliamentary division of Cumberland, England, 9 m. E.N.E. of Carlisle, on a branch of the North Eastern railway. Pop. (1901) 2494. It is picturesquely situated in a narrow valley opening upon that of the Irthing. The town has an agricultural trade, breweries, and manufactures of cotton and tweeds. The neighbourhood is rich in historical associations. Two miles N.E. of Brampton is the castle of Naworth, a fine example of a Border fortress. It was built in the reign of Edward III., by a member of the family of Dacre, who for many generations had had their stronghold here. Overlooking a deep wooded ravine, with streams to the east and west, the great quadrangular castle was naturally defended except on the south, where it was rendered secure by a double moat and drawbridge. By marriage in 1577 with Lady Elizabeth Dacre it passed into the hands of William Howard, afterwards lord warden of the Marches, the "Belted Will" of Sir Walter Scott and the Border ballads, who acquired great fame by his victories over the Scottish moss-troopers. The castle, the walls of which have many secret passages and hiding-places, is inhabited, and in its hall are numerous fine pictures, including a portrait of Charles I. by Van Dyck. Not far distant is Lanercost Priory, where in 1169 an Augustinian monastery was established. In 1311 Robert Bruce and his army were quartered here, and the priory was pillaged in 1346 by David, king of Scotland. From this time its prosperity declined, and at its dissolution under Henry VIII. it consisted only of a prior and seven canons. The Early English church has a restored nave, but retains much fine carving. The chancel is ruined, but the interesting crypt is preserved.

BRAMWELL, GEORGE WILLIAM WILSHERE BRAMWELL, BARON (1808-1892), English judge, was born in London on the 12th of June 1808, being the eldest son of George Bramwell, of the banking firm of Dorrien, Magens, Dorrien & Mello. He was educated privately, and at the age of sixteen he entered Dorriens' bank. In 1830 he gave up this business for the law, being admitted as a student at Lincoln's Inn in 1830, and at the Inner Temple in 1836. At first he practised as a special pleader, but was eventually called to the bar at both Inns in 1838. He soon worked his way into a good practice both in London and the home circuit, his knowledge of law and procedure being so well recognized that in 1850 he was appointed a member

of the Common Law Procedure Commission, which resulted in the Common Law Procedure Act of 1852. This act he drafted jointly with his friend Mr (afterwards Mr Justice) Willes, and thus began the abolition of the system of special pleading. In 1851 Lord Cranworth made Bramwell a queen's counsel, and the Inner Temple elected him a bench—he had ceased to be a member of Lincoln's Inn in 1841. In 1853 he served on the royal commission to inquire into the assimilation of the mercantile laws of Scotland and England and the law of partnership, which had as its result the Companies Act of 1862. It was he who, during the sitting of this commission, suggested the addition of the word "limited" to the title of companies that sought to limit their liability, in order to prevent the obvious danger to persons trading with them in ignorance of their limitation of liability. As a queen's counsel Bramwell enjoyed a large and steadily increasing practice, and in 1856 he was raised to the bench as a barrister of the court of exchequer. In 1867, with Mr Justice Blackburn and Sir John Coleridge, he was made a member of the judicature commission. In 1871 he was one of the three judges who refused the seat on the judicial committee of the privy council to which Sir Robert Collier, in evasion of the spirit of the act creating the appointment, was appointed; and in 1876 he was raised to the court of appeal, where he sat till the autumn of 1881. As a puisne judge he had been conspicuous as a sound lawyer, with a strong logical mind unfettered by technicalities, but endowed with considerable respect for the common law. His rulings were always clear and decisive, while the same quality marked his dealings with fact, and, coupled with a straightforward, unpretentious manner, gave him great influence with juries. In the court of appeal he was perhaps not so entirely in his element as at *nisi prius*, but the same combination of sound law, strong common sense and clear expression characterized his judgments. His decisions during the three stages of his practical career are too numerous to be referred to particularly, although *Ryder v. Wombwell* (L. R. 3 Ex. 95); *R. v. Bradshaw* (14 Cox C. C. 84); *Household Fire Insurance Company v. Grant* (4 Ex. Div. 216); *Stonor v. Fowle* (13 App. Cas. 20), *The Bank of England v. Vagliano Brothers* (App. Cas. 1891) are good examples. Upon his retirement, announced in the long vacation of 1881, twenty-six judges and a huge gathering of the bar entertained him at a banquet in the Inner Temple hall. In December of the same year he was raised to the peerage, taking the title Baron Bramwell of Hever, from his home in Kent. In private life Bramwell had simple tastes and enjoyed simple pleasures. He was musical and fond of sports. He was twice married: in 1830 to Jane (d. 1836), daughter of Bruno Silva, by whom he had one daughter, and in 1861 to Martha Sinden. He died on the 9th of May 1892.

His younger brother, Sir Frederick Bramwell (1818–1903), was a well-known consulting engineer and "expert witness."

At all times Lord Bramwell had been fond of controversy and controversial writing, and he wrote constant letters to *The Times* over the signature B. (he also signed himself at different times Bramwell, G. B. and L. L.). He joined in 1882 the Liberty and Property Defence League, and some of his writings after that date took the form of pamphlets published by that society.

BRAM, in Celtic legend, the name of (1) the hero of the Welsh *Mabinogi of Branwen*, who dies in the attempt to avenge his sister's wrongs; he is the son of Llyr (= the Irish sea-god Ler), identified with the Irish Bran mac Allait, Allait being a synonym of Ler; (2) the son of Febal, known only through the 8th-century Irish epic, *The Voyage of Bran* (to the world below); (3) the dog of Osian's Fingal. Bran also appears as a historical name, Latinized as *Brennus*. See Kuno Meyer and D. Nutt, *The Voyage of Bran* (London, 1895).

BRAN, the ground husk of wheat, oats, barley or other cereals, used for feeding cattle, packing and other purposes (see FLOUR). The word occurs in French *brun* or *bran*, in the dialects of other Romanic languages, and also in Celtic, cf. Breton *brenn*, Gaelic *brun*. The *New English Dictionary* considers these Celtic forms to be borrowed from French or English. In modern French *brun* means filth, refuse, and this points to some connexion with Celtic words, e.g. Irish *brenn*, manure. If so, the original meaning

would be refuse. "Bran-new," *i.e.* quite new, is now the common form of "brand-new," that which is fresh from the "brand," the branding-iron used for marking objects, &c.

BRANCH (from the Fr. *branche*, late Lat. *branca*, an animal's paw), a limb of a tree; hence any offshoot, e.g. of a river, railway, &c., of a deer's antlers, of a family or genealogical tree, and generally a subdivision or department, as in "a branch of learning." The phrase, to destroy "root and branch," meaning to destroy utterly, taken originally from Malachi iv. 1, was made famous in 1641 by the so-called "Root and Branch" Bill and Petition for the abolition of episcopal government, in which petition occurred the sentence, "That the said government, with all its dependencies, roots and branches, be destroyed." Among technical senses of the word "branch" are: the certificate of proficiency given to pilots by Trinity House; and in siege-craft a length of trench forming part of a zigzag approach.

BRANCO, or **PARIMA**, a river of northern Brazil and tributary of the Rio Negro, formed by the confluence of the Takutú, or "Upper Rio Branco," and Uraricoera, about 3° N. lat. and 60° 28' W. long., and flowing south by west to a junction with the Negro. It has rapids in its upper course, but the greater part of its length of 348 m. is navigable for steamers of light draught. The Takutú rises in the Roraima and Colfrit ranges on the Guiana frontier, while the Uraricoera rises in the Serra de Parima, on the Venezuelan frontier, and has a length of 360 m. before reaching the Branco. These are white water rivers, from which the Branco (white) derives its name, and at its junction with the Negro the two differently-coloured streams flow side by side for some distance before mingling.

BRANCOVAN, or **BRANCOVEANU**, the name of a family which has played an important part in the history of Rumania. It was of Servian origin and was connected with the family of Branko or Brankovich. Constantine Brancovan, the most eminent member of the family, was born in 1654, and became prince of Walachia in 1689. In consequence of his anti-Turkish policy of forming an alliance first with Austria and then with Russia, he was denounced to the Porte, deposed from his throne, brought under arrest to Constantinople and imprisoned (1710) in the fortress of Yedi Kuleh (Seven Towers). Here he was tortured by the Turks, who hoped thus to discover the fortune of £3,000,000, which Constantine was alleged to have amassed. He was beheaded with his four sons on the 26th of August 1714. His faithful friend Enake Vacarescu shared his fate. Constantine Brancovan became, through his tragic death, the hero of Rumanian popular ballads. His family founded and endowed the largest hospital in Walachia, the so-called Spital Brancovanescu.

See O. G. Lecca, *Familiiile Borești Române* (Bucharest, 1899), p. 90, 899. (M. G.)

BRAND, JOHN (1744–1806), English antiquary, was born on the 19th of August 1744 at Washington, Durham, where his father was parish clerk. His early years were spent at Newcastle-on-Tyne with his uncle, a cordwainer, to whom he was apprentice in his fourteenth year. Showing promise, however, at Newcastle grammar school, friends interested themselves in him and assisted him to go to Oxford. It was not, however, until his twenty-eighth year that he matriculated at Lincoln College, but before this he had been ordained, holding in succession the curacies of Bolam, Northumberland, of St Andrew's, Newcastle, and of Cramlington, 8 m. from the county town. He graduated in 1775 and two years later was elected fellow of the Society of Antiquaries. Having for a short time been under-usher at the Newcastle grammar school, the duke of Northumberland, a former patron, gave him in 1784 the rectory of the combined parishes of St Mary-at-Hill and St Mary Hubbard, London. Appointed secretary to the Society of Antiquaries in the same year, he was annually re-elected until his death in 1806. He was buried in the chancel of his church. His most important work is *Observations on Popular Antiquities: including the whole of Mr Bourne's "Antiquitates Vulgares," with addenda to every chapter of that work*. This was published in London in 1777, and after Brand's death, a new edition embodying the MSS. left by him, was published by Sir Henry Ellis in 1813. Brand also published

a poem entitled: *On Illicit Love, written among the ruins of Godslow Nunnery, near Oxford* (1775, Newcastle); *The History and Antiquities of Newcastle-upon-Tyne* (2 vols., London, 1789), and many papers in the *Archæologia*.

BRAND, SIR JOHN HENRY (1823-1888), president of the Orange Free State, was the son of Sir Christoffel Brand, speaker of the House of Assembly of the Cape Colony. He was born at Cape Town on the 6th of December 1823, and was educated at the South African College in that city. Continuing his studies at Leiden, he took the degree of D.C.L. in 1845. He was called to the English bar from the Inner Temple in 1849, and practised as an advocate in the supreme court of the Cape of Good Hope from that year until 1863. In 1858 he was appointed professor of law in the South African College. He was elected president of the Orange Free State in 1863, and subsequently re-elected for five years in 1869, 1874, 1879 and 1884. In 1864 he resisted the pressure of the Basuto on the Free State boundary, and after vainly endeavouring to induce Moshesh, the Basuto chief, to keep his people within bounds, he took up arms against them in 1865. This first war ended in the treaty of Thaba Bosigo, signed on the 3rd of April 1866; and a second war, caused by the treachery of the Basuto, ended in the treaty of Aliwal North, concluded on the 12th of February 1869. In 1871 Brand was solicited by a large party to become president of the Transvaal, and thus unite the two Dutch republics of South Africa; but as the project was hostile to Great Britain he declined to do so, and maintained his constant policy of friendship towards England, where his merits were recognized in 1882 by the honour of the G.C.M.G. He died on the 14th of July 1888. (See *ORANGE FREE STATE: History*.)

BRAND, WILLIAM THOMAS (1788-1866), English chemist, was born in London on the 11th of January 1788. After leaving Westminster school, he was apprenticed, in 1802, to his brother, an apothecary, with the view of adopting the profession of medicine, but his bent was towards chemistry, a sound knowledge of which he acquired in his spare time. In 1812 he was appointed professor of chemistry to the Apothecaries' Society, and delivered a course of lectures before the Board of Agriculture in place of Sir Humphry Davy, whom in the following year he succeeded in the chair of chemistry at the Royal Institution, London. His *Manual of Chemistry*, first published in 1819, enjoyed wide popularity, and among other works he brought out a *Dictionary of Science, Literature and Art* in 1842, on a new edition of which he was engaged when he died at Tunbridge Wells on the 11th of February 1866.

BRANDENBURG, the name of a margravate and electorate which played an important part in German history, and afterwards grew into the kingdom of Prussia. During the early years of the Christian era, the district was inhabited by the Semnones, and afterwards by various Slavonic tribes, who were partially subdued by Charlemagne, but soon regained their independence. The history of Brandenburg begins when the German king, Henry the Fowler, defeated the Havelli, or Hevelli, and took their capital, Brennibor, from which the name Brandenburg is derived. It soon came under the rule of Gero, margrave of the Saxon east mark, who pressed the campaign against the Slavs with vigour, while Otto the Great founded bishoprics at Havelberg and Brandenburg. When Gero died in 965, his mark was divided into two parts, the northern portion, lying along both banks of the middle Elbe, being called the north or old mark, and forming the nucleus of the later margravate of Brandenburg. After Otto the Great died, the Slavs regained much of their territory, Brandenburg fell again into their hands, and a succession of feeble margraves ruled only the district west of the Elbe, together with a small district east of that river.

A new era began in 1106 when Lothair, count of Supplinburg, became duke of Saxony. Aided by Albert the Bear, count of Ballenstädt, he renewed the attack on the Slavs, and in 1134 appointed Albert margrave of the north mark.

The new margrave continued the work of Lothair, and about 1140 made a treaty with Pribislaus, the childless duke of Brandenburg, by which he was recognized as the duke's heir.

He took at once the title margrave of Brandenburg, but when Pribislaus died in 1150, a stubborn contest followed with Jazko, a relation of the late duke, which was terminated in 1157 in Albert's favour. Albert was the real founder of Brandenburg. Under his rule Christianity and civilization were extended, bishoprics were restored and monasteries founded. The country was colonized with settlers from the lower Rhineland, land was brought under cultivation, forts were built, German laws and customs introduced, and gradually the woods and marshes were converted into lands of comparative fertility.

When Albert died in 1170, Brandenburg fell to his eldest son, Otto I. (c. 1130-1184), who compelled the duke of Pomerania to own his supremacy, and slightly increased by conquest the area of the mark. Otto's son, Otto II., was the succeeding margrave, and having quarrelled with his powerful neighbour, Ludolf, archbishop of Magdeburg, was forced to own the archbishop's supremacy over his allodial lands. He died in 1205, and was followed by his step-brother, Albert II. (c. 1174-1220), who assisted the emperor Otto IV. in various campaigns, but later transferred his allegiance to Otto's rival, Frederick of Hohenstaufen, afterwards the emperor Frederick II. His sons, John I. and Otto III., ruled Brandenburg in common until the death of John in 1266, and their reign was a period of growth and prosperity. Districts were conquered or purchased from the surrounding dukes; the marriage of Otto with Beatrice, daughter of Wenceslaus, king of Bohemia, in 1253, added upper Lusatia to Brandenburg; and the authority of the margraves was extended beyond the Oder. Many monasteries and towns were founded, among them Berlin; the work of Albert the Bear was continued, and the prosperity of Brandenburg formed a marked contrast to the disorder which prevailed elsewhere in Germany. Brandenburg appears about this time to have fallen into three divisions—the old mark lying west of the Elbe, the middle mark between the Elbe and the Oder, and the new mark, as the newly conquered lands beyond the Oder began to be called. When Otto died in 1267, the area of the mark had been almost doubled, and the margraves had attained to an influential position in the Empire. The *Sachsenspiegel*, written before 1235, mentions the margrave as one of the electors, by virtue of the office of chamberlain, which had probably been conferred on Albert the Bear by the German king Conrad III.

In 1258 John and Otto had agreed upon a division of their lands, but the arrangement only took effect on Otto's death in 1267, when John's son, John II., received the electoral dignity, together with the southern part of the margravate, which centred around Stendal, and Otto's son, John III., the northern or Saltzwedel portion. John II.'s brother, Otto IV., who became elector in 1281, had passed his early years in struggles with the archbishop of Magdeburg, whose lands stretched like a wedge into the heart of Brandenburg. In 1280 he was wounded in the head with a dart, and as he retained there a part of the weapon for a year, he was called "Otto with the dart." He secured the appointment of his brother Eric as archbishop of Magdeburg in 1283, and was afterwards engaged in various feuds. Songs attributed to him are found in F. H. von der Hagen's *Minnesinger*. Otto was succeeded in 1309 by his nephew, Valdemar, who, assisted by other members of his family, conquered Pomerellen, which he shared with the Teutonic order in 1310, and held his own in a struggle with the kings of Poland, Sweden and Denmark and others, over the possession of Stralsund.

In order to pay for these wars, and to meet the expenses of a splendid court, the later margraves had sold various rights to the towns and provinces of Brandenburg, and so aided the development of local government. John III. of Saltzwedel had shared his possessions with his brothers, but in 1303 they were reunited by his nephew Hermann, who purchased lower Lusatia in the same year. Hermann's daughter Agnes married the elector Valdemar, and on the death of her only brother, John VI., in 1317, the possessions of the Saltzwedel branch of the family passed to Valdemar, together with Landsberg and the Saxon Palatinate, which had been purchased from Albert the

Degenerate, landgrave of Thuringia. Valdemar thus gathered the whole of the mark under his rule, together with upper and lower Lusatia, and various outlying districts. He died childless in 1319, and was succeeded by his nephew Henry II., who died in 1320, when the Ascanian family, as the descendants of Albert the Bear were called, from the Latinized form of the name of their ancestral castle of Aschersleben, became extinct.

Brandenburg now fell into a deplorable condition, portions were seized by neighbouring princes, and the mark itself was disputed for by various claimants. In 1323 King Louis IV. took advantage of this condition to bestow the mark upon his young son, Louis, and thus Brandenburg was added to the possessions of the Wittelsbach family, although Louis did not receive the extensive lands of the Ascanian margraves. Upper and lower Lusatia, Landsberg, and the Saxon Palatinate had been inherited by female members of the family, and passed into the hands of other princes; the old mark was retained by Agnes, the widow of Valdemar, who was married again to Otto II., duke of Brunswick, and the king was forced to acknowledge these claims, and to cede districts to Mecklenburg and Bohemia. During the early years of the reign of Louis, who was called the margrave Louis IV. or V., Brandenburg was administered by Bertold, count of Henneberg, who established the authority of the Wittelsbachs in the middle mark, which, centring round Berlin, was the most important part of the margraviate. The quarrel between King Louis and Pope John XXII. was inimical to the interests of Brandenburg, which was ravaged by the Poles, torn by the strife of contending clerical factions, and alternately neglected and oppressed by the margrave. Trade and commerce were at a standstill, agriculture was neglected, the privileges and estates of the margrave passed into private hands, the nobles were virtually independent, and the towns sought to defend themselves by means of alliances. During the struggle between the families of Wittelsbach and Luxemburg, which began in 1342, there appeared in Brandenburg an old man who claimed to be the margrave Valdemar. He was gladly received by the king of Poland, and other neighbouring princes, welcomed by a large number of the people, and in 1348 invested with the margraviate by King Charles IV., who eagerly seized this opportunity to deal a blow at his enemy. This step compelled Louis to make peace with Charles, who abandoned the false Valdemar, invested Louis and his step-brothers with Brandenburg, and in return was recognized as king. Louis recovered the old mark in 1348, drove his opponent from the land, and in 1350 made a treaty with his step-brothers, Louis the younger and Otto, at Frankfort-on-Oder, by which Brandenburg was handed over to Louis the younger and Otto. Louis, who then undertook the government, made peace with his neighbours, finally defeated the false Valdemar, and was recognized by the Golden Bull of 1356 as one of the seven electors. The emperor Charles IV. took advantage of a family quarrel over the possessions of Louis the elder, who died in 1361, to obtain a promise from Louis the younger and Otto, that the margraviate should come to his own son, Wenceslaus, in case the electors died childless. Louis the younger died in 1365, and when his brother Otto, who had married a daughter of Charles IV., wished to leave Brandenburg to his own family Charles began hostilities; but in 1373 an arrangement was made, and Otto, by the treaty of Fürstenwalde, abandoned the margraviate for a sum of 500,000 gold gulden.

Under the Wittelsbach rule, the estates of the various provinces of Brandenburg had obtained the right to coin money, to build fortresses, to execute justice, and to form alliances with foreign states. Charles invested Wenceslaus with the margraviate in 1373, but undertook its administration himself, and passed much of his time at a castle which he built at Tangermünde. He diminished the burden of taxation, suppressed the violence of the nobles, improved navigation on the Elbe and Oder, and encouraged commerce by alliances with the Hanse towns, and in other ways. He caused a *Landbook* to be drawn up in 1375, in which are recorded all the castles, towns and villages of the land with their estates

and incomes. When Charles died in 1378, and Wenceslaus became German and Bohemian king, Brandenburg passed to the new king's half-brother Sigismund, then a minor, and a period of disorder ensued. Soon after Sigismund came of age, he pledged a part of Brandenburg to his cousin Jobst, margrave of Moravia, to whom in 1388 he handed over the remainder of the electorate in return for a large sum of money, and as the money was not repaid, Jobst obtained the investiture in 1397 from King Wenceslaus. Sigismund had also obtained the new mark on the death of his brother John in 1396, but sold this in 1402 to the Teutonic order. Jobst paid very little attention to Brandenburg, and the period was used by many of the noble families to enrich themselves at the expense of the poorer and weaker towns, to plunder traders, and to carry on feuds with neighbouring princes. When in 1410 Sigismund and Jobst were rivals for the German throne, Sigismund, anxious to obtain another vote in the electoral college, declared the bargain with Jobst void, and empowered Frederick VI. of Hohenzollern, burgrave of Nuremberg, to exercise the Brandenburg vote at the election. (See **FREDERICK I., ELECTOR OF BRANDENBURG.**) In 1411 Jobst died and Brandenburg reverted to Sigismund, who appointed Frederick as his representative to govern the margraviate, and a further step was taken when, on the 30th of April 1415, the king invested Frederick of Hohenzollern and his heirs with Brandenburg, together with the electoral privilege and the office of chamberlain, in return for a payment of 400,000 gold gulden, but the formal ceremony of investiture was delayed until the 18th of April 1417, when it took place at Constance.

During the century which preceded the advent of the Hohenzollerns in Brandenburg its internal condition had become gradually worse and worse, and had been accompanied by a considerable loss of territory. The central power had become weakened and the central organization relaxed, while the electorate had lost most of the advantages which formerly distinguished it from other German fiefs. Under the rule of the earliest margraves, it was the official side of their position that was prominent, and it was not forgotten that they were technically only the representatives of the emperor. But in the 13th century this feeling began to disappear, and Brandenburg enjoyed an independence and carried out an independent policy in a way that was not paralleled by any other German state. The emperor was still suzerain indeed, but his relations with the mark were so insignificant that they exercised practically no influence on its development; and so the power of the Ascanian margraves was virtually unlimited. This independence was enhanced by the fact that few great nobles had followed Albert the Bear in his work of conquest, and that consequently there were few large lordships with their crowd of dependents. The towns, the village communities and the knights held their lands and derived their rights directly from the margraves. The towns and villages had generally been laid out by contractors or *locatores*, men not necessarily of noble birth, who were installed as hereditary chief magistrates of the communities, and received numerous encouragements to reclaim waste lands. This mode of colonization was especially favourable to the peasantry, who seem in Brandenburg to have retained the disposal of their persons and property at a time when villenage or serfdom was the ordinary *status* of their class elsewhere. The dues paid by these contractors in return for the concessions formed the main source of the revenue of the margraves. Gradually, however, the expenses of warfare, liberal donations to the clergy, and the maintenance of numerous and expensive households, compelled them to pledge these dues for sums of ready money. This proceeding gave the barons and knights an opportunity to buy out the village magistrates and to replace them with nominees of their own. Thus the condition of the peasants grew worse, and their freedom was practically destroyed when the emperor Louis IV. recognized the jurisdiction of the nobles over their estates. Henceforth the power of the nobles steadily increased at the expense of the peasants, who soon sank into servitude. Instead of communicating

Condition before the Hohenzollern rule.

Important central

directly with the margrave through his burgraves and bailiffs, or *septs*; the village communities came to be represented by the nobles who had obtained possession of their lands. Many of the towns were forced into the same position. Others were able to maintain their independence, and to make use of the pecuniary needs of the margraves to become practically municipal republics. Their strength, however, was perhaps more usefully shown in their ability to resist the nobles, a proceeding which saved industry and commerce from extinction at a time of unbridled lawlessness. In the pecuniary embarrassments of the margraves also originated the power of the *Söhnde*, or estates, consisting of the nobles, the clergy and the towns. The first recorded instance of the *Söhnde* co-operating with the rulers occurred in 1170; but it was not till 1280 that the margrave solemnly bound himself not to raise a *bede* or special voluntary contribution without the consent of the estates. In 1355 the *Söhnde* secured the appointment of a permanent councillor, without whose concurrence the decrees of the margraves were invalid. In the century which followed the extinction of the Ascanian house, liberty degenerated into licence, and the country was given over to anarchy. Only the most powerful towns were able to maintain their independence; others, together with the clergy, regularly paid blackmail to the neighbouring nobles. Under these conditions it is no wonder that the electorate not only completely lost its political importance, but also suffered a considerable diminution of territory. Upper and lower Lusatia, the new mark of Brandenburg, and other outlying districts had been shorn away, and the electorate now consisted of the old mark, the middle mark with Priegnitz, Uckermark and Sternberg, a total area of not more than 10,000 sq. m.

Such was the condition and extent of Brandenburg in 1411 when Frederick of Hohenzollern became the representative of

Frederick of Hohenzollern, 1412. King Sigismund therein. Entering the electorate with a strong force in June 1412, his authority was quickly recognized in the middle mark, but the nobles of the old mark and of Priegnitz refused to follow this example.

The two succeeding years were skilfully used by Frederick to make peace with the neighbouring princes, and having thus isolated his domestic enemies, he turned his arms against them early in 1414. Their strongholds were stormed, and in a few weeks their leaders were either prisoners or fugitives. A general peace was then declared at Tangermünde which enabled Frederick to leave the mark to the rule of his wife, Elizabeth, and to turn his attention elsewhere. Returning to Brandenburg as elector in 1416, the last flickers of the insurrection were extinguished; and when Frederick was invested at Constance in April 1417 his authority over the mark was undisputed. His next difficulty was with Pomerania, which had been nominally under the suzerainty of Brandenburg since 1181. The revival of this claim by the elector provoked an invasion of the mark by an army of Pomeranians with their allies in 1420, when Frederick inflicted a severe defeat upon them at Angermünde; but in 1424 a temporary coolness between the elector and the emperor Sigismund led to a renewal of the attack which Frederick was unable to repulse. This reverse, together with the pressure of other business, induced him to leave Brandenburg in January 1426, after handing over its government to his eldest son, John. John, called the "Alchemist," who was born in 1403, had been disappointed in his hope of obtaining the vacant electoral duchy of Saxe-Wittenberg in 1423. Lacking the diplomatic and military qualities of his father, his difficulties were augmented by the poverty of the country, and the evils which Frederick had suppressed quickly returned. The feeling of security vanished, the towns banded themselves together for defensive purposes, the rights of the margrave were again pledged to provide money, and in 1432 the land was ravaged by the Hussites. John never attained to the electoral dignity; for, in 1437, his father in arranging a division of his territories decided that Brandenburg should pass to his second and fourth sons, both of whom were named Frederick. The elder of the two took up the government at once, whereupon John left the mark for south Germany, where he remained until his death in 1464.

Frederick II., who became elector on his father's death in September 1440, was born on the 19th of November 1413, and earned the surname of "Iron" through his sternness to his country's enemies. He had little difficulty in repressing the turbulence of the nobles which had been quickened into life during the regency of his brother, but found it less easy to deal with the towns. Three strong leagues had been formed among them about 1431, and the spirit of municipal independence was most prominently represented by the neighbouring and allied towns of Berlin and Cöln. In his conflict with the towns over his refusal to ratify all their privileges the elector's task was lightened by a quarrel between the magistrates and the burghers of Berlin, which he was called in to decide in 1442. He deposed the governing oligarchy, changed the constitution of the town, forbade all alliances and laid the foundations of a castle. The inhabitants soon chafed under these restrictions. A revolt broke out in 1447, but the power of the elector overawed the people, who submitted their case to the estates, with the result that the arrangement of 1442 was re-established. In 1447 Frederick was compelled to cede the old mark and Priegnitz to his younger brother, Frederick, under whose feeble rule they quickly fell into disorder. In 1463, however, when the younger Frederick died childless, the elector united them again with his own possessions and took measures to suppress the prevailing anarchy. In his dealings with neighbouring rulers Frederick pursued a peaceful and conciliatory policy. In 1442 he obtained some small additions to his territory, and the right of succession to the duchy of Mecklenburg in case the ducal family should die out. In 1445 an old feud with the archbishop of Magdeburg was settled, and in 1457 a treaty of mutual succession was made with the houses of Saxony and Hesse. Cottbus and Peitz in Lusatia were acquired, and retained after a quarrel with George Podiebrad, king of Bohemia, and the new mark of Brandenburg was purchased from the Teutonic order in 1454. An attempt, however, to secure the duchy of Pomerania-Stettin failed, and the concluding years of this reign were troubled by warfare with the Pomeranians.

The general success of Frederick's rule was secured by the sedulous care with which he confined himself to the work of government. He is said to have refused the thrones of Poland and Bohemia; and although he made pilgrimages to the Holy Land and to Rome, his interest in ecclesiastical questions was mainly directed towards quickening the religious life of his people. He obtained important concessions from Pope Nicholas V. with regard to the appointment of bishops and other ecclesiastical matters in 1447, and in general maintained cordial relations with the papacy. About 1467 his only son, John, died, and increasing infirmity led him to contemplate abdication. An arrangement was made with his brother, Albert Achilles, to whom early in 1470 the mark was handed over, and Frederick retired to Plassenburg where he died on the 20th of February 1471.

Albert appeared in Brandenburg early in the same year, and after receiving the homage of his people took up the struggle with the Pomeranians, which he soon brought to a satisfactory conclusion; for in May 1472 he not only obtained the cession of several districts, but was recognized as the suzerain of Pomerania and as its future ruler. The expenses of this war led to a quarrel with the estates. A subsidy was granted which the elector did not regard as adequate, and by a dexterous use of his power he established his right to take an excise on beer. Albert's most important contribution to the history of Brandenburg was the issue on the 24th of February 1473 of the *Dispositio Achilles*. By this instrument the elector decreed that the electoral mark should pass in its entirety to his eldest son, an establishment of primogeniture which had considerable influence on the future development of the country. He then entrusted the government to his eldest son, John, and left Brandenburg. Handicapped by poverty, John had to face attacks from two quarters. The Pomeranians, inspired by the declaration of the emperor Frederick III. that their land was a direct fief of the Empire, and aided by Matthias Corvinus, king of Hungary, took up arms; and a quarrel broke

Albert Achilles.

out with John, duke of Sagan, over the possessions of John's brother-in-law, Henry XI, duke of Glogau. To deal with these difficulties Albert returned to Brandenburg in 1478, and during his stay drove back the Pomeranians, and added Crossen and other parts of duke Henry's possessions to the electorate. Again left in charge of the country, John beat back a fresh attack made by John of Sagan in 1482; and he became elector on his father's death in March 1486. He added the county of Zossen to his possessions in 1490, and in 1493 made a fresh treaty with the duke of Pomerania. Although he brought a certain degree of order into the finances, his poverty and the constant inroads of external enemies prevented him from seriously improving the condition of the country. John, who was called "Cicero," either on account of his eloquence, or of his knowledge of Latin, was interested in learning, welcomed Italian scholars to the electorate, and strove to improve the education of his people. He died at Arneburg on the 9th of January 1499, and was succeeded by his son Joachim I.

When Joachim undertook the government of Brandenburg he had to deal with an amount of disorder almost as great as that which had taxed the energies of Frederick I. a century before. Highway robbery was general, the lives and property of traders were in continual jeopardy, and the machinery for the enforcement of the laws was almost at a standstill. About 1504 an attack of unusual ferocity on some Frankfurt traders aroused the elector's wrath, and during the next few years the execution of many lawbreakers and other stern measures restored some degree of order. In this and in other ways Joachim proved himself a sincere friend to the towns and a protector of industry. Following the economic tendencies of the time he issued sumptuary laws and encouraged manufactures; while to suppress the rivalry among the towns he established an order of precedence for them. Equally important was his work in improving the administration of justice, and in this direction he was aided by scholars from the university which he had founded at Frankfort-on-Oder in 1506. He gave a new organization to the highest court of justice, the *Kammergericht*, secured for himself an important voice in the choice of its members, and ordered that the local law should be supplemented by the law of Rome. He did not largely increase the area of Brandenburg, but in 1524 he acquired the county of Ruppın, and in 1529 he made a treaty at Grimnitz with George and Barnim XI, dukes of Pomerania, by which he surrendered the vexatious claim to suzerainty in return for a fresh promise of the succession in case the ducal family should become extinct. Joachim's attitude towards the teaching of Martin Luther which had already won many adherents in the electorate, was one of unrelenting hostility. The Jews also felt the weight of his displeasure, and were banished in 1510.

Ignoring the *Dispositio Achillea*, the elector bequeathed Brandenburg to his two sons. When he died in July 1535 the elder, Joachim II., became elector, and obtained the old and middle marks, while the younger, John, received the new mark. John went definitely over to the side of the Lutherans in 1538, while Joachim allowed the reformed doctrines free entrance into his dominions in 1539. The elector, however, unlike his brother, did not break with the forms of the Church of Rome, but established an ecclesiastical organization independent of the pope, and took up a position similar to that of King Henry VIII. in England. Many of the monasteries were suppressed, a consistory was set up to take over the functions of the bishops and to act as the highest ecclesiastical court of the country. In 1541 the new ecclesiastical system was confirmed by the emperor Charles V. With regard to this policy the elector was probably influenced by considerations of greed. The bishoprics of Brandenburg, Havelberg and Lebus were secularized; their administration was entrusted to members of the elector's family; and their revenues formed a welcome addition to his impoverished exchequer. Nor did Joachim neglect other opportunities for adding to his wealth and possessions. In 1537 he had concluded a treaty with Frederick III., duke of Liegnitz, which guaranteed to the Hohenzollerns the

succession to the Silesian duchies of Liegnitz, Brieg and Wohlau in the event of the ducal family becoming extinct; this arrangement is important as the basis of the claim made by Frederick the Great on Silesia in 1740. The treaty was declared invalid by the German king, Ferdinand I.; but the elector insisted on its legality, and in 1545 strengthened his position by arranging a double marriage between members of his own family and that of Duke Frederick. Of more immediate consequence was an arrangement made in 1569 with the representatives of Joachim's kinsman, Albert Frederick, duke of Prussia, after which the elector obtained the joint investiture of the duchy of Prussia from Sigismund II., king of Poland, and was assured of the succession if the duke's family became extinct. Joachim's luxurious habits, his partiality for adventurers, and his delight in building, led him to incur such a heavy expenditure that after pledging many of his lands and rights he was compelled in 1540 to appeal for help to the estates. Taking advantage of his difficulties, the estates voted him a sum of money as the price of valuable concessions, the most important of which was that the elector should make no alliance without their consent. Fresh liabilities were soon incurred, and in spite of frequent contributions from the estates Joachim left at his death in January 1571 a heavy burden of debt to his son and successor, John George.

The elector's death was followed ten days later by that of his brother, John, and as John left no sons the whole of Brandenburg, together with the districts of Beeskow and Storkow which had been added by purchase to the new mark, were united under the rule of his nephew, John George. Born on the 11th of September 1525 this prince had served in the field under Charles V., and, disliking his father's policy and associates, had absented himself from Berlin, and mainly confined his attention to administering the secularized bishopric of Brandenburg which he had obtained in 1560. When he became elector he hastened to put his ideas into practice. His father's favourites were exiled; foreigners were ousted from public positions and their places taken by natives; and important economies were effected, which earned for John George the surname of *Oekonom*, or steward. To lighten the heavy burden of debt left by Joachim the elector proposed a tax on wheat and other cereals. Some opposition was shown, but eventually the estates of both divisions of the mark assented; only, however at the price of concessions to the nobles, predominant in the diet, which thrust the peasantry into servitude. Thus the rule of John George was popular with the nobles, and to some extent with the towns. Protestant refugees from France and the Netherlands were encouraged to settle in Brandenburg, and a period of peace was beneficial to a land, the condition of which was still much inferior to that of other parts of Germany. In religion the elector was a follower of Luther, whose doctrines were prevalent among his people. He had accepted the *Formula Concordiæ*, a Lutheran document promulgated in June 1580, and sought to prevent any departure from its tenets. His dislike of Calvinism, or his antipathy to external complications, however, prevented him from taking any serious steps to defend Protestantism from the attacks of the counter-reformation. He did indeed join the league of Torgau, which voted assistance to Henry IV. of France in 1591; but he refused to aid the United Provinces, or even to give assistance to his eldest son, Joachim Frederick, administrator of the archbishopric of Magdeburg, whose claim to sit and vote in the imperial diet was contested, or to his grandson, John George, whose election to the bishopric of Strassburg was opposed by a Roman Catholic minority in the chapter. This indifference to the welfare of the Protestants added to the estrangement between the elector and his eldest son, which was further accentuated when John George, ignoring the *Dispositio Achillea*, bequeathed the new mark to one of his younger sons. He died on the 8th of January 1598.

Joachim Frederick, who now became elector, was born on the 27th of January 1546. Since 1553 he had held the bishopric of Havelberg, since 1555 that of Lebus; he had been administrator of Magdeburg since 1566, and of Brandenburg since 1571. Resigning these dignities in 1598, he contested his father's

will, and was successful in preventing a division of the electorate. An agreement with George Frederick, the childless margrave of Ansbach and Bayreuth, paved the way for an arrangement with the elector's younger brothers, who after the margrave's death in April 1603, shared his lands in Franconia, and were compensated in other ways for surrendering all claims on Brandenburg. This agreement, known as the Gera Bond, ratified the *Dispositio Achillea*. By George Frederick's death, Joachim became administrator of the duchy of Prussia, ruled nominally by the weak-minded Albert Frederick, but he had some difficulty in asserting his position. In Brandenburg he made concessions to the nobles at the expense of the peasantry, and admitted the right of the estates to control taxation. In religious matters he was convinced of the necessity of a union between Lutherans and Calvinists, and took steps to bring this about. Public opinion, however, in Brandenburg was too strong for him, and he was compelled to fall back upon the Lutheran *Formula* and the religious policy of his father. Joachim seems to have been a wise ruler, who improved in various ways the condition of the mark. He married Catherine, daughter of John, margrave of Brandenburg-Cüstrin, and when he died, on the 18th of July 1608, was succeeded by his eldest son John Sigismund.

The new elector, born on the 8th of November 1572, had married in 1594 Anna, daughter of Albert Frederick of Prussia, a union which not only strengthened the pretensions of the electors of Brandenburg to the succession in that duchy, but gave to John Sigismund a claim on the duchies of Cleves, Jülich and Berg, and other Rhenish lands should the ruling family become extinct. In March 1609 the death of Duke John William left these duchies without a ruler, and by arrangement they were occupied jointly by the elector and by his principal rival, Wolfgang, son of Philip Louis, count palatine of Neuburg. This proceeding aroused some opposition, and, complicated by religious considerations and by the excited state of European politics, almost precipitated a general war. However, in November 1612 the dispute was temporarily settled by the treaty of Xanten. Brandenburg obtained the duchy of Cleves with the counties of Mark and Ravensberg, but as the Dutch and Spanish garrisons were not withdrawn, these lands were only nominally under the elector's rule. In 1609, John Sigismund had joined the Evangelical Union, probably to win support in the Rhineland, and the same consideration was doubtless one reason why, in 1613, he forsook the Lutheran doctrines of his family, and became an adherent of the reformed, or Calvinist, faith. This step aroused grave discontent in the electorate, and, quickly abandoning his attempts to proselytize, the elector practically conceded religious liberty to his subjects. Over the Cleves-Jülich succession, John Sigismund had incurred heavy expenses, and the public debt had again mounted up. He was thus obliged to seek aid from the estates, and in return for grants to make concessions to the nobles. The elector spent much of his time in Prussia striving to assert his authority in that duchy, and in August 1618, according to the arrangement of 1569, became duke by the death of Albert Frederick. He only enjoyed this dignity for a short time, as he died on the 23rd of December 1619. He was succeeded by his eldest son, George William.

The new elector, born on the 3rd of November 1597, proved a weak and incapable ruler. He had married Elizabeth, daughter of Frederick IV., elector palatine of the Rhine, and sister of the elector Frederick V., afterwards king of Bohemia, and before his accession had acted as his father's representative in Cleves. Although a Protestant he was under the influence of Adam, count of Schwarzenberg, who was a Roman Catholic of imperialist sympathies. As a result the elector remained neutral during the early years of the Thirty Years' War in spite of his relationship with Frederick of the Palatinate, and the obvious danger to his Rhenish lands. This attitude was not successful. Brandenburg was ravaged impartially by both parties, and in 1627 George William attacked his brother-in-law, Gustavus Adolphus of Sweden, who was using

Prussia as a base of operations for his war against Poland. This campaign was short and inglorious for Brandenburg, and the elector was soon compelled to make peace. Although alarmed by the edict of restitution of 1629, George William took no steps to help the Protestants. In 1631, however, Gustavus Adolphus marched on Berlin, compelled the elector to cede the fortress of Spandau, and to aid him with men and money. The Brandenburg troops then assisted the Swedes until after the death of Gustavus in 1632, and the Swedish defeat at Nördlingen in 1634, when the elector assented to the treaty of Prague, which was made in May 1635 between the emperor Ferdinand II. and John George I., elector of Saxony. The imperialists did nothing, however, to drive the Swedes from Brandenburg, and the unfortunate land was entirely at the mercy of the enemy. This was the principal reason why the elector was unable to annex Pomerania when its last duke, Bogislaus XIV., died in 1637. In 1638 George William transferred his residence to Königsberg, leaving Schwarzenberg to administer the electorate. Although his harsh measures aroused some irritation, the count did something to rid the land of the Swedes and to mitigate its many evils; but its condition was still very deplorable when George William died at Königsberg on the 1st of December 1640, leaving an only son, Frederick William. The most important facts in the internal history of Brandenburg during the 16th century were the increase in the power of the estates, owing chiefly to the continuous pecuniary needs of the electors; the gradual decline in the political importance of the towns, due mainly to intestine feuds; and the lapse of the peasantry into servitude. These events gave a preponderance of power to the nobles, but concurrently a number of circumstances were silently preparing the way for a great increase of authority on the part of the ruler. The substitution of the elector for the pope as head of the church; the introduction of Roman law with its emphasis on a central authority and a central administration; the determined and successful efforts to avoid any partition of the electorate; and the increasing tendency of the separate sections of the diet to act independently; all tended in this direction. This new order was heralded in 1604 by the establishment of a council of state, devoted to the interests of the elector, which strengthened his authority, and paved the way for a bureaucratic government.

When Frederick William, the "Great Elector," became ruler of Brandenburg in 1640 he found the country in a very deplorable condition. Trade and agriculture were almost destroyed, and the inhabitants, compelled to support the Swedish army of occupation, suffered also from the disorderly conduct of the native soldiers. Although the young elector spent the two first years of his reign mainly in Prussia, he was by no means forgetful of Brandenburg, and began resolutely to root out the many evils which had sprung up during the feeble rule of his father. The powers of Schwarzenberg were curtailed; the state council was restored; and the licence of the soldiers was restrained, while their numbers were reduced. Then turning his attention to the Swedes a truce was arranged, and soon afterwards, in return for an indemnity, they agreed to evacuate the electorate. Having returned to Brandenburg in 1643, Frederick William remained neutral during the concluding years of the Thirty Years' War, and set to work to organize an army and to effect financial reforms. About the same time diplomatic methods freed Cleves, Mark and Ravensberg from foreign troops, but the estates of these lands gained a temporary victory when the elector attacked their privileges. However, in 1647 his title was formally admitted by Wolfgang, count palatine of Neuburg.

The terms of the treaty of Westphalia in 1648 are the best commentary on the general success of the elector's policy. Although he was obliged to give up his claim to the western part of Pomerania in favour of Sweden, he secured the eastern part of that duchy, together with the secularized bishoprics of Halberstadt, Minden and Kammin, and other lands, the whole forming a welcome addition to the area of Brandenburg. He was also promised the archbishopric of Magdeburg when its administrator, Augustus, duke of Saxe-Weissenfels, should die

Joachim
Frederick.

John
Sigismund.

Frederick
William,
the
"Great
Elector."

This event happened in 1680 when he secured the lands of the archbishopric. The elector did not, however, take possession of the newly-acquired territories at once. Fresh difficulties arose with Sweden, and it was not until 1653 that eastern Pomerania was freed from her soldiers. Meanwhile a new quarrel had broken out with Wolfgang of Neuburg. In 1650 Frederick William attacked his rival, but a variety of circumstances, among others a change of government in the Netherlands, and the resistance of the estates of Cleves, thwarted his plans, and he was compelled to listen to the mediating powers, and to acquiesce in the *status quo*.

Profiting by these reverses the elector then undertook a series of internal reforms, tending to strengthen the central authority, and to mitigate the constant lack of money, which was perhaps his chief obstacle to success; a work in which he was aided by George, count of Waldeck (1620-1692), who became his chief adviser about this time. In 1651 the powers of the state council were extended to include all the lands under the elector's rule; and a special committee was appointed to effect financial economies, and so to augment the electoral resources. In imperial politics Frederick William supported the election of Ferdinand, son of the emperor Ferdinand III., as king of the Romans in 1653; but when the emperor failed to fulfil his promises, influenced by Waldeck, he acted in opposition to the imperial interests, and even formed a plan for a great alliance against the Habsburgs. These projects were disturbed by the war which broke out in 1655 between Sweden and Poland. In this struggle the elector fought first on one side and then on the other; but the important consequences of his conduct belong rather to the history of the duchy of Prussia (*q.v.*). The transfer of the elector's support from Sweden to Poland in 1656 was followed by the fall from power of Waldeck, who was succeeded by Otto von Schwerin (1616-1679), under whose influence the elector's relations with the emperor became more cordial.

The increase in the prestige of Brandenburg was due chiefly to his army, which was gradually brought to a high state of efficiency. A proper organization was established to superintend the pay and maintenance of the soldiers, and they were commanded by experienced officers, among others by Georg Derfflinger (1606-1695), and Otto von Sparr (1605-1668). The general poverty, however, made the estates reluctant to support a standing army, and after the peace of Oliva in 1660, it was reduced to about 3500 men. The continual difficulties with the estates of his different dominions had harassed and hampered the elector, and the general peace which followed the treaty of Oliva offered a favourable opportunity to curtail their powers. Undaunted by two previous rebuffs he attacked the estates of Cleves, and by a display of force gained a substantial victory. Some important privileges were annulled, and he obtained a considerable sum of money. The *Landtag* of Brandenburg was not cowed so easily into submission, but an increase of revenue was obtained, and the stubborn struggle which ensued in Prussia ended in a victory for the ruler. This increased income enabled the elector to take a more considerable part in European politics. In 1663 he assisted the imperialists in their struggle with the Turks; in 1666 the dispute over Cleves, Mark and Ravensberg was finally settled, and Brandenburg were confirmed in the possession of these lands; and in the same year a reconciliation was effected with Sweden. Several disputes which threatened to disturb the peace of the Empire were settled through his mediation, and he compelled the citizens of Magdeburg to do homage to him. In religious matters he interceded with the emperor and the diet for the Protestants, and sought, but without success, to bring about a reconciliation between Lutherans and Calvinists in Brandenburg.

The elector's relations with Louis XIV. of France are full of interest. After the conclusion of the war of devolution in 1667, he allied himself with Louis, and together they agreed to support the candidature of Wolfgang of Neuburg for the vacant Polish throne. In 1668, moreover, he refused to join the triple alliance against France, but soon afterwards became aware of the danger to his country from the aggressive policy of Louis. The United

Provinces were bound to him by religious interests, political considerations, and family ties alike, and he could not be indifferent when their position was threatened by France. In spite of tempting offers from Louis, he was the first to join the Dutch when they were attacked by Louis in 1672, and conducted an ineffectual campaign on the Rhine until June 1673, when he was forced to make peace. In July 1674, however, he joined the Empire, the United Provinces and Spain, and in return for a subsidy, fought against France in Alsace. Meanwhile Louis had instigated the Swedes to invade Brandenburg, which had been left to the care of John George II., prince of Anhalt-Dessau. Hastening from Franconia to defend the electorate, Frederick William gained a complete victory over a superior number of the enemy at Fehrbellin on the 28th of June 1675, a great and glorious day for the arms of Brandenburg. Aided by the imperialists and the Danes, he followed up this success, and cleared Brandenburg and Pomerania of the Swedes, capturing Stettin in 1677 and Stralsund in 1678, while an attack made by Sweden on Prussia was successfully repelled. The general peace of Nijmegen was followed by the treaty of St Germain-en-Laye in June 1679 between Sweden and Brandenburg. Owing, however, to the insistence of Louis XIV. and the indifference, or weakness, of the emperor Leopold I., the elector was forced to restore western Pomerania to Sweden, in return for the payment of 300,000 crowns by France. This feebleness on the part of his ally induced Frederick William to listen more readily to the overtures of Louis, and in 1679, and again in 1681, he bound himself to support the interests of France. He had, moreover, a further grievance against the emperor as Leopold refused to recognize his right to the Silesian duchies of Liegnitz, Brieg and Wohlau, which had been left without a ruler in 1675. About 1684, however, the foreign policy of Brandenburg underwent another change. Disliking the harshness shown by Louis to the Protestants, the elector concluded an alliance with William, prince of Orange, in August 1683; and entered into more friendly relations with the emperor. Further incensed against France by the revocation of the edict of Nantes in 1685, he made an alliance with Leopold in January 1686, agreeing in return for a subsidy to send troops against the Turks. Soon afterwards he received Schwiebus to compensate him for abandoning his claim on the Silesian duchies, and in a secret treaty made promises of support to Leopold. The great elector died in May 1688, leaving his territories to his eldest son, Frederick.

The remarkable services of Frederick William to his country can best be judged by comparing its condition in 1640 with that in 1688. At his accession the greater part of his territory was occupied by strangers and devastated by war, and in European politics Brandenburg was merely an appendage of the empire. Its army was useless; its soil was poor; its revenue was insignificant. At his death the state of Brandenburg-Prussia was a power to be reckoned with in all European combinations. Inferior to Austria alone among the states of the Empire, it was regarded as the head of the German Protestantism; while the fact that one-third of its territory lay outside the Empire added to its importance. Its area had been increased to over 40,000 sq. m.; its revenue had multiplied sevenfold; and its small army was unsurpassed for efficiency. The elector had overthrown Sweden and inherited her position on the Baltic, and had offered a steady and not ineffectual resistance to the ambition of France.

While thus winning for himself a position in the councils of Europe, Frederick William was not less active in strengthening the central authority within his own dominions. He found Brandenburg a constitutional state, in which the legislative power was shared between the elector and the diet; he left it to his successor substantially an absolute monarchy. Many circumstances assisted to bring about this change, among the chief of which were the want of harmonious action on the part of the estates, and the decline in the political power of the towns. The substitution of a permanent excise for the subsidies granted from time to time by the estates also tended to increase his independence, and the officials or *Steuerräthe*, appointed by him to collect this tax in the towns, gradually absorbed many of

the administrative functions of the local authorities. The nobles and prelates generally preferred to raise their share of the revenue by the old method of a *bede*, or contribution, thus weakening the remaining bond between them and the burghers.

In matters of general administration Frederick William showed himself a prudent and careful ruler, and laid the foundation of the future greatness of Prussia in almost every department. The wounds inflicted by the Thirty Years' War were in a great measure healed, and the finances and credit of the state were established on a firm basis. Agriculture and commerce were improved and encouraged by a variety of useful measures, and in this connexion the settlement of a large number of Flemings, and the welcome extended to French Protestants, both before and after the revocation of the edict of Nantes, were of incalculable service. A small but efficient navy was founded, and strict economy, together with increasing resources, enabled a disciplined army to be maintained. Education was not neglected, a trading company was established, and colonies were founded on the west coast of Africa. In religious matters Calvinists and Lutherans were placed upon an equality, but the elector was unable to impress his own spirit of tolerance upon the clergy, who were occupied with ecclesiastical squabbles while the state of education and of public morals left much to be desired. The condition of the peasantry, however, during this reign reached its lowest point, and the "recess," or charter, of 1653 practically recognizes the existence of villenage. While the nobles had been losing power with regard to the ruler they had been increasing it at the expense of the peasants. The Thirty Years' War afforded them frequent opportunities of replacing the village *Schulzen*, or magistrates, with officials of their own; and the fact that their share of taxation was wholly wrung from the peasants made the burden of the latter much heavier than that of the townsmen.

The new elector, Frederick III., followed in general the policy of his father. Having persuaded his step-brothers to surrender the principalities bequeathed to them by the great elector, he assisted William of Orange to make his descent on England; then in 1688 allied himself with other German princes against Louis XIV., and afterwards fought for the Empire against both France and Turkey. Before he became elector Frederick had promised the emperor that he would restore Schwiebus, and he was now called upon to fulfil this engagement, which after some murmuring he did in 1695. This fact, however, together with some slights put upon him at the peace of 1697, led him to look with less favour upon imperial interests. Frederick's chief adviser about this time was Eberhard Danckelmann (1643-1722), whose services in continuing the reforming work of the great elector were very valuable; but having made many enemies, the electress Sophia among them, he fell from power in 1697, and was imprisoned for several years. The most important work of the elector was to crown the labours of his father by securing the kingly title for himself and his descendants. Broached in 1692 this matter was brought up again in 1698 when the emperor and his ministers, faced with the prospect of a fight over the Spanish succession, were anxious to conciliate Brandenburg. It was at length decided that the title should be taken from Prussia rather than from Brandenburg as the former country lay outside the Empire, and in return Frederick promised to assist Leopold with 8000 men. The coronation ceremony took place at Königsberg on the 18th of January 1701. The territorial additions to Brandenburg during this reign were few and unimportant, but the comparative wealth and prosperity enabled the elector to do a good deal for education, and to spend some money on buildings. In 1694 the university of Halle was founded; academies for arts and sciences were established, and Berlin was greatly improved. The subsequent history of Brandenburg is merged in that of Prussia (*q.v.*).

BIBLIOGRAPHY.—H. Brosien, *Geschichte der Mark Brandenburg im Mittelalter* (Leipzig, 1887); G. G. Küster, *Bibliotheca historica Brandenburgensis* (Breslau, 1743); and *Accessiones* (Breslau, 1768); and *Collectio opusculorum historiarum marchicam illustrantium* (Breslau, 1731-1733); A. Voss and G. Stimming, *Vorgeschichtliche Altertümer aus der Mark Brandenburg* (Berlin, 1886-1890); F. Voigt, *Geschichte des brandenburgisch-preussischen Staats* (Berlin,

1878); E. Berner, *Geschichte des preussischen Staats* (Berlin, 1890-1891); A. F. Riedel, *Codex diplomaticus Brandenburgensis* (Berlin, 1838-1865); J. Heidemann, *Die Reformation in der Mark Brandenburg* (Berlin, 1889); *Forstungen zur brandenburgischen und preussischen Geschichte*, edited by R. Koser (Leipzig, 1888 fol.); T. Carlyle, *History of Frederick the Great*, vol. i. (London, 1858); J. G. Droysen, *Geschichte der preussischen Politik* (Berlin, 1855-1886); E. Lavisse, *Étude sur une des origines de la monarchie prussienne* (Paris, 1875); B. Gebhardt, *Handbuch der deutschen Geschichte*, Band ii. (Leipzig, 1901). (A. W. H.)

BRANDENBURG, the central and one of the largest provinces of Prussia, consisting of a part of the former electorate of Brandenburg from which it derives its name. With the other territories of the elector of Brandenburg, it was merged in 1701 in the kingdom of Prussia, and when the administration of Prussia was reformed in 1815, Brandenburg became one of the provinces of Prussia. The boundaries of the new province, however, differed considerably from those of the old district. The old mark, the district on the left bank of the Elbe, was added to the province of Saxony, and in return a district to the south, taken from the kingdom of Saxony, was added to the province of Brandenburg. It has an area of 15,382 sq. m., and is divided into the two governments of Potsdam and Frankfurt-on-Oder; the capital, Berlin, forming a separate jurisdiction. The province is a sandy plain interspersed with numerous fertile districts and considerable stretches of woodland, mostly pine and fir. Its barrenness was formerly much exaggerated, when it was popularly described as the "sandbox of the Holy Roman Empire." It is generally well watered by tributaries of its two principal rivers, the Elbe and the Oder, and is besides remarkable for the number of its lakes, of which it contains between 600 and 700. The mineral products comprise lignite, limestone, gypsum, alum and potter's earth; barley and rye are the usual cereals; fruits and vegetables are abundant; and considerable quantities of hemp, flax, hops and tobacco are raised. The breeding of sheep receives much attention, and the province exports wool in considerable quantity. Bees are largely kept, and there is an abundance of game. The rivers and lakes also furnish fish, particularly carp, of excellent quality. The climate is cold and raw in winter, excessively hot in summer, and there are frequently violent storms of wind. The manufacturing industry of the province is both varied and extensive, but is for the most part concentrated in the principal towns. The most important branches are the spinning and weaving of wool and cotton, the manufacturing of paper, and the distillation of brandy. Pop. (1895) 2,821,695; (1905) 3,529,839.

BRANDENBURG, a town of Germany, capital of the district and province of same name, on the river Havel, 36 m. S.W. from Berlin, on the main line to Magdeburg and the west. Pop. (1905) 51,251, including 3643 military. The town is enclosed by walls, and is divided into three parts by the river—the old town on the right and the new town on the left bank, while on an island between them is the "cathedral town,"—and is also called, from its position, "Venice." Many of the houses are built on piles in the river. There are five old churches (Protestant), all more or less noteworthy. These are the Katharinenkirche (nave 1381-1401, choir c. 1410, western tower 1583-1585), a Gothic brick church with a fine carved wooden altar and several interesting medieval tombs; the Petrikirche (14th century Gothic); the cathedral (Domkirche), originally a Romanesque basilica (1170), but rebuilt in the Gothic style in the 14th century, with a good altar-piece (1465), &c., and noted for its remarkable collection of medieval vestments; the Gothardskirche, partly Romanesque (1166), partly Gothic (1348); the Nikolaikirche (12th and 13th centuries), now no longer used. There is also a Roman Catholic church. Of other buildings may be mentioned the former town hall of the "old town" (Altstadt Rathaus), built in the 13th and 14th centuries, now used as government offices; the new Real-gymnasium; and the town hall in the Neustadt, before which, in the market-place, stands a Rolandssäule, a colossal figure 18 ft. in height, hewn out of a single block of stone. A little north of the town is the Marienberg, or Harlungerberg, on which the heathen temple of Triglaff and afterwards the church and convent of St Mary were built. On the top stands a lofty monument

to the soldiers from the Mark who fell in the wars of 1864, 1866 and 1870-71. The town has a considerable trade, with manufactures of woollens, silks, linens, hosiery and paper, as well as breweries, tanneries, boat-building and bicycle factories.

Brandenburg, originally *Brennaburg* (*Brennabor*) or *Brendenburg*, was originally a town of the Slavic tribe of the Hevellin, from whom it was captured (927-928) by the German king Henry I. In 948 Otto I. founded a bishopric here, which was subordinated first to the archdiocese of Mainz, but from 968 onwards to the newly created archbishopric of Magdeburg. It was, however, destroyed by the heathen Wends in 983, and was only restored when Albert the Bear recaptured the town from them in 1153. In 1539 the bishop of Brandenburg, Matthias von Jagow, embraced the Lutheran faith, and five years later the Protestant worship was established in the cathedral. The see was administered by the elector of Brandenburg until 1598 and then abolished, its territories being for the most part incorporated in the electoral domains. The cathedral chapter, however, survived, and though suppressed in 1810, it was restored in 1824. It consists of twelve canons, of whom three only are spiritual, the other nine prebends being held by noblemen; all are in the gift of the king of Prussia.

The "old" and "new" towns of Brandenburg were for centuries separate towns, having been united under a single municipality so late as 1717.

See Schillmann, *Geschichte der Stadt Brandenburg* (Brandenburg, 1874-1882).

BRANDER, GUSTAVUS (1720-1787), English naturalist, who came of a Swedish family, was born in London in 1720, and was brought up as a merchant, in which capacity he achieved success and became a director of the Bank of England. His leisure time was occupied in scientific pursuits, and at his country residence at Christchurch in Hampshire he became interested in the fossils so abundant in the clays of Hordwell and Barton. A set of these was presented by him to the British Museum, and they were described by D. C. Solander in the beautifully illustrated work entitled *Fossilia Hantoniensis collecta, et in Museo Britannico deposita a Gustavo Brandero* (London, 1766). Brandero was elected F.R.S. in 1754, and he was also a trustee of the British Museum. He died on the 21st of January 1787.

BRANDES, GEORG MORRIS COHEN (1842-), Danish critic and literary historian, was born in Copenhagen on the 4th of February 1842. He became a student in the university in 1859, and first studied jurisprudence. From this, however, his maturer taste soon turned to philosophy and aesthetics. In 1862 he won the gold medal of the university for an essay on *The Nemesis Idea among the Ancients*. Before this, indeed since 1858, he had shown a remarkable gift for verse-writing, the results of which, however, were not abundant enough to justify separate publication. Brandes, indeed, did not collect his poems till so late as 1898. At the university, which he left in 1864, Brandes was much under the influence of the writings of Heiberg in criticism and Sören Kierkegaard in philosophy, influences which have continued to leave traces on his work. In 1866 he took part in the controversy raised by the works of Rasmus Nielsen in a treatise on "Dualism in our Recent Philosophy." From 1865 to 1871 he travelled much in Europe, acquainting himself with the condition of literature in the principal centres of learning. His first important contribution to letters was his *Aesthetic Studies* (1868), in which, in several brief monographs on Danish poets, his maturer method is already foreshadowed. In 1870 he published several important volumes, *The French Aesthetics of Our Days*, dealing chiefly with Taine, *Criticisms and Portraits*, and a translation of *The Subjection of Women* of John Stuart Mill, whom he had met that year during a visit to England. Brandes now took his place as the leading critic of the north of Europe, applying to local conditions and habits of thought the methods of Taine. He became *docent* or reader in *Belles Lettres* at the university of Copenhagen, where his lectures were the sensation of the hour. On the professorship of Aesthetics becoming vacant in 1872, it was taken as a matter of course that Brandes would be appointed. But the young critic had offended many sus-

ceptibilities by his ardent advocacy of modern ideas; he was known to be a Jew, he was convicted of being a Radical, he was suspected of being an atheist. The authorities refused to elect him, but his fitness for the post was so obvious that the chair of Aesthetics in the university of Copenhagen remained vacant, no one else daring to place himself in comparison with Brandes. In the midst of these polemics the critic began to issue the most ambitious of his works, *Main Strøms in the Literature of the Nineteenth Century*, of which four volumes appeared between 1872 and 1875 (English translation, 1901-1905). The brilliant novelty of this criticism of the literature of the chief countries of Europe at the beginning of the 19th century, and his description of the general revolt against the pseudo-classicism of the 18th century, at once attracted attention outside Denmark. The tumult which gathered round the person of the critic increased the success of the work, and the reputation of Brandes grew apace, especially in Germany and Russia. Among his later writings must be mentioned the monographs on *Sören Kierkegaard* (1877), on *Esaias Tegner* (1878), on *Benjamin Disraeli* (1878), *Ferdinand Lassalle* (in German, 1877), *Ludvig Holberg* (1884), on *Henrik Ibsen* (1899) and on *Anatole France* (1905). Brandes has written with great fulness on the main contemporary poets and novelists of his own country and of Norway, and he and his disciples have long been the arbiters of literary fame in the north. His *Danish Poets* (1877), containing studies of Carsten Hauch, Ludwig Bødtscher, Christian Winther, and Paludan-Müller, his *Men of the Modern Transition* (1883), and his *Essays* (1889), are volumes essential to the proper study of modern Scandinavian literature. He wrote an excellent book on *Poland* (1888; English translation, 1903), and was one of the editors of the German version of *Ibsen*. In 1877 Brandes left Copenhagen and settled in Berlin, taking a considerable part in the aesthetic life of that city. His political views, however, made Prussia uncomfortable for him, and he returned in 1883 to Copenhagen, where he found a whole new school of writers and thinkers eager to receive him as their leader. The most important of his recent works has been his study of Shakespeare (1897-1898), which was translated into English by William Archer, and at once took a high position. It was, perhaps, the most authoritative work on Shakespeare, not principally intended for an English-speaking audience, which had been published in any country. He was afterwards engaged on a history of modern Scandinavian literature. In his critical work, which extends over a wider field than that of any other living writer, Brandes has been aided by a singularly charming style, lucid and reasonable, enthusiastic without extravagance, brilliant and coloured without affectation. His influence on the Scandinavian writers of the 'eighties was very great, but a reaction, headed by Holger Drachmann, against his "realistic" doctrines, began in 1885 (see DENMARK: *Literature*). In 1900 he collected his works for the first time in a complete and popular edition, and began to superintend a German complete edition in 1902.

His brother Edvard Brandes (b. 1847), also a well-known critic, was the author of a number of plays, and of two psychological novels: *A Politician* (1889), and *Young Blood* (1899).

BRANDING (from Teutonic *brinnan*, to burn), in criminal law a mode of punishment; also a method of marking goods or animals; in either case by stamping with a hot iron. The Greeks branded their slaves with a Delta, Δ, for Δούλος. Robbers and runaway slaves were marked by the Romans with the letter F (*fur*, *fugitivus*); and the toilers in the mines, and convicts condemned to figure in gladiatorial shows, were branded on the forehead for identification. Under Constantine the face was not permitted to be so disfigured, the branding being on the hand, arm or calf. The canon law sanctioned the punishment, and in France galley-slaves could be branded "TF" (*travaux forcés*) until 1832. In Germany, however, branding was illegal. The punishment was adopted by the Anglo-Saxons, and the ancient law of England authorized the penalty. By the Statute of Vagabonds (1547) under Edward VI. vagabonds, gipsies and brawlers were ordered to be branded, the first two with a large V on the breast, the last with F for "fraymaker." Slaves, too,

who ran away were branded with S on cheek or forehead. This law was repealed in 1636. From the time of Henry VII. branding was inflicted for all offences which received benefit of clergy (*q.v.*), but it was abolished for such in 1822. In 1698 it was enacted that those convicted of petty theft or larceny, who were entitled to benefit of clergy, should be "burnt in the most visible part of the left cheek, nearest the nose." This special ordinance was repealed in 1707. James Nayler, the mad Quaker, who in the year 1655 claimed to be the Messiah, had his tongue bored through and his forehead branded B for blasphemer.

In the Lancaster criminal court a branding-iron is still preserved in the dock. It is a long bolt with a wooden handle at one end and an M (malefactor) at the other. Close by are two iron loops for firmly securing the hands during the operation. The brander, after examination, would turn to the judge and exclaim, "A fair mark, my lord." Criminals were formerly ordered to hold up their hands before sentence to show if they had been previously convicted.

Cold branding or branding with cold irons became in the 18th century the mode of nominally inflicting the punishment on prisoners of higher rank. "When Charles Moritz, a young German, visited England in 1782 he was much surprised at this custom, and in his diary mentioned the case of a clergyman who had fought a duel and killed his man in Hyde Park. Found guilty of manslaughter he was *burnt* in the hand, if that could be called burning which was done with a cold iron" (Markham's *Ancient Punishments of Northerns*, 1886). Such cases led to branding becoming obsolete, and it was abolished in 1820 except in the case of deserters from the army. These were marked with the letter D, not with hot irons but by tattooing with ink or gunpowder. Notoriously bad soldiers were also branded with BC (bad character). By the British Mutiny Act of 1858 it was enacted that the court-martial, in addition to any other penalty, may order deserters to be marked on the left side, 2 in. below the armpit, with the letter D, such letter to be not less than 1 in. long. In 1879 this was abolished.

See W. Andrews, *Old Time Punishments* (Hull, 1890); A. M. Earle, *Curious Punishments of Bygone Days* (London, 1896).

BRANDIS, CHRISTIAN AUGUST (1790-1867), German philologist and historian of philosophy, was born at Hildesheim and educated at Kiel University. In 1812 he graduated at Copenhagen, with a thesis *Commentationes Eleaticae* (a collection of fragments from Xenophanes, Parmenides and Melissus). For a time he studied at Göttingen, and in 1815 presented as his inaugural dissertation at Berlin his essay *Von dem Begriff der Geschichte der Philosophie*. In 1816 he refused an extraordinary professorship at Heidelberg in order to accompany B. G. Niebuhr to Italy as secretary to the Prussian embassy. Subsequently he assisted I. Bekker in the preparation of his edition of Aristotle. In 1821 he became professor of philosophy in the newly founded university of Bonn, and in 1823 published his *Aristoteles et Theophrasti Metaphysica*. With Boeckh and Niebuhr he edited the *Rheinisches Museum*, to which he contributed important articles on Socrates (1827, 1829). In 1836-1839 he was tutor to the young king Otho of Greece. His great work, the *Handbuch der Geschichte der griechisch-röm. Philos.* (1835-1866; republished in a smaller and more systematic form, *Gesch. d. Entwicklungen d. griech. Philos.*, 1862-1866), is characterized by sound criticism. Brandis died on the 21st of July 1867.

See Trendelenburg, *Zur Erinnerung an C. A. B.* (Berlin, 1868).

BRANDON, a city and port of entry of Manitoba, Canada, on the Assiniboine river, and the Canadian Pacific and Canadian Northern railways, situated 132 m. W. of Winnipeg, 1184 ft. above the sea. Pop. (1891) 3778; (1907) 12,519. It is in one of the finest agricultural sections and contains a government experimental farm, grain elevators, saw and grist mills. It was first settled in 1881, and incorporated as a city in 1882.

BRANDON, a market town in the Stowmarket parliamentary division of Suffolk, England, on the Little Ouse or Brandon river, 8½ m. N.N.E. from London by the Ely-Norwich line of the Great Eastern railway. Pop. (1901) 2327. The church of St Peter is Early English with earlier portions; there is a free

grammar school founded in 1646; and the town has some carrying trade by the Little Ouse in corn, coal and timber. Rabbit skins of fine texture are dressed and exported. Extensive deposits of flint are worked in the neighbourhood, and the work of the "flint-knappers" has had its counterpart here from the earliest eras of man. Close to Brandon, but in Norfolk across the river, at the village of Weeting, are the so-called Grimes' Graves, which, long supposed to show the foundations of a British village, and probably so occupied, were proved by excavation to have been actually neolithic flint workings. The pits, though almost completely filled up (probably as they became exhausted), were sunk through the overlying chalk to the depth of 20 to 60 ft., and numbered 254 in all. Passages branched out from them, and among other remains picks of deer-horn were discovered, one actually bearing in the chalk which coated it the print of the workman's hand.

BRANDY, an alcoholic, potable spirit, obtained by the distillation of grape wine. The frequently occurring statement that the word "brandy" is derived from the High German *Branntwein* is incorrect, inasmuch as the English word (as Fairley has pointed out) is quite as old as any of its continental equivalents. It is simply an abbreviation of the Old English *brandewine*, *brand-wine* or *brandy wine*, the word "brand" being common to all the Teutonic languages of northern Europe, meaning a thing burning or that has been burnt. John Fletcher's *Beggar's Bush* (1622) contains the passage, "Buy brand wine"; and from the Roxburgh *Ballads* (1650) we have "It is more fine than brandewine." The word "brandy" came into familiar use about the middle of the 17th century, but the expression "brandywine" was retained in legal documents until 1702 (Fairley). Thus in 1697 (*View Penal Laws*, 173) there occurs the sentence, "No aqua vitæ or brandywine shall be imported into England." The *British Pharmacopœia* formerly defined French brandy, which was the only variety mentioned (officially *spiritus vini gallici*), as "Spirit distilled from French wine; it has a characteristic flavour, and a light sherry colour derived from the cask in which it has been kept." In the latest edition the Latin title *spiritus vini gallici* is retained, but the word *French* is dropped from the text, which now reads as follows: "A spirituous liquid distilled from wine and matured by age, and containing not less than 36½% by weight or 43½% by volume of ethyl hydroxide." The *United States Pharmacopœia* (1905) retains the Latin expression *spiritus vini gallici* (English title *Brandy*), defined as "an alcoholic liquid obtained by the distillation of the fermented, unmodified juice of fresh grapes."

Very little of the brandy of commerce corresponds exactly to the former definition of the *British Pharmacopœia* as regards colouring matter, inasmuch as trade requirements necessitate the addition of a small quantity of caramel (burnt sugar) colouring to the spirit in the majority of cases. The object of this is, as a rule, not that of deceiving the consumer as to the apparent age of the brandy, but that of keeping a standard article of commerce at a standard level of colour. It is practically impossible to do this without having recourse to caramel colouring, as, practically speaking, the contents of any cask will always differ slightly, and often very appreciably, in colour intensity from the contents of another cask, even though the age and quality of the spirits are identical.

The finest brandies are produced in a district covering an area of rather less than three million acres, situated in the departments of Charente and Charente Inférieure, of which the centre is the town of Cognac. It is generally held that only brandies produced within this district have a right to the name "cognac." The Cognac district is separated into district zones of production, according to the quality of the spirit which each yields. In the centre of the district, on the left bank of the Charente, is the *Grande Champagne*, and radiating beyond it are (in order of merit of the spirit produced) the *Petite Champagne*, the *Borderies* (or *Premiers Bois*), the *Fins Bois*, the *Bons Bois*, the *Bois Ordinaires*, and finally the *Bois communs dits à terroir*. Many hold that the brandy produced in the two latter districts is not entitled to the name of "cognac," but this is a matter of controversy, as

is also the question as to whether another district called the *Grande Fine Champagne*, namely, that in the immediate neighbourhood of the little village of Julliac-le-Coq, should be added to the list. The pre-eminent quality of the Cognac brandies is largely due to the character of the soil, the climate, and the scientific and systematic cultivation of the vines. For a period—from the

which increases with age, furfural, which decreases, and small quantities of other matters of which we have as yet little knowledge.

The table gives analyses, by the present author (excepting No. 3, which is by F. Lusson), of undoubtedly genuine commercial cognac brandies of various ages.

GENUINE COGNAC BRANDIES.

(Excepting the alcohol, results are expressed in grammes per 100 litres of absolute alcohol.)

Age, &c.	Alcohol % by vol.	Total Acid.	Non-volatile Acid.	Esters.	"Higher Alcohols."	Aldehyde.	Furfural.
1. New 1904	61.7	45	5	82	125	8	2.3
2. New, still heated by steam coil	56.3	22	4	61	100	3	1.2
3. New	67.7	51	..	158	152	6	1.3
4. Five years old, 1900 vintage	57.7	92	37	125
5. 1875 vintage, pale	46.7	144	37	177	261	55	1.0
6. 1848 vintage, brown	38.5	254	109	190	488	32	2.1

Note.—In the above table the acid is expressed in terms of acetic acid, the esters are expressed as ethyl acetate, and the aldehyde as acetaldehyde. The "Higher Alcohol" figures do not actually represent these substances, but indicate the relative coloration obtained with sulphuric acid when compared with an iso-butyl standard under certain conditions.

middle 'seventies to the 'nineties of the 19th century—the cognac industry was, owing to the inroads of the phylloxera, threatened with almost total extinction, but after a lengthy series of experiments, a system of replanting and hybridizing, based on the characteristics of the soils of the various districts, was evolved, which effectually put a stop to the further progress of the disease. In 1907 the area actually planted with the vine in the Cognac district proper was about 200,000 acres, and the production of cognac brandy, which, however, varies widely in different years, may be put down at about five million gallons per annum. The latter figure is based on the amount of wine produced in the two Charentes (about forty-five million gallons in 1905).

Brandy is also manufactured in numerous other districts in France, and in general order of commercial merit may be mentioned the brandies of Armagnac, Marmande, Nantes and Anjou. The brandies commanding the lowest prices are broadly known as the *Trois-Six de Montpellier*. In a class by themselves are the *Eaux-de-vie de Marc*, made from the wine pressings or from the solid residues of the stills. Some of these, particularly those made in Burgundy, have characteristic qualities, and are considered by many to be very fine. The consumption is chiefly local. Brandy of fair quality is also made in other wine-producing countries, particularly in Spain, and of late years colonial (Australian and Cape) brandies have attracted some attention. The consumption of brandy in the United Kingdom amounts to about two million gallons.

Brandy, in common with other potable spirits, owes its flavour and aroma to the presence of small quantities of substances termed secondary or by-products (sometimes "impurities"). These are dissolved in the ethyl alcohol and water which form over 90% of the spirit. The nature and quantity of all of these by-products have not yet been fully ascertained, but the knowledge in this direction is rapidly progressing. Ch. Ordonneau fractionally distilled 100 litres of 25-year-old cognac brandy, and obtained the following substances and quantities thereof:—

	Grammes in 100 Litres.
Normal propyl alcohol	40.0
Normal butyl alcohol	218.6
Amyl alcohol	83.8
Hexyl alcohol	0.6
Heptyl alcohol	1.3
Ethyl acetate	35.0
Ethyl propionate, butyrate and caproate	3.0
Oenanthic ether (about)	4.0
Aldehyde	3.0
Acetal	traces
Amines	traces

Most of the above substances, in fact probably all of them, excepting the oenanthic ether, are contained in other spirits, such as whisky and rum. The oenanthic ether (ethyl pterogonate) is one of the main characteristics which enable us chemically to differentiate between brandy and other distilled liquors. Brandy also contains a certain quantity of free acid,

Storage and Maturation.—Brandy is stored in specially selected oak casks, from which it extracts a certain quantity of colouring matter and tannin, &c. Commercial cognac brandies are generally blends of different growths and vintages, the blending being accomplished in large vats some little time prior to bottling. The necessary colouring and sweetening matter is added in the vat. In the case of pale brandies very little colouring and sweetening are added, the usual quantity being in the neighbourhood of $\frac{1}{2}$ to 1%. Old "brown brandies," which are nowadays not in great demand, require more caramel and sugar than do the pale varieties. The preparation of the "liqueur," as the mixed caramel and sugar syrup is termed, is an operation requiring much experience, and the methods employed are kept strictly secret. Fine "liqueur" is prepared with high-class brandy, and is stored a number of years prior to use. Brandy, as is well known, improves very much with age (for chemical aspects of maturation see SPIRITS), but this only holds good when the spirit is in wood, for there is no material appreciation in quality after bottling. It is a mistake to believe, however, that brandy improves indefinitely, even when kept in wood, for, as a matter of fact, after a certain time—which varies considerably according to the type of brandy, the vintage, &c.—there is so much evaporation of alcohol that a number of undesirable changes come about. The brandy begins to "go back," and becomes, as it is called, "worn" or "tired." It is necessary, therefore, that the bottling should not be deferred too long. Sometimes, for trade reasons, it is necessary to keep brandy in cask for a long period, and under these conditions the practice is to keep a series of casks, which are treated as follows:—The last cask is kept filled by occasionally adding some spirit from the cask next in order, the latter is filled up by spirit taken from the third cask from the end, and so on, until the first cask in the row is reached. The latter is filled up or "topped" with some relatively fresh spirit.

Brandy is much employed medicinally as a food capable of supplying energy in a particularly labile form to the body, as a stimulant, carminative, and as a hypnotic.

Adulteration.—A good deal has been written about the preparation of artificial brandy by means of the addition of essential oils to potato or beetroot spirit, but it is more than doubtful whether this practice was really carried on on a large scale formerly. What undoubtedly did occur was that much beet, potato or grain spirit was used for blending with genuine grape spirit. Prosecutions under the Food and Drugs Act, by certain English local authorities in the year 1904, resulted in the practical fixation of certain chemical standards which, in the opinion of the present writer, have, owing to their arbitrary and unscientific nature, resulted in much adulteration of a type previously non-existent. There is no doubt that at the present time artificial esters and higher alcohols, &c., are being used on an extensive scale for the preparation of cheap brandies, and the position, in this respect, therefore, has not been improved. Where formerly fraud was practically confined to the blending

of genuine brandy with spirit other than that derived from the grape, it is now enhanced by the addition of artificial essences to the blend of the two spirits. (P. S.)

BRANDYWINE, the name of a stream in Pennsylvania and Delaware, U.S.A., which runs into the Delaware river a few miles east of Wilmington, Delaware. It is famous as the scene of the battle of Brandywine in the American War of Independence, fought on the 11th of September 1777 about 10 m. north-west of Wilmington, and a few miles inside the Pennsylvania border. Sir William Howe, the British commander-in-chief, while opposed to Washington's army in New Jersey, had formed the plan of capturing Philadelphia from the south side by a movement by sea to the head of Delaware Bay. But contrary winds and accidents delayed the British transports so long that Washington, who was at first puzzled, was able to divine his opponents' intentions in time; and rapidly moving to the threatened point he occupied a strong entrenched position at the fords over the Brandywine, 25 m. south-west of Philadelphia. Here on the 11th of September the British attacked him. Howe's plan, which was carefully worked out and exactly executed, was to deliver an energetic feint attack against the American front, to take a strong column 12 m. up the stream, and crossing beyond Washington's right to attack his entrenchments in rear. Washington was successfully held in play during the movement, and General Sullivan, the commander of the American right wing, misled by the conflicting intelligence which reached him from up-stream, was surprised about noon by definite information as to the approach of Cornwallis on his right rear. Changing front "right back" in the dense country, he yet managed to oppose a stubborn resistance to the flanking attack, and with other troops that were hurried to the scene his division held its ground for a time near Birmingham meeting-house. But Howe pressed his attack sharply and drove back the Americans for 2 m.; the holding attack of the British right was converted into a real one, and by nightfall Washington was in full retreat northward toward Chester, protected by General Greene and a steady rear-guard, which held off Howe's column for the necessary time. The British were too exhausted to pursue, and part of Howe's force was inextricably mixed up with the advancing troops of the frontal attack. The American loss in killed, wounded and prisoners was about 1000; that of the British less than 600. Howe followed up his victory, and on the 27th of September entered Philadelphia.

BRANFORD, a township, including a borough of the same name, in New Haven county, Connecticut, U.S.A., at the mouth of the Branford river and at the head of a short arm of Long Island Sound, about 7 m. E.S.E. of New Haven. Pop. of the township (1890) 4460; (1900) 5706 (1068 foreign-born); (1910) 6047; of the borough (1910) 2560. The borough is served by the New York, New Haven & Hartford railway, and by an electric line connecting with New Haven. A range of rocky hills commands fine views of the Sound, the shore is deeply indented, the harbour and bays are dotted with islands, and the harbour is deep enough for small craft, and these natural features attract many visitors during the summer season. In Branford is the James Blackstone Memorial library (1896), designed by Solon Spencer Beman (b. 1853) in the Ionic style (the details being taken from the Erechtheum at Athens). On the interior of the dome which covers the rotunda are a series of paintings by Oliver Dennett Grover (b. 1861) illustrating the evolution of book-making, and between the arches are medallion portraits, by the same artist, of New England authors—Longfellow, Emerson, Hawthorne, Lowell, Bryant, Whittier, Holmes and Mrs Stowe. The library was erected by Timothy B. Blackstone (1820-1900), a native of Branford, and president of the Chicago & Alton railway from 1864 to 1899—as a memorial to his father, a descendant of William Blackstone (d. 1675), the New England pioneer. The principal industries of Branford are the manufacture of malleable iron fittings, locks and general hardware, the quarrying of granite, and oyster culture.

The territory of Totoket (now the township of Branford) was purchased from the Indians by the New Haven Plantation, in

December 1638, for eleven coats of trucking cloth and one coat of English cloth, but with the reservation for a few Indians of what is still known as Indian Neck. In 1640 the general court of New Haven granted it to the Rev. Samuel Eaton (1596?-1665), a brother of Theophilus Eaton, on condition that he brought friends from England to settle it. As Eaton went to England and did not return, Totoket was granted in 1644 to settlers mostly from Wethersfield, Conn., on condition that they should organize a church state after the New Haven model and join the New Haven Jurisdiction. The settlement was made in the same year, and about two years later several new families came from Southampton, Long Island, under the leadership of the Rev. Abraham Pierson (c. 1608-1678), an ardent advocate of the church state, who was chosen pastor at Totoket. The present name of the township, derived from Brentford, England, was adopted about 1645. After the members of the New Haven Jurisdiction had submitted to Connecticut, Pierson, in 1666-1667, led the most prominent citizens of Branford to New Jersey, where they were leaders in founding Newark. The borough of Branford was incorporated in 1893.

See E. C. Baldwin, *Branford Annals*, in Papers of New Haven Colony Historical Society (New Haven, 1882 and 1888).

BRANGWYN, FRANK (1867-), English painter, was born at Bruges, and received his first instruction from his father, the owner of an establishment for church embroideries and kindred objects, who took a leading part in the Gothic revival under Pugin. When the family moved to England, Brangwyn attracted the attention of William Morris by a drawing on which he was engaged at South Kensington museum. He worked for some time in Morris's studio, and then travelled more than once to the East, whereby his sense of colour and the whole further development of his art became deeply influenced. Indeed, the impressions he then received, and his love of Oriental decorative art—tiles and carpets—exercised a greater influence on him than any early training or the works of any European master. His whole tendency is essentially decorative: a colour-sense of sumptuous richness is wedded to an equally strong sense of well-balanced, harmonious design. These qualities, together with a summary suppression of the details which tie a subject to time and place, give his compositions a nobly impressive and universal character, such as may be seen in his decorative panel "Modern Commerce" in the ambulatory of the Royal Exchange, London. Among other decorative schemes executed by him are those for "L'Art nouveau" in the rue de Provence, Paris; for the hall of the Skinners' Company, London; and for the British room at the Venice International Exhibition, 1905. The Luxembourg museum has his "Trade on the Beach"; the Venice municipal museum, the "St Simon Stylites"; the Stuttgart gallery, the "St John the Baptist"; the Munich Pinakothek, the "Assisi"; the Carnegie Institute in Pittsburgh, his "Sweetmeat Seller"; the Prague gallery, his "Turkish Boatmen"; and the National Gallery of New South Wales, "The Scoffers." Brangwyn embarked successfully in many fields of applied art, and made admirable designs for book decoration, stained glass, furniture, tapestry, metal-work and pottery. He devoted himself extensively to etching, and executed many plates of astonishing vigour and dramatic intensity. He was elected associate of the Royal Academy in 1904.

BRANKS (probably akin to Irish *brancas*, a halter; Ger. *Pranger*, fetter, pillory), or SCOLDING-BRIDLE, a contrivance formerly in use throughout England and Scotland for the punishment of scolding women. It is said to have originated in the latter country. It seems to have never been a legalized form of punishment; but corporations and lords of manors in England, town councils, kirk-sessions and barony courts in Scotland assumed a right to inflict it. While specially known as the "Gossip's or Scold's Bridle" the branks was also used for women convicted of petty offences, breaches of the peace, street-brawling and abusive language. It was the equivalent of the male punishments of the stocks and pillory. In its earliest form it consisted of a hoop head-piece of iron, opening by hinges at the side so as to enclose the head, with a flat piece of iron projecting inwards

so as to fit into the mouth and press the tongue down. Later it was made, by a multiplication of hoops, more like a cage, the front forming a mask of iron with holes for mouth, nose and eyes. Sometimes the mouth-plate was armed with a short spike. With this on her head the offending woman was marched through the streets by the beadle or chained to the market-cross to be gibed at by passers. The date of origin is doubtful. It was used at Edinburgh in 1567, at Glasgow in 1574, but not before the 17th century in any English town. A brank in the church of Walton-on-Thames, Surrey, bears date 1633; while another in a private collection has the crowned cipher of William III. The Ashmolean Museum at Oxford, the Scottish National Museum of Antiquities at Edinburgh, the towns of Lichfield, Shrewsbury, Leicester and Chester have examples of the brank. As late as 1856 it was in use at Bolton-le-Moors, Lancashire.

See W. Andrews, *Old Time Punishments* (Hull, 1890); A. M. Earle, *Jurious Punishments of Bygone Days* (Chicago, 1896).

BRANT, JOSEPH (1742-1807), American Indian chief of the Mohawk tribe, known also by his Indian name, THAYENDANEGEA, was born on the banks of the Ohio river in 1742. In early youth he attracted the attention of Sir William Johnson, who sent him to be educated by Dr Eleazar Wheelock at Lebanon, Conn., in Moor's Indian charity school, in which Dartmouth College had its origin. He took part, on the side of the English, in the French and Indian War, and in 1763 fought with the Iroquois against Pontiac. Subsequently he settled at Canajoharie, or Upper Mohawk Castle (in what is now Montgomery county, New York), where, being a devout churchman, he devoted himself to missionary work, and translated the Prayer Book and St Mark's Gospel into the Mohawk tongue (1787). When Guy Johnson (1740-1788) succeeded his uncle, Sir William, as superintendent of Indian affairs in 1774, Brant became his secretary. At the outbreak of the War of Independence, he remained loyal, was commissioned colonel, and organized and led the Mohawks and other Indians allied to the British against the settlements on the New York frontier. He took part in the Cherry Valley Massacre, in the attack on Minisink and the expedition of General St Leger which resulted in the battle of Oriskany on the 6th of August 1777. After the war he discouraged the continuance of Indian warfare on the frontier, and aided the commissioners of the United States in securing treaties of peace with the Miamis and other western tribes. Settling in Upper Canada, he again devoted himself to missionary work and in 1786 visited England, where he raised funds with which was erected the first Episcopal church in Upper Canada. His character was a peculiar compound of the traits of an Indian warrior—with few rivals for daring leadership—and of a civilized politician and diplomat of the more conservative type. He died on an estate granted him by the British government on the banks of Lake Ontario on the 24th of November 1807. A monument was erected to his memory at Brantford, Ontario, Canada (named in his honour) in 1886.

See W. L. Stone, *Life of Joseph Brant* (2 vols., New York, 1838; new ed., Albany, 1865); Edward Eggleston and Elizabeth E. Seelye, *Brant and Red Jacket* in "Famous American Indians" (New York, 1879); and a *Memoir* (Brantford, 1872).

BRANT, SEBASTIAN (1457-1521), German humanist and satirist, was born at Strassburg about the year 1457. He studied at Basel, took the degree of doctor of laws in 1489, and for some time held a professorship of jurisprudence there. Returning to Strassburg, he was made syndic of the town, and died on the 10th of May 1521. He first attracted attention in humanistic circles by his Latin poetry, and edited many ecclesiastical and legal works; but he is now only known by his famous satire, *Das Narrenschiff* (1494), a work the popularity and influence of which were not limited to Germany. Under the form of an allegory—a ship laden with fools and steered by fools to the fools' paradise of Narragonia—Brant here lashes with unsparing vigour the weaknesses and vices of his time. Although, like most of the German humanists, essentially conservative in his religious views, Brant's eyes were open to the abuses in the church, and the *Narrenschiff* was a most effective preparation for the Protestant Reformation. Alexander Barclay's *Ship of Fools* (1509) is a free imitation of the German poem, and a Latin version by

Jacobus Locher (1497) was hardly less popular than the German original. There is also a large quantity of other "fool literature." Nigel, called Wireker (fl. 1190), a monk of Christ Church Priory, Canterbury, wrote a satirical *Speculum stultorum*, in which the ambitious and discontented monk figured as the ass Brunellus, who wanted a longer tail. Brunellus, who has been educated at Paris, decides to found an order of fools, which shall combine the good points of all the existing monastic orders. *Cock Lovell's Bole* (printed by Wynkyn de Worde, c. 1510) is another imitation of the *Narrenschiff*. Cock Lovell is a fraudulent currier who gathers round him a rascally collection of tradesmen. They sail off in a riotous fashion up hill and down dale throughout England. Brant's other works, of which the chief was a version of Freidank's *Bescheidenheit* (1508), are of inferior interest and importance.

Brant's *Narrenschiff* has been edited by F. Zarncke (1854); by K. Goedeke (1872); and by F. Bobertag (Kürschner's *Deutsche Nationalliteratur*, vol. xvii., 1889). A modern German translation was published by K. Simrock in 1872. On the influence of Brant in England see especially C. H. Herford, *The Literary Relations of England and Germany in the 16th Century* (1886).

BRANTFORD, a city and port of entry of Ontario, Canada, on the Grand river, and on the Grand Trunk, and Toronto, Hamilton & Buffalo railways. The river is navigable to within 2½ m. of the town; for the remaining distance a canal has been constructed. Agricultural implements, plough, engine, bicycle and stove works, potteries and large railway shops constitute the important industrial establishments. It contains an institute for the education of the blind, maintained by the provincial government, and a women's college. The city is named in honour of the Mohawk Indian chief, Joseph Brant (Thayendanegea), who settled in the neighbourhood after the American War of Independence, in which he had led the Six Nations (Iroquois) on the British side. The amalgamated tribes of the Six Nations still make it their headquarters, and a monument to Brant has been erected in Victoria Square. Brantford is one of the most flourishing industrial towns of the province, and its population rose from 9616 in 1881 to 20,713 in 1907.

BRANTINGHAM, THOMAS DE (d. 1394), English lord treasurer and bishop of Exeter, came of a Durham family. An older relative, Ralph de Brantingham, had served Edward II. and Edward III., and Thomas was made a clerk in the treasury. Edward III. obtained preferment for him in the church, and from 1361 to 1368 he was employed in France in responsible positions. He was closely associated with William of Wykeham, and while the latter was in power as chancellor, Brantingham was lord treasurer (1369-1371, and 1377-1381), being made bishop of Exeter in 1370. He continued to play a prominent part in public affairs under Richard II., and in 1389 was again lord treasurer for a few months. He died in 1394 and was buried in Exeter cathedral.

BRANTÔME, PIERRE DE BOURDEILLE, SEIGNEUR AND ABBÉ DE (c. 1540-1614), French historian and biographer, was born in Périgord about 1540. He was the third son of the baron de Bourdeille. His mother and his maternal grandmother were both attached to the court of Marguerite of Valois, and at her death in 1549 he went to Paris, and later (1555) to Poitiers, to finish his education. He was given several benefices, the most important of which was the abbey of Brantôme (see below), but he had no inclination for an ecclesiastical career. At an early age he entered the profession of arms. He showed himself a brave soldier, and was brought into contact with most of the great leaders who were seeking fame or fortune in the wars that distracted the continent. He travelled much in Italy; in Scotland, where he accompanied Mary Stuart (then the widow of Francis I.); in England, where he saw Queen Elizabeth (1561, 1579); in Morocco (1564); and in Spain and Portugal. He fought on the galleys of the order of Malta, and accompanied his great friend, the French commander Philippe Strozzi (grandson of Filippo Strozzi, the Italian general, and nephew of Piero), in his expedition against Terceira, in which Strozzi was killed (1582). During the wars of religion under Charles IX. he fought in the ranks of the Catholics, but he allowed himself to be won over temporarily by the ideas of the

reformers, and though he publicly separated himself from Protestantism it had a marked effect on his mind. A fall from his horse compelled him to retire into private life about 1589, and he spent his last years in writing his *Memoirs* of the illustrious men and women whom he had known. He died on the 15th of July 1614.

Brantôme left distinct orders that his manuscript should be printed; a first edition appeared, however, late (1665-1666) and not very complete. Of the later editions the most valuable are: one in 15 volumes (1740); another by Louis Jean Nicolas Monmerqué (1780-1860) in 8 volumes (1821-1824), reproduced in Buchan's *Pantheon littéraire*; that of the *Bibliothèque descriptives*, begun (1858) by P. Mérimée and L. Lacour, and finished, with vol. xiii., only in 1893; and Lalanne's edition for the Société de l'Histoire de France (12 vols., 1864-1896). Brantôme can hardly be regarded as a historian proper, and his *Memoirs* cannot be accepted as a very trustworthy source of information. But he writes in a quaint conversational way, pouring forth his thoughts, observations or facts without order or system, and with the greatest frankness and naïveté. His works certainly gave an admirable picture of the general court-life of the time, with its unblushing and undisguised profligacy. There is not a *homme illustre* or a *dame galante* in all his gallery of portraits who is not stained with vice; and yet the whole is narrated with the most complete unconsciousness that there is anything objectionable in their conduct.

The edition of L. Lalanne has great merit, being the first to indicate the Spanish, Italian and French sources on which Brantôme drew, but it did not utilize all the existing MSS. It was only after Lalanne's death that the earliest were obtained for the Bibliothèque Nationale. At Paris and at Chantilly (Musée Condé) all Brantôme's original MSS., as revised by him several times, are now collected (see the *Bibliothèque de l'école des Chartes*, 1904), and a new and definitive edition has therefore become possible. Brantôme's poems (which amount to more than 2200 verses) were first published in 1881; see Lalanne's edition.

BRANTÔME, a town of south-western France, in the department of Dordogne, 20 m. N. by W. of Périgueux by steam-tramway. Pop. (1906) 1230. The town is built, in great part, on an island in the river Dronne. It is well known for the remains of an abbey founded by Charlemagne about 770 and afterwards destroyed by the Normans. The oldest existing portion is a square tower dating from the 11th century, built upon a rock beside the church which it overlooks. It communicates by a staircase with the church, a rectangular building partly Romanesque, partly Gothic, to the west of which are the remains of a cloister. The abbey buildings date from the 18th century, and now serve as hôtel-de-ville, magistrature and schools. Caves in the neighbouring rocks were inhabited by the monks before the building of the abbey; one of them, used as an oratory, contains curious carvings, representing the Last Judgment and the Crucifixion. In the middle of the 16th century Pierre de Bourdeille came into possession of the abbey, from which he took the name of Brantôme.

Brantôme has some old houses and a church of the 15th century, which was once fortified and is now used as a market. Truffles are the chief article of commerce; and there are quarries of freestone in the neighbourhood. The dolmen which is known as Pierre-Levéé, to the east of the town, is the most remarkable in Périgord.

BRANKHOLM, or **BRANKSOME**, a feudal castle, now modernized, and an ancient seat of the Buccleuchs, on the Teviot, 3 m. S.W. of Hawick, Roxburgh, Scotland. It was at Branksome Hall that Sir Walter Scott laid the scene of *The Lay of the Last Minstrel*.

BRANKHOLM, or **BRANKESTON**, a village of Northumberland, England, 10½ m. E. by N. of Kelso, and 2 m. E.S.E. of Coldstream, and 10 m. N.W. of Wooler. It was on Brantxon Hill, immediately south of the village, that the battle of Flodden (q.v.) was fought between the English and the Scots on the 9th of September 1513. During the fight the Scots centre pushed as far as Brantxon church, but "the King's Stone," which lies N.W. of the church and is popularly supposed to mark the spot where James IV. fell, is some three-quarters of a mile from the scene

of the battle; it is believed in reality to mark the sepulchre of a chieftain, whose name had already perished in the 16th century. Brantxon church, dedicated to St Paul, was rebuilt in 1849 in Norman style. Of the older building nothing remains save the chancel arch.

BRAOSE, WILLIAM DE (d. 1211), lord of Brecknock, Radnor and Limerick, spent the early part of his life fighting the Welsh in Radnorshire. He was high in King John's favour, received a large number of honours, and was even given the custody of Prince Arthur. But John and he quarrelled, probably over money (1207). In 1208 John began to suspect the fidelity of the whole family, and William had to fly to Ireland. After a number of attempted reconciliations, he was outlawed (1210) and died at Corbeil (1211). It is said that his wife and son were starved to death by John.

See *Foedera*, i. 107; *Histoire des ducs* (ed. Michel), Wendover; Kate Norgate's *John Lackland*.

A descendant, William de Braose (d. 1266), lord of Gower, was a devoted follower of Edward I., and in 1299 was summoned to parliament as baron de Braose; and his nephew Thomas de Braose (d. 1361) also distinguished himself in the wars and was summoned as baron de Braose in 1342. This latter barony became extinct in 1399; but a claim to the barony of William de Braose, which, as he had no son, fell into abeyance between his two daughters and co-heirs, Alina (wife of Lord Mowbray) and Joan (wife of John de Bohun), or their descendants, may still be traced by careful genealogists in various noble English families.

BRASCASSAT, JACQUES RAYMOND (1804-1867), French painter, was born at Bordeaux, and studied art in Paris, where in 1825 he won a *prix de Rome* with a picture ("Chasse de Méléagre") now in the Bordeaux gallery. He went to Italy and painted a number of landscapes which were exhibited between 1827 and 1835; but subsequently he devoted himself mainly to animal-painting, in which his reputation as an artist was made. His "Lutte de taureaux" (1837), in the *musée* at Nantes, and his "Vache attaquée par des loups" (1845), in the Leipzig museum, were perhaps the best of his pictures; but he was remarkable for his accuracy of observation and correct drawing. He was elected a member of the Institute in 1846. He died at Paris on the 28th of February 1867.

BRAS D'OR, a landlocked and tideless gulf or lake of high irregular outline, 50 m. long by 20 m. broad, almost separating Cape Breton Island (province of Nova Scotia, Canada) into two parts. A ship canal across the isthmus (about 1 m. wide) completes the severance of the island. The entrance to the gulf is on the N.E. coast of the island, and it is connected with the Atlantic by the Great and Little Bras d'Or channels, which are divided by Boulardeire Island. One channel is 25 m. long and from ¼ m. to 3 m. broad, but is of little depth, the other (used by shipping) is 22 m. long, 1 to 1½ m. wide, and has a depth of 60 fathoms. The gulf or lake is itself divided into two basins, the inner waters being known as the Great Bras d'Or Lake. The waters are generally from 12 to 60 fathoms deep, but in the outer basin (known as the Little Bras d'Or Lake) are soundings said to reach nearly 700 ft. The shores of the gulf are very picturesque and well wooded and have attracted many tourists. Sea fishing (cod, mackerel, &c.) is the chief industry. The name is said to be a corruption of an Indian word, but it assumed its present form during the French occupation of Cape Breton Island.

BRASDOR, PIERRE (1721-1799), French surgeon, was born in the province of Maine. He took his degree in Paris as master of surgery in 1752, and was appointed regius professor of anatomy and director of the Academy of Surgery. He was a skilful operator, whose name was long attached to a ligature of his invention; and he was an ardent advocate of inoculation. He died in Paris on the 28th of September 1799.

BRASIDAS (d. 422 B.C.), a Spartan officer during the first decade of the Peloponnesian War. He was the son of Tellis and Argileonis, and won his first laurels by the relief of Methone, which was besieged by the Athenians (431 B.C.). During the

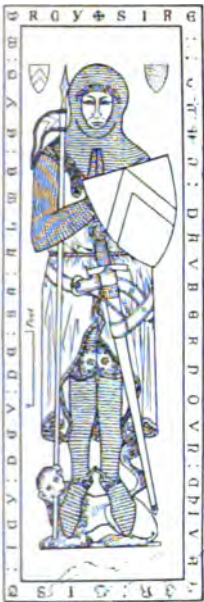

Fig. 1. — Sir John D'Abernon, 1277. Stoke D'Abernon, Surrey.



Fig. 2. — Margaret de Camoys, 1310. Trotton, Sussex.



Fig. 3. — Henry de Grofhurst, c. 1330. Horsemonden, Kent.



Fig. 4. — Sir Nicholas Bunnell, 1382. Acton Bunnell, Shropshire.



Fig. 5. — Margaret Lady Cobham, 1385. Cobham, Kent.



Fig. 6. — Sir John Corp and Eleanor, his grand-daughter, 1391, 1361. Stoke Fleming, Devonshire.



Fig. 7. — Sir Symon de Felbrigge and Margaret his wife, 1400. Felbrigge, Norfolk.

Figs. 1 and 6 from Waller's *Monumental Brasses*. Figs. 2, 3, and 4 by permission of the *Monumental Brass Society*. Figs. 5 and 7 from Boutell's *Monumental Brasses*.



Fig. 1.—Thomas de Beauchamp, Earl of Warwick and Lady, 1406 and 1401. St. Mary's Church, Warwick.



Fig. 2.—Thomas Cranley, Archbishop of Dublin, 1417. New College, Oxford.



Fig. 3.—Sir William Vernon and Lady 1467. Tong Church, Shropshire.



Fig. 4.—John Shelley Esq., 1526, and his wife Elizabeth, 1513. Clapham, Sussex.

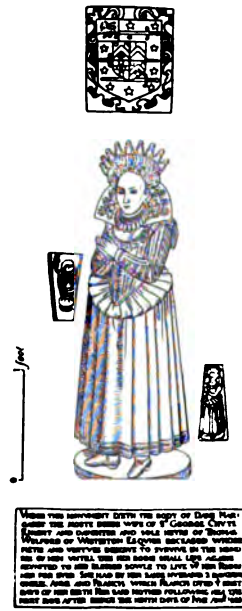

Fig. 5.—Dame Margaret Chute, 1614. Mardon, Herefordshire.



Fig. 6.—Sir Edward Filmer and Lady, 1638. East Sutton, Kent.

Figs. 1, 2, 3, and 6 from Waller's *Monumental Brasses*.

Figs. 4 and 5 by permission of the *Monumental Brasses Society*.

following year he seems to have been eponymous ephor (Xen. *Hell.* ii. 3, 10), and in 429 he was sent out as one of the three commissioners (*στρουβουλας*) to advise the admiral Cnemus. As trierarch he distinguished himself in the assault on the Athenian position at Pylos, during which he was severely wounded (Thuc. iv. 11: 12).

In the next year, while Brasidas mustered a force at Corinth for a campaign in Thrace, he frustrated an Athenian attack on Megara (Thuc. iv. 70-73), and immediately afterwards marched through Thessaly at the head of 700 helots and 1000 Peloponnesian mercenaries to join the Macedonian king Perdiccas. Refusing to be made a tool for the furtherance of Perdiccas's ambitions, Brasidas set about the accomplishment of his main object, and, partly by the rapidity and boldness of his movements, partly by his personal charm and the moderation of his demands, succeeded during the course of the winter in winning over the important cities of Acanthus, Stagirus, Amphipolis and Torone as well as a number of minor towns. An attack on Eion was foiled by the arrival of Thucydides, the historian, at the head of an Athenian squadron. In the spring of 423 a truce was concluded between Athens and Sparta, but its operation was at once imperilled by Brasidas's refusal to give up Scione, which, the Athenian partisans declared, revolted two days after the truce began, and by his occupation of Mende shortly afterwards. An Athenian fleet under Nicias and Nicostratus recovered Mende and blockaded Scione, which fell two years later (421 B.C.). Meanwhile Brasidas joined Perdiccas in a campaign against Arrhabaeus, king of the Lyncesti, who was severely defeated. On the approach of a body of Illyrians, who, though summoned by Perdiccas, unexpectedly declared for Arrhabaeus, the Macedonians fled, and Brasidas's force was rescued from a critical position only by his coolness and ability. This brought to a head the quarrel between Brasidas and Perdiccas, who promptly concluded a treaty with Athens, of which some fragments have survived (*I.G.* i. 42).

In April 422 the truce with Sparta expired, and in the same summer Cleon was despatched to Thrace, where he stormed Torone and Galepus and prepared for an attack on Amphipolis. But a carelessly conducted reconnaissance gave Brasidas the opportunity for a vigorous and successful sally. The Athenian army was routed with a loss of 600 men and Cleon was slain. On the Spartan side only seven men are said to have fallen, but amongst them was Brasidas. He was buried at Amphipolis with impressive pomp, and for the future was regarded as the founder (*κτιστής*) of the city and honoured with yearly games and sacrifices (Thuc. iv. 78-v. 11). At Sparta a cenotaph was erected in his memory near the tombs of Pausanias and Leonidas, and yearly speeches were made and games celebrated in their honour, in which only Spartiates could compete (Paus. iii. 14).

Brasidas united in himself the personal courage characteristic of Sparta with those virtues in which the typical Spartan was most signally lacking. He was quick in forming his plans and carried them out without delay or hesitation. With an oratorical power rare amongst the Lacedaemonians he combined a conciliatory manner which everywhere won friends for himself and for Sparta (Thuc. iv. 81).

See in particular Thucydides, ii-v.; what Diodorus xii. adds is mainly oratorical elaboration or pure invention. A fuller account will be found in the histories of Greece (e.g. those of Grote, Beloch, Busolt, Meyer) and in G. Schimmelpfeng, *De Brasidae Spartani rebus gestis atque ingenio* (Marburg, 1857).

BRASS, a river, town and district of southern Nigeria, British West Africa. The Brass river is one of the deltaic branches of the Niger, lying east of the Rio Nun or main channel of the river. From the point of divergence from the main stream to the sea the Brass has a course of about 100 m., its mouth being in 6° 20' E., 4° 35' N. Brass town is a flourishing trading settlement at the mouth of the river. It is the headquarters of a district commissioner and the seat of a native court. Its most conspicuous building is a fine church, the gift of a native chief. The capital of the Brass tribes is Nimbé, 30 m. up river.

The Brass river, called by its Portuguese discoverers the Rio Bento, is said to have received its English name from the brass

rods and other brass utensils imported by the early traders in exchange for palm oil and slaves. The Brass natives, of the pure negro type, were noted for their savage character. In 1856 their chiefs concluded a treaty with Great Britain agreeing to give up the slave-trade in exchange for a duty on the palm-oil exportation. Finding their profitable business as middlemen between the up-river producer and the exporter threatened by the appearance of European traders, they made ineffective complaints to the British authorities. The establishment of the Royal Niger Company led to further loss of trade, and on the 29th of January 1895 the natives attacked and sacked the company's station at Akassa on the Rio Nun, over forty prisoners being killed and eaten as a sacrifice to the fetish gods. In the following month a punitive expedition partially destroyed Nimbé, and a heavy fine was paid by the Brass chiefs. Since then the country has settled down under British administration. The trade regulations of which complaint had been made were removed in 1900 on the establishment of the protectorate of Southern Nigeria (see NIGERIA).

Valuable information concerning the country and people will be found in the *Report by Sir John Kirk on the Disturbances at Brass* (Africa, No. 3, 1896).

BRASS (O. Eng. *braes*), an alloy consisting mainly if not exclusively of copper and zinc; in its older use the term was applied rather to alloys of copper and tin, now known as bronze (*q.v.*). Thus the brass of the Bible was probably bronze, and so also was much of the brass of later times, until the distinction between zinc and tin became clearly recognized. The Latin word *aes* signifies either pure copper or bronze, not brass, but the Romans comprehended a brass compound of copper and zinc under the term *orichalcum* or *aurichalcum*, into which Pliny states that copper was converted by the aid of cadmia (a mineral of zinc).

In England there is good evidence of the manufacture of brass with zinc at the end of the 16th century, for Queen Elizabeth by patent granted to William Humfrey and Christopher Schutz the exclusive right of working calamine and making brass. This right subsequently devolved upon a body called the "Governors, Assistants and Societies of the City of London of and for the Mineral and Battery Works," which continued to exercise its functions down to the year 1710.

When a small percentage of zinc is present; the colour of brass is reddish, as in *tombac* or red brass, which contains about 10%. With about 20% the colour becomes more yellow, and a series of metals is obtained which simulate gold more or less closely; such are *Dutch metal*, *Mannheim gold*, *similar* and *pinchbeck*, the last deriving its name from a London clockmaker, Christopher Pinchbeck, who invented it in 1732. Ordinary brass contains about 30% of zinc, and when 40% is present, as in *Munns*, *yellow* or *patent metal* (invented by G. F. Muntz in 1832), the colour becomes a full yellow. When the proportion of zinc is largely increased the colour becomes silver-white and finally grey. The limit of elasticity increases with the percentage of zinc, as also does the amount of elongation before fracture, the maximum occurring with 30%. The tenacity increases with the proportion of zinc up to a maximum with 45%; then it decreases rapidly, and with 50% the metals are fragile. By varying the proportion between 30 and 43% a series of alloys may be prepared presenting very varied properties. The most malleable of the series has an elongation of about 60%, with a tensile strength of 17.5 tons per sq. in. Increase in the proportion of zinc gives higher tensile strength, accompanied, however, by a smaller percentage of elongation and a materially increased tendency to produce unsound castings. The quality of copper-zinc alloys is improved by the addition of a small quantity of iron, a fact of which advantage is taken in the production of Aich's metal and delta metal. Of the latter there are several varieties, modified in composition to suit different purposes. Some of them possess high tensile strength and ductility. They are remarkably resistant to corrosion by sea-water, and are well suited for screw-propellers as well as for pump-plungers, pistons and glands. Heated to a dull red delta metal becomes malleable

and can be worked under the hammer, press or stamps. By such treatment an ultimate tensile strength of 30 tons per sq. in. may be obtained, with an elongation of 32 % in 2 in. and a contraction of area of 30 %.

In the arts brass is a most important and widely used alloy. As compared with copper its superior hardness makes it wear better, while being more fusible it can be cast with greater facility. It is readily drawn into fine wire, and formed into rolled sheets and rods which are machined into a huge number of useful and ornamental articles. It is susceptible of a fine polish, but tarnishes with exposure to the air; the brilliancy of the surface can, however, be preserved if the metal is thoroughly cleansed by "dipping" in nitric acid and "lacquered" with a coating of varnish consisting of seed-lac dissolved in spirit.

BRASSES, MONUMENTAL, a species of engraved sepulchral memorials which in the early part of the 13th century began to take the place of tombs and effigies carved in stone. Made of hard *latens* or sheet brass, let into the pavement, and thus forming no obstruction in the space required for the services of the church, they speedily came into general use, and continued to be a favourite style of sepulchral memorial for three centuries. Besides their great value as historical monuments, they are interesting as authentic contemporary evidence of the varieties of armour and costume, or the peculiarities of palaeography and heraldic designs, and they are often the only authoritative records of the intricate details of family history. Although the intrinsic value of the metal has unfortunately contributed to the wholesale spoliation of these interesting monuments, they are still found in remarkable profusion in England, and they were at one time equally common in France, Germany and the Low Countries. In France, however, those that survived the troubles of the 16th century were totally swept away during the reign of terror, and almost the only evidence of their existence is now supplied by the collection of drawings bequeathed by Gough to the Bodleian library. The fine memorials of the royal house of Saxony in the cathedrals of Meissen and Freiberg are the most artistic and striking brasses in Germany. Among the 13th-century examples existing in German churches are the full-length memorials of Yso von Welpe, bishop of Verden (1231), and of Bernard, bishop of Paderborn (1340). Many fine Flemish specimens exist in Belgium, especially at Bruges. Only two or three examples, and these of late date, are known in Scotland, among which are the memorials of Alexander Cockburn (1564) at Ormiston; of the regent Murray (1560) in the collegiate church of St Giles, Edinburgh; and of the Minto family (1605) in the south aisle of the nave of Glasgow cathedral. England is the only country which now possesses an extensive series of these interesting memorials, of which it is calculated that there may be about 4000 still remaining in the various churches. They are most abundant in the eastern counties, and this fact has been frequently adduced in support of the opinion that they were of Flemish manufacture. But in the days when sepulchral brasses were most in fashion the eastern counties of England were full of commercial activity and wealth, and nowhere do the engraved memorials of civilians and prosperous merchants more abound than in the churches of Ipswich, Norwich, Lynn and Lincoln. Flemish brasses do occur in England, but they were never numerous, and they are readily distinguished from those of native workmanship. The Flemish examples have the figures engraved in the centre of a large plate, the background filled in with diapered or scroll work, and the inscription placed round the edge of the plate. The English examples have the figures cut out to the outline and inserted in corresponding cavities in the slab, the darker colour of the stone serving as a background. This is not an invariable distinction, however, as "figure-brasses" of Flemish origin are found both at Bruges and in England. But the character of the engraving is constant, the Flemish work being more florid in design, the lines shallower, and the broad lines cut with a chisel-pointed tool instead of the lozenge-shaped burin. The brass of Robert Hallum, bishop of Salisbury, the envoy of Henry V. to the council of Constance, who died and was interred there in 1416, precisely resembles

the brasses of England in the peculiarities which distinguish them from continental specimens. Scarcely any of the brasses which now exist in England can be confidently referred to the first half of the 13th century, though several undoubted examples of this period are on record. The full-sized brass of Sir John d'Aubernon at Stoke d'Abernon in Surrey (c. 1277) has the decorations of the shield filled in with a species of enamel. Other examples of this occur, and the probability is, that, in most cases, the lines of the engraving were filled with colouring-matter, though brass would scarcely bear the heat requisite to fuse the ordinary enamels. A well-known 13th-century example is that of Sir Roger de Trumpington (c. 1290), who accompanied Prince Edward in his expedition to Palestine and is represented cross-legged. About half a dozen instances of this peculiarity are known. The 14th-century brasses are much more numerous, and present a remarkable variety in their details. The finest specimen is that of Nicholas Lord Burrell (1315) in the church of Acton Burnell, Shropshire. In the 15th century the design and execution of monumental brasses had attained their highest excellence. The beautiful brass of Thomas Beauchamp, earl of Warwick (d. 1401), and his wife Margaret, which formerly covered the tomb in St Mary's church, Warwick, is a striking example. One of the best specimens of plate armour is that of Sir Robert Stantoun (1458) in Castle Donnington church, Leicestershire, and one of the finest existing brasses of ecclesiastics is that of Abbot de la Mare of St Albans. It is only in the 16th century that the engraved representations become portraits. Previous to that period the features were invariably represented conventionally, though sometimes personal peculiarities were given. A large number of brasses in England are *palimpsests*, the back of an ancient brass having been engraved for the more recent memorial. Thus a brass commemorative of Margaret Bulstrode (1540) at Hedgerley, on being removed from its position, was discovered to have been previously the memorial of Thomas Totyngton, abbot of St Edmunds, Bury (1312). The abbey was only surrendered to Henry VIII. in 1539, so that before the year was out the work of spoliation had begun, and the abbot's brass had been removed and re-engraved to Margaret Bulstrode. In explanation of the frequency with which ancient brasses have thus been stolen and re-erected after being engraved on the reverse, as at Berkhamstead, it may be remarked that all the sheet brass used in England previous to the establishment of a manufactory at Esher by a German in 1649, had to be imported from the continent.

AUTHORITIES.—(1) General: *Manual for the Study of Monumental Brasses* (Oxford, 1848); *Boutell's Monumental Brasses of England*, engravings on wood, folio (London, 1849); *Manual of Monumental Brasses*, by H. Haines (2 vols. 8vo, 1861); *Walker's Series of Monumental Brasses in England* (London and Oxford, Parkers, 1863); *Monumental Brasses*, by H. W. Macklin (8vo, 1890); *The Brasses of England*, by H. W. Macklin (8vo, London, 1907). (2) English Counties: *Cotman's Engravings of the most Remarkable of the Sepulchral Brasses of Norfolk* (4to, London, 1813-1816; and second edition, with plates and notes by Meyrick, Albert Way and Sir Harris Nicholas (2 vols. folio, London, 1839); *Illustrations of Monumental Brasses in Cambridge* (4to, Camden Society, 1846); *Monumental Brasses of Northamptonshire*, by F. Hudson (folio, 1853); *The Monumental Brasses of Wiltshire*, by G. Kite (8vo, London, 1860); *Architectural and Historical Notes of the Churches of Cambridgeshire*, by A. C. Hill (8vo, 1880); *Monumental Brasses of Cornwall*, by E. H. W. Dunken (4to, London, 1882); *Monumental Brasses of Worcestershire and Herefordshire*, ed. by C. T. Davis (1884); *Kentish Brasses*, by W. D. Belcher (4to, London, 1888); *List of Monumental Brasses in the County of Norfolk*, by the Rev. E. Farrer (Norwich, 1890); *The Monumental Brasses of Lancashire and Cheshire*, by James Thornby (8vo, Hull, 1893); *Monumental Brasses in the Bedfordshire Churches*, by Grace Isherwood (8vo, London, 1906); a large collection of rubbings of special interest and value. (3) Foreign: *Monumental Brasses and Incised Slabs in Belgium* (8vo, 1849); *Books of Facsimiles of Monumental Brasses of the Continent of Europe*, folio (1884), by the Rev. W. F. Creeny.

BRASSEUR DE BOURBOURG, CHARLES ÉTIENNE (1814-1874), Belgian ethnographer, was born at Bourbourg, near Dunkirk, on the 8th of September 1814. He entered the Roman Catholic priesthood, was professor of ecclesiastical history in the Quebec seminary in 1845, vicar-general at Boston in 1846, and from 1848 to 1863 travelled as a missionary, chiefly in Mexico

and Central America. He gave great attention to Mexican antiquities, published in 1857-1859 a history of Aztec civilization, and from 1861 to 1864 edited a collection of documents in the indigenous languages. In 1863 he announced the discovery of a key to Mexican hieroglyphic writing, but its value is very questionable. In 1864 he was archaeologist to the French military expedition in Mexico, and his *Monuments anciens du Mexique* was published by the French Government in 1866. Perhaps his greatest service was the publication in 1861 of a French translation of the *Popol Vuh*, a sacred book of the Quiché Indians, together with a Quiché grammar, and an essay on Central American mythology. In 1871 he brought out his *Bibliothèque Mexico-Guatemalienne*, and in 1869-1870 gave the principles of his decipherment of Indian picture-writing in his *Manuscrit Troano, études sur le système graphique et la langue des Mayas*. He died at Nice on the 8th of January 1874. His chief merit is his diligent collection of materials; his interpretations are generally fanciful.

BRASSEY, THOMAS (1805-1870), English railway contractor, was born at Buerton, near Chester, on the 7th of November 1805. His father, besides cultivating land of his own, held a large farm of the marquess of Westminster; his ancestors, according to family tradition, having been settled for several centuries at Bulkeley, near Malpas, Cheshire, before they went to Buerton in 1663. Thomas Brassey received an ordinary commercial education at a Chester school. At the age of sixteen he was apprenticed to a surveyor, and on the completion of his term became the partner of his master, eventually assuming the sole management of the business. In the local surveys to which he devoted his attention during his early years he acquired the knowledge and practical experience which were the necessary foundation of his great reputation. His first engagement as railway contractor was entered upon in 1835, when he undertook the execution of a portion of the Grand Junction railway, on the invitation of the distinguished engineer Joseph Locke, who soon afterwards entrusted him with the completion of the London and Southampton railway, a task which involved contracts to the amount of £4,000,000 sterling and the employment of a body of 3000 men. At the same time he was engaged on portions of several other lines in the north of England and in Scotland. In conjunction with his partner, W. Mackenzie, Brassey undertook, in 1840, the construction of the railway from Paris to Rouen, of which Locke was engineer. He subsequently carried out the extension of the same line. A few years later he was engaged with his partner on five other French lines, and on his own account on the same number of lines in England, Wales and Scotland. Brassey was now in control of an industrial army of 75,000 men, and the capital involved in his various contracts amounted to some £36,000,000. But his energy and capacity were equal to still larger tasks. He undertook in 1851 other works in England and Scotland; and in the following year he engaged in the construction of railways in Holland, Prussia, Spain and Italy. One of his largest undertakings was the Grand Trunk railway of Canada, 1100 m. in length, with its fine bridge over the St Lawrence. In this work he was associated with Sir M. Peto and E. L. Betts. In the following years divisions of his industrial army were found in almost every country in Europe, in India, in Australia and in South America. Besides actual railway works, he originated and maintained a great number of subordinate assistant establishments, coal and iron works, dockyards, &c., the direction of which alone would be sufficient to strain the energies of an ordinary mind. His profits were, of course, enormous, but prosperity did not intoxicate him; and when heavy losses came, as sometimes they did, he took them bravely and quietly. Among the greatest of his pecuniary disasters were those caused by the fall of the great Barentin viaduct on the Rouen and Havre railway, and by the failure of Peto and Betts. Brassey was one of the first to aim at improving the relations between engineers and contractors, by setting himself against the corrupt practices which were common. He resolutely resisted the "scamping" of work and the bribery of inspectors, and what he called the "smothering of

the engineer"; and he did much in this way to bring about a better state of things. Large-hearted and generous to a rare degree, modest and simple in his taste and manners, he was conscious of his power as a leader in his calling, and knew how to use it wisely and for noble ends. Honours came to him unsought. The cross of the Legion of Honour was conferred on him. From Victor Emmanuel he received the cross of the Order of St Maurice and St Lazarus; and from the emperor of Austria the decoration of the Iron Crown, which it is said had not before been given to a foreigner. He died at St Leonards on the 8th of December 1870. His life and labours are commemorated in a volume by Sir Arthur Helps (1872).

He left three sons, of whom the eldest, THOMAS (b. 1836), was knighted and afterwards (1886) created **BARON BRASSEY**. Lord Brassey, who was educated at Rugby and Oxford, entered parliament as a liberal in 1865, and devoted himself largely to naval affairs. He was civil lord of the admiralty (1880-1883), and secretary to the admiralty (1883-1885); and both before and after his elevation to the peerage did important work on naval and statistical inquiries for the government. In 1893-1895 he was president of the Institution of Naval Architects. In 1894 he was a lord-in-waiting, and from 1895 to 1900 was governor of Victoria. In 1908 he was appointed lord warden of the Cinque Ports. His voyages in his yacht "Sunbeam" from 1876 onwards, with his first wife (d. 1887), who published an interesting book on the subject, took him all over the world. Lord Brassey married a second time in 1890. Among other publications, his inauguration of the *Naval Annual* (1886 onwards), and his volumes on *The British Navy*, are the most important. His eldest son Thomas, who edited the *Naval Annual* (1890-1904), and unsuccessfully contested several parliamentary constituencies, was born in 1868.

BRASSÓ (Ger. *Kronstadt*; Rumanian, *Brasov*), a town of Hungary, in Transylvania, 206 m. S.E. of Kolozsvár by rail. Pop. (1900) 34,511. It is the capital of the comitat (county) of the same name, also known as Burzenland, a fertile country inhabited by an industrious population of Germans, Magyars and Rumanians. Brassó is beautifully situated on the slopes of the Transylvanian Alps, in a narrow valley, shut in by mountains, and presenting only one opening on the north-west towards the Burzen plain. The town is entirely dominated by the Zinne of Kapellenberg, a mountain rising 1276 ft. above the town (total altitude 3153 ft.), from which a beautiful view is obtained of the lofty mountains around and of the carefully cultivated plain of the Burzenland, dotted with tastefully built and well-kept villages. On the summit of the mountain is one of the numerous monuments erected in 1896 in different parts of the country to commemorate the thousandth anniversary of the foundation of the Hungarian state. It is known as Árpád's Monument, and consists of a Doric column erected on a circular pedestal, which supports the bronze figure of a warrior from the time of Árpád.

Brassó consists of the inner town, which is the commercial centre, and the suburbs of Blumenau, Altstadt and Obere Vorstadt or Bolgarszeg, inhabited respectively by Germans, Magyars and Rumanians. To the east of the inner town rises the Schlossberg, crowned by the citadel, which was erected in 1553, and constitutes the principal remaining fragment of the old fortifications with which Brassó was encircled. The most interesting building in the town is the Protestant church, popularly called the Black Church, owing to its smoke-stained walls, caused by the great fire of 1689. This church, the finest in Transylvania, is a Gothic edifice with traces of Romanesque influence, and was built in 1385-1425. In the square in front of it is the statue of Johannes Honterus (1498-1549), "the apostle of Transylvania," who was born in Brassó, and established here the first printing-press in Transylvania. In the principal square of the inner town stands the town hall, built in 1420 and restored in the 18th century, with a tower 190 ft. high. Brassó is the most important commercial and manufacturing town of Transylvania. Lying near the frontier of Rumania, with easy access through the Tömös pass, it developed from the earliest time an

active trade with that country and with the whole of the Balkan states. Its chief industries are iron and copper works, wool-spinning, turkey-red dyeing, leather goods, paper, cement and petroleum refineries. The timber industry in all its branches, with a speciality for the manufacture of the wooden bottles largely used by the peasantry in Hungary and in the Balkan states, as well as the dairy industry, and ham-curing are also fully developed. A peculiarity of Brassó, which constitutes a survival of the old methods of trade with the Balkan states, is the number of money-changers who ply their trade at small movable tables in the market-place and in the open street. Brassó is the most populous town of Transylvania, and its population is composed in about equal numbers of Germans, Magyars and Rumanians. The town, especially on market days, presents an animated and picturesque aspect. Here are seen Germans, Szecklers, Magyars, Rumanians, Armenians and Gipsies, each of them wearing their distinctive national costume, and talking and bargaining in their own special idiom.

Amongst the places of interest round Brassó is the watering-place Zaion, 15 m. to the east, with ferruginous and iodine waters; while about 17 m. to the south-west lies the pretty Rumanian village of Zernest, where in 1690 the Austrian general Heussler was defeated and taken prisoner by Imre (Emerich) Tököly, the usurper of the Transylvanian throne.

Brassó was founded by the Teutonic Order in 1211, and soon became a flourishing town. Through the activity of Honterus it played a leading part in the introduction of the Reformation in Transylvania in the 16th century. The town was almost completely destroyed by the big fire of 1689. During the revolution of 1848-1849 it was besieged by the Hungarians under General Bem from March to July 1849, and several engagements between the Austrian and the Hungarian troops took place in its neighbourhood.

BRATHWAIT, RICHARD (1588-1673), English poet, son of Thomas Brathwait, was born in 1588 at his father's manor of Burneshead, near Kendal, Westmorland. He entered Oriel College, Oxford, in 1604, and remained there for some years, pursuing the study of poetry and Roman history. He removed to Cambridge to study law and afterwards to London to the Inns of Court. Thomas Brathwait died in 1610, and the son went down to live on the estate he inherited from his father. In 1617 he married Frances Lawson of Nesham, near Darlington. On the death of his elder brother, Sir Thomas Brathwait, in 1618, Richard became the head of the family, and an important personage in the county, being deputy-lieutenant and justice of the peace. In 1633 his wife died, and in 1639 he married again. His only son by this second marriage, Sir Strafford Brathwait, was killed in a sea-fight against the Algerian pirates. Richard Brathwait's most famous work is *Barnabae Itinerarium* or *Barnabees Journall* [1638], by "Corymbaeus," written in English and Latin rhyme. The title-page says it is written for the "travellers' solace" and is to be chanted to the old tune of "Barnabe." The story of "drunken Barnabee's" four journeys to the north of England contains much amusing topographical information, and its gaiety is unflagging. Barnabee rarely visits a town or village without some notice of an excellent inn or a charming hostess, but he hardly deserves the epithet "drunken." At Banbury he saw the Puritan who has become proverbial,

"Hanging of his cat on Monday
For killing of a Mouse on Sunday."

Brathwait's identity with "Corymbaeus" was first established by Joseph Haslewood. In his later years he removed to Catterick, where he died on the 4th of May 1673. Among his other works are: *The Golden Fleece* (1611), with a second title-page announcing "sonnets and madrigals," and a treatise on *the Art of Poesy*, which is not preserved; *The Poets Willow; or the Passionate Shepheard* (1614); *The Prodigals Tears* (1614); *The Schollers Medley, or an intermixt Discourse upon Historicall and Poeticall relations* (1614), known in later editions as a *Survey of History* (1638, &c.); a collection of epigrams and satires entitled *A Strappado for the Diuill* (1615), with which was published incongruously *Loves Labyrinth* (edited, 1878, by J. W. Ebsworth);

Natures Embassie; or, the wildemans measures; danced naked by twelve satyres (1621), thirty satires finding antique parallels for modern vices; with these are bound up *The Shepherds Tales* (1621), a collection of pastorals, one section of which was reprinted by Sir Egerton Brydges in 1815; two treatises on manners, *The English Gentleman* (1630) and *The English Gentlewoman* (1631); *Anniversaries upon his Panarete* (1634), a poem in memory of his wife; *Essays upon the Five Senses* (1620); *The Psalmes of David . . . and other holy Prophets, paraphras'd in English* (1638); *A Comment upon Two Tales of . . . Jeffrey Chaucer* (1665; edited for the Chaucer Soc. by C. Spurgeon, 1901). Thomas Hearne, on whose testimony (MS. collections for the year 1713, vol. 47, p. 127) the authorship of the *Itinerarium* chiefly rests, not inappropriately called him "the scribler of those times," and the list just given of his works, published under various pseudonyms, is by no means complete.

A full bibliography is given in Joseph Haslewood's edition of *Barnabee's Journall* (ed. W. C. Hazlitt, 1876). See also J. Corser, *Collectanea* (Chetham Soc., 1860, &c.).

BRATIYANU (or **BRATIYANO**), **ION C.** (1821-1891), Rumanian statesman, was born at Pitesci in Walachia on the 2nd of June 1821. He entered the Walachian army in 1838, and visited Paris in 1841 for purposes of study. Returning to Walachia, he took part, with his friend C. A. Rosetti and other prominent politicians, in the Rumanian rebellion of 1848, and acted as prefect of police in the provisional government formed in that year. The restoration of Russian and Turkish authority shortly afterwards drove him into exile. He took refuge in Paris, and endeavoured to influence French opinion in favour of the proposed union and autonomy of the Danubian principalities. In 1854, however, he was sentenced to a fine of £120 and three months' imprisonment for sedition, and later confined in a lunatic asylum; but in 1856 he returned home with his brother, Dimitrie Bratiyanu, afterwards one of his foremost political opponents. During the reign of Prince Cuza (1859-1866), Bratiyanu figured prominently as one of the Liberal leaders. He assisted in 1866 in the deposition of Cuza and the election of Prince Charles of Hohenzollern, under whom he held several ministerial appointments during the next four years. He was arrested for complicity in the revolution of 1870, but soon released. In 1876, aided by C. A. Rosetti, he formed a Liberal cabinet, which remained in power until 1888. For an account of his work in connexion with the Russo-Turkish War of 1877, the Berlin congress, the establishment of the Rumanian kingdom, the revision of the constitution, and other reforms, see **RUMANIA**. After 1883 Bratiyanu acted as sole leader of the Liberals, owing to a quarrel with C. A. Rosetti, his friend and political ally for nearly forty years. His long tenure of office, without parallel in Rumanian history, rendered Bratiyanu extremely unpopular, and at its close his impeachment appeared inevitable. But any proceedings taken against the minister would have involved charges against the king, who was largely responsible for his policy; and the impeachment was averted by a vote of parliament in February 1890. Bratiyanu died on the 16th of May 1891. Besides being the leading statesman of Rumania during the critical years 1876-1888, he attained some eminence as a writer. His French political pamphlets, *Mémoire sur l'empire d'Autriche dans la question d'Orient* (1855), *Réflexions sur la situation* (1856), *Mémoire sur la situation de la Moldavie depuis le traité de Paris* (1857), and *La Question religieuse en Roumanie* (1866), were all published in Paris.

For his other writings and speeches see *Din Scrierile și cuvânturile lui I. C. Bratiyanu, 1821-1891* (Bucharest, 1903, &c.), edited with a biographical introduction by D. A. Sturza. A brief anonymous biography, *Ion C. Bratiyanu*, appeared at Bucharest in 1893.

BRATLANDSDAL (i.e. Bratland valley), a gorge of southern Norway in Stavanger amt (county), formed by the Bratland river, a powerful torrent issuing into Lake Suldal. A remarkable road traverses the gorge by means of cuttings and a tunnel, and the scenery is among the most magnificent in Norway. It is usually approached from Stavanger by way of Sand and Lake Suldal, and the road divides above the gorge, branches running north to Odde and south-east through Telemarken. The

junction of the roads is near Breifond, 13 m. above Naes at the mouth of the river, on the west shore of Lake Roldal, which is fed by the snowfield to the west, north and east, and is drained by the Bratland river.

BRATTISHING, or **BRANDISHING** (from the Fr. *brèche*), in architecture, a sort of crest or ridge on a parapet, or species of embattlement. The term, however, is generally employed to describe the ranges of flowers which form the crests of so many parapets in the Tudor period.

BRATTLEBORO, a village of Windham county, Vermont, U.S.A., in a township (pop. 1910, 7541) of the same name, in the south-east part of the state, 60 m. N. of Springfield, Massachusetts, on the Connecticut river. Pop. (1890) 5467; (1900) 5297 (686 foreign-born); (1910) 6517. It is served by the Central Vermont and the Boston & Maine railways. Situated in a hilly, heavily wooded country, it is an attractive place, with a few houses dating from the 18th century. Among the manufactures are toys, furniture, overalls and organs, and the Estey and the Carpenter organs being made there. First settled about 1753, Brattleboro took its name from one of the original patentees, William Brattle (1702-1776), a Massachusetts loyalist. It was incorporated ten years later.

See H. Burnham, *Brattleboro* (Brattleboro, 1880), and H. M. Burr, *The Attractions of Brattleboro, Glimpses of Past and Present* (Brattleboro, 1866).

BRAUNAU (Czech *Broumou*), a town of Bohemia, Austria, 139 m. E.N.E. of Prague by rail. Pop. (1900) 7622, chiefly German. The town is built on a rocky eminence on the right bank of the Steine. It has an imposing Benedictine abbey, once a castle, but converted into a religious house in 1322, when Ottakar I gave the district to the Benedictines. Noteworthy also is the great church of Saints Wenceslaus and Adalbert, built between 1683 and 1733. This stands on the site where, in 1618, the Protestants attempted to build a church, the forcible prevention of which by Abbot Wolfgang Solander was the immediate cause of the protest of the Bohemian estates and the "defenestration" of the ministers Martinic and Slavata, which opened the Thirty Years' War. After the battle of the White Hill, near Prague (1620), the town was deprived of all its privileges, which were, however, in great part restored nine years later. It is now a manufacturing centre (cloth, woollen and cotton stuffs, &c.) and has a considerable trade.

BRAUNSBERG, a town of Germany, in the kingdom of Prussia, 38 m. by rail S.W. of Königsberg, on the Passarge, 4 m. from its mouth in the Frisches Haff. Pop. (1900) 12,497. It possesses numerous Roman Catholic institutions, of which the most important is the Lyceum Hosianum (enjoying university rank), founded in 1564 by the cardinal bishop Stanislaus Hosius. Brewing, tanning, and the manufactures of soap, yeast, carriages and bricks are the most important industries of the town, which also carries on a certain amount of trade in corn, ship timber and yarn. The river is navigable for small vessels. The castle of Braunsberg was built by the Teutonic knights in 1241, and the town was founded ten years later. Destroyed by the Prussians in 1262, it was restored in 1279. The town, which was the seat of the bishops of Ermeland from 1255 to 1298, was granted the "law of Lübeck" by its bishop in 1284, and admitted to the Hanseatic League. After numerous vicissitudes it fell into the hands of the Poles in 1520, and in 1626 it was captured by Gustavus Adolphus. The Swedes kept possession till 1635. It fell to Prussia by the first partition of Poland in 1772.

BRAVO (Ital. for "brave"), the name for hired assassins such as were formerly common in Italy. The word had at first no evil meaning, but was applied to the retainers of the great noble houses, or to the cavalier-type of swashbucklers familiar in fiction. In later Italian history, especially in that of Venice, the *bravi* were desperate ruffians who for payment were ready to commit any crime, however foul.

BRAWLING (probably connected with Ger. *brallen*, to roar, shout), in law, the offence of quarrelling, or creating a disturbance in a church or churchyard. During the early stages of the Reformation in England religious controversy too often

became converted into actual disturbance, and the ritual lawlessness of the parochial clergy very frequently provoked popular violence. To repress these disturbances an act was passed in 1551, by which it was enacted "that if any person shall, by words only, quarrel, chide or brawl in any church or churchyard, it shall be lawful for the ordinary of the place where the same shall be done and proved by two lawful witnesses, to suspend any person so offending, if he be a layman, from the entrance of the church, and if he be a clerk, from the ministrations of his office, for so long as the said ordinary shall think meet, according to the fault." An act of 1553 added the punishment of imprisonment until the party should repent. The act of 1551 was partly repealed in 1828 and wholly repealed as regards laymen by the Ecclesiastical Courts Jurisdiction Act 1860. Under that act, which applies to Ireland as well as to England, persons guilty of riotous, violent or indecent behaviour, in churches and chapels of the Church of England or Ireland, or in any chapel of any religious denomination, or in England in any place of religious worship duly certified, or in churchyards or burial-grounds, are liable on conviction before two justices to a penalty of not more than £5, or imprisonment for any term not exceeding two months. This enactment applies to clergy as well as to laity, and a clergyman of the Church of England convicted under it may also be dealt with under the Clergy Discipline Act of 1892 (*Girt v. Pillingham*, 1901, L.R. Prob. 176). When Mr J. Kensit during an ordination service in St Paul's cathedral "objected" to one of the candidates for ordination, on grounds which did not constitute an impediment or notable crime within the meaning of the ordination service, he was held to have unlawfully disturbed the bishop of London in the conduct of the service, and to be liable to conviction under the act of 1860 (*Kensit v. Dean and Chapter of St Paul's*, 1905, L.R. 2 K.B. 249). The public worship of Protestant Dissenters, Roman Catholics and Jews in England had before 1860 been protected by a series of statutes beginning with the Toleration Act of 1689, and ending with the Liberty of Religious Worship Act 1855. These enactments, though not repealed, are for practical purposes superseded by the summary remedy given by the act of 1860. In Scotland disturbance of public worship is punishable as a breach of the peace (*Dougall v. Dykes*, 1861, 4 Irvine 101).

In British possessions abroad interference with religious worship is usually dealt with by legislation, and not as a common-law offence. In India it is an offence voluntarily to cause disturbance to any assembly lawfully engaged in the performance of religious worship or religious ceremonies (Penal Code, s. 296). Under the Queensland Criminal Code of 1899 (s. 207) penalties are imposed on persons who wilfully and without lawful justification or excuse (the proof of which lies on them) disquiet or disturb any meeting of persons lawfully assembled for religious worship, or assault any forces lawfully officiating at such meeting, or any of the persons there assembled.

In the United States disturbance of religious worship is treated as an offence under the common law, which is in many states supplemented by legislation (see Bishop, *Amer. Crim. Law*, 8th ed. 1892, vol. 1, s. 542, vol. 2, ss. 303-305; California Penal Code, s. 302; *Revised Laws of Massachusetts*, 1902, chap. 212, s. 30.).

BRAY, SIR REGINALD (d. 1503), British statesman and architect, was the second son of Sir Richard Bray, one of the privy council of Henry VI. Reginald was born in the parish of St John Bedwardine, near Worcester, but the date of his birth is uncertain. He was receiver-general and steward of the household to Sir Henry Stafford, second husband of Margaret, countess of Richmond, whose son afterwards became King Henry VII. The accession of the king Henry VII. favoured the fortunes of Reginald Bray, who was created a knight of the Bath at the coronation and afterwards a knight of the Garter. In the first year of Henry VII.'s reign he was given a grant of the constablership of Oakham Castle in Rutland, and was appointed joint chief justice with Lord Fitz Walter of all the forest south of Trent and chosen of the privy council. Subsequently he was made high treasurer and chancellor of the duchy of

Lancaster. In October 1494 he became high steward of the university of Oxford, and he was a member of the parliament summoned in the 11th year of Henry VII's reign. In June 1497 he was at the battle of Blackheath, and his services in repressing the Cornish rebels were rewarded with a gift of estates and the title of knight banneret. His taste and skill in architecture are attested by Henry VII.'s chapel at Westminster and St George's chapel at Windsor. He directed the building of the former, and the finishing and decoration of the latter, to which, moreover, he was a liberal contributor, building at his own expense a chapel still called by his name and ornamented with his crest, the initial letters of his name, and a device representing the hemp-bray, an instrument used by hemp manufacturers. He died in 1503, before the Westminster chapel was completed, and was interred in St George's chapel.

BRAY, THOMAS (1656-1730), English divine, was born at Marton, Shropshire, in 1656, and educated at All Souls' College, Oxford. After leaving the university he was appointed vicar of Over-Whitacre, and rector of Sheldon in Warwickshire, where he wrote his famous *Catechetical Lectures*. Henry Compton, bishop of London, appointed him in 1696 as his commissary to organize the Anglican church in Maryland, and he was in that colony in 1699-1700. He took a great interest in colonial missions, especially among the American Indians, and it is to his exertions that the Society for the Propagation of the Gospel owes its existence. He also projected a successful scheme for establishing parish libraries in England and America, out of which grew the Society for Promoting Christian Knowledge. From 1706 till his death in February 1730 he was rector of St. Botolph-without, Aldgate, London, being unceasingly engaged in philanthropic and literary pursuits.

BRAY, a village in the Wokingham parliamentary division of Berkshire, England, beautifully situated on the west (right) bank of the Thames, 1 m. S. of Maidenhead Bridge. Pop. (1901) 2978. There are numerous riverside residences in the locality. The church of St Michael has portions of various dates from the Early English period onward, and is much restored. It contains a number of brasses of the 14th, 15th, 16th and 17th centuries. A well-known ballad, "The Vicar of Bray," tells how a vicar held his position by easy conversions of faith according to necessity, from the days of Charles II. until the accession of George I. and the foundation of "the illustrious house of Hanover" (1714). One Francis Carswell, who is buried in the church, was vicar for forty-two years, approximately during this period, dying in 1709; but the legend is earlier, and the name of the vicar who gave rise to it is not certainly known. That of Simon Aleyn, who held the office from c. 1540 to 1588, is generally accepted, as, in the reigns of Henry VIII., Edward VI., Mary and Elizabeth, he is said to have been successively Papist, Protestant, Papist and Protestant. The name of Simon Simonds is also given on the authority of the vicar of the parish in 1745; Simonds died a canon of Windsor in 1551, but had been vicar of Bray. Tradition ascribes the song to a soldier in Colonel Fuller's troop of dragoons in the reign of George I.

BRAY, a seaport and watering-place of Co. Wicklow, Ireland, 12 m. S.S.E. of Dublin on the Dublin & South-Eastern railway, situated on both sides of the river Bray. Pop. of urban district (1901) 7424. For parliamentary purposes it is divided between the eastern division of county Wicklow and the southern of county Dublin. A harbour was constructed by the urban district council (the harbour authority) which accommodates ships of 400 tons. There is some industry in brewing, milling and fishing, but the town, which is known as the "Irish Brighton," is almost wholly dependent for its prosperity on visitors from Dublin and elsewhere. It therefore possesses all the equipments of a modern seaside resort; there is a fine sea-wall with esplanade upwards of a mile in length; the bathing is good, and race meetings are held. The town is rapidly increasing in size. The coast, especially towards the promontory of Bray Head, offers beautiful sea-views, and some of the best inland scenery in the county is readily accessible, such as the Glens of the Dargle and the Downs, the demesne of Powerscourt, the Bray river,

with its loughs, and the pass of the Scalp. The demesne of Kilruddy, the seat of the earls of Meath, is specially beautiful. About 1170 Bray was bestowed by Richard de Clare or Strongbow, earl of Pembroke and Strigul, on Walter de Reddesford, who took the title of baron of Bray, and built a castle.

BRAYLEY, EDWARD WEDLAKE (1773-1854), English antiquary and topographer, was born at Lambeth, London, in 1773. He was apprenticed to the enamelling trade, but early developed literary tastes. He formed a close friendship with John Britton, which lasted for sixty-five years. They entered into a literary partnership, and after some small successes at song and play writing they became joint editors of *The Beauties of England and Wales*, themselves writing many of the volumes. Long after he had become famous as a topographer, Brayley continued his enamel work. In 1823 he was elected a fellow of the Society of Antiquaries. He died in London on the 23rd of September 1854. His other works include *Sir Reginalde or the Black Tower* (1803); *Views in Suffolk, Norfolk and Northamptonshire, illustrative of works of Robt. Bloomfield* (1806); *Lambeth Palace* (1806); *The History of the Abbey Church of Westminster* (2 vols., 1818); *Topographical Sketches of Brighthelmston* (1825); *Historical and Descriptive Accounts of Theatres of London* (1826); *Londiniana* (1829); *History of Surrey* (5 vols., 1841-1848).

BRAZIER (from the Fr. *brasier*, which comes from *brasia*, hot charcoal), a metal receptacle for holding burning coals or charcoal, much used in southern Europe and the East for warming rooms. Braziers are often elegant in form, and highly artistic in ornamentation, with chased or embossed feet and decorated exteriors.

BRAZIL, or **BRASIL**, a legendary island in the Atlantic Ocean. The name connects itself with the red dye-woods so called in the middle ages, possibly also applied to other vegetable dyers, and so descending from the *Insulæ Purpurariæ* of Pliny. It first appears as the *I. de Brasi* in the Venetian map of Andrea Bianco (1436), where it is found attached to one of the larger islands of the Azores. When this group became better known and was colonized, the island in question was renamed Terceira. It is probable that the familiar existence of "Brazil" as a geographical name led to its bestowal upon the vast region of South America, which was found to supply dye-woods kindred to those which the name properly denoted. The older memory survived also, and the Island of Brazil retained its place in mid-ocean, some hundred miles to the west of Ireland, both in the traditions of the forecastle and in charts. In J. Purdy's *General Chart of the Atlantic*, "corrected to 1830," the "Brazil Rock (high)" is marked with no indication of doubt, in 51° 10' N. and 15° 50' W. In a chart of currents by A.G. Findlay, dated 1853, these names appear again. But in his 12th edition of Purdy's *Memor Descriptive and Explanatory of the N. Atlantic Ocean* (1865), the existence of Brazil and some other legendary islands is briefly discussed and rejected. (See also ATLANTIS.)

BRAZIL, a republic of South America, the largest political division of that continent and the third largest of the western hemisphere. It is larger than the continental United States excluding Alaska, and slightly larger than the great bulk of Europe lying east of France. Its extreme dimensions are 2670 m. from Cape Orange (4° 21' N.) almost due south to the river Chuy (33° 45' S. lat.), and 2691 m. from Olinda (Ponta de Pedra 8° 0' 57" S., 34° 50' W.) due west to the Peruvian frontier (about 73° 50' W.). The most northerly point, the Serra Roraima on the Venezuela and British Guiana frontier (5° 10' N.), is 56 m. farther north than Cape Orange. The area, which was augmented by more than 60,000 sq. m. in 1903 and diminished slightly in the boundary adjustment with British Guiana (1904), is estimated to have been 3,228,452 sq. m. in 1900 (A. Supan, *Die Bevölkerung der Erde*, Gotha, 1904). A subsequent planimetric calculation, which takes into account these territorial changes, increases the area to 3,270,000 sq. m.

Boundaries.—Brazil is bounded N. by Colombia, Venezuela and the Guianas, N.E., E. and S.E. by the Atlantic, S. by Uruguay, Paraguay and Bolivia, and W. by Argentina, Paraguay, Bolivia, Peru, Ecuador and Colombia. Its territory

touches that of every South American nation, except Chile, and with each one there has been a boundary dispute at some stage in its political life. The Spanish and Portuguese crowns attempted to define the limits between their American colonies in 1750 and 1777, and the lines adopted still serve in great part to separate Brazil from its neighbours. Lack of information regarding the geographical features of the interior, however, led to some indefinite descriptions, and these have been fruitful sources of dispute ever since. The Portuguese were persistent trespassers in early colonial times, and their land-hunger took them far beyond the limits fixed by Pope Alexander VI. In the boundary disputes which have followed, Brazil seems to have pursued this traditional policy, and generally with success.

Beginning at the mouth of the Arroyo del Chuy, at the southern extremity of a long sandbank separating Lake Mirim from the Atlantic ($33^{\circ}45'$ S. lat.), the boundary line between Brazil and Uruguay passes up that rivulet and across to the most southerly tributary of Lake Mirim, thence down the western shore of that lake to the Jaguarão and up that river to its most southerly source. The line then crosses to the hill-range called Cuchilla de Sant' Anna, which is followed in a north-west direction to the source of the Cuareim, or Quarahy, this river becoming the boundary down to the Uruguay. This line was fixed by the treaty of 1851, by which the control of Lake Mirim remains with Brazil. Beginning at the mouth of the Quarahy, the boundary line between Brazil and Argentina ascends the Uruguay, crosses to the source of the Santo Antonio, and descends that small stream and the Iguassú to the Paraná, where it terminates. This line was defined by the treaty of 1857, and by the decision of President Cleveland in 1895 with regard to the small section between the Uruguay and Iguassú rivers. The boundary with Paraguay was definitely settled in 1872. It ascends the Paraná to the great falls of Guayrá, or Sete Quedas, and thence westward along the water-parting of the Sierra de Maracayú to the *cerro* of that name, thence northerly along the Sierra d'Amambay to the source of the Estrella, a small tributary of the Apá, and thence down those two streams to the Paraguay. From this point the line ascends the Paraguay to the mouth of the Rio Negro, the outlet of the Bahia Negra, where the Bolivian boundary begins. As regards the Peruvian boundary, an agreement was reached in 1904 to submit the dispute to the arbitration of the president of Argentina in case further efforts to reach an amicable settlement failed. The provisional line, representing the Brazilian claim, begins at the termination of the Bolivian section (the intersection of the 11th parallel with the meridian of $72^{\circ}26'$ W. approx.) and follows a semicircular direction north-west and north to the source of the Javary (or Yavary), to include the basins of the Purús and Juruá within Brazilian jurisdiction. The line follows the Javary to its junction with the Amazon, and runs thence north by east direct to the mouth of the Apaporis, a tributary of the Yapurá, in about $1^{\circ}30'$ S. lat., $69^{\circ}20'$ W. long., where the Peruvian section ends. The whole of this line, however, was subject to future adjustments, Peru claiming all that part of the Amazon valley extending eastward to the Madeira and lying between the Beni and the east and west boundary line agreed upon by Spain and Portugal in 1750 and 1777, which is near the 7th parallel. With regard to the section between the Amazon and the Apaporis river, already settled between Brazil and Peru, the territory has been in protracted dispute between Peru, Ecuador and Colombia; but a treaty of limits between Brazil and Ecuador was signed in 1901 and promulgated in 1905. The boundary with Colombia, fixed by treaty of April 24, 1907, follows the lower rim of the Amazon basin, as defined by Brazil. The Colombian claim included the left bank of the Amazon eastward to the Auahy or Avahy-paraná channel between the Amazon and Yapurá, whence the line ran northward to the Negro near the intersection of the 66th meridian. The Brazilian line ran north and north-west from the mouth of the Apaporis to the 70th meridian, which was followed to the water-parting south of the Uaupés basin, thence north-east to the Uaupés river, which was crossed close to the 69th meridian, thence easterly along the Serra Tunaji

and Isana river to Cuyari, thence northerly up the Cuyari and one of its small tributaries to the Serra Capparro, and thence east and south-east along this range to the Cucuy rock (Pedra de Cucuy) on the left bank of the Negro, where the Colombian section ends. Negotiations for the settlement of this controversy, which involved fully one-third of the state of Amazonas, were broken off in 1870, but were resumed in 1905. The boundary with Venezuela, which was defined by a treaty of 1859, runs south-eastward from Cucuy across a level country intersected by rivers and channels tributary to both the Negro and Orinoco, to the Serra Cupuy watershed which separates the rivers of the Amazon and Orinoco valleys. This watershed includes the ranges running eastward and northward under the names of Imeri, Tapiira-peco, Curupira, Parima and Pacaraima, the Venezuelan section terminating at Mt. Roraima. On the 9th of December 1905 protocols were signed at Caracas accepting the line between Cucuy and the Serra Cupuy located in 1880, and referring the remainder, which had been located by a Brazilian commission in 1882 and 1884, to a mixed commission for verification.

The disputed boundary between Brazil and British Guiana, which involved the possession of a territory having an estimated area of 12,741 sq. m., was settled by arbitration in 1904 with the king of Italy as arbitrator, the award being a compromise division by which Great Britain received about 7336 sq. m. and Brazil about 5405. The definite boundary line starts from Mt. Roraima and follows the water-parting east and south to the source of the Ireng or Mahu river, which with the Takutu forms the boundary as far south as 1° N. to enclose the basin of the Essequibo and its tributaries, thence it turns east and north of east along the Serra Acaria to unite with the unsettled boundary line of Dutch Guiana near the intersection of the 2nd parallel north with the 56th meridian. Negotiations were initiated in 1905 for the definite location of the boundary with Dutch Guiana. Running north-east and south-east to enclose the sources of the Rio Paru, it unites with the French Guiana line at $2^{\circ}10'$ N., 55° W., and thence runs easterly along the water-parting of the Serra Tumuc-Humac to the source of the Oyapok, which river is the divisional line to the Atlantic coast. The boundary with French Guiana (see GUIANA), which had long been a subject of dispute, was settled by arbitration in 1900, the award being rendered by the government of Switzerland. The area of the disputed territory was about 34,750 sq. m.

Physical Geography.—A relief map of Brazil shows two very irregular divisions of surface: the great river basins, or plains, of the Amazon-Tocantins and La Plata, which are practically connected by low elevations in Bolivia, and a huge, shapeless mass of highlands filling the eastern projection of the continent and extending southward to the plains of Rio Grande do Sul and westward to the Bolivian frontier. Besides these there are a narrow coastal plain, the low plains of Rio Grande do Sul, and the Guiana highlands on the northern slope of the Amazon basin below the Rio Negro.

The coastal plain consists in great part of sandy beaches, detritus formations, and partially submerged areas caused by uplifted beaches and obstructed river channels. Mangrove swamps, lagoons and marshes, with inland canals following the coast line for long distances, are characteristic features of a large extent of the Brazilian coast. Parts of this coastal plain, however, have an elevation of 100 to 200 ft., are rolling and fertile in character, and terminate on the coast in a line of bluffs. In the larger depressions, like that of the Reconcavo de Bahia, there are large alluvial areas celebrated for their fertility. This plain is of varying width, and on some parts of the coast it disappears altogether. In Rio Grande do Sul, where two large lakes have been created by uplifted sand beaches, the coastal plain widens greatly, and is merged in an extensive open, rolling grassy plain, traversed by ridges of low hills (*cachillas*), similar to the neighbouring republic of Uruguay. The western part of this plain is drained by the Uruguay and its tributaries, which places it within the river Plate (La Plata) basin.

The two great river basins of the Amazon-Tocantins and La Plata comprise within themselves, approximately, three-fifths of the total area of Brazil. Large areas of these great river plains are annually flooded, the flood-plains of the Amazon extending nearly across the whole country and comprising thousands of square miles. The Amazon plain is heavily forested and has a slope of less than one inch to the mile within Brazilian territory—one competent authority placing it at about one-fifth of an inch per mile. The La Plata basin

is less heavily wooded, its surface more varied, and its Brazilian part stands at a much higher elevation.

Of the two highland regions of Brazil, that of the northern slope of the Amazon basin belongs physically to the isolated mountain system extending eastward from the Negro and Orinoco to the Atlantic, the water-parting of which forms the boundary line between the Guianas and Brazil. The culminating point is near the western extremity of this chain and its altitude is estimated at 8500 ft. The ranges gradually diminish in elevation towards the east, the highest point of the Tumuc-Humac range, on the frontier of French Guiana, being about 2600 ft. The Brazilian plateau slopes southward and eastward, traversed by broken ranges of low mountains and deeply eroded by river courses. The table-topped hills of Almeirim (or Almeirim) and Ereré, which lie near the lower Amazon and rise to heights of 800 and 900 ft., are generally considered the southernmost margin of this plateau, though Agassiz and others describe them as remains of a great sandstone sheet which once covered the entire Amazon valley. Its general elevation has been estimated to be about 2000 ft. It is a stony, semi-arid region, thinly wooded, having good grazing *campos* in its extreme western section. Its semi-arid character is due to the mountain ranges on its northern frontier, which extract the moisture from the north-east trades and leave the Brazilian plateau behind them with a very limited rainfall, except near the Atlantic coast. The more arid districts offer no inducement for settlement and are inhabited only by a few roving bands of Indians, but there were settlements of whites in the grazing districts of the Rio Branco at an early date, and a few hundreds of adventurers have occupied the mining districts of the east. In general, Brazilian Guiana, as this plateau region is sometimes called, is one of the least attractive parts of the republic.

The great Brazilian plateau, which is the most important physical division of Brazil, consists of an elevated tableland 1000 to 3000 ft. above the sea-level, traversed by two great mountain systems, and deeply eroded and indented by numerous rivers. A thick sandstone sheet once covered the greater part if not all of it, remains of which are found on the elevated *chapadas* of the interior and on isolated elevations extending across the republic toward its western frontier. These *chapadas* and elevations, which are usually described as mountain ranges, are capped by horizontal strata of sandstone and show the original surface, which has been worn away by the rivers, leaving here and there broad flat-topped ridges between river basins and narrower ranges of hills between river courses. From the valleys their rugged, deeply indented escarpments, stretching away to the horizon, have the appearance of a continuous chain of mountains. The only true mountain systems, however, so far as known, are the two parallel ranges which follow the contour of the coast, and the central, or Goyana, system. The first consists of an almost continuous range crossing the northern end of Rio Grande do Sul and following the coast northward to the vicinity of Cape Frio, and thence northward in broken ranges to the vicinity of Cape St Roque, and a second parallel range running from eastern São Paulo north-east and north to the eastern margin of the São Francisco basin in northern Bahia, where that river turns eastward to the Atlantic. The first of these is generally known as the Serra do Mar, or Coast Range, though it is locally known under many names. Its culminating point is in the Organ Mountains (Serra dos Organos), near Rio de Janeiro, which reaches an elevation of 7323 ft. The inland range, which is separated from the Coast Range in the vicinity of Rio de Janeiro by the valley of the Parahyba do Sul river, is known as the Serra da Mantiqueira, and from the point where it turns northward to form the eastern rim of the São Francisco basin, as the Serra do Espinhaço. This range is also known under various local names. Its culminating point is toward the western extremity of the Mantiqueira range where the Itatiaia, or Itatiaia-açu, peak rises to an elevation of 8898 ft. (other measurements give 9823 ft.), probably the highest summit in Brazil. This range forms the true backbone of the maritime mountainous belt and rises from the plateau itself, while the Coast Range rises on its eastern margin and forms a rim to the plateau. North of Cape Frio the Coast Range is much broken and less elevated, while the Serra do Espinhaço takes a more inland course and is separated from the coast by great gently-sloping, semi-barren terraces. The second system—the Central, or Goyana—consists of two distinct chains of mountains converging toward the north in the elevated *chapadão* between the Tocantins and São Francisco basins. The eastern range of this central system, which crosses western Minas Geraes from the so-called Serra das Vertentes to the valley of the Paracatú, a western tributary of the São Francisco, is called the Serra da Canastra and Serra da Matta da Corde. Its culminating point is toward its southern extremity in the Serra da Canastra, 4206 ft. above sea-level. The western range, or what is definitely known of it, runs across southern Goyaz, south-west to north-east, and forms the water-parting between the Paraná and Tocantins-Araguaya basins. Its culminating point is in the Montes Pyreneos, near the city of Goyaz, and is about 4500 ft. above sea-level.

The great part of this immense region consists of *chapadas*, as the larger table-land areas are called, *chapadas* or smaller sections of the same, and broadly excavated river valleys. How extensive this work of erosion has been may be seen in the Tocantins-Araguaya basin, where a great pear-shaped depression, approximately 100 to

500 m. wide, 700 m. long, and from 1000 to 1500 ft. deep, been excavated northward from the centre of the plateau. So ward the Paraná has excavated another great basin and eastward the São Francisco another. Add to these the eroded river basin the Xingú, Tapajós and Guaporé on the north and west, the Paraguay on the south-west, and the scores of smaller rivers along the Atlantic coast, and we may have some conception of the agent that have been at work in breaking down and shaping this plateau-land, perhaps the oldest part of the continent. The southern of these *chapadas*, that of the Paraná basin, in which is included the northern part of the Uruguay and eastern part of the Paraguay basins, includes the greater part of the states of Grande do Sul, Santa Catharina, Paraná and São Paulo, and the western corner of Minas Geraes, a part of southern Goyaz, and the south-eastern corner of Matto Grosso. The greatest elevation of its eastern or Atlantic margin where the average is about 2500 ft. above sea-level. The plateau breaks down abruptly toward the west and slopes gradually some hundreds of feet toward the south and west. There has been considerable denudation toward the west, the eastern tributaries of the Paraná rising very near the coast. The northern and western parts of this plateau have an average elevation a little less than that of the Atlantic margin, and the slopes are toward the south and east, those of Goyaz and Minas Geraes being abrupt and deeply eroded. This great *chapadão* in many respects the best part of Brazil, having a temperate climate, extensive areas of fertile soil, rich forests and a regular rainfall. Its Atlantic slopes are heavily wooded, but the western slopes are grass-covered *campos* between the river courses. The São Francisco *chapadão*, which has a general elevation of about 2600 ft., covers the greater part of the states of Minas Geraes and Bahia, and a small part of western Pernambuco, and might also be considered continuous with those of the Parahyba and Tocantins-Araguaya basins. This region is more tropical in character, partially bare and has an uncertain rainfall, a large part of the São Francisco basin and the upper Atlantic slope of its eastern rim being subject to long-continued droughts. This region is well wooded along the river courses of Minas Geraes, the lower Atlantic slopes of Bahia which are perhaps outside the plateau proper, and on the west side of some of the elevated ridges where the rainfall is heavy and regular. It has extensive *campos* and large areas of exposed sand and stony steppes, but is richly provided with mineral deposits, breaks down less abruptly toward the Atlantic, the slopes in Bahia being long and gradual. The Parahyba *chapadão* covers the state of Piahyá, the southern part of Maranhão, and the western part of Ceará. Its general elevation is less than that of the São Francisco region, owing to the slope of the plateau surface toward the Amazon depression and to denudation. It resembles the São Francisco region in its uncertain rainfall and exposure to droughts, and in having large areas of *campos* suitable for grazing purposes. It is thinly wooded except in the north, where the climatic conditions approach those of the Amazon valley. Its climate is more tropical and its development has gone forward less rapidly than in the more temperate regions of the south. The Amazonian *chapadão*, which includes the remainder of the great Brazilian plateau west of the São Francisco and Parahyba regions and which appears to be the continuation of these tablelands westward, is much the largest of these plateau divisions. It covers the greater part of the states of Matto Grosso and Goyaz, a large part of southern Pará, the southern margin of Amazonas, and a considerable part of western Maranhão. It includes the river basins of the Tocantins-Araguaya, Xingú, Tapajós and the eastern tributaries of the Guaporé-Madeira. A considerable part of it has been excavated by these rivers to a level which in their valleys the elevation and character of lowlands, though isolated hills and ranges with the characteristic overlying horizontal sandstone strata of the ancient plateau show that it was once a high region. The southern margin of this plateau breaks down abruptly toward the south and overlooks the Paraná and Paraguay basins from elevations of 2600 to 3000 ft. There is great diversity in the character and appearance of this extensive region. It lies within the tropics, though its more elevated districts enjoy a temperate climate. Its *chapadas* are covered with extensive areas of shallow valleys with open woodlands, and its deeper valleys with heavy forests. The rainfall is good, but not heavy. The general slope is toward the Amazon, and its rivers debouch upon the Amazonian plain through a succession of falls and rapids.

There remains only the elevated valley of the Parahyba do Sul lying between the so-called Serra das Vertentes of southern Minas Geraes and the Serra do Mar, and extending from the Serra Bocaina, near the city of São Paulo, eastward to Cape Frio and the coastal plain north of that point. It includes a small part of eastern São Paulo, the greater part of the state of Rio de Janeiro, the corner of Espírito Santo, and a narrow strip along the southern border of Minas Geraes. It is traversed by two mountain chains, the Serra da Mantiqueira and Serra do Mar, and the broad, flat valley of the Parahyba do Sul which lies between them, and whose slopes gently toward the east from a general elevation exceeding 2000 ft. in São Paulo. This region is the smallest of the plateau divisions of the great plateau, and might be considered either a southward extension of the São Francisco or an eastward extension of the Paraná *chapadão*. It is one of the most favoured regions

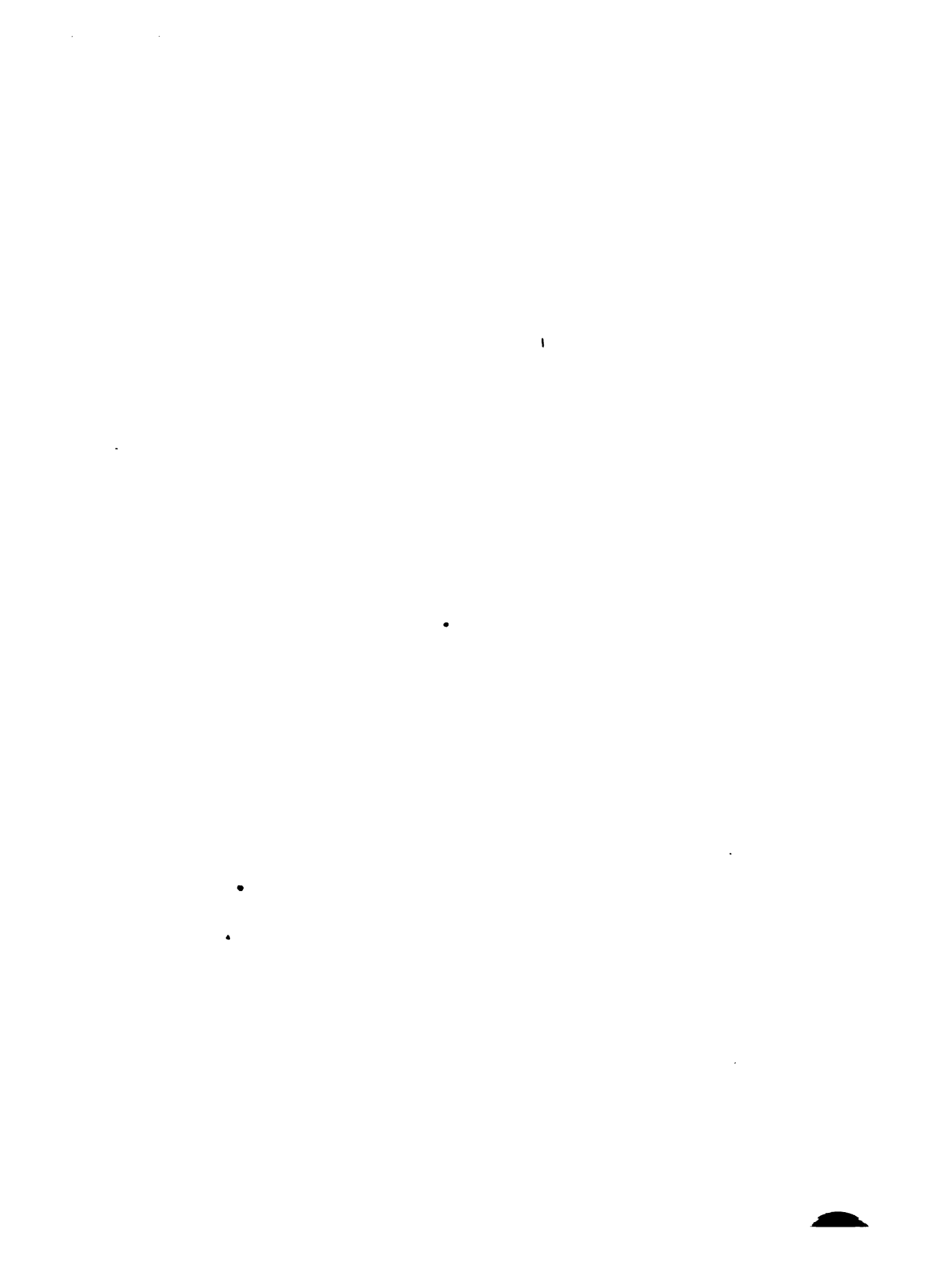

Brazil, having an abundant rainfall, extensive forests of valuable timber, and large areas of fertile soil. The mountain slopes are still masses of dense forest, though their lower elevations and neighbouring valleys have been cleared for cultivation and by dealers in rosewood and other valuable woods. This elevated valley is noted for its fertility and was once the principal coffee-producing district of Brazil.

Outside the two great river systems of the Amazon and river Plate (Rio de la Plata), which are treated under their respective titles, the rivers of Brazil are limited to the numerous small streams and three or four large rivers which flow eastward from the plateau regions directly into the Atlantic. The Amazon system covers the entire north-western part of the republic, the state of Amazonas, nearly the whole of Pará and the greater part of Matto Grosso being drained by this great river and its tributaries. If the Tocantins-Araguaya basin is included in the hydrographic system, the greater part of Goyaz and a small part of Maranhão should be added to this drainage area. The Tocantins is sometimes treated as a tributary of the Amazon because its outlet, called the Rio Pará, is connected with that great river by a number of inland channels. It is an entirely separate river, however, and the inland communication between them is due to the slight elevation of the intervening country above their ordinary levels and to the enormous volume of water brought down by the Amazon, especially in the flood season. As the outlet of the Tocantins is so near to that of the Amazon, and their lower valleys are continuous, it is convenient to treat them as parts of the same hydrographic basin.

In the extreme north-east corner of the republic where the Brazilian Guiana plateau slopes toward the Atlantic there is a small area lying outside the drainage basin of the Amazon. Its rivers flow easterly into the Atlantic and drain a triangular-shaped area of the plateau lying between the northern frontier and the southern and western watersheds of the Araguaya, whose extreme limits are about 5° 30' N. lat. and 53° 50' W. long. The more important of these rivers are the Araguaya, Amapá, Calçoene, Cassiporé and Oyapok. The Araguaya rises in the Tumuc-Humac mountains, in about 5° 30' N. lat., 52° 10' W. long., and follows a tortuous course south and north-east to the Atlantic. Its largest tributary, the Amapary, rises still farther west. Little is known of the country through which it flows, and its channel is broken by rapids and waterfalls where it descends to the coastal plain. The Amapá is a short river rising on the eastern slopes of the same range and flowing across a low, wooded plain, filled with lagoons. The Calçoene and Cassiporé enter the Atlantic farther north and have a north-east course across the same plain. All these small rivers are described as auriferous had have attracted attention for this reason. The Oyapok, or Vicente Pinzon, is the best-known of the group and forms the boundary line between Brazil and French Guiana under the arbitration award of 1900. It rises in about 2° 05' N., 53° 48' W., and flows easterly and north-easterly to the Atlantic. Its course is less tortuous than that of the Araguaya.

The rivers of the great Brazilian plateau which flow directly to the Atlantic coast may be divided into two classes: those of its northward slope which flow in a northerly and north-easterly direction to the north-east coast of the republic, and those which drain its eastern slope and flow to the sea in an easterly direction. The former reach the coastal plain over long and gradual descents, and are navigable for considerable distances. The latter descend from the plateau much nearer the coast, and are in most cases navigable for short distances only. In both classes navigation is greatly impeded by sandbars at the mouths of these rivers, while in the districts of periodical rainfall it is greatly restricted in the dry season. The more important rivers of the first division, which are described in more detail under the titles of the Brazilian states through which they flow, are the following: the Gurupy, Tury-assú, Mearim, Itapicuru and Balsas, in the state of Maranhão; the Parnaíba and its tributaries in Piauhy; Jaguaribe in Ceará; and the Apody and Piranhas in Rio Grande do Norte. Of these the Parnaíba is the most important, having a total length of about 900 m., broken at intervals by rapids and navigable in sections. It receives only one important tributary from Maranhão—the Rio das Balsas, 417 m. long—and five from Piauhy, the Urussuby-assú, Gurgueia, Canindé, Poty and Longa. Piauhy is wholly within its drainage basin, although the river forms the boundary line between that state and Maranhão throughout its entire length. All the rivers in this division are influenced by the periodical character of the rainfall, their navigable channels being greatly shortened in the dry season (August-January). In Ceará the smaller rivers become dry channels in the dry season, and in protracted droughts the larger ones disappear also.

The rivers of the second division are included in a very great extension of coast and are influenced by wide differences in climate. Their character is also determined by the distance of the Serra do Mar from the coast, the more southern rivers having short precipitous courses. The more northern rivers are subject to periodical variations in volume caused by wet and dry seasons, but the greater distance of the coast range and the more gradual breaking down of the plateau toward the sea, give them longer courses and a greater extent of navigable water. North of the São Francisco the watershed

projecting from the plateau eastward toward Cape St Roque, known as the Serra da Borboroma in Parahyba and Rio Grande do Norte where its direction becomes north-east, leaves a triangular section of the easterly slope in which the river courses are short and much broken by rapids. The rainfall, also, is limited and uncertain. The largest of this group of small rivers is the Parahyba do Norte, belonging to the state of Parahyba, whose length is said to be less than 200 m., only 5 or 6 m. of which are navigable for small steamers. The São Francisco, which belongs to the inland plateau region, is the largest river of the eastern coast of Brazil and exists by virtue of climatic conditions wholly different from those of the coast where it enters the Atlantic. The tributaries of the lower half of this great river, which belong to the Atlantic coast region, are small and often dry, but the upper river where the rainfall is heavier and more regular receives several large affluents. The river is navigable up to the Paulo Affonso falls, 192 m. from the coast, and above the falls there is a much longer stretch of navigable water.

From the São Francisco to Cape Frio there are many short rivers rising on the slopes of the plateau and crossing the narrow coastal plain to the sea. There are also a few of greater length which rise far back on the plateau itself and flow down to the plain through deeply cut, precipitous courses. The navigable channels of these rivers are restricted to the coastal plain, except where a river has excavated for itself a valley back into the plateau. The more important of these rivers are the Itapicuru, Paraguassú, Contas or Jussiapé, Pardo or Patype, and Jequitinhonha, of Bahia; the Mucury, and Doce, of Espírito Santo; and the Parahyba do Sul of the state of Rio de Janeiro. Of the Bahia group, the Jequitinhonha, sometimes called the Belmonte on its lower course, is the longest and most important, rising near Serro in the state of Minas Geraes and flowing in a curving north-east direction for a distance of about 500 m., 84 of which are navigable inland from the sea. The Mucury and Doce also rise in Minas Geraes, and are much broken in their descent to the lower plains, the former having a navigable channel of 98 m. and the latter of 138 m. The Parahyba, or Parahyba do Sul, which enters the sea about 30 m. north of Cape S. Thomé, is the largest and most important of the Atlantic coast rivers south of the São Francisco. It rises on an elevated tableland in the state of São Paulo and flows across the state of Rio de Janeiro from west to east, through a broad fertile valley producing coffee in its most elevated districts and sugar on its alluvial bottom-lands nearer the sea. It has a total length of 658 m., 57 of which are navigable between S. Fidelis and its mouth, and about 90 m. of its upper course.

South of Cape Frio there are no large rivers along the coast because of the proximity of the Serra do Mar—the coastal plain being very narrow and in places disappearing altogether. There are many short streams along this coast, fed by heavy rainfall, but they have no geographic importance and no economic value under existing conditions. The largest of these and the only one of commercial value is the Ribeira do Iguape, which has its source on the tablelands of Paraná and after receiving several affluents west of the Serra do Mar breaks through a depression in that range and discharges into the Atlantic some miles below Santos on the southern boundary of the state of São Paulo. This river has a navigable channel of 116 m. below Xicriza, and communicates with an inland canal or waterway extending for many miles along this coast and known as the Iguape, or Mar Pequeno. In Rio Grande do Sul the Atlantic coastal plain extends westward more than half-way across the state, and is well watered by numerous streams flowing eastward to the Lagoa dos Patos. Of these only two are of large size—the Guayba and Camaquam. The first is formed by the confluence of the Jacuhy, Cahy, Sinos and Gravatahy, and is known under this name only from Porto Alegre to the Ponta de Itapú, where it enters the Lagoa dos Patos. This river system drains a large part of the northern mountainous region of the state, and has a considerable extension of navigable channels between the plateau margin and the lake. In the extreme southern part of the state, the Lagoa Mirim empties into the Lagoa dos Patos through a navigable channel 61½ m. long, called the Rio São Gonçalo.

The Brazilian rivers of the Rio de la Plata system are numerous and important. Those of the Paraguay drain the south-western part of Matto Grosso and the tributaries of the Paraná cover the western slopes of the Serra do Mar from Rio Grande do Sul north to the south-west part of Minas Geraes, and include the south-east part of Matto Grosso and the south part of Goyaz within their drainage basin. This is one of the most important fluvial systems of Brazil, but its economic value is impaired by the great waterfalls of Guayra, or Sete Quedas, and Urubí-punga, and by the rapids and waterfalls in the majority of its affluents near their junction with the main stream. Between the two great waterfalls of the Paraná there is an open channel of 276 m., passing through a rich and healthy country, and receiving large tributaries from one of the most fertile regions of Brazil. Among the larger of these are the great falls of the Iguassú, near the junction of that river with the Paraná. Though the Uruguay plays a less important part, its relations to the country are similar to those of the Paraná, and its tributaries from the plateau region are similarly broken by falls and rapids. The Paraguay is in great part a lowland river, with a sluggish current, and is navigable by large river steamers up to Corumbá, and by smaller steamers to Cuyabá and the mouth of the Jaurú.

Compared with the number, length and volume of its rivers, Brazil has very few lakes, only two of which are noticeable for their size. There are a number of lakes in the lowland region of the Amazon valley, but these are mainly overflow reservoirs whose areas expand and contract with the rise and fall of the great river. The coastal plain is also intersected by lagoons, lakes and inland channels formed by uplifted beaches. These inland channels often afford many miles of sheltered navigation. The lakes formed in this manner are generally shallow, and are sometimes associated with extensive swamps, as in southern Bahia. The lakes of the Alagôas coast, however, are long, narrow and deep, occupying valleys which were deeply excavated when the land stood at a higher level, and which were transformed into lakes by the elevation of the coast. The largest of these are the Lagoa do Norte, on whose margin stands the city of Macció, and the Lagoa do Sul, a few miles south of that city. Both have outlets to the sea, and the former is salt. There is a large number of these lakes along the coasts of Espírito Santo and Rio de Janeiro, some of them of considerable size. The two largest lakes of this class are on the coast of Rio Grande do Sul and are known as the Lagoa dos Patos and Lagoa Mirim. Both of these lakes lie nearly parallel with the coast line, are separated from the ocean by broad sand beaches filled with small lakes, and communicate with the ocean through the same channel. The Lagoa dos Patos is about 124 m. long with a maximum width of 37 m., and Lagoa Mirim is 108 m. long with a maximum width of 15 m. Both are navigable, though comparatively shallow and filled with sandbanks. So far as known, there are no lakes of noteworthy size in the interior of the country. There are a few small lakes in Maranhão and Piahy, some in Goyaz in the great valley of the Araguaia, and a considerable number in Matto Grosso, especially in the Paraguary basin, where the sluggish current of that river is unable to carry away the rainfall in the rainy season.

The coast of Brazil is indented with a number of almost landlocked bays, forming spacious and accessible harbours. The larger and more important of these are Todos os Santos, on which is located the city of São Salvador or Bahia, and Rio de Janeiro or Guanabara, beside which stands the capital of the republic. These two are freely accessible to the largest ships afloat. The bays of Espírito Santo, Paranaçu and São Francisco have similar characteristics, but they are smaller and more difficult of access. The first is the harbour for the city of Victoria, and the other two for ports of the same name in southern Brazil. The port of Pernambuco, or Recife, is formed by a stone reef lying across the entrance to a shallow bay at the mouth of two small rivers, Beberibe and Capibaribe, and is accessible to steamers of medium draught. Santa Catharina and Maranhão have well-sheltered harbours formed by an island lying in the mouth of a large bay, but the latter is shallow and difficult of access. Pará, Parnahyba, Parahyba, Santos and Rio Grande do Sul are river ports situated near the sea on rivers having the same name; but, with the exception of Pará and Santos, they are difficult of access and are of secondary importance. There are still other bays along the coast which are well adapted for commercial purposes but are used only in the coasting trade. Many of the Atlantic coast rivers would afford excellent port facilities if obstructions were removed from their mouths.

Geology.—Brazil is a region which has been free from violent disturbances since an early geological period. It has, indeed, been subject to oscillations, but the movements have been regional in character and have not been accompanied by the formation of any mountain chain or any belt of intense folding. From the Devonian onwards the beds lie flat or dip at low angles. They are faulted but not sharply folded. The mountain ranges of the east of Brazil, from Cape St Roque to the mouth of the river Plate, are composed chiefly of crystalline and metamorphic rocks. Some of the metamorphic rocks may belong to the older Palaeozoic period, but the greater part of the series is probably Archaean. Similar rocks cover a large area in the province of Goyaz and in the south of the Matto Grosso, and they form, also, the hills which border the basin of the Amazon on the confines of Venezuela and Guiana. They constitute, in fact, an incomplete rim around the basin of sedimentary beds which occupies the Amazonian depression. In a large part of this basin the covering of sedimentary deposits is comparatively thin. The crystalline floor is exposed in the valleys of the Madeira, Xingú, &c. Some of the rocks thus exposed are, however, eruptive (e.g. in the Tapajoz), and probably do not belong to the Archaean. The crystalline rocks are succeeded by beds which have been referred to the Cambrian and Silurian systems. In the valley of the Trombetas, one of the northern tributaries of the Amazon, fossils have been found which indicate either the top of the Ordovician or the bottom of the Silurian. In the Maccuru, another northern affluent, graptolites of Ordovician age have been discovered, and Silurian fossils are said to have been found in the Maracá. Elsewhere the identification of the Silurian and older systems does not rest on palaeontological evidence. Devonian beds cover a much more extensive area. They crop out in a band some 25 to 50 m. north of the lower Amazon and in another band at a still greater distance south of that river. These bands are often concealed by more recent deposits, but it is clear that in this region the Devonian beds form a basin or synclinal with the Amazon for its axis. Devonian beds also lie upon the older rocks in the Matto Grosso and other provinces in the interior of Brazil, where they

generally form plateaux of nearly horizontal strata. Fossils have been found in many localities. They belong to either the lower or the middle division of the Devonian system. The fauna shows striking analogies with that of the Bokkeveld beds of South Africa on the one hand and of the Hamilton group of North America on the other. The Carboniferous system in Brazil presents itself under two faces: the one marine and the other terrestrial. In the basin of the Lower Amazon the Carboniferous beds lie within the Devonian syncline and crop out on both sides of the river next to the Devonian beds. There is a lower series consisting of sandstone and an upper series of limestone. The former appears to be almost unfossiliferous, the latter has yielded a rich marine fauna, which belongs to the top of the Carboniferous or to the Permian-carboniferous. In southern Brazil, on the other hand, in Rio Grande do Sul, Paraná, &c., the beds of this period are of terrestrial origin, containing coal seams and remains of plants. Some of the plants are European forms, other belong to the Glossopteris flora characteristic of India and South Africa. The beds are homotaxial with the Karharbari series of India and represent either the top of the Carboniferous or the base of the Permian of Europe. The only Mesozoic system which is represented in Brazil by marine beds is the Cretaceous, and the marine facies is restricted to the coasts and the basin of the Amazon. In the province of Sergipe, on the east coast, the beds are approximately of the horizon of the Cenomanian; in the valley of the Amazon they belong to the highest parts of the Cretaceous system, and the fauna shows Tertiary affinities. In the interior of Brazil, the Palaeozoic beds are directly overlaid by a series of red sandstones, &c., which appear to be of continental origin and of which the age is uncertain. Tertiary beds cover a considerable area, especially in the Amazonian depression. They consist chiefly of sands and clays of aeolian and freshwater origin. Of the Pleistocene and recent deposits the most interesting are the remains of extinct animals (*Glyptodon*, *Mylodon Megatherium*, &c.) in the caves of the São Francisco.

From the above account it will appear that, excepting near the coast and in the basin of the Amazon, there is no evidence that any part of Brazil has been under the sea since the close of the Devonian period. During the Triassic and Jurassic periods even the basin of the Amazon appears to have been dry land. Eruptive rocks occur in the Devonian and Carboniferous beds, but there is no evidence of volcanic activity since the Palaeozoic epoch. The remarkable "stone reefs" of the north-east coast are ancient beaches hardened by the infiltration of carbonate of lime. They are quite distinct in their formation from the coral reefs of the same coast.

Climate.—Brazil lies almost wholly within the torrid zone, less than one-twelfth of its area lying south of the tropic of Capricorn. In general terms, it is a tropical country, with sub-tropical and temperate areas covering its three southern states and a great part of the elevated central plateau. The forest-covered, lowland valley of the Amazon is a region of high temperatures which vary little throughout the year, and of heavy rainfall. There is no appreciable change of seasons, except that produced by increased rainfall in the rainy season. The average temperature according to Castelnau is about 78°F., or 82-40° to 84-20° F. according to Agassiz. There is an increase in the rainfall from August to October, and again from November to March, the latter being the regular rainy season, but the time varies considerably between the valley of the upper Amazon and those of the upper Madeira and Negro. There is usually a short dry season on the upper Amazon in January and February, which causes two annual floods—that of November-December, and the great flood of March-June. The subsidence of the latter usually lasts until October. The average rainfall throughout the whole Amazon valley is estimated by Reclus as "probably in excess of 2 metres" (78.7 in.), and the maximum rise of the great flood is about 45 ft. The prevailing winds in the Amazon valley are easterly and westerly (or south-westerly), the former warm and charged with moisture, the latter dry and cold. The easterly winds, which are deflections of the trade winds, blow upstream with great regularity and force, more especially in the winter or dry season, and are felt as far inland as the mouths of the Madeira and Negro. Above these they are less regular and are attracted northward by the head winds of Venezuela in winter, or southward by the heated winds of Matto Grosso in summer. The cold south-westerly winds are felt when the sun is north of the equator, and are most severe a few days, in the month of May, when a *tempo da friagem* (cold period) causes much discomfort throughout the upper Amazon region. There are winter winds from the Andes, but in the summer season there are cold currents of air from up-river (*senhas da cima*) which are usually followed by downpours of rain.

The coastal plain as far south as Santos is a region of high temperatures and great humidity. The year is usually divided into a winter (*inverno*) and summer (*verão*), corresponding approximately to a dry and wet season. The "dry" season, however, is a season of moderate rainfall, except on the north-east coast where arid conditions prevail. Another exception is that of the Pernambuco coast where the rainy season comes between March and August, with the heaviest rainfall from May to July, which is the time of the southern winter. Going southward there is also a gradual decrease in the mean annual temperature, the difference between Rio de Janeiro and the Amazon being about 5°. The north-east coast, which is sandy and barren, shows an average mean annual temperature

Fortaleza) of nearly 80° F., which is slightly higher than those of Maranhão and Pará. At Pernambuco the mean summer temperature is 79.5° and that of winter 76.8°, which are about 3° lower than the mean temperature of Bahia in summer, and 5° higher than the Bahia mean in winter. South of Bahia there is a gradual increase in the rainfall, that of Rio de Janeiro exceeding 43 in. per annum. At Santos the rainfall is exceptionally heavy and the mean temperature high, but below that point the climatic conditions are considerably modified, the range in temperature being greater, the mean annual temperature lower, and the rainfall more evenly distributed throughout the year. The winds are more variable, and the seasons are more sharply defined. In Rio Grande do Sul the range in temperature is from 26° to 80°, the climate being similar to that of Uruguay. At Pelotas, a sea-level port on Lagoa dos Patos, the mean annual temperature is about 63° and the annual rainfall about 42 in. Extreme variations in temperature are often produced by cold south-west storms from the Argentine pampas, which sweep across southern Brazil as far north as Cape Frio, the fall in temperature sometimes being 22° to 27°. These storms usually last from two to three days and cause much discomfort. Winter rains are more frequent in southern Brazil, and violent storms prevail in August and September. At Blumenau, on the Santa Catharina coast, the annual rainfall is 53 in.

The climatic conditions of the Brazilian plateau are widely different from those of the coast in many respects. There is less uniformity in temperature, and the elevated *chapadas* are generally hotter during the day and cooler at night than are localities of the same latitude on the coast. The Brazilian Guiana plateau, lying immediately north of the equator, is in great part a hot, stony desert. Geographically it belongs to the Amazon basin, as its western and southern slopes are drained by tributaries of that great river. Climatically, however, it is a region apart. It lies in the north-east trade winds belt, but the mountain chain on its northern frontier robs these winds of their moisture and leaves the greater part of the Brazilian plateau rainless. Its eastern and western extremities, however, receive more rain, the former being well forested, while the latter is covered with grassy *campos*. South of the Amazon valley and filling a great part of the eastern projection of the continent, is another arid, semi-barren plateau, lying within the south-east trade winds belt, and extending from Piahy southward to southern Bahia. It covers the state of Piahy and the western or inland parts of the states of Ceará, Rio Grande do Norte, Parahyba, Pernambuco and Bahia. The year is divided into a dry and wet season, the first from June to December, when rain rarely falls, the streams dry up and the *campos* are burned bare, and the second from January to May when the rains are sometimes heavy and the *campos* are covered with luxuriant verdure. The rains are neither regular nor certain, however, and sometimes fall for a succession of years, causing destructive *secas* (droughts). The interior districts of Ceará, Pernambuco and Bahia have suffered severely from these *secas*. The sun temperature is high on these barren tablelands, but the nights are cool and refreshing. The prevailing winds are the south-east trades, which have lost some of their moisture in rising from the coastal plain. In summer, becoming warmed by the heated surface of the plateau, they sweep across it without a cloud or drop of rain. In winter the plateau is less heated, and cold currents of air from the west and south-west cause precipitation over a part if not all of this region. South and south-west of this arid plateau lie the inhabited tablelands of Rio de Janeiro, São Paulo and Minas Geraes, where the climate is greatly modified by a luxuriant vegetation and southerly winds, as well as by the elevation. Minas Geraes is forested along its water courses and along its southern border only; its sun temperature, therefore, is high and the rainfall in its northern districts is comparatively light. São Paulo is partly covered by open *campos*, and these also serve to augment the maximum temperature. In both of these states, however, the nights are cool, and the mean annual temperature ranges from 68° to 77°, the northern districts of Minas Geraes being much warmer than the southern. In São Paulo and southern Minas Geraes there are sometimes frosts. In the Parahyba valley, which extends across the state of Rio de Janeiro, the mean temperature is somewhat higher than it is in São Paulo and Minas Geraes, and the nights are warmer, but the higher valleys of the Serra do Mar enjoy a delightfully temperate climate. The rainfall throughout this region is abundant, except in northern Minas Geraes, where the climatic conditions are influenced to some extent by the arid eastern plateau. South of São Paulo the tablelands of Paraná, Santa Catharina and Rio Grande do Sul enjoy a temperate climate, with an abundant rainfall. There are occasional frosts, but snow is never seen. Of Goyaz and Matto Grosso very little can be said. The lower river valleys of the Tocantins-Araguaya, Xingú, Tapajós and Paraguay are essentially tropical, their climate being hot and humid like that of the Amazon. The higher valleys of the Paraná and its tributaries, and of the rivers which flow northward, are sub-tropical in character, having high sun temperatures and cool nights. Above these, the *chapadas* lie open to the sun and wind and have a cool, bracing atmosphere even where high sun temperatures prevail. The mean annual temperature at Goyaz (city), according to a limited number of observations, is about 77°. There is no absolutely dry season in this part of the great Brazilian plateau, though the year is customarily divided into a dry and wet

season, the latter running from September to April in Goyaz, and from November to April in Matto Grosso. The prevailing winds are from the north-west in this region, and westerly winds in the rainy season are usually accompanied by rain.

Fauna.—The indigenous fauna of Brazil is noteworthy not only for the variety and number of its genera and species, but also for its deficiency in the larger mammals. Of this, one of the best authorities on the subject (H. W. Bates in *The Naturalist on the River Amazons*) says: "Brazil, moreover, is throughout poor in terrestrial mammals, and the species are of small size." It is noteworthy, also, for the large number of species having arboreal habits, the density and extent of the Amazon forests favouring their development rather than the development of those of terrestrial habits. Of Quadrupeds there are about fifty species in Brazil, all arboreal, thirty-eight of which inhabit the Amazon region. They belong mostly to the *Cebidae* family, and are provided with prehensile tails. The Carnivora are represented by six species of the *Felidae*, the best known of which is the onça, or jaguar (*F. onca*, L.), and the cougar, or puma (*F. concolor*); three species of the *Canidae*, the South American wolf (*C. jubatus*), and two small jackals (*C. brasiliensis* and *C. velutius*); and a few species of the *Mustelina* including two of the otter, two *Galeotis* and one *Mephitis*. Of the plantigrades, Brazil has no bears, but has the related species of raccoon (*Nasua socialis* and *N. solitaria*), popularly called *coatis*. The opossum (*Didelphis*) is represented by three or four species, two of which are so small that they are generally called wood rats. The rodents are numerous and include several peculiar species. Only one species of hare is found in Brazil, the *Lepus brasiliensis*, and but one also of the squirrel (*Sciurus*). Of the amphibious rodents, the preá (*Cavia aperca*), mocó (*C. rupestris*), paca (*Coelogenys paca*), cutia (*Dasyprocta aguti*) and capybara (*Hydrochoerus capybara*) are noteworthy for their size and extensive range. Their flesh is used as an article of food, that of the paca being highly esteemed. Of the Muridae there are several genera and a large number of species, some of them evidently importations from the Old World. Brazil has three groups of animals similar to the common rat—the *Capromyidae*, *Loncheridae* and *Psammoryctidae*—the best known of which is the "tucu-tucu" (*Clenomys brasiliensis*), a small burrowing animal of Rio Grande do Sul which excavates long subterranean galleries and lives on roots and bulbs. One of the characteristic orders of the Brazilian fauna is that of the *Edentata*, which comprises the sloth, armadillo and ant-eater. These animals are found only in the tropical regions of South America. The range of the sloth is from the Guianas south into Minas Geraes, the armadillo as far south as the Argentine pampas and the ant-eater from the Amazon south to Paraguay, though it is found in the Amazon region principally. The sloth (*Bradypus*) is an arboreal animal which feeds almost exclusively on the foliage of the Cecropias. It includes two recognized genera and half a dozen species, the best known of which is *B. didactylus*. The common name in Brazil is *preguiça*, which is equivalent to its English name. Of armadillos, commonly called *taíra* in Brazil, the largest species is the *Dasyprocta ferox*, but the best known is the *taíra-de* (*D. octocinctus*), which is highly esteemed for its flesh. The ant-eaters (*Mormecophaga*) are divided into three or four species, one of which (*M. jubata*) is exclusively terrestrial, and the others arboreal. The popular name for the animal is *tamandua*. The *M. jubata*, or *tamandua bandeira*, is sometimes found as far south as Paraguay. Of the ruminants, Brazil has only four or five species of *Cervidae*, which are likewise common to other countries of South America. The largest of these is the marsh deer (*C. paludosus*), which in size resembles its European congeners. The others are the *C. campestris*, *C. nemorivagus*, *C. rufus* and a small species or variety called *C. nanus* by the Danish naturalist Dr P. W. Lund. The pachyderms are represented by three species of the peccary (*Dicotyles*) and two of the anta, or tapir (*Tapirus*). The former are found over a wide range of country, extending into Bolivia and Argentina, and are noted for their impetuous pugnacity. The tapir also has an extensive range between the coast and the foothills of the Andes, and from northern Argentina to south-eastern Colombia. It is the largest of the Brazilian mammals, and inhabits densely forested tracts near river courses. The two species are *T. americanus*, which is the larger and best known, and the *anta chure*, found in Minas Geraes, which is said to be identical with the *T. Roulini* of Colombia. Perhaps the most interesting mammal of Brazil is the manati, or sea-cow (*Manatus americanus*), which inhabits the lower Amazon and sometimes reaches a length of 15 to 20 ft. It is taken with the harpoon and its oil is one of the commercial products of the Amazon valley.

The avifauna of Brazil is rich in genera, species and individuals, especially in species with brilliantly-coloured plumage. It is estimated that more than half the birds of Brazil are insectivorous, and that more than one-eighth are climbers. The range in size is a wide one—from the tiny humming-bird to the ema, rhea, or American ostrich. Although the order which includes song-birds is numerous in species and individuals, it is noticeably poor in really good songsters. On the other hand it is exceptionally rich in species having strident voices and peculiar unmusical calls, like the *paracá* (*Caracina scutata*) and the *araponga* (*Chasmorhynchus nudicollis*). Two species of vultures, twenty-three of falcons and eight of owls represent the birds of prey. The best known vulture is the common *urubú* (*Cathartes fectens*, Illig), which is the universal scavenger of the

tropics. The climbers comprise a large number of species, some of which, like those of the parrot (*Psittacidae*) and woodpecker (*Picus*), are particularly noticeable in every wooded region of the country. One of the most striking species of the former is the brilliantly coloured *arara* (*Macrocerus*, L.), which is common throughout northern Brazil. Another interesting species is the toucan (*Ramphastus*), whose enormous beak, awkward flight and raucous voice make it a conspicuous object in the great forests of northern Brazil. In strong contrast to the ungainly toucan is the tiny humming-bird, whose beautiful plumage, swiftness of flight and power of wing are sources of constant wonder and admiration. Of its smallest of birds there are fifty-nine well-known species, divided into two groups, the *Phaethorninae*, which prefer the forest shade and live on insects, and the *Trochilinae*, which frequent open sunny places where flowers are to be found. One of the Brazilian birds whose habits have attracted much interest is the *João de Barro* (Clay John) or oven bird (*Furnarius rufus*), which builds a house of reddish clay for its nest and attaches it to the branch of a tree, usually in a fork. The thrush is represented by a number of species, one of which, the *sabid* (*Mimus*), has become the popular song-bird of Brazil through a poem written by Gonçalves Dias. The dove and pigeon have also a number of native species, one of which, the *pomba jurity* (*Peristera frontalis*), is a highly-appreciated table luxury. The gallinaceous birds are well represented, especially in game birds. The most numerous of these are the *perdia* (partridge), the best known of which is the *Tinamus maculosa* which frequents the *campos* of the south, the *inhambú* (*Crypturus*), *capoeira* (*Odonophorus*), and several species of the penelope family popularly known as the *jacutinga*, *jacú* and *jacú-assú*. The common domesticated fowl is not indigenous. Among the wading and running birds, of which the *ema* is the largest representative, there are many species of both descriptions. In the Amazon lowlands are white herons (*Ardea candidissima*), egrets (*A. egretta*), bitterns (*A. exilis*), blue herons (*A. herodias*), scarlet ibises (*Ibis rubra*), roseate spoonbills (*Platalea ajaja*); on higher ground the beautiful peacock heron (*A. helias*) which is easily domesticated; and on the dry elevated *campos* the *ceriema* (*Dicholophus cristatus*) which is prized for its flesh, and the *jacumim* (*Psophia crepitans*) which is frequently domesticated. Prominent among the storks is the great black-headed white crane, called the *jabará* (*Mycteria americana*), which is found along the Amazon and down the coast and grows to a height of 43 ft. Of the swimmers, the number of species is smaller, but some of them are widely distributed and numerous in individuals. There are but few species of ducks, and they are apparently more numerous in southern Brazil than on the Amazon.

The reptilian fauna exhibits an exceptionally large number of interesting genera and species. A great part of the river systems of the country with their flooded areas are highly favourable to the development of reptilian life. Most prominent among these is the American alligator, of which there are, according to Netterer, two genera and eight species in Brazil. They are very numerous in the Amazon and its tributaries and in the Paraguay, and are found in all the rivers of the Atlantic coast. Three of the Brazilian species are voracious and dangerous. The largest of the Amazon species are the *jacaré-assú* (*Caiman niger*), *jacaré* (*C. fissipes*) and *jacaré-tinga* (*C. sclerops*). The Amazon is also the home of one of the largest fresh-water turtles known, the *Emys amazonica*, locally called the *jurard-assú* or *tartaruga grande*. These turtles are so numerous that their flesh and eggs have long been a principal food supply for the Indian population of that region. Another Amazon species, the *E. traxaca*, is still more highly esteemed for its flesh, but it is smaller and deposits fewer eggs in the sandy river beaches. Lagartos (*Iguanas*) and lizards are common everywhere. The ophidians are also numerous, especially in the wooded lowlands valleys, and the poisonous species, though less numerous than others, include some of the most dangerous known—the rattlesnake *suruacú* (*Lachesis rhombatus*), and *jararaca* (*Bothrops*). The Amazon region is frequented by the *gibria* (boa constrictor), and the central plateau by the *sucuriú* (*Euneocles murinus*), both distinguished for their enormous size. The batrachians include a very large number of genera and species, especially in the Amazon valley.

The fauna of the rivers and coast of Brazil is richer in species and individuals than that of the land. All the rivers are richly stocked, and valuable fishing grounds are to be found along the coast, especially that of southern Bahia and Espirito Santo where the *garoupa* (*Serranus*) is found in large numbers. Some of the small fish along the coast are highly esteemed for their flavour. Whales were once numerous between Capes St Roque and Frio, but are now rarely seen. Of the edible river fish, the best known is the *pirarucú* (*Sudis gigas*), a large fish of the Amazon which is salted and dried for market during the low-water season. Fish is a staple food of the Indian tribes of the Amazon region, and their fishing season is during the period of low water. The visit of Professor Louis Agassiz to the Amazon in 1865 resulted in a list of 1143 species, but it is believed that no less than 1800 to 2000 species are to be found in that great river and its tributaries.

In strong contrast to the poverty of Brazil in the larger mammals is the astonishing profusion of insect life in every part of the country. The Coleoptera and Lepidoptera are especially numerous, both in species and individuals. A striking illustration of this extraordinary

profusion was given by the English naturalist H. W. Bates, who found 7000 species of insects in the vicinity of only one of his collecting places on the Amazon (Ega), of which 550 species were of butterflies. Within an hour's walk of Pará are to be found, he says, about 700 species of butterflies, "whilst the total number found in the British Islands does not exceed 66, and the whole of Europe supports only 321." (H. W. Bates, *The Naturalist on the River Amazon*.) One of the rare species of the Amazon *Morphos* (*M. hecuba*) measures 8 to 9 in. across its expanded wings. Dipterous insects are also very numerous in species, especially in those of sanguinary habits, such as the mosquito, *piim*, *maroin*, *carapassá*, *borochado*, &c. In some places these insects constitute a veritable plague, and the infested regions are practically uninhabitable. The related species of the *Oestridae* family, which include the widely disseminated *chique* or *bicho do pé* (*Pulex penetrans*), and the equally troublesome *how* (*Cutilebra nazialis*), which is so injurious to animals, are equally numerous. The most numerous of all, however, and perhaps the most harmful to civilized man, are the termites and ants, which are found everywhere in the uninhabited *campo* and forest regions, as well as in the cultivated districts. Nature has provided several species of animals, birds and reptiles, to feed upon these insects, and various poisonous and suffocating compounds are used to destroy them, but with no great degree of success. It is not uncommon to find once cultivated fields abandoned because of their ravages and to see large *campos* completely covered with enormous ant-hills. The termites, or "white ants," are exceptionally destructive because of their habit of tunnelling through the softer woods of habitations and furniture, while some species of ants, like the *saúba*, are equally destructive to plantations because of the rapidity with which they strip a tree of its foliage. Spiders are represented by a very large number of species, some of which are beautifully coloured. The largest of these is the *Mygale* with a body 2 in. in length and outstretched legs covering 7 in., a monster strong enough to capture and kill small birds. A large *Mygale* found on the island of Siriba, of the Abrohlo group, feeds upon lizards, and has been known to attack and kill young chickens. One of the most troublesome pests of the interior is a minute degenerate spider of the genus *Loxos*, called *carraço*, or bush-tick, which breeds on the ground and then creeps up the grass blades and bushes where it waits for some passing man or beast. Its habit is to bury its head in its victim's skin and remain there until gorged with blood, when it drops off. Scorpions are common, but are considered less poisonous than some European species.

Flora.—Brazil not only is marvellously rich in botanical species, but included at the beginning of the 20th century the largest area of virgin forest on the surface of the earth. The flora falls naturally into three great divisions: that of the Amazon basin where exceptional conditions of heat and moisture prevail; that of the coast where heat, varying rainfall, oceanic influences and changing seasons have greatly modified the general character of the vegetation; and that of the elevated interior, or *sertão*, where drier conditions, rocky surfaces, higher sun temperatures and large open spaces produce a vegetation widely different from those of the other two regions. Besides these, the flora of the Paraguay basin varies widely from that of the inland plateau, and that of the Brazilian Guiana region is essentially distinct from the Amazon. The latter region is densely forested from the Atlantic to the Andes, but with a varying width of about 200 m. on the coast to about 900 m. between the Bolivian and Venezuelan *Uanos*, and thus far civilization has made only a very slight impression upon it. Even where settlements have been located, constant effort is required to keep the vegetation down. Along the coast, much of the virgin forest has been cut away, not only for the creation of cultivated plantations, but to meet the commercial demand for Brazil-wood and furniture woods.

The chief characteristic of the Amazonian forest, aside from its magnitude, is the great diversity of genera and species. In the northern temperate zone we find forests of a single species, others of three or four species; in this great tropical forest the habit of growth is solitary and an acre of ground will contain hundreds of species—palms, myrtles, acacias, mimosa, cecropias, euphorbia, malvaceae, laurals, cedrelas, bigonias, bombaceae, apocynaceae, malpias, lycythides, swartzias, &c. The vegetation of the low river-margins, which are periodically flooded, differs in some particulars from that of the higher ground, and the same variation is to be found between the forests of the upper and lower Amazon, and between the Amazon and its principal tributaries. The density of the forest is greatly augmented by the *cipós*, or lianas, which overgrow the largest trees to their tops, and by a profusion of epiphytes which cover the highest branches. As a rule the trees of the Amazon forest are not conspicuously high, a few species rarely reaching a height of 300 ft. The average is probably less than one-half that height. This is especially true of the flood plains where the annual inundations prevent the formation of humus and retard forest growth. The largest of the Amazon forest trees are the *massaranduba* (*Mimosa sciapida*), called the cow-tree because of its milky sap, the *samouira* (*Eriodendron samouira*) or silk-cotton tree, the *pinu d' arco* (*Tecoma speciosa*), *pinu d' alho* (*Catropa lapia*), *bacuri* (*Symphlocos coccinea*), *sapucaia* (*Lecythis ollaria*), and *castanhaeira* or Brazil-nut tree (*Bertholletia excelsa*). The Amazon region has a comparatively narrow

fringe on the Atlantic. In Maranhão, which belongs to the coast region, open spaces or *campos* appear, though the state is well wooded and its forests have the general characteristics of the lower Amazon. South-east of the Parnahyba the coast region becomes dryer and more sandy and the forests disappear. The coast and tide-water rivers are fringed with mangrove, and the sandy plain reaching back to the margin of the inland plateau is generally bare of vegetation, though the carnahuba palm (*Copernicia cerifera*) and some species of low-growing trees are to be found in many places. The higher levels of this plain are covered with shrubs and small trees, principally mimosas. The slopes of the plateau, which receive a better rainfall, are more heavily forested, some districts being covered with deciduous trees, forming *catingas* in local parlance. This dry, thinly-wooded region extends south to the states of Parahyba, where a more regular rainfall favours forest growth nearer the coast. Between Parahyba and southern Bahia forests and open plains are intermingled; thence southward the narrow coastal plain and bordering mountain slopes are heavily forested. The sea-coast bays and tide-water rivers are still fringed with mangrove, and on the sandy shores above Cape Frio grow large numbers of the exotic cocoa-nut palm. Many species of indigenous palms abound, and in places the forests are indescribably luxuriant. These are made up, as Prince Max zu Neuwied found in southern Bahia in 1817, "of the genera *Coccoloba*, *Melastoma*, *Bignonia*, *Rhexia*, *Mimosa*, *Inga*, *Bombax*, *Ilex*, *Laurus*, *Myrtus*, *Eugenia*, *Jacarandá*, *Jatropha*, *Vernonia*, *Lecythis*, *Ficus*, and a thousand other, for the most part, unknown species of trees." Further inland the higher country becomes more open and the forests are less luxuriant. Giant cacti and spiny scrub abound. Then come the *catingas* tracts, and, beyond these, the open *campos* of the elevated plateau, dotted with clumps of low growing bushes and broken by tracts of *carraço*, a thick, matted, bushy growth 10 to 12 ft. in height. Formerly this coast region furnished large quantities of Brazil-wood (*Caesalpinia echinata*), and the river valleys have long been the principal source of Brazil's best cabinet-wood—rosewood (*Dalbergia nigra*), jacarandá (*Machaerium firmum*, Benth.), vinhatico (*Plathymenia foliosa*, Benth.), peroba (*Aspidosperma peroba*), cedro, &c. The exotic mangabeira (mango) is found everywhere along the coast, together with the bamboo, orange, lemon, banana, cashew, &c.

Of the great inland region, which includes the arid *campos* of the north, the partially-wooded plateaus of Minas Geraes, Goyaz and Matto Grosso, the temperate highlands of the south, and the tropical lowlands of the Paraguay basin, no adequate description can be given without taking each section in detail, which can be done to better advantage in describing the individual states. In general, the *carraço* growth extends over the whole central plateau, and heavy forests are found only in the deep river valleys. Those opening northward have the characteristic flora of the Amazon basin. The Paraguay basin is covered with extensive marshy tracts and open woodlands, the palms being the conspicuous feature. The vegetation is similar to that of Paraguay and the Chaco, and aquatic plants are specially numerous and luxuriant. On the temperate uplands of the southern states there are imposing forests of South American pine (*Araucaria brasiliensis*), whose bare trunks and umbrella-like tops give to them the appearance of open woodland. These forests extend from Paraná into Rio Grande do Sul and smaller tracts are also found in Minas Geraes. Large tracts of *Ilex paraguayensis*, from which *maté*, or Paraguay-tea, is gathered, are found in this same region.

The economic plants of Brazil, both indigenous and exotic, are noticeably numerous. Coffee naturally occupies first place, and is grown wherever frosts are not severe from the Amazon south to Paraná. The states of São Paulo, Rio de Janeiro and Minas Geraes are the largest producers, but it is also grown for export in Espírito Santo, Bahia and Ceará. The export in 1905 was 10,820,604 bags of 132 lb each, with an official valuation of £21,420,330. Sugar cane, another exotic, has an equally wide distribution, and cotton is grown along the coast from Maranhão to São Paulo. Other economic plants and fruits having a wide distribution are tobacco, maize, rice, beans, sweet potatoes, bananas, cacao (*Theobroma cacao*), mandioca or cassava (*Manihot utilissima*), *ajipim* or sweet mandiocca (*M. aipi*), guavas (*Psidium guajava*, Raddi), oranges, lemons, limes, grapes, pineapples, *mandão* (*Carica papaya*), bread-fruit (*Artocarpus incisa*), jack fruit (*A. integrifolia*), and many others less known outside the tropics. Among the palms there are several of great economic value, not only as food producers but also for various domestic uses. The fruit of the *pupunha* or peach palm (*Guilielma speciosa*) is an important food among the Indians of the Amazon valley, where the tree was cultivated by them long before the discovery of America. Humboldt found it among the native tribes of the Orinoco valley, where it is called *pirijao*. The ita palm, *Mauritia flexuosa* (a fan-leaf palm) provides an edible fruit, medullary meal, drink, fibre, roofing and timber, but is less used on the Amazon than it is on the lower Orinoco. The *assai* (*Euterpe oleracea*) is another highly-prized palm because of a beverage made from its fruit along the lower Amazon. A closely-related species or variety (*Euterpe edulis*) is the well-known palmito or cabbage palm found over the greater part of Brazil, whose terminal phylophore is cooked and eaten as a vegetable. Another highly useful palm is the *carnahuba* or *carnahuba* (*Copernicia cerifera*) which supplies fruit, medullary meal, food for

cattle, boards and timber, fibre, wax and medicine. The fibre of the *piassava* (*Leopoldinia piassava*, or *Atalea fawifera*) is widely used for cordage, brushes and brooms. There are many other palms whose fruit, fibre and wood enter largely into the domestic economy of the natives, but the list given shows how important a service these trees rendered to the aboriginal inhabitants of tropical America, and likewise how useful they still are to the people of tropical Brazil. Another vegetable product of the Amazon region is made from the fruit of the *Paulinia sorbilis*, Mart., and is known by the name of *guaraná*. It is largely consumed in Bolivia and Matto Grosso, where it is used in the preparation of a beverage which has excellent medicinal properties. The Brazilian flora is also rich in medicinal and aromatic plants, dye-woods, and a wide range of gum and resin-producing shrubs and trees. The best known of these are saraparrilla, ipecacuanhá, cinchona, jaborandi and copaiba; vanilla, tonka beans and cloves; Brazil-wood and anatto (*Bixa orellana*); india-rubber and balata. India-rubber is derived principally from the *Elaeis guayanaensis*, sometimes called the *Siphonia elastica*, which is found on the Amazon and its tributaries as far inland as the foothills of the Andes. Other rubber-producing trees are the *manicoba* (*Jatropha Glaziovii*) of Ceará, and the *mangabeira* (*Hancornia speciosa*), of the central upland regions.

Population.—The first explorers of Brazil reported a numerous Indian population, but, as the sea-coast afforded a larger and more easily acquired food supply than did the interior, the Indian population was probably numerous only in a comparatively small part of this immense territory, along the sea-coast. Modern explorations have shown that the unsettled inland regions of Brazil are populated by Indians only where the conditions are favourable. They are to be found in wooded districts near rivers, and are rarely found on the elevated *campos*. The immediate result of European colonization was the enslavement and extermination of the Indians along the coast and in all those favoured inland localities where the whites came into contact with them. The southern districts and the Amazon and its tributaries were often raided by slave-hunting expeditions, and their Indian populations were either decimated, or driven farther into the inaccessible forests. But there is no record that the inland districts of western and north-western Brazil were treated in this manner, and their present population may be assumed to represent approximately what it was when the Europeans first came. According to the census of 1890 the Indian population was 1,295,796, but so far as the migratory tribes are concerned the figures are only guesswork. A considerable number of these Indians have been gathered together in *aldeas* under the charge of government tutors, but the larger part still live in their own villages or as nomads.

Down to the beginning of the 19th century the white colonists were almost exclusively Portuguese. The immigration from countries other than Portugal during the first half of that century was small, but before its close it increased rapidly, particularly from Italy. Fully nine-tenths of these immigrants, including those from the mother country, were of the Latin race. The introduction of African slaves followed closely upon the development of agricultural industries, and continued nominally until 1850, actually until 1854, and according to some authors until 1860. About 1826 it was estimated that the negro population numbered 2,500,000 or three times the white population of that period. The unrestricted intermixture of these three races forms the principal basis of the Brazilian population at the beginning of the 20th century. Brazil has never had a "colour line," and there has never been any popular prejudice against race mixtures. According to the census of 1872 the total population was 9,930,478, of which 1,510,806 were slaves; the race enumeration gave 3,787,280 whites, 1,959,452 Africans, 386,955 Indians, and 3,801,782 mixed bloods. The Indian population certainly exceeded the total given, and the white population must have included many of mixed blood, the habit of so describing themselves being common among the better classes of South American mestizos. The census of 1890 increased the total population to 14,333,915, which, according to an unofficial analysis (*Statesman's Year Book*, 1905), was made up of 6,302,198 whites, 4,638,495 mixed bloods, 2,097,426 Africans, and 1,295,796 Indians. This analysis, if correct, indicates that the vegetative increase of the whites has been greater than that of the Africans and mixed races. This is not the conclusion of many observers,

but it may be due to the excessive infant mortality among the lower classes, where an observance of the simplest sanitary laws is practically unknown. The census of the 31st of December 1900 was strikingly defective; it was wholly discarded for the city of Rio de Janeiro, and had to be completed by office computations in the returns from several states. The compilation of the returns was not completed and published until May 1908, according to which the total population was 17,318,556, of which 8,825,636 were males and 8,492,920 females. Not including the city of Rio de Janeiro, whose population was estimated at 691,565 in conformity with a special municipal census of 1906, the total population was 16,626,991, of which 15,572,671 were Roman Catholics, 177,727 Protestants, 876,593 of other faiths. The returns also show a total of 3,038,500 domiciles outside the federal capital, which gives an average of 5.472 to the domicile. These returns will serve to correct the exaggerated estimate of 22,315,000 for 1900 which was published in Brazil and accepted by many foreign publications.

The racial character of the people is not uniform throughout the republic, the whites predominating in the southern states, the Indians in Amazonas and, probably, Matto Grosso, and the mixed races in the central and northern coast states. The excess of whites over the coloured races in the southern states is due to their smaller slave population and to the large number of immigrants attracted to them. Slavery was not abolished until the 13th of May 1888, but a number of successful colonies had already been founded in these states. Other colonies were founded in Bahia, Espírito Santo and Rio de Janeiro during the same period, but they were unsuccessful, partly because of the competition of slave labour. Since the abolition of slavery immigration has poured a large number of labourers into the coffee-producing states, and with beneficial results. This strengthening of the white population of the South with fresh European blood must eventually divide Brazil into two distinct sections: the white states of the south; and the mixed or coloured states of the north. The introduction of European immigrants dates from 1818 when a Swiss colony was located at Nova Friburgo, near Rio de Janeiro, and it was continued under the direction and with the aid of the imperial government down to the creation of the republic. Since then the state governments have assumed charge of immigration, and some of them are spending large sums in the acquisition of labourers. The old system of locating immigrants in colonies, or colonial nuclei, which involved an enormous outlay of money with but slight benefit to the country, has been superseded by a system of locating the immigrants on the large plantations under formal contracts. In some of the coffee districts these contracts have resulted very profitably to the Italian labourers. The total number of colonists and immigrants entering Brazil between 1804 and 1902, inclusive, according to official returns, was 2,208,353. The arrivals fluctuate greatly in number from year to year, influenced by the prevailing economic conditions in the country. At first the Portuguese outnumbered all other nationalities in the immigration returns, but since the abolition of slavery the Italians have passed all competitors and number more than one-half the total arrivals. Of the 700,211 immigrants located in the state of São Paulo from 1827 to the end of 1896, no less than 493,535 were Italians, and their aggregate throughout the republic was estimated in 1906 at more than 1,100,000. The German

immigration, of which so much has been written for political ends, has been greatly over-estimated; trustworthy estimates in 1906 made the German contingent in the population vary from 350,000 to 500,000. They are settled chiefly in colonies in the southern states, and form a most desirable body of settlers.

Divisions and Towns.—The republic is divided into twenty states and one federal district, which are the same as the provinces and "município neutro" of the empire. Their names also remain unchanged, except that of the federalized district in which the national capital is located, which is called the "distrito federal." The republic has no territories, although Amazonas, Matto Grosso, Pará and Goyaz cover an immense region of uninhabited and only partially explored territory. The states are subdivided into *comarcas*, or judicial districts, and into *municípios*, or townships, which is the smallest autonomous division. The constitution provides for the autonomy of the municipalities in order to safeguard the permanence of representative institutions. The *paróquia*, or parish, an ecclesiastical division, is often used for administrative purposes, but it has no political organization. The names, areas, and populations of the states, together with the names and populations of their capitals, are as follows:—

States.	Area, ¹ Sq. miles.	Population ²		State Capitals.	Population, ³ Census 1890.
		Census 1890.	Census 1906.		
Alagoas	22,584	511,440	649,273	Maceió	31,498
Amazonas	742,123	147,915	249,756	Manaus	38,720
Bahia	164,650	1,919,802	2,117,956	São Salvador ⁴	174,412
Ceará	40,253	805,887	849,127	Fortaleza	40,902
Espírito Santo	17,313	135,997	209,783	Victoria	16,887
Federal District	538	522,651	691,565	Rio de Janeiro	522,651
Goyaz	288,549	227,572	255,284	Goyaz ⁵	17,181
Maranhão	177,569	439,854	499,308	S. Luiz do Maranhão ⁴	29,308
Matto Grosso	532,370	92,827	118,025	Cuyaba	17,815
Minas Geraes	221,961	3,184,099	3,594,471	Ouro Preto ⁶	59,249
Pará	443,922	328,455	445,356	Belem	50,064
Parahyba	28,853	457,232	499,784	Parahyba	18,645
Paraná	85,455	249,491	327,136	Curitiba	24,353
Pernambuco	49,575	1,030,224	1,178,150	Recife ⁴	111,556
Piauí	116,529	27,609	334,328	Therézina	31,523
Rio de Janeiro	26,635	276,184	334,317	Nitcheiroa	34,269
Rio Grande do Norte	22,196	268,273	1,149,070	Natal	13,725
Rio Grande do Sul	91,337	897,455	926,635	Porto Alegre	52,421
Santa Catharina	28,633	283,769	320,289	Desterro ⁷	30,687
São Paulo	112,312	1,384,753	2,282,279	São Paulo	64,934
Sergipe	15,093	319,626	356,264	Aracajú	16,336
Brazil	3,228,452	14,333,915	17,318,556		

immigration, of which so much has been written for political ends, has been greatly over-estimated; trustworthy estimates in 1906 made the German contingent in the population vary from 350,000 to 500,000. They are settled chiefly in colonies in the southern states, and form a most desirable body of settlers.

Communications.—Railway construction in Brazil dates from 1852, when work was initiated on the Mauá railway running from the head of the bay of Rio de Janeiro to the foot of the Serra where Petropolis is situated. The road is 10 m. long, and its first section was opened to traffic on April 30, 1854, and its second December 16, 1856. The mountain section, 51 m. long, which uses the Rigngenbach system from the terminal to Petropolis, was constructed between 1881 and 1883. The development of railway construction in Brazil has been impeded to a great extent by two unfavourable conditions—by the chain of mountains or plateau escarpments which follow the coast line and obstruct communication with the interior, and by the detached positions of the settlements along the Atlantic, which com-

¹ The areas are reduced from the planimetric calculations made at Gotha and used by A. Supan in *Die Bevölkerung der Erde* (1904). They are corrected to cover all boundary changes to 1906.

² The census of 1890 is the last one of which complete returns are published. That of 1900 was notoriously inaccurate in many instances.

³ The census returns are for municipalities, and not for cities proper. As a municipality covers a large extent of country, the population given is larger than that of the urban parishes, and is therefore not strictly correct according to European practice.

⁴ The Brazilian official titles are given for the state capitals: Belem for Pará; São Luiz for Maranhão; São Salvador for Bahia; and Recife for Pernambuco.

⁵ The capital of Minas Geraes in 1890 was Ouro Preto; it has since been transferred to Belo Horizonte, or Cidade de Minas, which has an estimated population of 25,000.

⁶ Since the naval revolt of 1893-1894 the name of the capital of Santa Catharina has been changed from Desterro to Florianópolis in honour of President Floriano Peixoto.

the building of lines from many widely separated points on the coast into a sparsely populated hinterland. A majority of the ports, from which these roads are built, are small and difficult of access, and the coasting trade is restricted to vessels carrying the Brazilian flag. The only ports having a rich and well-populated country behind them are Rio de Janeiro and Santos, and these are the terminals of long lines of railway which are being slowly extended farther into the interior.

The total mileage under traffic at the beginning of 1905 was 10,600 m., divided into 94 separate lines. There were also 745 m. under construction, 1740 m. under survey, and about 1600 m. projected. Of the 94 lines under traffic, 45 were operating by virtue of national and 49 by provincial and state concessions. They were grouped in the official reports of 1905 as follows:—

Government lines (21):—	Miles.	
Administered by the state (6)	2228	
Leased to private parties (15)	2174	4402
Private lines (24)—		
With national interest guarantees (12)	1290	
Without such guarantees (12)	815	2105
Private and state lines operated by virtue of state concessions, with and without interest guarantees (49)		4093
		10,600

The policy of the national government has been gradually to lease all its lines except the Estrada de Ferro Central do Brazil, which is retained for sentimental reasons. This great railway runs from the city of Rio de Janeiro westward to the city of São Paulo and northward into the interior of Minas Geraes, with a total length at the beginning of 1905 of 1002 m., and an extension of about 104 m. to Pirapora, on the São Francisco river. It was formerly known as the "E. de F. Dom Pedro II.," in honour of the sovereign who encouraged its construction. The main line has a gauge of 63 in. (1-60 m.) and affords an outlet for a number of inland metre-gauge lines. The first two sections of this great railway, which carry it across the coast range, were opened to traffic in 1858 and 1864. The series of trunk lines terminating at the port of Santos are owned by private companies and are formed by the São Paulo, Paulista and Mogiana lines, the first owned by an English company, and the other two by Brazilian companies. The Mogiana carries the system entirely across the state of São Paulo into the western districts of Minas Geraes. The principal trunk lines (the São Paulo and Paulista) have a broad gauge, while their extensions and feeders have a narrow gauge. The comparatively short lines extending inland from the ports of São Salvador (Bahia), Pernambuco, Maceió, Victoria and Paranaguá serve only a narrow zone along the coast. To encourage the investment of private capital in the construction of railways, the general railway law of 1853 authorized the national government to grant guarantees of interest on the capital invested. Under this law companies were organized in England for building the São Paulo railway, and the lines running from Bahia and Pernambuco toward the São Francisco river. Political considerations also led to the construction of similar lines in the states of Rio Grande do Norte, Parahyba, Alagoas, Sergipe, Espirito Santo, Paraná, Santa Catharina and Rio Grande do Sul. The result was that the national treasury became burdened with a heavy annual interest charge, payable abroad in gold, which did not tend to diminish, and had a long period to run before the expiration of the contracts. The government finally determined to take over these guaranteed lines from the foreign companies owning them, and a statement issued in October 1902 showed that 1335 m. had been acquired at a cost of 114,605,000 in bonds, the interest on which is £84,200 a year against an aggregate of \$31,750 in interest guarantees which the government had been paying. In addition to this economy it was calculated that the lines could be leased for £132,000 a year. The loan finally issued in London to cover the purchase of these railways aggregated £16,619,320. All but three of these lines had been leased in 1905.

The use of tramways for the transportation of passengers in cities dates from 1868, when the first section of the Botanical Garden line of Rio de Janeiro was opened to traffic. The line was completed with its surplus earnings and continued under the control of the American company which built it until 1882, when it was sold to a Brazilian company. Subsequently the tramways of the city have been mostly concentrated in the hands of a single Canadian company. All the large cities of Brazil are liberally provided with tramways, those of the city of São Paulo, where electric traction is used, being noticeably good. The substitution of electricity for animal traction was begun in São Salvador in 1906. Mules are universally employed for animal traction, and narrow gauge lines with single-mule trams are generally used where the traffic is light.

Brazil is lamentably deficient in steamship communication considering its importance in a country where the centres of population are separated by such distances of coasts and river. Previous to the creation of the republic, the coastwise service was performed

by two national companies (now united), and partially by foreign lines calling at two or more ports. A considerable number of foreign sailing vessels also carried on an important coasting trade. The coastwise service centres at Rio de Janeiro, from which port the Lloyd Brasileiro sends steamers regularly south to Montevideo, and north to Pará and Manaus, calling at the more important intermediate ports. From Montevideo river steamers are sent up the Paraná and Paraguay rivers to Corumbá and Cuyabá, in the state of Matto Grosso. The company receives a heavy subsidy from the national government. Parts of this coastwise traffic are covered by other companies, two of which receive subsidies. There were also six lines of river steamers receiving subsidies from the national government in 1904, and the aggregate paid to these and the coastwise lines was 2,830,061 milreis. The largest of the river lines is the Amazon Steam Navigation Co. (an English corporation), whose service covers the main river and several of its principal tributaries. Two subsidized companies maintain services on the São Francisco river—one below the Paulo Afonso falls, and the other above, the latter covering 854 m. of navigable channel between Joazeiro and Pirapora. Besides these there are other companies engaged in the coasting and river traffic, either with subsidies from the state governments, as feeders for railway lines, or as private unsubsidized undertakings.

The telegraph lines, which date from 1852, are owned and operated by the national government, with the exception of the lines constructed by private railway companies, and the cable lines of the Amazon and the coast. The government lines extend from Pará to the Argentine and Uruguayan frontiers, where they connect with the telegraph systems of those republics, and from Rio de Janeiro westward across country, in great part unsettled, to the capitals of Goyas and Matto Grosso. At Pará connexion is made with the cable laid in the bed of the Amazon to Manaus, which is owned and operated by a subsidized English company. At Vizeu, Pará, connexion is made with a French cable to the West Indies and the United States, and at Pernambuco with two cable lines to Europe. A coastwise cable runs from Pará to Montevideo with double cables between Pernambuco and Montevideo. There were in 1903 a total of 15,150 m. of land lines, with 29,310 m. of wire and 1102 telegraph offices. The government maintains reciprocal rates with most of the private railway lines.

The Brazilian postal service is under the general supervision of the minister of communications and public works, and is administered by a director-general. Owing to the size of the country and the sparsely-populated state of a large part of the interior, the transportation of the mails is attended with much difficulty and expense. Although the postal rates are high, the service is not self-sustaining, the receipts for 1904 being 7,018,344 milreis, against a total expenditure of 10,099,545 milreis. There were 2847 post offices (*agencias*), of which 2166 were of the 4th or lowest grade. Brazil is a member of the Postal Union, and like Argentina exacts higher nominal rates of postage upon outgoing mail than those agreed upon to cover the depreciation in her own currency. The letter rate was at first 200 reis (nearly 5½d.), but it has been increased to 300 reis, which is equivalent to 8d. at par and 4½d. at 15d. exchange. An inland parcel post was in operation long before the overthrow of the monarchy, and a similar service with Portugal has been successfully maintained for a number of years, notwithstanding the difficulties interposed by customs regulations. National and international money order systems are also in operation.

The constitution of Brazil provides that the coastwise trade shall be carried on by national vessels, but this provision did not go into effect until 1896. And even then, because of the insufficient number of Brazilian vessels it was provided in the regulations that foreign vessels could be enrolled in that trade by using the Brazilian flag and employing a certain proportion of Brazilians on the crew. One of the purposes of this restrictive provision was that of creating a national merchant marine, but the disinclination of Brazilians for maritime pursuits has been a serious obstacle to its realization. In 1901 the merchant navy included 228 steamers of 91,465 tons net, and 343 sailing vessels of 76,992 tons net. These vessels are all engaged in the coasting and river trade of the country. Efforts have been made, however, to engage in foreign trade, and subsidies were offered for a passenger and freight service to the United States. On the 23rd of February 1906 the government completed a new contract with the Lloyd Brasileiro Company for its coastwise and river service, and included clauses providing for a line to the United States. This foreign service (monthly) began in August 1906.

Although the coast of Brazil shows a large number of bays and tide-water river channels which are apparently suitable for commercial ports, a close examination of them reduces the number of good ports to less than a dozen. The others are either difficult of access, or are rendered practically useless by dangerous reefs, sand bars and shoals. Important improvements have been undertaken in some of these ports. Those at Santos and Manaus, for example, have produced good results. In many cases, as at Rio de Janeiro, Santos and Manaus, the cost and maintenance of the new port-works are met by an additional tax on merchandise, though the immediate expenditures are met by advances from the national treasury, and at Rio de Janeiro by a foreign loan.

Commerce.—The imports, exports and domestic trade of Brazil

are by reason of their magnitude and peculiar character the most important in South America, though the *per capita* aggregate is less than that of Argentina. Although an agricultural country, Brazil does not produce all its own bread and meat, and the imports of wheat, wheat flour, rice, fish, jerked beef and preserved meats, lard, butter, beans, potatoes, packed fruits and vegetables, Indian corn and other food-stuffs, are surprisingly large. Since the creation of the republic, extreme protective measures have caused the creation of a large number of cotton factories and other manufactures, but these are able to supply only a part of the consumption, and the importation of cotton and woollen fabrics, silks, ready-made clothing, boots and shoes, &c., is large. Modern industrial development in some of the states has greatly increased the importation of machinery, electric supplies, materials for construction, coal, &c. Kerosene oil also figures among the principal imports, and beef cattle are imported for consumption by some cities. The exports cover a wide range of agricultural, pastoral and natural productions, including coffee, rubber, sugar, cotton, cocoa, Brazil nuts, maté (Paraguay tea), hides, skins, fruits, gold, diamonds, manganese ore, cabinet woods and medicinal leaves, roots and resins. Coffee and rubber, however, represent from 80 to 90% of the official valuation of all exports. High import duties are imposed by the national government and export duties by the states. The exchange of domestic products between the states is greatly restricted through lack of cheap transportation facilities, and by the suicidal imposition of import and export duties by the states, either for revenue or for the protection of home industries.

According to a summary for the six years 1901 to 1906, derived from official sources and published in the annual *Retrospecto de the Jornal do Comercio*, of Rio de Janeiro, the values of the imports and exports for those years (exclusive of coin), reduced to pounds sterling at the average rate of exchange (or value of one milreis) for each year, were as follows:—

Year.	Average Value of the Milreis in Pence.	Imports in Pounds Ster.	Exports in Pounds Ster.
		£.	£.
1901	11.33	21,377,270	40,621,993
1902	11.93	23,879,418	36,437,456
1903	11.99	24,207,811	36,883,175
1904	12.22	25,915,423	39,430,136
1905	15.94	29,830,050	44,643,113
1906	16.17	33,204,041	53,959,480

Nearly 76% of the exports of 1906 were of coffee and rubber, the official valuations of these being: coffee 245,474,525 milreis gold (£27,615,884), and rubber (including mangoba and mangabeira), 124,941,433 milreis gold (£14,058,911).

Brazil is essentially an agricultural country. No other country has been able to equal Brazil in the production of coffee, and under better labour conditions the country might compete with the foremost in the production of cane sugar, cotton and tobacco. Besides these it might easily excel in producing many of the tropical fruits for which there is a commercial demand. During the colonial period sugar cane was cultivated from Parahyba S. to the vicinity of Santos, and sugar was the principal export of the colony. Before the middle of the 19th century coffee became one of the leading exports, and its cultivation in the states of São Paulo, Rio de Janeiro and Minas Geraes has been so increased since that time that it represents over four-fifths in value of the total export of agricultural produce. The principal sugar-producing states are Alagoas, Sergipe, Pernambuco, Bahia and Rio de Janeiro, and the production is between 200,000 and 300,000 tons, the greater part of which is consumed in the country. Cotton has been widely cultivated since early colonial days, principally in the northern Atlantic states. Tobacco is also widely cultivated, and the product of some states, such as Bahia, Minas Geraes and Goyas, has a high local reputation for its excellence. Cacau (cocoa) is cultivated extensively in the Amazon Valley and along the coast as far south as southern Bahia, and forms one of the leading exports. In 1906 São Paulo offered premiums for its cultivation in the state. Rice has been cultivated in places, but without much success, although the quality produced compared favourably with the imported article. Indian corn grows luxuriantly everywhere, but it does not mature well in the humid regions of the Amazon region and the coast. The product of the elevated inland regions is good, but the costs of transportation and the small profits afforded have prevented its extensive cultivation, and it is imported from the La Plata republics for consumption along the coast. Much has been said in regard to the production of wheat, and efforts have been made in various places to promote its cultivation. It was once cultivated in Rio Grande do Sul with some success, and it has been grown in Minas Geraes and São Paulo, but in no case have the returns been sufficient to give it a permanent standing among the productions of the country. The great majority of the people are unused to wheat bread, using the coarse flour of the mandioca root instead, consequently the demand for wheat and flour is confined to the large cities, which can obtain them from

Argentina more cheaply than they can be produced in the country. One of the most common and important productions of Brazil is *mandioca* (*Manihot*), of which there are two well-known species, *M. utilisissima* and *M. aipi*. The first named, which is poisonous in its native state, is the *cassava* of Spanish America. From it is made *farinha de mandioca*, which is the bread of the common people of Brazil, and tapioca. The poison is extracted by soaking the bruised or grated roots in water, after which the coarse flour is roasted. *Mandioca* was cultivated by the natives before the discovery of America, and the wide area over which it has been distributed warrants the conclusion that the discovery of its value as a food and the means of separating its poisonous properties must have occurred at a very remote period. The peanut, or ground-out (*Arachis hypogaea*), is another widely-cultivated plant, dating from pre-Columbian times. Very little attention has thus far been given to the cultivation of fruit for exportation, the exceptions being bananas for the Argentine and Uruguayan markets, and oranges and pineapples for European markets. The coast region from Ceará to Rio de Janeiro is adapted to the cultivation of a great variety of fruits of a superior quality. Ceará, Bahia, and Rio de Janeiro are celebrated for their oranges, and Pernambuco for its delicious pineapples. Tangerines, lemons, limes, grapes, guavas, figs, cashews or cajús (*Anacardium occidentale*), mangabas (*Hancornia speciosa*), joboticabas (*Eugenia aculeiflora* and *E. joboticaba*, Mart.), cocoa-nuts, mangos, *frutas de corde* (*Alstonia speciosa*), plantains, &c., are produced in abundance and with little labour. In some parts of southern Brazil the fruits and vegetables of the temperate zone do well, but within the tropics they thrive well only at a considerable elevation above sea-level. Apples, peaches, quinces, raspberries, strawberries, &c., are produced under such conditions, but the flavour of their kind grown in colder climates is usually wanting. The vegetable productions are less numerous, but they include sweet potatoes, cabbages, cauliflower, lettuce, beans, peas, onions, garlic, tomatoes, okra, radishes, cucumbers, couve, chuchu (*Scorpius edule*), and aipim (*Manihot aipi*). The white potato, known as "batata inglesa" (English potato), is grown in elevated localities, but it deteriorates so greatly after the first planting that fresh imported seed is necessary every second or third year.

The pastoral industries, which date from early colonial times, have suffered many vicissitudes, and their development has failed to keep pace with the country's growth in population. Horses are used to some extent for riding, but very little for carriage and draught purposes, consequently there has been no great incentive for their breeding. They are largely used and raised in Rio Grande do Sul, but in the warmer regions of the north only to a limited extent. The hardier mules are generally employed for draught, carriage, and saddle purposes in every part of the country, and their breeding is a lucrative industry in the southern states. Cattle-raising is the principal industry in Rio Grande do Sul, and receives considerable attention in Minas Geraes, Matto Grosso, Santa Catharina, Paraná, Piahy and Rio Grande do Norte. It was estimated that there were 30,000,000 head of cattle in the republic in 1904, but the estimate was unquestionably too large. A very large part of the jerked beef consumed in Brazil is imported from Argentina and Uruguay, and some beef cattle also are imported. These importations at Rio de Janeiro in 1906 were 12,464,170 kilograms of jerked beef and 12,575 head of cattle. In the Rio Branco region of Amazonas and in Piahy, where the national government has long been the owner of extensive cattle ranges, the industry is in a state of decadence. This is partly due to such pests as the vampire bat and bush ticks (*carraças*), and partly to the unprogressiveness of the cattlemen. Cattle-raising was once a flourishing industry on the island of Marajó, at the mouth of the Amazon, and it is followed to some extent at Alemquer and other points along the Amazon, but the cattle are small, and commonly in bad condition. In southern Bahia the industry has been nearly extinguished through increasing aridity and droughts, but in the state of Rio de Janeiro the planters are increasing their herds. Minas Geraes produces cheese, butter and milk, as well as beef cattle for neighbouring cities. Matto Grosso classifies cattle-raising as a principal industry, but under present conditions the accessible markets are too small for any large development. In Rio Grande do Sul, where it has attained its greatest development, about 400,000 beaves are slaughtered annually for the manufacture of jerked beef (*carraço*), beef extract, &c. Little attention has been given to sheep in Brazil except in the southern states, and even there the flocks are small. They were to be found in Ceará and Piahy in colonial times, and small flocks are still to be seen in the latter state, but no use is made of their wool, and the market for mutton is extremely limited because of popular prejudices. Woollen manufactures have been established in Rio de Janeiro, São Paulo and Rio Grande do Sul. The exportation of wool amounted to 1,130,160 lb in 1906. Goats have been found highly profitable in many of the middle Atlantic states, where the long dry seasons render the campos unsuitable for cattle pasturage. The export of goat skins from these states is large. Swine do well in all parts of the country, especially in Minas Geraes, São Paulo, Rio de Janeiro, Paraná and Rio Grande do Sul, and domestic pork and lard are slowly supplanting the heavily-taxed foreign products.

Although the coast and river fisheries of Brazil are numerous and valuable, cured fish is one of the staple imports, and foreign products

are to be found even along the Amazon. In the Amazon valley fish is a principal article of food, and large quantities of *pirarucu* (*Sudis gigas*) are caught during the season of low water and prepared for storage or market by drying in the sun. This and the collection of turtle eggs for their oil, or butter, are chiefly Indian industries, and contribute largely to the support of the native population of that region. Along the coast the best known fisheries are among the *Abrolhos* islands and in the shallow waters of Espírito Santo, where the *garoupa*, *pargo* and *vermelho* (species of *Serranus*) abound in great numbers.

The extractive or forest industries of Brazil were among the first to engage the attention of Europeans, and have always been considered a principal source of colonial and national wealth. The varied uses of india-rubber in modern times, however, have given them a greatly enhanced importance and value. Of the exports of 1905, 36% were of this class, while those of the pastoral and mining industries combined were not quite 6%. In 1906 the percentages were 31 and 6-67, showing a considerable loss for the former and a slight gain for the latter. The principal products of this class are india-rubber, maté, Brazil nuts, vegetable wax, palm fibre, cabinet woods, and medicinal leaves, roots, resins, &c. Before the discovery of the cheaper aniline colours, dye-woods were among the most valuable products of the country; in fact, Brazil derives her name from that of a dye-wood (Brazil-wood—*Caesalpinia echinata*), known as *brasil*, *brasily*, *brasilis*, or *brasilie* long before the discovery of America (see Humboldt's *Géographie du nouveau continent*, tom. ii. p. 214), which for many generations was the most highly prized of her natural productions. Of the total exports of this group (1905) very nearly 90% was of india-rubber, which percentage was reduced to 85 in the following year. The exportation for 1906 was 69,761,123 lb of Hevea, 5,871,968 lb of maniocoba, and 1,440,131 lb of mangabeira rubber, the whole valued at 124,941,433 milreis gold. The dried leaves and smaller twigs of maté (Paraguay tea—*Ilex Paraguensis*) are exported to the southern Spanish American republics, where (as in Rio Grande do Sul) the beverage is exceedingly popular. The export in 1906 amounted to 127,417,950 lb, officially valued at 16,502,881 milreis gold. The collection of Brazil nuts along the Amazon and its tributaries is essentially a poor man's industry, requiring no other plant than a boat. The harvest comes in January and February, in the rainy season, and the nut-gatherers often come one or two hundred miles in their boats to the best forests. The nuts are the fruit of the *Bertholletia excelsa*, one of the largest trees of the Amazon forest region, and are enclosed, sixteen to eighteen in number, in a hard, thick pericarp. Another nut-producing tree is the *sapucaya* (*Lacrythia olaria*), whose nuts are enclosed in a larger pericarp, and are considered to be better flavoured than those first described. The crop is a variable one, the export in 1905 having been 198,226 hectolitres, while that of 1906 was 96,770 hectolitres. It could undoubtedly be largely increased. Vegetable wax, which is an excellent substitute for beeswax, is a product of the *Carnaubus* palm (*Copernicia cerifera*), and is an important export from Ceará. Palm, or piassava fibre, derived from the *piassava* palm, is used in the manufacture of brooms, brushes, &c. It is found as far south as southern Bahia, and the export could be very largely increased. The export of cabinet woods is not large, considering the forest area of Brazil and the variety and quality of the woods. This is principally due to the cost and difficulties of transporting timbers to the coast. The export is confined principally to rosewood. Of the medicinal plants, the best-known products are ipecacuanhã, marsiparilla, copaiba, jaborandi and cinchona, but this is only a part of the list. Besides these, tonka beans, anatto, vanilla, and castor-oil seeds form a part of the exports.

The mineral exports are surprisingly small. Gold was discovered by the Portuguese soon after their settlement of the coast in the 16th century, but the washings were poor and attracted little attention. The richer deposits of Minas Geraes were discovered about 1693, and those of Matto Grosso early in the following century. Abandoned placer mines are to be found in every part of the unsettled interior, showing how thoroughly it had been explored by gold-hunters in those early days. Some good mines, like Morro Velho and the abandoned Gongo Soco, have been developed in Minas Geraes, but the great majority are small and not very productive. Diamonds were discovered in Minas Geraes, near the town now called Diamantina, during the first half of the 18th century, the dates given ranging from 1725 to 1746, but the productiveness of the district has greatly decreased. Diamonds have also been found in Bahia, Goyaz and Paraná. Other precious stones found in Brazil are the topaz, ruby, aquamarine, tourmaline, chrysoberyl, garnet and amethyst. Among the minerals are silver, platinum, copper, iron, lead, manganese, chromium, quicksilver, bismuth, arsenic and antimony, of which only iron and manganese have been regularly mined. The copper deposits of Minas Geraes are said to be promising. Manganese is mined in Minas Geraes for export. Iron ores have been found in most of the states, and are especially abundant in Minas Geraes. The Ipanema mine and ironworks, near Sorocaba, São Paulo, which belong to the national government, have been in operation since 1810, and small charcoal forges were in operation in colonial times and supplied the mines with a considerable part of the iron needed by them. Many of the richer deposits have never been developed because of a lack of fuel and limestone. Bituminous

coal of an inferior quality is mined to a limited extent in Rio Grande do Sul, and another mine has been opened in Santa Catharina. These coal deposits extend from Rio Grande do Sul north into the state of São Paulo. Salt, which does not figure in the list of exports, is produced along the coast between Pernambuco and Cape St Roque. The annual production is about 240,000 tons.

To illustrate the comparative productiveness and relationship of these sources of national wealth and industry, the following official returns of export for the years 1905 and 1906 are arranged in the four general classes previously discussed—the values being in Brazilian gold milreis, worth 2s. 3d. or 54-6 cents to the milreis:—

	Agricultural.	
	1905.	1906.
	Milreis, gold.	Milreis, gold.
Coffee	190,404,576	245,474,525
Cotton	10,290,790	14,726,492
Cacao	9,240,313	12,323,922
Tobacco	7,335,163	8,283,150
Sugar	3,608,476	5,388,596
Bras ¹	1,490,312	1,128,761
Cotton seed	964,074	1,084,742
Mandioca flour	692,079	789,913
Fruits	606,678	714,332
Castor-oil seeds	214,116	333,250
	<hr/>	<hr/>
	224,846,477	290,247,683
	Natural and Forest.	
Rubber:		
Mangabeira	1,286,672	1,376,014
Mangoba	7,418,559	7,335,870
Hevea (Pará)	119,433,947	116,229,549
Maté (Paraguay tea)	11,088,168	16,502,881
Brazil nuts	2,064,049	1,190,177
Palm wax (Carnaubá)	1,847,273	3,733,478
Cabinet woods	390,070	314,873
Piassava fibre	336,668	347,323
Medicinal leaves, roots, resins, &c.	191,534	263,137
	<hr/>	<hr/>
	143,331,142	147,297,302
	Pastoral and Animal.	
Salted hides	7,010,498	9,691,180
Dry hides	5,330,440	7,675,715
Skins	4,117,590	4,639,512
Horse hair	307,505	403,541
Horns	276,172	277,488
Wool	142,414	354,045
Beef extract, &c.	81,607	110,925
	<hr/>	<hr/>
	17,266,226	23,152,406
	Mineral Products.	
Gold, in bars	3,734,469	4,379,160
Manganese ore	2,958,462	1,594,486
Monazite sand	889,231	881,289
Precious stones	633,916	1,480,260
	<hr/>	<hr/>
	8,216,078	8,335,195
	Miscellaneous.	
Old metals ²	263,506	382,073
Sundry products	2,177,512	2,225,163
	<hr/>	<hr/>
	2,441,018	2,607,236
Total, all products	396,827,679	471,639,822

Manufactures.—Before the establishment of the republic very little attention had been given to manufacturing industries beyond what was necessary to prepare certain crude products for market. Sugar and rum were essentially plantation products down to the last ten years of the empire, when central usines using improved machinery and methods were introduced as a means of saving the sugar plantations from ruin. The crude methods of preparing jerked beef were also modified to some extent by better equipped abattoirs and establishments for preparing beef extract, preserved meats, &c. There were also mills for crushing the dried maté leaves, cigar and

¹The "bras" exported is from imported wheat and cannot be considered a national product.

²The "old metals" consist of old iron, brass, &c., derived from railway material, machinery, &c., all imported, and should not be considered a Brazilian product.

The "sundry products" would probably be included in the four general classes were the items given.

of the church, and their sentiment against the profanation of holy ground. Formerly Brazil constituted an ecclesiastical province under the metropolitan jurisdiction of an archbishop residing at Bahia, with 11 suffragan bishops, 12 vicars-general and about 2000 curates. In 1892 the diocese of Rio de Janeiro was made an archbishopric, and four new dioceses were created. Three more have been added since, making twenty dioceses in all. In 1905 the archbishop of Rio de Janeiro was made a cardinal. The church has eleven seminaries for the education of priests, and maintains a large number of private schools, especially for girls, which are patronized by the better classes. The church likewise exercises a far-reaching influence over the people through the beneficent work of its lay orders, and through the hospitals and asylums under its control in every part of the country. A Misericórdia hospital is to be found in almost every town of importance, and *recolhimentos* for orphan girls in all the large cities. In no country have these charities received more generous support than in Brazil. The Protestant contingent consists of a number of small congregations scattered throughout the country, a few Portuguese Protestants from the Azores, a part of the German colonists settled in the central and southern states, and a large percentage of the North Europeans and Americans temporarily resident in Brazil. The Positivists are few in number, but their congregations are made up of educated and influential people.

Art, Science and Literature.—The Brazilian people have the natural taste for art, music and literature so common among the Latin nations of the Old World. The emperor Dom Pedro II. did much to encourage these pursuits, and many promising young men received their education in Europe at his personal expense. Still earlier in the century (1815) the regent Dom John VI. brought out a number of French artists to educate his subjects in the fine arts, and the *Escola Real de Sciencias, Artes e Officios* was founded in the following year. From this beginning resulted the *Academia de Bellas Artes* of a later date, to which was added a conservatory of music in 1841. The institution is now called the *Escola Nacional de Bellas Artes*. Free instruction in the fine arts has been given in this school. The higher results of artistic training, however, are less marked than a widespread dilettantism. The Brazilian composer Carlos Gomes (1830–1896) is the best known of those who have adopted music as a profession, his opera *Il Guarani* having been produced at most of the European capitals. The most prominent among Brazilian painters is Pedro Americo, and in sculpture Rodolpho Bernardelli has done good work. In science Brazil has accomplished very little, although many eminent foreign naturalists have spent years of study within her borders. João Barbosa Rodrigues has done some good work in botany, especially in the study of the palms of the Amazon, and João Baptista de Lacerda has made important biological investigations at the national museum of Rio de Janeiro. There are several scientific societies and institutions in the country, but they rarely undertake original work. The most active are the geographical societies, but very little has been done in the direction of scientific exploration. Some interesting results have been obtained from the boundary surveys, from Dr E. Cruls's exploration of a section of the Goyaz plateau in 1892 in search of a site for the future capital of the republic, and from some of the river and railway surveys. In 1875 a geological commission was organized under the direction of Professor Charles Frederick Hartt, but it was disbanded two years later. In 1906 Congress resolved to undertake a national geological survey under the direction of Mr Orville A. Derby, one of Professor Hartt's assistants. The coal resources of the southern states were investigated in 1904, under the auspices of the national government, by Dr J. C. White, of the U. S. Geological Survey, who found strata of fairly good coal at depths of 100 to 200 ft. extending from Rio Grande do Sul north to São Paulo. The more important contributions to our present knowledge of Brazil, however, have been obtained through the labours of foreign naturalists. Beginning with the German mineralogist W. L. von Eschwege, who spent nineteen years in Brazil (1809–1828), the list includes A. de Saint-Hilaire (1816–

1820 and 1830), J. B. von Spix and C. F. von Martins (1817–1820), Prince Max zu Neuwied (1815–1817), P. W. Lund (1827–1830, and 1830 to 1880, the year of his death), George Gardner (1836–1841), A. R. Wallace (1848–1852), H. W. Bates (1848–1859), Hermann Burmeister (1850–1852), Louis Agassiz (1865–1866), Charles Frederick Hartt (1865–1866, 1872 and 1875–1878) and Karl von den Steinen (1884–1885 and 1887–1888). These explorations cover every branch of natural science and resulted in publications of inestimable scientific value. There should also be mentioned the monumental work of C. F. P. von Martius on the *Flora Brasiliensis*, and the explorations of Agassiz and Lund. Among other scientists of a later date who have published important works on Brazil are the American geologists O. A. Derby and J. C. Branner, the Swiss naturalist E. A. Goeldi, the German botanist J. Huber, the German ethnologist H. von Ithing, and the German geographer Fried. Ktzer. The *Instituto Historico e Geographico Brasileiro*, though devoted chiefly to historical research, has rendered noteworthy service in its encouragement of geographical exploration and by its publication of various scientific memoirs. The Museu Nacional at Rio de Janeiro, which has occupied the imperial palace of São Christovão since the overthrow of the monarchy, contains large collections of much scientific value, but defective organization and apathetic direction have rendered them of comparatively slight service. The Observatorio Nacional at Rio de Janeiro is another prominent public institution. The botanical gardens of Brazil are developing into permanent exhibitions of the flora of the regions in which they are located. That of Rio de Janeiro is widely celebrated for its avenues of royal palms, but it has also rendered an important service to the country in the dissemination of exotic plants.

Brazilian literature has been seriously prejudiced by partisan politics and dilettantism. The colonial period was one of strict repression, the intellectual life of the people being jealously supervised by the church to protect itself against heresy, and their progress being restricted by the Portuguese crown to protect its monopoly of the natural resources of the country. The arrival of Dom John VI. in 1808 broke down some of these restrictions, and the first year of his residence in Rio de Janeiro saw the establishment of the first printing press in Brazil and the publication of an official gazette. There was no freedom of the press, however, until 1821, when the abolition of the censorship and the constitutional struggle in Portugal gave rise to a political discussion that marked the opening of a new era in the development of the nation, and aroused an intellectual activity that has been highly productive in journalistic and polemical writings. In no country, perhaps, has the press exercised a more direct and powerful influence upon government than in Brazil, and in no other country can there be found so high a percentage of journalists in official life. Some of the political writers have played an important part in moulding public opinion on certain questions, as in the case of A. C. Tavares Bastos, whose *Carias do Solitario* were highly instrumental in causing the Amazon to be thrown open to the world's commerce and also in preparing the way for the abolition of slavery; and in that of Joaquim Saldanha Maranhão, whose discussions in 1874–1876 of the relations between church and state prepared the way for their separation. The personal element is conspicuous in the Brazilian journalism, and for a considerable period of its history libellous attacks on persons, signed by professional sponsors, popularly called *testas de ferro* (iron heads), were admitted at so much a line in the best newspapers.

The singular adaptability of the Portuguese language to poetical expression, coupled with the imaginative temperament of the people, has led to an unusual production and appreciation of poetry. The percentage of educated men who have written little volumes of lyrics is surprisingly large, and this may be accounted for by the old Portuguese custom of reciting poetry with musical accompaniment. The most popular of the Brazilian poets are Thomaz Antonio Gonzaga, Antonio Gonçalves Dias and Bernardo Guimarães. Among the dramatists and novelists

may be mentioned Joaquim Manoel de Macedo, José Martiniano de Alencar, Bernardo Guimarães, A. de Escrangolle Taunay and J. M. Machado de Assis. José M. de Alencar is usually described as the greatest of Brazilian novelists. The most popular of his romances are *Iracema* and *O Guarany*. In historical literature Brazil has produced one writer of high standing—Francisco Adolpho Varnhagen (Visconde de Porto Seguro), whose *História Geral do Brasil* is a standard authority on that subject. The two English authorities, Robert Southey's *History of Brazil*, covering the colonial period, and John Armitage's *History of Brazil*, covering the period between the arrival of the Braganza family (1808) and the abdication of Dom Pedro I. (1831), have been translated into Portuguese. Another Brazilian historian of recognized merit is João Manoel Pereira da Silva, whose historical writings cover the first years of the empire, from its foundation to 1840. Among the later writers João Capistrano de Abreu has produced some short historical studies of great merit. In the field of philosophic speculation, Auguste Comte has had many disciples in Brazil.

Finance.—The national revenue is derived largely from the duties on imports, the duties on exports having been surrendered to the states when the republic was organized. Other sources of revenue are stamp taxes on business transactions, domestic consumption taxes (usually payable in stamps) on manufactured tobaccos, beverages, boots and shoes, textiles, matches, salt, preserved foods, hats, pharmaceutical preparations, perfumeries, candles, vinegar, walking sticks and playing cards, and taxes on lotteries, passenger tickets, salaries and dividends of joint-stock companies. Formerly import duties were payable in currency, but in 1899 it was decided to collect 10% of them in gold to provide the government with specie for its foreign remittances. The revenues and expenditures have since then been calculated in gold and currency together, to the complete mystification of the average citizen, and the gold percentage of the duties on imports has been increased to 35 and 50% (in 1907), the higher rate to apply to specified articles and rule when exchange on London is above 14 pence per milreis, and the lower when it is below. The service of the national debt absorbs a very large part of the expenditure, about 45% of the estimates for 1907 being assigned to the department of finance. The department of industry, communications and public works takes the next highest proportion, but about half its expenditures are met by special taxes, as in the case of port works and railway inspection, and by the revenues of the state railways, telegraph lines and post office. The depreciation and unstable character of the paper currency render it difficult to give a clear statement of receipts and expenditures for a term of years, the sterling equivalents often showing a decrease, through a fall in the value of the milreis, where there has been an actual increase in currency returns. This was most noticeable between 1889 and 1898, when exchange, which represents the value of the milreis, fell from a maximum of 27½ pence (27d. being the par value of the milreis) to a minimum of 5½ pence. Since 1898 there has been an upward movement of exchange, the average rate for 1903 having been very nearly 16 pence. In this period the increase in the sterling equivalents would be proportionately greater than that of the currency values. The gold and currency receipts and expenditures for the six years 1900 to 1905, inclusive, according to official returns, were as follows:—

Year.	Average Rate of Exchange. Pence.	Revenue.		Expenditure.	
		Gold Milreis.	Currency Milreis.	Gold Milreis.	Currency Milreis.
1900	9-50	49,955,522	263,687,253	41,892,150	372,753,986
1901	11-38	44,041,302	239,284,702	40,493,241	261,629,212
1902	11-97	42,904,844	266,584,912	34,574,643	236,458,862
1903	12	45,121,815	327,370,063	48,324,642	291,198,960
1904	12-28	50,566,572	344,782,191	48,478,413	352,292,147
1905	15-89	64,207,004	243,335,396	51,606,272	265,699,281

Reducing gold to a currency basis at 15d. per milreis (the official valuation adopted in 1906), the budget for 1907 provided for a revenue of 353,590,593 milreis and an expenditure of 409,482,284 milreis, showing a deficit of 55,891,691 milreis. These deficits were common enough under the monarchy, but they have become still more prominent under the republic. According to the "Retrospecto Commercial" for 1906 of the *Jornal do Commercio* (Rio de Janeiro, March 3, 1907), the aggregate deficits for the eleven years 1891 to 1904 were 692,000,000 milreis, or, say, £43,250,000.

The natural result of such a regime is increasing indebtedness. In 1888, a year before the republic was proclaimed, the internal and external national debts amounted to £74,000,000 sterling, with the currency at par. Ten years later, when the currency had fallen to 5½ pence per milreis, the government found itself unable to meet

the interest obligations on its debt and railway guarantees, and an arrangement was made with its creditors in London for the issue of a 5% funding loan to an amount not to exceed £10,000,000, and the suspension of all amortization for thirteen years. On the other hand the government agreed to withdraw currency which had reached a total of 788,364,614 ½ milreis, *pari passu* with the issue of the loan, the milreis being computed at 18 pence. The purpose of this condition was in order to improve the value of the paper milreis in order to increase the specie value of the revenues. The scheme came into operation in June 1898, and not only was a complete suspension of payments avoided but the financial situation was greatly improved. The government even withdrew more of its currency issues than required by the agreement, and the value of the milreis steadily improved. At the same time the government carried out the forced conversion of the national loans into lower interest-bearing issues, which greatly reduced the annual interest charges. These measures would have put the financial affairs of the nation on a solid footing in a very few years had the government been able to keep its expenditure within its income. The naval revolt of 1893-1894, however, had aroused the spirit of militarism in the ruling classes, and the effort to perfect the organization and equipment of the army, strengthen the fortifications of Rio de Janeiro, and increase the navy, have kept expenditures in excess of the revenues. The purchase of guaranteed railways owned by foreign companies likewise added largely to the bonded indebtedness, though the onus was in existence in another form. The result of these measures was a large addition to the public debt, which on 31st December 1906 was approximately as follows (*apólices* being the name given to bonds inscribed to the holder):—

External debt:	£	s.	d.
Loans of 1883, 1888 and 1889	26,478,500		
Oeste de Minas R. R. loan	3,388,100		
Loan of 1898	7,331,600		
Funding loan of 1898	8,613,717	9	9
Railway rescission loan of 1901	15,467,015	16	1
Port works loan of 1903	8,500,000		
	£69,778,933	5	10

Internal debt, funded:	Milreis
5% apólices, Law of 1827	483,546,600
4 1/2% " " 1879	3,388,100
6% " " 1897	37,682,000
5% " " 1903	17,300,000
Total, funded	558,476,600
(at 15d. £34,904,787)	

Internal debt, not funded:	Milreis
Paper money	664,792,960
Savings bank and other deposits:	
In paper	246,812,407
In gold, 19,053,861 r (say)	34,296,950
Floating indebtedness (9%: current, bills, &c.)	?
Total, not funded, approx.	945,902,317
(at 15d. £59,118,895 stg.)	

Approximate total indebtedness . . . £163,802,675

In addition to these, the government was still responsible for interest guarantees on fourteen railways, or sections of existing lines, with an aggregate capital of about £4,900,000 held in Europe and 12,055,440 milreis held in Brazil, on which the national treasury paid in interest £191,324 and 1,398,493 milreis.

The paper currency of Brazil consists of both treasury issues and bank-notes, the latter issued under government supervision. Its fluctuations in value have been not only a serious inconvenience in commercial transactions, but also the cause of heavy loss to the people. Under the provisions of the funding loan of 1898 a scheme for the withdrawal of the paper money was carried into effect, and by the end of December 1906 the amount in circulation had been reduced from 788,364,614 ½ milreis (the outstanding circulation 31st August 1898) to 664,792,960 ½ milreis. Two funds were created for the redemption and guarantee of paper issues, the latter receiving 5% of the import duties payable in gold. Up to 1906 the Caixa da Amortização (redemption bureau), which has charge of the service of the internal funded debt, superintended the redemption of the currency, but in that year (December 6, 1906) a Caixa de Conversão (conversion bureau) was created for this special service. It is modelled after the Argentine Conversion office, and is authorized to issue notes to bearer against deposits of gold at the rate of 15 pence per milreis although exchange was above 17d. when the scheme was proposed. The notes are to be redeemable in gold at

sight; the Caixa de Conversão to keep the gold paid in for that express purpose. The coffee producers of São Paulo and other states found that the appreciation in value of the milreís was reducing their profits, and they advocated this measure (at first with a valuation of 12d.) to check the upward movement in exchange. Metallic money is limited to nickel and bronze coins, but in 1906 the government was authorized to purchase bar silver for the coinage of pieces of the denomination of two milreís, one milreís and 500 reis (½-milreís). Gold is the nominal standard of value, the monetary unit being the gold milreís worth 25.2½d. at par. The 10-milreís gold piece weighs 8.9648 grammes, 916 fine, and contains 8.2178 grammes of pure gold. There is no gold in circulation, however, and gold duties are paid with gold cheques purchased at certain banks with paper money. The banking facilities of the republic have undergone many changes under the new regime. A fruitful cause of disaster has been the practice of issuing agricultural and industrial loans under government authorization. Commercial business at the principal ports is largely transacted through foreign banks, of which there are a large number.

In addition to the indebtedness of the national government, the individual states have also incurred funded debts of their own. The aggregate of these debts in 1904 was £20,199,440, and the several loans made during the next two years, including those of the municipalities of Rio de Janeiro, Santos, Bahia and Manaus, add fully two and a half millions more to the total. (A. J. L.)

HISTORY

Brazil was discovered in February 1499 (o.s.) by Vicente Yañez Pinzon, a companion of Columbus. He descried the land near Cape St Augustine, and sailed along the coast as far as the river Amazon, whence he proceeded to the mouth of the Orinoco. He made no settlement, but

The Portuguese in Brazil.

took possession of the country in the name of the Spanish government, and carried home, as specimens of its natural productions, some drugs, gems and Brazil-wood. Next year the Portuguese commander, Pedro Alvares Cabral, appointed by his monarch to follow the course of Vasco da Gama in the East, was driven by adverse winds so far from his track, that he reached the Brazilian coast, April 24, and anchored in Porto Seguro (16° S. lat.) on Good Friday. On Easter day an altar was erected, mass celebrated in presence of the natives, the country declared an apanage of Portugal, and a stone cross erected in commemoration of the event. Cabral despatched a small vessel to Lisbon to announce his discovery, and, without forming any settlement, proceeded to India on the 3rd of May. On the arrival of the news in Portugal, Emanuel invited Amerigo Vespucci to enter his service, and despatched him with three vessels to explore the country. The navigator's first voyage was unsuccessful; but, according to his own account, in a second he discovered a safe port, to which he gave the name of All-Saints and where he erected a small fort. Vespucci's narrative is, however, suspected of being apocryphal (see VESPUCCI, AMERIGO).

The poor and barbarous tribes of Brazil, and their country, the mineral riches of which were not immediately discovered, offered but few attractions to a government into the coffers of which the wealth of India and Africa was flowing. For nearly thirty years the kings of Portugal paid no further attention to their newly-acquired territory than what consisted in combating the attempts of the Spaniards to occupy it, and dispersing the private adventurers from France who sought its shores for the purposes of commerce. The colonization of Brazil was prosecuted, however, by subjects of the Portuguese monarchy, who traded thither chiefly for Brazil-wood. The government also sought to make criminals of some use to the state, by placing them in a situation where they could do little harm to society, and might help to uphold the dominion of their nation.

The first attempt on the part of a Portuguese monarch to introduce an organized government into his dominions was made by John III. He adopted a plan which had been found to succeed well in Madeira and the Azores,—dividing the country into hereditary captaincies, and granting them to such persons as were willing to undertake their settlement, with unlimited powers of jurisdiction, both civil and criminal. Each captaincy extended along fifty leagues of coast. The boundaries in the interior were undefined. The first settlement made under this new system was that of

São Vicente Piratininga, in the present province of São Paulo. Martim Afonso de Sousa, having obtained a grant, fitted out a considerable armament and proceeded to explore the country in person. He began to survey the coast about Rio de Janeiro, to which he gave that name, because he discovered it on the 1st of January 1531. He proceeded south as far as La Plata, naming the places he surveyed on the way from the days on which the respective discoveries were made. He fixed upon an island in 24½° S. lat., called by the natives Guaibe, for his settlement. The Goagnazes, or prevailing tribe of Indians in that neighbourhood, as soon as they discovered the intentions of the new-comers to fix themselves permanently there, collected for the purpose of expelling them. Fortunately, however, a shipwrecked Portuguese, who had lived many years under the protection of the principal chief, was successful in concluding a treaty of perpetual alliance between his countrymen and the natives. Finding the spot chosen for the new town inconvenient, the colonists removed to the adjoining island of São Vicente, from which the captaincy derived its name. Cattle and the sugar-cane were at an early period introduced from Madeira, and here the other captaincies supplied themselves with both.

Pero Lopes de Sousa received the grant of a captaincy, and set sail from Portugal at the same time as his brother, the founder of São Vicente. He chose to have his fifty leagues in two allotments. That to which he gave the name of Santo Amaro adjoined São Vicente, the two towns being only three leagues asunder. The other division lay much nearer to the line between Parahyba and Pernambuco. He experienced considerable difficulty in founding this second colony, from the strenuous opposition of a neighbouring tribe, the Pétiguaires; at length he succeeded in clearing his lands of them, but not long afterwards he perished by shipwreck.

Rio de Janeiro was not settled till a later period; and for a considerable time the nearest captaincy to Santo Amaro, sailing along the coast northwards, was that of Espírito Santo. It was founded by Vasco Fernandes Coutinho, who having acquired a large fortune in India, sank it in this scheme of colonization. He carried with him no less than sixty fidalgos. They named their town by anticipation, Our Lady of the Victory (Victoria); but it cost them some hard fighting with the Goagnazes to justify the title.

Pedro de Campo Tourinho, a nobleman and excellent navigator, received a grant of the adjoining captaincy of Porto Seguro. This, it will be remembered, is the spot where Cabral first took possession of Brazil. The Tupinoquins at first offered some opposition; but having made peace, they observed it faithfully, notwithstanding that the oppression of the Portuguese obliged them to forsake the country. Sugar-works were established, and considerable quantities of the produce exported to the mother country.

Jorge de Figueiredo, *Escrivão da Fazenda*, was the first donatory of the captaincy Ilhéos, 140 m. south of Bahia. His office preventing him from taking possession in person, he deputed the task to Francisco Romeiro, a Castilian. The Tupinoquins, the most tractable of the Brazilian tribes, made peace with the settlers, and the colony was founded without a struggle.

The coast from the Rio São Francisco to Bahia was granted to Francisco Pereira Coutinho; the bay itself, with all its creeks, was afterwards added to the grant. When Coutinho formed his establishment, where Villa Velha now stands, he found a noble Portuguese living in the neighbourhood who, having been shipwrecked, had, by means of his fire-arms, raised himself to the rank of chief among the natives. He was surrounded by a patriarchal establishment of wives and children; and to him most of the distinguished families of Bahia still trace their lineage. The regard entertained by the natives for Caramuru (signifying *man of fire*) induced them to extend a hospitable welcome to his countrymen, and for a time everything went on well. Coutinho had, however, learned in India to be an oppressor, and the Tupinambas were the fiercest and most powerful of the native tribes. The Portuguese were obliged to abandon their settlement; but several of them returned at a later period, with

Caramuru, and thus a European community was established in the district.

Some time before the period at which these captaincies were established, a factory had been planted at Pernambuco. A ship from Marseilles took it, and left seventy men in it as a garrison; but she was captured on her return, and carried into Lisbon, and immediate measures were taken for reoccupying the place. The captaincy of Pernambuco was granted to Don Duarte Coelho Pereira as the reward of his services in India. It extended along the coast from the Rio São Francisco, northward to the Rio de Jurua. Duarte sailed with his wife and children, and many of his kinsmen, to take possession of his new colony, and landed in the port of Pernambuco. To the town which was there founded he gave the name of Olinda. The Cabetes, who possessed the soil, were fierce and pertinacious; and, assisted by the French, who traded to that coast, Coelho had to gain by inches what was granted him by leagues. The Portuguese managed, however, to beat off their enemies; and, having entered into an alliance with the Tobayanans, followed up their success.

Attempts were made about this time to establish two other captaincies, but without success. Pedro de Goes obtained a grant of the captaincy of Parahyba between those of São Vicente and Espírito Santo; but his means were too feeble to enable him to make head against the aborigines, and the colony was broken up after a painful struggle of seven years. João de Barros, the historian, obtained the captaincy of Maranhão. For the sake of increasing his capital, he divided his grant with Fernão Alvares de Andrade and Aires da Cunha. They projected a scheme of conquest and colonization upon a large scale. Nine hundred men, of whom one hundred and thirteen were horsemen, embarked in ten ships under the command of Aires da Cunha. But the vessels were wrecked upon some shoals about one hundred leagues to the south of Maranhão; the few survivors, after suffering immense hardships, escaped to the nearest settlements, and the undertaking was abandoned.

By these adventures the whole line of Brazilian coast, from the mouth of La Plata to the mouth of the Amazon, had become studded at intervals with Portuguese settlements, in all of which law and justice were administered, however inadequately. It is worthy of observation, that Brazil was the first colony founded in America upon an agricultural principle, for until then the precious metals were the exclusive attraction. Sufficient capital was attracted between the year 1531 (in which De Sousa founded the first captaincy) and the year 1548 to render these colonies an object of importance to the mother country. Their organization, however, in regard to their means of defence against both external aggression and internal violence, was extremely defective. Their territories were surrounded and partly occupied by large tribes of savages. Behind them the Spaniards, who had an establishment at Asuncion, had penetrated almost to the sources of the waters of Paraguay, and had succeeded in establishing communication with Peru. Orellana, on the other hand, setting out from Peru, had crossed the mountains and sailed down the Amazon. Nor had the French abandoned their hopes of effecting an establishment on the coast.

The obvious remedy for these evils was to concentrate the executive power, to render the petty chiefs amenable to one tribunal, and to confide the management of the defensive force to one hand. In order to this the powers of the several captains were revoked, whilst their property in their grants was reserved to them. A governor-general was appointed, with full powers, civil and criminal. The judicial and financial functions in each province were vested in the *Ovidor*, whose authority in the college of finance was second only to that of the governor. Every colonist was enrolled either in the *Milicias* or *Ordenanzas*. The former were obliged to serve beyond the boundaries of the province, the latter only at home. The chief cities received municipal constitutions, as in Portugal. Thome de Sousa was the first person nominated to the important post of governor-general. He was instructed to build a strong city in Bahia and to establish there the seat of his government. In pursuance

of his commission he arrived at Bahia in April 1549, with a fleet of six vessels, on board of which were three hundred and twenty persons in the king's pay, four hundred convicts and about three hundred free colonists. Care had been taken for the spiritual wants of the provinces by associating six Jesuits with the expedition.

Old Caramuru, who still survived, rendered the governor essential service by gaining for his countrymen the goodwill of the natives. The new city, to which the name of São Salvador was given, was established on the heights above the Bay of All Saints (*Todos os Santos*), from which its later name of Bahia is taken. Within four months one hundred houses were built, and surrounded by a mud wall. Sugar plantations were laid out in the vicinity. During the four years of Sousa's government there were sent out at different times supplies of all kinds. Female orphans of noble families were given in marriage to the officers, and portioned from the royal estates, and orphan boys were sent to be educated by the Jesuits. The capital rose rapidly in importance, and the captaincies learned to regard it as a common head and centre of wealth. Meanwhile the Jesuits undertook the moral and religious culture of the natives, and of the scarcely less savage colonists. Strong opposition was at first experienced from the gross ignorance of the Indians, and the depravity of the Portuguese, ^{First Jesuit mission.} fostered by the licentious encouragement of some abandoned priests who had found their way to Brazil. Over these persons the Jesuits had no authority; and it was not until the arrival of the first bishop of Brazil in 1552, that anything like an efficient check was imposed upon them. Next year Sousa was succeeded by Duarte da Costa, who brought with him a reinforcement of Jesuits, at the head of whom was Luis de Gran, appointed, with Nobrega the chief of the first mission, joint provincial of Brazil.

Nobrega's first act was one which has exercised the most beneficial influence over the social system of Brazil, namely, the establishment of a college on the then unreclaimed plains of Piratininga. It was named São Paulo, and has been at once the source whence knowledge and civilization have been diffused through Brazil, and the nucleus of a colony of its manliest and hardiest citizens, which sent out successive swarms of hardy adventurers to people the interior. The good intentions of the Jesuits were in part frustrated by the opposition of Costa the governor; and it was not until 1558, when Mem de Sa was sent out to supersede him, that their projects were allowed free scope.

Rio de Janeiro was first occupied by French settlers. Nicholas Durand de Villegagnon, a bold and skillful seaman, having visited Brazil, saw at once the advantages which might accrue ^{Settlement of Rio de Janeiro.} to his country from a settlement there. In order to secure the interest of Coligny, he gave out that his projected colony was intended to serve as a place of refuge for the persecuted Huguenots. Under the patronage of that admiral, he arrived at Rio de Janeiro in 1558 with a train of numerous and respectable colonists. As soon, however, as he thought his power secure, he threw off the mask, and began to harass and oppress the Huguenots by every means he could devise. Many of them were forced by his tyranny to return to France; and ten thousand Protestants, ready to embark for the new colony, were deterred by their representations. Villegagnon, finding his force much diminished in consequence of his treachery, sailed for France in quest of recruits; and during his absence the Portuguese governor, by order of his court, attacked and dispersed the settlement. For some years the French kept up a kind of bush warfare; but in 1567 the Portuguese succeeded in establishing a settlement at Rio.

Mem de Sa continued to hold the reins of government in Brazil upon terms of the best understanding with the clergy, and to the great advantage of the colonies, for fourteen years. On the expiration of his power, which was nearly contemporary with that of his life, an attempt was made to divide Brazil into two governments; but this having failed, the territory was reunited in 1578, the year in which Diego Laurencço da Veiga was appointed governor. At this time the colonies, although not yet

independent of supplies from the mother country, were in a flourishing condition; but the usurpation of the crown of Portugal by Philip II. changed the aspect of affairs. Brazil, believed to be inferior to the Spanish possessions in mines, was consequently abandoned in comparative neglect for the period intervening between 1578 and 1640, during which it continued an appanage of Spain.

No sooner had Brazil passed under the Spanish crown, than English adventurers directed their hostile enterprises against its shores. In 1586 Witherington plundered Bahia; in 1591 Cavendish made an abortive attack on Santos; in 1595 Lancaster attacked Olinda. These exploits, however, were transient in their effects. In 1612 the French attempted to found a permanent colony in the island of Marajó, where they succeeded in maintaining themselves till 1618. This attempt led to the erection of Maranhão and Pará into a separate *Estado*. But it was on the part of the Dutch that the most skillful and pertinacious efforts were made for securing a footing in Brazil; and they alone of all the rivals of the Portuguese have left traces of their presence in the national spirit and institutions of Brazil.

The success of the Dutch East India Company led to the establishment of a similar one for the West Indies, to which a monopoly of the trade to America and Africa was granted. This body despatched in 1624 a fleet against Bahia. The town yielded almost without a struggle.

The fleet soon after sailed, a squadron being detached against Angola, with the intention of taking possession of that colony, in order to secure a supply of slaves. The fall of Bahia for once roused the Spaniards and Portuguese to joint action, and a great expedition speedily sailed from Cadiz and Lisbon for Bahia. Once more, though strongly garrisoned, the town was retaken without any serious fighting in May 1625. The honours bestowed upon the Indian chiefs for their assistance in this war broke down in a great measure the barrier between the two races; and there is at this day a greater admixture of their blood among the better classes in Bahia than is to be found elsewhere in Brazil.

In 1630 the Dutch attempted again to effect a settlement; and Olinda, with its port, the Recife-Olinda, was destroyed, but the Recife was fortified and held, reinforcements and supplies being sent by sea from Holland. The Dutch were unable, however, to extend their power beyond the limits of the town, until the arrival of

Count John Maurice of Nassau-Siegen in 1636. His first step was to introduce a regular government among his countrymen; his second, to send to the African coast one of his officers, who took possession of a Portuguese settlement, and thus secured a supply of slaves. In the course of eight years, the limited period of his government, he succeeded in asserting the Dutch supremacy along the coast of Brazil from the mouth of São Francisco to Maranhão. The Recife was rebuilt and adorned with splendid residences and gardens and received from its founder the name of Mauristad. He promoted the amalgamation of the different races, and sought to conciliate the Portuguese by the confidence he reposed in them. His object was to found a great empire; but this was a project at variance with the wishes of his employers—an association of merchants, who were dissatisfied because the wealth which they expected to see flowing into their coffers was expended in promoting the permanent interests of a distant country. Count Maurice resigned his post in 1644. His successors possessed neither his political nor his military talents, and had to contend with more difficult circumstances.

In 1640 the revolution which placed the house of Braganza on the throne of Portugal restored Brazil to masters more inclined to promote its interests and assert its possession than the Spaniards. It was indeed high time that some exertion should be made. The northern provinces had fallen into the power of Holland; the southern, peopled in a great measure by the hardy descendants of the successive colonists who had issued on all sides from the central establishment of São Paulo, had learned from their habits of unaided and successful enterprise to court independence. They had ascended the waters of the Paraguay to their sources.

They had extended their limits southwards till they reached the Spanish settlements of La Plata. They had reduced to slavery numerous tribes of the natives. They were rich in cattle, and had commenced the discovery of the mines. When, therefore, the inhabitants of São Paulo saw themselves about to be transferred, as a dependency of Portugal, from one master to another, they conceived the idea of erecting their country into an independent state. Their attempt, however, was frustrated by Amador Bueno, the person whom they had selected for their king. When the people shouted "Long live King Amador," he cried out "Long live John IV.," and took refuge in a convent. The multitude, left without a leader, acquiesced, and this important province was secured to the house of Braganza.

Rio and Santos, although both evinced a desire of independence, followed the example of the Paulistas. Bahia, as capital of the Brazilian states, felt that its ascendancy depended upon the union with Portugal. The government, thus left in quiet possession of the rest of Brazil, had time to concentrate its attention upon the Dutch conquests. The crown of Portugal was, however, much too weak to adopt energetic measures. But the Brazilian colonists, now that the mother country had thrown off the Spanish yoke, determined even without assistance from the homeland to rise in revolt against foreign domination. The departure of Count Maurice, moreover, had seriously weakened the position of the Dutch, for his successors had neither his conciliatory manners nor his capacity.

João Fernandes Vieyra, a native of Madeira, organized the insurrection which broke out in 1645. This insurrection gave birth to one of those wars in which a whole nation, destitute of pecuniary resources, military organization and skillful leaders, but familiar with the country, is opposed to a handful of soldiers advantageously posted and well officered. But home difficulties and financial necessities prevented the West India Company from sending adequate reinforcements from Holland. In 1649 a rival company was started in Portugal known as the Brazil Company, which sent out a fleet to help the colonists in Pernambuco. Slowly the Dutch lost ground and the outbreak of war with England sounded the knell of their dominion in Brazil. In 1654 their capital and last stronghold fell into the hands of Vieyra. It was not, however, till 1662 that Holland signed a treaty with Portugal, by which all territorial claims in Brazil were abandoned in exchange for a cash indemnity and certain commercial privileges. After this, except some incursions on the frontiers, the only foreign invasion which Brazil had to suffer was from France. In 1710 a squadron, commanded by Duclerc, disembarked 1000 men, and attacked Rio de Janeiro. After having lost half of his men in a battle, Duclerc and all his surviving companions were made prisoners. The governor treated them cruelly. A new squadron with 6000 troops was entrusted to the famous admiral Duguay Trouin to revenge this injury. They arrived at Rio on the 12th of September 1711. After four days of hard fighting the town was taken. The governor retreated to a position out of it, and was only awaiting reinforcements from Minas to retake it; but, Duguay Trouin threatening to burn it, he was obliged on the 10th of October to sign a capitulation, and pay to the French admiral 610,000 crusados, 500 cases of sugar, and provisions for the return of the fleet to Europe. Duguay Trouin departed to Bahia to obtain fresh spoils; but having lost in a storm two of his best ships, with an important part of the money received, he renounced this plan and returned directly to France.

After this the Portuguese governed their colony undisturbed. The approach of foreign traders was prohibited, while the regalities reserved by the crown drained the country of a great proportion of its wealth.

The important part which the inhabitants of São Paulo have played in the history of Brazil has been already adverted to. The establishment of the Jesuit college had attracted settlers to its neighbourhood, and frequent marriages had taken place between the Indians of the district and the colonists. A hardy and enterprising race of men had sprung from this mixture,

English
and
French
aggrava-
tions.

Struggle
with the
Dutch.

Dutch
settlement
in Brazil.

Revolt
against
the Dutch.

French
expedition
to Brazil.
1710.

who, first searching whether their new country were rich in metals, soon began adventurous raids into the interior, making excursions also against the remote Indian tribes with a view to obtaining slaves, and from the year 1620 onwards repeatedly attacked the Indian reductions of the Jesuits in Paraguay, although both provinces were then nominally subject to the crown of Spain. Other bands penetrated into Minas and still farther north and westward, discovering mines there and in Goyaz and Cuyabá. New colonies were thus formed round those districts in which gold had been found, and in the beginning of the 18th century five principal settlements in Minas Geraes had been elevated by royal charter to the privileges of towns. In 1720 this district was separated from São Paulo, to which it had previously been dependent. As early as 1618 a code of laws for the regulation of the mining industry had been drawn up by Philip III., the executive and judicial functions in the mining districts being vested in a *provedor*, and the fiscal in a treasurer, who received the royal fifths and superintended the weighing of all the gold, rendering a yearly account of all discoveries and produce. For many years, however, these laws were little more than a dead letter. The same infatuated passion for mining speculation which had characterized the Spanish settlers in South America now began to actuate the Portuguese; labourers and capital were drained off to the mining districts, and Brazil, which had hitherto in great measure supplied Europe with sugar, sank before the competition of the English and French. A new source of wealth was now opened up; some adventurers from Villa do Principe in Minas, going north to the Seria Frio, made the discovery of diamonds about the year 1710, but it was not till 1730 that the discovery was for the first time announced to the government, which immediately declared them *regalia*. While the population of Brazil continued to increase, the moral and intellectual culture of its inhabitants was left in great measure to chance; they grew up with those robust and healthy sentiments which are engendered by the absence of false teachers, but with a repugnance to legal ordinances, and encouraged in their ascendancy over the Indians to habits of violence and oppression. The Jesuits from the first moment of their landing in Brazil had constituted themselves the protectors of the natives, and though strenuously opposed by the colonists and ordinary clergy, had gathered the Indians together in many *aldeas*, over which officials of their order exercised spiritual and temporal authority. A more efficacious stop, however, was put to the persecution of the Indians by the importation of large numbers of negroes from the Portuguese possessions in Africa, these being found more active and serviceable than the native tribes.

The Portuguese government, under the administration of Carvalho, afterwards marquis of Pombal, attempted to extend to Brazil the bold spirit of innovation which directed all his efforts. The proud minister had been resisted in his plans of reform at home by the Jesuits, and determining to attack the power of the order, first deprived them of all temporal power in the state of Maranhão and Pará. These ordinances soon spread to the whole of Brazil, and a pretext being found in the suspicion of Jesuit influence in some partial revolts of the Indian troops on the Rio Negro, the order was expelled from Brazil under circumstances of great severity in 1760. The Brazilian Company founded by Vieira, which so materially contributed to preserve its South American possessions to Portugal, had been abolished in 1721 by John V.; but such an instrument being well suited to the bold spirit of Pombal, he established a chartered company again in 1755, to trade exclusively with Maranhão and Pará; and in 1759, in spite of the remonstrance of the British Factory at Lisbon, formed another company for Parahyba and Pernambuco. Pombal's arrangements extended also to the interior of the country, where he extinguished at once the now indefinite and oppressive claims of the original donatories of the captaincies, and strengthened and enforced the regulations of the mining districts. The policy of many of Pombal's measures is more than questionable; but his admission of all races to equal rights in the eye

of the law, his abolition of feudal privileges, and the firmer organization of the powers of the land which he introduced, powerfully co-operated towards the development of the capabilities of Brazil. Yet on the death of his king and patron in 1777, when court intrigue forced him from his high station, he who had done so much for his country's institutions was reviled on all hands.

The most important feature in the history of Brazil during the first thirty years following the retirement of Pombal was the conspiracy of Minas in 1789. The successful issue of the recent revolution of the English colonies in North America had filled the minds of some of the more educated youth of that province; and in imitation, a project to throw off the Portuguese yoke was formed,—a cavalry officer, Silva Xavier, nicknamed *Tiradentes* (tooth-drawer), being the chief conspirator. But the plot being discovered during their activity, the conspirators were banished to Africa, and *Tiradentes*, the leader, was hanged. Thenceforward affairs went on prosperously; the mining districts continued to be enlarged; the trading companies of the littoral provinces were abolished, but the impulse they had given to agriculture remained.

Removed from all communication with the rest of the world except through the mother country, Brazil remained unaffected by the first years of the great revolutionary war in Europe. Indirectly, however, the fate of this isolated country was decided by the consequences of the French Revolution. Brazil is the only instance of a colony becoming the seat of the government of its own mother country, and this was the work of Napoleon.

When he resolved upon the invasion and conquest of Portugal, the prince regent, afterwards Dom John VI., having no means of resistance, decided to take refuge in Brazil. He created a regency in Lisbon, and departed for Brazil on the 29th of November 1807, accompanied by the queen Donna Maria I., the royal family, all the great officers of state, a large part of the nobility and numerous retainers. They arrived at Bahia on the 21st of January 1808, and were received with enthusiasm. The regent was requested to establish there the seat of his government, but a more secure asylum presented itself in Rio de Janeiro, where the royal fugitives arrived on the 7th of March. Before leaving Bahia, Dom John took the first step to emancipate Brazil, opening its ports to foreign commerce, and permitting the export of all Brazilian produce under any flag, the royal monopolies of diamonds and Brazil-wood excepted. Once established in Rio de Janeiro, the government of the regent was directed to the creation of an administrative machinery for the dominions that remained to him as it existed in Portugal. Besides the ministry which had come with the regent, the council of state, and the departments of the four ministries of home, finances, war and marine then existing, there were created in the course of one year a supreme court of justice, a board of patronage and administration of the property of the church and military orders, an inferior court of appeal, the court of exchequer and royal treasury, the royal mint, bank of Brazil, royal printing-office, powder-mills on a large scale, and a supreme military court. The maintenance of the court, and the salaries of so large a number of high officials, entailed the imposition of new taxes to meet these expenses. Notwithstanding this the expenses continued to augment, and the government had recourse to the reprehensible measure of altering the money standard, and the whole monetary system was soon thrown into the greatest confusion. The bank, in addition to its private functions, farmed many of the *regalia*, and was in the practice of advancing large sums to the state, transactions which gave rise to extensive corruption, and terminated some years later in the breaking of the bank.

Thus the government of the prince regent began its career in the new world with dangerous errors in the financial system; yet the increased activity which a multitude of new customers and the increase of circulating medium gave to the trade of Rio, added a new stimulus to the industry of the whole nation.

Portuguese royal family in Brazil, 1807.

Reorganization as Portuguese model.

Numbers of English artisans and shipbuilders, Swedish iron-founders, German engineers and French manufacturers sought fortunes in the new country, and diffused industry by their example.

In the beginning of 1809, in retaliation for the occupation of Portugal, an expedition was sent from Pará to the French colony of Guiana, and after some fighting this part of Guiana was incorporated with Brazil. This conquest was, however, of short duration; for, by the treaty of Vienna in 1815, the colony was restored to France. Its occupation contributed to the improvement of agriculture in Brazil; it had been the policy of Portugal up to this time to separate the productions of its colonies, to reserve sugar for Brazil, and spices to the East Indies, and to prohibit the cultivation of these in the African possessions. Now, however, many plants were imported not only from Guiana but from India and Africa, cultivated in the Royal Botanic Garden, and thence distributed. The same principle which dictated the conquest of French Guiana originated attempts to seize the Spanish colonies of Montevideo and Buenos Aires, Portugal being also at war with Spain. The chiefs of these colonies were invited to place them under the protection of the Portuguese crown, but these at first affecting loyalty to Spain declined the offer, then threw off the mask and declared themselves independent, and the Spanish governor, Elio, was afterwards defeated by Artigas, the leader of the independents.

The inroads made on the frontiers of Rio Grande and São Paulo decided the court of Rio to take possession of Montevideo; a force of 5000 troops was sent thither from Portugal, together with a Brazilian corps; and the irregulars of Artigas, unable to withstand disciplined troops, were forced, after a total defeat, to take refuge beyond the river Uruguay. The Portuguese took possession of the city of Montevideo in January 1817, and the territory of Misiones was afterwards occupied. The importance which Brazil was acquiring decided the regent to give it the title of kingdom, and by decree of the 16th January 1815, the Portuguese sovereignty thenceforward took the title of the United Kingdom of Portugal, Brazil and Algarves. Thus the old colonial government disappeared even in name. In March 1816 the queen Donna Maria I. died, and the prince regent became king under the title of Dom John VI.

Although Brazil had now become in fact the head of its own mother country, the government was not in the hands of Brazilians, but of the Portuguese, who had followed the court. The discontent arising among Brazilians from this cause was heightened by a decree assigning a heavy tax on the chief Brazilian custom houses, to be in operation for forty years, for the benefit of the Portuguese noblemen who had suffered during the war with France. The amiable character of the king preserved his own popularity, but the government was ignorant and profligate, justice was ill administered, negligence and disorder reigned in all its departments. Nor was the discontent less in Portugal on account of its anomalous position. These causes and the fermentation of liberal principles produced by the French Revolution originated a conspiracy in Lisbon in 1817, which was, however, discovered in time to prevent its success. A similar plot and rebellion took place in the province of Pernambuco, where the inhabitants of the important commercial city of Recife (Pernambuco) were jealous of Rio and the sacrifices they were compelled to make for the support of the luxurious court there. Another conspiracy to establish a republican government was promptly smothered in Bahia, and the outbreak in Pernambuco was put down after a republic had been formed there for ninety days. Still the progress of the republican spirit in Brazil caused Dom João to send to Portugal for bodies of picked troops, which were stationed throughout the provincial capitals. In Portugal the popular discontent produced the revolution of 1820, when representative government was proclaimed—the Spanish constitution of 1812 being provisionally adopted. In Rio, the Portuguese troops with which the king had surrounded himself as the defence against the liberal spirit of the Brazilians, took up arms on the 26th of February 1821, to force him to accept

the system proclaimed in Portugal. The prince Dom Pedro, heir to the crown, who now for the first time took part in public affairs, actively exerted himself as a negotiator between the king and the troops, who were joined by bodies of the people. After attempting a compromise the king finally submitted, took the oath and named a new ministry. The idea of free government filled the people with enthusiasm, and the principles of a representative legislature were freely adopted, the first care being for the election of deputies to the Cortes of Lisbon to take part in framing the new constitution. As the king could not abandon Portugal to itself he determined at first to send the prince thither as regent, but Dom Pedro had acquired such popularity by his conduct in the revolution, and had exhibited such a thirst for glory, that the king feared to trust his adventurous spirit in Europe, and decided to go himself. The Brazilian deputies on arriving in Lisbon expressed dissatisfaction with the Cortes for having begun the framing of the constitution before their arrival, for Brazil could not be treated as a secondary part of the monarchy. Sharp discussions and angry words passed between the Brazilian and Portuguese deputies, the news of which excited great discontent in Brazil. An insulting decree was passed in the Cortes, ordering the prince Dom Pedro to come to Europe, which filled the Brazilians with alarm; they foresaw that without a central authority the country would fall back to its former colonial state subject to Portugal. The provisional government of São Paulo, influenced by the brothers Andrada, began a movement for independence by asking the prince to disobey the Cortes and remain in Brazil, and the council of Rio de Janeiro followed with a similar representation, to which the prince assented. The Portuguese troops of the capital at first assumed a coercive attitude, but were forced to give way before the ardour and military preparations of the Brazilians, and submitted to embark for Portugal. These scenes were repeated in Pernambuco, where the Portuguese, after various conflicts, were obliged to leave the country; in Bahia, however, as well as in Maranhão and Pará, the Portuguese prevailed. In Rio the agitation for independence continued. The two brothers Andrada were called to the ministry; and the municipal council conferred upon the prince regent the title of Perpetual Defender of Brazil. With great activity he set off to the central provinces of Minas and São Paulo to suppress disaffected movements and direct the revolution. In São Paulo, on the 7th of September 1822, he proclaimed the independence of Brazil. On his return to Rio de Janeiro on the 12th of October he was proclaimed constitutional emperor with great enthusiasm.

The Cortes at Lisbon chose Bahia as a centre for resisting the independence, and large forces were sent thither. But the city was vigorously besieged by the Brazilians by land, and finally the Portuguese were obliged to re-embark on the 2nd of July 1823. A Brazilian squadron, under command of Lord Cochrane, attacked the Portuguese vessels, embarrassed with troops, and took several of them. Taylor, another Englishman in Brazilian service, followed the vessels across the Atlantic, and even captured some of the ships in sight of the land of Portugal. The troops in Montevideo also embarked for Portugal, and the Banda Oriental remained a part of Brazil with the title of the *Provincia Cisplatina*. Before the end of 1823 the authority of the new emperor and the independence of Brazil were undisputed throughout the whole country.

Republican movements now began to spread, to suppress which the authorities made use of the Portuguese remaining in the country; and the disposition of the emperor to consider these as his firmest supporters much influenced the course of his government and his future destiny. The two Andradas, who imagined they could govern the young emperor as a sovereign of their own creation, encountered great opposition in the constitutional assembly, which had been opened in Rio in May 1823, to discuss the project of a new constitution. In July the emperor resolved to dismiss them and form a new ministry, but against this the brothers raised a violent opposition. In November the emperor put an end to the angry debates which

Brazil declared an integral portion of the monarchy.

Pedro proclaimed the independence of Brazil, 1822.

ensued in the assembly by dissolving it, exiling the Andradas to France, and convoking a new assembly to deliberate on a proposed constitution more liberal than the former project. The proclamation of a republic in the provinces of Pernambuco and Ceará, with the rebellion of the Cisplatina province, favoured by Buenos Aires and its ultimate loss to Brazil, were the result of the *comp d'Etat* of November 1823. The Brazilians were universally discontented—on one side fearing absolutism if they supported the emperor, on the other anarchy if he fell. Knowing the danger of an undefined position, the emperor caused the councils to dispense with their deliberations, and adopt, as the constitution of the empire, the project framed by the council of state. Accordingly, on the 25th of March 1824, the emperor swore to the constitution with great solemnity and public rejoicings. By this stroke of policy he saved himself and Brazil. Negotiations were opened in London between the Brazilian and

Constitution of 1824.

Portuguese plenipotentiaries, treating for the recognition of the independence of Brazil; and on the 25th of August 1825 a treaty was signed by which the Portuguese king, Dom John VI., assumed the title of emperor of Brazil, and immediately abdicated in favour of his son, acknowledging Brazil as an independent empire, but the treaty obliged Brazil to take upon herself the Portuguese debt, amounting to nearly two millions sterling.

The rebellion of the Banda Oriental was followed by a declaration of war with Buenos Aires which had supported it, and operations by sea and land were conducted against that republic in a feeble way. Meanwhile the well-deserved popularity of the emperor began to decline. He had given himself up to the influence of the Portuguese; the most popular men who had worked for the independence were banished; and a continual change of ministry showed a disposition on the part of the sovereign to prosecute obstinately measures of which his advisers disapproved. His popularity was regained, however, to some extent, when, on the death of his father, he was unanimously acknowledged king of Portugal, and especially when he abdicated that crown in favour of his daughter, Donna Maria; but his line of policy was not altered, and commercial treaties entered into with European states conceding them favours, which were popularly considered to be injurious to Brazilian trade, met with bitter censure.

During the year 1827 the public debt was consolidated, and a department was created for the application of a sinking fund.

The year 1828 was a calamitous one for Brazil. It began with the defeat of the Brazilian army by the Argentine forces, and this entirely through the incapacity of the commander-in-chief; and misunderstandings, afterwards compensated by humbling money-payments on the part of Brazil, arose with the United States, France and England on account of merchant vessels captured by the Brazilian squadron blockading Buenos Aires. Financial embarrassments increased to an alarming extent; the emperor was compelled by the British government to make peace with Buenos Aires and to renounce the Banda Oriental; and to fill the sum of disasters Dom Miguel had treacherously usurped the crown of Portugal. It was under these unlucky auspices that the elections of new deputies took place in 1829. As was expected the result was the election everywhere of ultra-liberals opposed to the emperor, and in the succeeding year people everywhere exhibited their disaffection. During the session of 1830 the chambers adopted a criminal code in which punishment by death for political offences was abolished. It was openly suggested in the journals to reform the constitution by turning Brazil into independent federal provinces, governed by authorities popularly elected, as in the United States. Alarmed at length at the ground gained by this idea in the provinces, the emperor set off to Minas to stir up the former enthusiasm in his favour from recollections of the independence, but was coldly received. On his return to Rio in March 1831 scenes of disorder occurred, and great agitation among the Liberal party. Imagining himself sure of a brilliant destiny

in Europe if he lost his Brazilian crown, the emperor attempted to risk a decisive attack against the Liberals, and to form a new ministry composed of men favourable to absolutism. This step caused excited public meetings in the capital, which were joined in by the troops, and deputations went to ask the emperor to dismiss the unpopular ministry. He replied by dissolving the ministry without naming another, and by abdicating the crown in favour of the heir apparent, then only five years of age. Dom Pedro immediately embarked in an English ship, leaving the new emperor Dom Pedro II. and the princesses Januaria, Francisca and Paula. The subsequent career of this unfortunate prince belongs to the history of Portugal.

Abdication of Pedro I., 1831.

A provisional and afterwards a permanent regency, composed of three members, was now formed in Brazil, but scenes of disorder succeeded, and discussions and struggles between the republican party and the government, and a reactionary third party in favour of the restoration of Dom Pedro, occupied the succeeding years. In 1834 a reform which was well received consisted in the alteration of the regency, from that of three members elected by the legislative chambers, to one regent chosen by the whole of the electors in the same manner as the deputies; and the councils of the provinces were replaced by legislative provincial assemblies. Virtually, this was a republican government like that of the United States, for no difference existed in the mode of election of the regent from that of a president. The ex-minister Feijó was chosen for this office. With the exception of Pará and Rio Grande the provinces were at peace, but these were in open rebellion; the former was reduced to obedience, but in the latter, though the imperial troops occupied the town, the country was ravaged by its warlike inhabitants. The regent was now accused of conniving at this rebellion, and the opposition of the chamber of deputies became so violent as to necessitate his resignation. Araujo Lima, minister of the home department, who strove to give his government the character of a monarchical reaction against the principles of democracy, was chosen by a large majority in his stead. The experiment of republican government had proved so discreditable, and had so wearied the country of cabals, that men hitherto known for their sympathy with democratic principles became more monarchical than the regent himself; and under this influence a movement to give the regency into the hands of the princess Donna Januaria, now in her 18th year, was set on foot. It was soon perceived, however, that if the empire could be governed by a princess of eighteen it could be managed better by the emperor himself, who was then fourteen.

A bill was accordingly presented to the legislature dispensing with the age of the emperor and declaring his majority, which after a noisy discussion was carried. The majority of the emperor Dom Pedro II. was proclaimed on the 23rd of July 1840. Several ministries, in which various parties predominated for a time, now governed the country till 1848, during which period the rebellious province of Rio Grande was pacified, more by negotiation than force of arms. In 1848 hostilities were roused with the British government through the neglect shown by the Brazilians in putting in force a treaty for the abolition of the slave trade, which had been concluded as far back as 1826; on the other hand the governor of Buenos Aires, General Rosas, was endeavouring to stir up revolution again in Rio Grande. The appearance of yellow fever in 1849, until then unknown in Brazil, was attributed to the importation of slaves. Public opinion declared against the traffic; severe laws were passed against it, and were so firmly enforced that in 1853 not a single disembarkation took place. The ministry of the Visconde de Olinda in 1849 entered into alliances with the governors of Montevideo, Paraguay and the states of Entre Rios and Corrientes, for the purpose of maintaining the integrity of the republics of Uruguay and Paraguay, which Rosas intended to reunite to Buenos Aires, and the troops of Rosas which besieged Montevideo were forced to capitulate. Rosas then declared war formally against Brazil. An army of Correntine, Uruguayan and Brazilian troops, under

Majority of Pedro II., 1840.

General Urquiza, assisted by a Brazilian naval squadron, advanced on Buenos Aires, completely routed the forces of Rosas, and crushed for ever the power of that dictator. From 1844 Brazil was free from intestine commotions, and had resumed its activity. Public works and education were advanced, and the finances rose to a degree of prosperity previously unknown.

In 1855 the emperor of Brazil sent a squadron of eleven men-of-war and as many transports up the Paraná to adjust several questions pending between the empire and the republic of Paraguay, the most important of which was that of the right of way by the Paraguay river to the interior Brazilian province of Matto Grosso. This right had been in dispute for several years. The expedition was not permitted to ascend the river Paraguay, and returned completely foiled in its main purpose. Though the discord resulting between the states on account of this failure was subsequently allayed for a time by a treaty granting to Brazil the right to navigate the river, every obstacle was thrown in the way by the Paraguayan government, and indignities of all kinds were offered not only to Brazil but to the representatives of the Argentine and the United States. In 1864 the ambitious dictator of Paraguay, Francisco Solano Lopez, without previous declaration of war, captured a Brazilian vessel in the Paraguay, and rapidly followed up this outrage by an armed invasion of the provinces of Matto Grosso and Rio Grande in Brazil, and that of Corrientes in the Argentine Republic. A triple alliance of the invaded states with Uruguay ensued, and the tide of war was soon turned from being an offensive one on the part of Paraguay to a defensive struggle within that republic against the superior number of the allies. So strong was the natural position of Paraguay, however, and so complete the subjection of its inhabitants to the will of the dictator, that it was not until the year 1870, after the republic had been completely drained of its manhood and resources, that the long war was terminated by the capture and death of Lopez with his last handful of men by the pursuing Brazilians. From its duration and frequent battles and sieges this war involved an immense sacrifice of life to Brazil, the army in the field having been constantly maintained at between 20,000 and 30,000 men, and the expenditure in maintaining it was very great, having been calculated at upwards of fifty millions sterling. Large deficits in the financial budgets of the state resulted, involving increased taxation and the contracting of loans from foreign countries.

Notwithstanding this the sources of public wealth in Brazil were unaffected, and commerce continued steadily to increase. A grand social reform was effected in the law passed in September 1871, which enacted that from that date every child born of slave parents should be free, and also declared all the slaves belonging to the state or to the imperial household free from that time. The same law provided an emancipation fund, to be annually applied to the ransom of a certain number of slaves owned by private individuals.

Under the long reign of Dom Pedro II. progress and material prosperity made steady advancement in Brazil. Occasional political outbreaks occurred, but none of very serious nature except in Rio Grande do Sul, where a long guerrilla warfare was carried on against the imperial authority. The emperor occupied himself to a far greater extent with the economic development of his people and country than with active political life. Unostentatious in his habits, Dom Pedro always had at heart the true interests of the Brazilians. Himself a highly-educated man, he sincerely desired to further the cause of education, and devoted a large portion of his time to the study of this question. His extreme liberalism prevented his opposing the spread of Socialist doctrines preached far and wide by Benjamin Constant. Begun about 1880, this propaganda took deep root in the educated classes, creating a desire for change and culminating in the military conspiracy of November 1889, by which monarchy was replaced by a republican form of government.

At first the revolutionary propaganda produced no personal animosity against the emperor, who continued to be treated by

his people with every mark of respect and affection, but this state of things gradually changed. In 1864 the princess Isabella, the eldest daughter of the emperor and empress, had married the Comte d'Eu, a member of the Orleans family. The marriage was never popular in the country, owing partly to the fact that the Comte d'Eu was a reserved man who made few intimate friends and never attempted to become a favourite. Princess Isabella was charitable in many ways, always ready to take her full share of the duties falling upon her as the future empress, and thoroughly realizing the responsibilities of her position; but she was greatly influenced by the clerical party and the priesthood, and she thereby incurred the hostility of the Progressives. When Dom Pedro left Brazil for the purpose of making a tour through Europe and the United States he appointed Princess Isabella to act as regent, and she showed herself so swayed in political questions by Church influence that Liberal feeling became more and more anti-dynastic. Another incident which gave strength to the opposition was the sudden abolition of slavery without any compensation to slave-owners. The planters, the principal possessors of wealth, regarded the measure as unnecessary in view of the act which had been passed in 1885 providing for the gradual freeing of all slaves. The arguments used were, however, of no avail with the regent, and the decree was promulgated on the 13th of May 1888. No active opposition was offered to this measure, but the feelings of unrest and discontent spread rapidly.

Towards the close of 1888 the emperor returned and was received by the populace with every demonstration of affection and esteem. Even among the advocates of republicanism there was no intention of dethroning Dom Pedro, excepting a few extreme members of the party, who now gained the upper hand. They argued that it would be much more difficult to carry out a successful *coup d'état* when the good-natured, confiding emperor had been succeeded by his more suspicious and energetic daughter. Discontented officers in the army and navy rallied to this idea, and a conspiracy was organized to depose the emperor and declare a republic. On the 14th of November 1889 the palace was quietly surrounded, and on the following morning the emperor and his family were placed on board ship and sent off to Portugal. A provisional government was then formed and a proclamation issued to the effect that the country would henceforth be known as the United States of Brazil, and that in due time a republican constitution would be framed. The only voice raised in protest was that of the minister of war, and he was shot at and severely wounded as a consequence. Dom Pedro, completely broken down by the ingratitude of the people whom he had loved so much and laboured for so strenuously, made no attempt at resistance. The republican government offered to compensate him for the property he had held in Brazil as emperor, but this proposal was declined. His private possessions were respected, and were afterwards still held by Princess Isabella.

The citizen named as president of the provisional government was General Deodoro da Fonseca, who owed his advancement to the personal friendship and assistance of Dom Pedro. Second in authority was placed General Floriano Peixoto, an officer also under heavy obligations to the deposed monarch, as indeed were nearly all of those who took active part in the conspiracy.

Though the overthrow of the imperial dynasty was totally unexpected throughout, the new regime was accepted without any disturbances. Under the leadership of General Deodoro da Fonseca a praetorian system of government, in which the military element was all-powerful, came into existence, and continued till February 1891, when a national congress assembled and formulated the constitution for the United States of Brazil. The former provinces were converted into states, the only right of the federal government to interfere in their administration being for the purposes of national defence, the maintenance of public order or the enforcement of the federal laws. The constitution of the United States of America was taken as a model for drawing up that of Brazil,

War with Paraguay.

Establishment of the Republic, 1889.

Character of Pedro II.'s reign.

Strife under the Republic.

and the general terms were as far as possible adhered to (see above, section *Government*).

General da Fonseca and General Floriano Peixoto were elected to fill the offices of president and vice-president until the 15th of November 1894. This implied the continuance of praetorian methods of administration. The older class of more conservative Brazilians, who had formerly taken part in the administration under the emperor, withdrew altogether from public life. Many left Brazil and went into voluntary exile, while others retired to their estates. In the absence of these more respectable elements, the government fell into the hands of a gang of military adventurers and unscrupulous politicians, whose only object was to exploit the national resources for their own benefit. As a consequence, deep-rooted discontent rapidly arose. A conspiracy, of which Admiral Wandenkolk was the prime instigator, was discovered, and those who had taken part in it were banished to the distant state of Amazonas. Disturbances then broke out in Rio Grande do Sul, in consequence of disputes between the official party and the people living in the country districts. Under the leadership of Gumercindo Saraiva the country people broke into open revolt in September 1891. This outbreak was partially suppressed, but afterwards it again burst into flame with great vigour. In view of the discontent, conspiracies and revolutionary movements, President da Fonseca declared himself dictator. This act, however, met with such strong opposition that he resigned office on the 23rd of November 1891, and Vice-President Floriano Peixoto assumed the presidency.

Floriano Peixoto had been accustomed all his life to use harsh measures. For the first year of his term of office he kept seditious attempts in check, but discontent grew apace. Nor was this surprising to those who knew the corruption in the administration. Concessions and subsidies were given broadcast for worthless undertakings in order to benefit the friends of the president. Brazilian credit gave way under the strain, and evidences were not wanting at the beginning of 1893 that an outburst of public opinion was not far distant. Nevertheless President Peixoto made no effort to reform the methods of administration. Meanwhile, the revolution in Rio Grande do Sul had revived; and in July 1893 the federal government was forced to send most of the available regular troops to that state to hold the insurgents in check.

On the 6th of September prevailing discontent took definite shape in the form of a naval revolt in the Bay of Rio de Janeiro. Admiral Custodio de Mello took command of the naval forces, and demanded the resignation of the president. Naval revolt and civil war: 1894. General Peixoto replied by organizing a defence against any attack from the squadron. Admiral Mello, finding that his demands were not complied with, began a bombardment of the city, but did not effect his purpose of compelling Peixoto to resign. The foreign ministers then arranged a compromise between the contending parties, according to which President Peixoto was to place no artillery in the city, while Admiral Mello was to refrain from bombarding the town, which was thus saved from destruction. Shortly afterwards the cruiser "Republica" and a transport ran the gauntlet of the government forts at the entrance of the bay, and proceeded south to the province of Santa Catharina, taking possession of Desterro, its capital. A provisional government was proclaimed by the insurgents, with headquarters at Desterro, and communication was opened with Gumercindo Saraiva, the leader of the insurrection in Rio Grande do Sul. It was proposed that the army of some 10,000 men under his command should advance northwards towards Rio de Janeiro, while the insurgent squadron threatened the city of Rio. In November Admiral Mello left Rio de Janeiro in the armoured cruiser "Aquidaban" and went to Desterro, the naval forces in Rio Bay being left in charge of Admiral Saldanha da Gama, an ardent monarchist, who had thrown in his lot with the insurgent cause. All was, apparently, going well with the revolt, Saraiva having invaded the states of Santa Catharina and Paraná, and defeated the government troops in several encounters. Mean-

while, President Peixoto had fortified the approaches to the city of Rio de Janeiro, bought vessels of war in Europe and the United States and organized the National Guard.

Early in 1894 dissensions occurred between Saraiva and Mello, which prevented any advance of the insurgent forces, and allowed Peixoto to perfect his plans. Admiral da Gama, unable to leave the Bay of Rio de Janeiro on account of lack of transport for the sick and wounded and the civilians claiming his protection, could do no more than wait for Admiral Mello to return from Desterro. In the meantime the ships bought by President Peixoto arrived off Rio de Janeiro and prevented da Gama from escaping. On the 15th of March 1894 the rebel forces evacuated their positions on the islands of Villegaignon, Cobras and Enxadas, abandoned their vessels, and were received on board two Portuguese warships then in the harbour, whence they were conveyed to Montevideo. The action of the Portuguese commander was prompted by a desire to save life, for had the rebels fallen into the hands of Peixoto, they would assuredly have been executed.

When the news of the surrender of Saldanha da Gama reached Gumercindo Saraiva, then at Curitiba in Paraná, he proceeded to retire to Rio Grande do Sul. Government troops were despatched to intercept his retreat, and in one of the skirmishes which followed Saraiva was killed. The rebel army then dispersed. Admiral Mello made an unsuccessful attack on the town of Rio Grande, and then sailed to Buenos Aires, there surrendering the rebel squadron to the Argentine authorities, by whom it was immediately delivered to the Brazilian government. After six months of civil war peace was once more established, but there still remained some small rebel groups in Rio Grande do Sul. These were joined by Admiral da Gama and a number of the naval officers, who had escaped from Rio de Janeiro; but in June 1895 the admiral was killed in a fight with the government troops. After the cessation of hostilities, the greatest barbarities were practised upon those who, although they had taken no part in the insurrection, were known to have desired the overthrow of President Peixoto. The baron Cerro Azul was shot down without trial; Marshal de Gama Eza, an old imperial soldier of eighty years of age, was murdered in cold blood, and numerous executions of men of lesser note took place, among these being two Frenchmen for whose death the Brazilian government was subsequently called upon to pay heavy compensation.

General Peixoto was succeeded as president on the 15th of November 1894 by Dr Prudente de Moraes Barros. It was a moot question whether Peixoto, after the revolt was crushed, would not declare himself dictator; certainly many of his friends were anxious that he should follow this course, but he was broken down by the strain which had been imposed upon him and was glad to surrender his duties. He did not recover his health and died shortly afterwards.

From the first day that he assumed office, President Moraes showed that he intended to suppress praetorian systems and reduce militarism to a minimum. This policy received the approval and sympathy of the majority of Brazilians; but naturally met with bitter opposition from the military element. The president gradually drew to him some members of the better conservative class to assist in his administration, and felt confident that he had the support of public opinion. Early in 1895 murmurings and disorderly conduct against the authorities began to take place in the military school at Rio de Janeiro, which had always been a hotbed of intrigue. Some of the officers and students were promptly expelled, and the president closed the school for several months. This salutary lesson had due effect, and no more discontent was fomented from that quarter. Two great difficulties stood in the way of steering the country to prosperity. The first was the chaotic confusion of the finances resulting from the maladministration of the national resources since the deposition of Dom Pedro II., and the corruption that had crept into every branch of the public service. Much was done by President Moraes to correct abuses, but the task was of too herculean a nature to allow of accomplishment

within the four years during which he was at the head of affairs. The second difficulty was the war waged by religious fanatics under the leadership of Antonio Maciel, known as "Conselheiro," against the constituted authorities of Brazil.

The story of *Conselheiro* is a remarkable one. A native of Pernambuco, when a young man he married against the wishes of his mother, who took a violent dislike to the bride. Shortly after the marriage the mother assured her son that his wife held clandestine meetings with a lover, and stated that if he would go to a certain spot not far from the house that evening he would himself see that her assertion was true. The mother invented some plea to send the wife to the trysting-place, and then, dressing herself in male clothing, prepared to come suddenly on the scene as the lover, trusting to be able to make her escape before she was recognized. The three met almost simultaneously. *Conselheiro*, deeming his worst suspicions confirmed, shot and killed his wife and his mother before explanations could be offered. He was tried and allowed to go at liberty after some detention in prison. From that time *Conselheiro* was a victim of remorse, and to expiate his sin became a missionary in the *sertão* or interior of Brazil among the wild Jagunço people. He built places of worship in many different districts, and at length became the recognized chief of the people among whom he had thus strangely cast his lot. Eventually he formed a settlement near Canudos, situated about 400 m. inland from Bahia. Difficulty arose between the governor of Bahia and this fanatical missionary, with the result that *Conselheiro* was ordered to leave the settlement and take away his people. This order was met with a sturdy refusal to move. Early in 1897 a police force was sent to eject the settlers, but encountered strong resistance, and suffered heavy loss without being able to effect the purpose intended. In March 1897 a body of 1500 troops, with four guns, was despatched to bring the Jagunços to reason, but was totally defeated. An army comprising some 5000 officers and men was then sent to crush *Conselheiro* and his people at all costs. Little progress was made, the country being difficult of access and the Jagunços laying ambushes at every available place. Finally strong reinforcements were sent forward, the minister of war himself proceeding to take command of the army, now numbering nearly 13,000 men. Canudos was besieged and captured in September 1897, *Conselheiro* being killed in the final assault. The expense of these expeditions was very heavy, and prevented President Moraes from carrying out many of the retrenchments he had planned.

Soon after the Canudos affair a conspiracy was hatched to assassinate the president. He was watching the disembarkation of some troops when a shot was fired which narrowly missed him, and killed General Bitencourt, the minister of war. The actual perpetrator of the deed, a soldier, was tried and executed, but he was apparently ignorant of the persons who procured his services. Three other men implicated in the conspiracy were subsequently sentenced to imprisonment for a term of thirty years. The remainder of the presidency of Dr Moraes was uneventful; and on the 15th of November 1898 he was succeeded by Dr Campos Salles, who had previously been governor of the state of São Paulo. President Salles publicly promised political reform, economy in the administration, and absolute respect for civil rights, and speedily made efforts to fulfil these pledges.

The difficulties in the reorganization of the finances of the state, which Dr Campos Salles had to face on his accession to power, were very great. The heavy cost involved in the suppression of internal disorders, maladministration, and the hindrances placed in the way of economical development by the semi-independence of the federal states had seriously depreciated the national credit. The president-elect accordingly undertook with the full approval of Dr Moraes, who was still in office, the task of visiting Europe with the object of endeavouring to make an arrangement with the creditors of the state for a temporary suspension of payments. He was successful in his object, and an agreement was made by which bonds should be issued instead of interest payments from the 1st of July 1898, the promise being given that every

effort should be made for the resumption of cash payments in 1901. President Campos Salles entered upon his tenure of office on the 15th of November 1898, and at once proceeded to initiate fiscal legislation for the purpose of reducing expenditure and increasing the revenue. He had to face opposition from sectional interests and from the jealousy of interference with their rights on the part of provincial administrations, but he was able to achieve a considerable measure of success and to lay the foundation of a sounder system under which the financial position of the republic has made steady progress. The chief feature of the administration of Dr Campos Salles was the statesmanlike ability with which various disputes with foreign powers on boundary questions were seriously taken in hand and brought to a satisfactory and pacific settlement. There had for a long period been difficulties with France with regard to the territory which lay between the mouth of the Amazon and Cayenne or French Guiana. The language of various treaties was doubtful and ambiguous, largely owing to the ignorance of the diplomatists who drew up the articles of the exact geography of the territory in question. Napoleon had forced the Portuguese government to cede to him the northernmost arm of the mouth of the Amazon as the southern boundary of French Guiana with a large slice of the unexplored interior westwards. A few years later the Portuguese had in their turn conquered French Guiana, but had been compelled to restore it at the peace of Paris. The old ambiguity attaching to the interpretation of earlier treaties, however, remained, and in April 1899 the question by an agreement between the two states was referred to the arbitration of the president of the Swiss confederation. The decision was given in December 1900 and was entirely in favour of the Brazilian contention. A still more interesting boundary dispute was that between Great Britain and Brazil, as to the southern frontier line of British Guiana. The dispute was of very old standing, and the settlement by arbitration in 1899 of the acute misunderstanding between Great Britain and Venezuela regarding the western boundary of British Guiana, and the reference to arbitration in that same year of the Franco-Brazilian dispute, led to an agreement being made in 1901 between Brazil and Great Britain for the submission of their differences to the arbitration of the king of Italy. The district in dispute was the site of the fabled Lake Parima and the Golden City of Manoa, the search for which in the early days of European settlement attracted so many adventurous expeditions, and which fascinated the imagination of Raleigh and drew him to his doom. The question was a complicated one involving the historical survey of Dutch and Portuguese exploration and control in the far interior of Guiana during two centuries; and it was not until 1904 that the king of Italy gave his award, which was largely in favour of the British claim, and grants to British Guiana access to the northern affluents of the Amazon. Before this decision was given Senhor Rodrigues Alves had been elected president in 1902. Dr Campos Salles had signaled his administration, not only by the settlement of disputes with European powers, but by efforts to arrive at a good understanding with the neighbouring South American republics. In July 1899 President Roca had visited Rio de Janeiro accompanied by an Argentine squadron, this being the first official visit that any South American president had ever paid to one of the adjoining states. In October 1900 Dr Campos Salles returned the visit and met with an excellent reception at Buenos Aires. The result was of importance, as it was known that Brazil was on friendly terms with Chile, and this interchange of courtesies had some effect in bringing about a settlement of the controversy between Chile and Argentina over the Andean frontier question without recourse to hostilities. This was indeed a time when questions concerning boundaries were springing up on every side, for it was only through the moderation with which the high-handed action of Bolivia in regard to the Acre rubber-producing territory was met by the Brazilian government that war was avoided. Negotiations were set on foot, and finally by treating the matter in a give-and-take spirit a settlement was reached and a treaty for an amicable exchange of territories

Reforms under president Campos Salles.

in the district in question, accompanied by a pecuniary indemnity, was signed by President Alves at Petropolis on the 17th of November 1903. During the remainder of the term of this president internal and financial progress were undisturbed save by an outbreak in 1904 in the Cunani district, the very portion of disputed territory which had been assigned to Brazil by the arbitration with France. This province, being difficult of access, was able for a time to assert a practical independence. In 1906 Dr Afonso Penna, three times minister under Pedro II., and at that time governor of the state of Minas-Geraes, of which he had founded the new capital, Belo Horizonte, was elected president, a choice due to a coalition of the other states against São Paulo, to which all the recent presidents had belonged. Penna's presidency was distinguished by his successful efforts to place the finances on a sound basis. He died in office on the 14th of June 1909.

(K. J.; C. E. A.; G. E.)
BIBLIOGRAPHY.—History: Capistrano de Abreu, *Descobrimiento do Brazil e seu desenvolvimento no seculo xix.* (Rio de Janeiro, 1883); John Armitage, *History of Brazil from 1808 to 1831* (2 vols., London, 1836); Moreira de Azevedo, *Historia do Brazil de 1831 a 1890* (Rio de Janeiro, 1841); V. L. Basil, *L'Empire du Brésil* (Paris, 1862); Caspar Barlaeus, *Kerum per octennium in Brasiliâ . . . sub praefectura Mauritiâ Nassovii . . . historia* (Amsterdam, 1647); F. S. Constance, *Historia do Brazil* (Pernambuco, 1843); Anfonso Fialho, *Historia d'estabelecimento da republica "Estados Unidos do Brazil"* (Rio de Janeiro 1890); P. Gaffarel, *Histoire du Brésil français* (Paris, 1878); E. Grosse, *Dom Pedro I.* (Leipzig, 1836); E. Levasseur, *L'Abolition de l'esclavage en Brésil* (Paris, 1888); J. M. de Macedo, *Anno biographico brasileiro* (3 vols., Rio de Janeiro, 1876); A. J. Mello Moraes, *Brasil historico* (4 vols., Rio de Janeiro, 1839); *Chorographia historica, chronographica geneologica, nobilitaria e politica do Brazil* (5 vols., Rio de Janeiro, 1858-1863); *A Independencia e o Imperio do Brazil* (Rio de Janeiro, 1877); B. Mosse, *Dom Pedro II., imperador do Brazil* (Paris, 1889); P. Netscher, *Les Hollandais au Brésil* (Hague, 1853); J. M. Pereira da Silva, *Varões illustres do Brazil* (2 vols., Paris, 1888); *Historia da fundação do imperio brasileiro* (Rio de Janeiro, 1877); *Segundo Período do reinado de D. Pedro I.* (Paris, 1875); *Historia do Brazil de 1831 a 1890* (Rio de Janeiro, 1888); J. P. Oliveira Martins, *O Brazil e as colonias Portuguezas* (Lisbon, 1888); S. da Rocha Pitta, *Historia da America Portuguesa* (Lisbon, 1730); C. da Silva, *L'Oyapock et l'Amazonie* (2 vols., Paris, 1861); R. Southey, *History of Brazil* (3 vols., London, 1810-1819); J. B. Spix and C. F. von Martius, *Reise in Brasilien, 1817-1820* (3 parts, Munich, 1823-1831); F. A. de Varnhagen, *Historia geral do Brazil* (2 vols., Rio de Janeiro, 1877); *Historia das luctas com os Hollandeses* (Vienna, 1871); C. E. Akers, *Hist. of South America, 1654-1904* (1904); *the Revista trimestral do Instituto Historico e Geographico do Brazil* (1839-1908), one or two volumes annually, is a storehouse of papers, studies and original documents bearing on the history of Brazil.

Geography, &c.: Elisée Reclus, *Universal Geography* (1875-1894), vol. xii, pp. 77-291; J. E. Wappaus, *Geographica physica do Brazil* (Rio de Janeiro, 1884); A. Moreira Pinto, *Chorographia do Brazil* (5th ed., Rio de Janeiro, 1895); Therese Prinzessin von Bayern, *Meine Reise indenbrasilianischen Tropen* (Berlin, 1873); M. Lamberg, *Brasilien, Land und Leute* (Leipzig, 1899); L. Hutchinson, *Report on Trade in Brazil* (Washington, 1906); F. Katzer, *Grundzüge der Geologie des unteren Amazonasgebietes* (Leipzig, 1903); J. C. Branner, *A Bibliography of the Geology, Mineralogy and Palaeontology of Brazil* (Rio de Janeiro, 1903); J. W. Evans, "The Rocks of the Cataracts of the River Madeira and the adjoining Portions of the Beni and Mamoré," *Quart. Journ. Geol. Soc.*, London, vol. lxiii., 1906, pp. 88-124, pl. v.

BRAZIL, a city and the county-seat of Clay county, Indiana, U.S.A., situated in the west central part of the state, about 16 m. E. of Terre Haute and about 57 m. W.S.W. of Indianapolis. Pop. (1890) 5905; (1900) 7786 (723 foreign-born); (1910) 9340. It is served by the Central Indiana, the Chicago & Eastern Illinois, the Evansville & Indianapolis and the Vandalia railways, and is connected with Indianapolis, Terre Haute and other cities by an interurban electric line. The principal business thoroughfare is part of the old National Road. Brazil's chief industrial importance is due to its situation in the heart of the "Brazil block" coal (so named because it naturally breaks into almost perfect rectangular blocks) and clay and shale region; among its manufactures are mining machinery and tools, boilers, paving and enamelled building bricks, hollow bricks, tiles, conduits, sewer-pipe and pottery. The municipality owns and operates its water-works. The first settlement here was in 1844; and Brazil was incorporated as a town in 1866, and was chartered as a city in 1873.

BRAZIL NUTS, the seeds of *Bertholletia excelsa*, a gigantic tree belonging to the natural order Lecythidaceae, which grows in the valleys of the Amazons and generally throughout tropical America. The tree attains an average height of 130 ft., having a smooth cylindrical trunk, with a diameter of 14 ft. 50 ft. from the ground, and branching at a height of about 100 ft. The lower portion of the trunk presents a buttressed aspect, owing to the upward extension of the roots in the form of thin prop-like walls surrounding the stem. The fruit of the tree is globular, with a diameter of 5 or 6 in., and consists of a thick hard woody shell, within which are closely packed the seeds which constitute the so-called nuts of commerce. The seeds are triangular in form, having a hard woody testa enclosing the "kernel"; and of these each fruit contains from eighteen to twenty-five. The fruits as they ripen fall from their lofty position, and they are at the proper season annually collected and broken open by the Indians. Brazil nuts are largely eaten; they also yield in the proportion of about 9 oz. to each lb of kernels a fine bland fluid oil, highly valued for use in cookery, and used by watchmakers and artists.

BRAZIL WOOD, a dye wood of commercial importance, obtained from the West Indies and South America, belonging to the genera *Caesalpinia* and *Peltophorum* of the natural order Leguminosae. There are several woods of the kind, commercially distinguished as Brazil wood, Nicaragua or Peach wood, Pernambuco wood and Lima wood, each of which has a different commercial value, although the tinctorial principle they yield is similar. Commercial Brazil wood is imported for the use of dyers in billets of large size, and is a dense compact wood of a reddish brown colour, rather bright when freshly cut, but becoming dull on exposure. The colouring-matter of Brazil wood, brazilin, $C_{12}H_{10}O_2$, crystallizes with $1\frac{1}{2}$ H₂O, and is freely soluble in water; it is extracted for use by simple infusion or decoction of the coarsely-powdered wood. When freshly prepared the extract is of a yellowish tint; but by contact with the air, or the addition of an alkaline solution, it develops a brick-red colour. This is due to the formation of brazilin, $C_{12}H_{11}O_2 \cdot H_2O$, which is the colouring matter used by the dyer. Brazilin crystallizes in hexagonal amber yellow crystals, which are soluble in water and alcohol. The solution when free of oxygen is colourless, but on the access of air it assumes first a yellow and thereafter a reddish yellow colour. With soda-ley it takes a brilliant deep carmine tint, which colour may be discharged by heating in a closed vessel with zinc dust, in which condition the solution is excessively sensitive to oxygen, the slightest exposure to air immediately giving a deep carmine. With tin mordants Brazil wood gives brilliant but fugitive steam reds in calico-printing; but on account of the loose nature of its dyes it is seldom used except as an adjunct to other colours. It is used to form lakes which are employed in tinting papers, staining paper-hangings, and for various other decorative purposes.

BRAZING AND SOLDERING, in metal work, termed respectively hard and soft soldering, are processes which correspond with soldering done at high and at low temperatures. The first embraces jointing effected with soldering mixtures into which copper, brass, or silver largely enter, the second those in which lead and tin are the only, or the principal, constituents. Some metals, as aluminium and cast iron, are less easily soldered than others. Aluminium, owing to its high conductivity, removes the heat from the solder rapidly. Aluminium enters into the composition of most of the solders for these metals, and the "soldering bit" is of pure nickel.

The hard solders are the spelter and the silver solders. Soft spelter solder is composed of equal parts of copper and zinc, melted and granulated and passed through a sieve. As some of the zinc volatilizes the ultimate proportions are not quite equal. The proportion of zinc is increased if the solder is required to be softer or more fusible. A valuable property of the zinc is that its volatilization indicates the fusing of the solder. Silver solder is used for jewelry and other fine metal work, and has the advantage of high fusing points. The hardest contains from 4 parts of silver to 1 of copper; the softest 2 of silver to 1 of

brass wire. Borax is the flux used, with silver solder as with spelter.

The soft solders are composed mainly of tin and lead. They occur in a large range. Common tinner's solder is composed of equal parts of tin and lead, and melts at 370° Fah. Plumber's solder has 2 of lead to 1 of tin. Excess of lead in plumber's solder renders the solder difficult to work, excess of tin allows it to melt too easily. Pewterers add bismuth to render the solder more fusible, e.g. lead 4, tin 3, bismuth 2; or lead 1, tin 2, bismuth 1. Unless these are cooled quickly the bismuth separates out.

The essentials of a soldered joint are the contact of absolutely clean surfaces, free from oxide and dirt. The surfaces are therefore scraped, filed and otherwise treated, and then, in order to cleanse and preserve them from any trace of oxide which might form during subsequent manipulation, a fluxing material is used. The soldering material is compelled to follow the areas prepared for it by the flux, and it will not adhere anywhere else. There is much similarity between soldering and welding in this respect. A weld joint must as a rule be fluxed, or metal will not adhere to metal. There is not, however, the absolute need for fluxing that there is in soldered joints, and many welds in good fibrous iron are made without a flux. But the explanation here is that the metal is brought to a temperature of semifusion, and the shapes of joints are generally such that particles of scale are squeezed out from between the joint in the act of closing the weld. But in brazing and soldering the parts to be united are generally nearly cold, and only the soldering material is fused, so that the conditions are less favourable to the removal of oxide than in welding processes.

Fluxes are either liquid or solid, but the latter are not efficient until they fuse and cover the surfaces to be united. Hydrochloric acid (spirits of salts) is the one used chiefly for soft soldering. It is "killed" by the addition of a little zinc, the resulting chloride of zinc rendering its action quiet. Common fluxes are powdered resin, and tallow (used chiefly by plumbers for wiped joints). These, with others, are employed for soft solder joints, the temperature of which rarely exceeds about 600° Fah. The best flux for zinc is chloride of zinc. For brazed joints, spelter or powdered brass is employed, and the flux is usually borax. The borax will not cover the joint until it has been deprived of its water of crystallization, and this is effected by raising it to a full red heat, when it swells in bulk, "boils," and afterwards sinks quietly and spreads over, or into the joint. There are differences in details of working. The borax is generally powdered and mixed with the spelter, and both with water. But sometimes they are applied separately, the borax first and over this the particles of spelter. Another flux used for copper is sal ammoniac, either alone or mixed with powdered resin.

As brazed joints often have to be very strong, other precautions are frequently taken beyond that of the mere overlapping of the joint edges. In pipes subjected to high steam pressures, and articles subjected to severe stresses, the joints are "cramped" before the solder is applied. That is, the edges are notched in a manner having somewhat the appearance of the dovetails of the carpenter; the notched portions overlap the opposite edges, and on alternate sides. Such joints when brazed are stronger than plain overlapping joints would be. Steam dome coverings are jointed thus longitudinally as cylinders, and the crown is jointed thereto, also by cramping. Another common method of union is that of flanges to copper pipes. In these the pipe passes freely within a hole bored right through the flange, and the solder is run between. The pipe is suspended vertically, flange downwards, and the spelter run in from the back of the flange. The fused borax works its way in by capillary action, and the spelter follows.

The "copper bit" is used in soft soldering. Its end is a prismatic pyramid of copper, riveted to an iron shank in a wooden handle. It is made hot, and the contained heat is sufficient to melt the solder. It has to be "tinned," by being heated to a dull red, filed, rubbed with sal ammoniac, and then rubbed upon the solder. It is wiped with tow before use. For

small brazed work the blow-pipe is commonly employed; large works are done on the brazier's hearth, or in any clear coke fire. If coal is used it must be kept away from the joint.

In "sweating on," a variation in soldering, the surfaces to be united are cleaned, and solder melted and spread over them. They are then brought together, and the temperature raised sufficiently to melt the solder.

A detail of first importance is the essential difference between the melting points of the objects to be brazed or soldered, and that of the solder used. The latter must always be lower than the former. This explains why soldering materials are used in a large range of temperatures. A few will melt at the temperature of boiling water. At the other extreme 3000° Fah. is required to melt a solder for brazing. If this point is neglected, it will often happen that the object to be soldered will fuse before the solder melts. This accident may occur in the soft Britannia and white metals at the one extreme, and in the softer brasses at the other. It would not do, for example, to use flanges of common brass, or even ordinary gun-metal, to be brazed to copper pipe, for they would begin to fuse before the joint was made. Such flanges must be made of nearly pure copper, to withstand the temperature, usually 98 of copper to 2 of tin (brazing metal). A most valuable feature in solder is that by varying the proportions of the metals used a great range in hardness and fusibility is obtainable. The useful solders therefore number many scores. This is also a source of danger, unless regard be had to the relative fusing points of solders, and of the parts they unite.

(J. G. H.)

BRAZZA, PIERRE PAUL FRANÇOIS CAMILLE SAVORGNAN DE, COMTE (1852-1905), French explorer and administrator, founder of French Congo, was born on board ship in the harbour of Rio de Janeiro on the 26th of January 1852. He was of Italian parentage, the family name being de Brazza Savorgnan. Through the instrumentality of the astronomer Secchi he was sent to the Jesuit college in Paris, and in 1868 obtained authorization to enter as a foreigner the marine college at Brest. In the Franco-Prussian War of 1870-71 he took part in the operations of the French fleet. In 1874 when the warship on which he was serving was in the Gabun, Alfred Marche and the marquis de Compiègne arrived at Libreville from an expedition in the lower Ogowé district. Interested in the reports of these travellers, de Brazza conceived the idea of exploring the Ogowé, which he thought might prove to be the lower course of the Lualaba, a river then recently discovered by David Livingstone. Having meantime been naturalized as a Frenchman, de Brazza in 1875 obtained permission to undertake his African scheme, and with the naval doctor, Noel Ballay, he explored the Ogowé river. Penetrating beyond the basin of that river, he discovered the Alima and Likona, but did not descend either stream. Thence turning northwards the travellers eventually regained the coast at the end of November 1878, having left Paris in August 1875. On arrival in Paris, de Brazza learned of the navigation of the Congo by H. M. Stanley, and recognized that the rivers he had discovered were affluents of that stream.

De Brazza was anxious to obtain for France some part of the Congo. The French ministry, however, determined to utilize his energies in another quarter of Africa. Their attention had been drawn to the Niger through the formation of the United African Company by Sir George Goldie (then Mr Goldie Taubman) in July 1879, Goldie's object being to secure Nigeria for Great Britain. A new expedition was fitted out, and de Brazza left Paris at the end of 1879 with orders to go to the Niger, make treaties, and plant French flags. When on the point of sailing from Lisbon he received a telegram cancelling these instructions and altering his destination to the Congo. This was a decision of great moment. Had the Nigerian policy of France been maintained the International African Association (afterwards the Congo Free State) would have had a clear field on the Congo, while the young British Company would have been crushed out by French opposition; so that the two great basins of the Niger and the Congo would have had a vastly different history.

Acting on his new instructions, de Brazza, who was again

accompanied by Ballay, reached the Gabun early in 1880. Rapidly ascending the Ogowé he founded the station of Franceville on the upper waters of that river and pushed on to the Congo at Stanley Pool, where Brazzaville was subsequently founded. With Makoko, chief of the Bateke tribe, de Brazza concluded treaties in September and October 1880, placing the country under French protection. With these treaties in his possession Brazza proceeded down the Congo, and at Isangila on the 7th of November met Stanley, who was working his way up stream concluding treaties with the chiefs on behalf of the International African Association. De Brazza spent the next eighteen months exploring the hinterland of the Gabun, and returned to France in June 1882. The ratification by the French chambers in the following November of the treaties with Makoko (described by Stanley as worthless pieces of paper) committed France to the action of her agent.

Furnished with funds by the French government, de Brazza returned in 1883 to the Congo to open up the new colony, of which he was named commissioner-general in 1886. This post he held until January 1898, when he was recalled. During his period of office the work of exploration was systematically carried out by numerous expeditions which he organized. The incessant demands on the resources of the infant colony for these and other expeditions to the far interior greatly retarded its progress. De Brazza's administration was severely criticized; but that its comparative failure was largely due to inadequate support from the home authorities was recognized in the grant to him in 1902 of a pension by the chambers. Both as explorer and administrator his dealings with the natives were marked by consideration, kindness and patience, and he earned the title of "Father of the Slaves." His efforts to connect the upper Congo with the Atlantic by a railway through French territory showed that he understood the chief economic needs of the colony. After seven years of retirement in France de Brazza accepted, in February 1905, a mission to investigate charges of cruelty to natives brought against officials of the Congo colony. Having concluded his inquiry he sailed for France, but died at Dakar, Senegal, on the 4th of September 1905. His body was taken to Paris for burial, but in 1908 was reinterred at Algiers.

See D. Neuville et Ch. Bréard, *Les Voyages de Savorgnan de Brazza, Ogozé et Congo, 1875-1882* (Paris, 1884), and *Conférences et lettres de P. Savorgnan de Brazza sur ses trois explorations dans l'ouest africain de 1875 à 1886* (Paris, 1887); A. J. Wauters, "Savorgnan de Brazza et la conquête du Congo français," in *Le Mouvement géographique*, vol. xxii., No. 39 (Brussels, 1905). Giacomo or Jacques de Brazza (1859-1883), a younger brother of Savorgnan, and one of the men he employed in the work of exploration, published in collaboration with his companion A. Peclie, *Tre Anni e mezzo nella regione del Congo e dell' Ogozé* (Rome, 1887). (G. T. G.)

BRAZZA (Serbo-Croatian, *Braz*; Lat. *Brattia*), an island in the Adriatic Sea, forming part of Dalmatia, Austria. Pop. (1900) 24,408. With an area of 170 sq. m. Brazza is the largest of the Dalmatian Islands; it is also the most thickly populated, and one of the most fertile. Its closely cultivated surface though ragged and mountainous yields an abundance of olives, figs, almonds and saffron, while its wines are of good quality. The corn-crop, however, barely suffices for three months' food. Other local industries are fishing and silk-worm-rearing. The most important among twenty small villages on the island is Milina (pop. 2579), a steamship station, provided with shipwrights' wharves. The early history of Brazza is obscure. In the first years of the 13th century it was ruled by the piratical counts of Almossa; but after a successful revolt and a brief period of liberty it came under the dominion of Hungary. From 1413 to 1416 it was subject to Ragusa; and in 1420 it passed, with the greater part of Dalmatia, under Venetian sovereignty.

BREACH (Mid. Eng. *breche*, derived from the common Teutonic root *brac*, which appears in "break," Ger. *brechen*, &c.), in general, a breaking, or an opening made by breaking; in law, the infringement of a right or the violation of an obligation or duty. The word is used in various phrases: *breach of close*, the unlawful entry upon another person's land (see **TRESPASS**); *breach of covenant or contract*, the non-fulfilment of an agreement either to do or not to do some act (see **DAMAGES**); *breach of the*

peace, a disturbance of the public order (see **PEACE, BREACH OF**); *breach of pound*, the taking by force out of a pound things lawfully impounded (see **POUND**); *breach of promise of marriage*, the non-fulfilment of a contract mutually entered into by a man and a woman that they will marry each other (see **MARRIAGE**); *breach of trust*, any deviation by a trustee from the duty imposed upon him by the instrument creating the trust (q.v.).

BREAD, the name given to the staple food-product prepared by the baking of flour. The word itself, O. Eng. *bræd*, is common in various forms to many Teutonic languages; cf. Ger. *Brot*, Dutch, *brood*, and Swed. and Dan. *brød*; it has been derived from the root of "brew," but more probably is connected with the root of "break," for its early uses are confined to "broken pieces, or bits" of bread, the Lat. *frustum*, and it was not till the 12th century that it took the place, as the generic name of bread, of *hlaif*, "loaf," which appears to be the oldest Teutonic name, cf. Old High Ger. *hleib*, and modern Ger. *Laib*.

History.—Bread-baking, or at any rate the preparation of cakes from flour or parched grain by means of heat, is one of the most ancient of human arts. At Wangen and Robenhausen have been found the calcined remains of cakes made from coarsely-ground grain in Swiss lake-dwellings that date back to the Stone Age. The cakes were made of different kinds of grain, barley and one-grained wheat (*Triticum monococcum*) being among the ingredients. This bread was made, not from fine meal, but from grain crushed between some hard surfaces, and in these lake-dwellings many round-shaped stones have been found, which were evidently used for pounding or crushing grain against the surface, more or less concave, of another stone (see **FLOUR AND FLOUR MANUFACTURE**). Perhaps the earliest form of bread, if that word may be used, was prepared from acorns and beech nuts. To this day a sort of cake prepared from crushed acorns is eaten by the Indians of the Pacific slopes. The flour extracted from acorns is bitter and unfit to eat till it has been thoroughly soaked in boiling water. The saturated flour is squeezed into a kind of cake and dried in the sun. Pliny speaks of a similar crude process in connexion with wheat; the grain was evidently pounded, and the crushed remnant, soaked into a sort of pulp, then made into a cake and dried in the sun. Virgil (*Georgics*, i. 267) refers to the husbandman first torrefying and then crushing his grain between stones:—"Nunc torrete igni fruges, nunc frangite saxo."

The question naturally arises, how did the lake-dwellers bake their cakes of bruised grain? Probably the dough was laid on a flat or convex-shaped stone, which was heated, while the cake was covered with hot ashes. Stones have been found among prehistoric remains which were apparently used for this purpose. In ancient Egyptian tombs cakes of durra have been found, of concave shape, suggesting the use of such baking-slabs; here the cake was evidently prepared from coarsely-cracked grain. In primitive times milling and baking were twin arts. The housewife, and the daughters or handmaids, crushed or ground the grain and prepared the bread or cakes. When Abraham entertained the angels unawares (*Genesis* xviii.) he bade his wife Sarah "make ready quickly three measures of fine meal, knead it, and make cakes upon the hearth." Professor Maspero says that an oven for baking bread was to be found in the courtyard of every house in Chaldaea; close by were kept the grinding stones. That bread prepared by means of leaven was known in the days of the patriarchs may be fairly inferred from the passage in *Genesis* iii., where it is said of Lot that he "made a feast, and did bake unleavened bread." Whether the shew-bread of the Jewish tabernacle was leavened is an open question, but it is significant that the Passover cakes eaten by Jews to-day, known as Matzos, are innocent of leaven. Made from flour and water only, they are about 12 in. in diameter, and have somewhat the look of water biscuits.

The ancient Egyptians carried the art of baking to high perfection. Herodotus remarks of them, "dough they knead with their feet, but clay with their hands." The practice of using the feet for dough kneading, however repulsive, long persisted in Scotland, if indeed it is yet defunct. The Egyptians

used for their bread, wheat, spelt, barley and durra (sorghum). In the opinion of Dr Wallis Budge, barley was in Egypt the grain of most primitive culture. However that may be, it is certain that even in ancient Egypt white bread made from wheat was used by the rich. The form of the bread is revealed by ancient monuments. A common shape was a small, round loaf, something like the muffin of to-day. Other loaves were elongated rolls, and curiously enough were sprinkled on the top with seeds like modern Vienna bread.

The history of baking in classical Greece and Italy can be clearly traced. Athenæus in his *Deipnosophists* minutely describes many different kinds of bread, which may be assumed to have been currently used in Greece. According to Pliny (*Nat. Hist.* xviii. 11. § 28) Rome had no public bakers till after the war with Perseus (171-168 B.C.). That long after public bakehouses came into use the Romans and other urban dwellers in Italy continued to make a great deal of bread at home is certain. In Pompeii several private houses had their own mill and bakehouse. That city must also have possessed bakers by trade, as loaves of bread have been found, round in form, and stamped with the maker's name, possibly to fix responsibility for weight and purity. In the time of the Republic, public bakehouses were under the control of the aediles. Grain was delivered to the public granaries by the *Saccarii*, while another body called *Catabolenses* distributed the grain to the bakers. The latter were known as *Pistores* or "pounders," a reminiscence no doubt of the primitive time when grain was pounded by a pestle in a mortar. Slaves were largely employed in the irksome work of grinding, and when Constantine abolished slavery the staff of the *pistrinae* was largely recruited from criminals. The emperor Trajan incorporated about A.D. 100 the college of *Pistores* (millers and bakers), but its members were employers, not operatives. The work of a bakery is depicted in a set of bas-reliefs on the tomb of a master Pistor named Eurysaces, who flourished about a century before the foundation of the college. Here the grain is being brought and paid for; mills driven by horse and ass (or mule) power are busy; men are sieving out the bran from the flour by hand (bolters); bakers are moulding loaves on a board; an oven of domelike shape is being charged by means of a shovel (peel); and baskets of bread are being weighed on the one hand and carried off on men's backs on the other.

Regulation of Sale.—In the middle ages bakers were subjected to special regulations in all European lands. These regulations were supposed to be conceived in the interests of bread consumers, and no doubt were intended to secure fair dealing on the part of bread vendors. The legislators appear, however, to have been unduly biased against the baker, who was often beset by harassing restrictions. Bakers were formed into guilds, which were under the control, not only of their own officials, but of the municipality. In London the bakers formed a brotherhood as early as 1155, and were incorporated in 1307. There were two distinct corporate bodies concerned with bread-making, the Company of White Bakers and the Company of Brown Bakers; these were nominally united in 1509, but the union did not become complete till the middle of the 17th century. In Austria, bakers who offended against police regulations respecting the sale of bread were liable, until comparatively recent times, to fine, imprisonment and even corporal punishment. In Turkey the lot of the baker was very hard. Baron de Tott, writing of Constantinople in the 18th century, says that it was usual, when bread went to famine prices, to hang a baker or two. He would have us believe that it was the custom of master bakers to keep a second hand, who, in consideration of a small increase of his weekly wage, was willing to appear before the *cadi* in case a victim were wanted. A barbarous punishment, inflicted in Turkey and in Egypt on bakers who sold light or adulterated bread, consisted in nailing the culprit by his ear to the door-post of his shop. In France a decree of 1863 relieved bakers from many of the restrictions under which they previously suffered, but it did not touch the powers of the municipalities to regulate the quality and sale of bread. It left them the right conferred

in 1791, to enforce the *taxe du pain*, the object of which was to prevent bakers from increasing the price of bread beyond a point justified by the price of the raw materials; but the right was exercised on their own responsibility, subject to appeal to higher authorities, and by a circular issued in 1863 they were invited to abolish this *taxe officielle*. In places where it exists it is fixed every week or fortnight, according to the average price of grain in the local markets.

In England an act of parliament was passed in 1266 for regulating the price of bread by a public assize, and that system continued in operation till 1822 in the case of the city of London, and till 1836 for the rest of the country. The price of bread was determined by adding a certain sum to the price of every quarter of flour, to cover the baker's expenses and profit; and for the sum so arrived at tradesmen were required to bake and sell eighty quarter loaves or a like proportion of other sizes, which it was reckoned each quarter of flour ought to yield. The acts now regulating the manufacture and sale of bread in Great Britain are one of 1822 (Sale of Bread in the City of London and within 10 m. of the Royal Exchange), and the Bread Act of 1836, as to sale of bread beyond 10 m. of the Royal Exchange. The acts require that bread shall be sold by weight, and in no other manner, under a penalty not exceeding forty shillings. This does not, however, mean that a seller is bound to sell at any particular weight; the words quarter and half-quarter, though commonly used and taken to indicate a 4-lb and 2-lb loaf respectively, have no legal sanction. That is to say, a baker is not bound to sell a loaf weighing either 4 lb or 2; all he has to do, when a customer asks for a loaf, is to put one on the scale, weigh it, and declare the weight. When bread is sold over the counter it is usual for the vendor to cut off and tender a piece of bread to make up any deficiency in the loaf. This is known as the "overweight." There is little doubt the somewhat misty wording of the bread acts lends itself to a good deal of fraudulent dealing. For instance, when bread is sold over the counter, two loaves may be 5 or 6 oz. short, while the piece of makeweight may not reach an ounce. The customer sees the bread put on the scale, but in ninety-nine cases out of a hundred does not trouble to verify the weight, and unless he expressly asks for 2 lb or some specific weight of bread, it is very doubtful whether the seller, having satisfied the letter of the law by placing the bread on the scales, could be convicted of fraud. The provision as to selling by weight does not apply to fancy bread and rolls. No exact definition of "fancy bread" has ever been laid down, and it must be largely a question of fact in each particular case. All bakers or sellers of bread must use avoirdupois weight, and must provide, in a conspicuous place in the shop, beams, scales and weights, in order that all bread there sold may from time to time be weighed in the presence of the purchaser. The penalty for using any other weight than avoirdupois is a sum not exceeding £5 nor less than forty shillings, and for failing to provide beams and scales a sum not exceeding £5. Also every baker and seller of bread, delivering by cart or other conveyance, must be provided with scales and weights for weighing bread; but since the Weights and Measures Act 1889, no penalty is incurred by omission to weigh, unless there has been a request on the part of the purchaser. The acts also define precisely what ingredients may be employed in the manufacture of bread, and impose a penalty not exceeding £10 nor less than £5 for the adulteration of bread. (See further under ADULTERATION.)

Although the act of 1836 extends to the whole of the United Kingdom (Ireland excepted) out of the city of London and beyond 10 m. of the Royal Exchange, yet in many Scottish burghs this act is replaced by local acts on the sale of bread. These are in all cases of a much more stringent nature, requiring all batch or household bread to be stamped with the reputed weight. Any deficiency within a certain time from the withdrawal of the bread from the oven is an offence. The London County Council desired to introduce a similar system into the area under their jurisdiction, and promoted a bill to that effect in 1905, but it fell through. The bill was opposed not only by the National Association of Master Bakers, the London Master

Bakers' Protection Society, and by the West End metropolitan bakers in a body, but also by the Home Office, which objected to what it termed exceptional legislation.

It may be noted that the acts of 1822 and 1836 define precisely what may and may not be sold as bread. It is laid down in section 2 that "it shall and may be lawful . . . to make and sell . . . bread made of flour or meal of wheat, barley, rye, oats, buckwheat, Indian corn, peas, beans, rice or potatoes, or any of them, and with any (common) salt, pure water, eggs, milk, barm, leaven, potato or other yeast, and mixed in such proportions as they shall think fit, and with no other ingredients or matter whatsoever."

Sanitation of Bakehouses.—The sanitary arrangements of bakehouses in England were first regulated by the Bakehouse Regulation Act 1863, which was repealed and replaced by the Factory and Workshop Act 1878; this act, with various amending acts, was in turn repealed and replaced by the Factory and Workshop Act 1901. By the act of 1901 a bakehouse is defined as a place in which are baked bread, biscuits or confectionery, from the baking or selling of which a profit is derived. The act of 1863 placed the sanitary supervision of bakehouses in the hands of local authorities; from 1878 to 1883 supervision was in the hands of inspectors of factories, but in 1883 the supervision of retail bakehouses was placed in the hands of local authorities. Under the act of 1901 the supervision of bakehouses which are "workshops" is carried out by local authorities, and for the purposes of the act every bakehouse is a workshop unless within it, or its close or curtilage or precincts, steam, water or other mechanical power is used in aid of the manufacturing process carried on there, in which case it is treated as a non-textile factory, and is under the supervision of factory inspectors.

The more important regulations laid down by the act are: (1) No water-closet, &c., must be within or communicate directly with the bakehouse; every cistern for supplying water to the bakehouse must be separate and distinct from any cistern supplying a water-closet; no drain or pipe for carrying off sewage matter shall have an opening within the bakehouse. (2) The interior of all bakehouses must be lime-washed, painted or varnished at stated periods. (3) No place on the same level with a bakehouse or forming part of the same building may be used as a sleeping place, unless specially constructed to meet the requirements of the act. (4) No underground bakehouse (one of which the floor is more than 3 ft. below the surface of the footway of the adjoining street) shall be used unless certified by the district council as suitable for the purpose (see *Redgrave, Factory Acts*; *Evans Austin, Factory Acts*).

Bread Stuffs.—As compared with wheat-flour, all other materials used for making bread are of secondary importance. Rye bread is largely consumed in some of the northern parts of Europe, and cakes of maize meal are eaten in the United States. In southern Europe the meal of various species of millet is used, and in India and China durra and other cereal grains are baked for food. Of non-cereal flour, the principal used for bread-making is buckwheat (*Fagopyrum esculentum*), extensively employed in Russia, Holland and the United States. The flour of peas, beans and other leguminous seeds is also baked into cakes, and in South America the meal of the tapioca plant, *Jatropha Manihot*, is employed. But, excepting rye, none of these substances is used for making vesiculated or fermented bread.

A normal sample of wheat-flour consists roughly of 10 parts of moisture, 72 of starch, 14 of nitrogenous matter, 2.25 of fatty matters, and 1.75% of mineral matter. Starch is thus the predominating component; it is not, however, the dough-forming ingredient. By itself, starch, when saturated with water, forms a putty-like mass devoid of coherence, and it is the gluten of the nitrogenous matter which is the binding constituent in dough-making, because when wetted it forms a more or less elastic body. The proportion of gluten in wheat-flour varies from 7 to 15%, but the mere quantity of gluten is by no means the only standard of the commercial value of the flour, the quality also counting for much. One of the functions of gluten is to produce a high or well-piled loaf, and its value for this purpose depends largely on its quality. This in turn depends largely on the variety of wheat; certain races of wheat are much richer in nitrogenous elements than others, but such wheats

usually only flourish in certain countries. Soil and climate are undoubtedly factors in modifying the character of wheat, and necessarily therefore of the flour. The same wheat grown in the same soil will show very varying degrees of strength (i.e. of gluten) in different seasons. For instance, the north-western districts of America grow a hard spring wheat which in a normal season is of almost unequalled strength. In 1904 an excess of moisture and deficiency in sun in the Red River Valley during the critical months of June and July caused a serious attack of red and black rust in these wheat fields, the disease being more virulent in the American than the Canadian side of the valley. The result was that the quality of the gluten of that season's American spring wheat was most seriously affected, its famed strength being almost gone. Wheat from the Canadian side was also affected, but not nearly to so great an extent. Flour milled from hard winter wheat in the American winter districts is sometimes nearly as strong as the spring wheat of the North-west. Hungarian flour milled from This wheat is also very strong, and so is the flour milled from some south Russian spring wheats. But here again the degree of strength will vary from season to season in a remarkable manner. In the main each land has its own clearly marked type of wheat. While the United States, Canada, Hungary and Russia are each capable of growing strong wheat, Great Britain, France and Germany produce wheat more or less weak. It follows that the bread baked from flour milled from wheat from British, French or German wheat alone would not make a loaf of sufficient volume, judged by present British standards. As a matter of fact, except in some country districts, British bakers either use strong foreign flour to blend with English country flour, or, more frequently, they are supplied with flour by British millers milled from a blend in which very often English wheat has a small, or no place at all. If the baker's trade calls for the making of household bread, especially of the London type, he must use a strong flour, with plenty of staple gluten in it, because it is this element which supplies the driving or lifting force, without which a high, bold loaf cannot be produced. If the demand is for tin or (as it is called in many parts of the north of England) pan bread, a weaker flour will suffice, as the tin will keep it up. A Vienna loaf should be made with at least a certain proportion of Hungarian patent flour, which is normally the highest-priced flour in the market, though probably the bulk of the Vienna rolls made in London contain no Hungarian flour. A cake of flat shape can be very well made with a rather weak flour, but any cake that is required to present a domed top cannot be prepared without a flour of some strength.

It is a general opinion, though contested by some authorities, that soft, weak flours contain more flavour than strong, harsh flours. The strong wheats of the American and Canadian North-West make less flavoured flour than ^{Flavour of flour.} soft red winter from the American South-West. It would not, however, be correct to say that all strong wheats are necessarily less full of flavour than weak wheats. Hungarian wheat, for instance, is one of the strongest wheats of the world, but has a characteristic and pleasant flavour of its own. Indian wheats, on the other hand, are not particularly strong, but are liable to give a rather harsh flavour to the bread. English, French and German wheats, when harvested in good condition, produce flour of more or less agreeable flavour. None of these wheats could be classified as strong, though from each of those lands wheat of fair strength may be obtained under favourable meteorological conditions. The Australasian continent raises white wheat of fine quality which has much affinity with British wheat—it is the descendant in many cases of seed wheats imported from England—but it is occasionally stronger. The resultant flour is noted for its sweetness. Both millers and bakers who are concerned with the supply of high-class bread and flour make free use of what may be termed flavoured wheats. The proportion of English wheat used in London mills is very small, but millers who supply West-End bakeries with what is known as top-price flour are careful to use a certain amount of English wheat, if it is to be had in prime condition. They term this ingredient of their mixture "sugar." London bakers again,

with customers who appreciate nicely flavoured bread, will "pitch" into their trough a certain proportion of English country flour, that is, flour milled entirely or chiefly from English wheat, which under such conditions is strengthened by a blend of strong flour, a patent flour for choice. It has been objected that as English wheat contains a large proportion of starch, and as starch is admittedly destitute of flavour, there is no reason why flour milled from English wheat should possess a sweeter flavour than any other starchy wheat flour. Experience, however, has amply proved that well-ripened English wheat produces bread with an agreeable flavour, though it does not follow that all English wheat is under all conditions capable of baking bread of the highest quality. But it would be as fallacious to hold that weak flour is necessarily flavoury, as that all strong flour is insipid and harsh. Different wheats are undoubtedly possessed of different flavours, but not all these flavours are of a pleasing character. In some cases the very reverse is true. Californian and Australian wheats have occasionally aromatic odours, due to the presence of certain seeds, that will impart an objectionable flavour to the resultant bread.

While the essential character of particular wheats will account for a good deal of the flavour that may be detected in the bread made from them, the baking process must also be responsible to some extent for flavour. The temperature of the oven and the degree of fermentation must be factors in the question. It has been asserted that the same flour will bake into bread of very different flavour according as the fermentation is carried out slowly or quickly, or as the oven is hot or the reverse. A high temperature seems to have the effect of quickly drawing out the subtle essences which go to give flavour to the bread, but it is a question whether they are not subsequently rapidly volatilized and partially or wholly lost. The rapid formation of a solid crust is no doubt likely to retain some of these flavouring essences. A moist, or "slack," sponge, or dough, appears distinctly favourable to the retention of flavour, the theory being that under such conditions the yeast, having more room to "breathe," works more easily, and is therefore less likely to convert into food those soluble constituents of the flour which give flavour.

The colour of flour is a valuable, though not an infallible, index to its baking qualities. Thus, a flour of good colour, by which bakers mean a flour of bright appearance, white, but not a dull dead white, will usually bake into a loaf of good appearance. At the same time, a flour of pronounced white tint may bake into a dirty grey loaf. This has been particularly noted in the case of flours milled in Argentina. The colour of flour will vary from a rich, creamy white to a dull grey, according to its quality. The different shades are many and various, but the prevailing tints are comparatively few. Perhaps Blandy's classification of the colours as white, yellow, red, brown and grey is as serviceable as any. Each of these tints is directly caused by the presence of certain substances. White denotes the presence of a considerable proportion of starch, while a pronounced yellow tint proclaims gluten of more or less good quality. Red and brown are tints only found in flours of low grade, because they are sure proofs of an undue proportion of branny or fibrous particles. A greyish flour invariably contains impurities, such as crease dirt, from the wheat, the intensity of the tint varying in proportion to their amount. With regard to a yellow tint, though this always denotes the presence of gluten, it is difficult to estimate the baking quality of the flour by the shade of yellow. In the best Hungarian patent flour the whole sample will be suffused by an amber tint, known to Budapest and Vienna bakers as *gelblicher Stick*. Rolls baked from the best Hungarian flour will not infrequently cut yellow as if eggs had been used in making them up, though nothing more than flour, yeast and water has been employed. Strong flour milled from American or Canadian spring wheat is also yellowish in colour, but the tint is not so deep as with Hungarian flour. On the other hand, there are flours of no great strength, such as those from some Australian wheats, which are apt to look yellow; when the colour of flour is not maintained in the bread, the reason is generally to be found in the baking process employed. Colour

is a fairly trustworthy, but not an absolute guide to the chemical composition of flour.

Unfortunately not all flour of good colour is sound for bread-making purposes. Wheat which has been harvested in a damp condition, or has been thoroughly soaked, by drenching showers previous to cutting, or has got wet in the stook, is liable, unless carefully handled, to produce flour that will only bake flat, sodden loaves. Wheat which has received too much rain as it is approaching maturity, and has then been exposed to strong sunlight, is peculiarly liable to sprout. This seems to happen not infrequently to La Plata wheat, and though wheat shippers in that country are usually careful to clean off the little green spikes, this outward cleansing does not remedy the mischief wrought to the internal constitution of the berry. Such wheat makes flour lacking in strength and stability. Its gluten is immature and low in percentage, while the soluble albuminoids are in high percentage and in a more or less active diastatic state. The starch granules are liable to have weakened or fissured walls, and the proportion of moisture and of soluble extract will be high. With regard to the beneficial action of kiln or other drying on damp flour, William Jago was convinced by a series of experiments that the gentle artificial drying of flour increases its water-absorbing capacity to about three times the amount of water lost by evaporation. On the other hand, a damp flour dried too quickly and at too great a heat is liable to be made more instead of less susceptible to diastatic changes.

Alum.—Strictly speaking, when employed with weak and unstable flours alum is a remedial agent. The popular idea that it acts as a kind of bleacher of flour, having the faculty of converting flour that is dark-coloured through containing a sensible proportion of branny particles and woody fibre, into white-coloured loaves, is erroneous. Its action as a producer of white bread is indirect, not direct, though it is none the less effective. It seems to act as a brace to or steadier of unstable gluten. If from the same wheat a certain proportion of gluten be extracted and divided into two parts, of which one is placed in a glass of water containing a strong solution of alum, and the other in a glass of plain water, the gluten in the latter case will become spent days and perhaps weeks before the sample in the alumed water is disintegrated. The place of alum in the process of fermentation is well marked. By holding together unstable glutes it checks the diastatic action, and the proportion of starch converted into glucose (grape sugar) is reduced, with the result that a whiter and more porous loaf is produced. It is generally admitted that by the use of alum more or less eatable bread may be baked from flour which otherwise could hardly be made into bread at all. Strictly, therefore, this substance is not an adulterant, inasmuch as it is not a substitute in any sense for flour. But it is admittedly unwholesome, and therefore its legal interdiction for alimentary purposes is quite justifiable. Another aspect of the use of alum is that it is employed for the purpose of enabling bakers to use poor flour.

A fairly satisfactory test for alum in bread (or flour) is afforded by an alkaline solution of logwood and a saturated solution of ammonium carbonate. The presence of alum is shown by a lavender or full blue colour. The depth of the tint is said to be a rough guide to the quantity of alum present. According to Jago this test is so sensitive that it has resulted in the detection of 7 grains of alum in a 4-lb loaf.

Besides alum, small quantities of copper sulphate have been used for checking diastasis and retarding fermentation. This substance has the same effect as alum, but as all copper salts are active poisons, the employment of copper sulphate is most strongly to be condemned.

Lime-water.—The object of using either alum or copper sulphate is to check over-rapid diastasis during fermentation. Baron Liebig pointed out a much less objectionable means of attaining the same end by means of lime-water, about 1½ oz. of fresh quicklime being dissolved in the water used for doughing one sack of flour. Bread made in this way is said to be spongy in texture, of agreeable flavour, and perfectly free from acidity. In the baked loaf the lime is transformed into calcium carbonate (chalk) by the carbon dioxide resulting from the panary fermentation. It is said that an increased yield of bread may be obtained by the use of lime-water; the explanation may be that lime-water, by retarding the degradation of the gluten and the diastasis of the starch, increases the water-retaining power of the flour, so that the same weight of flour yields a greater volume of bread.

Unvesiculated and Vesiculated Bread.—Wheat bread may be divided into two main divisions, unvesiculated and vesiculated. The term vesiculated simply means provided with vesicles, or small membranous cavities, such as are found in all bread that has been treated by yeast, leaven or any other agent for rendering it spongy in structure by the action of carbonic acid gas. Nearly all bread eaten by civilized folk is vesiculated, though

there are different methods and processes for attaining this result. Into the category of unvesiculated bread enter such products as the Australian damper, a flat cake prepared from flour, water and salt, and baked in the hot ashes of a wood fire. The dough is spread on a flat stone and covered with a tin plate, while the hot ashes are heaped around and over it; the heat should not be much in excess of 212° Fahr. The scones, the bannock and other similar cakes, still much appreciated in Scotland and the north of England, are also examples of unvesiculated bread. They are baked on hot plates or "griddles," on hearths, and sometimes in ovens. Biscuits differ from these cakes in the fact that they are baked by a high instead of a moderate heat. But they enter so far into the class of unvesiculated bread that they are generally prepared without the aid of any such aerating agent as carbon dioxide. (See Biscuit.)

Vesiculated bread is now the only article of diet made from flour to which the term bread is applied, and there are various ways of producing the spongiform texture by which it is characterized. The ordinary and doubtless the most satisfactory way is by developing the carbon dioxide within the dough itself by the use of yeast (*g.v.*) or leaven, which sets up alcoholic fermentation, splitting up the saccharine matters in the flour into alcohol and carbon dioxide. The latter is retained by the dough and distends it, causing the bread to "rise." Or the carbon dioxide may be artificially introduced, as in the so-called "aerated" bread (see below), or it may be produced by the agency of certain chemicals, as for instance of baking powders.

Such powders are mixtures which, under the influence of either water or heat, evolve carbon dioxide. These powders have been divided by Jago into three groups:—(1) *Tartrate* powders, in which the acid constituent is either free or partly combined tartaric acid; (2) *Phosphate* powders, in which the acid is some form of phosphoric acid; (3) *Alum* powders. All these powders have a more or less aperient action on the human system. Tartrate powders have the disadvantage that both commercial tartaric acid and cream of tartar frequently contain lead, a poisonous substance. Phosphate powders are less open to objection, as they are more easy to obtain free from lead and other metallic impurities. Alum powders contain potassium bisulphate and alum. It is somewhat remarkable that while the presence of alum in bread is regarded by the law of England as adulteration, its use in baking powder was pronounced legal in *James v. Jones*, 1894, 1, Q.B. 304, on the ground that baking powder is not food within the meaning of the Sale of Food and Drugs Act 1875. In making wholemeal bread, hydrochloric acid and sodium bicarbonate are often used in such proportions that they neutralize each other. Carbon dioxide is evolved and raises the dough. In preparing wholemeal bread the use of this combination has the advantage that the acid acting rapidly on the sodium bicarbonate soon produces enough carbon dioxide to aerate the dough, and thus hasten its entry into the oven. Wholemeal flour contains so large a proportion of cerealin that diastasis is apt to proceed rapidly, the result being a clammy, sodden loaf. For this reason, perhaps the so-called aerated process is even more suitable for making wholemeal than white bread.

Methods of dough-making differ in different countries, and even in different parts of the same land. In the *off hand* method the dough is made right off, without any preliminary stages of ferment or sponge. This plan is sometimes adopted for making tin bread, and occasionally for crusty loaves. For tin bread a strong flour would be used and made into a slack dough, and about 1½ lb to 2 lb of distillers' yeast would be used for the sack (280 lb) of flour, occasionally with the addition of a little brewers' yeast. Salt is used in the proportion of 3 lb to 3½ lb per sack. Formerly also it was the custom to add 10-14 lb of boiled potatoes, but the use of potatoes has greatly decreased. A tin-bread dough would be made slack, with about 70 quarts of water to the sack, and after being mixed, would be fermented at a temperature of 76-80° Fahr. It should lie for about ten hours. A dough for crusty bread such as cottage loaves, would be made much tighter,

not more than 60 quarts of water being allowed to the sack. It would be fermented at a higher temperature, and would not lie more than about six hours. A slack dough is much less laborious to work (when the dough is hand-made) than a tight dough, for which a mechanical kneader is very suitable, but as a matter of fact the use of machinery (see below) is still the exception, not the rule. When a stiff dough is made by hand, it is usually made somewhat slack to begin with, and then "cut back" and "dusted" at regular intervals, that is to say, more and more flour is added till a dough of the required consistency has been obtained. (In the British baker's vocabulary "dust" means flour, and good dust stands for good flour.) This system, on the one hand, saves the labour involved for "sponging" and other operations, and the bread is produced in less time; but on the other hand more yeast is used, and bakers generally hold that the system sacrifices the colour and texture of the loaf to convenience of working and yield. The high proportion of yeast enables the dough to carry a large quantity of water, and about 104 4-lb loaves to the sack is said by Jago to be a not unusual yield in the case of slack doughs. But such a result would only be possible with very strong flour. In an ordinary way 66 loaves to the sack is a very high yield, unattainable except with strong flour, and probably the average yield is not more than 90 loaves to the sack. In London the manager of a "tied" shop is usually held to account for 92 loaves to the sack.

In the *ferment and dough* system, the ferment usually consists of 10 to 14 lb of potatoes to the sack of flour, boiled or steamed, and mashed with water, so as to yield about 3 gallons of liquor. There are several substitutes for potatoes, including raw and scalded flour, malt, malt extracts, &c.; brewers' or distillers' yeast may also be used. A ferment should contain saccharine matters and yeast stimulants in such a form as to favour the growth and reproduction of yeast in a vigorous condition. Hence it should not be too concentrated. About six hours are required for its preparation. It is added, together with 2½ to 3 lb of salt, to the dough, which is prepared with about 56 quarts of water to the sack, and worked at a temperature of 80-84° Fahr. The dough is allowed to lie from two to five hours according to the flour used, the character of the ferment, and the working temperature. In this system the proportion of strong flour is usually reduced to 40% of the dough, and no doubt in some cases only soft or weak flours are used. Naturally the yield of bread is not so high as in the case of an off hand dough made entirely from strong flour, and it will probably not exceed 90 loaves to the sack. This method has many advantages. After the ferment is made the labour required is not much greater than with the off hand doughs, and less yeast is required, while potatoes, which are somewhat troublesome, from the necessary cleaning, can be replaced by the substitutes already mentioned. The method produces good-looking and palatable bread, though the loaves should be eaten within some twelve hours of leaving the oven.

The *sponge and dough* system, which is probably in widest use in England, is adapted to almost every kind of bread, and has the advantage that any kind of flour can be employed. The stronger flours which need long fermentation can be and usually are used in the "sponge" stage, while soft flours are utilized in the dough. (The sponge is a certain proportion, varying from a quarter to one-half, of the flour necessary for making the batch.) In London the baker often uses for the sponge a bag (140 lb) of American spring wheat flour, and for the dough a sack (280 lb) of British milled flour, which, whether it be country flour milled largely from English wheat or London milled, is always softer and weaker than that used for the sponge. The sponge is made very slack, 26 to 32 quarts of water being used to say 100 lb of flour. Yeast, either distillers' or brewers', must be added, in proportions varying according to its character and strength. Of distillers' yeast 6 to 10 oz. may be used for 280 lb of flour (including sponge and dough). Salt is added to the sponge sparingly, at the rate of about ½ lb to the sack of 280 lb. The object of making the sponge so slack is to quicken the fermentation. When set the sponge is allowed to ferment from six to ten

hours, according to temperature and other conditions. Sometimes all the water it is intended to use is put into the sponge, which is then known as a "batter" sponge. The sponge, when ready, is incorporated with the rest of the flour to which the necessary amount of water and salt is added. The whole mass is then doughed up into the requisite consistency, the dough being allowed to lie for about two hours. Bread made by this method, always assuming that over-fermentation has been avoided, is of good appearance, presenting a bold loaf, with even texture and a nice sheen. Owing to the use of soft flours, the flavour should be agreeable, and the loaves ought to keep much longer than bread made by ferment and dough. The yield may rise as high as 96 loaves per sack, if strong flour has been used in the sponge.

A combination of the above two methods, known as the *ferment, sponge and dough* system, is often used with brewers' yeast. In this case the yeast is not added to the sponge direct, but goes into the ferment. This method is rather in favour with bakers who make their own yeast.

The system of bread-making generally used in Scotland is known as the *flour barm, sponge and dough*. The barm is a combination of a malt and hop yeast, with a slow, scalded flour ferment. To make the so-called "virgin" barm a Scottish baker would use a 30-gallon tub; a smaller vessel for malt-mashing; 10 lb malt; 3 oz. hops and a jar for infusing them; 40 lb flour; 2 to 3 oz. malt; 8 to 12 oz. sugar, and 18 gallons of boiling water. With these materials a powerful ferment is produced, which it is considered best to use in the sponge the fourth or fifth day after brewing. The sponges used in Scotland are "half" or "quarter." About 6 lb of malt go to the sack, one-sixth going into the sponge. As in England, strong flours are used for the sponge, but rather stronger flours are used for the dough than is usual in England. Scottish loaves are largely of the "brick" type, high and narrow. Such bread has an attractive appearance and keeps well. It has a rather sharp flavour, approaching acidity but avoiding sourness, while the large quantity of malt used adds a characteristic taste. The yield rises in some Glasgow bread factories to 100 loaves to the sack.

In many parts of Europe bread is still made from leaven, which, properly speaking, consists of a portion of dough held over from the previous baking. This substance, known to French bakers as *levain*, is called in Germany *Sauerleig* (anglicise "sour dough"). The lump of old dough, placed aside in a uniform temperature for some eight hours, swells and acquires an alcoholic odour, becoming the *levain de chef* of the French bakers. It is then worked up with flour and water to a firm paste double its original volume, when it becomes the *levain de première*. Six hours later, by the addition of more flour and water its amount is again doubled, though its consistency is made rather softer, and it becomes the *levain de seconde*. Finally, by another addition of flour and water, the amount is again doubled, and the *levain de tous points* is obtained. This mass is divided into two parts; one is baked yielding rather dark sour bread, while the other is mixed with more flour and water. This second portion is in turn halved, part is baked, and part again mixed with more flour, this last batch yielding the best and whitest bread. In North Germany leaven is generally used for making rye bread, and loaves baked from a mixture of wheat and rye flour. In the bakery of the Krupp works at Essen, each batch of the so-called Paderborn bread is prepared entirely with leaven from 270 kilos of rye flour (patent quality), 100 of wheat flour (seconds), 2 of buckwheat meal, 6 of salt, 5 of leaven, and one litre of oil. In Vienna leaven is never used for making the rolls and small goods for which that city is famous. Viennese bakers use either brewers' yeast or a ferment, prepared by themselves, of which the basis is an infusion of hops. Brewers' yeast is added to the ferment, which takes the form of a very slack dough. With 100 kilos (220-46 lb) of flour about 17 litres or nearly 2 gallons of ferment are used.

In the original Daughish process for the manufacture of aerated bread, which was brought into operation in Great Britain in 1859, carbonic acid gas was evolved in a generating vessel by the

action of sulphuric acid on chalk, and after purification was forced at high pressure into water, which was then used for doughing the flour. In this process the flour that had to be made into bread was submitted to the action of the super-aerated water by direct transference. It was

found, however, in practice that much difficulty occurred in making the gas admix readily with the flour and water, great pressure being required, and to lessen the difficulties a new process, called the "wine whey," was introduced. To carry this out, a vat placed on the upper storey of the factory is charged with a portion of malt and flour, which is mashed and allowed to ferment until a weak and slightly acid thin wine is produced, this after passing through the coolers is stored until it is transformed into a vinous whey. This whey is then introduced into a strong cylinder partly filled with water, and is aerated by letting in the gas (now stored in a highly compressed form in bottles), the pressure required being only a quarter of that necessary with the original method. The flour having been placed in the mixers, which are of globular form containing revolving arms, the aerated fluid is admitted, and in a short period the flour and fluid are completely incorporated. By means of an ingenious appliance termed a dough cock, the exact amount of dough for a single loaf of bread is forced out under the pressure of the gas, and by reversing the lever the dough, which expands as it falls into a baking tin, is cut off. Two sacks of flour can be converted with ease into 400 2-lb loaves in forty minutes, whereas the ordinary baker's process would require about ten hours. At first a difficulty was encountered in the fact that the dough became discoloured by the action of the "wine whey" on the iron, but it was overcome by Killingworth Hedges, who discovered a non-poisonous vitreous enamel for coating the interior of the mixers, &c. It has been claimed for the Daughish process that it saves the baker risks attendant on the production of carbon dioxide by the ordinary process of fermentation, in that he is no longer liable to have his dough spoil by variations of temperature and other incalculable factors, the results being certain and uniform. A further claim is the saving of the proportion of starch consumed by conversion into glucose during the process of fermentation. The original objection, that, by the absence of fermentation, those subtle changes which help to produce flavour are lost, is annulled by the use of the wine whey process. The Daughish process is well suited for producing small goods, such as cakes and scones, where flavour can be artificially imparted by means of currants, flavouring essences, &c. An undoubted advantage of the aerating process of bread-making is adaptability for utilizing flour with unstable gluten, which can thus be made into an excellent quality of bread. For wholemeal bread, too, there is probably no more suitable process than the Daughish. The strong diastasic action of the cereal, inevitable in fermentation, is entirely avoided. The Aerated Bread Company have about a hundred depots in London, which are supplied from a central factory.

The essence of the bread-making process recently invented by Serge Apostolov is the combination of a flour mill and bakery. The wheat, after a preliminary cleaning, is ground into flour by a mill composed of metal disks dressed, that is furrowed, very much like the surfaces of a pair of mill-stones. The disks are not set to grind very close, because it is desired, by minimizing friction, to keep the meal cool. From the middlings obtained by this milling process about 10% of bran is separated, and the remainder of the middlings is treated by a peculiar process, akin to mashing, termed "liviviation." The middlings are saturated with tepid water containing a small proportion of yeast, which causes a certain amount of fermentation. It is claimed that by this process a solution is obtained of the floury constituents of the middlings. From the vats the solution is poured on an inclined sieve which has a gentle reciprocating motion. The floury particles pass through the meshes, while the bran tails over the sieve; the proportion of the wheat berry thus rejected is given as about 2%. On the other hand, the milky-looking solution, called "lactus," is caught in a special vessel, and delivered by a shoot into a trough, which may be

either a mechanical kneader of an ordinary trough. This lactus takes the place of the ordinary sponge. The flour is added in the proportion necessary to make the required batch and the whole mass is doughed, either by hand or power. The resultant dough is moulded in the ordinary way into loaves, which are baked in due course. The advantages claimed for the process are that it permits of the utilization in bread-making of about 8½ % of the wheat berry, that the resultant bread is fairly white in colour and is agreeable in flavour, and that it is extremely simple and provides a ready and cheap means of flour-making.

Mackies Bakeries.—Bread-baking, though one of the most important of human industries, was long carried out in a most primitive manner, and machinery is still practically unknown in the bulk of British bakehouses. The reasons for this apparently anomalous condition of things are not very far to seek. Bread, unlike biscuits, is a food quite unfitted for long storage, and must be consumed within a comparatively short time of being drawn from the oven. Hence the bread-baker's output is necessarily limited to a greater or lesser degree. This will be the more apparent when it is considered that the cost of distributing bread is high relatively to the profits to be realized. A baker's bread trade is therefore usually limited to local requirements, and trading on a small scale he has less inducement to lay out capital on the installation of machinery than other classes of manufacturers. But there are now many machine bakeries (known in Scotland as bread factories), both in London and in other parts of Great Britain, where the manufacture of bread is carried out more or less on a large scale. The evolution of the machine bakery has been slow, and the mechanical operations of the bakehouse were long limited to the mixing of the sponge and the kneading of the dough, but now the work of the bakery engineer extends over almost every operation of bread-making.

A bread-baking plant should be installed in a building of at least two storeys. The ground floor may be used for the shop, with possibly a bread-cooling and delivery room at the rear. The flour may be hoisted to an attic at the top of the building, or to the top floor; in any case there must be sufficient floor space to accommodate the flour sacks and bags. Underneath the floor of the flour store should be installed a flour sifter, a simple apparatus consisting essentially of a hopper through which the flour enters a cylinder with a spiral brush, by which it is thoroughly agitated previously to passing through one or more sieves placed under the brush. A sack of flour may be passed through this sifter in a couple of minutes, the operation freeing the flour from lumps and pieces of string or other foreign substances which may have found their way into the sack. The sifter may also be combined with a blender or mixer, so that the baker may by its means thoroughly blend different flours in any desired proportion. The operation of blending is usually effected by a revolving blade of suitable design or by a worm conveyor placed underneath the sieve or sleeve. From the sifter and blender the flour descends by a sleeve into the dough kneading machine on the floor below. But in cases where it is desired merely to sift and blend flour ready for future use, it may be received in a worm and elevated again to the storage floor by an ordinary belt and bucket elevator. The water required for doughing purposes is contained in an iron tank, fixed to the wall in convenient proximity to the dough kneader. This tank, known as a water attemperating and measuring tank, is provided with a gauge and thermometer, and from it the exact quantity of water needed for doughing can be rapidly drawn off at the desired temperature. The cold water supply may be let into the tank at the top, and the hot water supply at the bottom, the idea being that each supply shall permeate the whole mass by gravity, the hot water ascending and the cold descending. The chief types of dough kneader will be described subsequently, but here it should be noted that not only have machines been devised for cutting out the exact sizes of dough required for small goods, such as buns and tarts, but that the operations of weighing and dividing dough for quarter and half-quarter loaves can also be neatly and economically effected by machinery. Further, at least two machines have been built which successfully mould loaves (of simple shape), and the problem of moulding household bread by machinery has certainly been solved, but whether delicate twists and other fancy shapes could be equally well moulded mechanically is less certain.

The machine bakery, however complete, is not likely ever to be quite automatic and continuous like a modern flour mill, where the plant is connected throughout and virtually forms one machine (see FLOUR AND FLOUR MANUFACTURE), and though the engineer has at least managed to effect every operation of the bakehouse by mechanical means, it is not yet possible to shoot a sack of flour into the hopper of the sifter on the top floor, and to turn it into bread, without any human intervention whatever, though as things are, the moulded dough can be put into the oven without undergoing actual contact with human hands. In practice, some of the machines mentioned above are often dispensed with, even in so-called machine bakeries. The flour sifter and blender is indeed found in many bakeries where mechanical kneaders are unknown, while not in all machine bakeries would be found dough weighers and dividers, still

less moulding machines. The economical side of the argument on behalf of machinery is presented in the familiar shape that a properly equipped machine bakery can turn out better work at a lower cost (by dispensing with labour), or at any rate can carry on a bigger trade with the same staff. There is plausibility in this argument, but it must be admitted that innumerable bakeries of capacities varying from 10 to 20 sacks per week are carried on more or less successfully without machinery of any kind, beyond perhaps a sifter or blender. Moreover, some of these bakehouses produce bread which can hardly be improved on.

One advantage claimed for flour sifters, besides removing the impurities, is that by thoroughly aerating flour they cause it to become more "lively," in which condition it kneads more readily. It is also quite possible that the air which is thus incorporated with the dough has a stimulating effect on the yeast, causing a more energetic fermentation. A strong argument in favour of dough kneaders is their hygienic aspect. It is agreed that the operation of dough stirring by hand, since it involves severe labour conducted in a heated atmosphere, must be liable to cause contamination of the dough through emanations from the bodies of the operatives. In well-managed bakeries the utmost personal cleanliness on the part of the staff is exacted, but the unpleasant contingency alluded to is certainly possible. It is also contended that the use of machinery for dough kneading and batter whisking will ensure better work, in the sense that the mass under treatment will be more thoroughly worked by mechanically driven arms of iron or steel than by human limbs, liable to weariness and fatigue. The better worked the dough, the greater its power of expansion, and consequently the greater its bread-making value.

The most widely known machine used in connexion with bread-baking, next to the sifter, is the dough kneader. The dough kneader is no new invention. As far back as 1760, a kind of dough Dough
Kneader. kneader was constructed in France by one Salignac. It is described as consisting of a trough, inside which the dough was agitated by arms shaped somewhat like harrows. This machine is said to have been tested before a committee of the Academy of Sciences, who reported that in their presence dough had been prepared in fourteen to fifteen minutes. The bread baked from this dough is said to have been most satisfactory, but for some reason the machine never came into general use. For one thing, the power problem would have been almost insuperable to a baker in the France of those days. In general design this kneader approximated to the machines which have since done good work in bakeries all the world over. Salignac was quickly followed by another inventor, Cousin, also a Frenchman, who brought out in 1761, or thereabouts, a dough-kneading machine, which, however, had no better success than its predecessor. The first kneading machine which appears to have been in actual use in a bakery was constructed by a Paris baker of the name of Lembert, after whom it was called the Lembertine. Lembert is said to have been experimenting with this apparatus as early as 1796. Be that as it may, it was not brought out till 1810, when a prize of 1500 francs (£60) was offered by the Société d'Encouragement pour l'Industrie Nationale. This reward was won by Lembert, and his machine thereupon came into a certain amount of use in France. It is remarkable that France long remained the only country in which dough kneaders were employed, but even there their use was limited.

The Fontaine, another French kneader, called after its inventor, was first made in 1835. It had a certain success, but has long passed out of use. It appears to have been a copy to a great extent of the Lembertine. The objection against both these machines was that their blades, while exercising a mixing action, were deficient in kneading effect. Probably the first machine which achieved the task of efficiently replacing the work of human arms in sponge breaking and dough kneading was the Boland kneader. This was also a French machine, and dates back to about the middle of the 19th century. It is believed to have been first used in the Scipion bakery in Paris. It consists essentially of a trough, inside which revolve a pair of blades so arranged as to work somewhat like alternate screws: it is claimed for these blades that their action has the effect of tossing the dough backwards and forwards when it is slack, and of drawing it out when it happens to be stiff. It is further claimed that the blades are so shaped that their revolution has the effect of moving the dough from right to left and left to right in the trough. The machine is geared to give two speeds, the faster being suitable for sponge setting, while the slow and most powerful speed is intended for the doughing. The Boland machine has been widely adopted in other countries than France, and was certainly one of the first dough kneaders to be used in the United Kingdom. It was installed in the great Boland bakery in Dublin, where it proved a great success. The proprietor of this bakery, with which was also connected a flour mill, is said to have had his attention first drawn to this machine by the fact that its inventor was his namesake, though no relative.

The Deliry-Desboves dough kneader, also of French origin, and in general use in France, consists essentially of a cast iron trough, shaped somewhat like a basin, and turning on a vertical axis. The kneading arms inside the trough are shaped after the pattern of a lyre, and have the effect of first working up and then dividing the dough right through the kneading process. Two helical blades,

which also form part of the mechanism, serve to draw out and aerate the dough, as effectively, it is claimed, as can be done by the most skilled operative. The force of the kneading operations can be regulated without stopping the machine. A thoroughly kneaded dough can, it is said, be made in this machine in twelve to fifteen minutes.

In Great Britain the type of machine that used to be most in favour was the trough within which the kneading arms worked on horizontal axis. The trough was either open or provided with a lid. The kneading blades were variously shaped, but generally were more or less straight, and were designed to both mix and aerate the dough. In some cases the kneading blades were worked on a single axis, in others two different sets of arms worked on two axes running parallel to one another. Generally the kneader was geared to two speeds, the fast motion being most suitable for sponge setting, and the earlier stages of dough-making, while the slower motion was intended to draw out and thoroughly aerate the dough. To discharge the dough, the trough was tilted by means of a worm and worm wheel, the latter being secured to the trough. Several variations of this type of kneader are still in use. The machine known as the "Universal" kneader consists of a trough set horizontally, within which rotate on horizontal axes a pair of blades lying in the same plane. These blades are curved and are geared together by means of differential spur wheels, with the object of running the two spindles at unequal speeds. The bottom of the trough is divided into two semi-cylindrical cavities, separated by a ridge. Each blade plunges into its own cavity, and the action of these arms tends, while pressing the dough against the sides and base of the trough, to bring it quickly back towards the centre. The differential speed has the advantage of effecting a more thorough mixing of the dough, as it brings together pieces of dough which have not yet been mingled, the blades pushing the dough from one cavity to the other. To hasten the kneading process it is desirable occasionally to reverse the motion by a turn of a hand wheel on the same shaft as the two pulleys. This wheel governs all the motions of the blades. The trough, which is set low, is tilted over, when the dough is ready, by an endless chain operated by a hand winch. The effort required for this operation is very slight, as the trough is balanced by two weights. The action of tilting does not interfere with the blades, which continue rotating until stopped by the hand wheel. The Universal kneader was designed to imitate as closely as possible the action of a pair of skilled human arms and hands, but of course works at a much greater speed.

Another form of dough mixer which is extensively used consists simply of a drum made of sheet steel supported by two A-shaped standards at a sufficient height from the floor to allow a trough to be run underneath to receive the dough when ready for the moulding board. In this drum are two tight-fitting doors. The interior is fitted with no blades or knives, but presents a free cylindrical space, with the sole exception that, set not very far from the circumference, there are several fixed rods passing from one side of the drum to the other. These act as mixers of the dough. The door is opened and the flour and water poured in, whereupon the door is again fastened and the drum is made to rotate. As the rotation proceeds, the dough begins to form, and being lifted up by the revolving drum falls by its own weight. In this process, which is repeated again and again, the dough is caught by and tumbled over by the rods, which act as mixers and take the place of the revolving arms of the trough kneader. The kneading action of the rotating arms is absent, but the steady tumbling over these rods appears to have a thorough mixing effect, and the dough is discharged from the drum in good condition for moulding. The time occupied for making a dough by this apparatus varies from four to six minutes. The advantages claimed for this machine are that it consumes comparatively little power, and that there is not so much danger of "felling" or over-kneading dough as in some of the machines with revolving blades. The compactness of this rotating drum mixer, often known as the Rotary mixer, recommends it on shipboard and in other places where space is limited.

In the earlier days of machine bakeries the accurate dividing of dough, and still more the moulding of loaves by mechanical means, was considered an unattainable ideal. The first step in this direction was made by the Lewis-Pointon dough divider and weigher, which was intended for dividing and weighing out dough ready for the moulding table. In an ordinary way a baker who wishes to bake a batch of half-quartern or 2-lb loaves scales off 2 lb 2 oz. of dough for each loaf. The 2 oz. are a sort of insurance against light weight. The evaporation of moisture from dough in the oven is bound to reduce to some extent the weight of the baked loaf, but with normally baked bread, 2 lb 2 oz. in the case of half-quarterns, and 4 lb 4 oz. in the case of quartern loaves, is sufficient to ensure full weight. As the accurate scaling of dough requires some pains and trouble, it would be surprising if hand scaling were always accurate. The Lewis-Pointon machine can, it is claimed, be set to turn out lumps of dough of the exact weight required either for 1-lb, 2-lb, or 4-lb loaves. The apparatus does not measure the dough by weight but by volume by an ingenious piston arrangement. The machine when first put on the market was a little complicated, but its mechanism has since been simplified. It has been successfully worked on doughs of all descriptions, ranging from the tightest to those made with 20

gallons of water to the sack. The same firm which brought out this dough divider has also produced a dough-moulding machine, which has a wide range of work. In this apparatus the dough is introduced between a trough and a revolving table at a point on the outer periphery of the latter. The order of things observed in hand moulding is here reversed, as the trough, unlike the hand, is fixed, while the table revolves around a vertical axis. This table is sharply coned, and can be made to work the dough as much or as little as may be required. In working dough for tin or Coburg loaves only one trough is used, but for cottage loaves two parallel troughs are fitted, one taking the lower and the other the upper half of the loaf. In the latter case, a single piece of dough is fed into the machine and passed through an automatic splitter, the two portions being automatically carried into the troughs and simultaneously delivered at the other side of the machine ready to be put together. With doughs which require "handing-up," two machines may be used for moulding, the dough being automatically fed from the divider to the handing-up machine, and after a short proof passed through the finisher. But the moulding machine may also be used as a "hand-up."

Another ingenious dough moulder, known as the Baker-Callow, works on a rather different principle. Here the pieces of dough coming from the divider are fed into the moulder by a canvas band, and are worked between a large cylindrical roller and a vertically running canvas and leather belt. To prevent pieces from dropping through, and to assist the moulding process, a smaller roller is placed under and between the cylindrical roller and canvas belt. A wooden puncher also assists in working the loaves, which are finished by being rolled between a band and a special shaped wooden moulding. This machine delivers the dough in spherical shaped pieces. If intended for cottage bread they are at once placed on the dough table at the side, and one piece is put on the top of the other ready for the oven. It is claimed the machine will deal equally well with large and small pieces at the same time, so that the tops and bottoms can be made together. Should the machine be intended for tinned bread, a special attachment is used, into which the spherical pieces are delivered from the machine and rolled into cylindrical shapes, ready to be dropped into the pan. A capacity of sixty loaves per minute is claimed for this moulder.

Ovens.—The ordinary baker's oven is a vaulted chamber, about 10 ft. in length, by 8 ft. in width and 50 in. in height; it is constructed of brick or stone, and has a small door in front through which the oven is charged (by means of a "peel" or long wooden shovel) and the batch withdrawn. The furnace and fire-grate are often placed at the side of the oven door, but with the oldest ovens, which were heated by wood, there generally was only one door for the fuel and for the bread. Whether the furnace is heated by coal, as is usual in England, or by coke, as is often the case in Scotland, the oven mouth remains in the bakehouse itself; hence the stoking and scuffing must be carried out within the bakehouse. This is in many ways objectionable. For one thing, the fuel must almost of necessity be kept in the bakehouse itself, and it is obvious that the products of combustion are liable to get into the oven. In the old type of oven a flue was frequently placed on the other side of the furnace door, both furnace and flue being on the front of the oven. After firing the furnace, the oven is allowed to "lie down" for a certain time, and secure an even distribution of heat. The furnace and flue are then shut, and the oven charged, the batch being baked by the heat stored within the oven chamber. With ovens of this type, each batch of bread requires a separate firing. This kind of oven has undergone several improvements of detail, but the principle of internal heating, that is, of firing the furnace inside the bakehouse, has remained unchanged.

A new era in bakers' ovens began about the middle of the 19th century with the introduction of the "Perkins" oven, a system which, with slight modifications, has persisted till to-day. In this oven the baking chamber is heated by steam pipes. The latter consist of tubes of iron or mild steel which are partly filled with water and are hermetically sealed by welded ends. The pipes are arranged in two parallel rows, the one at the crown and the other at the sole of the oven. The pipes project at one end into the furnace, which is set at the back of the oven and is usually outside the bakehouse. This is termed an externally heated oven. As the ends of the pipes get red hot the water is converted into superheated steam, which being under high pressure soon raises the chamber to baking heat, say 450° to 500° F. In an oven of this description the heat can be continuously maintained, and batch after batch can be baked without refring. The only drawback is that a flash heat cannot be raised. In another type of externally fired oven the heat is conveyed by flues placed at the bottom and top of the oven, which discharge into a chimney. Excellent results have been attained with ovens of this kind. The distribution of the heat can be well regulated; for instance, it is quite possible to build ovens to be cooler at the back than front, an arrangement which is useful when the bread is withdrawn by means of a hand peel. As the baker has to withdraw each loaf one at a time, it is clear that the withdrawal of the batch through the oven door must take time, probably not less than half-an-hour. Hence the bread drawn from near the oven's mouth may be underbaked as compared with that at the back of the chamber. The latter, on the other hand, may be overbaked and deficient in weight.

Dough dividers and moulders.

By means of a draw-plate, however, an oven can be expeditiously charged. This appliance consists of a sliding plate or tray, mounted on wheels running on rails, which is drawn out of the oven loaded with bread, and then returned. The plate itself is often made of iron, but one well-known oven is fitted with a withdrawable iron frame, in which are laid, edge to edge, tiles of a special make, which are cemented in place, and form a continuous baking surface. This seems an excellent arrangement, as the baker has all the advantages of a brick oven, that is to say, his bread is baked both on top and bottom by heat evolved from tiled surfaces, and the undoubted drawbacks incidental to baking bread on an iron surface are avoided. A draw-plate fitted to an oven capable of baking a batch made from a sack (280 lb) of flour can be run out, charged and run in again, in about two minutes. The draw-plate has the incidental advantage, by expediting the loading and discharge of the oven, of ensuring a more uniform baking of the batch, and therefore of minimizing the loss of weight. Some bakers have gone so far as to estimate the saving in this respect from the use of a draw-plate at half an ounce per 2-lb loaf. With decker ovens a double draw-plate may be used, the feet of the pedestal supporting the upper draw-plate running on a rail outside, but parallel to the rail on which the lower draw-plate runs. This arrangement, however, is more applicable to small than large ovens. Or the lower oven may be fitted with a draw-plate while the upper oven is served with a peel. The draw-plate being at a lower level than the sole of an ordinary oven, the upper deck may be worked with a peel without much difficulty.

The *decker* oven is, as its name implies, an oven built over another oven: in fact, sometimes a tier of three ovens is employed, placed one above the other. The object is to secure a double or treble baking surface without a very much larger outlay on fuel than would be necessary for one oven. It is easy to understand that a double or three decker oven might be constructed under conditions where it would be impossible to place two or three ordinary ovens side by side. Practical bakers are somewhat divided as to the actual economy of the decker system: possibly it is a question of management. The upper oven is heated by the gases which have passed under the oven beneath. A double-decker oven on the flue principle could be heated by three flues, one beneath the lower oven, another passing between the crown of the lower and the sole of the top oven, and the third over the crown of the upper oven. If a third oven were built over the second, then a fourth flue would pass over the crown of the third and top oven. In such an arrangement of flues the distribution of heat to the ovens would be fairly equal, but no doubt the lower oven would be the hottest. In addition to the flues, which should be straight and accessible for cleaning, there ought also to be auxiliary flues by which heat may be allowed to pass dampers to the upper portions of the series of ovens. In this way the heat of the upper oven or ovens can be regulated independently to a great extent of the bottom oven. The power of regulating the heat of the ovens is very necessary, because a baker doing what is called a mixed trade, that is to say, producing cakes and pastry in addition to bread, must work his ovens at varying temperatures. Cakes cannot be baked at the heat (about 450° F.) required by a batch of household bread. The richest fancy goods, such as wedding and Christmas cakes, require the coolest ovens. Flue ovens are best worked with coke, as coal is apt to choke the flues; retort coke is recommended in place of oven coke. An oven should be fitted with some kind of thermal register, and both high-temperature thermometers and pyrometers are used for this purpose. (G. F. Z.)

BREADALBANE, JOHN CAMPBELL, 1ST EARL OF (c. 1636-1717), son of Sir John Campbell of Glenorchy, Bart., and of the Lady Mary Graham, daughter of William, earl of Airth and Menteth, was born about 1636. He took part in the abortive royalist rising under Glencairn in 1654, and was one of those who urged Monk to declare a free parliament in England to facilitate the restoration. He sat in the Scottish parliament as member for Argyllshire from 1660 to 1674. As principal creditor he obtained in October 1672, from George, 6th earl of Caithness, a conveyance of his dignities, lands and heritable jurisdictions; and after the latter's death he was created on the 28th of June 1677 earl of Caithness and viscount of Breadalbane. In 1678 he married the widowed countess of Caithness, an economical step which saved him the alimentary provision of 12,000 merks a year he had covenanted to pay. In 1680 he invaded Caithness with a band of 700 men and defeated and dispossessed the earl's heir male. The latter, however, was subsequently confirmed in his lands and titles, and Campbell on the 13th of August 1681 obtained a new patent with the precedence of the former one, creating him earl of Breadalbane and Holland, viscount of Tay and Paintland, Lord Glenorchy, Beneralloch, Ormelie and Wick in the peerage of Scotland, with special power to nominate his successor from among the sons of his first wife. In 1685 he was a member of the Scottish privy council. Though nominally a Presbyterian he had assisted the intolerant and despotic

government of Lauderdale in 1678 with 1700 men. He is described as having "neither honour nor religion but where they are mixed with interest," as of "fair complexion, of the gravity of the Spaniard, cunning as a Fox, wise as a Serpent and supple as an Eel."¹ He was reputed the best headpiece in Scotland.² His influence, owing to his position and abilities, was greater than that of any man in Scotland after Argyll, and it was of high moment to King William to gain him and obtain his services in conciliating the Highlanders. Breadalbane at first carried on communications with Dundee and was implicated in the royalist intrigue called the "Montgomery plot," but after the battle of Killiecrankie in July 1689 he made overtures to the government, subsequently took the oath of allegiance, and was entrusted with a large sum of money by the government to secure the submission of the clans. On the 30th of June 1691 he met the Jacobite chiefs and concluded with them secret articles by which they undertook to refrain from acts of hostility till October, gaining their consent by threats and promises rather than by the distribution of the money entrusted to him, the greater part of which, it was believed, he retained himself. When asked to give an account of the expenditure he replied: "The money is spent, the Highlands are quiet, and this is the only way of accounting between friends."³

On the 27th of August a proclamation was issued offering indemnity to all those who should submit and take the oath of allegiance before the 1st of January 1692, and threatening all those who should refuse with a military execution and the penalties of treason. All the chiefs took the oath except MacIain, the chief of the MacDonalds of Glencoe, who postponed his submission till the 31st of December, and was then prevented from taking the oath till the 6th of January 1692 through the absence of a magistrate at Fort William, whither he had repaired for the purpose. This irregularity gave Breadalbane an immediate opportunity of destroying the clan of thieves which had for generations lived by plundering his lands and those of his neighbours. Accordingly, together with Argyll and Sir John Dalrymple (afterwards Lord Stair), Breadalbane organized the atrocious crime known as the "Massacre of Glencoe," when the unfortunate MacDonalds, deceived by assurances of friendship, and at the moment when they were lavishing their hospitality upon their murderers, were butchered in cold blood on the 13th of February 1692. Breadalbane's astuteness, however, prevented the disclosure of any evidence against him in the inquiry afterwards instituted in 1695, beyond the deposition of a person who professed to have been sent on Breadalbane's behalf to obtain a declaration of his innocence from MacIain's sons, who had escaped. The discovery of his former negotiations with the Jacobite chiefs caused his imprisonment in Edinburgh Castle in September, but he was released when it was known that he had been acting with William's knowledge.

Breadalbane did not vote for the Union in 1707, but was chosen a representative peer in the parliament of Great Britain of 1713-1715. His co-operation with the English government in securing the temporary submission of the Highlands was inspired by no real loyalty or allegiance, and he encouraged the attempted French descent in 1708, refusing, however, to commit himself to paper. On the occasion of the Jacobite rising in 1715 he excused himself on the 19th of September from obeying the summons to appear at Edinburgh on the ground of his age and infirmities; but nevertheless the next day visited Mar's camp at Logierait and afterwards the camp at Perth, his real business being, according to the Master of Sinclair, "to trick others, not to be tricked," and to obtain a share of the French subsidies. He had taken money for the whole 1200 men he had promised and only sent 300. His 300 men were withdrawn after the battle of Sheriffmuir, and his death, which took place on the 19th of March 1717, rendered unnecessary any inquiry into his conduct. He married (1) Mary, daughter of Henry Rich, 1st earl of Eolland,

¹ *Memoirs of John Macky* (Roxburghe Club, 1895), 121.

² *Corr. of Col. N. Hoche* (Roxburghe Club, 1870), i. 49.

³ Note by Sir W. Scott in Sinclair's *Mem. of Insurrection in Scotland* (Abbotford Club, 1858), 185.

by whom he had two sons, Duncan, styled Lord Ormelie, who was passed over in the succession, and John, 2nd earl of Breadalbane; (2) Mary, daughter of Archibald, marquis of Argyll, and widow of George, 6th earl of Caithness, by whom he had one son, Colin. By Mrs Mildred Littler, who has sometimes but probably in error been named as his third wife, he had a daughter, Mary.

JOHN CAMPBELL, 2nd earl of Breadalbane (1662-1752), an eccentric nobleman, who was known as "Old Rag," was succeeded by his only son, John (c. 1696-1782). This earl was a diplomatist, being British ambassador to Denmark and to Russia, and a politician, being for a long time a member of the House of Commons and a supporter of Sir Robert Walpole, in addition to holding several official positions. All his sons having predeceased their father, the title passed on his death, on the 26th of January 1782, to a cousin, John (1762-1834), who became 4th earl and was created a British peer as marquis of Breadalbane in 1831. His son John, the 2nd marquis (1796-1862), a prominent leader of the Free Church during the ecclesiastical disputes in Scotland, died without sons in November 1862. The marquessate now became extinct, but the Scottish earldom passed to a cousin John Alexander (1824-1871), whose son and successor, Gavin (b. 1851), was created marquis of Breadalbane in 1885.

BREADALBANE, a large district of Perthshire, Scotland, bordered N. by Atholl, E. by Strathtay, S. by Strathearn and W. by the districts of Argyll and Lorne, and occupying some 1020 sq. m. Most of the surface is mountainous, Ben Lawers (3984 ft.), Ben More (3843), and Ben Lui (3708), being the principal hills. Loch Tay is the chief lake, and among the rivers are the Orchy, Dochart, Lochay, Lyon, Almond and the Tay (during the early part of its course). Population mostly centres in Aberfeldy, Fortingal, Kenmore and Killin. The soil is not cultivable excepting in some of the glens and straths. Game is plentiful, the lakes and rivers afford good sport, and the deer forests and shootings are valuable. The district has given the titles of earl and marquess to the Campbells of Glenorchy.

BREAD-FRUIT. This most important food staple of the tropical islands in the Pacific Ocean is the fruit of *Artocarpus incisa* (nat. ord. Moraceae). The tree attains a moderate height, has very large, acutely lobed, glossy leaves, the male flowers in spikes, and the female flowers in a dense head, which by consolidation of their fleshy carpels and receptacles form the fruit. The fruit is globular in shape, about the size of a melon, with a tuberculated or (in some varieties) nearly smooth surface. Many varieties of the tree are cultivated, the fruits of some ripening numerous seeds, which are eaten as chestnuts; but in the best kinds the seeds are aborted, and it is only these that are highly prized as vegetables. The tree is a native of the South Sea Islands, where its fruit occupies the important position that is held by cereals in temperate latitudes. The fruit, which on distinct varieties ripens at different periods, affording a nearly constant supply throughout the year, is gathered for use just before it ripens, when it is found to be gorged with starchy matter, to which its esculent value is due. It may be cooked and prepared for use in a great variety of ways, the common practice in the South Sea Islands being to bake it entire in hot embers, and scoop out the interior, which when properly cooked should have a soft smooth consistence, fibrous only towards the heart, with a taste which has been compared to that of boiled potatoes and sweet milk. Of this fruit A. R. Wallace, in his *Malay Archipelago*, says: "With meat and gravy it is a vegetable superior to anything I know either in temperate or tropical countries. With sugar, milk, butter or treacle it is a delicious pudding, having a very slight and delicate but characteristic flavour, which, like that of good bread and potatoes, one never gets tired of." In the Pacific Islands the fruit is preserved for use by storing in pits, where the fruits ferment and resolve themselves into a mass similar in consistency to new cheese, in which state they emit an offensive odour; but after baking under hot stones they yield a pleasant and nutritious food. Another and more common method of preserving the fruit for use consists in cutting it into thin slices, which are dried

in the sun. From such dried slices a flour is prepared which is useful for the preparation of puddings, bread and biscuits, or the slices are baked and eaten without grinding. The tree yields other products of economic value, such as native cloth from the fibrous inner bark of young trees; the wood is used for canoes and articles of furniture; and a kind of glue and caulking material are obtained from the viscid milky juice which exudes from incisions made in the stem.

The bread-fruit is found throughout the tropical regions of both hemispheres, and its first introduction into the West Indies is connected with the famous mutiny of the "Bounty," and the remarkable history of a small company of the mutineers at Pitcairn Island. Attention was directed to the fruit in 1688 by



Artocarpus incisa, the Bread-fruit tree.

- Fig. 1. Branch reduced about a 6th natural size, with cuneate-ovate pinnatifid leaves, male flowers in a club-shaped deciduous catkin, and female flowers in rounded clusters.
 Fig. 2. Transverse section of the male spike with numerous flowers.
 Fig. 3. Male flowers.
 Fig. 4. Single male flower separated, with a perianth in 2 segments and a single stamen.
 Fig. 5. Female flowers.
 Fig. 6. Single female flower separated, with ovary, style and bifid stigma.
 Fig. 7. Ovary.
 Fig. 8. Ovary laid open to show the ovule.
 Fig. 9. A variety of the ovary with 2 loculements.
 Fig. 10. Transverse section of a bilocular ovary.

Captain Dampier, and later by Captain Cook, who recommended its transplantation to the West Indian colonies. In 1787 the "Bounty" was fitted out under command of Lieutenant William Bligh (*q.v.*) to proceed to Tahiti to carry plants thence to the West Indian Islands; and it was after the cargo had been secured and the vessel was on her way that the mutiny broke out, and Lieutenant Bligh and some of his crew were turned adrift in a small boat in the open sea. The mutineers returned with the vessel to Tahiti, whence a number of them, with a few native men and women, sailed to the desolate and lone islet of Pitcairn. Lieutenant Bligh ultimately reached England, and was again commissioned to undertake the work of transplanting the plants, which in the year 1792-1793 he successfully accomplished.

A somewhat similar but inferior fruit is produced by an allied species, the Jack or Jak, *Artocarpus integrifolia*, growing in India, Ceylon and the Eastern Archipelago. The large fruit

is from 12 to 18 in. long by 6 to 8 in. in diameter, and is much eaten by the natives in India. This tree is chiefly valuable on account of its timber, which has a grain very similar to mahogany, and although at first light-coloured it gradually assumes much of the appearance of that wood.

BREAKING BULK, a nautical term for the taking out of a portion of the cargo of a ship, or the beginning to unload; and used in a legal sense for taking anything out of a package or parcel, or in any way destroying its entirety. It was thus important in connexion with the subject of bailment, involving as it did the curious distinction that where a bailee received possession of goods in a box or package, and then sold them as a whole, he was guilty only of a breach of trust, but if he "broke bulk" or caused a separation of the goods, and sold a part or all, he was guilty of felony. This distinction was abolished by the Larceny Act 1861, which enacted that whoever, being a bailee of any chattel, money or valuable security, should fraudulently take or convert the same to his own use, or the use of any person other than the owner, although he should not break bulk or otherwise determine the bailment, should be guilty of larceny (s. 3).

BREAKWATER. When a harbour (*q.v.*) is proposed to be established on an exposed coast, whether for naval or commercial purposes, to provide a protected approach to a port or river, or to serve as a refuge for vessels from storms, the necessary shelter, so far as it is not naturally furnished by a bay or projecting headlands, has to be secured by the construction of one or more "breakwaters." These breakwaters, having to prevent the waves that beat upon the coast from reaching the site which they are designed to protect, must be made sufficiently strong to withstand the shocks of the waves during the worst storms to which they are exposed. It is therefore essential, before constructing a breakwater, to investigate most carefully the force, periods and duration of the winds from the quarters to which the work will be exposed, the distance of any sheltering land from the site in the most stormy direction, the slope of the beach and the depth of the sea in the neighbourhood of the shore, and the protection, if any, afforded by outlying shoals or sandbanks. In a tidal sea, the height required for a breakwater is affected by the amount of tidal range; and the extent of breakwater exposed to breaking waves depends upon the difference in level between low and high water. The existence, also, of any drift of sand or shingle along the shore must be ascertained, and its extent; for the projection of a solid breakwater out from the shore is certain to affect this littoral drift, which, if large in amount, may necessitate important modifications in the design for the harbour.

Observations of the force and prevalence of the winds from the different quarters at the various periods of the year, and the *Winds* instruments by which they are recorded, belong to the science of meteorology; but such records are very valuable to the maritime engineer in indicating from which directions, open to the sea, the worst storms, and, consequently, the greatest waves, may be expected, and against which the most efficient shelter has to be provided. Moreover, it is necessary, for constructing or repairing a breakwater, to know the period of the year when the calmest weather may be safely anticipated, and also the stormy season during which no work should be attempted, and in preparation for which unfinished works have to be guarded by protective measures. In the parts of the world subject to periodical winds, such as the monsoons, the direction and force of the winds vary with remarkable regularity according to the seasons; and even such uncertain occurrences as hurricanes and cyclones generally visit the regions in their track at definite periods of the year, according to the locality. Even in western Europe, where the winds are extremely variable, violent gales are much more liable to beat upon the western and northern coasts in the winter months than at any other period of the year; whilst the calmest weather may be expected between May and August.

The size of waves depends upon the force of the wind, and the distance along which it blows continuously, in approximately

the same direction, over a large expanse of ocean. The greatest waves are, accordingly, encountered where the maximum distance in a certain direction from the nearest land, or, as it is termed, the "fetch," coincides with the line travelled *Waves* by the strongest gales. The dimensions, indeed, of waves in the worst storms depend primarily on the extent of the sea in which they are raised; though in certain seas they are occasionally greatly increased by the exceptional velocities attained by hurricanes and typhoons, which, however, are fortunately restricted to fairly well defined and limited regions. Waves have been found to attain a maximum height of about 10 ft. in the Lake of Geneva, 17 ft. in the Mediterranean Sea, 23 ft. in the Bay of Biscay, and 40 ft. in the Atlantic Ocean; whilst waves of 50 to 60 ft. in height have been observed in the Pacific Ocean off the Cape of Good Hope, where the expanse of sea reaches a maximum, and the exposure to gales is complete. The length of large waves bears no definite relation to their height, and is apparently due, in the long waves often observed in exposed situations, to the combination of several shorter waves in their onward course, which is naturally dependent on the extent of the exposure. Thus waves about 500 ft. in length have been met with during severe gales in the Atlantic Ocean; whilst waves from 600 to 1000 ft. long are regarded as of common occurrence in the Pacific Ocean during storms.

The rate of transmission of the undulation also varies with the exposure; for the ordinary velocity of the apparent travel of waves in storms has been found to amount to about 22 m. an hour in the Atlantic Ocean, and to attain about 27 m. an hour off Cape Horn. The large waves, however, observed in mid-ocean do not reach the coast, because their progress is checked, and their height and length reduced, by encountering the shelving sea-bottom, which diminishes the depth of water on approaching the shore; and the actual waves which have to be arrested by breakwaters depend on the exposure of the site, the existence of continuous deep water close up to the shore, and the depth in which the breakwater is situated. On the other hand, the height, and, consequently, the destructive force of waves, is increased on running up a funnel-shaped bay, by the increasing concentration of the waves in the narrowing width, just as the tidal range of a moderate tidal current is much augmented by its passage up the Bay of Fundy, or up the Bristol Channel into the Severn estuary, or by filling the shallow enclosed bay of St. Malo. This effect is intensified when the bay faces the direction of the strongest winds. Thus at Wick a mass of masonry weighing 1350 tons, placed at the head of the breakwater projecting half-way across the bay and facing the entrance, was moved by the waves during a violent storm; and a portion of Peterhead breakwater, weighing 3300 tons, was shifted 2 in. in 1898, indicating a wave-stroke of 2 tons per sq. ft. South-westerly gales, blowing up the Gulf of Genoa, cause large waves to roll into the bay, reaching a height of about 21 ft. in the worst storms.

Where outlying sandbanks stretch in front of a coast, as for instance the Stroombank in front of Ostend and the adjacent shore, and the sandbank opposite Yarmouth sheltering Yarmouth Roads, large waves cannot approach the land, for they break on the sandbanks outside. Waves, indeed, always break when, on running up a shoaling beach, they reach a depth approximately equal to their height; and the largest waves which can reach a shore protected by intervening sandbanks, are those which are low enough to pass over the banks without breaking.

The force of the wind, as transmitted by degrees to the sea, is manifested as a series of progressing undulations without any material displacement of the body of water, each undulation transmitting its accumulated force to the next in the direction the wind is blowing, till at last, on encountering an obstacle to its onward course, each wave, no longer finding any water to which to communicate its energy, deals a blow against the obstacle proportionate to its size and rate of transmission; or on reaching shoal water near the shore, the undulation is finally transformed into a breaking wave rushing up the sloping beach,

till, on its energy being spent, it recoils back to the sea down the beach. A breaking wave concentrates its transmitted force on a portion of the water forming the undulation, which, consequently, strikes a more powerful blow over a limited area against any structure than the more distributed shock of a simple undulation beating against a vertical wall. Moreover, the recoil of broken waves down a sloping beach or rubble mound produces a greater scour than the simple reflection of an undulation from a vertical wall, especially where the depth is sufficient to provide a cushion of water below the undulation, protecting the toe of the wall from the wash or recoil.

Types of Breakwaters.—There are three distinct types of breakwaters:—(1) A simple rubble or concrete-block mound; (2) a mound for the bottom portion, surmounted on the top by a solid superstructure of masonry or concrete; and (3) an upright-wall breakwater, built up solid from the sea-bottom to the top. The second type forms a sort of combination of the first and third types; and each type presents several varieties. In a few harbours, two different types have been adopted for different situations at the same place; but generally the choice of type is determined by the materials available at the site for the construction of the breakwater, the nature of the sea-bottom and the depth into which the breakwater has to be carried.

1. **Rubble and Concrete-Block Mound Breakwaters.**—A rubble mound consists merely of a mass of rubble stone, just as it is obtained from a neighbouring quarry, tipped into the sea along a predetermined line, till the mound emerges out of water. The rubble stone is deposited, either from barges, as adopted for the construction of the detached breakwater sheltering Plymouth Bay, or from wagons, having hinged opening flaps at the bottom for dropping their load, run out from the shore along staging erected in the proposed line, according to the method employed for the outer breakwater enclosing Portland Harbour, and the north-east breakwater at Colombo Harbour. The mound thus deposited is gradually consolidated under the action of the sea; and a tolerably stable form is by degrees attained by continued deposits of stone. This system of construction is very wasteful of materials, and can only be resorted to where extensive quarries close at hand are able to furnish readily and cheaply very large quantities of stone, especially where, as at Portland and Table Bay, convict labour has been advantageously utilized in quarrying. When the site is very exposed, the large waves in storms, dashing over a rubble-mound breakwater, carry the stones on the top, if unprotected, over on to the harbour slope, and in recoiling down the outer slope, draw down the stones on the face, so that the top and sea slope of the mound need replenishing with a fresh deposit of stones after severe storms.

Under the action of the breaking and recoiling waves, the mound assumes a very flat slope on the sea side, from a few feet above high-water down to several feet below low-water level (fig. 1). The flatness

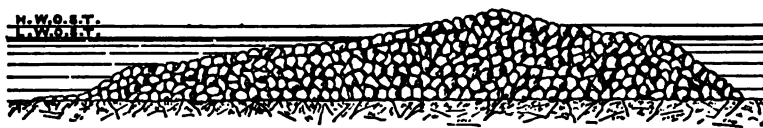

FIG. 1.—Table Bay Breakwater.

of the sea slope depends on the exposure of the site, and the limited size of the stones covering the outer portion of the mound; and its extent increases with the range of tide, as a large tidal rise exposes a greater length of slope to the action of the waves. This flattening of the sea slope greatly increases the amount of stone required for a rubble-mound breakwater, in proportion to the exposure and the range of tide; and the amount is also affected, but in a proportionately minor degree, by the depth in which the breakwater is situated. In order to avoid the injuries to which an ordinary rubble mound is subjected by waves, certain methods have been devised for protecting the top and sea slope of the mound. For instance, the upper portion of Plymouth breakwater has been covered over by granite paving set in cement, to diminish the displacement of the stones by the waves. Frequently, on the continent of Europe, rubble mounds have been formed of materials so sorted that the smallest stones are placed in the centre of the lower part of the mound, and covered over along the slopes and top by layers of larger stones, increasing in size towards the outer part of the mound, so that the largest stones obtainable are deposited on the outside, and especially on the top and sea slope of the mound. This is, no doubt, theoretically the correct method of construction of rubble mounds exposed to the sea; but it involves a considerable amount of trouble and expense.

Practically the chief point of importance is to cover the outer slope and the top of the mound with the largest stones that can be procured, and where large stones are not readily obtainable concrete blocks furnish a very convenient substitute. These blocks are generally deposited as the outer covering on the top and sea slope of a rubble mound, as for example, at the mound breakwaters in deep water sheltering Algiers harbour, and at the French ports of Cette and Bona on the Mediterranean; whilst they furnish the protection of the top and upper part of the sea slope of the rubble-mound extension of Marseilles breakwater down to 20 ft. below sea-level. At Alexandria, concrete blocks compose the outer half of the mound, sheltering the inner half consisting of small rubble (fig. 2); at Biarritz the mound breakwater is



FIG. 2.—Alexandria Breakwater.

formed mainly of concrete blocks, with rubble stone filling the interstices and on the top; whereas at the outer end of the western breakwater at Port Said, protecting the entrance to the Suez Canal, a bottom layer of rubble is surmounted by concrete blocks. These blocks are generally deposited at random; but at Cette (fig. 3), and at the breakwater in deep water at Civita Vecchia, the concrete blocks covering the rubble have been laid in stepped, horizontal courses. This arrangement necessitates more care and better appliances in construction; but, in compensation, the blocks so placed are less exposed to disturbance and injury by the waves. Concrete blocks possess the great advantages for breakwaters that they can be made wherever sand and shingle can be procured, and of a size only limited by the appliances which are available for



FIG. 3.—Cette Breakwater.

handling them. In fact, in places where stone of any kind is difficult to procure at a reasonable cost, as for instance at Port Said, concrete blocks are indispensable for the construction of breakwaters. Large concrete blocks, moreover, by enabling a comparatively steep slope to be formed with them on the sea side of a mound breakwater, reduce considerably the amount of materials required, especially at exposed sites, and also for breakwaters extended into deep water, such as those of Algiers and Marseilles.

Occasionally, in the absence of suitable rubble stone, a mound breakwater has been formed entirely with concrete blocks; and of this the main portion of the western breakwater at Port Said furnishes a notable example (fig. 4). Sometimes, in exposed situations, the mounds of the composite type of breakwaters have been constructed exclusively with concrete blocks, such, for instance, as in the curved breakwater protecting the outer harbour at Loughorn, and in the central breakwater in deep water sheltering the harbour of St Jean de Luz, and directly facing the Bay of Biscay. These large concrete blocks are deposited by cranes from staging, tipped into the sea from a sloping platform on barges, or floated out between pontoons, or slung out from floating derricks. This last method proved so expeditious for the upper blocks at Alexandria that, in conjunction with the tipping of the lower blocks from the inclined planes on the decks of barges and the deposit of the rubble from hopper barges, provided also with side flaps for the higher portions, the detached breakwater, nearly 2 m. long, sheltering a very spacious harbour, was constructed in two years (1870-1872). Sometimes, when a mound breakwater has been raised out of water, advantage is taken of a calm period of the year and a low tide to form large blocks of concrete within timber framing on the top of the mound, so as to provide a very efficient protection.



FIG. 4.—Port Said Western Breakwater.

Concrete blocks with rubble mound.

Concrete block mound.

The large masses composing mound breakwaters give them great stability against the attacks of the sea; and, moreover, the wide base of the mounds enables them to be deposited on a sandy or silty sea-bottom, without any fear of settlement or undermining. A mound breakwater, however, has the disadvantages of requiring a large amount of material, and of occupying a wide space on the bed of the sea, more especially where the mound consists of rubble stone and is in deep water, so that the system, though simple, is costly, and is unsuited for harbours where the available space to be sheltered is limited. Nevertheless, a mound breakwater can be rapidly constructed by the employment of a large number of barges; and by the adoption of large concrete blocks, the quantity of materials and the space occupied by the mound can be considerably reduced. This form of breakwater, with its long outer slope exposed to breaking waves, particularly where the tidal range is considerable, is, indeed, more subject to frequent small injuries than the other types, but they are readily repaired; and a mound is not generally liable to the serious breaches which occasionally are formed in solid superstructures and upright walls in exceptional storms.

2. *Breakwaters formed of a Mound surmounted by a Superstructure.*—The second type of breakwater consists of a mound, composed of rubble or concrete blocks, or generally a combination of the two, carried up from the sea-bottom, on the top of which some form of solid superstructure is erected. This superstructure reduces considerably the amount of materials required (which, on account of the slopes of the mound, increases rapidly with the height) in proportion to the depth at which the superstructure is founded; and the solid capping on the mound serves also to protect the top of the mound from the action of the waves. In the case, however, of a mound breakwater, portions of the highest waves generally pass over the top of the mound, and also to some extent expend their force in passing through the interstices between the blocks; whereas a superstructure presents a solid face to the impact of the waves. A superstructure, accordingly, must be very strongly built in proportion to the exposure, and also to the size of the waves liable to reach it, which depends upon the height and flatness of the slope of the mound just in front of it on the sea side. Special care, moreover, has to be taken to prevent the superstructure from being undermined; for the waves in storms, dashing up against this nearly vertical, solid obstacle, tend in their recoil down the face to scour out the materials of the mound at the outer toe of the superstructure, and thereby undermine it, especially where the superstructure is founded on the mound near low-water level, and there is, therefore, no adequate cushion of water above the mound to diminish the effect of the recoil on the foundation.

The mound constituting the lower portion of the composite type of breakwater has been formed in the same varied way as simple mound breakwaters, namely, of rubble, sorted rubble, rubble protected by concrete blocks, and wholly of concrete blocks. The only differences introduced in the mound in this case are, that it is not carried up so high, that the top portion covered by the superstructure needs no further protection, and that special protection has to be provided on the slope of the mound adjacent to the outer toe of the superstructure.

The forms of the superstructures exhibit considerable variations, ranging from a few concrete blocks laid in courses on the top of the mound, or a paving furnishing a quay protected by a narrow parapet wall on the sea side, up to a large, solid structure, only differing from an upright-wall breakwater in being founded upon a mound, instead of on the sea-bottom. Notwithstanding, however, this great variety in design, these breakwaters may be divided into two distinct classes, namely, breakwaters having their superstructures founded at or near low-water level, and breakwaters with superstructures founded some depth below low water. The object in the first case is to lay the foundations of the superstructure on the mound at the lowest level consistent with building a solid structure with blocks set in mortar, out of water, in the ordinary manner; and, in the second case, to stop the raising of the mound at such a depth under water as to secure it from displacement by the waves. In fact, the solidity and facility of construction of the superstructure were the primary considerations in the older form of breakwater; whereas the stability of the mound and the avoidance of the undermining of the superstructure have been regarded as the most important provisions in the more modern form.

Well-known examples of breakwaters formed of a rubble mound surmounted by a superstructure founded at or near low water or sea-level, are furnished by Cherbourg and Holyhead breakwaters, the inner breakwater at Portland, and the breakwaters at Marseilles, Genoa, Civita Vecchia, Naples, Trieste and other Mediterranean ports. The very exposed breakwater at Alderney was commenced on this principle about the middle of the 19th century; and the outer breakwaters at Leghona and St Jean de Luz have superstructures founded at low water on concrete-block mounds.

The long, detached breakwater sheltering the series of basins formed by wide projecting jetties along the sea coast at Marseilles (see DOCK), is a typical instance of a breakwater where a quay has been formed on the top of a sorted rubble mound, sheltered on the sea side by a high wall, or narrow superstructure, founded at sea-level, and protected on the sea slope of the mound from undermining by large concrete blocks deposited at random (fig. 5). In this case the quay has been rendered accessible for vessels on the harbour side by a quay wall, formed of concrete blocks deposited



FIG. 5.—Marseilles Breakwater, central portion.

one above the other, providing a vertical face to a depth of about 22 ft. below sea-level; and a similar arrangement has been adopted at Trieste, and in a less effective manner at Civita Vecchia and Naples. At Marseilles, however, when the breakwater reached great depths, the quay was abandoned on account of the increased exposure, and the extension made of a simple rubble mound, protected on the sea side, from the top down to 20 ft. below sea-level, by large concrete blocks deposited at random.

The superstructures at Holyhead and Portland, being built on the old weak system of a sea wall and a harbour wall, with rubble filling between, are protected on the sea side by raising the rubble against them from low water up to high water of spring tides; whereas the superstructure of Cherbourg breakwater, being built solid and less exposed, is only protected on the sea side by large rubble and some concrete blocks, forming an apron raised slightly above low water. These three breakwaters are provided with a quay sheltered by a raised wall or promenade on the sea side; but as the mound on the harbour side is raised up to, or a little above low water, the quay is only accessible for vessels near high water. This, however, is of comparatively little importance, since these quays, though very useful for access to the end of the breakwater in fairly calm weather, are inaccessible in exposed situations with a rough sea; and quays for the accommodation of vessels are better provided well within the sheltered harbour.

The outer portions of the main breakwaters at Genoa and at Naples (fig. 6), extending into depths of about 75 ft. and 110 ft. respectively, have been provided with superstructures, similar in type, but more solid than the superstructure at Marseilles; and the sorted rubble mounds upon which the superstructures rest are

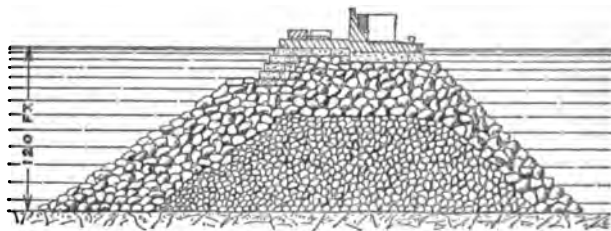

FIG. 6.—San Vincenzo Breakwater, Naples.

protected on the sea slope by stepped courses of concrete blocks from a depth of 26 ft. below sea-level, covered over at the top by a masonry apron forming a prolongation of the superstructure. The outer extension of the main breakwater at Civita Vecchia furnishes an interesting example of a composite form of breakwater, in which the rubble mound has been protected, and greatly reduced in volume and extent in deep water, by stepped courses of concrete blocks carried up from near the bottom of the mound (fig. 7).

The breakwaters in front of Havre, constructed in 1896-1907, for sheltering the altered entrance to the port, were formed of a sorted rubble mound, protected on the sea slope by concrete blocks, and raised a little above low water of spring tides, upon which large blocks of masonry, built on land, were deposited with their upper surfaces about 18 in. above low water of neap tides. As soon as settlement of the mound under the action of the sea appeared to have ceased, these masonry blocks were connected together by filling the spaces between them with masonry; and a solid masonry superstructure was built during low tide on this foundation layer, as shown in fig. 8.

The breakwaters constructed for forming harbours on the sea coast of the United States are almost all rubble-mound breakwaters. The two old detached breakwaters sheltering Delaware Harbour near the south-eastern extremity of Delaware Bay, were formed of simple rubble mounds raised about 13 ft. above low water; but in closing the gap between them towards the close of the 19th century, the rubble mound was stopped at low water, and a sort of superstructure, consisting of stepped courses of large rectangular blocks of stone on the sea and harbour sides, with tightly packed rubble between them and capped across the top for a width of 20 ft. with a course of large blocks, was raised to 14 ft. above low water, resembling, on a

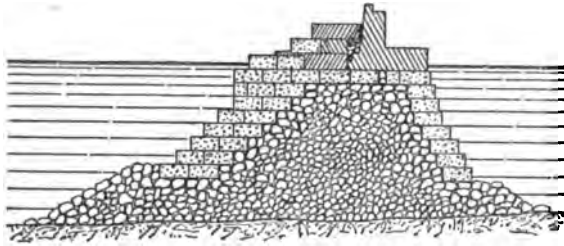

FIG. 7.—Civita Vecchia Outer Breakwater.

small scale, the upper part of the Civita Vecchia mound (fig. 7). A similar construction was adopted for the new breaker formed in 1807-1901 for providing a harbour of refuge at the mouth of Delaware Bay; but in this instance the mound was made considerably wider at the top, and had to be protected along the toe of the superstructure on the sea side by large stones. The same form of superstructure, also, on a narrower base, was resorted to for a breaker in deeper water at San Pedro in California with satisfactory results. When, however, a breaker of the Delaware type was in progress for forming a harbour of refuge in Sandy Bay, Massachusetts, in front of Rockport to the north of Boston, the upper 13 ft. of the 600 ft. of completed superstructure were carried away during a severe storm in 1898, leaving only a portion about 5 ft. in height above low water, the average rise of tide there being 8½ ft. The design was, accordingly, modified in 1902, by commencing the stepped courses of large stones at 12 ft. below mean low water on each slope, instead of at low water, raising this kind of superstructure to 22 ft. above low water in place of 18 ft., and capping the stepped courses at the top by large blocks of stone, 20 ft. long and 5 ft. deep, laid across the breaker, which thus presented a marked resemblance to the upper section of the mound at Civita Vecchia.

The breaker at Sandy Bay just referred to, and the one at Civita Vecchia, which it somewhat resembles, approximate to that class of breaker which has a superstructure founded below low-water level, so far as stepped courses of blocks can be regarded as forming part of a superstructure; but as the protection afforded by these courses differs only in the arrangement of the blocks from that obtained by blocks deposited at random, it appears expedient to restrict this class to the more solid structures, resembling upright-wall breakwaters, founded on a mound at some depth below low water. As the main object of this class of breaker is to keep the mound below the zone of disturbance by waves in severe storms, it is evident that the depth at which the superstructure is founded should vary directly with the exposure of the site, and inversely with the size of the materials forming the mound.

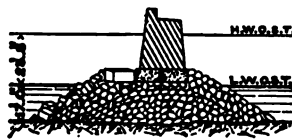

FIG. 8.—Havre Breakwater.

though fully exposed to the Atlantic Ocean, was begun with a superstructure founded at low water of spring tides upon a rubble mound; but within two years the foundations had to be carried down 12 ft. below low water, and this was adhered to till close to the head, though the breaker, completed in 1864, extended 4700 ft. from the shore into a depth of 130 ft. at low tide, the rise of springs being 17 ft. The great recoil of the waves in storms from the promenade wall on the sea side of the superstructure, raised 33 ft. above low water, disturbed the sea slope of the mound along the outer portion, situated in depths of 80 to 130 ft. at low water, out to a distance of 90 ft. from the superstructure and to a depth of 20 ft.; whilst the

outer toe of the superstructure was only preserved from being undermined by frequent deposits of stone along the sea face.

The south-west breaker at Colombo Harbour, constructed in 1876-1884, facing the sea raised by the south-west monsoon, extends into a depth of 39 ft. at low water, where the rise of tide is only 2 ft. at springs, and was built with a superstructure founded upon a rubble mound at a depth of 20 ft. below low water, but raised only 12 ft. above this level without any parapet, and protected along its sea face by an apron of concrete in bags. In this case, not only was the depth of the sea much less than at Alderney, but the small elevation of the superstructure above low water enabled a portion of the waves in storms to pass over it without materially impairing the shelter inside. These circumstances reduced the shock and recoil of the waves; and the greater depth of the foundations and the protection of the toe of the superstructure greatly diminished the danger of undermining. Consequently, the Colombo breaker has been preserved from the injuries to which the outer part of the Alderney breaker succumbed. Nevertheless, in subsequently constructing the north-west detached breaker, less exposed to the south-west monsoon, but in somewhat deeper water (see COLOMBO), the experience of the action of the sea on the south-west breaker led to the laying of the foundations of the superstructure on the rubble mound at 20½ ft. below low water (fig. 9).

The breaker for sheltering Peterhead Bay, where the rise of springs is 11½ ft., was begun in 1888, and designed to extend into a depth of 9½ fathoms at low water (see HARBOUR). It was built as an upright wall upon the rocky bottom for 1000 ft. from the shore; but owing to the increase in depth it was decided to construct the outer portion with a rubble base, surmounted by a superstructure originally designed to be founded 30 ft. below low water. As, however, during a storm in October 1898, the recoil of the waves from the breaker, which is provided with a promenade wall rising about 35 ft. above low water, disturbed rubble to a depth of 36½ ft., the superstructure has been founded 43 ft. below low water on the rubble base; and its outer toe is protected from being undermined by two rows of concrete blocks on the rubble mound.

Formerly, in constructing a large superstructure upon a rubble mound, it was a common practice to build a sea wall and a harbour wall several feet apart, and to fill up the intermediate space between them with rubble, so as economically to form a wide structure on the top of the mound, and provide an adequate width for a quay along the top. A sheltering wall was also generally erected on the sea side. This, for instance, was the system of construction adopted for the superstructures, founded at low water, of Holyhead breaker, Portland inner breaker, and St Catherine's, Jersey, breaker, the Tyne breakers and Colombo south-west breaker were also commenced with a precisely similar method of construction. The system, however, possesses a very serious defect for exposed situations, namely, that if once Fig. 9.—Colombo North-West Breakwater.

the sea can force a small opening through the sea wall, the scooping out of the rubble filling, and the overthrow of the thinner harbour wall are rapidly accomplished if the storm continues or recurs before repairs can be effected. Experience soon proved at Alderney and Tyne, and the unsuitability of the system for very exposed situations, and the intermediate rubble filling was replaced by solid bearing down to a certain depth. At Colombo, after the first 1326 ft. of the south-west breaker had been built with two walls and intermediate rubble for the superstructure, as the exposure proved greater than had been anticipated, and a slight displacement of part of the sea wall, 24 ft. wide, had occurred, the rubble filling was discontinued, and the two walls were united into a solid superstructure 34 ft. in width.

A difficulty experienced in constructing a solid superstructure on the top of a rubble mound consists in the settlement of the mound which takes place when the weight of the superstructure comes on it, in spite of the consolidation of the rubble under the action of the sea for one or two years before the erection of the superstructure on it is undertaken. When the superstructure is carried out in long stepped-forward courses, irregular settlement is particularly liable to occur, as the weight is progressively imposed in an uneven manner on the yielding rubble, in proportion to the height of the rubble base and its deficiency in compactness. The open joints between the blocks laid below low water enable the air to penetrate, on the recoil of the waves at low tide, into any internal fissures resulting from settlement; and the following wave, on striking the superstructure,



compresses the air inside, which, on its expansion when the wave recedes, forces out any unconnected face stones. The hole thus formed is rapidly enlarged by the sea if the storm continues; and a breach is eventually formed. The sloping-block system was, accordingly, devised to provide against the dislocation of superstructures by the inevitable irregular settlement, by forming them of a series of sloping sections, composed of concrete blocks laid at an angle, free to settle independently on the mound, as shown in fig. 10. In the first superstructure thus constructed, in 1869-1874, at the entrance to Karachi harbour, founded 15 ft. below low water on a rubble mound and 24 ft. high, the blocks in each section, consisting of two rows of three superposed blocks laid at an inclination of 76° shorewards, were entirely unconnected; and, consequently, though the superstructure offered as little opposition as practicable to the waves by having its top slightly below high water, the waves in a storm, forcing their way into the vertical joint between the two rows, threw some of the top 27-ton blocks of the inner row down on the harbour slope of the mound. This cause of damage was obviated in effecting the repairs, by connecting the top blocks with the next ones by stone dowels. The superstructures of the breakwaters forming Madras harbour, commenced in 1876, were similarly constructed in sloping, independent sections, 4½ ft. thick, composed of two distinct rows of four tiers of blocks founded upon a rubble mound 22 ft. below low water (the rise of tide at springs being 3½ ft.), and raised 3½ ft. above high water. The blocks in each row were connected by a tenon, projecting at the top of each block, fitting into a mortise in the block above it. The retention of the vertical joint, however, between the two rows led to the overthrow of the greater part of the superstructures of the outer arms at Madras, situated in a depth of 45 ft. and facing the Indian Ocean, during a cyclone of 1881. In the reconstruction of these superstructures, bond was introduced in the successive tiers of each sloping section; and the blocks of the two upper tiers were cramped together. After

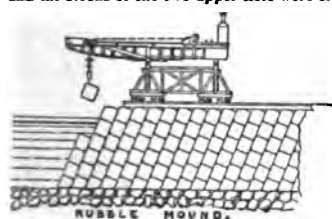

FIG. 10.—Colombo North-West Breakwater with Titan Crane.

settlement on the mound had ceased, a thick capping of mass concrete was laid all along the top of the superstructure; and, finally, a mound of concrete blocks was deposited at random on the mound in front of the sea face of the superstructure to break the force of the waves and prevent undermining. A similar wave-breaker, with blocks somewhat specially arranged, was deposited in front

of the sloping concrete-block superstructure of the breakwater sheltering the Portuguese harbour of Marmagao on the west coast of India, more particularly with the object of preventing the undermining of the superstructure founded only 18 ft. below low water of spring tides, on a layer of rubble spread on the muddy sea-bottom, the settlement in this case being occasioned by the yielding of the soft clay bed. This breakwater having been commenced in 1884, subsequently to the failure at Madras, the superstructure, formed of concrete blocks weighing 28½ to 37½ tons, was built in accordance with the design adopted for the reconstructed outer arms at Madras, with the exceptions that the separate sections were given a slope of 70° instead of 76° shorewards to ensure greater stability, that the superstructure was made 30 ft. in width instead of 24 ft., that the top tier of blocks in each section was secured to the next tier by two dowels, each formed of a bundle of four rails, penetrating 3½ ft. into each tier, so as to enable the top courses to be more correctly aligned than with tenons and mortises, and that the outer side of the continuous concrete-in-mass capping was raised about 22 ft. above low water (fig. 11). The rise of spring tides at Marmagao is 6 ft.

At Colombo the superstructures of both the south-west and north-west breakwaters were built on the sloping-block system in sections 5½ ft. thick, and built at an angle of 68° shorewards (fig. 10); and the blocks, from 16½ to 31 tons in weight, were laid in bonded courses across each section, with four tiers of blocks in the south-west breakwater founded 20 ft. below low water on the rubble mound, and six tiers of blocks in the north-west breakwater, founded 30 ft. below low water. Five oblong grooves, moreover, were formed in moulding the blocks, in the adjacent faces of each sloping section, extending from top to bottom of the sections. These, when settlement on the mound had ceased, were filled with concrete in bags, which not only connected the tiers of blocks in each section together, but also joined the several sections to one another, and

effectually closed the transverse joints between the successive sections, which were further connected together by a continuous capping of concrete-in-mass along the whole length of the breakwater.

These sloping blocks are laid by powerful overhanging, block-setting cranes, called Titans (see CRANES), which travel along the completed portion of the breakwater, and lay the blocks in advance on the mound levelled by divers, as shown in fig. 10. The earlier Titans, employed for the sloping-block superstructures at Karachi and Madras, were constructed to travel only backwards and forwards on the completed work, with sufficient sideways movement of the little trolley travelling along the overhanging arm, from which the block is suspended at the proper angle, to lay the blocks for each side of the superstructure. In later forms, however, such for instance as the Titan laying the 14-ton blocks at Peterhead breakwater in horizontal courses, the overhanging arm is supported centrally on a ring of rollers, placed

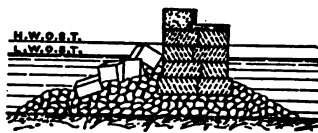

FIG. 11.—Marmagao Breakwater.

on the top of the truck on which the Titan travels, so that it can revolve and deposit blocks at the side of the superstructure for protecting the mound, as well as in advance of the finished work. These Titans possess the important advantage over the timber staging formerly employed for such breakwaters, that, in exposed situations, they can be moved back into shelter on the approach of a storm, or for the winter or stormy months, instead of, as in the case of staging, remaining out exposed to the danger of being carried away during stormy weather, or necessitating loss of time in erection at the beginning of the working season.

Though composite breakwaters are still occasionally constructed with a superstructure founded on a rubble mound at, or above, low-water level, these breakwaters are now almost always constructed with the superstructure founded at some depth below low water, even at harbours on the continent of Europe, where formerly broad quays founded at sea-level, protected by a parapet wall and outer concrete blocks, were the regular form of superstructure adopted. The breakwater for the extension of the harbour at Naples provides an interesting example of this change of design. A solid superstructure, formed of large concrete blocks capped with masonry, about 50 ft. wide at the base, is laid on a high rubble mound at a depth of 31 ft. below mean sea-level, and provides a quay on the top, 24½ ft. wide, protected on the sea side by a promenade wall, 10 ft. high and 12½ ft. wide at the top, raised 19½ ft. above sea-level (fig. 12). In view of the increased depth at which superstructures are now founded upon rubble mounds, causing the breakwaters to approximate more and more to the upright-wall type, it might seem at first sight that the rubble base might be dispensed with, and the superstructure founded directly on the bed of the sea. Two circumstances, however, still render the composite form of breakwater indispensable in certain cases: (1) the great depth into which breakwaters have sometimes to extend, reaching about 56 ft. below low water at Peterhead, and 102 ft. below mean sea-level at Naples; and (2) the necessity, where the sea-bottom is soft or liable to be eroded by scour, of interposing a wide base between the upright superstructure and the bed of the sea.

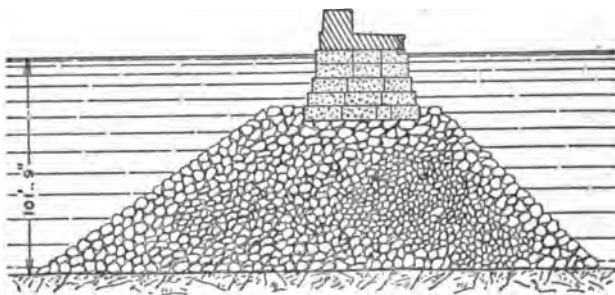

FIG. 12.—Naples Harbor Extension Breakwater.

The injuries to which composite breakwaters appear to have been specially subject must be attributed to the greater exposure and depth of the sites in which they have been frequently constructed, as compared with rubble mounds or upright walls. The latter types, indeed, are not well suited for erection in deep water, in the first case, on account of the very large quantity of materials required

for a high mound with flat slopes, and in the second, owing to the increased pressure of air under which divers have to work in laying blocks for an upright wall in deep water. The ample depth in which superstructures are founded, the due protection afforded to their outer toe, the adoption of the sloping-block system for their construction, and the dispensing in most cases with a high sheltering wall on the sea side of the superstructure, render modern superstructures as stable as upright-wall breakwaters of similar height. Nevertheless, superstructures require to be given a greater thickness than similar upright walls, because the greater depth of water in which such composite breakwaters are built causes them to be exposed to larger waves under similar conditions.

The superstructures of composite breakwaters erected by the United States for harbours on the shores of Lake Superior were formerly in some cases composed of timber cribs floated into position and sunk by filling them with rubble stone. On account of the cheapness of timber several years ago in those regions, this simple mode of construction was also economical, even though the rapid decay of the timber in the portions of the cribs where it was alternately wet and dry involved its renewal about every fifteen years on the average. Owing, however, to the fact that the price of timber has increased considerably, whilst that of Portland cement has been reduced, durable concrete superstructures are beginning to be substituted for the rapidly decaying cribwork structures.

With the exception perhaps of the Alderney breakwater, which, owing to its exceptional exposure and the unparalleled depth into which it extended, had its superstructure so often breached by the sea that, owing to the cost of maintenance, the inner portion only has been kept in repair, the composite breakwater of Bilbao harbour has probably proved the most difficult to construct on account of its great exposure. The original design consisted of a wide rubble mound up to about 16½ ft. below low water, a mound of large concrete blocks up to low water of equinoctial spring tides, and a solid masonry superstructure well protected at its outer toe by a projection of masonry, and raised several feet above high water, forming a quay sheltered by a promenade wall. The rise of equinoctial spring tides at the mouth of the river Nervion is 14½ ft. In carrying out the work, however, the superstructure built in the summer months was for the most part destroyed by the following winter storms; and, accordingly, the superstructure was eventually constructed on a widened rubble base, so as to be sheltered to some extent by the outlying concrete-block mound already deposited, a system subsequently adopted in rebuilding the damaged portion of the North Pier at Tynemouth under shelter of the ruins of the previous work. The modified superstructure of the Bilbao breakwater was founded on the extended rubble mound at a depth of 16½ ft. below low water, and formed of iron caissons partially filled with concrete and floated out, sunk in position, and filled up with concrete blocks and concrete. It thus consists of a continuous row of concrete blocks, each of them being 42½ ft. in width across the breakwater, 23 ft. in length along the line of the breakwater, 23 ft. high, and weighing 1400 tons. These caisson blocks, raised 6½ ft. above low water, form the base of the superstructure, upon which the upper part was built of concrete blocks on each face with mass concrete filling between them, forming a continuous quay, 24 ft. wide, raised 8 ft. above high tide, and slightly sheltered by a curved parapet block only 3 ft. high. The outer toe of the caisson blocks is protected from being undermined by two tiers of large concrete blocks laid flat on the rubble mound. This superstructure has successfully resisted the attacks of the Atlantic waves rolling into the bay. At this breakwater and at Tynemouth advantage has been taken of the protection unintentionally provided by previous failures, by which the waves are broken before reaching the superstructure and pier respectively; but instead of introducing a wave-breaker of concrete blocks, for a protection to the superstructure, as arranged at Marmagao (fig. 11) and the outer arms at Madras, it would appear preferable to increase the width of the solid superstructure, if necessary, as carried out at Naples (fig. 12), and to dispense with a parapet and keep the superstructure low, as being unsuitable for a quay in exposed situations, according to the plan adopted at Colombo (fig. 9).

3. *Upright-Wall Breakwaters.*—The third type of breakwater consists of a solid structure founded directly on the sea-bottom, in the form of an upright wall, with only a moderate batter on each face. This form of breakwater is strictly limited to sites where the bed of the sea consists of rock, chalk, boulders, or other hard bottom not subject to erosion by scour, and where the depth does not exceed about 40 to 50 ft. If a solid breakwater were erected on a soft yielding bottom, it would be exposed to dislocation from irregular settlement; and such a structure, by obstructing or diverting the existing currents, tends to create a scour along its base; whilst the waves in recoiling from its sea face are very liable to produce erosion of the sea-bottom along its outer toe. Moreover, when the foundations for an upright-wall breakwater have to be levelled by divers, and the blocks laid under water by their help, the extension of such a breakwater into a considerable depth is undesirable on account of the increased pressure imposed upon diving operations.

The Admiralty pier at Dover was begun about the middle of the 19th century, and furnishes an early and notable example of an upright-wall breakwater resting upon a hard chalk bottom; and it was subsequently extended to a depth of about 42 ft. at low tide, in

connexion with the works for forming a closed naval harbour at Dover. This breakwater, the Prince of Wales pier of the commercial harbour, and the eastern breakwater and detached south breakwater for the naval harbour, were all founded on a levelled bottom, carried down to the hard chalk underlying the surface layer, by means of men in diving-bells. The extension of the Admiralty pier and the other breakwaters of Dover harbour consist of bonded courses of concrete blocks, from 26 to 40 tons in weight, as shown in figs. 13 and 14, the outer blocks above low water being formed on their exposed side with a facing of granite rubble. The blocks, composed of six parts of sand and stones to one part of Portland cement, moulded in frames, and left to set thoroughly in the block-yard before being used, are all joggled together, and above low-water level are bedded in cement and the joints filled with cement grout. The blocks were laid by Goliath travelling cranes running on temporary staging supported at intervals of 50½ ft. by clusters of iron piles carried down into the chalk bottom. On each line of staging there were four Goliaths, preceded by a stage-erecting machine. The front Goliath was used for working a grab for excavating the surface layer of chalk, which was finally levelled by divers, the second for carrying the diving-bell, the third for laying the blocks below low water, and the fourth for setting the blocks above low water. This succession of Goliaths enabled more rapid progress to be made than with a single Titan at the end of a breakwater; but it involved a considerable increase in the cost of the plant, owing to the temporary staging required. The foundations were carried down from 4 to 6 ft. into the chalk bottom, the deepest being 53 ft. below low water of spring tides, and the average 47 ft. With a rise of tide at springs of 18½ ft., the average depth is thus approximately 66 ft. at high tide, necessitating a pressure of 29 lb on the square inch, which is the limit at which men can work without inconvenience in the diving-bells. The breakwaters are raised about 11 ft. above high water of springs. The detached southern breakwater

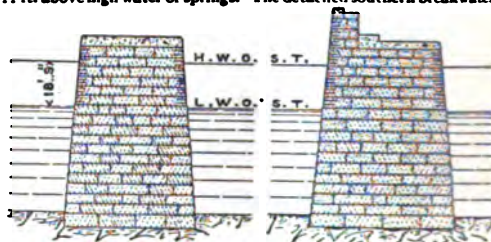

Dover Breakwater.

FIG. 13.
South Breakwater.FIG. 14.
Admiralty Pier Extension.

was finished off at this level; but the extended western breakwater, or Admiralty pier, is provided with a promenade parapet on its exposed side, rising 13 ft. above the quay; and the eastern breakwater also has a parapet on its exposed eastern side, raised, however, only 9 ft. above its quay. The breakwaters are protected from scour along their outer toe by an apron of concrete blocks, extending 25 ft. out from their sea face.

The levelling of the foundations for laying the courses of an upright-wall breakwater is costly and tedious, even in chalk; and the expense and delay are considerably enhanced where the bottom is hard rock. Accordingly, in constructing two breakwaters at the entrance to Aberdeen harbour on a bottom of granite in 1870-1877, concrete bags were laid on the sea-bed; and these bags, by adapting themselves to the rocky irregularities, obviated levelling the bottom. They formed the foundation for the concrete blocks in the south breakwater; and by the deposit of successive layers of 50-ton concrete bags till they rose above low water, they constituted the whole of the submerged portion of the north breakwater. The 50-ton bags were deposited from hopper barges towed out to the site; and the portions of both breakwaters above low water were carried up with mass concrete. Subsequently, the breakwater at Newhaven was constructed on a foundation of chalk, with 100-ton concrete bags up to low water, and mass concrete above. Still later, the two breakwaters sheltering the approach to the river Wear (see HARBOUR) and the Sunderland docks were built with a foundation mound of concrete in bags, 56 to 116 tons in weight, on the uneven sea-bottom, raised slightly above low water of spring tides, on which a solid upright wall was erected, formed of concrete blocks on each side faced with granite, filled in the centre and capped on the top with mass concrete. The most exposed northern Rolker breakwater, raised about 11 ft. above high water of springs where the rise is 14 ft. 5 in., is devoid of a parapet; but a subway formed near the top in each breakwater gives access to the light on the pier-head in stormy weather (fig. 15). These concrete bags are made by lining the hopper of the barge with jute canvas, which receives the concrete and

rown up to form a bag whilst the barge is being towed to the site. The concrete is thus deposited unset, and readily accommodates itself to the irregularities of the bottom or of the mound of bags; and sufficient liquid grout oozes out of the canvas when the bag is compressed, to unite the bags into a solid mass, so that with the breakwater forms a monolith.

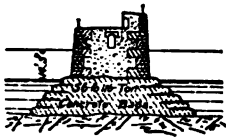

FIG. 15.—Sunderland Southern Breakwater.

This system has been extended to the portion of the superstructure of the eastern, little-exposed breakwater of Bilbao harbour below low water, where the rubble mound is of moderate height; but this application of the system appears less satisfactory, as settlement of the superstructure on the mound would produce cracks in the set concrete in the bags.

Foundation blocks of 2500 to 3000 tons have been deposited for raising the walls on each side of the wide portion of the Zebrugge breakwater (fig. 16) from the sea-bottom to above low water, and also 4400-ton blocks along the narrow outer portion (see HARBOUR), by building iron caissons, open at the top, in the dry bed of the Bruges ship-canal, lining them with concrete, and after the canal was filled with water, floating them out one by one in calm weather, sinking them in position by admitting water, and then filling them with concrete under water from closed skips which open at the bottom directly they begin to be raised. The firm sea-bed is levelled by small rubble for receiving the large blocks, whose outer toe is protected from undermining by a layer of big blocks of stone extending out for a width of 50 ft.; and then the breakwater walls are raised above high water by 55-ton concrete blocks, set in cement at low tide; and the upper portions are completed by concrete-in-mass widening and framing.

Sometimes funds are not available for a large plant; and in such cases small upright-wall breakwaters may be constructed in a moderate depth of water on a hard bottom of rock, chalk or boulders, by erecting timber framing in suitable lengths, lining it inside with jute cloth, and then depositing concrete below low water in closed hopper skips lowered to the bottom before releasing the concrete, which must be effected with great care to avoid allowing the concrete to fall through the water. The portion of the breakwater above low water is then raised

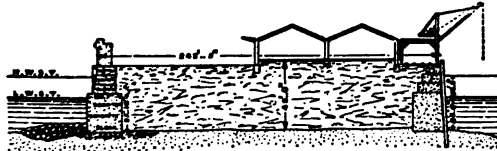

FIG. 16.—Zebrugge Harbour Breakwater with Quay.

by tide-work with mass concrete within frames, in which large blocks of stone may be bedded, provided they do not touch one another and are kept away from the face, which should be formed with concrete containing a larger proportion of cement. As long continuous lengths of concrete crack across under variations in temperature, it is advisable to form fine straight divisions across the upper part of a concrete breakwater in construction, as substitutes for irregular cracks.

Upright-wall breakwaters should not be formed with two narrow walls and intermediate filling, as the safety of such a breakwater depends entirely on the sea-wall being maintained intact. A warning of the danger of this system of construction, combined with a high parapet, was furnished by the south breakwater of Newcastle harbour in Dundrum Bay, Ireland, which was breached by a storm in 1868, and eventually almost wholly destroyed; whilst its ruins for many years filled up the harbour which it had been erected to protect. In designing its reconstruction in 1897, it was found possible to provide a solid upright wall of suitable strength with the materials scattered over the harbour, together with an extension needed for providing proper protection at the entrance. This work was completed in 1906.

Upright-wall breakwaters and superstructures are generally made of the same thickness throughout, irrespective of the differences in depth and exposure which are often met with in different parts of the same breakwater. This may be accounted for by the general custom of regarding the top of an upright wall or superstructure as a quay, which should naturally be given a uniform width; and this view has also led to the very general practice of sheltering the top of these structures with a parapet. Generally the width is proportioned to the most exposed part, so that the only result is

an excess of expenditure in the inner portion to secure uniformity. When, however, as at Madras, the width of the structure is reduced to a minimum, the action of the sea demonstrates that the strength of the structure must be proportioned to the depth and exposure. In small fishery piers, where great economy is essential to obtain the maximum shelter at limited expense, it appears expedient to make the width of the breakwater proportionate to the depth. This was done in Babbacombe Bay; and in reconstructing the southern breakwater at Newcastle, Ireland, advantage was taken of a change in direction of the outer half to introduce an addition to the width, so as to make the strength of the breakwater proportionate to the increase in depth and exposure. In large structures, however, uniformity of design may be desirable for each straight length of breakwater; though where two or more breakwaters or outer arms enclose a harbour, the design should obviously be modified to suit the depth and exposure. At Colombo harbour, the superstructure of the less exposed north-west breakwater has been made slightly narrower than that of the south-west breakwater; and a simple rubble mound shelters the harbour from the moderate north-east monsoon. In special cases, where a breakwater has to serve as a quay, like the Admiralty pier at Dover, a high parapet wall is essential; but in most cases, where a parapet merely enables the breakwater to be more readily accessible in moderate weather, it would be advisable to keep it very low, or to dispense with it altogether, as at the southern Dover breakwater, the northern breakwater at Sunderland, and the Colombo western breakwaters. This course is particularly expedient in very exposed sites, as a high parapet intensifies the shock of the waves against a breakwater and their erosive recoil. Moreover, when a light has to be attended to at the end of a breakwater, sheltered access can be provided by a subway, as at Sunderland.

Structures in the sea almost always require works of maintenance; and when a severe storm has caused any injury, it is most important to carry out the repairs at the earliest available moment, as the waves rapidly enlarge any holes that they may have formed in weak places. (L. F. V.-H.)

BRÉAL, MICHEL JULES ALFRED (1832—), French philologist, was born on the 26th of March 1832, at Landau in Rhenish Bavaria, of French parents. After studying at Weissenburg, Metz and Paris, he entered the Ecole Normale in 1852. In 1857 he went to Berlin, where he studied Sanskrit under Bopp and Weber. On his return to France he obtained an appointment in the department of oriental MSS. at the Bibliothèque Impériale. In 1864 he became professor of comparative grammar at the Collège de France, in 1875 member of the Académie des Inscriptions et Belles-lettres, in 1879 *inspecteur-général* of public instruction for higher schools until the abolition of the office in 1888. In 1890 he was made commander of the Legion of Honour. Among his works, which deal mainly with mythological and philological subjects, may be mentioned: *L'Etude des origines de la religion Zoroastrienne* (1862), for which a prize was awarded him by the Académie des Inscriptions; *Hercule et Cacus* (1863), in which he disputes the principles of the symbolic school in the interpretation of myths; *Le Mythe d'Œdipe* (1864); *Les Tables Eugubines* (1875); *Mélanges de mythologie et de linguistique* (2nd. ed., 1882); *Leçons de mois* (1882, 1886), *Dictionnaire étymologique latin* (1885) and *Grammaire latine* (1890). His *Essai de Sémantique* (1897), on the signification of words, has been translated into English by Mrs H. Cust with preface by J. P. Postgate. His translation of Bopp's *Comparative Grammar* (1866–1874), with introductions, is highly valued. He has also written pamphlets on education in France, the teaching of ancient languages, and the reform of French orthography. In 1906 he published *Pour mieux connaître Homère*.

BREAM (*Abramis*), a fish of the Cyprinid family, characterized by a deep, strongly compressed body, with short dorsal and long anal fins, the latter with more than sixteen branched rays, and the small inferior mouth. There are two species in the British Isles, the common bream, *A. brama*, reaching a length of 2 ft. and a weight of 12 lb, and the white bream or bream flat, *A. bicca*, a smaller and, in most places, rarer species. Both occur in slow-running rivers, canals, ponds and reservoirs. Bream are usually despised for the table in England, but fish from large lakes, if well prepared, are by no means deserving of ostracism. In the days of medieval abbeys, when the provident Cistercian monks attached great importance to pond culture, they gave the first place to the tench and bream, the carp still being unknown in the greater part of Europe. At the present day, the poorer Jews in large English cities make a great consumption

of bream and other Cyprinids, most of them being imported alive from Holland and sold in the Jewish fish markets. In America the name bream is commonly given to the golden shiner minnow (*Abramis chrysoleucus*), to the pumpkin-seed sunfish (*Eupomotis gibbosus*), and to some kinds of porgy (*Sparidae*).

BREAST (a word common to Teutonic languages, cf. the Ger. *Brust*, possibly connected with an O. Sax. *brustian*, to bud), the term properly confined to the external projecting parts of the thorax in females, which contain the mammary glands (for anatomy, and diseases, see MAMMARY GLAND); more generally it is used of the external part of the thorax in animals, including man, lying between the neck and the abdomen.

BREAUTÉ, FALKES DE (d. 1226), one of the foreign mercenaries of King John of England, from whom he received in marriage the heiress of the earldom of Devon. On the outbreak of the Barons' War (1215) the king gave him the sheriffdoms of six midland shires and the custody of many castles. He fulfilled his military duties with as much skill as cruelty. The royalists owed to his daring the decisive victory of Lincoln (1217). But after the death of William Marshal, earl of Pembroke, Falkes joined the feudal opposition in conspiring against Hubert de Burgh. Deprived in 1223 of most of his honours, he was drawn into a rebellion by the imprudence of his brother, who captured a royal justice and threw him into prison (1224). Falkes was allowed to go into exile after his submission, and endeavoured to obtain a pardon through the mediation of Pope Honorius III. But this was refused, and Falkes died at St Cyriac in 1226.

See Shirley, *Royal Letters*, vol. i.; the *Poet and Close Rolls*; Pauli, *Geschichte von England*, vol. i. pp. 540-545. (H. W. C. D.)

BRECCIA, in petrology, the name given to rocks consisting of angular fragments embedded in a matrix. They may be composed of volcanic rocks, limestones, siliceous cherts, sandstones, in fact of any kind of material, and the matrix, which usually corresponds to some extent to the fragments it encloses, may be siliceous, calcareous, argillaceous, &c. The distinctive character of the group is the sharp-edged and unworn shapes of the fragments; in conglomerates the pebbles are rounded and water-worn, having been transported by waves and currents from some distance. There are many ways in which breccias may originate. Some are formed by ordinary processes of atmospheric erosion; frost, rain and gravity break up exposed surfaces of rock and detach pieces of all sizes; in this way scree are formed at the bases of cliffs, and barren mountain-tops are covered with broken débris. If such accumulations gather and are changed into hard rock by pressure and other indurating agencies they make typical breccias. Conglomerates often pass into rocks of this type, the difference being merely that the fragments are of purely local origin, and are unworn because they have not been transported. In caves breccias of limestone are produced by the collapse of part of the roof, covering the floor with broken masses. Coral reefs often contain extensive areas of limestone breccia, formed of detached pieces of rock which have been dislodged from the surface and have been carried down the steep external slopes of the reef. Volcanic breccias are very common near active or extinct craters, as sudden outbursts of steam bear fragments from the older rocks and scatter them over the ground.

Another group of breccias is due to crushing; these are produced in fissures, faults and veins, below the surface, and may be described as "crush-breccias" and "friction-breccias." Very important and well-known examples of this class occur as veinstones, which may be metalliferous or not. A fissure is formed, probably by slight crustal movements, and is subsequently filled with material deposited from solution (quartz, calcite, barytes, &c.). Very often displacement of the walls again takes place, and the infilling or "veinstone" is torn apart and brecciated. It may then be cemented together by a further introduction of mineral matter, which may be the same as that first deposited or quite different. In important veins this process is often repeated several times; detached pieces of the country rock are mingled with the shattered veinstone, and generally

experience alteration by the percolating mineral solutions. Other crush-breccias occurring on a much larger scale are due to the folding of strata which have unequal plasticities. If, for example, shales and sandstones are bent into a series of arches, the sandstones being harder and more resistant will tend to crack, while the shales, which are soft and flow under great pressures, are injected into the crevices and separate the broken pieces from one another. Continued movement will give the brecciated fragments of sandstone a rounded form by rubbing them against one another, and, in this way, a crush-conglomerate is produced. Great masses of limestone in the Alps, Scottish Highlands, and all regions of intense folding are thus converted into breccias. Cherts frequently also show this structure; igneous rocks less commonly do so; but it is perhaps most common where there have been thin bedded alternations of rocks of different character, such as limestone and dolerite, limestone and quartzite, shale or phyllite and sandstone. Fault-breccias closely resemble vein-breccias, except that usually their fragments consist principally of the rocks which adjoin the fault and not of mineral deposits introduced in solution; but many veins occupy faults, and hence no hard and fast line can be drawn between these types of breccia.

A third group of breccias is due to movement in a partly consolidated igneous rock, and may be called "fluxion-breccias." Lava streams, especially when they consist of rhyolite, dacite and some kinds of andesite, may rapidly solidify, and then become exceedingly brittle. If any part of the mass is still liquid, it may break up the solid crust by pressure from within and the angular fragments are enveloped by the fluid lava. When the whole comes to rest and cools, it forms a typical "volcanic-fluxion-breccia." The same phenomena are sometimes exemplified in intrusive sills and dykes. The fissures which are occupied by igneous dikes may be the seat of repeated injections following one another at longer or shorter intervals; and the latter may shatter the earlier dike rocks, catching up the fragments. Among the older formations, especially when decomposition has gone on extensively, these fluxion and injection-breccias are often very hard to distinguish from the commoner volcanic-breccias and ash-beds, which have been produced by weathering, or by the explosive power of superheated steam. (J. S. F.)

BRECHIN, a royal, municipal and police burgh of Forfarshire, Scotland. Pop. (1901) 8941. It lies on the left bank of the South Esk, 7½ m. west of Montrose, and has a station on the loop line of the Caledonian railway from Forfar to Bridge of Dun. Brechin is a prosperous town, of great antiquity, having been the site of a Culdee abbey. The Danes are said to have burned the town in 1012. David I. erected it into a bishopric in 1150, and it is still a see of the Episcopal Church of Scotland. In 1543 the earl of Huntly crushed the insurrection led by the earl of Crawford at the battle of Brechin Muir, and in 1645 the town and castle were harried by the marquis of Montrose. James VI. gave a grant for founding a hospital in the burgh, which yet supplies the council with funds for charity. No trace remains of the old walls and gates of the town, but the river is crossed by a two-arched stone bridge of very early date. The cathedral church of the Holy Trinity belongs to the 13th century. It is in the Pointed style, but suffered maltreatment in 1806 at the hands of restorers, whose work, however, disappeared during the restoration completed in 1902. The western gable with its flamboyant window and Gothic door and the massive square tower are all that is left of the original edifice. The modern stained glass in the chancel is reckoned amongst the finest in Scotland. Immediately adjoining the cathedral to the south-west stands the Round Tower, built about 1000. It is 86½ ft. high, has at the base a circumference of 50 ft. and a diameter of 16 ft., and is capped with a hexagonal spire of 18 ft., which was added in the 15th century. This type of structure is somewhat common in Ireland, but the only Scottish examples are those at Brechin, Abernethy in Perthshire, and Eglishay in the Orkneys. Brechin Castle played a prominent part in the Scottish War of Independence. In 1303 it withstood for twenty days a siege in

force by the English under Edward I., surrendering only when its governor, Sir Thomas Maule, had been slain. From the Maule family it descended to the Dalhousies. Its library contains many important MSS., among them Burns's correspondence with George Thomson, and several cartularies including those of St Andrews and Brechin. In the Vennel (alley or small street) some ruins remain of the *maison dieu*, or *hospitium*, founded in 1256 by William of Brechin. Besides these historical buildings the principal public structures include Smith's school, the municipal buildings, the free library, the episcopal library (founded by Bishop Forbes, who, as well as Bishop Abernethy-Drummond, presented a large number of volumes). The principal industries include manufactures of linen and sailcloth, bleaching, rope-making, brewing, distilling, paper-making, in addition to nurseries and freestone quarries. Brechin—which is controlled by a provost, bailies and council—unites with Arbroath, Forfar, Inverberrie and Montrose to return one member to parliament.

Edzell (pronounced Edyell, and, locally, Aigle) lies about 6 m. north of Brechin, with which it is connected by rail. It is situated on the North Esk and near the West Water, which falls into the Esk 2 m. south-west. Edzell is on the threshold of romantic Highland scenery. The picturesque ruins of Edzell Castle lie a mile to the west of the town. Once the seat of the Lindsays the estate now belongs to the earl of Dalhousie. The church of the parish of Farnell, 3½ m. south-east of Brechin, was erected in 1806 after the model, so it is stated, of the famous Holy House (Casa Santa) of Loreto in Italy. It was here that the old sculptured stone giving a version of the Fall was found. Between Farnell and Brechin lies Kinnaird Castle, the seat of the earl of Southesk.

BRECKINRIDGE, JOHN CABELL (1821-1875), American soldier and political leader, was born near Lexington, Kentucky, on the 21st of January 1821. He was a member of a family prominent in the public life of Kentucky and the nation. His grandfather, John Breckinridge (1760-1806), who revised Jefferson's draft of the "Kentucky Resolutions" of 1798, was a United States senator from Kentucky in 1801-1805 and attorney-general in President Jefferson's cabinet in 1805-1806. His uncles, John Breckinridge (1797-1841), professor of pastoral theology in the Princeton Theological Seminary in 1836-1838 and for many years after secretary of the Presbyterian Board of Foreign Missions, and Robert Jefferson Breckinridge (1800-1871), for several years superintendent of public instruction in Kentucky, an important factor in the organization of the public school system of the state, a professor from 1853 to 1871 in the Danville Presbyterian Theological Seminary at Danville, Kentucky, and the temporary chairman of the national Republican convention of 1864, were both prominent clergymen of the Presbyterian Church. His cousin, William Campbell Preston Breckinridge (1837-1904), was a Democratic representative in Congress from 1885 to 1893. Another cousin, Joseph Cabell Breckinridge (1842-), served on the Union side in the Civil War, was a major-general of volunteers during the Spanish-American War (1898), became a major-general in the regular United States army in 1903, and was inspector-general of the United States army from 1899 until his retirement from active service in 1904.

John Cabell Breckinridge graduated in 1838 at Centre College, Danville, Kentucky, continued his studies at Princeton, and then studied law at Transylvania University, Lexington, Kentucky. He practised law in Frankfort, Kentucky, in 1840-1841 and in Burlington, Iowa, from 1841 to 1843, and then returned to Kentucky and followed his profession at Lexington. In 1847 he went to Mexico as major in a volunteer regiment, but arrived too late for service in the field. In 1849 he was elected a Democratic member of the Kentucky legislature, and in 1851-1855 he served in the national House of Representatives. President Pierce offered him the position of minister to Spain, but he declined it. In 1856 he was chosen vice-president of the United States on the Buchanan ticket, and although a strong pro-slavery and states rights man, he presided over the Senate with conspicuous fairness and impartiality during the trying years before

the Civil War. In 1860 he was nominated for the presidency by the pro-slavery seceders from the Democratic national convention, and received a total of 72 electoral votes, including those of every Southern state except Virginia, Kentucky, Tennessee and Missouri. As vice-president and presiding officer of the Senate, it was his duty to make the official announcement of the election of his opponent, Lincoln. He succeeded John J. Crittenden as United States senator from Kentucky in March 1861, but having subsequently entered the Confederate service he was expelled from the Senate in December 1861. As brigadier-general he commanded the Confederate reserve at Shiloh, and in August 1862 he became major-general. On the 5th of this month he was repulsed in his attack on Baton Rouge, but he won distinction at Stone River (December 31, 1862-January 2, 1863), where his division lost nearly a third of its number. He took part in the battle of Chickamauga, defeated General Franz Sigel at Newmarket, Virginia, on the 15th of May 1864, and then joined Lee and took part in the battles of Cold Harbor on the 1st and on the 3rd of June. In the autumn he operated in the Shenandoah Valley, and with Early was defeated by Sheridan at Winchester on the 19th of September. Being transferred to the department of South-west Virginia, he fought a number of minor engagements in eastern Tennessee, and in January 1865 became secretary of war for the Confederate States. At the close of the war he escaped to Cuba, and from there went to Europe. In 1868 he returned to the United States and resumed the practice of law at Lexington, Kentucky, where he died on the 17th of May 1875.

BRECON, or **BRECKNOCK**, a market town and municipal borough, the capital of Breconshire, Wales, 183 m. from London by rail, picturesquely situated nearly in the centre of the county, at the confluence of the Honddu with the Usk. Half a mile higher up the Tarell also falls into the Usk from the south. The ecclesiastical parish of Brecon consists of the two civil parishes of St. John the Evangelist and St. Mary, both on the left bank of the Usk, while St David's in Llanfaes is on the other side of the river, and was wholly outside the town walls. Pop. (1901) 5875. There is only one line of railway, over which several companies, however, have running powers, so that the town may be reached by the Brecon & Merthyr railway from Merthyr, Cardiff and Newport, by the Cambrian from Builth Wells, or by the Midland from Hereford and Swansea respectively. The Great Western railway has also a service of road motors between Abergavenny and Brecon. A canal running past Abergavenny connects Brecon with Merthyr.

The Priory church of St John, a massive cruciform building, originally Norman with Early English and Decorated additions, is the finest parish church in Wales, and even taking into account the cathedrals it is according to E. A. Freeman "indisputably the third church not in a state of ruin in the principality," its choir furnishing "one of the choicest examples of the Early English style." Previous to the dissolution, a rood-screen bearing a gigantic rood, the object of many pilgrimages, stood to the west of the tower. The church was restored under Sir Gilbert Scott between 1861 and 1875. St Mary's, in the centre of the town, and St David's, beyond the Usk, are now mainly modern, though the former has some of the Norman arches of the original church. There is also a Roman Catholic church (St Michael's) opened in 1851, and chapels belonging to the Baptists, Calvinistic and Wesleyan Methodists, and to the Congregationalists. In Llanfaes there was formerly a Dominican priory, but in 1542 Henry VIII. granted it with all its possessions to a collegiate church, which was transferred thither from Abergwili, and was given the name of Christ College. Many of the bishops of St David's during the 17th century occasionally resided here, and several are also buried here. A small part of the revenues went to the maintenance of a grammar-school, but in 1841 the collegiate body was dissolved, and its revenues, then amounting to about £8000 a year, were transferred to the ecclesiastical commissioners. In 1853 Henry VIII.'s charter was repealed, and under a chancery scheme adopted two years later, £12000 a year was appropriated for the school. New school

buildings were erected at a cost of about £10,000 in 1862, and these were enlarged at a cost of about £5000 in 1880. The chancel of the old Dominican chapel, dating from the 13th century, was restored in 1864, and is now the school chapel. There is also a Congregationalist theological college, built in 1869 at a cost of £12,000, and now affiliated with the university of Wales. The other chief buildings of the town are the shire hall built in 1842 in the Doric style from designs by T. H. Wyatt; the Guildhall; the barracks, which are the headquarters of two battalions of the South Wales Borderers; the county infirmary founded in 1832; and the prison (in Llanfaes) for the counties of Brecon and Radnor. There is a bronze statue of the duke of Wellington (erected in 1854) by John Evan Thomas, a native of the town. The town commands a magnificent view of the Brecknock Beacons, and is noted for its promenades on the banks of the Usk, and in the priory groves. Brecon is favourably known as a fishing centre, and there is also boating on the Usk and the canal. There are several houses of interest, notably the Priory and Dr Awbrey's residence (now called Buckingham House), both built about the middle of the 16th century, but the finest specimen is Newton (about a mile out, near Llanfaes) built in 1582 by Sir John Games (a descendant of Sir David Gam), but now a farmhouse. The "Shoulder of Mutton" Inn, now known as the "Siddons Wine Vaults," was the birthplace in 1755 of Mrs Siddons.

The name Brecknock is an anglicized form of Brycheiniog, the Welsh name of the territory of Brychan (whence the alternative form of Brecon), a Goidelic chieftain, who gained possession of the Usk valley in the 5th century. The Welsh name of the town, on the other hand, has always been Aber-Honddu (the estuary of the Honddu). There is no evidence of any settlement on the site of the present town prior to about 1092, when Bernard Newmarch, after defeating Bleddin ab Maenarch, built here a castle which he made his residence and the chief stronghold of his new lordship. For this purpose he utilized what remained of the materials of the Roman fort, 3 m. to the west, at Y Gaer, which some identify as Bannium. He subsequently founded, near the castle, the Benedictine priory of St John, which he endowed and constituted a cell of Battle Abbey. In time a town grew up outside the castle, and its inhabitants received a series of charters from the de Bohuns, into which family the castle and lordship passed, the earliest recorded charter being granted by Humphrey, 3rd earl of Hereford. Under the patronage of his great-grandson, the last earl of Hereford (who lived in great splendour at the castle), the town became one of the chief centres of trade in South Wales, and a sixteen days' fair, which he granted, still survives as a hiring fair held in November. Further charters were granted by Henry IV. (who married Hereford's co-heiress), by Henry V., who gave the town two more fairs, and by the Stafford family, to which the castle and lordship were allotted on the partition of the Bohun estates in 1421. Henry Stafford, 2nd duke of Buckingham, resided a good deal at the castle, and Morton, bishop of Ely, whose custody as a prisoner was entrusted to him, plotted with him there for the dethronement of Richard III., for which Stafford was executed in 1483. His son, Edward, the 3rd duke, who was born in the castle in 1478, had the estates restored to him, but, in 1521, suffered a like fate with his father, and the lordship and castle then vested in the crown. Both were acquired in the next century by the ancestors of Viscount Tredegar, to whom they now belong. By a statute of 1535 Brecon was made the county town of the new shire of Brecknock, and was granted the right of electing one burges to represent it in parliament, a right which it retained till it was merged in the county representation in 1885. A chancery and exchequer for the counties of Brecknock and Radnor were also established at Brecon Castle, and from 1542 till 1830 the great sessions, and since then the assizes, and at all times the quarter sessions for the county, have been held at Brecon. The borough had also a separate court of quarter sessions till 1835. The town was incorporated by a charter granted by Philip and Mary in 1556 and confirmed by Elizabeth in the nineteenth year of her reign. A charter granted by James II. was never acted upon.

The borough was placed under the Municipal Corporations Act 1835, and until then the town of Llywel, which is 10 m. off, formed a ward of the borough. There were formerly five trade guilds in the town, the chief industries being cloth and leather manufactures. There are five ancient fairs for stock, and formerly each of them was preceded by a leather fair. The fairs held in May and November were also for hiring, much of the hiring being now done at the Guildhall, and not in the streets as used to be the case.

During the Civil War the greater part of the castle and of the town walls (which with their four gates were until then well preserved) were demolished by the inhabitants in order to prevent the town being either garrisoned or besieged. Charles I., however, stayed a night at the priory house shortly after the battle of Naseby. The chief ruins of the castle are now enclosed in the grounds of the Castle Hotel, the principal object being Ely tower, where Bishop Morton was imprisoned.

Besides those already mentioned the persons of note born in the town include Henry Stafford, duke of Buckingham; Dr Hugh Price, founder of Jesus College, Oxford; Dr Thomas Coke, the first Wesleyan missionary bishop in America; and Theophilus Jones, the historian of the county. Henry Vaughan, the Sicutist, at one time practised here as a doctor of medicine. (D. L. T.)

BRECONSHIRE, or BRECKNOCKSHIRE, an inland county in South Wales, and the fourth largest in all Wales, bounded N.W. by Cardigan, N. and N.E. by Radnor, E. and S.E. by Monmouth, S. by Glamorgan and W. by Carmarthen. The general aspect of the county is mountainous, and the scenery is marked by beauty and grandeur. The climate is moist but temperate and healthy, and the soil of the valleys, often consisting of rich alluvial deposits, is very fertile. The loftiest mountains in South Wales, extending from Herefordshire and Monmouthshire (where their eastern spurs form the Hatterall Hills) in a south-easterly direction into Carmarthenshire, completely encircle the county on the east and south except for the break formed by the Vale of Usk at Crickhowell. Their highest summit north of the Usk, on the eastern side, where they are known as the Black Mountains, or sometimes the Black Forest Mountains, is Pen y Gader (2624 ft.) between Talgarth and Llanthony, and on the south-west the twin peaks of the Mynydd Du ("Black Mountain") or the so-called Carmarthenshire Vans or Beacons, only the higher of which, Fan Brycheiniog (2632 ft.), is, however, in Breconshire; while the centre of the crescent is occupied by the masses of the Brecknockshire Beacons or Vans (often called the Beacons simply), the highest point of which, Pen y Fan, formerly also known as Cadair Arthur, or Arthur's Chair, attains an altitude of 2910 ft. In the north, a range of barren hills, which goes by the general designation of Mynydd Eppynt (a name more properly limited to its central portion), stretches right across the county in a north-easterly direction, beginning with Mynydd Bwlch-y-Groes on the boundary to the east of Llandovery, and terminating near Builth. In the dreary country still farther north there is a series of rounded hills covered with peat and mosses, the chief feature being Drygarn Fawr (2115 ft.) on the confines of Cardiganshire.

Of the valleys, the most distinguished for beauty is that of the Usk, stretching from east to west and dividing the county into two nearly equal portions. The Wye is the chief river, and forms the boundary between the county and Radnorshire on the north and north-east, from Rhayader to Hay, a distance of upwards of 20 m.; its tributary, the Elan, till it receives the Claerwen, and then the latter river, continue the boundary between the two counties on the north, while the Towy separates the county from Cardigan on the north-west. The hilly country to the north of the Eppynt is mainly drained by the Irfon, which falls into the Wye near Builth. The Usk rises in the Carmarthenshire Van on the west, and flowing in a direction nearly due east through the centre of the county, collects the water from the range of the Beacons in the south, and from the Eppynt range in the north by means of numerous smaller streams, of which the Tarell and the Honddu (which join it at Brecon) are the most important, and it enters Monmouthshire near Abergavenny.

The Taff, the Nédd (with its tributaries the Hapest and the Melte) and the Tawe, all rise on the south of the Beacon range, and passing through Glamorganshire, flow into the Bristol Channel, the upper reaches of the Nédd and its tributaries in the Vale of Neath being deservedly famous for its scenery. The mountains of the county constitute one of the best water-producing areas in Wales. Recognizing this, the corporation of Birmingham, under an act of 1892, acquired the watershed of the Elan and Claerwen, and constructed on the Elan three impounding reservoirs whence the water is conducted through an aqueduct to Birmingham (*q.v.*). Swansea obtains its chief supply from a reservoir of one thousand million gallons constructed in 1898-1906 on the Cray, a tributary of the Usk. A large industrial area around Neath is supplied from Ystradfellte. Merthyr Tydfil draws its supply from the lesser Taff, while Cardiff's main supply comes from the Great Taff valley, where, under acts of 1884 and 1894, two reservoirs with a capacity of 668 million gallons have been constructed and a third authorized.

In the east of the county, at the foot of the Black Forest Mountains, is Llyn Safaddan, or Brecknock Mere, now more generally known as Llangorse Lake (from being partly situated in the parish of that name). It is about 3 m. long by 1 m. broad, being the largest lake in South Wales. Upon an artificial island in the lake traces of lake-dwellings were discovered in 1869, together with the bones of red deer, wild boar and *Bos longifrons*.

Geology.—The oldest rocks in Brecknockshire are the Llandello shales and intrusive diabases of pre-Llandovery age which near Builth extend across the Wye from Radnorshire; another patch with volcanic outflows comes up at Llanwrtyd, and at both places they give rise to mineral springs. Next follow the Bala Beds, which, with the succeeding Lower and Upper Llandovery shales, sandstones and conglomerates, form the sparsely populated sheepwalks and valleys which occupy most of the north-western part of the county. These rocks are much folded and the shales are locally cleaved into slates, while the sandstones and conglomerates form scarps and ridges. To the south-east of this region a narrow outcrop of Upper Llandovery, Wenlock and Ludlow sandstones and mudstones follows, unconformably overlying the Llandello and Bala rocks, and dipping conformably under the Old Red Sandstone; they extend from Newbridge-on-Wye and Builth through Llangammarch (where there are mineral springs) towards Llandovery, while a tongue of Ludlow rocks brought up by faulting extends from Erwood on the Wye for 8 m. south-westwards into the Old Red Sandstone. The remainder and greater part of the county is occupied chiefly by the gently inclined Old Red Sandstone; in the dissected plateau of the Black Mountains north of Crickhowell the lower marls and cornstones are laid open, while south of Brecon the conglomeratic upper beds form the escarpment and plateaus of the Beacons. The southern edge of the county is formed by the scarps and moorlands of the Carboniferous Limestone and Millstone Grit (both of which form also the outlier of Pen-ceryg-calch north of Crickhowell), while the lowest beds of the Coal Measures of the South Wales coalfield are reached in the Tawe and Neath valleys (where the beds are much folded) and near Tredegar and Brynmawr. Glacial deposits spread over the lower grounds and striae occur at great heights on the Black Mountains.

Industries.—Agriculture is the chief industry, and the Agricultural Society of the county, dating from 1755, is the oldest in Wales. About one-fourth only of the area of the county is under cultivation, and the chief crops grown are wheat and barley, but above all, turnips and oats. The acreage devoted to any other crop is practically infinitesimal, though in the eastern part more attention is paid to fruit-growing than perhaps in any other part of South Wales. The farming is, however, chiefly pastoral, nearly one-third of the county is common or waste land, and its number of sheep (mainly of the Radnor Forest breed) far exceeds that of any other county in Wales. The breeding of cobs and ponies comes next in importance, and thirdly that of cattle, now mostly Herefords, though Speed mentions a native breed, long since extinct, all white with red ears. These, together with pigs, wool, butter, and (in small quantities) cheese, form the staple of a considerable trade with the Midlands and the industrial districts to the south and south-west. The farms are of comparatively small size, the average cultivated area of the holdings in 1894 being 63 acres, and the hired labour averages about two men for each farm. A large share of the work, especially on the highland farms, is done by the occupiers and members of their own families, with the aid,

where required, of an indoor servant or two. Few hands are employed in manufactures, but the mining industry is more important, coal being extensively worked—chiefly anthracite in the upper reaches of the Swansea and Neath valleys, and bituminous in the south-eastern corner of the county. There are also limestone and fireclay, firebrick and cement works, chiefly on the northern outcrop of the carboniferous limestone, as at Abernant in the Vale of Neath and at Penwyllt.

The Central Wales section of the London & North-Western railway from Craven Arms to Swansea crosses the north-west corner of the county, and is intersected at Builth Road by a branch of the Cambrian, which, running for the most part on the Radnorshire side of the Wye, follows that river from Rhayader to Three Cocks; the Midland railway from Hereford to Swansea runs through the centre of the county, effecting junctions at Three Cocks with the Cambrian, at Talylyn with the Brecon & Merthyr railway (which connects the county with the industrial areas of East Glamorgan and West Monmouthshire), and at Capel Colbren with the Neath and Brecon line. The North-Western and Rhymney joint line skirts the south-eastern boundary of the county. Brecon is also connected with Newport by means of the Brecknock and Abergavenny Canal, which was completed in 1801 and is 35 m. in length. The Swansea Canal and that of the Vale of Neath have also their northern terminal within the county, at Ystradgynlais and Abernant respectively. The main roads of the county are probably the best in South Wales.

Population and Administration.—The area of the ancient county is 475,224 acres, with a population in 1891 of 57,031 and in 1901 of 59,907. The area of the administrative county is 469,301 acres. The only municipal borough is Brecon, which is the county town, and had in 1901 a population of 5741. The other urban districts are Brynmawr, Builth Wells and Hay, with populations of 6833, of 1805 and of 1680 respectively in 1901. Crickhowell and Talgarth are market towns, while Llanwrtyd Wells is a rapidly developing health resort. The county forms part of the South Wales circuit, and the assizes are held at Brecon. It had one court of quarter sessions, and is divided into ten petty sessional divisions. The borough of Brecon has a separate commission of the peace, but no separate court of quarter sessions. There are 94 civil parishes, while the ecclesiastical parishes or districts wholly or in part within the county number 70, of which 67 are in the diocese of St David's and the archdeaconry of Brecon, the remaining 3 being in the diocese of Llandaff. The county is not divided for parliamentary purposes, and returns one member to parliament. It contains a small part of the parliamentary borough of Merthyr Tydfil.

In the eastern parts and along the Wye valley, English has become the predominant language, but in the rest of the county, especially north of the Epynt range, Welsh occupies that position. In 1901 about 51% of the population above three years could speak both English and Welsh, 38% could speak English only and 11% Welsh only. The majority of the population is Nonconformist in religion, the chief denominations being the Baptists, Calvinistic Methodists and Congregationalists. Besides an endowed grammar-school (Christ College) at Brecon, there are in the county four secondary schools, established under the Welsh Intermediate Education Act 1899, viz. separate schools for boys and girls at Brecon, and dual schools at Builth and Brynmawr. Most of the county institutions are in the town of Brecon, but the joint asylum for the counties of Brecon and Radnor is at Talgarth. It was opened in February 1903. At Trevecca, near the same town, was a theological college for ministerial students attached to the Calvinistic Methodist body, but in October 1906 the institution was removed to Aberystwyth, and the buildings have since been utilized for a preparatory school belonging to the same body.

History.—There are no traces or record of Breconshire being inhabited before the Neolithic period, but to that period may be ascribed a number of cairns, menhirs and one cromlech (near Glanusk). In Roman times the eastern half of the county formed part of the territory of the Silures, a pre-Celtic race, whose governing class at that time probably consisted of Brythonic

Celts. But an earlier wave of Celtic invasion represented by the Goidels had passed westwards along the valleys of the Usk and Wye, leaving traces in place-names (e.g. *Uwch*, lake), and in the Ogham inscribed stones found at Gianusk, Trallwng and Tre-castle, and probably surviving into historic times around the Beacon range and farther south even to Gower and Kidwelly. The conquest of the district by the Romans was effected between about A.D. 75 and 80, and they established a frontier fort (which some have called *Caer Bannau*, identifying it as *Bannium*) some 3 m. out of the present town of Brecon, with smaller stations on roads leading thereto at Y Gaer near Crickhowell, and at Capel Colbren in the direction of Neath. On the departure of the Romans, the Goidelic hill-tribes, probably with help from Gower and Ireland, seem to have regained possession of the Usk valley under the leadership of a chieftain of their own race, Brychan, who became the ancestor of one of the three chief tribes of hereditary Welsh saints. His territory (named after him *Brycheiniog*, whence *Brecknock*) lay wholly east of the Epynt range, for the lordship of Buallt, corresponding to the modern hundred of Builth, to the west, remained independent, probably till the Norman invasion. Most of the older churches of central Brecknockshire and east Carmarthenshire were founded by or dedicated to members of Brychan's family.

From the middle of the 8th century to the 10th, *Brycheiniog* proper often bore the brunt of Mercian attacks, and many of the castles on its eastern border had their origin in that period. Subsequently, when Bernard de Newmarch and his Norman followers obtained possession of the country in the last quarter of the 11th century, these were converted into regular fortresses. Bernard himself initiated this policy by building a castle at Talgarth on the Upper Wye, but in 1091 he moved southwards, defeated the regulus of *Brycheiniog*, Bleddyn ab Maenarch, and his brother-in-law Rhys ap Tewdwr, the prince of south-west Wales, and with materials obtained from the Roman fort of *Caer Bannau*, built a castle at Brecon, which he made his *caput baroniae*. *Brycheiniog* was then converted into a lordship marcher and passed to the Fitzwalter, de Breos, the Bohun and the Stafford families in succession, remaining unaffected by the Statute of Rhuddlan (1282), as it formed part of the marches, and not of the principality of Wales.

The Irfon valley, near Builth, was, however, the scene of the last struggle between the English and Llewelyn, who in 1282 fell in a petty skirmish in that district. The old spirit of independence flickered once again when Owen Glendower marched to Brecon in 1403. Upon the attainder of Edward, duke of Buckingham, in 1521, the lordship of Brecon with its dependencies became vested in the crown. In 1536 it was grouped with a whole series of petty lordships marcher and the lordship of Builth to form the county of Brecknock with Brecon as the county town, and the place for holding the county court. The county returns one member to parliament, and has done so since 1536; the borough of Brecon, with the town of Llywel, had also a separate representative from the same date till 1885, when it became merged in the county.

BREDA, a fortified town in the province of North Brabant, Holland, at the confluence of the canalized rivers Merk and Aa, 15 m. by rail E.N.E. of Roosendaal. Pop. (1900) 26,296. It is connected by steam tramway with Antwerp (30 m. S.S.W.), and with Geertruidenberg in the north, and the island of Duiveland on the west. The fortress of Breda, which was once considered impregnable, has been dismantled, but the town is still protected by extensive lines of fortification and lies in the midst of a district which can be readily laid under water. It has a fine quay, town-hall and park. There are several Roman Catholic and Protestant churches. The principal Protestant church is a Gothic building dating from the end of the 13th century, with a fine tower, and a choir of later date (1410). Among the many interesting monuments is the imposing tomb of the stadtholder Count Engelbert II. of Nassau and his wife. This is the work of Tommaso Vincenz of Bologna, who, though a pupil of Raphael in painting, in sculpture followed Michelangelo, to whom the work is sometimes ascribed. Since 1828 Breda has been the seat of a royal

military academy for all arms of the service. It also possesses a Latin school, an arsenal, and a modern prison built on the isolated-cell principle. The prison is in the form of a rotunda, 58 yds. in diameter, and covered by a high dome. In the middle is the office of the administration, and on the top of this a small watch-tower. Round the walls of the rotunda are the cells, 208 in number, and arranged in four tiers with balconies reached by iron staircases. Each cell measures 35 cub. yds., is provided with an electric bell communicating with the warden in the tower, heated by hot-air pipes, and lighted by day through a window on the outer wall of the rotunda, and from sunset till ten o'clock by electric light. The industries of Breda comprise the manufacture of linen and woollen goods, carpets, hats, beer and musical instruments. In the neighbourhood of the town are the villages of Ginneken and Prinsenhage, situated in the midst of pretty pine woods. They form favourite places of excursion, and in the woods at Ginneken is a Knippis sanatorium.

History.—Breda was in the 11th century a direct fief of the Holy Roman Empire, its earliest known lord being Henry I. (1065-1125), in whose family it continued, though, from the latter part of the 13th century, in the female line, until Alix, heiress of Philip (d. 1323), sold it to Brabant. In 1350 the fief was resold to John (Jan) of Polanen (d. 1377), the heiress of whose line, Joanna (d. 1445), married Engelbert of Nassau-Dillenburg (d. 1442). Henceforth it remained in the house of Nassau, passing ultimately to William I. (1533-1584), the first stadtholder of the Netherlands. Breda obtained municipal rights in 1252, but was first surrounded with walls in 1534 by Count Henry of Nassau, who also restored the old castle, originally built by John of Polanen in 1350. From this period until late in the 19th century it remained the most important of the line of fortresses along the Meuse. Breda was captured by surprise by the Spaniards in 1581; but in 1590 it fell again into the hands of Maurice of Nassau, 68 picked men contriving to get into the town concealed under the turf in a peat-boat. The so-called "Spaniard's Hole" still marks the spot where the peat-boat lay. Its surrender in 1625, after a ten months' siege, to the Spaniards under Spinola is the subject of the famous picture by Velasquez in the Museo del Prado in Madrid. In 1637 Breda was recaptured by Frederick Henry of Orange after a four months' siege, and in 1648 it was finally ceded to Holland by the treaty of Westphalia. During the wars of the French Revolution, it was taken by Dumouriez in 1793, evacuated soon after and retaken by Pichegru in 1795, after the whole of Holland had already succumbed to the French. In 1813, a sally being made by the French garrison on an advance-guard of the Russians under Benckendorf, the citizens of Breda again made themselves masters of the town.

Breda was the residence, during his exile, of Charles II., who, by the declaration of Breda (1660), made known the conditions of his acceptance of the crown of England. In 1696 William, prince of Orange and king of England, built the new castle, one of the finest buildings of the period, which now serves as the military academy. Breda also derives some celebrity from the various political congresses of which it has been the scene. In 1575 a conference was held here between the ambassadors of Spain and those of the United Provinces; in 1667 a peace was signed between England, Holland, France and Denmark; and in 1746-1747 the representatives of the same powers met in the town to discuss the terms of another treaty.

BREDAEL, JAN FRANS VAN (1683-1750), Flemish painter, son of Alexander van Bredael (d. 1720), who was also an artist was born in Antwerp. He imitated the style of Wouverman and Breughel with such dexterity that even connoisseurs are often unable to distinguish his copies of their pictures from the originals. He visited England, where he was so well employed that in a few years he was able to retire to his native country with a competency. The earl of Derwentwater was one of his chief patrons. There were several other van Bredaels, who won honour as artists—notably PIETER (1622-1710), Alexander's father, and JOZEF (1688-1730). They were formerly known as "Breda," but this apparently is incorrect, though it occurs as a signature on a picture by Jan Frans in the Amsterdam gallery.

BREDERODE, HENRY, COUNT OF (1531-1568), was born at Brussels in 1531. He was the descendant of an ancient race, which had for some centuries been settled in Holland, and had taken an active part in the affairs of war and peace. Count Henry became a convert to the Reformed faith and placed himself at the side of the prince of Orange and Count Egmont in resisting the introduction of the Spanish Inquisition and Spanish despotism into the Netherlands. In 1566 he was one of the founders of the confederacy of nobles who bound themselves to maintain the rights and liberties of the country by signing a document known as "the Compromise." On the 5th of April of that year Brederode accompanied to the palace a body of 250 confederates, of whom he acted as the spokesman, to present to the regent, Margaret of Parma, a petition setting forth their grievances, called "the Request." It was at a banquet at the Hôtel Culemburg on the 8th of April, presided over by Brederode, that the sobriquet of *les Gueux*, or "the Beggars," was first given to the opponents of Spanish rule. Brederode was banished from the Netherlands by Alva, and died in exile shortly afterwards at the early age of thirty-six.

BREDOW, GOTTFRIED GABRIEL (1773-1814), German historian, was born at Berlin on the 14th of December 1773, and became successively professor at the universities of Helmstädt, Frankfurt-on-Oder and Breslau. He died at Breslau on the 5th of September 1814. Bredow's principal works are *Handbuch der alten Geschichte, Geographie und Chronologie* (Eutin, 1799; English trans., London, 1827); *Chronik des 19. Jahrhunderts* (Altona, 1801); *Entwurf der Weltkunde der Alten* (Altona, 1810); *Weltgeschichte in Tabellen* (Altona, 1801; English trans. by J. Bell, London, 1820); *Grundriss einer Geschichte der merkwürdigsten Weltkündel von 1796-1810* (Hamburg, 1810).

Bredow's posthumous writings were edited by J. G. Kunisch (Breslau, 1823), who added a biography of the author.

BREDOW, a village of Germany, in the kingdom of Prussia, immediately north of Stettin, of which it forms a suburb. Here are the Vulcan iron-works and shipbuilding yards, where the liners "Deutschland" (1900), the "Kaiserin Augusta Victoria" (1906), and the "George Washington" (1908), the largest vessel (722 ft. long, 27,000 tons) in the German mercantile marine, were built; and also sugar, cement and other factories.

BREECH (common in early forms to Teutonic languages), a covering for the lower part of the body and legs. The Latin *braca* or *bracca* is a Celtic word, probably cognate with the Teutonic. The word in its proper meaning is used in the plural, and, strictly, is confined to a garment reaching to the knees only. The meaning of "the hinder part of the body" is later than, and derived from, its first meaning; this sense appears in the "breach" or hinder part of a gun. The word is also found in "breches buoy," a sling life-saving apparatus, consisting of a support of canvas breeches. The "Breeches Bible," a name for the Geneva Bible of 1560, is so called because "breeches" is used for the aprons of fig-leaves made by Adam and Eve. On the stage the phrase a "breeches" part is used when a woman plays in male costume. "Breeching" is a strap passed round the breech of a harnessed horse and joined to the shafts to allow a vehicle to be backed.

BREEDS AND BREEDING. Breeds may be defined as domestic varieties of animals or plants which man has been able to bring into existence and to maintain in existence. The process of breeding includes all the modifying influences which man may bring to bear on a wild stock for the purpose, conscious or unconscious, of establishing and maintaining breeds. Charles Darwin's *Variation of Animals and Plants under Domestication* (1868) was the starting-point of exact knowledge on this subject; when it appeared, it contained not only the best collection of empirical facts, but the only rational theory of the facts. The first relations between man and domesticated animals and plants were due to unconscious or accidental selection of wild stocks that tolerated the vicinity of man and that were useful or attractive to him. The new conditions must have produced modifications in these stocks, whether these were caused by a survival in each generation of individuals with the power of

response to the new environment, or were due to a conscious selection of individuals capable of such favourable response. The essence of the process, however, came to be a conscious selection in each generation of the best individuals, that is to say, of those individuals that seemed to man to be most adapted to his wants. The possibility of establishing a breed depended, therefore, in the first place on the natural variability of wild animals and plants, then on the variations induced in animals and plants under subjection to the new conditions brought about by man's interference, next on the extent to which these variations, natural or artificial, persisted through the series of generations, and finally on man's intelligence in altering or maintaining the conditions of the environment, and in selective mating. The theory of breeds and breeding depends, in fact, on knowledge of variation, of modification by the environment, and of heredity. Any attempt to give an account of what actually has been done by man in establishing breeds would be little more than an imperfect summary of Darwin's work. The articles HEREDITY, MENDELISM and VARIATION and SELECTION show that what may be called the theoretical and experimental knowledge of variation and heredity is far in advance of the practical art of breeding. Even horticulturists, who have been much more successful than those who deal with animals, are still far from being able to predict the result of their selections and crossings. None the less it may be stated definitely that such prediction is already so nearly within the power of the practical breeder that it would be a waste of time to give a summary of the existing rule-of-thumb methods. The art of breeding is so immediately destined to become a science of breeding that existing knowledge and conceptions must be dismissed as of no more than historical interest. (P. C. M.)

BREEZE. (1) A current of air generally taken as somewhat less than a "wind," which in turn is less than a "gale." The term is particularly applied to the light wind blowing landwards by day, "sea-breeze," and the counter wind, blowing off the land at night, "land-breeze." The word appears in Fr. *brise* (admitted by the Academy in 1762). The Span. *brisa*, Port. *brisa*, and Ital. *bressa* are used for a wind blowing from the north or north-east. According to Cotgrave, Rabelais uses *brise* in the sense of *brise*, the name of a dry north or north-east wind prevalent in Switzerland and the bordering parts of France, Italy and Germany. The word is first used in English as applied to the cool sea-breeze blowing usually from the east or north-east in the West Indies and Atlantic sea-coast of Central America. It was then applied to sea-breezes from any quarter, and also to the land-breeze, and so to any light wind or current of air. (2) Fine ashes or cinders, the refuse of coal, coke and charcoal burning. This is probably from the O. Fr. *brése*, modern *braise*, a word connected with *braser*, whence Eng. *brasier*, a pan for burning coals, charcoal, &c.

BREGENZ (anc. *Brigantium*), the capital of the Austrian province of Vorarlberg, as well as of the administrative district of Bregenz. In 1900 its population was 7595, German-speaking and Roman Catholic. It is situated at the south-east angle of the Lake of Constance, and, besides communications by water with the other towns on the shores of that lake, is connected by rail with Feldkirch on the Arlberg line (24 m.) and with Munich. The old town is on a hillock, crowned by the ancient castle, while the new town is built on the level ground at the foot of the hill. The fine parish church (dedicated to St Gall) stands on another mound more to the south. In the local museum are collections of various kinds, especially of the Roman antiquities which have been dug up on the site of the old town. The position of the town on the lake has always made it an important port and commercial centre. Nowadays the main trade is in grain, but much is done also in cattle and in the products of the cotton-spinning factories of Vorarlberg.

We hear of counts of Bregenz as early as the 10th century, their heirs in the early 13th century being the counts of Montfort (a castle north of Feldkirch), who gradually acquired most of the surrounding country (including Feldkirch and Bludenz). But little by little the Habsburgers, counts of Tirol since 1363

bought from them most of their domains—first Feldkirch in 1375, next Bludenz and the Montafon valley in 1394, finally the county of Bregenz in two parts, acquired in 1451 and 1523. In 1408 the Appenzellers were defeated before Bregenz, while in 1647, during the Thirty Years' War, the town was sacked by the Swedes under Wrangel.

(W. A. B. C.)
BREHON LAWS, the English but incorrect appellation of the ancient laws of Ireland, the proper name for which is *Feineachas*, meaning the laws of the Feine or Feini (fainyeh), who were the free Gaelic farmers. *Dighth Feine* is another name for the laws, with the same meaning. Laws of universal application which could be administered only by duly qualified judges were called *Cáin* law, while minor laws administered by nobles and magistrates were called *Urradhus* law. Regular courts and judges existed in Ireland from prehistoric times. The Anglo-Irish word "Brehon" is derived from the Gaelic word *Brethem* (=judge).

The extant remains of these laws are manuscript transcripts from earlier copies made on vellum from the 8th to the 13th century, now preserved with other Gaelic manuscripts in Trinity College and the Royal Irish Academy, Dublin, the British Museum, Oxford University, some private collections and several libraries on the continent of Europe. The largest and most important of these documents is the *Senchus Mór* or "Great Old Law Book." No copy of it now existing is complete, and some portions are missing from all. What remains of it occupies the first, second, and a portion of the third of the volumes produced by the Brehon Law Commission, which was appointed in 1852.

In the *Annals of the Four Masters* it is said: "The age of Christ 438, the tenth year of King Laeghaire (Lairy), the *Senchus Mór* and *Feineachas* of Ireland were purified and written." This entry has ample historical corroboration. Of many separate treatises dealing with special branches of the law, the *Book of Aicill*, composed of opinions or placita of King Cormac Mac Art, otherwise Cormac ua Quim, Ard-Rig of Erin from A.D. 227 until 266, and Cennfaeladh the Learned, who lived in the first part of the 7th century, is the most important.

The text and earlier commentaries are in the *Bearta Feini*—the most archaic form of the Celtic or Gaelic language. From gradual changes in the living tongue through a long expanse of time many words, phrases and idioms in the *Bearta Feini* became obsolete, and are so difficult to translate that the official translations are to some extent confessedly conjectural. In many cases only opening words of the original text remain. Wherever the text is whole, it is curt, elliptical, and yet rhythmical to a degree attainable only through long use. The rigorously authentic character of these laws, relating to, and dealing with, the actual realities of life, and with institutions and a state of society nowhere else revealed to the same extent, the extreme antiquity both of the provisions and of the language, and the meagreness of continental material illustrative of the same things, endow them with exceptional archaic, archaeological and philological interest.

In the earliest times all learned men, whether specially learned in law or not, appear to have acted as judges. Gradually as literature and learning increased, judgments delivered by men without special legal training fell into disfavour. In the 1st century of the Christian era, when Conchobhar or Conor Mac Nessa was king of Ulster, a crisis was reached, the result of which was that no man was allowed to act as Brehon until he had studied the full law course, which occupied twenty years, and had passed a rigorous public examination. The course of study for Brehon and Ollamh, advocate and law-agent respectively, is carefully laid down in the law itself. The Brehonship was not an office of state like that of the modern judge, but a profession in which success depended upon ability and judgment. The Brehon was an arbitrator, umpire, and expounder of the law, rather than a judge in the modern acceptation. It appears, without being expressly stated, that the facts of a case were investigated and ascertained by laymen, probably by the *Aireachtas*—a local assembly or jury—before submission to a Brehon for legal decision. A Brehon whose decision was reversed

upon appeal was liable to damages, loss of position and of free lands, if any, disgrace, and a consequent loss of his profession. No Brehon had any fixed territorial jurisdiction. A party initiating proceedings could select any Brehon he pleased, if there were more than one in his district. Every king or chief of sufficient territory retained an official Brehon, who was provided with free land for his maintenance. In ordinary cases the Brehon's fee was said to have been one-twelfth of the amount at stake.

Assemblies, national, provincial and local, were a marked characteristic of ancient Irish life. They all, without exception, discharged some legal functions, legislative or administrative, and even in those in which amusement predominated, the *Cáin* law was publicly rehearsed. Most of the assemblies were annual, some triennial, some lasted only a day or two, others a week and occasionally longer. All originated in pagan funeral or commemorative rites, and continued to be held, even in Christian times, in very ancient cemeteries. They were called by different names—*Feis*, *Aenach*, *Aireachtas*, *Dál*, &c.

The Feis of Tara, in Meath, was from its origin seven centuries before Christ down to A.D. 560, mainly national and political, being convened by the Ard-Rig, held at his residence, presided over by him, and consisting of the provincial kings, tanists, faiths, Brehons, warriors, historians, poets and other distinguished men from the whole of Ireland. It was due to be held every third year for the purpose of "preserving the laws and rules," and it might be called specially on any urgent occasion. After the statesman had consulted, the laws were proclaimed, with any modifications agreed upon. Then the proceedings became festive, queens and great ladies taking part. The Feis of A.D. 560 was the last regular one held at Tara because the monarch ceased to reside there. One national assembly of an exceptional character was held at Tara in A.D. 697, by a decree of which women were emancipated from liability to military service.

The Aenach held annually at Tailtinn, also in Meath, was a general assembly of the people without restriction of rank, class or country, and became the most celebrated for athletic sports, games and contests. Yet even here the laws were read aloud, and it is not without significance that the last national assembly held at Tailtinn under King Rhoderic O'Connor in 1168 was a political one.

The *Dál-Criche* (=territorial assembly), held at Uisneach in Westmeath, was a gathering for political and quasi-legislative purposes. At one assembly there about a century before Christ, a uniform law of distraint for the whole of Ireland was adopted on the motion of Sen, son of Aigé. This did not prevent the gatherings at Uisneach from being for ages celebrated for gaiety and amusement.

Each provincial kingdom and each tuath had assemblies of its own. Every *faith* and *faith-fine* was a member of a local assembly, the clan system conferring the qualification, and there being no other election.

An assembly when convened by the *Briughfer* for the special purpose of electing a tanist or successor to the king was called a *Tocomra*.

Very careful provision is made for the preparation of the sites of great assemblies, and the preservation of peace and order at them is sanctioned by the severest penalties of the law. The operation of every legal process calculated to occasion friction, such as seizure of property, was suspended during the time the assemblies lasted.

The term *Rig* (reeh=*rex*, king) was applied to four classes or grades of rulers, the lower grades being grouped, each group being subject to one of their number, and all being subject to, and owing tribute and allegiance to the Ard-Rig (=supreme king of Erin). The Ard-Rig had an official residence at Tara and the kingdom of Meath for his special use. The provincial king, *Rig Cúicidh*, also had an official residence and kingdom of his own, together with allegiance and tribute from each *Rig-mor-Tuatha* in his province, who in his turn received tribute and allegiance from each *Rig-Tuatha* under subjection to him. The *Rig-Tuatha* received

tribute and allegiance from the *flaiths* or nobles in his tuath. The tuath was the political unit, and the ruler of it was the lowest to whom the term "king" was applied. For each payment of tribute a king always made some return. Every king was obliged, on his inauguration, to swear that he would govern justly and according to law, to which he remained always subject. The Ard-Rig was selected by the sub-kings and other leading men who legally constituted the Feis of Tara, the sub-kings by those under them in their respective spheres. No person not of full age, imperfectly educated, stupid, blind, deaf, deformed or otherwise defective in mind or body, or for any reason whatsoever unfit to discharge the duties or unworthy to represent the manhood of the nation, could be king, even though he were the eldest son of the preceding king. "It is a forbidden thing for one with a blemish to be king at Tara."

Tuath, *Cinél* and *Clann* were synonyms meaning a small tribe or nation descended from a common ancestor. A king and clan being able, subject to certain limitations, to adopt new members or families, or amalgamate with another clan, the theory of common origin was not rigidly adhered to. Kinship with the clan was an essential qualification for holding any office or property. The rules of kinship largely determined status with its correlative rights and obligations, supplied the place of contract and of laws affecting the ownership, disposition and devolution of property, constituting the clan an organic, self-contained entity, a political, social and mutual insurance co-partnership. The solidarity of the clan was its most important and all-pervading characteristic. The entire territory occupied by a clan was the common and absolute property of that clan. Subject to this permanent and fundamental ownership, part of the land was set apart for the maintenance of the king as such. Warriors, statesmen, Brehons, Ollams, physicians, poets, and even eminent workers in the more important arts, were, in different degrees, rewarded with free lands for their respective public services. On the death of any person so rewarded, the land in theory reverted to the clan; but if like services continued to be rendered by the son or other successor, and accepted by the clan, the land was not withdrawn. The successors of statesmen, for whom the largest provision was made, became a permanent nobility. Flaith (flah = noble chief) was a term applied to a man of this rank. Rank, with the accompanying privileges, jurisdiction and responsibility, was based upon a qualification of kinship and of property, held by a family for a specified number of generations, together with certain concurrent conditions; and it could be lost by loss of property, crime, cowardice or other disgraceful conduct. The *flaiths* in every tuath and all ranks of society were organized on the same hierarchical pattern as royalty. A portion of land called the *Cumhal Senorba* was devoted to the support of widows, orphans and old childless people.

Fine (finna), originally meaning family, came in course of time to be applied to a group of kindred families or to a whole clan. From differences between incidental accounts written in different ages, it appears that the social system underwent some change. For the purpose of conveying some idea, one theory may be taken, according to which the *fine* was made up of seventeen clansmen, with their families, viz. the *Geifine*, consisting of the *flaith-fine* and four others in the same or nearest degree of kinship to the centre, and the *Deirbhfine*, *Tarfine* and *Inafine*, each consisting of four heads of families, forming widening concentric circles of kinship to which the rights and liabilities of the *fine* extended with certainty, but in diminishing degrees.

In course of time a large and increasing proportion of the good land became, under the titles so far described, limited private property. The area of arable land available for the common use of the clansmen was gradually diminished by these encroachments, but was still always substantial. A share of this was the birth-right of every law-abiding member of the Feini who needed it. To satisfy this title and give a start in life to some young men who would otherwise have got none, this land was subject to *Gabhailcine* (= clan-resumption), meaning that the clan resumed the whole area at intervals of a few years for a fresh distribution after some occupants had died, and young men by attaining

manhood had become entitled. Hence the Anglo-Irish word *gavelkind*. Anciently this re-distribution extended throughout the clan at the same time. Later it extended only to the land of a *fine*, each *fine* making its own distribution at its own time and in its own way as determined by the seventeen men above specified. In this distribution men might or might not receive again their former portions. In the latter case compensation was made for unexhausted improvements. This land could not be sold, nor even let except for a season in case of domestic necessity. The Feini who used it had no landlord and no rent to pay for this land, and could not be deprived of it except by the clan for a crime. They were subject only to public tributes and the ordinary obligations of free men. Presumably their homesteads were not on this land and were not subject to *Gabhailcine*. Neither were the unfenced and unappropriated common lands—waste, bog, forest and mountain—which all clansmen were free to use promiscuously at will.

There was hardly any selling and little letting of land in ancient times. Flaiths and other persons holding large areas let to clansmen, who then became *Ceiles*, not land, but the privilege of feeding upon land a number of cattle specified by agreement. Flaiths and Bo-aíres also let cattle to a *ceile* who had none or not enough, and this was the most prevalent practice. There were two distinct methods of letting and hiring—*saer* (= free) and *daer* (= base), the conditions being fundamentally different. The conditions of *saer*-tenure were largely settled by the law, were comparatively easy, did not require any security to be given, left the *ceile* free within the limits of justice to end the connexion, left him competent in case of dispute to give evidence against that of the *flaith*, and did not impose any liability on the *fine* of the *ceile*. By continued user of the same land for some years and discharge of the public obligations in respect of it in addition to the *ciss* or payment as tenant, a *ceile* became a sub-owner or permanent tenant and could not be evicted. There is no provision in these laws for evicting any one. For the hire of cattle a usual payment was one beast in seven per annum for seven years; after which the cattle that remained became the property of the hirer. A *saer-ceile* on growing wealthy might become a *bo-aire*. *Daer-tenure*, whether of cattle or of the right to graze cattle upon land, was subject to a *ciss-miascias* (= wearisome tribute), for the payment of which security had to be given. A man not in the enjoyment of full civil rights, if able to find security, could become a *daer-ceile*. A free clansman by becoming a *daer-ceile* lowered his own status and that of his *fine*, became incompetent to give evidence against that of a *flaith*, and could not end the connexion until the end of the term except by a large payment. The members of his *fine* were liable, in the degree of their relationship, to make good out of their own property any default in the payments. Hence this tenure could not be legally entered into by a free clansman without the permission of his *fine*. *Daer-ceiles* were also exposed to casual burdens, like that of lodging and feeding soldiers when in their district. All payments were made in kind. When the particular kind was not specified by the law or by agreement, the payments were made according to convenience in horses, cattle, sheep, pigs, wool, butter, bacon, corn, vegetables, yarn, dye-plants, leather, cloth, articles of use or ornament, &c. As the clan system relaxed, and the *fine* lost its legal power of fixing the amounts of public tributes, which were similarly payable to the *flaith*, and neglected its duty of seeing that those tributes were duly applied, the *flaith* became able to increase these tributes with little check, to confuse them with rent, to confuse jurisdiction with ownership, and to exalt himself at the expense of his fellow-clansmen. A *flaith* by arranging that his tenants should make their payments at different periods of the year, secured a constant and copious supply without an inconvenient surplus.

People who did not belong to the clan and were not citizens were in a base condition and incompetent to appear in court in suit or defence except through a freeman. The *Bothach* (= cottier) and the *Sen-cléithe* (= old dependent) were people who, though living for successive generations attached to the families of *flaiths*, did not belong to the clan and had no rights of

citizenship. *Fuidhirs*, or manual labourers without property, were the lowest section of the population. Some were born in this condition, some clansmen were depressed into it by crime, consequences of war or other misfortune; and strangers of a low class coming into the territory found their level in it. The *fuidhirs* also were divided into *saer* and *daer*; the former being free by industry and thrift to acquire some property, after which five of them could club together to acquire rights corresponding to those of one freeman. The *daer-fuidhirs* were tramps, fugitives, captives, &c.

Fosterage, the custom of sending children to be reared and educated in the families of fellow-clansmen, was so prevalent, especially among the wealthy classes, and the laws governing it are so elaborate and occupied such a large space, that some mention of it here is inevitable. Beyond mention, there is little to be said, owing to the absence of general principles in an infinity of specific details, mostly domestic and apparently trivial. A child in fosterage was reared and educated suitably for the position it was destined to fill in life. There was fosterage for affection, for payment and for a literary education. Fosterage began when the child was a year old and ended when the marriageable age was reached, unless previously terminated by death or crime. Every fostered person was under an obligation to provide, if necessary, for the old age of foster-parents. The affection arising from this relationship was usually greater, and was regarded as more sacred than that of blood relationship.

The solidarity of clan and *fine* in their respective spheres, the provisions of the system, the simple rural life, and the prevalence of barter and payments in kind, left comparatively little occasion for contracts between individuals. Consequently the rules relating to contract are not very numerous. They are, however, sufficiently solemn. No contract affecting land was valid unless made with the consent of the *fine* and in the presence of the *Aire-Forgaill*. Contracts relating to other kinds of property are more numerous. When important or involving a considerable amount, they had to be made in the presence of a *faith* or magistrate. The *Aire-Coisring* presided over most of the contracts of the common people. The parties to a contract should be free citizens, of full age, sound mind, free to contract or not, and under no legal disability. "The world would be in a state of confusion if express contracts were not binding." From the repeated correlative dicta that "nothing is due without deserving," and that a thing done "for God's sake," i.e. gratis, imposed little obligation, it is clear that the importance of valuable consideration was fully recognized. So also was the importance of time. "To be asleep avails no one"; "Sloth takes away a man's welfare." Contracts made by the following persons were invalid: (1) a servant without his master's authority; (2) a monk without authority from his abbot or manager of temporalities; (3) a son subject to his father without the father's authority; (4) an infant, lunatic, or "one who had not the full vigilance of reason"; (5) a wife in relation to her husband's property without his authority. She was free to hold and deal with property of her own and bind it by contract. If a son living with his father entered into a contract with his father's knowledge, the father was held to have ratified the contract unless he promptly repudiated it. "One is held to adopt what he does not repudiate after knowledge, having the power." Contract of sale or barter with warranty could be dissolved for fraud, provided action was taken within a limited time after the fraud had become known. Treaties and occasional very important contracts were made "blood-covenants" and inviolable by drawing a drop of blood from the little finger of each of the contracting parties, blending this with water, and both drinking the mixture out of the same cup. The forms of legal evidence were pledges, documents, witnesses and oaths. In cases of special importance the pledges were human beings, "hostage sureties." These were treated as in their own homes according to the rank to which they belonged, and were discharged on the performance of the contract. If the contract was broken, they became prisoners and might be fettered or made to work as slaves until the obligation was satisfied. Authentic documents

were considered good evidence. A witness was in all cases important, and in some essential to the validity of a contract. His status affected the force of the contract as well as the value of his evidence; and the laws appear to imply that by becoming a witness, a man incurred liabilities as a surety. The pre-Christian oath might be by one or more of the elements, powers or phenomena of nature, as the sun, moon, water, night, day, sea, land. The Christian oath might be on a copy of the Gospels, a saint's crozier, relic or other holy thing.

These laws recognized crime, but in the same calm and deliberate way in which they recognized contract and other things seriously affecting the people. Although we find in the poems of Debbthach, written in the 5th century and prefixed to the *Sraech Mór*, the sentences, "Let every one die who kills a human being," and "Every living person that inflicts death shall suffer death," capital punishment did not prevail in Ireland before or after. The laws uniformly discountenanced revenge, retaliation, the punishment of one crime by another, and permitted capital punishment only in the last resort and in ultimate default of every other form of redress. They contain elaborate provision for dealing with crime, but the standpoint from which it is regarded and treated is essentially different from ours. The state, for all its elaborate structure, did not assume jurisdiction in relation to any crimes except political ones, such as treason or the disturbance of a large assembly. For these it inflicted the severest penalties known to the law—banishment, confiscation of property, death or putting out of eyes. A crime against the person, character or property of an individual or family was regarded as a thing for which reparation should be made, but the individual or family had to seek the reparation by a personal action. This differed from a civil action only in the terms employed and the elements used in calculating the amount of the reparation. The function of a judge in a criminal as in a civil action was to see that the facts, with modifying circumstances, were fully and truly submitted to him, and then by applying the law to these facts to ascertain and declare the amount of compensation that would make a legal adjustment. For this amount the guilty person, and in his default his kindred, became legally debtor, and the injured person or family became entitled to recover the amount like a civil debt by distraint, if not paid voluntarily. There were no police, sheriffs or public prisons. The decisions of the law were executed by the persons concerned, supported by a highly organized and disciplined public opinion springing from honour and interest and inherent in the solidarity of the clan. There is good reason to believe that the system was as effectual in the prevention and punishment of crime and in the redress of wrongs as any other human contrivance has ever been.

In calculating the amount of compensation the most characteristic and important element was *Einechlan* (= honour-price, honour-value), a value attaching to every free person, varying in amount from one cow to thirty cows according to rank. It was the assessed value of *status* or *caput*. It was frequently of consequence in relation to contracts and other clan affairs; but it emerges most clearly in connexion with crime. By the commission of crime, breach of contract, or other disgraceful or injurious conduct, *Einechlan* was diminished or destroyed, a *capiti diminutio* occurred, apart from any other punishment. Though existing apart from *fine*, *Einechlan* was the first element in almost every *fine*. *Dire* was the commonest word for *fine*, whether great or small. *Eric* (= reparation, redemption) was the *fine* for "separating body from soul"; but the term was used in lighter cases also. In capital cases the word sometimes meant *Einechlan*, sometimes *corp-dire* (= body-fine), but most correctly the sum of these two. It may be taken that, subject to modifying circumstances, a person guilty of homicide had to pay (1) *corp-dire* for the destruction of life, irrespective of rank; (2) the honour-value of the victim; (3) his own honour-value if the deed was unintentional; and (4) double his own honour-value if committed with malice aforethought. The sum of these was in all cases heavy; heaviest when the parties were wealthy. The amount was recoverable as a debt from the criminal to the extent of his

property, and in his default from the members of his *fine* in sums determined by the degree of relationship; and it was distributable among the members of the *fine* of a murdered person in the same proportions, like a distribution among the next of kin. The *fine* of a murderer could free themselves from liability by giving up the murderer and his goods, or if he escaped, by giving up any goods he had left, depriving him of clanship, and lodging a pledge against his future misdeeds. In these circumstances the law held the criminal's life forfeit, and he might be slain or taken as a prisoner or slave. He could escape only by becoming a *deor-fuidhir* in some distant territory. When the effect of a crime did not go beyond an individual, if that individual's *fine* did not make good their claim while the criminal lived, it lapsed on his death. "The crime dies with the criminal." If an unknown stranger or person without property caught red-handed in the commission of a crime refused to submit to arrest, it was lawful to maim or slay him according to the magnitude of the attempted crime. "A person who came to inflict a wound on the body may be safely killed when unknown and without a name, and when there is no power to arrest him at the time of committing the trespass." For crimes against property the usual penalty, as in breach of contract, was generic restitution, the quantity, subject to modifying circumstances, being twice the amount taken or destroyed.

Distress of seizure of property being the universal mode of obtaining satisfaction, whether for crime, breach of contract, non-payment of debt, or any other cause, the law of distress came into operation as the solvent of almost every dispute. Hence it is the most extensive and important branch, if not more than a branch, of these ancient laws. Of several words meaning distress, *athgabail* was the most frequently used. A person having a liquidated claim might either sue a debtor or proceed at his peril to seize without this preliminary. In the latter case the defendant could stop the progress of the seizure by paying the debt, giving a pledge, or demanding a trial; and he then could choose a Brehon. Distress was of two kinds—(1) *athgabail ar fud* (=distress on length, i.e. with time, with delays); and (2) *athgabail tulla* (=immediate distress). Which method was pursued depended partly upon the facts of the case and partly upon the respective ranks of the parties. A person entitled to seize property had to do it himself, accompanied, if the amount was large, by a law agent and witnesses. No man was entitled to seize unless he owned, or had a surety who owned, sufficient property for indemnity or adjustment in case the seizure should be found to have been wrongful. The formalities varied in different circumstances and also at different times in the long ages in which these laws prevailed. Some forms may, in the Irish as in other legal systems, have become merely ceremonial and fictitious.

Tallach (=seizure of immovable property) was made in three periods or delays of ten days each (=30 days). The first step was a notice that unless the debt was paid immediately seizure would be made. Ten days later, the plaintiff crossed the fence in upon the land, with a law agent, a witness and a pair of horses yoked or harnessed, and in a loud voice stated the amount of the debt and called upon the defendant to pay it according to law. On receiving no answer, or an unsatisfactory one, he withdrew. After an interval of ten days more, the creditor entered with his law agent, two witnesses and four horses, went farther in upon the land, repeated his demand, and if refused withdrew. Finally, after a further interval of ten days, he entered once more with his law agent, three witnesses and eight horses, drove up to the debtor's house, repeated his demand, and if not satisfied drove a herd of cattle or a flock of sheep in upon the farm and left them to care for them.

Athgabail ordinarily meant the seizure of movable property. The following technical terms will indicate the procedure in distress with time:—*Aurfoere* (=demand of payment, stating the amount in presence of witnesses); *apad* (=delay); *athgabail* (=the actual seizure); *anad* (=delay after seizure, the thing remaining in the debtor's possession); *iosal* (=the taking away of the thing seized); *fasc* (=notice to the debtor of the amount

due, the *mainder* or pound in which the thing seized is impounded, and the name of the law agent); *dilthim* (=delay during which the thing is in pound); *lobad* (=destruction or forfeiture of the debtor's ownership and substitution of the creditor's ownership). There was no sale, because sale for money was little known. The property in the thing seized, to the amount of the debt and expenses, became legally transferred from the debtor to the creditor, not at all once but in stages fixed by law. A creditor was not at liberty to seize household goods, farming utensils, or any goods the loss of which would prevent the debtor recovering from embarrassment, so long as there was other property which could be seized. A seizure could be made only between sunrise and sunset. "If a man who is sued evades justice, knowing the debt to be due of him, double the debt is payable by him and a fine of five seds." When a large debt was clearly due, and there was no property to seize, the debtor himself could be seized and compelled to work as a prisoner or slave until the debt was paid.

When a defendant was of rank superior to that of the plaintiff, distress had to be preceded by *broscaid* (=fasting). This is a legal process unknown elsewhere except in parts of India. The plaintiff having made his demand and waited a certain time without result, went and sat without food before the door of the defendant. To refuse to submit to fasting was considered indelibly disgraceful, and was one of the things which legally degraded a man by reducing or destroying his honour-value. The law said "he who does not give a pledge to fasting is an evader of all; he who disregards all things shall not be paid by God or man." If a plaintiff having duly fasted did not receive within a certain time the satisfaction of his claim, he was entitled to distrain as in the case of an ordinary defendant, and to seize double the amount that would have satisfied him in the first instance. If a person fasting in accordance with law died during or in consequence of the fast, the person fasted upon was held guilty of murder. Fasting could be stopped by paying the debt, giving a pledge, or submitting to the decision of a Brehon. A creditor fasting after a reasonable offer of settlement had been made to him forfeited his claim. "He who fasts notwithstanding the offer of what should be accorded to him, forfeits his legal right according to the decision of the Feini."

AUTHORITIES.—Since Sir Samuel Ferguson wrote his article on "Brehon Laws" in the 9th edition of this *Encyclopaedia*, much research has been done on the subject, and Ferguson's account is no longer accepted by scholars, either as regards the language or the substance of the laws. Pending the work of a second Brehon Law Commission, the Laws are best studied in the six imperfect volumes (*Ancient Laws of Ireland, 1865-1901*) produced by the first Commission (ignoring their long and worthless introductions); together with Dr. Whitley Stokes's *Criticism* (London, Nutt, 1903) of Atkinson's *Glossary* (Dublin, 1901). The following are important references (kindly supplied by Dr Whitley Stokes) for detailed research:—R. Dareste, *Études d'histoire de droit*, pp. 356-381 (Paris, 1889); Arbois de Jubainville and Paul Collinet, *Études sur le droit celtique* (2 vols., Paris, 1895); Joyce, *Social History of Ancient Ireland*, vol. 1, pp. 168-214 (2 vols., London, 1903); *Zeitschrift für celtische Philologie*, iv, 221 (the Copenhagen fragments of the Laws (Halle, 1903); important letters in *The Academy*, Nos. 699, 700, 701, 702, 703, 704, 706, 707 (substantially covered by Stokes's *Criticism*); *Revue Celtique*, xxx, 344; *Eriu*, i, 209-315 (collation by Kuno Meyer of the Law-tract Crith Gablach); Maine's *Early Hist. of Institutions* (1875) and *Early Law and Custom*, pp. 162, 180 (1883); Hearn's *Aryan Household* (1879), and MacLennan's *Studies in Ancient History*, pp. 453-507 (1876), contain interesting general reference, but the writers were not themselves original students of the laws. L. Ginnell's *Brehon Laws* (1894) may also be consulted. See further the article CELT, sections *Language and Literature*. (L. G.)

BREISACH, or **ALTREISACH**, a town of Germany, in the grand duchy of Baden, on the left bank of the Rhine, standing on a basalt rock 250 ft. above the river, 10 m. W. of Freiburg-im-Breisgau, and on the railway connecting that city with Colmar. Pop. (1900) 5357. It has a fine minster, partly Romanesque, partly Gothic, dating from the 10th to the 15th centuries; of its two principal towers one is 13th century Gothic, the other Romanesque. The interior is remarkable for its rich decorations, especially the wood-carving of the high altar, and for many interesting tombs and pictures. There is little industry, but a considerable trade is done in wines and other agricultural

roadway. On the opposite bank of the Rhine, here crossed by a pulvra bridge, lies the little town of Neubreisach and the fort Mortier.

Breisach (*Brisiacum*), formerly an imperial city and until the middle of the 18th century one of the chief fortresses of the Empire, is of great antiquity. A stronghold of the *Segnani* (a Gallic tribe, which occupied the country of the Doubs and Burgundy), it was captured in the time of Julius Caesar by Ariovistus and became known as the *Mons Brisiacus*. Fortified by the emperor Valentinian in 369 to defend the Rhine against the Germans, it retained its position throughout the middle ages as one of the chief bulwarks of Germany and was called the "cushion and key (*Kissen und Schlüssel*) of the German empire." Its importance was such that it gave its name to the district Breisgau, in which it is situated. In 939 it was taken by the emperor Otto I., and after remaining in the exclusive possession of the emperors for two centuries, was strengthened and shared for a while between them and the bishops of Basel. In 1254 and 1262 the bishops obtained full control over it; but in 1275 it was made an imperial city by King Rudolph I., and at the beginning of the 14th century his son brought it definitively into the possession of the Habsburg monarchs, leaving the bishops but few privileges. In the Thirty Years' War Breisach successfully resisted the Swedes, but after a memorable siege and a defence by General von Reisch, one of the most famous in military annals, it was forced to capitulate to Duke Bernhard of Saxe-Weimar on the 18th of December 1638. The endeavours of the emperor Ferdinand III. to retake it were fruitless, and by the peace of Westphalia (1648) Breisach was annexed to France. By the peace of Ryswick (1697) it was restored to Austria, when Louis XIV. built the town and fortress of Neubreisach on the left bank of the Rhine. Again in 1703 it fell into the hands of the French, owing to treachery, but was ceded to Austria by the peace of Rastatt (1714). Yet again, in the War of the Austrian Succession, it was captured (1744) by the French, who dismantled the fortifications. They reformed it in 1796, and after passing, by the peace of Lunéville (1801), together with the Breisgau to the duke of Modena, Breisach was by the peace of Presburg (1805) finally incorporated with Baden, when the fortifications were razed. During the Franco-German War (1870) Breisach suffered severely from bombardment directed against it from Neubreisach.

BREISGAU, a district of Germany, in the grand duchy of Baden. It extends along the right bank of the Rhine from Basel to Kehl, and includes the principal peaks of the southern Black Forest and the Freiburg valley. The Breisgau, originally a *pagus* or *gau* of the Frankish empire, was ruled during the middle ages by hereditary counts. Of these the earliest recorded is Birtilo (962-995), ancestor of the counts and dukes of Zähringen. On the death of Berchthold V. of Zähringen in 1218, his co-heiresses brought parts of the Breisgau to the counts of Urach and Kyburg, while part went to the margraves of Baden. At the close of the 13th century the Kyburg part of the Breisgau passed to the Habsburgs, who in 1368 acquired also the town and countship of Freiburg, which had been sold by the counts of Urach to the Freiburgers and given in pledge by them to the house of Austria in exchange for a loan of the purchase price, which they were unable to repay. The male Urach line becoming extinct in 1457, an heiress carried what remained of their possessions in the Breisgau to the house of Baden. In the struggle between France and Austria from the 17th century onwards the Breisgau frequently changed masters. In 1801 Austria was forced to cede it to Ercole III., duke of Modena, in compensation for the duchy of which Napoleon had deprived him. His successor Ferdinand took the title of duke of Modena-Breisgau, but on his death in 1805 the Breisgau was divided between Baden and Württemberg. The latter ceded its portion to Baden in 1810.

See Stokvis, *Manuel d'histoire*, &c. (Leiden, 1890-1893).

BREISLAK, SCIPIONE (1748-1826), Italian geologist of German parentage, was born at Rome in 1748. He early distinguished himself as professor of mathematical and mechanical philosophy in the college of Ragusa; but after residing there for

several years he returned to his native city, where he became a professor in the Collegio Nazareno, and began to form the fine mineralogical cabinet in that institution. His leisure was dedicated to geological researches in the papal states. His account of the aluminous district of Tolfa and adjacent hills, published in 1786, gained for him the notice of the king of Naples, who invited him to inspect the mines and similar works in that kingdom, and appointed him professor of mineralogy to the royal artillery. The vast works for the refining of sulphur in the volcanic district of Solfatara were erected under his direction. He afterwards made many journeys through the ancient Campania to illustrate its geology, and published in 1798 his *Topografia fisica della Campania*, which contains the results of much accurate observation. Breislak also published an essay on the physical condition of the seven hills of Rome, which he regarded as the remains of a local volcano,—an opinion shown to be erroneous by the later researches of G. B. Brocchi. The political convulsions of Italy in 1799 brought Breislak to Paris, where he remained until 1802, when, being appointed inspector of the saltpetre and powder manufactories near Milan, he removed to that city. The mineral Breislakite was named after him. He died on the 15th of February 1826. His other publications include:—*Introduzione alla geologia* (1811, French ed. 1819); *Traité sur la structure extérieure du globe*, 3 vols. and atlas (Milan, 1818, 1822); *Descrizione geologica della provincia di Milano* (1822).

BREITENFELD, a village of Germany in the kingdom of Saxony, 5½ m. N.N.W. of Leipzig, noted in military history. The first battle of Breitenfeld was fought on the 17th of September 1631, between the allied Swedish and Saxon armies under Gustavus Adolphus and the imperial forces under Count Tilly. The battlefield is a low ridge running east and west between the villages of Göbschelwitz and Breitenfeld, the position of the Imperialists lying along the crest from Göbschelwitz on the right to a point about 1 m. short of Breitenfeld on the left; opposite this position, and behind a group of villages on the Loberbach stream, lay the Swedish forces, flanked on their left by the Saxon contingent under the elector, who was assisted by Arnim. The villages formed the only obstacle on the gentle slope lying between the Loberbach and Tilly's line; through these villages the Swedes defiled slowly, and formed up on the open ground beyond them. Tilly's army was drawn up in a continuous line, the infantry ranged in heavy battalions in the centre, the cavalry on the wings, and the heavy artillery in a mass in front of the infantry. Gustavus arrayed the Swedes in two lines and a reserve, infantry in the centre, cavalry on the flanks, and the Saxons were drawn up in a similar formation on the left of the Swedish left-wing cavalry. So far as can be gauged the respective numbers were at least 32,000 Imperialists, 22,000 Swedes and 15,000 Saxons. The Swedish infantry was drawn up on an entirely novel system; each brigade of infantry, composed of several battalions, was formed in many small and handy corps of pikemen and musketeers, and parties of musketeers were also detached to support the cavalry. The guns were scattered along the front. The Saxons were ranged, like Tilly's army, in heavy masses of foot and horse preceded by a great battery of guns. At 2 P.M. Pappenheim, commanding Tilly's left wing, led forward the whole of his cavalry in a furious charge. Feeding the fire of the musketeers who were intercalated amongst the Swedish horse, Pappenheim swung round to his left and charged the Swedish right wing in flank. The Swedes of both lines promptly wheeled up, and after a prolonged conflict the Imperial horse were driven completely off the field. The attack of Tilly's right wing under Fürstenberg directed against the Saxons was more successful. The Saxons were at once broken and routed, only a handful under Arnim maintaining the ground. Fürstenberg pursued the fugitives for many miles, and Tilly with the centre of infantry (which, considering the depth of its formations, must have possessed great manœuvring power) rapidly followed him and formed up opposite the now exposed left of the Swedes. Thereupon the Swedes, in their light and handy formation, changed position rapidly and easily to meet him. Tilly's attack

was strenuously opposed, and at this moment the decisive stroke of the battle was delivered by the Swedish right wing, which, having disposed of Pappenheim, swung round and occupied the ground originally held by the Imperial infantry, seized Tilly's guns, and with them enfiladed the enemy's new line. This put an end to the attack of the Imperial foot, and before sunset Tilly was in full retreat, hotly pursued and losing heavily in prisoners. His losses on the field have been estimated at 7000 killed and wounded and almost as many prisoners; the Swedes lost about 2000 and the Saxons over 4000 men.

The village of Breitenfeld also gives its name to another great battle in the Thirty Years' War (November 2, 1642), in which the Swedes under Torstensson defeated the Imperialists under the archduke Leopold and Prince Piccolomini, who were seeking to relieve Leipzig. The Swedish cavalry decided the day on this occasion also.

BREMEN, a free state in the German empire, bearing the title *Freie Hansestadt Bremen*. It falls into three distinct parts: (1) the largest portion, with the city of Bremen, lying on both banks, but chiefly on the right, of the lower course of the Weser, surrounded by the Prussian province of Hanover and the grand-duchy of Oldenburg, and consisting in the main of lowland country intersected by canals and dykes; (2) the town and district of Vegesack, lying separate from, but immediately north of the main portion, on the right bank of the river; (3) the port of Bremerhaven, 46 m. down the Weser, at its mouth. Of the whole territory, which has an area of 99 sq. m., about one-half is meadow and grazing land, one-quarter under tillage, and the remainder occupied by a little woodland, some unprofitable sandy wastes, the bed of the Weser and the towns. Market gardening, the rearing of cattle, for which the district is widely famed, and fishing, form the chief occupations of the rural population. The climate is mild, but the rainfall (26.9 in. annually on the average) is relatively considerable. The population is shown as follows:—

	1900.	1905.
Bremen, city	186,822	214,953
Vegesack	3,943	4,130
Bremerhaven	20,315	24,159
Rural districts	37,327	20,431
Total	248,407	263,673

Of the inhabitants, who belong to the Lower Saxon (*Nieder-Sachsen*) race and in daily intercourse mostly speak the Low German (*Plattdeutsch*) dialect, about two-thirds are natives of the state and one-third immigrants from other parts of Germany, chiefly from Hanover and Oldenburg. About 93% are Protestants, 6% Roman Catholics, and only 1% Jews. The form of government is that of a republic, under a constitution proclaimed on the 8th of March 1849, revised on the 21st of February 1854, the 17th of November 1875, and the 1st of January 1894. The sovereignty resides jointly in the senate and the Bürgerschaft, or Convent of Burgesses. The senate, which is the executive power, is composed of sixteen life members, elected by the convent, on presentation by the senate. Of these ten at least must be lawyers and three merchants. Two of the number are nominated by their colleagues as burgomasters, who preside in succession for a year at a time and hold office four years, one retiring every two years. The Bürgerschaft consists of 150 (formerly 300) representatives, chosen by the citizens for six years, and forms the legislative body. Fourteen members are elected by such citizens of Bremen (city) as have enjoyed a university education, forty by the merchants, twenty by the manufacturers and artisans, and forty-eight by the other citizens. Of the remaining representatives, twelve are furnished by Bremerhaven and Vegesack and sixteen by the rural districts. As a member of the German empire, the state of Bremen has one voice in the Bundesrat and returns one member to the Imperial diet (Reichstag). Formerly Bremen was a free port, but from the 1st of October 1888 the whole of the state, with the exception of two small free districts in Bremen and Bremerhaven respectively,

joined the German customs union. The state has two Amtsgerichte (courts of first instance) at Bremen and Bremerhaven respectively, and a superior court, Landgericht, at Bremen, whence appeals lie to the Oberlandesgericht for the Hanseatic towns in Hamburg. The judges of the Bremen courts are appointed by a committee of members of the senate, the Bürgerschaft and the bench of judges. By the convention with Prussia of the 27th of June 1867, the free state surrendered its right to furnish its own contingent to the army, the recruits being after that time drafted into the Hanseatic infantry regiment, forming a portion of the Prussian IX. army corps.

BREMEN, a city of Germany, capital of the free state of Bremen, and one of the Hanseatic towns. It lies on a sandy plain on both banks of the Weser, 46 m. from the North Sea and 71 m. S.W. from Hamburg by rail, on the main line to Cologne. Pop. (1905) 214,953. It has also direct railway communication with Berlin via Uelzen, Hanover and Bremerhaven. The city consists of four quarters,—the old town (Altstadt) and its suburban extensions (Vorstadt) being on the right bank of the river, and the new town (Neustadt) with its southern suburb (Südvorstadt) on the left bank. The river is crossed by three bridges, the old, the new (1872-1875) Kaiserbrücke, and the railway bridge, with a gangway for foot passengers. The ramparts of the old town have long been converted into beautiful promenades and gardens, the moats forming a chain of lakes.

The romantic old town, with its winding streets and lanes, flanked by massive gabled houses, dates from the medieval days of Hanseatic prosperity. On the market square stands the fine town hall (Rathaus), dating from the 15th century, with a handsome Renaissance *façade* of a somewhat later date, and before it a stone statue of Roland, the emblem of civic power. Its celebrated underground wine cellar has been immortalized by Wilhelm Hauff in his *Phantasien im Bremer Ratskeller*. The town hall is internally richly embellished and has a gallery of interesting paintings. In an upper hall a model of an old Hanseatic frigate, with the device *Navigare necesse est, vivere non est necesse*, hangs from the ceiling. Among other ancient buildings, situated chiefly in the old town, are the following:—the cathedral of St Peter (formerly the archiepiscopal and now the Lutheran parish church), erected in the 12th century on the site of Charlemagne's wooden church, and famous for its Bleikeller, or lead vault, in which bodies can be preserved for a long time without suffering decomposition; the church of St Ansgarius, built about 1243, with a spire 400 ft. high; the church of Our Lady, dating from the 12th and 13th centuries; the 12th century Romanesque church of St Stephen; the Schütting, or merchants' hall, originally built in 1619 for the cloth-traders' guild; the Stadthaus (town house), formerly the archiepiscopal palace, and converted to its present uses only in 1819. The most important and imposing among the more modern architectural additions to the city are the handsome Gothic exchange, completed in 1867; the municipal theatre, the municipal library, the post office (1878), the law courts (1891-1895), the wool exchange, the German bank, the municipal museum for natural science, ethnology and commerce, and the fine railway station (1888). The principal memorials embrace, besides the Roland, the Willehad fountain (1883), the monument of the Franco-German War (erected 1875), the centaur fountain (1891), an equestrian statue of the emperor William I. (1893), and a statue of the poet Theodor Körner. A beautiful park, Bürgerpark, has been laid out in the Bürgerweide, or meadows, lying beyond the railway station to the north-east of the city. It is a peculiarity of the domestic accommodation of Bremen that the majority of the houses, unlike the custom in most other German towns, where flats prevail, are occupied by a single family only.

The industries and manufactures of Bremen are of considerable variety and extent, but are more particularly developed in such branches as are closely allied to navigation, such as shipbuilding, founding, engine-building and rope-making. Next in importance come those of tobacco, snuff, cigars, the making of cigar boxes, jute-spinning, distilling, sugar refining and the shelling of rice. Bremen owes its fame almost exclusively to its transmaritime

trade, mainly imports. By the completion of the engineering works on the Weser in 1887-1899, whereby, among other improvements, the river was straightened and deepened to 18 ft., large ocean-going vessels are able to steam right up to the city itself. It has excellent railway connexions with the chief industrial districts of Germany. Like Hamburg, it does predominantly a transit trade; it is especially important as the importer of raw products from America. In two articles, tobacco and rice, Bremen is the greatest market in the world; in cotton and indigo it takes the first place on the continent, and it is a serious rival of Hamburg and Antwerp in the import of wool and petroleum. The value of the total imports (both sea-borne and by river and rail) increased from £22,721,700 in 1883 to about £60,000,000 in 1905; the imports from the United States, from £9,755,000 in 1883 to about £25,000,000 in 1905. The countries from which imports principally come are the United States, England, Germany, Russia, the republics of South America, the Far East and Australia. The exports rose from a total of £26,006,500 in 1883 to £62,000,000 in 1905. The number of vessels which entered the ports of the free state (i.e. Bremen city, Bremerhaven and Vegesack) increased from 2869 of 1,258,529 aggregate tonnage in 1883, to 4024 of 2,716,633 tons in 1900. Bremen is the centre for some of the more important of the German shipping companies, especially of the North German Lloyd (founded in 1856), which, on the 1st of January 1905, possessed a fleet of 382 steamers of 693,892 tons, besides lighters and similar craft. Bremen also shares with Hamburg the position of being one of the two chief emigration ports of Germany. There are three docks, all to the north-west of the city—namely, the free harbour (which was opened in 1888), the winter harbour, and the timber and industrial harbour. Internal communication is served by an excellent system of electric tramways, and there is also a local steamboat service with neighbouring villages on the Weser.

History.—According to Brandes, quoting Martin Luther in the *Lexicon Philologicum*, the name is derived from *Bram, Bräm*, i.e. *hem* = the river-bank, or confine of the land on which it was built. In 787 Bremen was chosen by St Willehad, whom Charlemagne had established as bishop of the *pays* of the lower Weser, as his see. In 848 the destruction of Hamburg by the Normans led to the transference of the archiepiscopal see of Hamburg to Bremen, which became the seat of the archbishops of Hamburg-Bremen. In 965 the emperor Otto I. granted to Archbishop Adalag "in the place called Bremen" (*in loco Bremun nuncupato*) the right to establish a market, and the full administrative, fiscal and judicial powers of a count, no one but the bishop or his *advocatus* being allowed to exercise authority in the city. This privilege, by which the archbishop was lord of the city and his *Vogt* its judge, was frequently confirmed by subsequent emperors, ending under Frederick I. in 1158. Though, however, there is no direct evidence of the existence of any communal organization during this period, it is clear from the vigorous part taken by the burghers in the struggle of the emperor Frederick with Henry the Lion of Saxony that some such organization very early existed. Yet in the *privilegium* granted to the townspeople by Frederick I. in 1186 the emperor had done no more than guarantee them their personal liberties. The earliest recognition of any civic organization they may have possessed they owed to Archbishop Hartwig II. (1184-1207), who had succeeded in uniting against him his chapter, the nobles and the citizens; and the first mention of the city council occurs in a charter of Archbishop Gerhard II. in 1225, though the *consules* here named doubtless represented a considerably older institution. In the 13th century, however, whatever the civic organization of the townsfolk may have been, it was still strictly subordinate to the archbishop and his *Vogt*; the council could issue regulations only with the consent of the former, while in the judicial work of the latter, save in small questions of commercial dishonesty, its sole function was advisory. By the middle of the 14th century this situation was exactly reversed; the elected town council was the supreme legislative power in all criminal and civil causes, and in the court of the *advocatus* two *Ratsmänner* sat as assessors.

The victory had been won over the archbishop; but a fresh peril had developed in the course of the 13th century in the growth of a patrician class, which, as in so many other cities, threatened to absorb all power into the hands of a close oligarchy. In 1304 the commonalty rose against the patricians and drove them from the city, and in the following year gained a victory over the exiles and their allies, the knights, which was long celebrated by an annual service of thanksgiving. This was the beginning of troubles that lasted intermittently throughout the century. Bremen had been admitted to the Hanseatic league in 1283, but was excluded in 1285, and not readmitted until 1358. Owing to the continued civic unrest it was again excluded in 1427, and only readmitted in 1433 when the old aristocratic constitution was definitively restored. But though in Bremen the efforts of the craftsmen's "arts" to secure a share of power had been held in check and the guilds never gained any importance, the city government did not, as at Cologne and elsewhere, develop into a close patrician oligarchy. Power was in the hands of the wealthy, but the avenues to power were open to those who knew how to acquire the necessary qualification. There was thus no artificial restraint put upon individual enterprise, and the question of the government having been settled, Bremen rapidly developed in wealth and influence.

The Reformation was introduced into Bremen in 1522 by Heinrich von Zütphen. Archbishop Christopher of Brunswick-Wolfenbüttel (1487-1558), a brutal libertine, hated for his lusts and avarice, looked on the reforming movement as a revolt against himself. He succeeded in getting the reformer burned, but found himself involved in a life and death struggle with the city. In 1532 Bremen joined the league of Schmalkalden, and twice endured a siege by the imperial forces. In 1547 it was only saved by Mansfeld's victory at Drakenburg. Archbishop Christopher was succeeded in 1558 by his brother Georg, bishop of Minden (d. 1566), who, though he himself was instrumental in introducing the reformed model into his other diocese of Verden, is reckoned as the last Roman Catholic archbishop of Bremen. His successor, Henry III. (1550-1585), a son of Duke Francis I. of Lauenburg, who had been bishop of Osnabrück and Paderborn, was a Lutheran and married. Protestantism was not, however, definitively proclaimed as the state religion in Bremen until 1618. The last archbishop, Frederick II. (of Denmark), was deposed by the Swedes in 1644. In 1646 Bremen received the privileges of a free imperial city from the emperor Ferdinand III.; but Sweden, whose possession of the archbishopric was recognized two years later, refused to consent to this, and in 1666 attempted vainly to assert her claims over the city by arms—in the so-called Bremen War. When, however, in 1720 the elector of Hanover (George I. of Great Britain) acquired the archbishopric, he recognized Bremen as a free city. In 1803 this was again recognized and the territory of the city was even extended. In 1806 it was taken by the French, was subsequently annexed by Napoleon to his empire, and from 1810 to 1813 was the capital of the department of the Mouths of the Weser. Restored to independence by the congress of Vienna in 1815, it subsequently became a member of the German Confederation, and in 1867 joined the new North German Confederation, with which it was merged in the new German empire.

See Buchenau, *Die freie Hansestadt Bremen* (3rd ed. Bremen, 1900, 5 vols.); *Bremisches Urkundenbuch*, edited by R. Ehmke and W. von Bippen (1863, fol.); W. von Bippen, *Geschichte der Stadt Bremen* (Bremen, 1892-1898); F. Donandt, *Versuch einer Geschichte des bremischen Stadtrechts* (Bremen, 1830, 2 vols.); *Bremisches Jahrbuch* (historical, 19 vols., 1864-1900); and Karl Hegel, *Städte und Gilden*, vol. ii. p. 461 (Leipzig, 1891).

BREMER, FREDRIKA (1801-1865), Swedish novelist, was born near Åbo, in Finland, on the 17th of August 1801. Her father, a descendant of an old German family, a wealthy iron master and merchant, left Finland when Fredrika was three years old, and after a year's residence in Stockholm, purchased an estate at Arsta, about 20 m. from the capital. There, with occasional visits to Stockholm and to a neighbouring estate, which belonged for a time to her father, Fredrika passed her time till 1820. The education to which she and her sisters were subjected

was unusually strict; Fredrika's health began to give way; and in 1821 the family set out for the south of France. They travelled slowly by way of Germany and Switzerland, and returned by Paris and the Netherlands. It was shortly after this time that Miss Bremer became acquainted with Schiller's works, which made a very deep impression on her. She had begun to write verses from the age of eight, and in 1828 she succeeded in finding a publisher for the first volume of her *Teckningar ur kvardagslivet* (1828), which at once attracted attention. The second volume (1831), containing one of her best tales, *Familjen H.*, gave decisive evidence that a real novelist had been found in Sweden. The Swedish Academy awarded her their smaller gold medal, and she increased her reputation by *Presidentens dottrar* (1834), *Grannarne* (1837) and others. Her father had died in 1830, and her life was thereafter regulated in accordance with her own wishes and tastes. She lived for some years in Norway with a friend, after whose death she travelled in the autumn of 1849 to America, and after spending nearly two years there returned through England. The admirable translations (1846, &c.) of her works by Mary Howitt, which had been received with even greater eagerness in America and England than in Sweden, secured for her a warm and kindly reception. Her impressions of America, *Hemmen i nya världen*, were published in 1853-1854, and at once translated into English. After her return Miss Bremer devoted herself to her scheme for the advancement and emancipation of women. Her views on these questions were expounded in her later novels—*Herika* (1856) and *Far och dotter* (1858). Miss Bremer organized a society of ladies in Stockholm for the purpose of visiting the prisons, and during the cholera started a society, the object of which was the care of children left orphans by the epidemic. She devoted herself to other philanthropic and social schemes, and gradually abandoned her earlier simple and charming type of story for novels directed to the furtherance of her views. In these she was less successful. In 1856 she again travelled, and spent five years on the continent and in Palestine. Her reminiscences of these countries have all been translated into English. On her return she settled at Årsta, where, with the exception of a visit to Germany, she spent the remaining years of her life. She died on the 31st of December 1865.

See *Life, Letters and Posthumous Works of F. Bremer*, by her sister, Charlotte Bremer, translated by F. Milow, London, 1868. A selection of her works in 6 vols. appeared at Örebro, 1868-1872.

BREMERHAVEN, a seaport town of Germany, in the free state of Bremen, on the right bank and estuary of the Weser, at the confluence of the Geeste, 38 m. N. of the city of Bremen by rail. Pop. (1895) 18,366; (1905) 24,159. It is built on a tract of territory ceded to Bremen by Hanover in 1826, and further increased by treaty with Prussia in 1869. It forms practically a single town with Geestemünde (Prussia), which lies across the Geeste and with which it is connected by a drawbridge. The port was opened in 1830, and besides an excellent harbour, there are three large wet docks, including the Kaiserhafen, enlarged in 1897-1899 at a cost of £900,000. This, together with the north portion of the Neuerhafen, constitutes the free harbour. Here are the workshops and dry docks of the North German Lloyd steamship company. The whole internal harbour system is furnished with powerful hydraulic cranes and lines of railway running alongside the quays. The entrance to the port is free from ice nearly all the year round, is excellently buoyed, and lighted by two lightships and eight lighthouses, among the latter the remarkable Rothesand Leuchtturm, erected 1884-1885. The Hanoverian fort and batteries, which formerly protected the town, have been removed, and their place is supplied by four modern forts, with revolving turtleback turrets, lower down. The town possesses two Protestant and a Roman Catholic church, a technical institute, a natural history museum, a library, a theatre, a monument to the emperor William I. and one to Johann Smidt (1773-1850), the burgomaster of Bremen to whose enterprise the harbour of Bremerhaven is due. Shipbuilding and kindred industries are carried on.

BRENDAN, BRANDON, or BRANDAN (c. 484-578), Irish saint and hero of a legendary voyage in the Atlantic, is said to have

been born at Tralee in Kerry in A.D. 484. The Irish form of his name is *Brennain*, the Latin *Brendanus*. Medieval historians usually call him Brendan of Clonfert, or Brendan son of Finnloga, to distinguish him from his contemporary, St Brendan of Birr (573). Little is known of the historical Brendan, who died in 578 as abbot of a Benedictine monastery which he had founded twenty years previously at Clonfert in eastern Galway. The story of his voyage across the Atlantic to the "Promised Land of the Saints," afterwards designated "St Brendan's Island," ranks among the most celebrated of the medieval sagas of western Europe. Its traditional date is 565-573. The legend is found, in prose or verse and with many variations, in Latin, French, English, Saxon, Flemish, Irish, Welsh, Breton and Scottish Gaelic. Although it does not occur in the writings of any Arabian geographer, several of its incidents—such as the landing on a whale in mistake for an island—belong also to Arabic folk-literature. Many of Brendan's fabulous adventures seem to be borrowed from the half-pagan Irish saga of Maelduin or Maeldune, and others belong also to Scandinavian mythology. The oldest extant version of the legend is the 11th century *Navigatio Brendani*.

St Brendan's island was long accepted as a reality by geographers. In a Venetian map dated 1367, in the anonymous Weimar map of 1424, and in B. Beccario's map of 1435, it is identified with Madeira. Columbus, in his journal for the 9th of August 1492, states that the inhabitants of Hierro, Gomera and Madeira had seen the island in the west; and Martin Behaim, in the globe he made at Nuremberg in the same year, places it west of the Canaries and near the equator. During the 16th century the progress of exploration in these latitudes compelled many cartographers to locate the island elsewhere; and it was marked about 100 m. west of Ireland, or afterwards among the West Indies. But in Spain and Portugal the older belief as to its situation was maintained. In 1526 an expedition under Fernando Alvarez left Grand Canary in search of St Brendan's island, which had again been reported as seen by many trustworthy witnesses. In 1570 an official inquiry was held, and a second expedition undertaken, by Fernando de Villalobos, governor of Palma. Similar voyages of discovery were made by the Canarians in 1604 and 1721; and only in 1759 was the apparition of St Brendan's island explained as an effect of mirage.

Among the numerous books which deal with the legend, the following are important: *Die altfranzösische Prosaübersetzung von Brendani Meerfahrt*, by C. Wahlund (Upsala, 1900); *Le "Navigatio Sancti Brendani" in antico Veneziano*, by F. Novati (Bergamo, 1892); *Zur Brendanus-Legende*, &c., by G. Schirmer (Leipzig, 1888); *Les Voyages merveilleux de St. Brendan*, &c., by F. Michel (Paris, 1878); and *Acta Sancti Brendani . . . Original Latin Documents connected with the Life of St. Brendan*, by P. F. Moran (Dublin, 1872).

BRENNHAM, a city and the county-seat of Washington county, Texas, U.S.A., situated in the S.E. part of the state, about 68 m. N.W. of Houston. Pop. (1890) 5209; (1900) 5968, including 2701 negroes and 531 foreign-born; (1910) 4718. Brenham is served by the Gulf, Colorado & Santa Fé (controlled by the Atchison, Topeka & Santa Fé) and the Houston & Texas Central railways. It is the seat of Blinn Memorial College (German Methodist Episcopal), opened as "Mission Institute" in 1883, and renamed in 1889 in honour of the Rev. Christian Blinn, of New York, a liberal benefactor; of Brenham Evangelical Lutheran College, and of a German-American institute (1898). The municipality owns and operates the waterworks. The city is situated in an agricultural and cotton-raising region, and has cotton compresses and gins, cotton mills, cotton-seed oil refineries, foundries and machine shops, and furniture and wagon factories. Brenham was settled about 1844, was incorporated in 1866, and was chartered as a city in 1873.

BRENNER PASS, the lowest (4495 ft.) and one of the most frequented passes across the Alps in all ages, though the name itself rarely occurs in the middle ages, the route over it being said to lie through "the valley of Trent." It may be described as the great gate of Italy, and by it most of the Teutonic tribes made their way to Italy. One reason of its importance is that

many side passes in the end join this great thoroughfare. It was crossed no fewer than 66 times by various emperors, between 793 and 1402. A carriage road was constructed over it as far back as 1772, while the railway over it was built in 1864-1867. From Innsbruck to the summit of the pass is a distance by rail of 25 m. The line then descends through the Eisack valley past Brixen (34 m.) to Botzen (24 m.). Thence it follows the valley of the Adige to Trent (35 m.) and on to Verona (56½ m.)—in all 174½ m. by rail from Innsbruck to Verona. (W. A. B. C.)

BRENNUS, the name, or perhaps the official title, of two chiefs of the Celtic Gauls.

(1) The first Brennus crossed the Apennines in 391 B.C., ravaged Etruria, and annihilated a Roman army of about 40,000 men on the Allia some 12 m. from Clusium (July 16, 390). Rome thus lay at his mercy, but he wasted time, and the Romans were able to occupy and provision the Capitol (though they had not sufficient forces to defend their walls) and to send their women and children to Veii. When on the third day the Gauls took possession, they found the city occupied only by those aged patrians who had held high office in the state. For a while the Gauls withheld their hands out of awe and reverence, but the ruder passions soon prevailed. The city was sacked and burnt; but the Capitol itself withstood a siege of more than six months, saved from surprise on one occasion only by the wakefulness of the sacred geese and the courage of Marcus Manlius. At last the Gauls consented to accept a ransom of a thousand pounds of gold. As it was being weighed out, the Roman tribune complained of some unfairness. Brennus at once threw his heavy sword into the scale; and when asked the meaning of the act, replied that it meant *Vae victis* ("woe to the conquered"). The Gauls returned home with their plunder, leaving Rome in a condition from which she took long to recover. A later legend, probably an invention, represents M. Furius Camillus as suddenly appearing with an avenging army at the moment when the gold was being weighed, and defeating Brennus and all his host.

See Livy v. 33-49; Plutarch, *Camillus*, 17, 22, 28; Polybius i. 6, ii. 18; Dion. Halic. xiii. 7.

(2) The second Brennus is said to have been one of the leaders of an inroad made by the Gauls from the east of the Adriatic into Thrace and Macedonia (280), when they defeated and slew Ptolemy Ceraunus, then king of Macedonia. Whether Brennus took part in this first invasion or not is uncertain; but its success led him to urge his countrymen to a second expedition, when he marched with a large army through Macedonia and Thessaly until he reached Thermopylae. To this point the united forces of the northern Greeks—Athenians, Phocians, Boeotians and Aetolians—had fallen back; and here the Greeks a second time held their foreign invaders in check for many days, and a second time had their rear turned, owing to the treachery of some of the natives, by the same path which had been discovered to the Persians two hundred years before. Brennus and his Gauls marched on to Delphi, of whose sacred treasures they had heard much. But the little force which the Delphians and their neighbours had collected—about 4000 men—favoured by the strength of their position, made a successful defence. They rolled down rocks upon their enemies as they crowded into the defile, and showered missiles on them from above. A thunder-storm, with hail and intense cold, increased their confusion, and on Brennus himself being wounded they took to flight, pursued by the Greeks all the way back to Thermopylae. Brennus killed himself, "unable to endure the pain of his wounds," says Justin; more probably determined not to return home defeated.

See Justin xxiv. 6; Diod. Sic. xxii. 11; Pausanias x. 19-23; L. Contzen, *Die Wanderungen der Kelten* (Leipzig, 1861).

BRENTANO, KLEMENS (1778-1842), German poet and novelist, was born at Ehrenbreitstein on the 8th of September 1778. His sister was the well-known Bettina von Arnim (q.v.), Goethe's correspondent. He studied at Jena, and afterwards resided at Heidelberg, Vienna and Berlin. In 1818, weary of his somewhat restless and unsettled life, he joined the Roman Catholic Church and withdrew to the monastery of Dülmen,

where he lived for some years in strict seclusion. The latter part of his life he spent in Regensburg, Frankfurt and Munich, actively engaged in Catholic propaganda. He died at Aschaffenburg on the 28th of July 1842. Brentano, whose early writings were published under the pseudonym Maria, belonged to the Heidelberg group of German-romantic writers, and his works are marked by excess of fantastic imagery and by abrupt, bizarre modes of expression. His first published writings were *Satiren und poetische Spiele* (1800), and a romance *Godwi* (1801-1802); of his dramas the best are *Ponce de Léon* (1804), *Victoria* (1817) and *Die Gründung Prags* (1815). On the whole his finest work is the collection of *Romanzen vom Rosenkranz* (published posthumously in 1852); his short stories, and more especially the charming *Geschichte vom braven Kasperl und dem schönen Annerl* (1838), which has been translated into English, are still popular. Brentano also assisted Ludwig Achim von Arnim, his brother-in-law, in the collection of folk-songs forming *Des Knaben Wunderhorn* (1806-1808).

Brentano's collected works, edited by his brother Christian, appeared at Frankfurt in 9 vols. (1851-1855). Selections have been edited by J. B. Diel (1873), M. Koch (1892), and J. Dohmke (1893). See J. B. Diel and W. Kreiten, *Klemens Brentano* (2 vols., 1877-1878), the introduction to Koch's edition, and R. Steig, *A. von Arnim und K. Brentano* (1894).

BRENTANO, LUDWIG JOSEPH [called Lujjo] (1844-), German economist, a member of the same family as the preceding, was born at Aschaffenburg on the 18th of December 1844. He received some of his academical education in Dublin. In 1868 he made a thorough study of trade-unionism in England, which resulted in his principal work, *Die Arbeitergilden der Gegenwart* (Leipzig, 1871-1872; Eng. trans. by L. T. Smith). The book was assailed by Bamberger and other economists, but is important not only as an authority on modern associations of workmen, but for having given an impetus to the study of the guilds of the middle ages, and the examination of the great stores of neglected information bearing upon the condition of the people in olden days. Brentano's other works are of a more theoretical character, and chiefly relate to political economy, of which he was professor at Breslau from 1872 to 1882, at Strassburg from 1882 to 1888, at Vienna 1888-1889, at Leipzig 1889-1891, and at Munich since 1891. We may mention *Das Arbeitsverhältnis gemäss dem heutigen Recht* (1877); *Die christlich-soziale Bewegung in England* (1883); *Über das Verhältnis von Arbeitslohn und Arbeitszeit zur Arbeitsleistung* (1893); *Agropolitik* (1897).

BRENTFORD, a market town in the Brentford parliamentary division of Middlesex, England, 10½ m. W. of Waterloo terminus, London, by the London & South-Western railway, at the junction of the river Brent with the Thames. Pop. of urban district (1901) 15,171. The Grand Junction Canal joins the Brent, affording ample water-communications to the town, which has considerable industries in brewing, soap-making, saw-milling, market-gardening, &c. The Grand Junction waterworks are situated here. Brentford has been the county-town for elections since 1701.

In 1016 Brentford, or, as it was often called Braynford, was the scene of a great defeat inflicted on the Danes by Edmund Ironside. In 1280 a toll was granted by Edward I., who granted the town a market, for the construction of a bridge across the river, and in the reign of Henry VI. a hospital of the Nine Orders of Angels was founded near its western side. In 1642 a battle was fought here in which the royalists defeated the parliamentary forces. For his services on this occasion the Scotsman Ruthven, earl of Forth, was made earl of Brentford, a title afterwards conferred by William III. on Marshal Schomberg. Brentford was during the 16th and 17th centuries a favourite resort of London citizens; and its inn of the Three Pigeons, which was kept for a time by John Lowin, one of the first actors of Shakespeare's plays, is frequently alluded to by the dramatists of the period. Falstaff is disguised as the "Fat Woman of Brentford" in Shakespeare's *Merry Wives of Windsor*, and numerous other references to the town in literature point, in most cases, to its reputation for excessive dirt. The "two kings of Brentford" mentioned in Cowper's *Task*, and elsewhere, seem to owe their

mythical existence to the play, *The Rehearsal*, by George Villiers, second duke of Buckingham, produced in 1671.

South of Brentford, towards Isleworth, is Sion House, a mansion founded by Lord Protector Somerset in 1547, and rebuilt and enlarged by the 10th earl of Northumberland and Sir Hugh Smithson, afterwards duke of Northumberland, the architects being Inigo Jones and Robert Adam. The gardens are very beautiful. The site of Sion or Syon House was previously occupied by a convent of Bridgetine nuns established at Twickenham by Henry V. in 1415 and removed here in 1431.

BRENTON, SIR JAHLEEL (1770-1844), British admiral, was born in Rhode Island, U.S.A., on the 22nd of August 1770. He was the son of Rear-Admiral Jahleel Brenton (1729-1802), who belonged to a loyalist family which suffered the loss of most of its property in the insurrection of the American colonies. He was a lieutenant in the British navy when the war began, and emigrated with his family to the mother country. Three of the sons entered the navy—Jahleel (the eldest), Captain Edward Pelham Brenton (1774-1839), and James Wallace Brenton, who was killed young in 1799 when attacking a Spanish privateer near Barcelona in the boats of the "Petrel," of which he was lieutenant. Jahleel went to sea first with his father in 1781, and on the return of peace was sent to the "maritime school" at Chelsea. He served in the peace before the beginning of the war in 1793, and passed his examination as lieutenant, but seeing no chance of employment went with other English naval officers to serve in the Swedish navy against the Russians. In 1790 he received his commission and returned home. Till 1799 he served as lieutenant, or acting commander, mostly under Earl St Vincent, and was present in the battle from which the admiral received his title. As commander of the "Speedy" brig he won much distinction in actions with Spanish gunboats in the Straits of Gibraltar. In 1800 he reached the rank of post-captain, and had the good fortune to serve as flag-captain to Sir James (afterwards Lord) Saumarez in the action at Algiers, and in the Straits in 1801. During the peace of Amiens he married Miss Stewart, a lady belonging to a loyalist family of Nova Scotia. After the renewal of the war he commanded a succession of frigates. In 1803 he had the misfortune to be wrecked on the coast of France, and remained for a time in prison, where his wife joined him. Having been exchanged he was named to another ship. His most brilliant action was fought with a flotilla of Franco-Neapolitan vessels outside of Naples in May 1801. He was severely wounded, and Murat, then king of Naples, praised him effusively. He was made a baronet in 1802 and K.C.B. in 1815. After his recovery from his wound he was unable to bear sea service, but was made commissioner of the dockyard at Port Mahon, and then at the Cape, and was afterwards lieutenant-governor of Greenwich hospital till 1840. He reached flag rank in 1830. In his later years he took an active part in philanthropic work, in association with his brother, Captain E. P. Brenton, who had seen much service but is best remembered by his writings on naval and military history,—*Naval History of Great Britain from the Year 1783 to 1822* (1823), and *The Life and Correspondence of John, Earl of St Vincent* (1838).

A Memoir of the Life and Services of Vice-Admiral Sir Jahleel Brenton, based on his own papers, was published in 1846 by the Rev. Henry Raikes, and reissued by the admiral's son, Sir L. C. L. Brenton, in 1855.

BRENTWOOD, a market town in the mid or Chelmsford parliamentary division of Essex, England; 18 m. E.N.E. of London by the Great Eastern railway (Brentwood and Worley station). Pop. of urban district (1901) 4932. The neighbouring country is pleasantly undulating and well wooded. The church of St Thomas the Martyr, with several chapels, is modern. The old assize house, an Elizabethan structure, remains. A free grammar school was founded in 1557. The county asylum is in the vicinity. There are breweries and brick works. To the south lies the fine upland of Worley Common, with large barracks. Adjoining Brentwood to the north-east is Shenfield, with the church of St Mary the Virgin, Early English and later. Brentwood was formerly an important posting station on the main

road to the eastern counties, which follows the line of the railway to Colchester. The name (*Burntwood*) is supposed to record an original settlement made in a clearing of the forest. The district is largely residential.

BRENZ, JOHANN (1490-1570), Lutheran divine, eldest son of Martin Brenz, was born at Weil, Württemberg, on the 24th of June 1499. In 1514 he entered the university of Heidelberg, where Oecolampadius was one of his teachers, and where in 1518 he heard Luther discuss. Ordained priest in 1520, and appointed preacher (1522) at Hall in Swabia, he gave himself to biblical exposition. He ceased to celebrate mass in 1523, and reorganized his church in 1524. Successful in resisting the peasant insurrection (1525), his fortunes were affected by the Schmalkaldic War. From Hall, when taken by the imperial forces, he fled on his birthday in 1548. Protected by Duke Ulrich of Württemberg, he was appointed (January 1553) provost of the collegiate church of Stuttgart. As organizer of the reformation in Württemberg he did much fruitful work. A strong advocate of Lutheran doctrine, and author of the *Syngramma Suenicum* (October 21, 1525), which set forth Luther's doctrine of the Eucharist, he was free from the persecuting tendencies of the age. He is praised and quoted (as Joannes Wittingius) for his judgment against applying the death penalty to anabaptists or other heretics in the *De Haereticis, an sint persequendi* (1554), issued by Sebastian Castellio under the pseudonym of Martinus Bellius. An incomplete edition of his works (largely expository) appeared at Tübingen, 1576-1590. Several of his sermons were reproduced in contemporary English versions. A volume of *Anecdota Brentiana* was edited by Pressel in 1868. He died on the 11th of September 1570, and was buried in his church at Stuttgart; his grave was subsequently violated. He was twice married, and his eldest son, Johann Brenz, was appointed (1562) professor of theology in Tübingen at the early age of twenty-two.

See Hartmann and Jäger, *Johann Brenz* (1840-1842); Bossert, in *Hauk's Realencyklop.* (1897). (A. G. O.)

BRÉQUIGNY, LOUIS GEORGES OUDARD FEUDRIX DE (1714-1795), French scholar, was born at Gainneville near Havre, on the 22nd of February 1714, and died at Paris on the 3rd of July 1795. His first publications were anonymous: an *Histoire des révolutions de Gènes jusqu'à la paix de 1748* (1750), and a series of *Vies des orateurs grecs* (1752). Elected a member of the Académie des Inscriptions et Belles-lettres in 1759, he contributed an *Histoire de Posthume empereur des Gaules* (vol. xxx., 1760) to the collected works of that illustrious society, and also a *Mémoire sur l'établissement de la religion et de l'empire de Mahomet* (vol. xxxii., 1761-1763). After the close of the Seven Years' War he was sent to search in the archives of England for documents bearing upon the history of France, more particularly upon that of the French provinces which once belonged to England. This mission (1764-1766) was very fruitful in results; Bréquigny brought back from it copies of about 7000 documents, which are now in the Bibliothèque Nationale. A useful selection of these documents was published (unfortunately without adequate critical treatment) by Jean Jacques Champollion-Figeac, under the title *Lettres de rois, reines et autres personnages des cours de France et d'Angleterre, depuis Louis VII. jusqu'à Henri IV., tirées des archives de Londres par Bréquigny* (collection of *Documents inédits relatifs à l'histoire de France*, 2 vols., 1839, 1847). Bréquigny himself drew the material for many important studies from the rich mine which he had thus exploited. These were included in the collection of the Académie des Inscriptions: *Mémoire sur les différends entre la France et l'Angleterre sous le règne de Charles le Bel* (vol. xli.); *Mémoire sur la vie de Marie, reine de France, sœur de Henri VIII., roi d'Angleterre* (vol. xlii.); *four Mémoires pour servir à l'histoire de Calais* (vols. xliii. and l.); and *Mémoire sur les négociations touchant les projets de mariage d'Elizabeth, reine d'Angleterre, d'abord avec le duc d'Anjou, ensuite avec le duc d'Alençon, tous deux frères de Charles IX.* (vol. l.). This last was read to the Academy on the 22nd of January 1793, the morrow of Louis XVI.'s execution. Meanwhile, Bréquigny had taken part in three great and erudite works. For the *Recueil des ordonnances des rois de France* he had prepared

volumes x-xiv., the preface to vol. xi. containing important researches into the French communes. To the *Table chronologique des diplômes, chartes, lettres, et actes imprimés concernant l'histoire de France* he contributed three volumes in collaboration with Mouchet (1769-1783). Charged with the supervision of a large collection of documents bearing on French history, analogous to Rymer's *Fœdera*, he published the first volume (*Diplomat. Chartæ, &c.*, 1791). The Revolution interrupted him in his collection of *Mémoires concernant l'histoire, les sciences, les lettres, et les arts des Chinois*, begun in 1776 at the instance of the minister Bertin, when fifteen volumes had appeared.

See the note on Bréquigny at the end of vol. i. of the *Mémoires de l'Académie des Inscriptions* (1808); the Introduction to vol. iv. of the *Table chronologique des diplômes* (1836); Champollion-Figeac's preface to the *Lettres des rois et reines; le Comité des travaux historiques*, by X. Chartes, vol. i. *passim*; N. Oursel, *Nouvelle biographie normande* (1886); and the *Catalogue des manuscrits des collections Duchesne et Bréquigny* (in the Bibliothèque Nationale), by René Poupardin (1905). (C. B. *)

BRESCIA (anc. *Brixia*), a city and episcopal see of Lombardy, Italy, the capital of the province of Brescia, finely situated at the foot of the Alps, 52 m. E. of Milan and 40 m. W. of Verona by rail. Pop. (1901) town, 42,495; commune, 72,731. The plan of the city is rectangular, and the streets intersect at right angles, a peculiarity handed down from Roman times, though the area enclosed by the medieval walls is larger than that of the Roman town, which occupied the eastern portion of the present one. The Piazza del Museo marks the site of the forum, and the museum on its north side is ensconced in a Corinthian temple with three *cellæ*, by some attributed to Hercules, but more probably the Capitolium of the city, erected by Vespasian in A.D. 73 (if the inscription really belongs to the building; cf. Th. Mommsen in *Corp. Inscr. Lat.* v. No. 4312, Berlin, 1872), and excavated in 1823. It contains a famous bronze statue of Victory, found in 1826. Scanty remains of a building on the south side of the forum, called the *curia*, but which may be a basilica, and of the theatre, on the east of the temple, still exist.

Brescia contains many interesting medieval buildings. The castle, at the north-east angle of the town, commands a fine view. It is now a military prison. The old cathedral is a round domed structure of the 10th (?) century erected over an early Christian basilica, which has forty-two ancient columns; and the Broletto, adjoining the new cathedral (a building of 1604) on the north, is a massive building of the 12th and 13th centuries (the original town hall, now the prefecture and law courts), with a lofty tower. There are also remains of the convent of S. Salvatore, founded by Desiderius, king of Lombardy, including three churches, two of which now contain the fine medieval museum, which possesses good ivories. The church of S. Francesco has a Gothic façade and cloisters. There are also some good Renaissance palaces and other buildings, including the Municipio, begun in 1492 and completed by Jacopo Sansovino in 1554-1574. This is a magnificent structure, with fine ornamentation. The church of S. Maria dei Miracoli (1488-1523) is also noteworthy for its general effect and for the richness of its details, especially of the reliefs on the façade. Many other churches, and the picture gallery (Galleria Martinengo), contain fine works of the painters of the Brescian school, Alessandro Bonvicino (generally known as Moretto), Girolamo Romanino and Moretto's pupil, Giovanni Battista Moroni. The Biblioteca Queriniana contains early MSS., a 14th-century MS. of Dante, &c., and some rare incunabula. The city is well supplied with water, and has no less than seventy-two public fountains. Brescia has considerable factories of iron ware, particularly fire-arms and weapons (one of the government small arms factories being situated here), also of woollens, linens and silks, matches, candles, &c. The stone quarries of Mazzano, 8 m. east of Brescia, supplied material for the monument to Victor Emmanuel II. and other buildings in Rome. Brescia is situated on the main railway line between Milan and Verona, and has branch railways to Isco, Parma, Cremona and (via Rovato) to Bergamo, and steam tramways to Mantua, Soncino, Ponte Toscolano and Cardone Valtrompia.

The ancient Celtic Brixia, a town of the Cenomani, became Roman in 225 B.C., when the Cenomani submitted to Rome. Augustus founded a civil (not a military) colony here in 27 B.C., and he and Tiberius constructed an aqueduct to supply it. In 452 it was plundered by Attila, but was the seat of a duchy in the Lombard period. From 1167 it was one of the most active members of the Lombard League. In 1258 it fell into the hands of Eccelino of Verona, and belonged to the Scaligers (della Scala) until 1421, when it came under the Visconti of Milan, and in 1426 under Venice. Early in the 16th century it was one of the wealthiest cities of Lombardy, but has never recovered from its sack by the French under Gaston de Foix in 1512. It belonged to Venice until 1797, when it came under Austrian dominion; it revolted in 1848, and again in 1849, being the only Lombard town to rally to Charles Albert in the latter year, but was taken after ten days' obstinate street fighting by the Austrians under Haynau.

See *Museo Bresciano Illustrato* (Brescia, 1838). (T. As.)

BRESLAU (Polish *Wrocław*), a city of Germany, capital of the Prussian province of Silesia, and an episcopal see, situated in a wide and fertile plain on both banks of the navigable Oder, 350 m. from its mouth, at the influx of the Ohle, and 202 m. from Berlin on the railway to Vienna. Pop. (1867) 171,926; (1880) 272,912; (1885) 299,640; (1890) 335,186; (1905) 470,751, about 60% being Protestants, 35% Roman Catholics and nearly 5% Jews. The Oder, which here breaks into several arms, divides the city into two unequal halves, crossed by numerous bridges. The larger portion, on the left bank, includes the old or inner town, surrounded by beautiful promenades, on the site of the ramparts, dismantled after 1813, from an eminence within which, the Liebhöhe, a fine view is obtained of the surrounding country. Outside, as well as across the Oder, lies the new town with extensive suburbs, containing, especially in the Schweidnitz quarter in the south, and the Oder quarter in the north, many handsome streets and spacious squares. The inner town, in contrast to the suburbs, still retains with its narrow streets much of its ancient characters, and contains several medieval buildings, both religious and secular, of great beauty and interest. The cathedral, dedicated to St John the Baptist, was begun in 1148 and completed at the close of the 15th century, enlarged in the 17th and 18th centuries, and restored between 1873 and 1875; it is rich in notable treasures, especially the high altar of beaten silver, and in beautiful paintings and sculptures. The Kreuzkirche (church of the Holy Cross), dating from the 13th and 14th centuries, is an interesting brick building, remarkable for its stained glass and its historical monuments, among which is the tomb of Henry IV., duke of Silesia. The Sandkirche, so called from its dedication to Our Lady on the Sand, dates from the 14th century, and was until 1810 the church of the Augustinian canons. The Dorothea- or Minoritenkirche, remarkable for its high-pitched roof, was founded by the emperor Charles IV. in 1351. These are the most notable of the Roman Catholic churches. Of the Evangelical churches the most important is that of St Elizabeth, founded about 1250, rebuilt in the 14th and 15th centuries, and restored in 1857. Its lofty tower contains the largest bell in Silesia, and the church possesses a celebrated organ, fine stained glass, a magnificent stone pyx (erected in 1455) over 52 ft. high, and portraits of Luther and Melancthon by Lucas Cranach. The church of St Mary Magdalen, built in the 14th century on the model of the cathedral, has two lofty Gothic towers connected by a bridge, and is interesting as having been the church in which, in 1523, the reformation in Silesia was first proclaimed. Other noteworthy ecclesiastical buildings are the graceful Gothic church of St Michael built in 1871, the bishop's palace and the Jewish synagogue, the finest in Germany after that in Berlin.

The business streets of the city converge upon the Ring, the market square, in which is the town-hall, a fine Gothic building, begun in the middle of the 14th and completed in the 16th century. Within is the Fürstensaal, in which the diets of Silesia were formerly held, while beneath is the famous Schweidnitzer Keller, used continuously since 1355 as a beer and wine house.

The university, a spacious Gothic building facing the Oder, is a striking edifice. It was built (1728-1736) as a college by the Jesuits, on the site of the former imperial castle presented to them by the emperor Leopold I., and contains a magnificent hall (Aula Leopoldina), richly ornamented with frescoes and capable of holding 1200 persons. Breslau possesses a large number of other important public buildings: the Stadthaus (civic hall), the royal palace, the government offices (a handsome pile erected in 1887), the provincial House of Assembly, the municipal archives, the courts of law, the Silesian museum of arts and crafts and antiquities, stored in the former assembly hall of the estates (Ständehaus), which was rebuilt for the purpose, the museum of fine arts, the exchange, the Stadt and Lobe theatres, the post office and central railway station. There are also numerous hospitals and schools. Breslau is exceedingly rich in fine monuments; the most noteworthy being the equestrian statues of Frederick the Great and Frederick William III., both by Kiss; the statue of Blücher by Rauch; a marble statue of General Tauentzien by Langhans and Schadow; a bronze statue of Karl Gottlieb Svarez (1746-1798), the Prussian jurist, a monument to Schlieiermacher, born here in 1768, and statues of the emperor William I., Bismarck and Moltke. There are also several handsome fountains. Foremost among the educational establishments stands the university, founded in 1702 by the emperor Leopold I. as a Jesuit college, and greatly extended by the incorporation of the university of Frankfort-on-Oder in 1811. Its library contains 306,000 volumes and 4000 MSS., and has in the so-called *Bibliotheca Habichtiana* a valuable collection of oriental literature. Among its auxiliary establishments are botanical gardens, an observatory, and anatomical, physiological and kindred institutions. There are eight classical and four modern schools, two higher girls' schools, a Roman Catholic normal school, a Jewish theological seminary, a school of arts and crafts, and numerous literary and charitable foundations. It is, however, as a commercial and industrial city that Breslau is most widely known. Its situation, close to the extensive coal and iron fields of Upper Silesia, in proximity to the Austrian and Russian frontiers, at the centre of a network of railways directly communicating both with these countries and with the chief towns of northern and central Germany, and on a deep waterway connecting with the Elbe and the Vistula, facilitates its very considerable transit and export trade in the products of the province and of the neighbouring countries. These embrace coal, sugar, cereals, spirits, petroleum and timber. The local industries comprise machinery and tools, railway and tramway carriages, furniture, cast-iron goods, gold and silver work, carpets, furs, cloth and cottons, paper, musical instruments, glass and china. Breslau is the headquarters of the VI. German army corps and contains a large garrison of troops of all arms.

History.—Breslau (Lat. *Vratislavia*) is first mentioned by the chronicler Thietmar, bishop of Merseburg, in A.D. 1000, and was probably founded some years before this date. Early in the 11th century it was made the seat of a bishop, and after having formed part of Poland, became the capital of an independent duchy in 1163. Destroyed by the Mongols in 1241, it soon recovered its former prosperity and received a large influx of German colonists. The bishop obtained the title of a prince of the Empire in 1290.¹ When Henry VI., the last duke of Breslau, died in 1335, the city came by purchase to John, king of Bohemia, whose successors retained it until about 1460. The Bohemian kings bestowed various privileges on Breslau, which soon began to extend its commerce in all directions, while owing to increasing wealth the citizens took up a more independent attitude. Disliking the Hussites, Breslau placed itself under the protection of Pope Pius II. in 1463, and a few years afterwards came under the rule of the Hungarian king, Matthias Corvinus. After his death in 1490 it again became subject to Bohemia, passing with the rest

of Silesia to the Habsburgs when in 1526 Ferdinand, afterwards emperor, was chosen king of Bohemia. Having passed almost undisturbed through the periods of the Reformation and the Thirty Years' War, Breslau was compelled to own the authority of Frederick the Great in 1741. It was, however, recovered by the Austrians in 1757, but was regained by Frederick after his victory at Leuthen in the same year, and has since belonged to Prussia, although it was held for a few days by the French in 1807 after the battle of Jena, and again in 1813 after the battle of Bautzen. The sites of the fortifications, dismantled by the French in 1807, were given to the civic authorities by King Frederick William III., and converted into promenades. In March 1813 this monarch issued from Breslau his stirring appeals to the Prussians, *An mein Volk* and *An mein Kriegsheer*, and the city was the centre of the Prussian preparations for the campaign which ended at Leipzig. After the Prussian victory at Sadowa in 1866, William I. made a triumphant and complimentary entry into the city, which since the days of Frederick the Great has been only less loyal to the royal house than Berlin itself.

See Bürkner and Stein, *Geschichte der Stadt Breslau* (Bresl. 1851-1853); J. Stein, *Geschichte der Stadt Breslau im 19ten Jahrhundert* (1884); O. Frenzel, *Breslauer Stadtbuch* ("Codex dipl. Silesiac," vol. ii. 1882); Luchs, *Breslau, ein Führer durch die Stadt* (12th ed., Bresl. 1904).

BRESSANT, JEAN BAPTISTE PROSPER (1815-1886), French actor, was born at Chalon-sur-Saône on the 23rd of October 1815, and began his stage career at the Variétés in Paris in 1833. In 1838 he went to the French theatre at St Petersburg, where for eight years he played important parts with ever-increasing reputation. His success was confirmed at the Gymnase when he returned to Paris in 1846, and he made his *début* at the Comédie Française as a full-fledged *sociétaire* in 1854. From playing the ardent young lover, he turned to leading rôles both in modern plays and in the classical repertoire. His Richeieu in *Mlle de Belle-Isle*, his Octave in Alfred de Musset's *Les Caprices de Marianne*, and his appearance in de Musset's *Il faut qu'une porte soit ouverte ou fermée* and *Un caprice* were followed by *Tartuffe*, *Le Misanthrope* and *Don Juan*. Bressant retired in 1875, and died on the 23rd of January 1886. During his professorship at the Conservatoire, Mounet-Sully was one of his pupils.

BRESSE, a district of eastern France embracing portions of the departments of Ain, Saône-et-Loire and Jura. The Bresse extends from the Dombes on the south to the river Doubs on the north, and from the Saône eastwards to the Jura, measuring some 60 m. in the former, and 20 m. in the latter direction. It is a plain varying from 600 to 800 ft. above the sea, with few eminences and a slight inclination westwards. Heath and coppice alternate with pastures and arable land; pools and marshes are numerous, especially in the north. Its chief rivers are the Veyle, the Keyssouze and the Scille, all tributaries of the Saône. The soil is a gravelly clay but moderately fertile, and cattle-raising is largely carried on. The region is, however, more especially celebrated for its table poultry. The inhabitants preserve a distinctive but almost obsolete costume, with a curious head-dress. The Bresse proper, called the *Bresse Bressane*, comprises the northern portion of the department of Ain. The greater part of the district belonged in the middle ages to the lords of Bâgé, from whom it passed in 1272 to the house of Savoy. It was not till the first half of the 15th century that the province, with Bourg as its capital, was founded as such. In 1601 it was ceded to France by the treaty of Lyons, after which it formed (together with the province of Bugey) first a separate government and afterwards part of the government of Burgundy.

BRESSUIRE, a town of western France, capital of an arrondissement in the department of Deux-Sèvres, 48 m. N. of Niort by rail. Pop. (1906) 4561. The town is situated on an eminence overlooking the Dolo, a tributary of the Argenton. It is the centre of a cattle-rearing and agricultural region, and has important markets; the manufacture of wooden type and woollen goods is carried on. Bressuire has two buildings of interest: the church of Notre-Dame, which, dating chiefly from the 12th and 15th centuries, has an imposing tower of the Renaissance period; and the castle, built by the lords of

¹ In 1195 Jaroslaw, son of Boleslaus I. of Lower Silesia, who became bishop of Breslau in 1198, inherited the duchy of Neisse, which at his death (1201) he bequeathed to his successors in the sec. The Austrian part of Neisse still belongs to the bishop of Breslau, who also still bears the title of prince bishop.

Beaumont, vassals of the viscount of Thouars. The latter is now in ruins, and a portion of the site is occupied by a modern château, but an inner and outer line of fortifications are still to be seen. The whole forms the finest assemblage of feudal ruins in Poitou. Bressuire is the seat of a sub-prefect and has a tribunal of first instance. Among the disasters suffered at various times by the town, its capture from the English and subsequent pillage by French troops under du Guesclin in 1370 is the most memorable.

BREST, a fortified seaport of western France, capital of an arrondissement in the department of Finistère, 155 m. W.N.W. of Rennes by rail. Population (1906) town, 71,163; commune, 85,294. It is situated to the north of a magnificent land-locked bay, and occupies the slopes of two hills divided by the river Penfeld,—the part of the town on the left bank being regarded as Brest proper, while the part on the right is known as Recouvrance. There are also extensive suburbs to the east of the town. The hill-sides are in some places so steep that the ascent from the lower to the upper town has to be effected by flights of steps and the second or third storey of one house is often on a level with the ground storey of the next. The chief street of Brest bears the name of rue de Siam, in honour of the Siamese embassy sent to Louis XIV., and terminates at the remarkable swing-bridge, constructed in 1861, which crosses the mouth of the Penfeld. Running along the shore to the south of the town is the Cours d'Ajot, one of the finest promenades of its kind in France, named after the engineer who constructed it. It is planted with trees and adorned with marble statues of Neptune and Abundance by Antoine Coysevox. The castle with its donjon and seven towers (12th to the 16th centuries), commanding the entrance to the river, is the only interesting building in the town. Brest is the capital of one of the five naval arrondissements of France. The naval port, which is in great part excavated in the rock, extends along both banks of the Penfeld; it comprises gun-foundries and workshops, magazines, ship-building yards and repairing docks, and employs about 7000 workmen. There are also large naval barracks, training ships and naval schools of various kinds, and an important naval hospital. Brest is the seat of a sub-prefect and has tribunals of first instance and of commerce, a chamber of commerce, a board of trade-arbitrators, two naval tribunals, and a tribunal of maritime commerce. There are also lycées for boys and girls and a school of commerce and industry. The commercial port, which is separated from the town itself by the Cours d'Ajot, comprises a tidal port with docks and an outer harbour; it is protected by jetties to the east and west and by a breakwater on the south. In 1905 the number of vessels entered was 202 with a tonnage of 67,755, and cleared 160 with a tonnage of 61,012. The total value of the imports in 1905 was £244,000. The chief were wine, coal, timber, mineral tar, fertilizers and lobsters and crayfish. Exports, of which the chief were wheat-flour, fruit and superphosphates, were valued at £40,000. Besides its sardine and mackerel fishing industry, the town has flour-mills, breweries, foundries, forges, engineering works, and manufactures of blocks, candles, chemicals (from sea-weed), boots, shoes and linen. Brest communicates by submarine cable with America and French West Africa. The roadstead consists of a deep indentation with a maximum length of 14 m. and an average width of 4 m., the mouth being barred by the peninsula of Quéléren, leaving a passage from 1 to 2 m. broad, known as the Goulet. The outline of the bay is broken by numerous smaller bays or arms, formed by the embouchures of streams, the most important being the Anse de Quéléren, the Anse de Poulmic, and the mouths of the Châteaulin and the Landerneau. Brest is a fortress of the first class. The fortifications of the town and the harbour fall into four groups: (1) the very numerous forts and batteries guarding the approaches to and the channel of the Goulet; (2) the batteries and forts directed upon the roads; (3) a group of works preventing access to the peninsula of Quéléren and commanding the ground to the south of the peninsula from which many of the works of group (2) could be taken in reverse; (4) the defences of Brest itself, consisting of an old-fashioned

enceinte possessing little military value and a chain of detached forts to the west of the town.

Nothing definite is known of Brest till about 1240, when it was ceded by a count of Léon to John I., duke of Brittany. In 1342 John of Montfort gave it up to the English, and it did not finally leave their hands till 1397. Its mediæval importance was great enough to give rise to the saying, "He is not duke of Brittany who is not lord of Brest." By the marriage of Francis I. with Claude, daughter of Anne of Brittany, Brest with the rest of the duchy definitely passed to the French crown. The advantages of the situation for a seaport town were first recognized by Richelieu, who in 1631 constructed a harbour with wooden wharves, which soon became a station of the French navy. Colbert changed the wooden wharves for masonry and otherwise improved the port, and Vauban's fortifications followed in 1680-1688. During the 18th century the fortifications and the naval importance of the town continued to develop. In 1694 an English squadron under John, 3rd Lord Berkeley, was miserably defeated in attempting a landing; but in 1794, during the revolutionary war, the French fleet, under Villaret de Joyeuse, was as thoroughly beaten in the same place by the English admiral Howe.

BREST-LITOVSK (Polish *Breść-Litewski*; and in the Choc. *Beresie* and *Bereslow*), a strongly fortified town of Russia, in the government of Grodno, 137 m. by rail S. from the city of Grodno, in 52° 5' N. lat. and 23° 30' E. long., at the junction of the navigable river Mukhovets with the Bug, and at the intersection of railways from Warsaw, Kiev, Moscow and East Prussia. Pop. (1867) 22,493; (1901) 42,812, of whom more than one-half were Jews. It contains a Jewish synagogue, which was regarded in the 16th century as the first in Europe, and is the seat of an Armenian and of a Greek Catholic bishop; the former has authority over the Armenians throughout the whole country. The town carries on an extensive trade in grain, flax, hemp, wood, tar and leather. First mentioned in the beginning of the 11th century, Brest-Litovsk was in 1241 laid waste by the Mongols and was not rebuilt till 1275; its suburbs were burned by the Teutonic Knights in 1379; and in the end of the 15th century the whole town met a similar fate at the hands of the khan of the Crimea. In the reign of the Polish king Sigismund III. diets were held there; and in 1594 and 1596 it was the meeting-place of two remarkable councils of the bishops of western Russia. In 1657, and again in 1706, the town was captured by the Swedes; in 1794 it was the scene of Savaarov's victory over the Polish general Sierakowski; in 1795 it was added to the Russian empire. The Brest-Litovsk or King's canal (50 m. long), utilizing the Mukhovets-Bug rivers, forms a link in the waterways that connect the Dnieper with the Vistula.

BRETEUIL, LOUIS CHARLES AUGUSTE LE TONNELIER, BARON DE (1730-1807), French diplomatist, was born at the château of Azay-le-Féron (Indre) on the 7th of March 1730. He was only twenty-eight when he was appointed by Louis XV. ambassador to the elector of Cologne, and two years later he was sent to St Petersburg. He arranged to be temporarily absent from his post at the time of the palace revolution by which Catherine II. was placed on the throne. In 1766 he was sent to Stockholm, and subsequently represented his government at Vienna, Naples, and again at Vienna until 1783, when he was recalled to become minister of the king's household. In this capacity he introduced considerable reforms in prison administration. A close friend of Marie Antoinette, he presently came into collision with Calonne, who demanded his dismissal in 1787. His influence with the king and queen, especially with the latter, remained unshaken, and on Necker's dismissal on the 11th of July 1789, Breteuil succeeded him as chief minister. The fall of the Bastille three days later put an end to the new ministry, and Breteuil made his way to Switzerland with the first party of *émigrés*. At Solcure, in November 1790, he received from Louis XVI. exclusive powers to negotiate with the European courts, and in his efforts to check the ill-advised diplomacy of the *émigré* princes, he soon brought himself into opposition with the old rival Calonne, who held a chief place in their council.

After the failure of the flight to Varennes, in the arrangement of which he had a share, Breteuil received instructions from Louis XVI., designed to restore amicable relations with the princes. His distrust of the king's brothers and his defence of Louis XVI.'s prerogative were to some extent justified, but his intransigent attitude towards these princes emphasized the dissensions of the royal family in the eyes of foreign sovereigns, who looked on the comte de Provence as the natural representative of his brother and found a pretext for non-interference on Louis's behalf in the contradictory statements of the negotiators. Breteuil himself was the object of violent attacks from the party of the princes, who asserted that he persisted in exercising powers which had been revoked by Louis XVI. After the execution of Marie Antoinette he retired into private life near Hamburg, only returning to France in 1802. He died in Paris on the 2nd of November 1807.

See the memoirs of Bertrand de Molleville (2 vols., Paris, 1816) and of the marquis de Bouillé (2 vols., Paris, 1884); and E. DauDET, *Coblenz, 1789-1793* (1889), forming part of his *Hist. de l'émigration*.

BRÉTIGNY, a French town (dept. Eure-et-Loir, arrondissement and canton of Chartres, commune of Sour), which gave its name to a celebrated treaty concluded there on the 8th of May 1360, between Edward III. of England and John II., surnamed the Good, of France. The exactions of the English, who wished to yield as few as possible of the advantages claimed by them in the treaty of London, made negotiations difficult, and the discussion of terms begun early in April lasted more than a month. By virtue of this treaty Edward III. obtained, besides Guienne and Gascony, Poitou, Saintonge and Aunis, Agenais, Périgord, Limousin, Quercy, Bigorre, the countship of Gaure, Angoumois, Rouergue, Montreuil-sur-mer, Ponthieu, Calais, Sangatte, Ham and the countship of Guines. John II. had, moreover, to pay three millions of gold crowns for his ransom. On his side the king of England gave up the duchies of Normandy and Touraine, the countships of Anjou and Maine, and the suzerainty of Brittany and of Flanders. As a guarantee for the payment of his ransom, John the Good gave as hostages two of his sons, several princes and nobles, four inhabitants of Paris, and two citizens from each of the nineteen principal towns of France. This treaty was ratified and sworn to by the two kings and by their eldest sons on the 24th of October 1360, at Calais. At the same time were signed the special conditions relating to each important article of the treaty, and the renunciations in which the kings abandoned their rights over the territory they had yielded to one another.

See Rymer's *Fœderas*, vol. iii.; Dumont, *Corps diplomatique*, vol. ii.; Froissart, ed. Luce, vol. vi.; *Les Grandes Chroniques de France*, ed. P. Paris, vol. vi.; E. CoNSEAU, *Les Grands Traités de la guerre de cent ans* (1889).

BRETON, JULES ADOLPHE AIMÉ LOUIS (1827-), French painter, was born on the 1st of May 1827, at Courrières, Pas de Calais, France. His artistic gifts being manifest at an early age, he was sent in 1843 to Ghent, to study under the historical painter de Vigne, and in 1846 to Baron Wappers at Antwerp. Finally he worked in Paris under Drolling. His first efforts were in historical subjects: "Saint Piat preaching in Gaul"; then, under the influence of the revolution of 1848, he represented "Misery and Despair." But Breton soon discovered that he was not born to be a historical painter, and he returned to the memories of nature and of the country which were impressed on him in early youth. In 1853 he exhibited the "Return of the Harvesters" at the Paris Salon, and the "Little Gleaner" at Brussels. Thenceforward he was essentially a painter of rustic life, especially in the province of Artois, which he quitted only three times for short excursions: in 1864 to Provence, and in 1865 and 1873 to Brittany, whence he derived some of his happiest studies of religious scenes. His numerous subjects may be divided generally into four classes: labour, rest, rural festivals and religious festivals. Among his more important works may be named "Women Gleaning," and "The Day after St Sebastian's Day" (1855), which gained him a third-class medal; "Blessing the Fields" (1857), a second-class medal; "Erecting a Calvary" (1859), now in the Lille gallery;

"The Return of the Gleaners" (1859), now in the Luxembourg; "Evening" and "Women Weeding" (1861), a first-class medal; "Grandfather's Birthday" (1862); "The Close of Day" (1865); "Harvest" (1867); "Potato Gatherers" (1868); "A Pardon, Brittany" (1869); "The Fountain" (1872), medal of honour; "The Bonfires of St John" (1873); "Women mending Nets" (1876), in the Douai museum; "A Gleaner" (1877), Luxembourg; "Evening, Finistère" (1881); "The Song of the Lark" (1884); "The Last Sunbeam" (1885); "The Shepherd's Star" (1888); "The Call Home" (1889); "The Last Gleanings" (1895); "Gathering Poppies" (1897); "The Alarm Cry" (1899); "Twilight Glory" (1900). Breton was elected to the Institut in 1886 on the death of Baudry. In 1889 he was made commander of the Legion of Honour, and in 1899 foreign member of the Royal Academy of London. He also wrote several books, among them *Les Champs et la mer* (1876), *Nos peintres du siècle* (1900), "Jeanne," a poem, *Delphine Bernard* (1902), and *La Peinture* (1904).

See Jules Breton, *Vie d'un artiste, art et nature* (autobiographical), (Paris, 1890); Marius VACHON, *Jules Breton* (1899).

BRETON, BRITTON or BRITTAINE, NICHOLAS (1545?-1626), English poet, belonged to an old family settled at Layer-Breton, Essex. His father, William Breton, who had made a considerable fortune by trade, died in 1559, and the widow (*née* Elizabeth Bacon) married the poet George Gascoigne before her sons had attained their majority. Nicholas Breton was probably born at the "capitall mansion house" in Red Cross Street, in the parish of St Giles without Cripplegate, mentioned in his father's will. There is no official record of his residence at the university, but the diary of the Rev. Richard Madox tells us that he was at Antwerp in 1583 and was "once of Oriel College." He married Ann Sutton in 1593, and had a family. He is supposed to have died shortly after the publication of his last work, *Fantasticks* (1626). Breton found a patron in Mary, countess of Pembroke, and wrote much in her honour until 1601, when she seems to have withdrawn her favour. It is probably safe to supplement the meagre record of his life by accepting as autobiographical some of the letters signed N.B. in *A Poete with a Packet of Mad Letters* (1603, enlarged 1637); the 19th letter of the second part contains a general complaint of many griefs, and proceeds as follows: "hath another been wounded in the warres, fared hard, lain in a cold bed many a bitter storme, and benee at many a hard banquet? all these have I; another imprisoned? so have I; another long been sicke? so have I; another plagued with an unquiet life? so have I; another indebted to his hearts grieffe, and faine would pay and cannot? so am I." Breton was a facile writer, popular with his contemporaries, and forgotten by the next generation. His work consists of religious and pastoral poems, satires, and a number of miscellaneous prose tracts. His religious poems are sometimes wearisome by their excess of fluency and sweetness, but they are evidently the expression of a devout and earnest mind. His praise of the Virgin and his references to Mary Magdalene have suggested that he was a Catholic, but his prose writings abundantly prove that he was an ardent Protestant. Breton had little gift for satire, and his best work is to be found in his pastoral poetry. His *Passionate Shepherd* (1604) is full of sunshine and fresh air, and of unaffected gaiety. The third pastoral in this book—"Who can live in heart so glad As the merrie country lad"—is well known; with some other of Breton's daintiest poems, among them the lullaby, "Come little babe, come silly soule,"—it is incorporated in A. H. Bullen's *Lyrics from Elizabethan Romances* (1890). His keen observation of country life appears also in his prose idyll, *Wits Trenchmow*, "a conference betwixt a scholler and an angler," and in his *Fantasticks*, a series of short prose pictures of the months, the Christian festivals and the hours, which throw much light on the customs of the times. Most of Breton's books are very rare and have great bibliographical value. His works, with the exception of some belonging to private owners, were collected by Dr A. B. Grosart in the

¹ This poem, however, comes from *The Arbor of Amorous Devices*, which is only in part Breton's work.

Chertsey Worthies Library in 1879, with an elaborate introduction quoting the documents for the poet's history.

Bretón's poetical works, the titles of which are here somewhat abbreviated, include *The Works of a Young Wit* (1577); *A Floorish upon Fancie* (1577); *The Pilgrimage to Paradise* (1592); *The Countess of Penbrook's Passion* (MS.), first printed by J. O. Halliwell Phillips in 1853; *Pasquil's Foles cappe*, entered at Stationers' Hall in 1600; *Pasquil's Mistresse* (1600); *Pasquil's Passe and Passeh* Not (1600); *Melancholike Humours* (1600); *Marie Magdalen's Love: a Solemne Passion of the Soules Love* (1595), the first part of which, a prose treatise, is probably by another hand; the second part, a poem in six-lined stanza, is certainly by Bretón; *A Divine Poem*, including "The Ravisht Soul" and "The Blessed Weeper" (1601); *An Excellent Poem, upon the Longing of a Blessed Heart* (1601); *The Soules Heavenly Exercise* (1601); *The Soules Harmony* (1602); *Olde Madcappe newe Gally mayfrey* (1602); *The Mother's Blessing* (1602); *A True Description of Unhankfulness* (1602); *The Passionate Shepheard* (1604); *The Soules Immortall Crowne* (1605); *The Honour of Valour* (1605); *An Inveective against Treason: I would and I would not* (1614); *Bryton's Boure of Delights* (1591), edited by Dr Grosart in 1893, an unauthorized publication which contained some poems disclaimed by Bretón; *The Arbor of Amorous Devises* (entered at Stationers' Hall, 1594), only in part Bretón's; and contributions to *England's Helicon* and other miscellanies of verse. Of his twenty-two prose tracts may be mentioned *Wit's Trenchmour* (1597); *The Wit of Wit* (1599); *A Poste with a Packet of Mad Letters* (1603). *Sir Philip Sidney's Ourania* by N. B. (1606), *Mary Magdalen's Lamentations* (1604), and *The Passion of a Discontented Mind* (1601), are sometimes, but erroneously, ascribed to Bretón.

BRETÓN DE LOS HERREROS, MANUEL (1796-1873), Spanish dramatist, was born at Quel (Logroño) on the 19th of December 1796 and was educated at Madrid. Enlisting on the 24th of May 1812, he served against the French in Valencia and Catalonia, and retired with the rank of corporal on the 8th of March 1822. He obtained a minor post in the civil service under the liberal government, and on his discharge determined to earn his living by writing for the stage. His first piece, *A la vejez viruelas*, was produced on the 14th of October 1824, and proved the writer to be the legitimate successor of the younger Moratin. His industry was astonishing; between October 1824 and November 1828, he composed thirty-nine plays, six of them original, the rest being translations or recasts of classic masterpieces. In 1831 he published a translation of Tibullus, and acquired by it an unmerited reputation for scholarship which secured for him an appointment as sub-librarian at the national library. But the theatre claimed him for its own, and with the exception of *Elena* and a few other pieces in the fashionable romantic vein, his plays were a long series of successes. His only serious check occurred in 1840; the former liberal had grown conservative with age, and in *La Ponchoda* he ridiculed the National Guard. He was dismissed from the national library, and for a short time was so unpopular that he seriously thought of emigrating to America; but the storm blew over, and within two years Bretón de los Herreros had regained his supremacy on the stage. He became secretary to the Spanish Academy, quarrelled with his fellow-members, and died at Madrid on the 8th of November 1873. He is the author of some three hundred and sixty original plays, twenty-three of which are in prose. No Spanish dramatist of the nineteenth century approaches him in comic power, in festive invention, and in the humorous presentation of character, while his metrical dexterity is unique. *Marcela o a cual de los tres?* (1831), *Muñete; y verás!* (1837) and *La Escuela del matrimonio* (1852) still hold the stage, and are likely to hold it so long as Spanish is spoken.

See Marqués de Molíns, *Bretón de los Herreros, recuerdos de su vida y de sus obras* (Madrid, 1883); *Obras de Bretón de Herreros* (5 vols., Madrid, 1883); E. Piñeyro, *El Romanticismo en España* (Paris, 1904).

BRETSCHNEIDER, KARL GOTTLIEB (1776-1848), German scholar and theologian, was born at Gersdorf in Saxony. In 1794 he entered the university of Leipzig, where he studied theology for four years. After some years of hesitation he resolved to be ordained, and in 1802 he passed with great distinction the examination for *candidatus theologie*, and attracted the regard of F. V. Reinhard, author of the *System der christlichen Moral* (1788-1815), then court-preacher at Dresden, who became his

warm friend and patron during the remainder of his life. In 1804-1806 Bretschneider was *Privat-docens* at the university of Wittenberg, where he lectured on philosophy and theology. During this time he wrote his work on the development of dogma, *Systematische Entwicklung aller in der Dogmatik vorkommenden Begriffe nach den symbolischen Schriften der evangelisch-lutherischen und reformirten Kirche* (1805, 4th ed. 1841), which was followed by others, including an edition of Ecclesiasticus with a Latin commentary. On the advance of the French army under Napoleon into Prussia, he determined to leave Wittenberg and abandon his university career. Through the good offices of Reinhard, he became pastor of Schneeberg in Saxony (1807). In 1808 he was promoted to the office of superintendent of the church of Annaberg, in which capacity he had to decide, in accordance with the canon law of Saxony, many matters belonging to the department of ecclesiastical law. But the climate did not agree with him, and his official duties interfered with his theological studies. With a view to a change he took the degree of doctor of theology in Wittenberg in August 1812. In 1816 he was appointed general superintendent at Gotha, where he remained until his death in 1848. This was the great period of his literary activity.

In 1820 was published his treatise on the gospel of St John, entitled *Probabilia de Evangelio et Epistolarum Joannis Apostoli indole et origine*, which attracted much attention. In it he collected with great fulness and discussed with marked moderation the arguments against Johannine authorship. This called forth a number of replies. To the astonishment of every one, Bretschneider announced in the preface to the second edition of his *Dogmatik* in 1822, that he had never doubted the authenticity of the gospel, and had published his *Probabilia* only to draw attention to the subject, and to call forth a more complete defence of its genuineness. Bretschneider remarks in his autobiography that the publication of this work had the effect of preventing his appointment as successor to Karl C. Tittmann in Dresden, the minister Detlev von Einsiedel (1773-1861) denouncing him as the "slanderer of John" (*Johannisschänder*). His greatest contribution to the science of exegesis was his *Lexicon Manuale Græco-Latinum in libros Novi Testamenti* (1824, 3rd ed. 1840). This work was valuable for the use which its author made of the Greek of the Septuagint, of the Old and New Testament Apocrypha, of Josephus, and of the apostolic fathers, in illustration of the language of the New Testament. In 1826 he published *Apologie der neuern Theologie des evangelischen Deutschlands*. Hugh James Rose had published in England (1825) a volume of sermons on the rationalist movement (*The State of the Protestant Religion in Germany*), in which he classed Bretschneider with the rationalists; and Bretschneider contended that he himself was not a rationalist in the ordinary sense of the term, but a "rational supernaturalist." Some of his numerous dogmatic writings passed through several editions. An English translation of his *Manual of the Religion and History of the Christian Church* appeared in 1857. His dogmatic position seems to be intermediate between the extreme school of naturalists, such as Heinrich Paulus, J. F. Röhr and Julius Wegscheider on the one hand, and D. F. Strauss and F. C. Baur on the other. Recognizing a supernatural element in the Bible, he nevertheless allowed to the full the critical exercise of reason in the interpretation of its dogmas (cp. Otto Pfeiderer, *Development of Theology*, pp. 89 ff.).

See his autobiography, *Aus meinem Leben: Selbstbiographie* von K. G. Bretschneider (Gotha, 1851), of which a translation, with notes, by Professor George E. Day, appeared in the *Bibliotheca Sacra and American Biblical Repository*, Nos. 36 and 38 (1852, 1853); Neudecker in *Die allgemeine Kirchengeschichte* (1848), No. 38; Wüstermann, *Bretschneider's Memoria* (1848); A. G. Farrar, *Critical History of Free Thought* (Bampton Lectures, 1862); Herzog-Hauck, *Realencyclopædie* (ed. 1897).

BRETEN, a town of Germany, in the grand duchy of Baden, on the Saalbach, 9 m. S.E. of Bruchsal by rail. Pop. (1900) 4781. It has some manufactories of machinery and japanned goods, and a considerable trade in timber and live stock. Bretten was the birthplace of Melancthon (1497), and in addition to a

statue of him by Drake, a memorial hall, containing a collection of his writings and busts and pictures of his famous contemporaries, has been erected.

BRETWALDA, a word used in the *Anglo-Saxon Chronicle* under the date 827, and also in a charter of Æthelstan, king of the English. It appears in several variant forms (*brytenwald*, *bretanwald*, &c.), and means most probably "lord of the Britons" or "lord of Britain"; for although the derivation of the word is uncertain, its earlier syllable seems to be cognate with the words Briton and Britannia. In the *Chronicle* the title is given to Egbert, king of the English, "the eighth king that was Bretwalda," and retrospectively to seven kings who ruled over one or other of the English kingdoms. The seven names are copied from Bede's *Historia Ecclesiastica*, and it is interesting to note that the last king named, Oswiu of Northumbria, lived 150 years before Egbert. It has been assumed that these seven kings exercised a certain superiority over a large part of England, but if such superiority existed it is certain that it was extremely vague and was unaccompanied by any unity of organization. Another theory is that Bretwalda refers to a war-leadership, or *imperium*, over the English south of the Humber, and has nothing to do with Britons or Britannia. In support of this explanation it is urged that the title is given in the *Chronicle* to Egbert in the year in which he "conquered the kingdom of the Mercians and all that was south of the Humber." Less likely is the theory of Palgrave that the Bretwaldas were the successors of the pseudo-emperors, Maximus and Carausius, and claimed to share the imperial dignity of Rome; or that of Kemble, who derives Bretwalda from the British word *bretlan*, to distribute, and translates it "widely ruling." With regard to Egbert the word is doubtless given as a title in imitation of its earlier use, and the same remark applies to its use in Æthelstan's charter.

See E. A. Freeman, *History of the Norman Conquest*, vol. i. (Oxford, 1877); W. Stubbs, *Constitutional History*, vol. i. (Oxford, 1897); J. R. Green, *The Making of England*, vol. ii. (London, 1897); F. Palgrave, *The Rise and Progress of the English Commonwealth* (London, 1832); J. M. Kemble, *The Saxons in England* (London, 1876); J. Rhys, *Celtic Britain* (London, 1884).

BREUGHEL (or **BRUEGHEL**), **PIETER**, Flemish painter, was the son of a peasant residing in the village of Breughel near Breda. After receiving instruction in painting from Koek, whose daughter he married, he spent some time in France and Italy, and then went to Antwerp, where he was elected into the Academy in 1551. He finally settled at Brussels and died there. The subjects of his pictures are chiefly humorous figures, like those of D. Teniers; and if he wants the delicate touch and silvery clearness of that master, he has abundant spirit and comic power. He is said to have died about the year 1570 at the age of sixty; other accounts give 1590 as the date of his death.

His son **PIETER**, the younger (1564-1637), known as "Hell" Breughel, was born in Brussels and died at Antwerp, where his "Christ bearing the Cross" is in the museum.

Another son **JAN** (c. 1569-1642), known as "Velvet" Breughel, was born at Brussels. He first applied himself to painting flowers and fruits, and afterwards acquired considerable reputation by his landscapes and sea-pieces. After residing long at Cologne he travelled into Italy, where his landscapes, adorned with small figures, were greatly admired. He left a large number of pictures, chiefly landscapes, which are executed with great skill. Rubens made use of Breughel's hand in the landscape part of several of his small pictures—such as his "Vertumnus and Pomona," the "Satyr viewing the Sleeping Nymph," and the "Terrestrial Paradise."

BREVET (a diminutive of the Fr. *bref*), a short writing, originally an official writing or letter, with the particular meaning of a papal indulgence. The use of the word is mainly confined to a commission, or official document, giving to an officer in the army a permanent, as opposed to a local and temporary, rank in the service higher than that he holds substantively in his corps. In the British army "brevet rank" exists only above the rank of captain, but in the United States army it is possible to obtain a brevet as first lieutenant. In France the term

brevet is particularly used with respect to the General Staff to express the equivalent of the English "passed Staff College" (p.s.c.).

BREVIARY (Lat. *breviarium*, abridgment, epitome), the book which contains the offices for the canonical hours, i.e. the daily service of the Roman Catholic Church. As compared with the Anglican Book of Common Prayer it is both more and less comprehensive; more, in that it includes lessons and hymns for every day in the year; less, because it excludes the Eucharistic office (contained in the Missal), and the special offices connected with baptism, marriage, burial, ordination, &c., which are found in the Ritual or the Pontifical. In the early days of Christian worship, when Jewish custom was followed, the Bible furnished all that was thought necessary, containing as it did the books from which the lessons were read and the psalms that were recited. The first step in the evolution of the Breviary was the separation of the Psalter into a choir-book. At first the president of the local church (bishop) or the leader of the choir chose a particular psalm as he thought appropriate. From about the 4th century certain psalms began to be grouped together, a process that was furthered by the monastic practice of daily reciting the 150 psalms. This took so much time that the monks began to spread it over a week, dividing each day into hours, and allotting to each hour its portion of the Psalter. St Benedict in the 6th century drew up such an arrangement, probably, though not certainly, on the basis of an older Roman division which, though not so skillful, is the one in general use. Gradually there were added to these psalter choir-books additions in the form of antiphons, responses, collects or short prayers, for the use of those not skillful at improvisation and metrical compositions. Jean Beleth, a 12th-century liturgical author, gives the following list of books necessary for the right conduct of the canonical office:—the *Antiphonarium*, the Old and New Testaments, the *Passionarius* (*liber*) and the *Legendarius* (dealing respectively with martyrs and saints), the *Homiliarius* (homilies on the Gospels), the *Sermologus* (collection of sermons) and the works of the Fathers, besides, of course, the *Psalterium* and the *Collectarium*. To overcome the inconvenience of using such a library the Breviary came into existence and use. Already in the 8th century Prudentius, bishop of Troyes, had in a *Breviarium Psalterii* made an abridgment of the Psalter for the laity, giving a few psalms for each day, and Alcuin had rendered a similar service by including a prayer for each day and some other prayers, but no lessons or homilies. The Breviary rightly so called, however, only dates from the 11th century; the earliest MS. containing the whole canonical office is of the year 1099 and is in the Mazarin library. Gregory VII. (pope 1073-1085), too, simplified the liturgy as performed at the Roman court, and gave his abridgment the name of Breviary, which thus came to denote a work which from another point of view might be called a Plenary, involving as it did the collection of several works into one. There are several extant specimens of 12th-century Breviaries, all Benedictine, but under Innocent III. (pope 1198-1216) their use was extended, especially by the newly founded and active Franciscan order. These preaching friars, with the authorization of Gregory IX., adopted (with some modifications, e.g. the substitution of the "Gallican" for the "Roman" version of the Psalter) the Breviary hitherto used exclusively by the Roman court, and with it gradually swept out of Europe all the earlier partial books (Legendaries, Responsories), &c., and to some extent the local Breviaries, like that of Sarum. Finally, Nicholas III. (pope 1277-1280) adopted this version both for the curia and for the basilicas of Rome, and thus made its position secure. The Benedictines and Dominicans have Breviaries of their own. The only other types that merit notice are:—(1) the Mozarabic Breviary, once in use throughout all Spain, but now confined to a single foundation at Toledo; it is remarkable for the number and length of its hymns, and for the fact that the majority of its collects are addressed to God the Son; (2) the Ambrosian, now confined to Milan, where it owes its retention to the attachment of the clergy and people to their traditional rites, which they derive from St Ambrose (see LITURGY).

Till the council of Trent every bishop had full power to regulate the Breviary of his own diocese; and this was acted upon almost everywhere. Each monastic community, also, had one of its own. Pius V. (pope 1566-1572), however, while sanctioning those which could show at least 200 years of existence, made the Roman obligatory in all other places. But the influence of the court of Rome has gradually gone much beyond this, and has superseded almost all the local "uses." The Roman has thus become nearly universal, with the allowance only of additional offices for saints specially venerated in each particular diocese. The Roman Breviary has undergone several revisions. The most remarkable of these is that by Francis Quignonez, cardinal of Santa Croce in Gerusalemme (1536), which, though not accepted by Rome,¹ formed the model for the still more thorough reform made in 1549 by the Church of England, whose daily morning and evening services are but a condensation and simplification of the Breviary offices. Some parts of the prefaces at the beginning of the English Prayer-Book are free translations of those of Quignonez. The Pian Breviary was again altered by Sixtus V. in 1588, who introduced the revised Vulgate text; by Clement VIII. in 1602 (through Baronius and Bellarmine), especially as concerns the rubrics; and by Urban VIII. (1623-1644), a purist who unfortunately tampered with the text of the hymns, injuring both their literary charm and their historic worth.

In the 17th and 18th centuries a movement of revision took place in France, and succeeded in modifying about half the Breviaries of that country. Historically, this proceeded from the labours of Jean de Launo (1603-1678), "le dénicheur des saints," and Louis Sébastien le Nain de Tillemont, who had shown the falsity of numerous lives of the saints; while theologically it was produced by the Port Royal school, which led men to dwell more on communion with God as contrasted with the invocation of the saints. This was mainly carried out by the adoption of a rule that all antiphons and responses should be in the exact words of Scripture, which, of course, cut out the whole class of appeals to created beings. The services were at the same time simplified and shortened, and the use of the whole Psalter every week (which had become a mere theory in the Roman Breviary, owing to its frequent supersession by saints' day services) was made a reality. These reformed French Breviaries—e.g. the Paris Breviary of 1680 by Archbishop François de Harlay (1625-1695) and that of 1736 by Archbishop Charles Gaspard Guillaume de Vintimille (1655-1746)—show a deep knowledge of Holy Scripture, and much careful adaptation of different texts; but during the pontificate of Pius IX. a strong Ultramontane movement arose against them. This was inaugurated by Montalembert, but its literary advocates were chiefly Dom Gueranger, a learned Benedictine monk, abbot of Solesmes, and Louis François Vuillot (1813-1883) of the *Usagers*; and it succeeded in suppressing them everywhere, the last diocese to surrender being Orleans in 1875. The Jansenist and Gallican influence was also strongly felt in Italy and in Germany, where Breviaries based on the French models were published at Cologne, Münster, Mainz and other towns. Meanwhile, under the direction of Benedict XIV. (pope 1740-1758), a special congregation collected many materials for an official revision, but nothing was published. Subsequent changes have been very few and minute. In 1902, under Leo XIII., a commission under the presidency of Monsignor Louis Duchesne was appointed to consider the Breviary, the Missal, the Pontifical and the Ritual.

The beauty and value of many of the Latin Breviaries were brought to the notice of English churchmen by one of the numbers of the Oxford *Tracts for the Times*, since which time they have been much more studied, both for their own sake and for the light they throw upon the English Prayer-Book.

From a bibliographical point of view some of the early printed Breviaries are among the rarest of literary curiosities, being merely local. The copies were not spread far, and were soon

¹ It was approved by Clement VII. and Paul III., and permitted as a substitute for the unrevised Breviary, until Pius V. in 1568 excluded it as too short and too modern, and issued a reformed edition (*Breviarium Pianum*, Pian Breviary) of the old Breviary.

worn out by the daily use made of them. Doubtless many editions have perished without leaving a trace of their existence, while others are known by unique copies. In Scotland the only one which has survived the convulsions of the 16th century is that of Aberdeen, a Scottish form of the Sarum Office,² revised by William Elphinstone (bishop 1483-1514), and printed at Edinburgh by Walter Chapman and Andrew Myllar in 1509-1510. Four copies have been preserved of it, of which only one is complete; but it was reprinted in facsimile in 1854 for the Bannatyne Club by the munificence of the duke of Buccleuch. It is particularly valuable for the trustworthy notices of the early history of Scotland which are embedded in the lives of the national saints. Though enjoined by royal mandate in 1501 for general use within the realm of Scotland, it was probably never widely adopted. The new Scottish *Proprium* sanctioned for the Roman Catholic province of St Andrews in 1903 contains many of the old Aberdeen collects and antiphons.

The Sarum or Salisbury Breviary itself was very widely used. The first edition was printed at Venice in 1483 by Raynald de Novimagio in folio; the latest at Paris, 1556, 1557. While modern Breviaries are nearly always printed in four volumes, one for each season of the year, the editions of the Sarum never exceeded two parts.

Contents of the Roman Breviary.—At the beginning stands the usual introductory matter, such as the tables for determining the date of Easter, the calendar, and the general rubrics. The Breviary itself is divided into four seasonal parts—winter, spring, summer, autumn—and comprises under each part (1) the Psalter; (2) *Proprium de Tempore* (the special office of the season); (3) *Proprium Sanctorum* (special offices of saints); (4) *Commune Sanctorum* (general offices for saints); (5) *Extra Services*. These parts are often published separately.

1. *The Psalter.*—This is the very backbone of the Breviary, the groundwork of the Catholic prayer-book; out of it have grown the antiphons, responsories and versicles. In the Breviary the psalms are arranged according to a disposition dating from the 8th century, as follows. Psalms I.-civiii., with some omissions, are recited at Matins, twelve each day from Monday to Saturday, and eighteen on Sunday. The omissions are said at Lauds, Prime and Compline. Psalms cix.-cxviii. (except cxvii., cxviii. and cxlii.) are said at Vespers, five each day. Psalms cxlviii.-cl. are always used at Lauds, and give that hour its name. The text of this Psalter is that commonly known as the Gallican. The name is misleading, for it is simply the second revision (A.D. 392) made by Jerome of the old *Itala* version originally used in Rome. Jerome's first revision of the *Itala* (A.D. 383), known as the Roman, is still used at St Peter's in Rome, but the "Gallican" thanks especially to St Gregory of Tours, who introduced it into Gaul in the 6th century, has ousted it everywhere else. The Antiphony of Bangor proves that Ireland accepted the Gallican version in the 7th century, and the English Church did so in the 10th.

2. The *Proprium de Tempore* contains the office of the seasons of the Christian year (Advent to Trinity), a conception that only gradually grew up. There is here given the whole service for every Sunday and week-day, the proper antiphons, responsories, hymns, and especially the course of daily Scripture-reading, averaging about twenty verses a day, and (roughly) arranged thus: for Advent, Isaiah; Epiphany to Septuagesima, Pauline Epistles; Lent, patristic homilies (Genesis on Sundays); Passion-tide, Jeremiah; Easter to Whitsun, Acts, Catholic epistles and Apocalypse; Whitsun to August, Samuel and Kings; August to Advent, Wisdom books, Maccabees, Prophets. The extracts are often scrappy and torn out of their context.

3. The *Proprium Sanctorum* contains the lessons, psalms and liturgical formularies for saints' festivals, and depends on the days of the secular month. Most of the material here is hagiological biography, occasionally revised as by Leo XIII. in view of archaeological and other discoveries, but still largely uncritical. Covering a great stretch of time and space, they do for the worshipper in the field of church history what the Scripture readings do in that of biblical history. As something like 90% of the days in the year have, during the course of centuries, been allotted to some saint or other, it is easy to see how this section of the Breviary has encroached upon the *Proprium de Tempore*, and this is the chief problem that confronts any who are concerned for a revision of the Breviary.

4. The *Commune Sanctorum* comprises psalms, antiphons, lessons, &c., for feasts of various groups or classes (twelve in all); e.g. apostles, martyrs, confessors, virgins, and the Blessed Virgin Mary. These offices are of very ancient date, and many of them were probably

² The Sarum Rite was much favoured in Scotland as a kind of protest against the jurisdiction claimed by the church of York.

in origin proper to individual saints. They contain passages of great literary beauty. The lessons read at the third nocturn are patristic homilies on the Gospels, and together form a rough summary of theological instruction.

5. *Extra Services*.—Here are found the Little Office of the Blessed Virgin Mary, the Office of the Dead (obligatory on All Souls' Day), and offices peculiar to each diocese.

It has already been indicated, by reference to Matins, Lauds, &c., that not only each day, but each part of the day, has its own office, the day being divided into liturgical "hours." A detailed account of these will be found in the article HOURS, CANONICAL. Each of the hours of the office is composed of the same elements, and something must be said now of the nature of these constituent parts, of which mention has here and there been already made. They are: psalms (including canticles), antiphons, responsories, hymns, lessons, little chapters, versicles and collects.

The *psalms* have already been dealt with, but it may be noted again how the multiplication of saints' festivals, with practically the same special psalms, tends in practice to constant repetition of about one-third of the Psalter, and correspondingly rare recital of the remaining two-thirds, whereas the *Proprium de Tempore*, could it be adhered to, would provide equal opportunities for every psalm. As in the Greek usage and in the Benedictine, certain canticles like the Song of Moses (Exodus xv.), the Song of Hannah (1 Sam. ii.), the prayer of Habakkuk (iii.), the prayer of Hezekiah (Isaiah xxxviii.) and other similar Old Testament passages, and, from the New Testament, the Magnificat, the Benedictus and the Nunc dimittis, are admitted as psalms.

The *antiphons* are short liturgical forms, sometimes of biblical, sometimes of patristic origin, used to introduce a psalm. The term originally signified a chant by alternate choirs, but has quite lost this meaning in the Breviary.

The *responsories* are similar in form to the antiphons, but come at the end of the psalm, being originally the reply of the choir or congregation to the precentor who recited the psalm.

The *hymns* are short poems going back in part to the days of Prudentius, Synesius, Gregory of Nazianus and Ambrose (4th and 5th centuries), but mainly the work of medieval authors. Together they make a fine collection, and it is a pity that Urban VIII. in his mistaken humanistic zeal tried to improve them.

The *lessons*, as has been seen, are drawn variously from the Bible, the Acts of the Saints and the Fathers of the Church. In the primitive church, books afterwards excluded from the canon were often read, e.g. the letters of Clement of Rome and the *Shepherd of Hermas*. In later days the churches of Africa, having rich memorials of martyrdom, used them to supplement the reading of Scripture. Monastic influence accounts for the practice of adding to the reading of a biblical passage some patristic commentary or exposition. Books of homilies were compiled from the writings of SS. Augustine, Hilary, Athanasius, Isidore, Gregory the Great and others, and formed part of the library of which the Breviary was the ultimate compendium. In the lessons, as in the psalms, the order for special days breaks in upon the normal order of ferial offices and dislocates the scheme for consecutive reading. The lessons are read at Matins (which is subdivided into three nocturns).

The *little chapters* are very short lessons read at the other "hours."

The *versicles* are short responsories used after the little chapters.

The *collects* come at the close of the office and are short prayers summing up the supplications of the congregation. They arise out of a primitive practice on the part of the bishop (local president), examples of which are found in the *Didaché* (Teaching of the Apostles) and in the letters of Clement of Rome and Cyrian. With the crystallization of church order improvisation in prayer largely gave place to set forms, and collections of prayers were made which later developed into Sacramentaries and Oratorials. The collects of the Breviary are largely drawn from the Gelasian and other Sacramentaries, and they are used to sum up the dominant idea of the festival in connexion with which they happen to be used.

The difficulty of harmonizing the *Proprium de Tempore* and the *Proprium Sanctorum* to which reference has been made, is only partly met in the thirty-seven chapters of general rubrics. Additional help is given by a kind of Catholic Churchman's Almanack, called the *Ordo Rationis Divini Officii*, published in different countries and dioceses, and giving, under every day, minute directions for proper reading.

Every clerk in orders and every member of a religious order must publicly join in or privately read aloud (i.e. using the lips as well as the eyes—it takes about two hours in this way) the whole of the Breviary services allotted for each day. In large churches the services are usually grouped; e.g. Matins and Lauds (about 7.30 A.M.); Prime, Terce (High Mass), Sext, and None (about 10 A.M.); Vespers and Compline (4 P.M.); and from four to eight hours (depending on the amount of music and the number of high masses) are thus spent in choir. Laymen do not use the Breviary as a manual of devotion to any great extent.

The Roman Breviary has been translated into English (by the marquis of Bute in 1879; new ed. with a trans. of the Martyrology, 1908), French and German. The English version is noteworthy for its inclusion of the skilful renderings of the ancient hymns by J. H. Newman, J. M. Neale and others.

AUTHORITIES.—F. Cabrol, *Introduction aux études liturgiques*; Probst, *Kirchenlex. II.*, s.s. "Brevier"; Bäumer, *Geschichte des Breviers* (Freiburg, 1895); P. Batiffol, *L'Histoire du bréviaire romain* (Paris, 1893; Eng. tr.); Baudot, *Le Bréviaire romain* (1907). A complete bibliography is appended to the article by F. Cabrol in the *Catholic Encyclopedia*, vol. ii. (1908).

BREVINARY OF ALARIC (*Breviarium Alaricansum*), a collection of Roman law, compiled by order of Alaric II., king of the Visigoths, with the advice of his bishops and nobles, in the twenty-second year of his reign (A.D. 506). It comprises sixteen books of the Theodosian code; the Novels of Theodosius II., Valentinian III., Marcian, Majorianus and Severus; the Institutes of Gaius; five books of the *Sententiae Receptae* of Julius Paulus; thirteen titles of the Gregorian code; two titles of the Hermogenian code; and a fragment of the first book of the *Responsa Papinianae*. It is termed a code (codex), in the certificate of Anianus, the king's referendary, but unlike the code of Justinian, from which the writings of jurists were excluded, it comprises both imperial constitutions (*leges*) and juridical treatises (*juris*). From the circumstance that the Breviary has prefixed to it a royal rescript (*commodianorium*) directing that copies of it, certified under the hand of Anianus, should be received exclusively as law throughout the kingdom of the Visigoths, the compilation of the code has been attributed to Anianus by many writers, and it is frequently designated the Breviary of Anianus (Breviary of Aniani). The code, however, appears to have been known amongst the Visigoths by the title of "Lex Romana," or "Lex Theodosii," and it was not until the 16th century that the title of "Breviary" was introduced to distinguish it from a recast of the code, which was introduced into northern Italy in the 9th century for the use of the Romans in Lombardy. This recast of the Visigothic code has been preserved in a MS. known as the Codex Utinensis, which was formerly kept in the archives of the cathedral of Udine, but is now lost; and it was published in the 18th century for the first time by P. Canciani in his collection of ancient laws entitled *Barbarorum Leges Antiquae*. Another MS. of this Lombard recast of the Visigothic code was discovered by Hänel in the library of St Gall. The chief value of the Visigothic code consists in the fact that it is the only collection of Roman Law in which the five first books of the Theodosian code and five books of the *Sententiae Receptae* of Julius Paulus have been preserved, and until the discovery of a MS. in the chapter library in Verona, which contained the greater part of the Institutes of Gaius, it was the only work in which any portion of the institutional writings of that great jurist had come down to us.

The most complete edition of the Breviary will be found in the collection of Roman law published under the title of *Jus Civile Ante-Justinianum* (Berlin, 1815). See also G. Hänel's *Lex Romana Visigothorum* (Berlin, 1847-1849).

BREWER, JOHN SHERREN (1810-1879), English historian, was born in Norwich in 1810, the son of a Baptist schoolmaster. He was educated at Queen's College, Oxford, was ordained in the Church of England in 1837, and became chaplain to a central London workhouse. In 1839 he was appointed lecturer in classical literature at King's College, London, and in 1855 he became professor of English language and literature and lecturer in modern history, succeeding F. D. Maurice. Meanwhile from 1854 onwards he was also engaged in journalistic work on the *Morning Herald*, *Morning Post* and *Standard*. In 1856 he was commissioned by the master of the rolls to prepare a calendar of the state papers of Henry VIII., a work demanding a vast amount of research. He was also made reader at the Rolls, and subsequently preacher. In 1877 Disraeli secured for him the crown living of Toppefield, Essex. There he had time to continue his task of preparing his *Letters and Papers of the Reign of King Henry VIII.*, the Introductions to which (published separately, under the title *The Reign of Henry VIII.*, in 1884) form a scholarly and authoritative history of Henry VIII.'s reign. New editions of several standard historical works were also produced under Brewer's direction. He died at Toppefield in February 1879.

BREWING, in the modern acceptation of the term, a series of operations the object of which is to prepare an alcoholic beverage of a certain kind—to wit, beer—mainly from cereals (chiefly malted barley), hops and water. Although the art of preparing beer (*q.v.*) or ale is a very ancient one, there is very little information in the literature of the subject as to the apparatus and methods employed in early times. It seems fairly certain, however, that up to the 18th century these were of the most primitive kind. With regard to *materials*, we know that prior to the general introduction of the hop (see **ALE**) as a preservative and astringent, a number of other bitter and aromatic plants had been employed with this end in view. Thus J. L. Baker (*The Brewing Industry*) points out that the Cimbric used the *Tamarix germanica*, the Scandinavians the fruit of the sweet gale (*Myrica gale*), the Cauchi the fruit and the twigs of the chaste tree (*Vitex agrius castus*), and the Icelanders the yarrow (*Achillea millefolium*).

The preparation of beer on anything approaching to a manufacturing scale appears, until about the 12th or 13th century, to have been carried on in England chiefly in the monasteries; but as the brewers of London combined to form an association in the reign of Henry IV., and were granted a charter in 1445, it is evident that brewing as a special trade or industry must have developed with some rapidity. After the Reformation the ranks of the trade brewers were swelled by numbers of monks from the expropriated monasteries. Until the 18th century the professional brewers, or brewers for sale, as they are now called, brewed chiefly for the masses, the wealthier classes preparing their own beer, but it then became gradually apparent to the latter (owing no doubt to improved methods of brewing, and for other reasons) that it was more economical and less troublesome to have their beer brewed for them at a regular brewery. The usual charge was 30s. per barrel for bitter ale, and 8s. or so for small beer. This tendency to centralize brewing operations became more and more marked with each succeeding decade. Thus during 1895-1905 the number of private brewers declined from 17,041 to 9930. Of the private brewers still existing, about four-fifths were in the class exempted from beer duty, i.e. farmers occupying houses not exceeding £10 annual value who brew for their labourers, and other persons occupying houses not exceeding £15 annual value. The private houses subject to both beer and licence duty produced less than 20,000 barrels annually. There are no official figures as to the number of "cottage brewers," that is, occupiers of dwellings not exceeding £8 annual value; but taking everything into consideration it is probable that more than 99% of the beer produced in the United Kingdom is brewed by public brewers (brewers for sale). The disappearance of the smaller public brewers or their absorption by the larger concerns has gone hand-in-hand with the gradual extinction of the private brewer. In the year 1894-1895 8863 licences were issued to brewers for sale, and by 1904-1905 this number had been reduced to 5164. There are numerous reasons for these changes in the constitution of the brewing industry, chief among them being (a) the increasing difficulty, owing partly to licensing legislation and its administration, and partly to the competition of the great breweries, of obtaining an adequate outlet for retail sale in the shape of licensed houses; and (b) the fact that brewing has continuously become a more scientific and specialized industry, requiring costly and complicated plant and expert manipulation. It is only by employing the most up-to-date machinery and expert knowledge that the modern brewer can hope to produce good beer in the short time which competition and high taxation, &c., have forced upon him. Under these conditions the small brewer tends to extinction, and the public are ultimately the gainers. The relatively non-alcoholic, lightly hopped and bright modern beers, which the small brewer has not the means of producing, are a great advance on the muddy, highly hopped and alcoholized beverages to which our ancestors were accustomed.

The brewing trade has reached vast proportions in the United Kingdom. The maximum production was 37,090,986 barrels in 1900, and while there has been a steady decline since that

year, the figures for 1905-1906—34,109,263 barrels—were in excess of those for any year preceding 1897. It is interesting in this connexion to note that the writer of the article on Brewing in the 9th edition of the *Encyclopædia Britannica* was of the opinion that the brewing industry—which was then (1875) producing, roughly, 25,000,000 barrels—had attained its maximum development. In the year ending 30th September 1905 the beer duty received by the exchequer amounted to £13,156,953. The number of brewers for sale was 5180. Of these one firm, namely, Messrs Guinness, owning the largest brewery in the world, brewed upwards of two million barrels, paying a sum of, roughly, one million sterling to the revenue. Three other firms brewed close on a million barrels or upwards. The quantity of malt used was 51,818,697 bushels; of unmalted corn, 125,671 bushels; of rice, flaked maize and similar materials, 1,348,558 cwt.; of sugar, 2,746,615 cwt.; of hops, 62,360,817 lb; and of hop substitutes, 49,202 lb. The average specific gravity of the beer produced in 1905-1906 was 1053.24. The quantity of beer exported was 520,826; of beer imported, 57,104 barrels. It is curious to note that the figures for exports and imports had remained almost stationary for the last thirty years. By far the greater part of the beer brewed is consumed in England. Thus of the total quantity retained for consumption in 1905-1906, 28,500,563 barrels were consumed in England, 1,648,463 in Scotland, and 3,265,084 in Ireland. In 1871 it was calculated by Professor Leone Levi that the capital invested in the liquor trade in the United Kingdom was £117,000,000. In 1908 this figure might be safely doubled. A writer in the *Brewers' Almanach* for 1906 placed the capital invested in limited liability breweries alone at £185,000,000. If we allow for over-capitalization, it seems fairly safe to say that, prior to the introduction of the Licensing Bill of 1908, the market value of the breweries in the United Kingdom, together with their licensed property, was in the neighbourhood of £200,000,000, to which might be added another £20,000,000 for the value of licences not included in the above calculation; the total capital actually sunk in the whole liquor trade (including the wine and spirit industries and trades) being probably not far short of £250,000,000, and the number of persons directly engaged in or dependent on the liquor trade being under-estimated at 2,000,000. (For comparative production and consumption see **BEER**.)

Taxation and Regulations.—The development of the brewing industry in England is intimately interwoven with the history of its taxation, and the regulations which have from time to time been formed for the safeguarding of the revenue. The first duty on beer in the United Kingdom was imposed in the reign of Charles II. (1660), namely 2s. 6d. per barrel on strong and 6d. per barrel on weak beer. This was gradually increased, amounting to 4s. 9d. on strong and 1s. 3d. on weak beer in the last decade of the 17th century, and to 8s. to 10s. in the year 1800, at which rate it continued until the repeal of the beer duty in 1830. A duty on malt was first imposed in the reign of William III. (1697), and from that date until 1830 both beer duty and malt tax were charged. The rate at first was under 7d. per bushel, but this was increased up to 2s. 7d. prior to the first repeal of the beer duty (1830), and to 4s. 6d. after the repeal. In 1829 the joint beer and malt taxes amounted to no less than 13s. 8d. per barrel, or 4½d. per gallon, as against 2½d. at the present day. From 1856 until the abolition of the malt tax the latter remained constant at a fraction under 2s. 8½d. A *hop duty* varying from 1d. to 2½d. per pound was in existence between 1711 and 1862. One of the main reasons for the abolition of the hop duty was the fact that, owing to the uncertainty of the crop, the amount paid to the revenue was subject to wide fluctuations. Thus in 1855 the revenue from this source amounted to £728,183, in 1861 to only £149,700.

It was not until 1847 that the use of sugar in brewing was permitted, and in 1850 the first sugar tax, amounting to 1s. 4d. per cwt., was imposed. It varied from this figure up to 6s. 6d. in 1854, and in 1874, when the general duty on sugar was repealed, it was raised to 11s. 6d., at which rate it remained until 1880, when it was repealed simultaneously with the malt duty. In 1901 a general sugar tax of 4s. 2d. and under (according to the percentage of actual sugar contained) was imposed, but no drawback was allowed to brewers using sugar, and therefore—and this obtains at the present day—sugar used in brewing pays the general tax and also the beer duty.

By the Free Mash-Tun Act of 1880, the duty was taken off the malt and placed on the beer, or, more properly speaking, on the wort; maltsters' and brewers' licences were repealed, and in lieu thereof an annual licence duty of £1 payable by every brewer for sale was

imposed. The chief feature of this act was that, on and after the 1st of October 1880, a beer duty was imposed in lieu of the old malt tax, at the rate of 6s. 3d. per barrel of 36 gallons, at a specific gravity of 1-057, and the regulations for charging the duty were so framed as to leave the brewer practically unrestricted as to the description of malt or corn and sugar, or other description of saccharine substitutes (other than deleterious articles or drugs), which he might use in the manufacture or colouring of beer. This freedom in the choice of materials has continued down to the present time, except that the use of "saccharin" (a product derived from coal-tar) was prohibited in 1888, the reason being that this substance gives an apparent palate-fulness to beer equal to roughly 4" in excess of its real gravity, the revenue suffering thereby. In 1889 the duty on beer was increased by a reduction in the standard of gravity from 1-057 to 1-055, and in 1894 a further 6d. per barrel was added. The duty thus became 6s. 9d. per barrel, at a gravity of 1-055, which was further increased to 7s. 9d. per barrel by the war budget of 1900, at which figure it stood in 1909. (See also LIQUOR LAWS.)

Prior to 1896, rice, flaked maize (see below), and other similar preparations had been classed as malt or corn in reference to their wort-producing powers, but after that date they were deemed sugar¹ in that regard. By the new act (1880) 42 lb weight of corn, or 28 lb weight of sugar, were to be deemed the equivalent of a bushel of malt, and a brewer was expected by one of the modes of charge to have brewed at least a barrel (36 gallons) of worts (less 4% allowed for waste) at the standard gravity for every two bushels of malt (or its equivalents) used by him in brewing; but where, owing to lack of skill or inferior machinery, a brewer cannot obtain the standard quantity of wort from the standard equivalent of material, the charge is made not on the wort, but directly on the material. By the new act, licences at the annual duty of £1 on brewers for sale, and of 6s. (subsequently modified by 44 Vict. c. 12, and 48 and 49 Vict. c. 5, &c., to 4s.) or 9s., as the case might be, on any other brewers, were required. The regulations dealing with the mashing operations are very stringent. Twenty-four hours at least before mashing the brewer must enter in his brewing book (provided by the Island Revenue) the day and hour for commencing to mash malt, corn, &c., or to dissolve sugar; and the date of making such entry; and also, two hours at least before the notice hour for mashing, the quantity of malt, corn, &c., and sugar to be used, and the day and hour when all the worts will be drawn off the grains in the mash-tun. The worts of each brewing much be collected within twelve hours of the commencement of the collection, and the brewer must within a given time enter in his book the quantity and gravity of the worts before fermentation, the number and name of the vessel, and the date of the entry. The worts must remain in the same vessel undisturbed for twelve hours after being collected, unless previously taken account of by the officer. There are other regulations, e.g. those prohibiting the mixing of worts of different brewings unless account has been taken of each separately, the alteration of the size or shape of any gauged vessel without notice, and so on.

Taxation of Beer in Foreign Countries.—The following table shows the nature of the tax and the amount of the same calculated to English barrels.

Country.	Nature of Tax.	Amount per English Barrel (round numbers).
United States	Beer Tax	5s. 9d.
Germany—		
N. German Customs Union	Malt Tax	1s. 6d.
Bavaria	Malt Tax	3s. 5d. to 4s. 8d., according to quantity produced
Belgium	Malt Tax	2s. 9d.
France	On Wort	4s. 1d.
Holland	On cubic contents of Mash-Tun or on Malt	About 1s. 9d. to 3s. 3d., according to quality
Austro-Hungarian Empire	On Wort	6s. 8d.
Russia	Malt Tax	5s. to 6s. 8d.

MATERIALS USED IN BREWING.—These are water, malt (q.v.), hops (q.v.), various substitutes for the two latter, and preservatives.

Water.—A satisfactory supply of water—which, it may here be mentioned, is always called *liquor* in the brewery—is a matter of great importance to the brewer. Certain waters, for instance, those contaminated to any extent with organic matter, cannot be used at all in brewing, as they give rise to unsatisfactory fermentation, cloudiness and abnormal flavour. Others again, although suited to the production of one type of beer, are quite unfit for the brewing of another. For black beers a soft water is a desideratum, for ales of the Burton type a hard water is a necessity. For the brewing of mild ales, again, a water contain-

¹ They were classified at 28lb in 1896, but since 1897 the standard has been at the rate of 32 lb to the bushel.

ing a certain proportion of chlorides is required. The presence or absence of certain mineral substances as such in the finished beer is not, apparently, a matter of any moment as regards flavour or appearance, but the importance of the rôle played by these substances in the brewing process is due to the influence which they exert on the solvent action of the water on the various constituents of the malt, and possibly of the hops. The excellent quality of the Burton ales was long ago surmised to be due mainly to the well water obtainable in that town. On analysing Burton water it was found to contain a considerable quantity of calcium sulphate—gypsum—and of other calcium and magnesium salts, and it is now a well-known fact that good bitter ales cannot be brewed except with waters containing these substances in sufficient quantities. Similarly, good mild ale waters should contain a certain quantity of sodium chloride, and waters for stout very little mineral matter, excepting perhaps the carbonates of the alkaline earths, which are precipitated on boiling.

The following analyses (from W. J. Sykes, *The Principles and Practice of Brewing*) are fairly illustrative of typical brewing waters.

<i>Burton Water (Pale Ale).</i>		Grains per Gallon.
Sodium Chloride	3-90
Potassium Sulphate	1-59
Sodium Nitrate	1-97
Calcium Sulphate	77-87
Calcium Carbonate	7-62
Magnesium Carbonate	21-31
Silica and Alumina	0-98
<i>Dublin Water (Stout).</i>		
Sodium Chloride	1-83
Calcium Sulphate	4-45
Calcium Carbonate	14-21
Magnesium Carbonate	0-90
Iron Oxide and Alumina	0-24
Silica	0-26
<i>Mild Ale Water.</i>		
Sodium Chloride	35-14
Calcium Chloride	3-88
Calcium Sulphate	6-23
Calcium Carbonate	4-01
Iron Oxide and Alumina	0-24
Silica	0-22

Our knowledge of the essential chemical constituents of brewing waters enables brewers in many cases to treat an unsatisfactory supply artificially in such a manner as to modify its character in a favourable sense. Thus, if a soft water only is to hand, and it is desired to brew a bitter ale, all that is necessary is to add a sufficiency of gypsum, magnesium sulphate and calcium chloride. If it is desired to convert a soft water lacking in chlorides into a satisfactory mild ale liquor, the addition of 30-40 grains of sodium chloride will be necessary. On the other hand, to convert a hard water into a soft supply is scarcely feasible for brewing purposes. To the substances used for treating brewing liquors already mentioned we may add kankite, a naturally deposited composite salt containing potassium and magnesium sulphates and magnesium chloride.

Malt Substitutes.—Prior to the repeal of the Malt Acts, the only substitute for malt allowed in the United Kingdom was sugar. The quantity of the latter employed was 295,865 cwt. in 1870, 1,136,434 cwt. in 1880, and 2,746,615 cwt. in 1905; that is to say, that the quantity used had been practically trebled during the last twenty-five years, although the quantity of malt employed had not materially increased. At the same time other substitutes, such as unmalted corn and preparations of rice and maize, had come into favour, the quantity of these substances used being in 1905 125,671 bushels of unmalted corn and 1,348,558 cwt. of rice, maize, &c.

The following statistics with regard to the use of malt substitutes in the United Kingdom are not without interest.

Year.	Quantities of Malt and Corn used in Brewing.	Quantities of Sugar, Rice, Maize, &c. used in Brewing.	Percentage of Substitutes to Total Material.
	Bushels.	Bushels.	
1878	59,288,905	3,825,148	6.05
1883	51,331,451 ¹	4,503,680 ²	8.06
1890	55,359,964 ¹	7,904,708 ²	12.48
1895	53,731,177	10,754,510	16.66
1903	51,942,368	15,706,413	23.22

The causes which have led to the largely increased use of substitutes in the United Kingdom are of a somewhat complex nature. In the first place, it was not until the malt tax was repealed that the brewer was able to avail himself of the surplus diastatic energy present in malt, for the purpose of transforming starch (other than that in malted grain) into sugar. The diastatic enzyme or ferment (see below, under *Mashing*) of malted barley is present in that material in great excess, and a part of this surplus energy may be usefully employed in converting the starch of unmalted grain into sugar. The brewer has found also that brewing operations are simplified and accelerated by the use of a certain proportion of substitutes, and that he is thereby enabled appreciably to increase his turn-over, i.e. he can make more beer in a given time from the same plant. Certain classes of substitutes, too, are somewhat cheaper than malt, and in view of the keenness of modern competition it is not to be wondered at that the brewer should resort to every legitimate means at his disposal to keep down costs. It has been contended, and apparently with much reason, that if the use of substitutes were prohibited this would not lead to an increased use of domestic barley, inasmuch as the supply of home barley suitable for malting purposes is of a limited nature. A return to the policy of "malt and hops only" would therefore lead to an increased use of foreign barley, and to a diminution in the demand for home barley, inasmuch as sugar and prepared cereals, containing as they do less nitrogen, &c. than even the well-cured, sun-dried foreign barleys, are better diluents than the latter. At the same time, it is an undoubted fact that an excessive use of substitutes leads to the production of beer of poor quality. The better class of brewer rarely uses more than 15-20%, knowing that beyond that point the loss of flavour and quality will in the long run become a more serious item than any increased profits which he might temporarily gain.

With regard to the nature of the substitutes or adjuncts for barley malt more generally employed, raw grain (unmalted barley, wheat, rice, maize, &c.) is not used extensively in Great Britain, but in America brewers employ as much as 50%, and even more, of maize, rice or similar materials. The maize and rice preparations mostly used in England are practically starch pure and simple, substantially the whole of the oil, water, and other subsidiary constituents of the grain being removed. The germ of maize contains a considerable proportion of an oil of somewhat unpleasant flavour, which has to be eliminated before the material is fit for use in the mash-tun. After degerming, the maize is unhusked, wetted, submitted to a temperature sufficient to rupture the starch cells, dried, and finally rolled out in a flaky condition. Rice is similarly treated.

The sugars used are chiefly cane sugar, glucose and invert sugar—the latter commonly known as "saccharum." Cane sugar is mostly used for the preparation of heavy mild ales and stouts, as it gives a peculiarly sweet and full flavour to the beer, to which, no doubt, the popularity of this class of beverage is largely due. Invert sugar is prepared by the action either of acid or of yeast on cane sugar. The chemical equation representing the conversion (or inversion) of cane sugar is:—

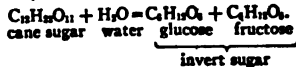

Invert sugar is so called because the mixture of glucose and fructose which forms the "invert" is laevo-rotatory, whereas

¹Inclusive of rice and maize. ²Exclusive of rice and maize.

cane sugar is dextro-rotatory to the plane of polarized light. The preparation of invert sugar by the acid process consists in treating the cane sugar in solution with a little mineral acid, removing the excess of the latter by means of chalk, and concentrating to a thick syrup. The yeast process (Tompson's), which makes use of the inverting power of one of the enzymes (invertase) contained in ordinary yeast, is interesting. The cane sugar solution is pitched with yeast at about 55° C., and at this comparatively high temperature the inversion proceeds rapidly, and fermentation is practically impossible. When this operation is completed, the whole liquid (including the yeast) is run into the boiling contents of the copper. This method is more suited to the preparation of invert in the brewery itself than the acid process, which is almost exclusively used in special sugar works. Glucose, which is one of the constituents of invert sugar, is largely used by itself in brewing. It is, however, never prepared from invert sugar for this purpose, but directly from starch by means of acid. By the action of dilute boiling acid on starch the latter is rapidly converted first into a mixture of dextrine and maltose and then into glucose. The proportions of glucose, dextrine and maltose present in a commercial glucose depend very much on the duration of the boiling, the strength of the acid, and the extent of the pressure at which the starch is converted. In England the materials from which glucose is manufactured are generally sago, rice and purified maize. In Germany potatoes form the most common raw material, and in America purified Indian corn is ordinarily employed.

Hop substitutes, as a rule, are very little used. They mostly consist of quassia, gentian and camomile, and these substitutes are quite harmless *per se*, but impart an unpleasantly rough and bitter taste to the beer.

Preservatives.—These are generally, in fact almost universally, employed nowadays for draught ales; to a smaller extent for stock ale. The light beers in vogue to-day are less alcoholic, more lightly hopped, and more quickly brewed than the beers of the last generation, and in this respect are somewhat less stable and more likely to deteriorate than the latter were. The preservative in part replaces the alcohol and the hop extract, and shortens the brewing time. The preservatives mostly used are the bisulphites of lime and potash, and these, when employed in small quantities, are generally held to be harmless.

BREWING OPERATIONS.—The general scheme of operations in an English brewery will be readily understood if reference be made to fig. 1, which represents an 8-quarter brewery on the *gravitation system*, the principle of which is that all materials to be employed are pumped or hoisted to the highest point required, to start with, and that subsequently no further pumping or hoisting is required, the materials (in the shape of water, malt, wort or hops, &c.) being conveyed from one point to another by the force of gravity.

The malt, which is hoisted to the top floor, after cleaning and grading is conveyed to the *Malt Mill*, where it is crushed. Thence the ground malt, or "grist" as it is now called, passes to the *Grist Hopper*, and from the latter to the *Mashing Machine*, in which it is intimately mixed with hot water from the *Hot Liquor Vessel*. From the mashing machine the mixed grist and "liquor" pass to the *Mash-Tun*, where the starch of the malt is rendered soluble. From the mash-tun the clear wort passes to the *Copper*, where it is boiled with hops. From the copper the boiled wort passes to the *Hop Back*, where the insoluble hop constituents are separated from the wort. From the hop back the wort passes to the *Cooler*, from the latter to the *Refrigerator*, thence (for the purpose of enabling the revenue officers to assess the duty) to the *Collecting Vessel*,³ and finally to the *Fermenting Vessels*, in which the wort is transformed into "green" beer. The latter is then cleaned, and finally racked and stored.

It will be seen from the above that brewing consists of seven distinct main processes, which may be classed as follows: (1) Grinding; (2) Mashing; (3) Boiling; (4) Cooling; (5) Fermenting; (6) Cleaning; (7) Racking and Storing.

Grinding.—In most modern breweries the malt passes, on its way

³As a rule there is no separate "collecting vessel," duty being assessed in the fermenting vessels.

from the bins to the mill, through a cleaning and grading apparatus, and then through an automatic measuring machine. The mills, which exist in a variety of designs, are of the smooth roller type, and are so arranged that the malt is *crushed* rather than ground, and

difficulties arise in regard to efficient drainage in the mash-tun and subsequent clarification. On the other hand, if the crushing is too coarse the subsequent extraction of soluble matter in the mash-tun is incomplete, and an inadequate yield results.

Mashing is a process which consists mainly in extracting, by means of water at an adequate temperature, the soluble matters pre-existent in the malt, and in converting

in order to wash out the wort remaining in the grains. The sparger consists of a number of hollow arms radiating from a common centre and pierced by a number of small perforations. The common central vessel from which the sparge-arms radiate is mounted in such a manner that it rotates automatically when a stream of water is admitted, so that a constant fine spray covers the whole tun when the sparger is in operation. There are also pipes for admitting "liquor" to the bottom of the tun, and for carrying the wort from the latter to the "underback" or "copper."

The grist and liquor having been introduced into the tun (either by means of the mashing machine or separately), the rakes are set going, so that the mash may become thoroughly homogeneous, and after a short time the rakes are stopped and the mash allowed to rest, usually for a period of about two hours. After this, "taps are set"—i.e. communication is established between the mash-tun and the vessel into which the wort runs—and the sparger is started. In this manner the whole of the wort or extract is separated from the grains. The quantity of water employed is, in all, from two to three barrels to the quarter (336 lb) of malt.

In considering the process of mashing, one might almost say the process of brewing, it is essential to remember that the type and quality of the beer to be produced (see MALT) depends almost entirely (a) on the kind of malt employed, and (b) on the mashing temperature. In other words, quality may be controlled on the kiln or in the mash-tun, or both. Viewed in this light, the following theoretical methods for preparing different types of beer are possible:—(1) high kiln heats and high mashing temperatures; (2) high kiln heats and low mashing temperatures; (3) low kiln heats and high mashing temperatures; and (4) low kiln heats and low mashing temperatures. In practice all these combinations, together with many intermediate ones, are met with, and it is not too much to say that the whole science of modern brewing is based upon them. It is plain, then, that the mashing temperature will depend on the kind of beer that is to be produced, and on the kind of malt employed. For stouts and black beers generally, a mashing temperature of 148° to 150° F. is most usual; for pale or stock ales, 150° to 154° F.; and for mild running beers, 154° to 149° F. The range of temperatures employed in brewing English beers is a very limited one as compared with foreign mashing methods, and does not range further, practically speaking, than from 140° to 160° F. The effect of higher temperatures is chiefly to cripple the enzyme or "ferment" diastase, which, as already said, is the agent which converts the insoluble starch into soluble dextrin, sugar and intermediate products. The higher the mashing temperature, the more the diastase will be crippled in its action, and the more dextrinous (non-fermentable) matter as compared with maltose (fermentable sugar) will be formed. A pale or stock ale, which is a type of beer that must be "dry" and that will keep, requires to contain a relatively high proportion of dextrin and little maltose, and, in its preparation, therefore, a high mashing temperature will be employed. On the other hand, a mild running ale, which is a full, sweet beer, intended for rapid consumption,

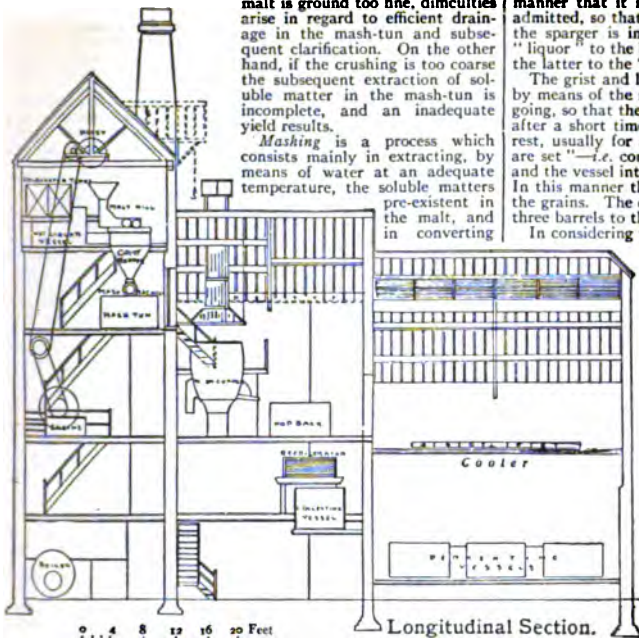

FIG. 1.—An 8-quarter Brewery (Messrs L. Lumley & Co., Ltd.).

the insoluble starch and a great part of the insoluble nitrogenous compounds into soluble and partly fermentable products. Mashing is, without a doubt, the most important of the brewing processes, for it is largely in the mash-tun that the character

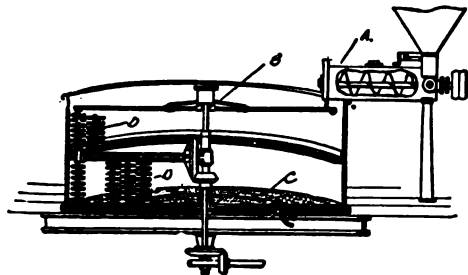

FIG. 2.—Mash-tun with mashing machine.

of the beer to be brewed is determined. In modern practice the malt and the mashing "liquor" (i.e. water) are introduced into the mash-tun simultaneously, by means of the mashing machine (fig. 2, A). This is generally a cylindrical metal vessel, commanding the mash-tun and provided with a central shaft and screw. The grist (as the crushed malt is called) enters the mashing machine from the grist case above, and the liquor is introduced at the back. The screw is rotated rapidly, and so a thorough mixture of the grist and liquor takes place as they travel along the mashing machine. The mash-tun (fig. 2) is a large metal or wooden vessel, fitted with a false bottom composed of plates perforated with numerous small holes or slits (C). This arrangement is necessary in order to obtain a proper separation of the "wort" (as the liquid portion of the finished mash is called) from the spent grains. The mash-tun is also provided with a stirring apparatus (the rakes) so that the grist and liquor may be intimately mixed (D), and an automatic sprinkler, the sparger (fig. 2, B, and fig. 3), which is employed

speaking, than from 140° to 160° F. The effect of higher temperatures is chiefly to cripple the enzyme or "ferment" diastase, which, as already said, is the agent which converts the insoluble starch into soluble dextrin, sugar and intermediate products. The higher the mashing temperature, the more the diastase will be crippled in its action, and the more dextrinous (non-fermentable) matter as compared with maltose (fermentable sugar) will be formed. A pale or stock ale, which is a type of beer that must be "dry" and that will keep, requires to contain a relatively high proportion of dextrin and little maltose, and, in its preparation, therefore, a high mashing temperature will be employed. On the other hand, a mild running ale, which is a full, sweet beer, intended for rapid consumption,

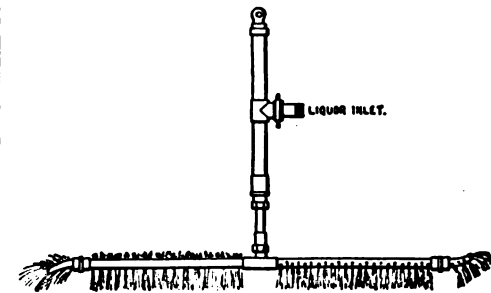

FIG. 3.—Sparger.

will be obtained by means of low mashing temperatures, which produce relatively little dextrin, but a good deal of maltose, i.e. sweet and readily fermentable matter.

Diastase is not the only enzyme present in malt. There is also a ferment which renders a part of the nitrogenous matter soluble. This again is affected by temperature in much the same way as diastase. Low heats tend to produce much non-coagulable

nitrogenous matter, which is undesirable in a stock beer, as it tends to produce fret and side fermentations. With regard to the kind of malt and other materials employed in producing various types of beer, pale ales are made either from pale malt (generally a mixture of English and fine foreign, such as Smyrna, California) only, or from pale malt and a little flaked maize, rice, invert sugar or glucose. Running beers (mild ale) are made from a mixture of pale and amber malts, sugar and flaked goods; stout, from a mixture of pale, amber and roasted (black) malts only, or with the addition of a little sugar or flaked maize.

When raw grain is employed, the process of mashing is slightly modified. The maize, rice or other grain is usually gelatinized in a vessel (called a *converter* or *cooker*) entirely separated from the mash-tun, by means of steam at a relatively high temperature, mostly with, but occasionally without, the addition of some malt meal. After about half an hour the gelatinized mass is mixed with the main mash, and this takes place shortly before taps are set. This is possible inasmuch as the starch, being already in a highly disintegrated condition, is very rapidly converted. By working on the limited-decoction system (see below), it is possible to make use of a fair percentage of raw grain in the mash-tun proper, thus doing away with the "converter" entirely.

The Filter Press Process.—The ordinary mash-tun process, as described above, possesses the disadvantage that only coarse grists can be employed. This entails loss of extract in several ways. To begin with, the sparging process is at best a somewhat inefficient method for washing out the last portions of the wort, and again, when the malt is at all hard or "steely," starch conversion is by no means complete. These disadvantages are overcome by the filter press process, which was first introduced into Great Britain by the Belgian engineer P. Meura. The malt, in this method of brewing, is ground quite fine, and although an ordinary mash-tun may be used for mashing, the separation of the clear wort from the solid matter takes place in the filter press, which retains the very finest particles with ease. It is also a simple matter to wash out the wort from the filter cake in the presses, and experience has shown that markedly increased yields are thus obtained. In the writer's opinion, there is little doubt that in the future this, or a similar process, will find a very wide application.

Boiling.—From the mash-tun the wort passes to the *copper*. If it is not possible to arrange the plant so that the coppers are situated beneath the mash-tuns (as is the case in breweries arranged on the *gravitation system*), an intermediate collecting vessel (the underback) is interposed, and from this the wort is pumped into the copper. The latter is a large copper vessel heated by direct fire or steam. Modern coppers are generally closed in with a dome-shaped head, but many old-fashioned open coppers are still to be met with, in fact pale-ale brewers prefer open coppers. In the closed type the wort is frequently boiled under slight pressure. When the wort has been raised to the boil, the hops or a part thereof are added, and the boiling is continued generally from an hour to three hours, according to the type of beer. The objects of boiling, briefly put, are: (1) sterilization of the wort; (2) extraction from the hops of substances that give flavour and aroma to the beer; (3) the coagulation and precipitation of a part of the nitrogenous matter (the coagulable albuminoids), which, if left in, would cause cloudiness and fret, &c., in the finished beer; (4) the concentration of the wort. At least three distinct substances are extracted from the hops in boiling. First, the *hop tannin*, which, combining with a part of the proteids derived from the malt, precipitates them; second, the *hop resin*, which acts as a preservative and bitter; third, the *hop oil*, to which much of the fine aroma of beer is due. The latter is volatile, and it is customary, therefore, not to add the whole of the hops to the wort when it commences to boil, but to reserve about a third until near the end of the copper stage. The quantity of hops employed varies according to the type of beer, from about 3 lb to 15 lb per quarter (336 lb) of malt. For mild ales and porters about 3 to 4 lb, for light pale ales and light stouts 6 to 10 lb, and for strong ales and stouts 9 to 15 lb of hops are employed.

Cooling.—When the wort has boiled the necessary time, it is turned into the *hop back* to settle. A hop back is a wooden or metal vessel, fitted with a false bottom of perforated plates; the latter retain the spent hops, the wort being drawn off into the coolers. After resting for a brief period in the hop back, the bright wort is run into the *coolers*. The cooler is a very shallow vessel of great area, and the result of the exposure of the hot wort to a comparatively large volume of air is that a part of the hop constituents and other substances contained in the wort are rendered insoluble and are precipitated. It was formerly considered absolutely essential that this hot aeration should take place, but in many breweries nowadays coolers are not used, the wort being run direct from the hop back to the refrigerator. There is much to be said for this procedure, as the exposure of hot wort in the cooler is attended with much danger of bacterial and wild yeast infection, but it is still a moot point whether the cooler or its equivalent can be entirely dispensed with for all classes of beers. A rational alteration would appear to be to place the cooler in an air-tight chamber supplied with purified and sterilized air. This principle has already been applied to the refrigerator, and apparently with success. In America the cooler is frequently replaced by a cooling tank, an enclosed vessel of some

depth, capable of artificial aeration. If is not practicable, in any case, to cool the wort sufficiently on the cooler to bring it to the proper temperature for the fermentation stage, and for this purpose, therefore, the *refrigerator* is employed. There are several kinds of refrigerators, the main distinction being that some are vertical, others horizontal; but the principle in each case is much the same, and consists in allowing a thin film or stream of wort to trickle over a series of pipes through which cold water circulates. Fig. 5, Plate I., shows refrigerators, employed in Messrs Allsopp's lager beer brewery, at work.

Fermenting.—By the process of fermentation the wort is converted into beer. By the action of living yeast cells (see FERMENTATION) the sugar contained in the wort is split up into alcohol and carbonic acid, and a number of subsidiary reactions occur. There are two main systems of fermentation, the *top fermentation system*, which is that employed in the United Kingdom, and the *bottom fermentation system*, which is that used for the production of beers of the continental ("lager") type. The wort, generally at a temperature of about 60° F. (this applies to all the systems excepting B [see below], in which the temperature is higher), is "pitched" with liquid yeast (or "barm," as it is often called) at the rate of, according to the type and strength of the beer to be made, 1 to 4 lb to the barrel. After a few hours a slight froth or scum makes its appearance on the surface of the liquid. At the end of a further short period this develops into a light curly mass (*cauliflower* or *curly head*), which gradually becomes lighter and more solid in appearance, and is then known as *rocky head*. This in its turn shrinks to a compact mass—the *yeasty head*—which emits great bubbles of gas with a hissing sound. At this point the *cleansing* of the beer—i.e. the separation of the yeast from the liquid—has fairly commenced, and it is let down (except in the skimming and Yorkshire systems [see below]) into the *ponchos* or unions, as the case may be. During fermentation the temperature rises considerably, and in order to prevent an excessive temperature being obtained (70–75° F. should be the maximum) the fermenting vessels are fitted with "attemperators," i.e. a system of pipes through which cold water may be run.

Cleansing.—In England the methods of applying the top fermentation system may be classified as follows: (A) *The Cleansing System*: (a) Skimming System, (b) Dropping System (ponchos or ordinary dropping system), (c) Burton Union System. (B) *The Yorkshire Stone Square System*.

(A) In (a) the *Skimming System* the fermentation from start to finish takes place in wooden vessels (termed "squares" or "rounds"), fitted with an attemperator and a parachute or other similar skimming device for removing or "skimming" the yeast at the end of the fermentation (fig. 4). The principle of (b) the *Dropping System* is that the beer undergoes only the main fermenta-

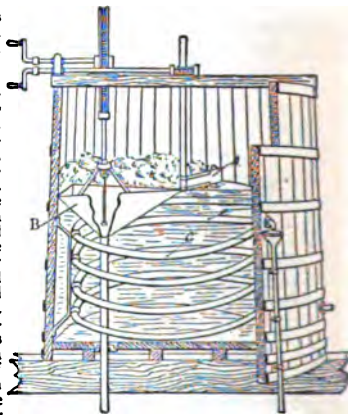

FIG. 4.—Fermenting Round.

A, Skimmer; B, Parachute; C, Attemperator. let down from the "squares" and "rounds" into large vessels, termed dropping or skimming "backs." These are fitted with attemperators, and parachutes for the removal of yeast, in much the same way as in the skimming system. As a rule the parachute covers the whole width of the back. (c) The *Burton Union System* is really an improved poncho system. A series of casks, supplied with beer at the cleansing stage from a feed vessel, are mounted so that they may rotate axially. Each cask is fitted with an attemperator, a pipe and cock at the base for the removal of the finished beer and "bottoms," and lastly with a swan neck fitting through a bung-hole and commanding a common gutter. This system yields excellent results for certain classes of beers, and many Burton brewers think it is essential for obtaining

the Burton character. Fig. 6 (Plate II.) shows the process in operation in Messrs Allsopp's brewery.

(B) *The Stone Square System*, which is only used to a certain extent (exclusively in the north of England), practically consists in pumping the fermenting wort from one to the other of two superimposed square vessels, connected with one another by means of a man-hole and a valve. These squares are built of stone and kept very cool. At the end of the fermentation the yeast (after closing the man-hole) is removed from the top square.

Racking, &c.—After the fermentation and cleansing operations are completed, the beer is racked off (sometimes after passing a few hours in a settling tank) into storage vessels or trade casks. The finest "stock" and "pale" ales are stored for six weeks to three months prior to going out, but "running" beers (mild ales, &c.) are frequently sent out of the brewery within a week or ten days of mashing. It is usual to add some hops in cask (this is called *dry hopping*) in the case of many of the better beers. Running beers, which must be put into condition rapidly, or beers that have become flat, are generally *primed*. Priming consists in adding a small quantity of sugar solution to the beer in cask. This rapidly ferments and so produces "condition."

Fining.—As a very light article is desired nowadays, and this has to be provided in a short time, artificial means must be resorted to, in order to replace the natural fining or brightening which storage brings about. *Fining* generally consist of a solution or semi-solution of isinglass in sour beer, or in a solution of tartaric acid or of sulphurous acid. After the finings are added to the beer and the barrels have been well rolled, the finings slowly precipitate (or work out through the bung-hole) and carry with them the matter which would otherwise render the beer turbid.

Bottling.—Formerly it was the general custom to brew a special beer for bottling, and this practice is still continued by some brewers. It is generally admitted that the special brew, matured by storage and an adequate secondary fermentation, produces the best beer for bottling, but the modern taste for a very light and bright bottled beer at a low cost has necessitated the introduction of new methods. The most interesting among these is the "chilling" and "carbonating" system. In this the beer, when it is ripe for racking, is first "chilled," that is, cooled to a very low temperature. As a result, there is an immediate deposition of much matter which otherwise would require prolonged time to settle. The beer is then filtered and so rendered quite bright, and finally, in order to produce immediate "condition," is "carbonated," i.e. impregnated under pressure with carbon dioxide (carbonic acid gas).

FOREIGN BREWING AND BEERS.—The system of brewing which differs most widely from the English *infusion* and *top fermentation* method is the *decoction* and *bottom fermentation* system, so widely employed, chiefly on the continent of Europe, for the production of beers of the "lager" type.

The method pursued in the decoction system is broadly as follows:—After the grist has been mashed with cold water until a homogeneous mixture ensues, sufficient hot water is introduced into the mash-tun to raise the temperature to 85–100° F., according to circumstances. Thereupon, about one-third of the mash (including the "goods") is transferred to the *Maisch Kessel* (mash copper), in which it is gradually brought to a temperature of (about) 165° F., and this heat is maintained until the mash becomes transparent. The *Dickmaische*, as this portion is called, is then raised to the boil, and the ebullition sustained between a quarter and three-quarters of an hour. Just sufficient of the *Dickmaische* is returned to the mash-tun proper to raise the temperature of the whole to 111–125° F., and after a few minutes a third is again withdrawn and treated as before, to form the second "thick mash." When the latter has been returned to the mash-tun the whole is thoroughly worked up, allowed to stand in order that the solids may deposit, and then another third (called the *Läutermaische* or "clear mash") is withdrawn, boiled until the coagulable albuminoids are precipitated, and finally reconveyed to the mash-tun, where the mashing is continued for some time, the final heat being rather over 160° F. The wort, after boiling with hops and cooling, much as in the English system, is subjected to the peculiar system of fermentation called *bottom fermentation*. In this system the "pitching" and fermentation take place at a very low temperature and, compared with the English system, in very small vessels. The fermenting cellars are maintained at a temperature of about 37–38° F., and the temperature of the fermenting wort does not rise above 50° F. The yeast, which is of a different type from that employed in the English system, remains at the bottom of the fermenting tun, and hence is derived the name of "bottom

fermentation" (see FERMENTATION). The primary fermentation lasts about eleven to twelve days (as compared with three days on the English system), and the beer is then run into store (lager) casks where it remains at a temperature approaching the freezing-point of water for six weeks to six months, according to the time of the year and the class of the beer. As to the relative character and stability of decoction and infusion beers, the latter are, as a rule, more alcoholic; but the former contain more unfermented malt extract, and are therefore, broadly speaking, more nutritive. Beers of the German type are less heavily hopped and more peptonized than English beers, and more highly charged with carbonic acid, which, owing to the low fermentation and storing temperatures, is retained for a comparatively long time and keeps the beer in condition. On the other hand, infusion beers are of a more stable and stimulating character. It is impossible to keep "lager" beer on draught in the ordinary sense of the term in England. It will not keep unless placed on ice, and, as a matter of fact, the "condition" of lager is dependent to a far greater extent on the methods of distribution and storage than is the case with infusion beers. If a cask is opened it must be rapidly consumed; indeed it becomes undrinkable within a very few hours. The gas escapes rapidly when the pressure is released, the temperature rises, and the beer becomes flat and mawkish. In Germany every publican is bound to have an efficient supply of ice, the latter frequently being delivered by the brewery together with the beer.

In America the common system of brewing is one of infusion mashing combined with bottom fermentation. The method of mashing, however, though on infusion lines, differs appreciably from the English process. A very low initial heat—about 100° F.—at which the mash remains for about an hour, is employed. After this the temperature is rapidly raised to 153–156° F. by running in the boiling "cooker mash," i.e. raw grain wort from the converter. After a period the temperature is gradually increased to about 165° F. The very low initial heat, and the employment of relatively large quantities of readily transformable malt adjuncts, enable the American brewer to make use of a class of malt which would be considered quite unfit for brewing in an English brewery. The system of fermentation is very similar to the continental "lager" system, and the beer obtained bears some resemblance to the German product. To the English' palate it is somewhat flavourless, but it is always retailed in exceedingly brilliant condition and at a proper temperature. There can be little doubt that every nation evolves a type of beer most suited to its climate and the temperament of the people, and in this respect the modern American beer is no exception. In regard to plant and mechanical arrangements generally, the modern American breweries may serve as an object-lesson to the European brewer, although there are certainly a number of breweries in the United Kingdom which need not fear comparison with the best American plants.

It is a sign of the times and further evidence as to the growing taste for a lighter type of beer, that lager brewing in its most modern form has now fairly taken root in Great Britain, and in this connexion the process introduced by Messrs Allsopp exhibits many features of interest. The following is a brief description of the plant and the methods employed:—The wort is prepared on infusion lines, and is then cooled by means of refrigerated brine before passing to a temporary store tank, which serves as a gauging vessel. From the latter the wort passes directly to the fermenting tuns, huge closed cylindrical vessels made of sheet-steel and coated with glass enamel. There the wort ferments under reduced pressure, the carbonic acid generated being removed by means of a vacuum pump, and the gas thus withdrawn is replaced by the introduction of cool sterilized air. The fermenting cellars are kept at 40° F. The yeast employed is a pure culture (see FERMENTATION) bottom yeast, but the withdrawal of the products of yeast metabolism and the constant supply of pure fresh air cause the fermentation to proceed far more rapidly than is the case with lager beer brewed on ordinary lines. It is, in fact, finished in about six days. Thereupon the air-supply is cut off, the green beer again cooled to 40° F. and

then conveyed by means of filtered air pressure to the store tanks, where secondary fermentation, lasting three weeks, takes place. The gases evolved are allowed to collect under pressure, so that the beer is thoroughly charged with the carbonic acid necessary to give it condition. Finally the beer is again cooled, filtered, raked and bottled, the whole of these operations taking place under counter pressure, so that no gas can escape; indeed, from the time the wort leaves the copper to the moment when it is bottled in the shape of beer, it does not come into contact with the outer air.

The preparation of the Japanese beer *saké* (*q.v.*) is of interest. The first stage consists in the preparation of *Koji*, which is obtained by treating steamed rice with a culture of *Aspergillus oryzae*. This micro-organism converts the starch into sugar. The *Koji* is converted into *moto* by adding it to a thin paste of fresh-boiled starch in a vat. Fermentation is set up and lasts for 30 to 40 days. The third stage consists in adding more rice and *Koji* to the *moto*, together with some water. A secondary fermentation, lasting from 8 to 10 days, ensues. Subsequently the whole is filtered, heated and run into casks, and is then known as *saké*. The interest of this process consists in the fact that a single micro-organism—a mould—is able to exercise the combined functions of saccharification and fermentation. It replaces the diastase of malted grain and also the yeast of a European brewery. Another liquid of interest is *Weissbier*. This, which is largely produced in Berlin (and in some respects resembles the *wheat-beer* produced in parts of England), is generally prepared from a mash of three parts of wheat malt and one part of barley malt. The fermentation is of a symbiotic nature, two organisms, namely a yeast and a fission fungus (the *lactic acid bacillus*) taking part in it. The preparation of this peculiar double ferment is assisted by the addition of a certain quantity of white wine to the yeast prior to fermentation.

BREWING CHEMISTRY.—The principles of brewing technology belong for the most part to physiological chemistry, whilst those of the cognate industry, malting, are governed exclusively by that branch of knowledge. Alike in following the growth of barley in field, its harvesting, maturing and conversion into malt, as well as the operations of mashing malt, fermenting wort, and conditioning beer, physiological chemistry is needed. On the other hand, the consideration of the saline matter in waters, the composition of the extract of worts and beers, and the analysis of brewing materials and products generally, belong to the domain of pure chemistry. Since the extractive matters contained in wort and beer consist for the most part of the transformation products of starch, it is only natural that these should have received special attention at the hands of scientific men associated with the brewing industry. It was formerly believed that by the action of diastase on starch the latter is first converted into a gummy substance termed dextrin, which is then subsequently transformed into a sugar—glucose. F. A. Musculus, however, in 1860, showed that sugar and dextrin are simultaneously produced, and between the years 1872 and 1876 Cornelius O'Sullivan definitely proved that the sugar produced was maltose. When starch-paste, the jelly formed by treating starch with boiling water, is mixed with iodine solution, a deep blue coloration results. The first product of starch degradation by either acids or diastase, namely soluble starch, also exhibits the same coloration when treated with iodine. As degradation proceeds, and the products become more and more soluble and diffusible, the blue reaction with iodine gives place first to a purple, then to a reddish colour, and finally the coloration ceases altogether. In the same way, the optical rotating power decreases, and the cupric reducing power (towards Fehling's solution) increases, as the process of hydrolysis proceeds. C. O'Sullivan was the first to point out definitely the influence of the temperature of the mash on the character of the products. The work of Horace T. Brown (with J. Heron) extended that of O'Sullivan, and (with G. H. Morris) established the presence of an intermediate product between the higher dextrans and maltose. This product was termed maltodextrin, and Brown and Morris were led to believe that a large number of these sub-

stances existed in malt wort. They proposed for these substances the generic name "amyloins." Although according to their view they were compounds of maltose and dextrin, they had the properties of mixtures of these two substances. On the assumption of the existence of these compounds, Brown and his colleagues formulated what is known as the maltodextrin or amyloin hypothesis of starch degradation. C. J. Lintner, in 1891, claimed to have separated a sugar, isomeric with maltose, which is termed isomaltose, from the products of starch hydrolysis. A. R. Ling and J. L. Baker, as well as Brown and Morris, in 1895, proved that this isomaltose was not a homogeneous substance, and evidence tending to the same conclusion was subsequently brought forward by continental workers. Ling and Baker, in 1897, isolated the following compounds from the products of starch hydrolysis—maltodextrin- α , $C_{48}H_{96}O_{48}$, and maltodextrin- β , $C_{54}H_{108}O_{54}$ (previously named by Prior, achrodextrin III.). They also separated a substance, $C_{12}H_{24}O_{12}$, isomeric with maltose, which had, however, the characteristics of a dextrin. This is probably identical with the so-called dextrinose isolated by V. Snyewski in 1902, which yields a phenyllosazone melting at 82-83° C. It has been proved by H. Ost that the so-called isomaltose of Lintner is a mixture of maltose and another substance, maltodextrin, isomeric with Ling and Baker's maltodextrin- β .

The theory of Brown and Morris of the degradation of starch, although based on experimental evidence of some weight, is by no means universally accepted. Nevertheless it is of considerable interest, as it offers a rational and consistent explanation of the phenomena known to accompany the transformation of starch by diastase, and even if not strictly correct it has, at any rate, proved itself to be a practical working hypothesis, by which the mashing and fermenting operations may be regulated and controlled. According to Brown and Morris, the starch molecule consists of five amylin groups, each of which corresponds to the molecular formula $(C_{24}H_{48}O_{24})_n$. Four of these amylin radicles are grouped centrally round the fifth, thus—



By the action of diastase, this complex molecule is split up, undergoing hydrolysis into four groups of amyloins, the fifth or central group remaining unchanged (and under brewing conditions unchangeable), forming the substance known as stable dextrin. When diastase acts on starch-paste, hydrolysis proceeds as far as the reaction represented by the following equation:—

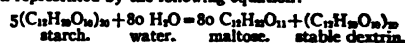

The amyloins are substances containing varying numbers of amylin (original starch or dextrin) groups in conjunction with a proportional number of maltose groups. They are not separable into maltose and dextrin by any of the ordinary means, but exhibit the properties of mixtures of these substances. As the process of hydrolysis proceeds, the amyloins become gradually poorer in amyloin and relatively richer in maltose-groups. The final products of transformation, according to Brown and J. H. Millar, are maltose and glucose, which latter is derived from the hydrolysis of the stable dextrin. This theory may be applied in practical brewing in the following manner. If it is desired to obtain a beer of a stable character—that is to say, one containing a considerable proportion of high-type amyloins—it is necessary to restrict the action of the diastase in the mash-tun accordingly. On the other hand, for mild running ales, which are to "condition" rapidly, it is necessary to provide for the presence of sufficient maltodextrin of a low type. Investigation has shown that the type of maltodextrin can be regulated, not only in the mash-tun but also on the malt-kiln. A higher type is obtained by low kiln and high mashing temperatures than by high kiln and low mashing heats, and it is possible therefore to regulate, on scientific lines, not only the quality but also the type of amyloins which are suitable for a particular beer.

The chemistry of the nitrogenous constituents of malt is equally important with that of starch and its transformations. Without nitrogenous compounds of the proper type, vigorous fermentations are not possible. It may be remembered that yeast and other nitrogenous compounds in some of their simpler forms—acids and the like. One of the aims of the malter is therefore, to break down the protein substances present in barley to such a degree that the wort has a maximum nutritive value for the yeast. Further, it is necessary for the production of stable beer to eliminate a large proportion of nitrogenous matter, and this is only done by the yeast when the proteins are degraded. There is also some evidence that the presence of albumoses assists in producing the foaming properties of beer. It has now been established definitely, by the work of

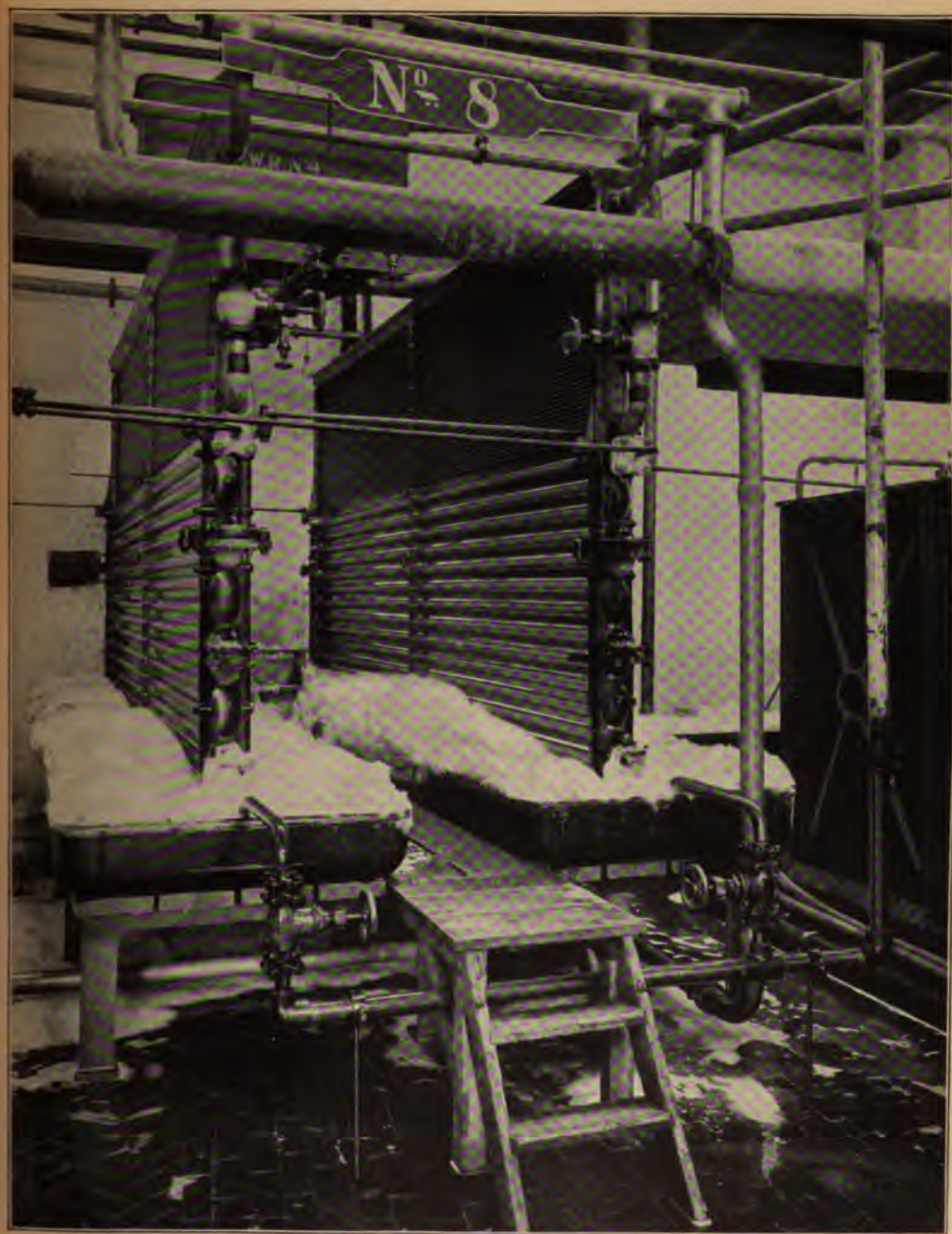

Fig. 5.—Refrigerators in "Lager" Brewery of Messrs. Allsopp.
The hot wort trickles over the outside of the series of pipes, and is cooled by the cold water which circulates in them. From the shallow collecting trays the cooled wort is conducted to the fermenting backs.



Fig. 6.—Burton-Union System of Cleansing. (Mears, Allsopp's Brewery.)

The green beer is filled into the casks, and the excess of yeast, &c., then works out through the swan necks into the long common gutter shown.

A. Fernbach, W. Windisch, F. Weiss and P. Schidrowitz, that finished malt contains at least two proteolytic enzymes (a peptic and a pancreatic enzyme).

The presence of different types of phosphates in malt, and the important influence which, according to their nature, they exercise in the brewing process by way of the enzymes affected by them, have been made the subject of research mainly by Fernbach and A. Hubert, and by P. E. Petit and G. Labourasse. The number of enzymes which are now known to take part in the brewing process is very large. They may with utility be grouped as follows:—

	N. me.	Rôle or Nature.
In the malt or mash-tun.	Cytase	Dissolves cell walls of starch granules.
	Diastase A	Liquefies starch.
	Diastase B	Saccharifies starch.
	Proteolytic Enzymes } (1) Peptic. (2) Pancreatic.	
In fermenting wort and yeast.	Catalase	Splits peroxide.
	Invertase	Inverts cane sugar.
	Glucose	Splits maltose into glucose.
	Zymase	Splits sugar into alcohol and carbonic acid.

BIBLIOGRAPHY.—W. J. Sykes, *Principles and Practice of Brewing* (London, 1897); Moritz and Morris, *A Text-book of the Science of Brewing* (London, 1891); H. E. Wright, *A Handy Book for Brewers* (London, 1897); Frank Thatcher, *Brewing and Malting* (London, 1898); Julian L. Baker, *The Brewing Industry* (London, 1905); E. J. Lintner, *Grundriss der Bierbrauerei* (Berlin, 1904); J. E. Thausing, *Die Theorie und Praxis der Malzbereitung und Bierfabrikation* (Leipzig, 1898); E. Michel, *Lehrbuch der Bierbrauerei* (Augsburg, 1900); E. Prior, *Chemie u. Physiologie des Malzes und des Bieres* (Leipzig, 1896). Technical journals: *The Journal of the Institute of Brewing* (London); *The Brewing Trade Review* (London); *The Brewer's Journal* (London); *The Brewer's Journal* (New York); *Wochenchrift für Brauerei* (Berlin); *Zeitschrift für das gesammte Brauwesen* (Munich). (P. S.)

BREWSTER, SIR DAVID (1781–1868), Scottish natural philosopher, was born on the 11th of December 1781 at Jedburgh, where his father, a teacher of high reputation, was rector of the grammar school. At the early age of twelve he was sent to the university of Edinburgh, being intended for the clerical profession. Even before this, however, he had shown a strong inclination for natural science, and this had been fostered by his intimacy with a "self-taught philosopher, astronomer and mathematician," as Sir Walter Scott called him, of great local fame—James Veitch of Inchbonny, who was particularly skilful in making telescopes. Though he duly finished his theological course and was licensed to preach, Brewster's preference for other pursuits prevented him from engaging in the active duties of his profession. In 1799 he was induced by his fellow-student, Henry Brougham, to study the diffraction of light. The results of his investigations were communicated from time to time in papers to the *Philosophical Transactions* of London and other scientific journals, and were admirably and impartially summarized by James D. Forbes in his preliminary dissertation to the eighth edition of the *Encyclopaedia Britannica*. The fact that other philosophers, notably Etienne Louis Malus and Augustin Fresnel, were pursuing the same investigations contemporaneously in France does not invalidate Brewster's claim to independent discovery, even though in one or two cases the priority must be assigned to others.

The most important subjects of his inquiries are enumerated by Forbes under the following five heads:—(1) The laws of polarization by reflection and refraction, and other quantitative laws of phenomena; (2) The discovery of the polarizing structure induced by heat and pressure; (3) The discovery of crystals with two axes of double refraction, and many of the laws of their phenomena, including the connexion of optical structure and crystalline forms; (4) The laws of metallic reflection; (5) Experiments on the absorption of light. In this line of investigation the prime importance belongs to the discovery (1) of the connexion between the refractive index and the polarizing angle, (2) of biaxial crystals, and (3) of the production of double refraction by irregular heating. These discoveries were promptly recognized. So early as the year 1807 the degree of LL.D. was conferred upon Brewster by Marischal College, Aberdeen; in 1815 he was made a member of the Royal Society of London, and received the Copley medal; in 1818 he received the Rumford

medal of the society; and in 1816 the French Institute awarded him one-half of the prize of three thousand francs for the two most important discoveries in physical science made in Europe during the two preceding years. Among the non-scientific public his fame was spread more effectually by his rediscovery about 1815 of the kaleidoscope, for which there was a great demand in both England and America. An instrument of higher interest, the stereoscope, which, though of much later date (1849–1850), may be mentioned here, since along with the kaleidoscope it did more than anything else to popularize his name, was not, as has often been asserted, the invention of Brewster. Sir Charles Wheatstone discovered its principle and applied it as early as 1838 to the construction of a cumbersome but effective instrument, in which the binocular pictures were made to combine by means of mirrors. To Brewster is due the merit of suggesting the use of lenses for the purpose of uniting the dissimilar pictures; and accordingly the lenticular stereoscope may fairly be said to be his invention. A much more valuable practical result of Brewster's optical researches was the improvement of the British lighthouse system. It is true that the dioptric apparatus was perfected independently by Fresnel, who had also the satisfaction of being the first to put it into operation. But it is indisputable that Brewster was earlier in the field than Fresnel; that he described the dioptric apparatus in 1812; that he pressed its adoption on those in authority at least as early as 1820, two years before Fresnel suggested it; and that it was finally introduced into British lighthouses mainly by his persistent efforts.

Brewster's own discoveries, important though they were, were not his only, perhaps not even his chief, service to science. He began literary work in 1799 as a regular contributor to the *Edinburgh Magazine*, of which he acted as editor at the age of twenty. In 1807 he undertook the editorship of the newly projected *Edinburgh Encyclopaedia*, of which the first part appeared in 1808, and the last not until 1830. The work was strongest in the scientific department, and many of its most valuable articles were from the pen of the editor. At a later period he was one of the leading contributors to the *Encyclopaedia Britannica* (seventh and eighth editions), the articles on Electricity, Hydrodynamics, Magnetism, Microscope, Optics, Stereoscope, Voltaic Electricity, &c., being from his pen. In 1810 Brewster undertook further editorial work by establishing, in conjunction with Robert Jameson (1774–1854), the *Edinburgh Philosophical Journal*, which took the place of the *Edinburgh Magazine*. The first ten volumes (1819–1824) were published under the joint editorship of Brewster and Jameson, the remaining four volumes (1825–1826) being edited by Jameson alone. After parting company with Jameson, Brewster started the *Edinburgh Journal of Science* in 1824, sixteen volumes of which appeared under his editorship during the years 1824–1832, with very many articles from his own pen. To the transactions of various learned societies he contributed from first to last between three and four hundred papers, and few of his contemporaries wrote so much for the various reviews. In the *North British Review* alone seventy-five articles of his appeared. A list of his larger separate works will be found below. Special mention, however, must be made of the most important of them all—his biography of Sir Isaac Newton. In 1831 he published a short popular account of the philosopher's life in Murray's *Family Library*; but it was not until 1855 that he was able to issue the much fuller *Memoirs of the Life, Writings and Discoveries of Sir Isaac Newton*, a work which embodied the results of more than twenty years' patient investigation of original manuscripts and all other available sources.

Brewster's relations as editor brought him into frequent communication with the most eminent scientific men, and he was naturally among the first to recognize the benefit that would accrue from regular intercourse among workers in the field of science. In an article in the *Quarterly Review* he threw out a suggestion for "an association of our nobility, clergy, gentry and philosophers," which was taken up by others and found speedy realization in the British Association for the Advancement of

Science. Its first meeting was held at York in 1831; and Brewster, along with Charles Babbage and Sir John F. W. Herschel, had the chief part in shaping its constitution. In the same year in which the British Association held its first meeting, Brewster received the honour of knighthood and the decoration of the Guelphic order of Hanover. In 1838 he was appointed principal of the united colleges of St Salvator and St Leonard, St Andrews. In 1849 he acted as president of the British Association and was elected one of the eight foreign associates of the Institute of France in succession to J. J. Berzelius; and ten years later he accepted the office of principal of the university of Edinburgh, the duties of which he discharged until within a few months of his death, which took place at Allerly, Melrose, on the 10th of February 1868.

In estimating Brewster's place among scientific discoverers the chief thing to be borne in mind is that the bent of his genius was not characteristically mathematical. His method was empirical, and the laws which he established were generally the result of repeated experiment. To the ultimate explanation of the phenomena with which he dealt he contributed nothing, and it is noteworthy in this connexion that if he did not maintain to the end of his life the corpuscular theory he never explicitly adopted the undulatory theory of light. Few will be inclined to dispute the verdict of Forbes:—"His scientific glory is different in kind from that of Young and Fresnel; but the discoverer of the law of polarization of biaxial crystals, of optical mineralogy, and of double refraction by compression, will always occupy a foremost rank in the intellectual history of the age." In addition to the various works of Brewster already noticed, the following may be mentioned:—Notes and Introduction to Carlyle's translation of Legendre's *Elements of Geometry* (1824); *Treatise on Optics* (1831); *Letters on Natural Magic*, addressed to Sir Walter Scott (1831); *The Martyrs of Science, or the Lives of Galileo, Tycho Brahe, and Kepler* (1841); *More Worlds than One* (1854).

See *The Home Life of Sir David Brewster*, by his daughter Mrs Gordon.

BREWSTER, WILLIAM (c. 1566–1644), American colonist, one of the leaders of the "Pilgrims," was born at Scrooby, in Nottinghamshire, England, about 1566. After studying for a short time at Cambridge, he was from 1584 to 1587 in the service of William Davison (? 1541–1608), who in 1585 went to the Low Countries to negotiate an alliance with the states-general and in 1586 became assistant to Walsingham, Queen Elizabeth's secretary of state. Upon the disgrace of Davison, Brewster removed to Scrooby, where from 1590 until September 1607 he held the position of "Post," or postmaster responsible for the relays of horses on the post road, having previously, for a short time, assisted his father in that office. About 1602 his neighbours began to assemble for worship at his home, the Scrooby manor house, and in 1606 he joined them in organizing the Separatist church of Scrooby. After an unsuccessful attempt in 1607 (for which he was imprisoned for a short time), he, with other Separatists, removed to Holland in 1608 to obtain greater freedom of worship. At Leiden in 1609 he was chosen ruling elder of the Congregation. In Holland he supported himself first by teaching English and afterwards in 1616–1619, as the partner of one Thomas Brewer, by secretly printing, for sale in England, books proscribed by the English government, thus, says Bradford, having "employment enough." In 1619 their types were seized and Brewer was arrested by the authorities of the university of Leiden, acting on the instance of the British ambassador, Sir Dudley Carleton. Brewster, however, escaped, and in the same year, with Robert Cushman (c. 1580–1625), obtained in London, on behalf of his associates, a land patent from the Virginia Company. In 1620 he emigrated to America on the "Mayflower," and was one of the founders of the Plymouth Colony. Here besides continuing until his death to act as ruling elder, he was also—regularly until the arrival of the first pastor, Ralph Smith (d. 1661), in 1629 and irregularly afterward—a "teacher," preaching "both powerfully and profitably to ye great contentment of ye hearers and their comfortable edification."

By many he is regarded as pre-eminently the leader of the "Pilgrims." He died, probably on the 10th of April 1644.

See Ashbel Steele's *Chief of the Pilgrims; or the Life and Time of William Brewster* (Philadelphia, 1857); and a sketch in William Bradford's *History of the Plymouth Plantation* (new ed., Boston, 1898).

BRÉZÉ, the name of a noble Angevin family, the most famous member of which was PIERRE DE BRÉZÉ (c. 1410–1465), one of the trusted soldiers and statesmen of Charles VII. He had made his name as a soldier in the English wars when in 1433 he joined with Yolande, queen of Sicily, the constable Richmond and others, in chasing from power Charles VII.'s minister La Trémoille. He was knighted by Charles of Anjou in 1434, and presently entered the royal council. In 1437 he became seneschal of Anjou, and in 1440 of Poitou. During the Praguerie he rendered great service to the royal cause against the dauphin Louis and the revolted nobles, a service which was remembered against him after Louis's accession to the throne. He fought against the English in Normandy in 1440–1441, and in Guicenne in 1442. In the next year he became chamberlain to Charles VII., and gained the chief power in the state through the influence of Agnes Sorel, superseding his early allies Richmond and Charles of Anjou. The six years (1444–1450) of his ascendancy were the most prosperous period of the reign of Charles VII. His most dangerous opponent was the dauphin Louis, who in 1448 brought against him accusations which led to a formal trial resulting in a complete exoneration of Brézé and his restoration to favour. He fought in Normandy in 1450–1451, and became seneschal of the province after the death of Agnes Sorel and the consequent decline of his influence at court. He made an ineffective descent on the English coast at Sandwich in 1457, and was preparing an expedition in favour of Margaret of Anjou when the accession of Louis XI. brought him disgrace and a short imprisonment. In 1462, however, his son Jacques married Louis's half-sister, Charlotte de Valois, daughter of Agnes Sorel. In 1462 he accompanied Margaret to Scotland with a force of 2000 men, and after the battle of Hexham he brought her back to Flanders. On his return he was reappointed seneschal of Normandy, and fell in the battle of Montlithéry on the 16th of July 1465. He was succeeded as seneschal of Normandy by his eldest son Jacques de Brézé (c. 1440–1490), count of Maulévrier; and by his grandson, husband of the famous Diane de Poitiers, Louis de Brézé (d. 1531), whose tomb in Rouen cathedral, attributed to Jean Goujon and Jean Cousin, is a splendid example of French Renaissance work.

The lordship of Brézé passed eventually to Claire Clémence de Maillé, princess of Condé, by whom it was sold to Thomas Dreux, who took the name of Dreux Brézé, when it was erected into a marquisate. HENRI EVRAUD, marquis de Dreux-Brézé (1762–1820), succeeded his father as master of the ceremonies to Louis XVI. in 1781. On the meeting of the states-general in 1789 it fell to him to regulate the questions of etiquette and precedence between the three estates. That as the immediate representative of the crown he should wound the susceptibilities of the deputies was perhaps inevitable, but little attempt was made to adapt traditional etiquette to changed circumstances. Brézé did not formally intimate to President Bailly the proclamation of the royal séance until the 20th of June, when the carpenters were about to enter the hall to prepare for the event, thus provoking the session in the tennis court. After the royal séance Brézé was sent to reiterate Louis's orders that the estates should meet separately, when Mirabeau replied that the hall could not be cleared except by force. After the fall of the Tuileries Brézé emigrated for a short time, but though he returned to France he was spared during the Terror. At the Restoration he was made a peer of France, and resumed his functions as guardian of an antiquated ceremonial. He died on the 17th of January 1820, when he was succeeded in the peerage and at court by his son Scipion (1793–1845).

The best contemporary account of Pierre de Brézé is given in the *Chroniques* of the Burgundian chronicler, Georges Chastellain, who had been his secretary. Chastellain addressed a *Déploration* to Louis XI. on his behalf at the time of his disgrace.

BRIALMONT, HENRI ALEXIS (1821-1903), Belgian general and military engineer, son of General Laurent Mathieu Brialmont (d. 1885), was born at Venlo in Limburg on the 25th of May 1821. Educated at the Brussels military school, he entered the army as sub-lieutenant of engineers in 1843, and became lieutenant in 1847. From 1847 to 1850 he was private secretary to the war minister, General Baron Chazal. In 1855 he entered the staff corps, became major in 1861, lieutenant-colonel 1864, colonel in 1868 and major-general 1874. In this rank he held at first the position of director of fortifications in the Antwerp district (December 1874), and nine months later he became inspector-general of fortifications and of the corps of engineers. In 1877 he became lieutenant-general. His far-reaching schemes for the fortification of the Belgian places met with no little opposition, and Brialmont seems to have felt much disappointment in this; at any rate he went in 1883 to Rumania to advise as to the fortification works required for the defence of the country, and presided over the elaboration of the scheme by which Bucharest was to be made a first-class fortress. He was thereupon placed *ex disponibilitate* in his own service, as having undertaken the Bucharest works without the authorization of his sovereign. This was due in part to the suggestion of Austria, which power regarded the Bucharest works as a menace to herself. His services were, however, too valuable to be lost, and on his return to Belgium in 1884 he resumed his command of the Antwerp military district. He had, further, while in eastern Europe, prepared at the request of the Hellenic government, a scheme for the defence of Greece. He retired in 1886, but continued to supervise the Rumanian defences. He died on the 21st of September 1903.

In the first stage of his career as an engineer Brialmont's plans followed with but slight modification the ideas of Vauban, and his original scheme for fortifying Antwerp provided for both enceinte and forts being on a bastioned trace. But in 1859, when the great entrenched camp at Antwerp was finally taken in hand, he had already gone over to the school of polygonal fortification and the ideas of Montalembert. About twenty years later Brialmont's own types and plans began to stand out amidst the general confusion of ideas on fortification which naturally resulted from the introduction of long-range guns, and from the events of 1870-71. The extreme detached forts of the Antwerp region and the fortifications on the Meuse at Liège and Namur were constructed in accordance with Brialmont's final principles, viz. the lavish use of armour to protect the artillery inside the forts, the suppression of all artillery positions open to overhead fire, and the multiplication of intermediate batteries (see FORTIFICATION AND SIEGE-CRAFT). In his capacity of inspector-general Brialmont drafted and carried out the whole scheme for the defences of Belgium. He was an indefatigable writer, and produced, besides essays, reviews and other papers in the journals, twenty-three important works and forty-nine pamphlets. In 1850 he originated the *Journal de l'armée Belge*. His most important publications were *La Fortification du temps présent* (Brussels, 1885); *Influence du tir plongeant et des obus-torpilles sur la fortification* (Brussels, 1888); *Les Régions fortifiées* (Brussels, 1890); *La Défense des États et la fortification à la fin du XIX^e siècle* (Brussels, 1895); *Progrès de la défense des États et de la fortification permanente depuis Vauban* (Brussels, 1898).

BRIAN (926-1014), king of Ireland, known as BRIAN BORU, BOROMA, or BOROIMHE (from *boroma*, an Irish word for tribute), was a son of a certain Kennedy or Cenneide (d. 951). He passed his youth in fighting against the Danes, who were constantly ravaging Munster, the northern part of which district was the home of Brian's tribe, and won much fame in these encounters. In 976 his brother, Mathgamhain or Mahon, who had become king of Thomond about 951 and afterwards king of Munster, was murdered; Brian avenged this deed, became himself king of Munster in 978, and set out upon his career of conquest. He forced the tribes of Munster and then those of Leinster to own his sovereignty, defeated the Danes, who were established around Dublin, in Wicklow, and marched into

Dublin, and after several reverses compelled Malachy (Maelsechlainn), the chief king of Ireland, who ruled in Meath, to bow before him in 1002. Connaught was his next objective. Here and also in Ulster he was successful, everywhere he received hostages and tribute, and he was generally recognised as the *ardri*, or chief king of Ireland. After a period of comparative quiet Brian was again at war with the Danes of Dublin; and on the 23rd of April 1014 his forces gained a great victory over them at Clontarf. After this battle, however, the old king was slain in his tent, and was buried at Armagh. Brian has enjoyed a great and not undeserved reputation. One of his charters is still preserved in Trinity College, Dublin.

See E. A. D'Alton, *History of Ireland*, vol. i. (1903).

BRIANÇON, a strongly fortified town in the department of Hautes-Alpes in S.E. France. It is built at a height of 4334 ft. on a plateau which dominates the junction of the Durance with the Guisane. The town itself is formed of very steep and narrow, though picturesque streets. As it lies at the foot of the descent from the Mont Genève Pass, giving access to Turin, a great number of fortifications have been constructed on the heights around Briançon, especially towards the east. The Fort Janus is no less than 4000 ft. above the town. The parish church, with its two towers, was built 1703-1726, and occupies a very conspicuous position. The Pont d'Asfeld, E. of the town, was built in 1734, and forms an arch of 131 ft. span, thrown at a height of 184 ft. across the Durance. The modern town extends in the plain at the S.W. foot of the plateau on which the old town is built and forms the suburb of Ste Catherine, with the railway station, and an important silk-weaving factory. Briançon is 51½ m. by rail from Gap. The commune had a civil population in 1906 of 4883 (urban population 3130), while the permanent garrison was 2641—in all 7524 inhabitants.

Briançon was the *Brigantium* of the Romans and formed part of the kingdom of King Cottius. About 1040 it came into the hands of the counts of Albon (later dauphins of the Viennois) and thenceforth shared the fate of the Dauphiné. The Briançonnais included not merely the upper valley of the Durance (with those of its affluents, the Gyrondie and the Guil), but also the valley of the Dora Riparia (Césanne, Oulx, Bardonnèche and Exilles), and that of the Chisone (Fénetrelles, Pérouse, Pragelas)—these glens all lying on the eastern slope of the chain of the Alps. But by the treaty of Utrecht (1713) all these valleys were handed over to Savoy in exchange for that of Barcelonnette, on the west slope of the Alps. In 1815 Briançon successfully withstood a siege of three months at the hands of the Allies, a feat which is commemorated by an inscription on one of its gates, *Le passé répond de l'avenir*. (W. A. B. C.)

BRIAND, ARISTIDE (1862-), French statesman, was born at Nantes, of a bourgeois family. He studied law, and while still young took to politics, associating himself with the most advanced movements, writing articles for the anarchist journal *Le Peuple*, and directing the *Lanterne* for some time. From this he passed to the *Petite République*, leaving it to found, with Jean Jaurès, *L'Humanité*. At the same time he was prominent in the movement for the formation of labour unions, and at the congress of working men at Nantes in 1894 he secured the adoption of the labour union idea against the adherents of Jules Guesde. From that time, Briand became one of the leaders of the French Socialist party. In 1902, after several unsuccessful attempts, he was elected deputy. He declared himself a strong partisan of the union of the Left in what is known as the *Bloc*, in order to check the reactionary deputies of the Right. From the beginning of his career in the chamber of deputies, Briand was occupied with the question of the separation of church and state. He was appointed reporter of the commission charged with the preparation of the law, and his masterly report at once marked him out as one of the coming leaders. He succeeded in carrying his project through with but slight modifications, and without dividing the parties upon whose support he relied. He was the principal author of the law of separation, but, not content with preparing it, he wished to apply it as well, especially as the existing Rouvier

ministry allowed disturbances to occur during the taking of inventories of church property, a clause of the law for which Briand was not responsible. Consequently he accepted the portfolio of public instruction and worship in the Sarrien ministry (1906). So far as the chamber was concerned his success was complete. But the acceptance of a portfolio in a bourgeois ministry led to his exclusion from the Unified Socialist party (March 1906). As opposed to Jaurès, he contended that the Socialists should co-operate actively with the Radicals in all matters of reform, and not stand aloof to await the complete fulfilment of their ideals.

BRIANZA, a district of Lombardy, Italy, forming the south part of the province of Como, between the two southern arms of the lake of that name. It is thickly populated and remarkable for its fertility; and being hilly is a favourite summer resort of the Milanese.

BRIARE, a town of north-central France in the department of Loiret on the right bank of the Loire, 45½ m. S.E. of Orléans on the railway to Nevers. Pop. (1906) 4613. Briare, the *Briodorum* of the Romans, is situated at the extremity of the Canal of Briare, which unites the Loire and its lateral canal with the Loing and so with the Seine. The canal of Briare was constructed from 1605 to 1642 and is about 36 m. long. The industries include the manufacture of fine pottery, and of so-called porcelain buttons made of felspar and milk by a special process; its inventor, Bapterosses, has a bust in the town. The canal traffic is in wood, iron, coal, building materials, &c. A modern hospital and church, and the hôtel de ville installed in an old moated château, are the chief buildings. The lateral canal of the Loire crosses the Loire near Briare by a fine canal-bridge 720 yds. in length.

BRIAREUS, or **ARGÆON**, in Greek mythology, one of the three hundred-armed, fifty-headed Hecatoncheires, brother of Cottus and Gyges (or Gyes). According to Homer (*Iliad* i. 403) he was called Argæon by men, and Briareus by the gods. He was the son of Poseidon (or Uranus) and Gaea. The legends regarding him and his brothers are various and somewhat contradictory. According to the most widely spread myth, Briareus and his brothers were called by Zeus to his assistance when the Titans were making war upon Olympus. The gigantic enemies were defeated and consigned to Tartarus, at the gates of which the three brothers were placed (Hesiod, *Theog.* 624, 630, 714). Other accounts make Briareus one of the assailants of Olympus, who, after his defeat, was buried under Mount Aetna (Callimachus, *Hymn to Delos*, 141). Homer mentions him as assisting Zeus when the other Olympian deities were plotting against the king of gods and men (*Iliad* i. 398). Another tradition makes him a giant of the sea, ruler of the fabulous Aegæa in Euboea, an enemy of Poseidon and the inventor of warships (Schol. on Apoll. Rhod. i. 1165). It would be difficult to determine exactly what natural phenomena are symbolized by the Hecatoncheires. They may represent the gigantic forces of nature which appear in earthquakes and other convulsions, or the multitudinous motion of the sea-waves (Mayer, *Die Giganten und Titanen*, 1887).

BRIBERY (from the O. Fr. *briberie*, begging or vagrancy, *bribe*, Mid. Lat. *bribo*, signifying a piece of bread given to beggars; the Eng. "bribe" has passed through the meanings of alms, blackmail and extortion, to gifts received or given in order to influence corruptly). The public offence of bribery may be defined as the offering or giving of payment in some shape or form that it may be a motive in the performance of functions for which the proper motive ought to be a conscientious sense of duty. When this is superseded by the sordid impulses created by the bribe, a person is said to be corrupted, and thus corruption is a term sometimes held equivalent to bribery. The offence may be divided into two great classes—the one where a person invested with power is induced by payment to use it unjustly; the other, where power is obtained by purchasing the suffrages of those who can impart it. It is a natural propensity, removable only by civilization or some powerful counteracting influence, to feel that every element of power is to be employed as much as

possible for the owner's own behoof, and that its benefits should be conferred not on those who best deserve them, but on those who will pay most for them. Hence judicial corruption is an inveterate vice of imperfect civilization. There is, perhaps no other crime on which the force of law, if unaided by public opinion and morals, can have so little influence; for in other crimes, such as violence or fraud, there is generally some person immediately injured by the act, who can give his aid in the detection of the offender, but in the perpetration of the offence of bribery all the immediate parties obtain what they desire, and are satisfied.

The purification of the bench from judicial bribery has been gradual in most of the European countries. In France it received an impulse in the 16th century from the high-minded chancellor, Michel de L'Hôpital. In England judicial corruption has been a crime of remarkable rarity. Indeed, with the exception of a statute of 1384 (repealed by the Statute Law Revision Act 1881) there has been no legislation relating to judicial bribery. The earliest recorded case was that of Sir William Thorpe, who in 1351 was fined and removed from office for accepting bribes. Other celebrated cases were those of Michael de la Pole, chancellor of England, in 1387; Lord Chancellor Bacon in 1621; Lionel Cranfield, earl of Middlesex, in 1624; and Sir Thomas Parker, 1st earl of Macclesfield, in 1725. In Scotland for some years after the Revolution the bench was not without a suspicion of interested partiality; but since the beginning of the 19th century, at least, there has been in all parts of the empire a perfect reliance on its purity. The same may be said of the higher class of ministerial officers. There is no doubt that in the period from the Revolution to the end of Queen Anne's reign, when a speaker of the House of Commons was expelled for bribery, and the great Marlborough could not clear his character from pecuniary dishonesty, there was much corruption in the highest official quarters. The level of the offence of official bribery has gradually descended, until it has become an extremely rare thing for the humbler officers connected with the revenue to be charged with it. It has had a more lingering existence with those who, because their power is more of a constitutional than an official character, have been deemed less responsible to the public. During Walpole's administration there is no doubt that members of parliament were paid in cash for votes; and the memorable saying, that every man has his price, has been preserved as a characteristic indication of his method of government. One of the forms in which administrative corruption is most difficult of eradication is the appointment to office. It is sometimes maintained that the purity which characterizes the administration of justice is here unattainable, because in giving a judgment there is but one form in which it can be justly given, but when an office has to be filled many people may be equally fitted for it, and personal motives must influence a choice. It very rarely happens, however, that direct bribery is supposed to influence such appointments. It does not appear that bribery was conspicuous in England until, in the early part of the 18th century, constituencies had thrown off the feudal dependence which lingered among them; and, indeed, it is often said, that bribery is essentially the defect of a free people, since it is the sale of that which is taken from others without payment.

In English law bribery of a privy councillor or a jurymen (see **EMBRACERY**) is punishable as a misdemeanour, as is the taking of a bribe by any judicial or ministerial officer. The buying and selling of public offices is also regarded as common law as a form of bribery. By the Customs Consolidation Act 1874, any officer in the customs service is liable to instant dismissal and a penalty of £500 for taking a bribe, and any person offering or promising a bribe or reward to an officer to neglect his duty or conceal or connive at any act by which the customs may be evaded shall forfeit the sum of £500. Under the Inland Revenue Regulations Act 1890, the bribery of commissioners, collectors, officers or other persons employed in relation to the Inland Revenue involves a fine of £500. The Merchant Shipping Act 1894, ss. 112 and 398, makes provision for certain offences in the nature of bribery. Bribery is, by the Extradition Act 1904,

an extraditable offence. Administrative corruption was dealt with in the Public Bodies' Corrupt Practices Act 1889. The public bodies concerned are county councils, town or borough councils, boards, commissioners, select vestries and other bodies having local government, public health or poor law powers, and having for those purposes to administer rates raised under public general acts. The giving or receiving, promising, offering, soliciting or agreeing to receive any gift, fee, loan or advantage by any person as an inducement for any act or forbearance by a member, officer or servant of a public body in regard to the affairs of that body is made a misdemeanour in England and Ireland and a crime and offence in Scotland. Prosecution under the act requires the consent of the attorney- or solicitor-general in England or Ireland and of the lord advocate in Scotland. Conviction renders liable to imprisonment with or without hard labour for a term not exceeding two years, and to a fine not exceeding £500, in addition to or in lieu of imprisonment. The offender may also be ordered to pay to the public body concerned any bribe received by him; he may be adjudged incapable for seven years of holding public office, *i.e.* the position of member, officer or servant of a public body; and if already an officer or servant, besides forfeiting his place, he is liable at the discretion of the court to forfeit his right to compensation or pension. On a second conviction he may be adjudged forever incapable of holding public office, and for seven years incapable of being registered or of voting as a parliamentary elector, or as an elector of members of a public body. An offence under the act may be prosecuted and punished under any other act applicable thereto, or at common law; but no person is to be punished twice for the same offence. Bribery at political elections was at common law punishable by indictment or information, but numerous statutes have been passed dealing with it as a "corrupt practice." In this sense, the word is elastic in meaning and may embrace any method of corruptly influencing another for the purpose of securing his vote (see CORRUPT PRACTICES). Bribery at elections of fellows, scholars, officers and other persons in colleges, cathedral and collegiate churches, hospitals and other societies was prohibited in 1588-1589 by statute (31 Eliz. c. 6). If a member receives any money, fee, reward or other profit for giving his vote in favour of any candidate, he forfeits his own place; if for any such consideration he resigns to make room for a candidate, he forfeits double the amount of the bribe, and the candidate by or on whose behalf a bribe is given or promised is incapable of being elected on that occasion. The act is to be read at every election of fellows, &c., under a penalty of £40 in case of default. By the same act any person for corrupt consideration presenting, instituting or inducing to an ecclesiastical benefice or dignity forfeits two years' value of the benefice or dignity; the corrupt presentation is void, and the right to present lapses for that turn to the crown, and the corrupt presentee is disabled from thereafter holding the same benefice or dignity; a corrupt institution or induction is void, and the patron may present. For a corrupt resignation or exchange of a benefice the giver and taker of a bribe forfeit each double the amount of the bribe. Any person corruptly procuring the ordaining of ministers or granting of licenses to preach forfeits £40, and the person so ordained forfeits £10 and for seven years is incapacitated from holding any ecclesiastical benefice or promotion.

In the United States the offence of bribery is very severely dealt with. In many states, bribery or the attempt to bribe is made a felony, and is punishable with varying terms of imprisonment, in some jurisdictions it may be with a period not exceeding ten years. The offence of bribery at elections is dealt with on much the same lines as in England, voiding the election and disqualifying the offender from holding any office.

Bribery may also take the form of a secret commission (*q.v.*), a profit made by an agent, in the course of his employment, without the knowledge of his principal.

BRIC À BRAC (a French word, formed by a kind of onomatopoeia, meaning a heterogeneous collection of odds and ends; *cf. de bric et de broc*, corresponding to our "by hook or by crook";

or by reduplication from *brack*, refuse), objects of "virtu," a collection of old furniture, china, plate and curiosities.

BRICK (derived according to some etymologists from the Teutonic *bricke*, a disk or plate; but more authoritatively, through the French *brique*, originally a "broken piece," applied especially to bread, and so to clay, from the Teutonic *brikan*, to break), a kind of artificial stone generally made of burnt clay, and largely used as a building material.

History.—The art of making bricks dates from very early times, and was practised by all the civilized nations of antiquity. The earliest burnt bricks known are those found on the sites of the ancient cities of Babylonia, and it seems probable that the method of making strong and durable bricks, by burning blocks of dried clay, was discovered in this corner of Asia. We know at least that well-burnt bricks were made by the Babylonians more than 6000 years ago, and that they were extensively used in the time of Sargon of Akkad (*c.* 3800 *a.c.*). The site of the ancient city of Babylon is still marked by huge mounds of bricks, the ruins of its great walls, towers and palaces, although it has been the custom for centuries to carry away from these heaps the bricks required for the building of the modern towns in the surrounding country. The Babylonians and Assyrians attained to a high degree of proficiency in brickmaking, notably in the manufacture of bricks having a coating of coloured glaze or enamel, which they largely used for wall decoration. The Chinese claim great antiquity for their clay industries, but it is not improbable that the knowledge of brickmaking travelled eastwards from Babylonia across the whole of Asia. It is believed that the art of making glazed bricks, so highly developed afterwards by the Chinese, found its way across Asia from the west, through Persia and northern India, to China. The great wall of China was constructed partly of brick, both burnt and unburnt; but this was built at a comparatively late period (*c.* 210 *a.c.*), and there is nothing to show that the Chinese had any knowledge of burnt bricks when the art flourished in Babylonia.

Brickmaking formed the chief occupation of the Israelites during their bondage in Egypt, but in this case the bricks were probably sun-dried only, and not burnt. These bricks were made of a mixture of clay and chopped straw or reeds, worked into a stiff paste with water. The clay was the river mud from the banks of the Nile, and as this had not sufficient cohesion in itself, the chopped straw (or reeds) was added as a binding material. The addition of such substances increases the plasticity of wet clay, especially if the mixture is allowed to stand for some days before use; so that the action of the chopped straw was twofold; a fact possibly known to the Egyptians. These sun-dried bricks, or "adobes," are still made, as of old, on the banks of the Nile by the following method:—A shallow pit or bed is prepared, into which are thrown the mud, chopped straw and water in suitable proportions, and the whole mass is tramped on until it is thoroughly mixed and of the proper consistence. This mixture is removed in lumps and shaped into bricks, in moulds or by hand, the bricks being simply sun-dried.

Pliny mentions that three kinds of bricks were made by the Greeks, but there is no indication that they were used to any great extent, and probably the walls of Athens on the side towards Mount Hymettus were the most important brick-structures in ancient Greece. The Romans became masters of the brick-maker's art, though they probably acquired much of their knowledge in the East, during their occupation of Egypt and Greece. In any case they revived and extended the manufacture of bricks about the beginning of the Christian era; exercising great care in the selection and preparation of their clay, and introducing the method of burning bricks in kilns. They carried their knowledge and their methods throughout western Europe, and there is abundant evidence that they made bricks extensively in Germany and in Britain.

Although brickmaking was thus introduced into Britain nearly 2000 years ago, the art seems to have been lost when the Romans withdrew from the country, and it is doubtful whether any burnt bricks were made in England from that time until the 13th century. Such bricks as were used during this long

period were generally taken from the remains of Roman buildings, as at Colchester and St Albans Abbey. One of the earliest existing brick buildings, erected after the revival of brickmaking in England, is Little Wenham Hall, in Suffolk, built about A. D. 1210; but it was not until the 15th century that bricks came into general use again, and then only for important edifices. During the reign of Henry VIII. brickmaking was brought to great perfection, probably by workmen brought from Flanders, and the older portions of St James's Palace and Hampton Court Palace remain to testify to the skill then attained. In the 16th century bricks were increasingly used, but down to the Great Fire of London, in 1666, the smaller buildings, shops and dwelling-houses, were constructed of timber framework filled in with lath and plaster. In the rebuilding of London after the fire, bricks were largely used, and from the end of the 17th century to the present day they have been almost exclusively used in all ordinary buildings throughout the country, except in those districts where building stone is plentiful and good brick-clay is not readily procurable. The bricks made in England before 1625 were of many sizes, there being no recognized standard; but in that year the sizes were regulated by statute, and the present standard size was adopted, viz. $9 \times 4\frac{1}{2} \times 3$ in. In 1784 a tax was levied on bricks, which was not repealed until 1850. The tax averaged about 4s. 7d. per thousand on ordinary bricks, and special bricks were still more heavily taxed.

The first brick buildings in America were erected on Manhattan Island in the year 1633 by a governor of the Dutch West India Company. These bricks were made in Holland, where the industry had long reached great excellence; and for many years bricks were imported into America from Holland and from England. In America burnt bricks were first made at New Haven about 1650, and the manufacture slowly spread through the New England states; but for many years the home-made article was inferior to that imported from Europe.

The Dutch and the Germans were the great brickmakers of Europe during the middle ages, although the Italians, from the 14th to the 15th century, revived and developed the art of decorative brick-work or terra-cotta, and discovered the method of applying coloured enamels to these materials. Under the Della Robbias, in the 15th century, some of the finest work of this class that the world has seen was executed, but it can scarcely be included under brickwork.

Brick Clays.—All clays are the result of the denudation and decomposition of felspathic and siliceous rocks, and consist of the fine insoluble particles which have been carried in suspension in water and deposited in geologic basins according to their specific gravity and degree of fineness (see CLAY). These deposits have been formed in all geologic epochs from the "Recent" to the "Cambrian," and they vary in hardness from the soft and plastic "alluvial" clays to the hard and rock-like shales and slates of the older formations. The alluvial and drift clays (which were alone used for brickmaking until modern times) are found near the surface, are readily worked and require little preparation, whereas the older sedimentary deposits are often difficult to work and necessitate the use of heavy machinery. These older shales, or rocky clays, may be brought into plastic condition by long weathering (*i.e.* by exposure to rain, frost and sun) or by crushing and grinding in water, and they then resemble ordinary alluvial clays in every respect.

The clays or earths from which burnt bricks are made may be divided into two principal types, according to chemical composition: (1) Clays or shales containing only a small percentage of carbonate of lime and consisting chiefly of hydrated aluminium silicates (the "true clay substance") with more or less sand, undecomposed grains of feldspar, and oxide or carbonate of iron; these clays usually burn to a buff, salmon or red colour; (2) Clays containing a considerable percentage of carbonate of lime in addition to the substances above mentioned. These latter clay deposits are known as "marls,"¹ and may contain as much

as 40% of chalk. They burn to a sulphur-yellow colour which is quite distinctive.

Brick clays of class (1) are very widely distributed, and have a more extensive geological range than the marls, which are found in connexion with chalk or limestone formations only. These ordinary brick clays vary considerably in composition, and many clays, as they are found in nature, are unsuitable for brickmaking without the addition of some other kind of clay or sand. The strongest brick clays, *i.e.* those possessing the greatest plasticity and tensile strength, are usually those which contain the highest percentage of the hydrated aluminium silicates, although the exact relation of plasticity to chemical composition has not yet been determined. This statement cannot be applied indiscriminately to all clays, but may be taken as fairly applicable to clays of one general type (see CLAY). All clays contain more or less free silica in the form of sand, and usually a small percentage of undecomposed feldspar. The most important ingredient, after the clay-substance and the sand, is oxide of iron; for the colour, and, to a less extent, the hardness and durability of the burnt bricks depend on its presence. The amount of oxide of iron in these clays varies from about 1 to 10%, and the colour of the bricks varies accordingly from light buff to chocolate; although the colour developed by a given percentage of oxide of iron is influenced by the other substances present and also by the method of firing. A clay containing from 5 to 8% of oxide of iron will, under ordinary conditions of firing, produce a red brick; but if the clay contains 3 to 4% of alkalis, or the brick is fired too hard, the colour will be darker and more purple. The actions of the alkalis and of increased temperature are probably closely related, for in either case the clay is brought nearer to its fusion point, and ferruginous clays generally become darker in colour as they approach to fusion. Alumina acts in the opposite direction, an excess of this compound tending to make the colour lighter and brighter. It is impossible to give a typical composition for such clays, as the percentages of the different constituents vary through such wide ranges. The clay substance may vary from 15 to 80%, the free silica or sand from 5 to 80%, the oxide of iron from 1 to 10%, the carbonates of lime and magnesia together, from 1 to 5%, and the alkalis from 1 to 4%. Organic matter is always present, and other impurities which frequently occur are the sulphates of lime and magnesia, the chlorides and nitrates of soda and potash, and iron-pyrites. The presence of organic matter gives the wet clay a greater plasticity, probably because it forms a kind of mullage which adds a certain viscosity and adhesiveness to the natural plasticity of the clay. In some of the coal-measure shales the amount of organic matter is very considerable, and may render the clay useless for brickmaking. The other impurities, all of which, except the pyrites, are soluble in water, are undesirable, as they give rise to "scum," which produces patchy colour and pitted faces on the bricks. The commonest soluble impurity is calcium sulphate, which produces a whitish scum on the face of the brick in drying, and as the scum becomes permanently fixed in burning, such bricks are of little use except for common work. This question of "scumming" is very important to the maker of high-class facing and moulded bricks, and where a clay containing calcium sulphate must be used, a certain percentage of barium carbonate is nowadays added to the wet clay. By this means the calcium sulphate is converted into calcium carbonate which is insoluble in water, so that it remains distributed throughout the mass of the brick instead of being deposited on the surface. The presence of magnesium salts is also very objectionable, as these generally remain in the burnt brick as magnesium sulphate, which gives rise to an efflorescence of fine white crystals after the bricks are built into position. Clays which are strong or plastic are known as "fat" clays, and they always contain a high percentage of true "clay substance," and, consequently, a low percentage of sand. Such clays take up a considerable amount of water in "tempering"; they dry slowly, shrink greatly, and so become liable to lose their shape and develop cracks in drying and firing. "Fat" clays are greatly improved by the addition of coarse sharp sand.

¹ The term "marl" has been wrongly applied to many fire-clays. It should be restricted to natural mixtures of clay and chalk such as those of the Paris and London basins.

which reduces the time of drying and the shrinkage, and makes the brick more rigid during the firing. Coarse sand, unlike clay-substance, is practically unaffected during the drying and firing, and is a desirable if not a necessary ingredient of all brick clays. The best brick-clays feel gritty between the fingers; they should, of course, be free from pebbles, sufficiently plastic to be moulded into shape and strong enough when dry to be safely handled. All clays are greatly improved by being turned over and exposed to the weather, or by standing for some months in a wet condition. This "weathering" and "ageing" of clay is particularly important where bricks are made from tempered clay, *i.e.* clay in the wet or plastic state; where bricks are made from shale, in the semi-plastic condition, weathering is still of importance.

The lime clays or "marls" of class (2), which contain essentially a high percentage of chalk or limestone, are not so widely distributed as the ordinary brick-clays, and in England the natural deposits of these clays have been largely exhausted. A very fine chalk-clay, or "malm" as it was locally called, was formerly obtained from the alluvium in the vicinity of London; but the available supply of this has been used up, and at the present time an artificial "malm" is prepared by mixing an ordinary brick-clay with ground chalk. For the best London facing-bricks the clay and chalk are mixed in water. The chalk is ground on grinding-pans, and the clay is mixed with water and worked about until the mixture has the consistency of cream. The mixture of these "pulpas" is run through a grating or coarse sieve on to a drying-kiln or "bed," where it is allowed to stand until stiff enough to walk on. A layer of fine ashes is then spread over the clay, and the mass is turned over and mixed by spade, and tempered by the addition of water. In other districts, where clays containing limestone are used, the marl is mixed with water on a wash-pan and the resulting creamy fluid passed through coarse sieves on to a drying-bed. If necessary, coarse sand is added to the clay in the wash-pan, and such addition is often advisable because the washed clays are generally very fine in grain. Another method of treating these marls, when they are in the plastic condition, is to squeeze them by machinery through iron gratings, which arrest and remove the pebbles. In other cases the marl is passed through a grinding-mill having a solid bottom and heavy iron rollers, by which means the limestone pebbles are crushed sufficiently and mixed through the whole mass. The removal of limestone pebbles from the clay is of great importance, as during the firing they would be converted into quicklime, which has a tendency to shatter the brick on exposure to the weather. As before stated, these marls (which usually contain from 15 to 30% of calcium carbonate) burn to a yellow colour which is quite distinctive, although in some cases, where the percentage of limestone is very high, over 40%, the colour is grey or a very pale buff. The action of lime in bleaching the ferric oxide and producing a yellow instead of a red brick, has not been thoroughly investigated, but it seems probable that some compound is produced, between the lime and the oxide of iron, or between these two oxides and the free silica, entirely different from that produced by oxide of iron in the absence of lime. Such marls require a harder fire than the ordinary brick-clays in order to bring about the reaction between the lime and the other ingredients. Magnesia may replace lime to some extent in such marls, but the firing temperature must be higher when magnesia is present. Marls usually contract very little, if at all, in the burning, and generally produce a strong, square brick of fine texture and good colour. When under-fired, marl bricks are very liable to disintegrate under the action of the weather, and great care must be exercised in burning them at a sufficiently high temperature.

Brickmaking.—Bricks made of tempered clay may be made by hand or by machine, and the machines may be worked by hand or by mechanical power. Bricks made of semi-plastic clay (*i.e.* ground clay or shale sufficiently damp to adhere under pressure) are generally machine-made throughout. The method of making bricks by hand is the same, with slight variation, the world over. The tempered clay is pressed by hand into a wooden or metal mould or four-sided case (without top or

bottom) which is of the desired shape and size, allowance being made for the shrinkage of the brick in drying and firing. The moulder stands at the bench or table, dips the mould in water, or water and then sand, to prevent the clay from sticking, takes a rudely shaped piece of clay from an assistant, and dashes this into the mould which rests on the moulding bench. He then presses the clay into the corners of the mould with his fingers, scrapes off any surplus clay and levels the top by means of a strip of wood called a "strike," and then turns the brick out of the mould on to a board, to be carried away by another assistant to the drying-ground. The mould may be placed on a special piece of wood, called the stock-board, provided with an elevated tongue of wood in the centre, which produces the hollow or "frog" in the bottom of the brick.

Machine-made bricks may be divided into two kinds, plastic and semi-plastic, although the same type of machine is often used for both kinds.

The machine-made plastic bricks are made of tempered clay, but generally the tempering and working of the clay are effected by the use of machinery, especially when the harder clays and shales are used. The machines used in the preparation of such clays are grinding-mills and pug-mills. The grinding-mills are either a series of rollers with graduated spaces between, through which the clay or shale is passed, or are of the ordinary "mortar pan" type, having a solid or perforated iron bottom on which the clay or shale is crushed by heavy rollers. Shales are sometimes passed through a grinding-mill before they are exposed to the action of the weather, as the disintegration of the hard lumps of shale greatly accelerates the "weathering." In the case of ordinary brick-clay, in the plastic condition, grinding-mills are only used when pebbles more than a quarter of an inch in diameter are present, as otherwise the clay may be passed directly through the pug-mill, a process which may be repeated if necessary. The pug-mill consists of a box or trough having a feed hole at one end and a delivery hole or nose at the other end, and provided with a central shaft which carries knives and cutters so arranged that when the shaft revolves they cut and knead the clay, and at the same time force it towards and through the delivery nose. The cross section of this nose of the pug-mill is approximately the same as that of the required brick (9 in. \times 4½ in. plus contraction, for ordinary bricks), so that the pug delivers a solid or continuous mass of clay from which bricks may be made by merely making a series of square cuts at the proper distances apart. In practice, the clay is pushed from the pug along a smooth iron plate, which is provided with a wire cutting frame having a number of tightly stretched wires placed at certain distances apart, arranged so that they can be brought down upon, and through, the clay, and so many bricks cut off at intervals. The frame is sometimes in the form of a skeleton cylinder, the wires being arranged radially (or the wires may be replaced by metal disks); but in all cases bricks thus made are known as "wire-cuts." In order to obtain a better-shaped and more compact brick, these wire-cuts may be placed under a brick press and there squeezed into iron moulds under great pressure. These two processes are now generally performed by one machine, consisting of pug-mill and brick press combined. The pug delivers the clay, downwards, into the mould; the proper amount of clay is cut off; and the mould is made to travel into position under the ram of the press, which squeezes the clay into a solid mass.

There are many forms of brick press, a few for hand power, but the most adapted for belt-driving; although in recent years hydraulic presses have come more and more into use, especially in Germany and America. The essential parts of a brick press are: (1) a box or frame in which the clay is moulded; (2) a plunger or die carried on the end of a ram, which gives the necessary pressure; (3) an arrangement for pushing the pressed brick out of the moulding box. Such presses are generally made of iron throughout, although other metals are used, occasionally, for the moulds and dies. The greatest variations found in brick presses are in the means adopted for actuating the ram; and many ingenious mechanical devices have been applied to this end, each claiming some particular advantage over its predecessors. In many recent presses, especially where semi-plastic clay is used, the brick is pressed simultaneously from top and bottom, a second ram, working upwards from beneath, giving the additional pressure.

Although the best bricks are still pressed from tempered or plastic clay, there has recently been a great development in the manufacture of semi-plastic or dust-made bricks, especially in those districts where shales are used for brickmaking. These semi-plastic bricks are stamped out of ground shale that has been sufficiently moistened with water to enable it to bind together. The hard-clay, or shale, is crushed under heavy rollers in an iron grinding-pan having a perforated bottom through which the crushed clay passes, when sufficiently fine, into a small compartment underneath. This clay powder is then delivered, by an elevator, into a sieve or screen, which retains the coarser particles for regrinding. Sets of rollers may also be used for crushing shales that are only moderately hard, the ground material being sifted as before. The material, as fed

into the mould of the press, is a coarse, damp powder which becomes adhesive under pressure, producing a so-called "semi-plastic" brick. The presses used are similar to those employed for plastic clay, but they are generally more strongly and heavily built, and are capable of applying a greater pressure.

The semi-plastic method has many advantages where shales are used, although the bricks are not as strong nor as perfect as the best "plastic" bricks. The method, however, enables the brickmaker to make use of certain kinds of clay-rock, or shale, that would be impracticable for plastic bricks; and the weathering, tempering and "ageing" may be largely or entirely dispensed with. The plant required is heavier and more costly, but the brickyard becomes more compact, and the processes are simpler than with the "plastic" method.

The drying of bricks, which was formerly done in the open, is now, in most cases, conducted in a special shed heated by flues along which the heated gases from the kilns pass on their way to the chimney. It is important that the atmosphere of the drying-shed should be fairly dry, to which end suitable means of ventilation must be arranged (by fans or otherwise). If the atmosphere is too moist the surface of the brick remains damp for a considerable time, and the moisture from the interior passes to the surface as water, carrying with it the soluble salts, which are deposited on the surface as the water slowly evaporates. This deposit produces the "scum" already referred to. When the drying is done in a dry atmosphere the surface quickly dries and hardens, and the moisture from the interior passes to the surface as vapour, the soluble salts being left distributed through the whole mass, and consequently no "scum" is produced. Plastic bricks take much longer to dry than semi-plastic; they shrink more and have a greater tendency to warp or twist.

The burning or firing of bricks is the most important factor in their production; for their strength and durability depend very largely on the character and degree of the firing to which they have been subjected. The action of the heat brings about certain chemical decompositions and re-combinations which entirely alter the physical character of the dry clay. It is important, therefore, that the firing should be carefully conducted and that it should be under proper control. For ordinary bricks the firing atmosphere should be oxidizing, and the finishing temperature should be adjusted to the nature of the clay, the object being to produce a hard strong brick, of good shape, that will not be too porous and will withstand the action of frost. The finishing temperature ranges from 900° C. to 1250° C., the usual temperature being about 1050° C. for ordinary bricks. As before mentioned, lime-clays require a higher firing temperature (usually about 1150° C. to 1200° C.) in order to bring the lime into chemical combination with the other substances present.

It is evident that the best method of firing bricks is to place them in permanent kilns, but although such kilns were used by the Romans some 2000 years ago, the older method of firing in "clamps" is still employed in the smaller brickfields, in every country where bricks are made. These clamps are formed by arranging the unfired bricks in a series of rows or walls, placed fairly closely together, so as to form a rectangular stack. A certain number of channels, or fire-mouths, are formed in the bottom of the clamp; and fine coal is spread in horizontal layers between the bricks during the building up of the stack. Fires are kindled in the fire-mouths, and the clamp is allowed to go on burning until the fuel is consumed throughout. The clamp is then allowed to cool, after which it is taken down, and the bricks sorted; those that are under-fired being built up again in the next clamp or re-firing. Sometimes the clamp takes the form of a temporary kiln, the outside being built of burnt bricks which are plastered over with clay, and the fire-mouths being larger and more carefully formed. There are many other local modifications in the manner of building up the clamps, all with the object of producing a large percentage of well-fired bricks. Clamp-firing is slow, and also uneconomical, because irregular and not sufficiently under control; and it is now only employed where bricks are made on a small scale.

Brick-kilns are of many forms, but they can all be grouped under two main types—Intermittent kilns and Continuous kilns. The intermittent kiln is usually circular in plan, being in the form of a vertical cylinder with a domed top. It consists of a single firing-chamber in which the unfired bricks are placed, and in the walls of which are contrived a number of fire-mouths where wood or coal is burned. In the older forms known as *up-draught* kilns, the products of combustion pass from the fire-mouth, through flues, into the bottom of the firing-chamber, and thence directly upwards and out at the top. The modern plan is to introduce the products of combustion near the top, or crown, of the kiln, and to draw them downwards through holes in the bottom which lead to flues connected with an independent chimney. The *down-draught* kilns have short chimneys or "bags" built round the inside wall in connection with the fire-mouths, which conduct the flames to the upper part of the firing-chamber, where they are reverberated and passed down through the bricks in obedience to the pull of the chimney. The "bags" may be joined together, forming an inner circular wall entirely round the firing-chamber, except at the doorway; and a number of kilns may be built in a row or group having their bottom flues connected with the same tall chimney. Down-draught kilns usually give a more regular fire and a higher percentage of well-fired bricks;

and they are more economical in fuel consumption than *up-draught* kilns, while the hot gases, as they pass from the kiln, may be utilized for drying purposes, being conducted through flues under the floor of the drying-shed, on their way to the chimney. The method of using one tall chimney to work a group of down-draught kilns naturally led to the invention of the "continuous" kiln, which is really made up of a number of separate kilns or firing-chambers, built in series and connected up to the main flue of the chimney in such a manner that the products of combustion from one kiln may be made to pass through a number of other kilns before entering the flue. The earliest form of continuous kiln was invented by Friedrich Hoffman, and all kilns of this type are built on the Hoffman principle, although there are a great number of modifications of the original Hoffman construction. The great principle of "continuous" firing is the utilization of the waste heat from one kiln or section of a kiln in heating up another kiln or section, direct firing being applied only to finish the burning. In practice a number of kilns or firing-chambers, usually rectangular in plan, are built side by side in two parallel lines, which are connected at the ends by other kilns so as to make a complete circuit. The original form of the complete series was elliptical in plan, but the tendency in recent years has been to flatten the sides of the ellipses and bring their corners thus giving two parallel rows joined at the ends by a chamber or passage at right angles. Coal or gas is burnt in the chamber or section that is being fired-up, the air necessary for the combustion being heated on its passage through the kilns that are cooling down, and the products of combustion, before entering the chimney flue, are drawn through a number of other kilns or chambers containing unfired bricks, which are thus gradually heated up by the otherwise waste-heat from the sections being fired. Continuous kilns produce a more evenly fired product than the intermittent kilns usually do, and, of course, at much less cost for fuel. Gas firing is now being extensively applied to continuous kilns, natural gas in some instances being used in the United States of America; and the methods of construction and of firing are carried out with greater care and intelligence, the prime objects being economy of fuel and perfect control of firing. Pyrometers are coming into use for the control of the firing temperature, with the result that a constant and trustworthy product is turned out. The introduction of machinery greatly helped the brickmaking industry in opening up new sources of supply of raw material in the shales and hardens clays of the sedimentary deposits, and the geologic formations, and, with the extended use of continuous firing plants, it has led to the establishment of large concerns where everything is co-ordinated for the production of enormous quantities of bricks at a minimum cost. In the United Kingdom, and still more in Germany and the United States of America, great improvements have been made in machinery, firing-plant and organization, so that the whole manufacture is now being conducted on more scientific lines, to the great advantage of the industry.

Blue Brick is a very strong vitreous brick of dark, slaty-blue colour, used in engineering works where great strength or impermeability is desirable. These bricks are made of clay containing from 7 to 10% of oxide of iron, and their manufacture is carried out in the ordinary way until the later stages of the firing process, when they are subjected to the strongly reducing action of a smoky atmosphere, which is produced by throwing small bituminous coal upon the fire-mouths and damping down the admission of air. The smoke thus produced reduces the red ferric oxide to blue-green ferrous oxide, or to metallic iron, which combines with the silica present to form a fusible ferrous silicate. This fusible "slag" partly combines with the other silicates present, and partly fills up the pores, and so produces a vitreous impermeable layer varying in thickness according to the duration and character of the smoking, the finishing temperature of the kiln and the texture of the brick. Particles of carbon penetrate the surface during the early stages of the smoking, and a small quantity of carbon probably enters into combination, tending to produce a harder surface and darker colour.

Floating Bricks were first mentioned by Strabo, the Greek geographer, and afterwards by Pliny as being made at Pitane in the Troad. The secret of their manufacture was lost for many centuries, but was rediscovered in 1791 by Fabroni, an Italian, who made them from the fossil meal (diatomaceous earth) found in Tuscany. These bricks are very light, fairly strong, and being poor conductors of heat, have been employed for the construction of powder-magazines on board ship, &c.

Mortar Bricks belong to the class of unburnt bricks, and are, strictly speaking, blocks of artificial stone made in brick moulds. These bricks have been made for many years by moulding a mixture of sand and slaked lime and allowing the blocks thus made to harden in the air. This hardening is brought about partly by evaporation of the water, but chiefly by the conversion of the calcium hydroxide or slaked lime into calcium carbonate by the action of the carbonic acid in the atmosphere. A small proportion of the lime enters into combination with the silica and water present to form hydrated calcium silicate, and probably a little hydrated basic carbonate of lime is also formed, both of which substances are in the nature of cement. This process of natural hardening by exposure to the air was a very long one, occupying from six to eighteen months, and many improvements were introduced during the latter half of the 19th century to improve the strength of the bricks and to hasten the hardening

Mixtures of sand, lime and cement (and of certain ground blast-furnace slags and lime) were introduced; the moulding was done under hydraulic presses and the bricks afterwards treated with carbon dioxide under pressure, with or without the application of mild heat. Some of these mixtures and methods are still in use, but a new type of mortar brick has come into use during recent years which has practically superseded the old mortar brick.

Sand-lime Bricks.—In the early 'eighties of the 19th century, Dr Michaelis of Berlin patented a new process for hardening blocks made of a mixture of sand and lime by treating them with high-pressure steam for a few hours, and the so-called *sand-lime* bricks are now made on a very extensive scale in many countries. There are many differences of detail in the manufacture, but the general method is in all cases the same. Dry sand is intimately mixed with about one-tenth of its weight of powdered slaked lime, the mixture is then slightly moistened with water and afterwards moulded into bricks under powerful presses, capable of exerting a pressure of about 10 tons per sq. in. After removal from the press the bricks are immediately placed in huge steel cylinders usually 60 to 80 ft. long and about 7 ft. in diameter, and are there subjected to the action of high-pressure steam (120 lb to 150 lb per sq. in.) for from ten to fifteen hours. The proportion of slaked lime to sand varies according to the nature of the lime and the purity and character of the sand, one of lime to ten of sand being a fair average. The following is an analysis of a typical German sand-lime brick: silica (SiO₂), 84%; lime (CaO), 7%; alumina and oxide of iron, 2%; water, magnesia and alkalis, 7%. Under the action of the high-pressure steam the lime attacks the particles of sand, and a chemical compound of water, lime and silica is produced which forms a strong bond between the larger particles of sand. This bond of hydrated calcium silicate is evidently different from, and of better type than, the filling of calcium carbonate produced in the mortar-brick, and the sand-lime brick is consequently much stronger than the ordinary mortar-brick, however the latter may be made. The sand-lime brick is simple in manufacture, and with reasonable care is of constant quality. It is usually of a light-grey colour, but may be stained by the addition of suitable colouring oxides or pigments unaffected by lime and the conditions of manufacture.

Strength of Brick.—The following figures indicate the crushing load for bricks of various types in tons per sq. in.:

Common hand-made	from 0.4 to 0.9
" machine-made	" 0.9 " 1.2
London stock	" 0.7 " 1.3
Staffordshire blue	" 2.8 " 3.3
Sand-lime	" 2.9 " 3.4

See also BRICKWORK. (J. B.; W. B.)*

BRICKFIELDER, a term used in Australia for a hot scorching wind blowing from the interior, where the sandy wastes, bare of vegetation in summer, are intensely heated by the sun. This hot wind blows strongly, often for several days at a time, defying all attempts to keep the dust down, and parching all vegetation. It is in one sense a healthy wind, as, being exceedingly dry and hot, it destroys many injurious germs of disease. The northern brickfielder is almost invariably followed by a strong "southerly buster," cloudy and cool from the ocean. The two winds are due to the same cause, viz. a cyclonic system over the Australian Bight. These systems frequently extend inland as a narrow V-shaped depression (the apex northward), bringing the winds from the north on their eastern sides and from the south on their western. Hence as the narrow system passes eastward the wind suddenly changes from north to south, and the thermometer has been known to fall fifteen degrees in twenty minutes.

BRICKWORK, in building, the term applied to constructions made of bricks. The tools and implements employed by the bricklayer are:—the trowel for spreading the mortar; the plumb-rule to keep the work perpendicular, or in the case of an inclined or battering wall, to a regular batter, for the plumb-rule may be made to suit any required inclination; the spirit-level to keep the work horizontal, often used in conjunction with a straight-edge in order to test a greater length; and the gauge-rod with the brick-courses marked on it. The quoins or angles are first built up with the aid of the gauge-rod, and the intermediate work is kept regular by means of the line and line pins fixed in the joints. The raker, jointer, pointing rule and Frenchman are used in pointing joints, the pointing staff being held on a small board called the hawk. For roughly cutting bricks the large trowel is used; for neater work such as facings, the bolster and club-hammer; the cold chisel is for general cutting away, and for chases and holes. When bricks require to be cut, the work is set out with the square, bevel and compasses. If the

brick to be shaped is a hard one it is placed on a V-shaped cutting block, an incision made where desired with the tin saw, and after the bolster and club-hammer have removed the portion of the brick, the scutch, really a small axe, is used to hack off the rough parts. For cutting soft bricks, such as rubbers and malms, a frame saw with a blade of soft iron wire is used, and the face is brought to a true surface on the rubbing stone, a slab of Yorkshire stone.

In ordinary practice a scaffold is carried up with the walls and made to rest on them. Having built up as high as he can reach from the ground, the scaffolder erects a scaffold with standards, ledgers and putlogs to carry the scaffold boards (see **SCAFFOLD, SCAFFOLDING**). Bricks are carried to the scaffold on a hod which holds twenty bricks, or they may be hoisted in baskets or boxes by means of a pulley and fall, or may be raised in larger numbers by a crane. The mortar is taken up in a hod or hoisted in pails and deposited on ledged boards about 3 ft. square, placed on the scaffold at convenient distances apart along the line of work. The bricks are piled on the scaffold between the mortar boards, leaving a clear way against the wall for the bricklayers to move along. The workman, beginning at the extreme left of his section, or at a quoin, advances to the right, carefully keeping to his line and frequently testing his work with the plumb-rule, spirit-level and straight-edge, until he reaches another angle, or the end of his section. The pointing is sometimes finished off as the work proceeds, but in other cases the joints are left open until the completion, when the work is pointed down, perhaps in a different mortar. When the wall has reached a height from the scaffold beyond which the workman cannot conveniently reach, the scaffolding is raised and the work continued in this manner from the new level.

It is most important that the brickwork be kept perfectly plumb, and that every course be perfectly horizontal or level, both longitudinally and transversely. Strictest attention should be paid to the levelling of the lowest course of footings of a wall, for any irregularity will necessitate the inequality being made up with mortar in the courses above, thus inducing a liability for the wall to settle unequally, and so perpetuate the infirmity. To save the trouble of keeping the plumb-rule and level constantly in his hands and yet ensure correct work, the bricklayer, on clearing the footings of a wall, builds up six or eight courses of bricks at the external angles (see fig. 1), which he carefully plumbs and levels across. These form a gauge for the intervening

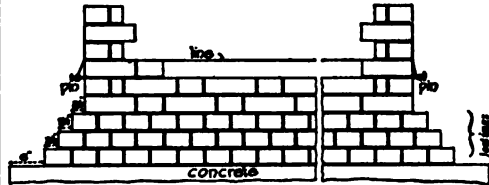

FIG. 1.

work, a line being tightly strained between and fixed with steel pins to each angle at a level with the top of the next course to be laid, and with this he makes his work range. If, however, the length between the quoins be great, the line will of course sag, and it must, therefore, be carefully supported at intervals to the proper level. Care must be taken to keep the "perpend," or vertical joints, one immediately over the other. Having been carried up three or four courses to a level with the guidance of the line which is raised course by course, the work should be proved with the level and plumb-rule, particularly with the latter at the quoins and reveals, as well as over the face. A smart tap with the end of the handle of the trowel will suffice to make a brick yield what little it may be out of truth, while the work is green, and not injure it. The work of an efficient craftsman, however, will need but little adjustment.

For every wall of more than one brick (9 in.) thick, two men should be employed at the same time, one on the outside and the

other inside; one man cannot do justice from one side to even a 14-in. wall. When the wall can be approached from one side only, the work is said to be executed "overhand." In work circular on plan, besides the level and plumb-rule, a gauge mould or template, or a ranging trammel—a rod working on a pivot at the centre of the curve, and in length equalling the radius—must be used for every course, as it is evident that the line and pins cannot be applied to this in the manner just described.

Bricks should not be merely laid, but each should be placed frog upwards, and rubbed and pressed firmly down in such a manner as to secure absolute adhesion, and force the mortar into joints. Every brick should be well wetted before it is laid, especially in hot dry weather, in order to wash off the dust from its surface, and to obtain more complete adhesion, and prevent it from absorbing water from the mortar in which it is bedded. The bricks are wetted either by the bricklayer dipping them in water as he uses them, or by water being thrown or sprinkled on them as they lie piled on the scaffold. In bricklaying with quick-setting cements an ample use of water is of even more importance.

All the walls of a building that are to sustain the same floors and the same roof, should be carried up simultaneously; in no circumstances should more be done in one part than can be reached from the same scaffold, until all the walls are brought up to the same height. Where it is necessary for any reason to leave a portion of the wall at a certain level while carrying up the adjoining work the latter should be racked back, *i.e.* left in steps as shown in fig. 7, and not carried up vertically with merely the toothing necessary for the bond.

Buildings in exposed situations are frequently built with cavity-walls, consisting of the inside or main walls with an outer skin usually half a brick thick, separated from the former by a cavity of 2 or 3 in. (fig. 2). The two walls are tied together at frequent intervals by iron or stoneware ties, each having a bend or twist in the centre, which prevents the transmission of water to the inner wall. All water, therefore, which penetrates the outer wall drops to the base of the cavity, and trickles out through gratings provided for the purpose a few inches above the ground level. The base of the cavity should be taken down a course or two below the level of the damp-proof course. The ties are placed about 3 ft. apart horizontally, with 12 or 18 in. vertical intervals; they are about 8 in. long and $\frac{1}{2}$ in. wide. It is considered preferable by some architects and builders to place the thicker wall on the outside. This course, however, allows the main wall to be attacked by the weather, whereas the former method provides for its protection by a screen of brickwork. Where door and window frames occur in hollow walls, it is of the utmost importance that a proper lead or other flashing be built in, shaped so as to throw off on each side, clear of the frames and with wall, the water which may penetrate the outer shell. While building the wall it is very essential to ensure that the cavity and ties be kept clean and free from rubbish or mortar, and for this purpose a wisp of straw or a narrow board, is laid on the ties where the bricklayer is working, to catch any material that may be inadvertently dropped, this protection being raised as the work proceeds. A hollow wall tends to keep the building dry internally and the temperature equable, but it has the disadvantage of harbouring vermin, unless care be taken to ensure their exclusion. The top of the wall is usually sealed with brickwork to prevent vermin or rubbish finding its way into the cavity. Air gratings should be introduced here to allow of air circulating through the cavity; they also facilitate drying out after rain.

Hollow walls are not much used in London for two reasons, the first being that, owing to the protection from the weather afforded by surrounding buildings, one of the main reasons for their use is gone, and the other that the expense is greatly increased, owing to the authorities ignoring the outer shell and requiring the main wall to be of the full thickness stipulated in schedule 1. of London Building Act 1894. Many English provincial authorities in determining the thickness of a cavity-wall, take the outer portion into consideration.

In London and the surrounding counties, brickwork is measured by the rod of 164 ft. square, 1½ bricks in thickness. A rod of brickwork gauged four courses to a foot with bricks 8½ in. long, 4½ in. wide, and 2½ in. thick, and joints ½ in. in thickness, will require 4356 bricks, and the number will vary as the bricks are above or below the average size, and as the joints are made thinner or thicker. The quantity of mortar, also, will evidently be affected by the latter consideration, but in London it is generally reckoned at 50 cub. ft. for a ½-in. joint, to 72 cub. ft. for a joint ½ in. thick. To these figures must be added an allowance of about 11 cub. ft. to the bricks are formed with frogs or hollows. Bricks weigh about 7 lb each; they are bought and sold by the thousand, which quantity weighs about 62 cwt. The weight of a rod of brickwork is 13½–15 tons, work in cement mortar being heavier

than that executed in lime. Seven bricks are required to face a sq. ft.; 1 ft. of reduced brickwork—1½ bricks thick—will require 16 bricks. The number of bricks laid by a workman in a day of eight hours varies considerably with the description of work, but on straight walling a man will lay an average of 500 in a day.

The absorbent properties of bricks vary considerably with the kind of brick. The ordinary London stock of good quality should not have absorbed, after twenty-four hours' soaking, more than one-fifth of its bulk. Inferior bricks will absorb as much as a third. The Romans were great users of bricks, both burnt and sun-dried. At the decline of the Roman empire, the art of brickmaking fell into disuse, but after

the lapse of some centuries it was revived, and the ancient architecture of Italy shows many fine examples of brick and terracotta work. The scarcity of stone in the Netherlands led to the development of a brick architecture, and fine examples of brickwork abound in the Low Countries. The Romans seem to have introduced brickmaking into England, and specimens of the large thin bricks which they used chiefly as a bond for rubble masonry, may be seen in the many remains of Roman buildings scattered about that country. During the reigns of the early Tudor kings the art of brickmaking arrived at great perfection, and some of the finest known specimens of ornamental brickwork are to be found among the work of this period. The rebuilding of London after the Great Fire of 1666 gave considerable impetus to brickmaking, most of the new buildings being of brick, and a statute was passed regulating the number of bricks in the thickness of the walls of the several rates of dwelling-houses.

The many names given to the different qualities of bricks in various parts of Great Britain are most confusing, but the following are those generally in use:—

Stocks, hard, sound, well-burnt bricks, used for all ordinary purposes.

Hard Stocks, sound but over-burnt, used in footings to walls and other positions where good appearance is not required.

Shippers, sound, hard-burnt bricks of imperfect shape. Obtain their name from being much used as ballast for ships.

Rubbers or Cutters, sandy in composition and suitable for cutting with a wire saw and rubbing to shape on the stone slab.

Grissles, sound and of fair shape, but under-burnt; used for inferior work, and in cases where they are not liable to be heavily loaded.

Place-bricks, under-burnt and defective; used for temporary work. **Chuffs**, cracked and defective in shape and badly burnt.

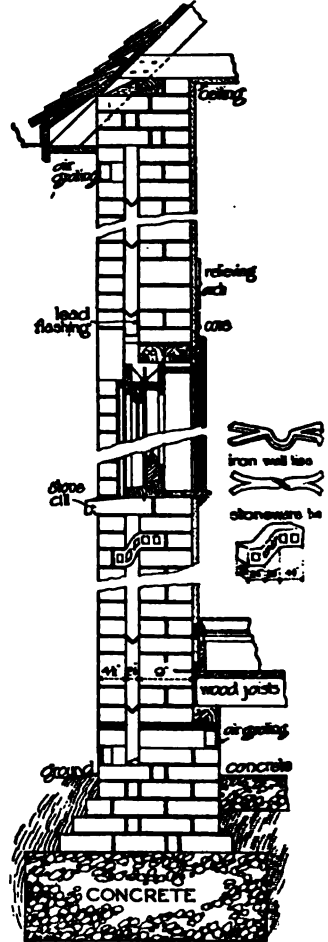

FIG. 2.—Section of a Hollow Wall.

Barrs, lumps which have vitrified or run together in the burning; used for rough walling, garden work, &c.

Pressed bricks, moulded under hydraulic pressure, and much used for facing work. They usually have a deep frog or hollow on one or both horizontal faces, which reduces the weight of the brick and forms an excellent key for the mortar.

Blue bricks, chiefly made in South Staffordshire and North Wales. They are used in engineering work, and where great compressional resistance is needed, as they are vitrified throughout, hard, heavy, impervious and very durable. Blue bricks of special shape may be had for paving, channelling and copings.

Fire-bricks, withstanding great heat, used in connexion with furnaces. They should always be laid with fire-clay in place of lime or cement mortar.

Glazed bricks, either salt-glazed or enamelled. The former, brown in colour, are glazed by throwing salt on the bricks in the kiln. The latter are dipped into a slip of the required colour before being burnt, and are used for decorative and sanitary purposes, and where reflected light is required.

Moulded bricks, for cornices, string courses, plinths, labels and copings. They are made in the different classes to many patterns; and on account of their greater durability, and the saving of the labour of cutting, are preferable in many cases to rubbers. For sewer work and arches, bricks shaped as voussoirs are supplied.

The strength of brickwork varies very considerably according to the kind of brick used, the position in which it is used, the kind and quality of the lime or cement mortar, and above all the quality of the workmanship. The results of experiments with short walls carried out in 1896-1897 by the Royal Institute of British Architects to determine the average loads per sq. ft. at which crushing took place, may be briefly summarized as follows: Stock brickwork in lime mortar crushed under a pressure of 18.63 tons per sq. ft., and in cement mortar under 39.29 tons per sq. ft. Gault brickwork in lime mortar crushed at 31.14 tons, and in cement mortar at 51.34 tons. Fletton brickwork in lime mortar crushed under a load of 30.68 tons, in cement under 56.25 tons. Leicester red brickwork in lime mortar crushed at 45.36 tons per sq. ft., in cement mortar at 83.36 tons. Staffordshire blue brick work in lime mortar crushed at 114.34 tons, and in cement mortar at 135.43 tons.

The height of a brick pier should not exceed twelve times its least width. The London Building Act in the first schedule prescribes that in buildings not public, or of the warehouse class, in no storey shall any external or party walls exceed in height sixteen times the thickness. In buildings of the warehouse class, the height of these walls shall not exceed fourteen times the thickness.

In exposed situations it is necessary to strengthen the buildings by increasing the thickness of walls and parapets, and to provide heavier copings and flashings. Special precautions, too, must be observed in the fixing of copings, chimney pots, ridges and hips. The greatest wind pressure experienced in England may be taken at 56 lb on a sq. ft., but this is only in the most exposed positions in the country or on a sea front. Forty pounds is a sufficient allowance in most cases, and where there is protection by surrounding trees or buildings 28 lb per sq. ft. is all that needs to be provided against.

In mixing mortar, particular attention must be paid to the sand with which the lime or cement is mixed. The best sand is that obtained from the pit, being sharp and angular. It is, however, liable to be mixed with clay or earth, which must be washed away before the sand is used. Gravel found mixed with it must be removed by screening or sifting. River sand is frequently used, but is not so good as pit sand on account of the particles being rubbed smooth by attrition. Sea sand is objectionable for two reasons: it cannot be altogether freed from a saline taint, and if it is used the salt attracts moisture and is liable to keep the brickwork permanently damp. The particles, moreover, are generally rounded by attrition, caused by the movement of the sea, which makes it less efficient for mortar than if they retained their original angular forms. Blue or black mortar, often used for pointing the joints of external brickwork on account of its greater durability, is made by using foundry sand or smith's ashes instead of ordinary sand. There are many other substitutes for the ordinary sand. As an example, fine stone grit may be used with advantage. Thoroughly burnt clay or ballast, old bricks, clinkers and cinders, ground to a uniform size and screened from dust, also make excellent substitutes.

Mortar. Fat limes (that is, limes which are pure, as opposed to "hydraulic" limes which are burnt from limestone containing some clay) should not be used for mortar; they are slow-setting, and there is a liability for some of the mortar, where there is not a free access of air to assist the setting, remaining soft for some considerable period, often months, thus causing unequal settlement and possibly failure. Grey stone lime is feebly hydraulic, and makes a good mortar for ordinary work. It, however, decays under the influence of the weather, and it is, therefore, advisable to point the external face of the work in blue ash or cement mortar, in order to obtain greater durability. It should never be used in foundation work, or where exposed to wet. Lias lime is hydraulic, that is, it will set firm under water. It should be used in all good class work, where Portland cement is not desired.

Of the various cements used in building, it is necessary only to mention three as being applicable to use for mortar. The first of these is Portland cement, which has sprung into very general use, not only for work where extra strength and durability are required, and for underground work, but also in general building where a small extra cost is not objected to. Ordinary lime mortar may have its strength considerably enhanced by the addition of a small proportion of Portland cement. Roman cement is rarely used for mortar, but is useful in some cases on account of the rapidity with which it sets, usually becoming hard about fifteen minutes after mixing. It is useful in tidal work and embankments, and constructions under water. It has about one-third of the strength of Portland cement, by which it is now almost entirely supplanted. Selenitic cement or lime, invented by Major-General H. Y. D. Scott (1822-1883), is lias lime, to which a small proportion of plaster of Paris has been added with the object of suppressing the action of slaking and inducing quicker setting. If carefully mixed in accordance with the instructions issued by the manufacturers, it will take a much larger proportion of sand than ordinary lime.

Lime should be slaked before being made into mortar. The lime is measured out, deposited in a heap on a wooden "bank" or platform, and after being well watered is covered with the correct proportion of sand. This retains the heat and moisture necessary to thorough slaking; the time required for this operation depends on the variety of the lime, but usually it is from a few hours to one and a half days. If the mixing is to be done by hand the materials must be screened to remove any unslaked lumps of lime. The occurrence of these may be prevented by grinding the lime shortly before use. The mass should then be well "larryed," i.e. mixed together with the aid of a long-handled rake called the "larry." Lime mortar should be tempered for at least two days, roughly covered up with sacks or other material. Before being used it must be again turned over and well mixed together. Portland and Roman cement mortars must be mixed as required on account of their quick-setting properties. In the case of Portland cement mortar, a quantity sufficient only for the day's use should be "knocked up," but with Roman cement fresh mixtures must be made several times a day, as near as possible to the place of using. Cement mortars should never be worked up after setting has taken place. Care should be taken to obtain the proper consistency, which is a stiff paste. If the mortar be too thick, extra labour is involved in its use, and much time wasted. If it be so thin as to run easily from the trowel, a longer time is taken in setting, and the wall is liable to settle; also there is danger that the lime or cement will be killed by the excess of water, or at least have its binding power affected. It is not advisable to carry out work when the temperature is below freezing point, but in urgent cases bricklaying may be successfully done by using unslaked lime mortar. The mortar must be prepared in small quantities immediately before being used, so that binding action takes place before it cools. When the wall is left at night the top course should be covered up to prevent the penetration of rain into the work, which would then be destroyed by the action of frost. Bricks used during frosty weather should be quite dry, and those that have been exposed to rain or frost should never be employed. The question whether there is any limit to bricklayers' work in frost is still an open one. Among the members of the Norwegian Society of Engineers and Architects, at whose meetings the subject has been frequently discussed, that limit is variously estimated at between -6° to -3° Réaumur ($18\frac{1}{2}$ to 14° Fahr.) and -12° to -15° Réaumur (5° above to $1\frac{1}{2}^{\circ}$ below zero Fahr.). It has been proved by hydraulic tests that good bricklayers' work can be executed at the latter minimum. The conviction is held that the variations in the opinions held on this subject are attributable to the degree of care bestowed on the preparation of the mortar. It is generally agreed, however, that from a practical point of view, bricklaying should not be carried on at temperatures lower than -8° to -10° Réaumur (14° to $9\frac{1}{2}^{\circ}$ Fahr.), for as the thermometer falls the expense of building is greatly increased, owing to a larger proportion of lime being required.

For grey lime mortar the usual proportion is one part of lime to two or three parts of sand; lias lime mortar is mixed in similar proportions, except for work below ground, when equal quantities of lime and sand should be used. Portland cement mortar is usually in the proportions of one to three, or five, of sand; good results are obtained with lime mortar fortified with cement as follows—one part slaked lime, one part Portland cement, and seven parts sand. Roman cement mortar should consist of one or one and a half parts of cement to one part of sand. Selenitic lime mortar is usually in the proportions of one to four or five, and must be mixed in a particular manner, the lime being first ground in water in the mortar-mill, and the sand gradually added. Blue or black mortar contains equal parts of foundry ashes and lime; but is improved by the addition of a proportion of cement. For setting fire-bricks fire-clay is always used. Pargetting for rendering inside chimney flues is made of one part of lime with three parts of cow dung free from straw or litter. No efficient substitute has been found for this mixture, which should be used fresh. A mortar that has found approval for tall chimney shafts is composed by grinding in a mortar-mill one part of blue lias lime with one part each of sand and foundry ashes. In the external walls of the Albert Hall the mortar used was one part Portland cement, one part grey Burham lime and six parts pit sand. The lime was slaked twenty-four hours, and after being mixed

with the sand for ten minutes the cement was added and the whole ground for one minute; the stuff was prepared in quantities only sufficient for immediate use. The by-laws dated 1891, made by the London County Council under section 16 of the Metropolis Management and Building Acts Amendment Act 1878, require the proportions of lime mortar to be one to three of sand or grit, and for cement mortar one to four. Clean soft water only should be used for the purpose of making mortar.

GROUT is thin liquid mortar, and is legitimately used in gauged arches and other work when fine joints are desired. In ordinary work it is sometimes used every four or five courses to fill up any spaces that may have been inadvertently left between the bricks. This at the best is but doing with grout what should be done with mortar in the operation of laying the bricks; and filling or flushing up every course with mortar requires but little additional exertion and is far preferable. The use of grout is, therefore, a sign of inefficient workmanship, and should not be countenanced in good work. It is liable, moreover, to ooze out and stain the face of the brickwork.

LIME PUTTY is pure slaked lime. It is prepared or "run," as it is termed, in a wooden tub or bin, and should be made as long a time as possible before being used; at least three weeks should elapse between preparation and use.

The pointing of a wall, as previously mentioned, is done either with the bricklaying or at the completion of the work. If the pointing is to be of the same mortar as the rest of the work, it would probably greatly facilitate matters to finish off the work at one operation with the bricklaying, but where, as in many cases, the pointing is required to be executed in a more durable mortar, this would be done as the scaffold is taken down at the completion of the building, the joints being raked out by the brick-

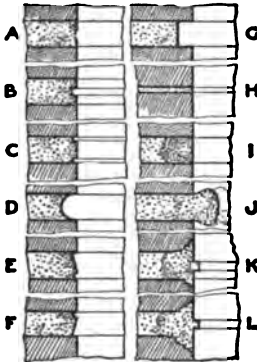

FIG. 3.—Forms of Joints.

layer to a depth of $\frac{1}{4}$ or $\frac{1}{2}$ in. By the latter method the whole face of the work is kept uniform in appearance. The different forms of joints in general use are clearly shown in fig. 3. Flat or flush joints (A) are formed by pressing the protruding mortar back flush with the face of the brickwork. This joint is commonly used for walls intended to be coated with distemper or limewhite. The flat joint jointed (two forms, B and C) is a development of the flush joint. In order to increase the density and thereby enhance the durability of the mortar, a semi-circular groove is formed along the centre, or one on each side of the joint, with an iron jointer and straight-edge. Another form, rarely used, is the keyed joint shown at D, the whole width of the joint in this case being treated with the curved key. Struck or bevelled, or weathered, joints have the upper portion pressed back with the trowel to form a sloping surface, which throws off the wet. The lower edge is cut off with the trowel to a straight edge. This joint is in very common use for new work. Ignorant workmen frequently make the slope in the opposite direction (F), thus forming a ledge on the brick; this catches the water, which on being frozen rapidly causes the disintegration of the upper portion of the brick and of the joint itself. With recessed jointing, not much used, a deep shadow may be obtained. This form of joint, illustrated in G, is open to very serious objections, for it encourages the soaking of the brick with rain instead of throwing off the wet, as it seems the natural function of good pointing, and this, besides causing undue dampness in the wall, renders it liable to damage by frost. It also leaves the arrises of the bricks unprotected and liable to be damaged, and from its deep recessed form does not make for stability in the work. Gauged work has very thin joints, as shown at H, formed by dipping the side of the brick in white lime putty. The sketch I shows a joint raked out and filled in with pointing mortar to form a flush joint, or it may be finished in any of the preceding forms. Where the wall is to be plastered the joints are either left open or raked out, or the superfluous mortar may be left protruding as shown at J. By either method an excellent key is obtained, to which the rendering firmly adheres. In tuck pointing (K) the joints are raked out and stopped, i.e. filled in flush with mortar coloured to match the brickwork. The face of the wall is then rubbed over with a soft brick of the same colour, or the work may be coloured with pigment. A narrow groove is then cut in the joints, and the mortar allowed to set. White lime putty is next filled into the groove, being pressed on with a jointing tool, leaving a white joint $\frac{1}{4}$ to $\frac{1}{2}$ in. wide, and with a projection of about $\frac{1}{4}$ in. beyond the face of the work. This method is not a good or a durable one, and should only be adopted in old work when the

edges of the bricks are broken or irregular. In bastard tuck pointing (L), the ridge, instead of being in white lime putty, is formed of the stopping mortar itself.

Footings, as will be seen on reference to fig. 1, are the wide courses of brickwork at the base or foot of a wall. They serve to spread the pressure over a larger area of ground, offsets 2 $\frac{1}{2}$ in. wide being made on each side of the wall until a width equal to double the thickness of the wall is reached. Thus in a wall 13 $\frac{1}{2}$ in. (14 bricks) thick, this bottom course would be 2 ft. 3 in. (3 bricks) wide. It is preferable for greater strength to double the lowest course. The foundation led of concrete then spreading out an additional 6 in. on each side brings the width of the surface bearing on the ground to 3 ft. 3 in. The London Building Act requires the projection of concrete on each side of the brickwork to be only 4 in., but a projection of 6 in. is generally made to allow

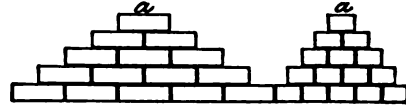
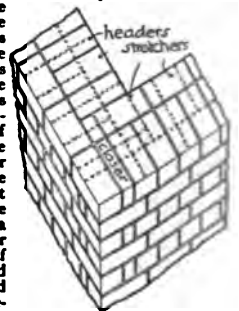

FIG. 4.—Diagram of Bonding.

for easy working. Footings should be built with hard bricks laid principally as headers; stretchers, if necessary, should be placed in the middle of the wall.

Bond in brickwork is the arrangement by which the bricks of every course cover the joints of those in the course below it, and so tend to make the whole mass or combination of bricks act as much together, or as dependently one upon another, as possible. The workmen should be strictly supervised as they proceed with the work, for many failures are due to their ignorance or carelessness in this particular. The object of bonding will be understood by reference to fig. 4. Here it is evident from the arrangement of the bricks that any weight placed on the topmost brick (a) is carried down and borne alike in every course; in this way the weight on each brick is distributed over an area increasing with every course. But this forms a longitudinal bond only, which cannot extend its influence beyond the width of the brick; and a wall of one brick and a half, or two bricks, thick, built in this manner, would in effect consist of three or four half brick thick walls acting independently of each other. If the bricks were turned so as to show their short sides or ends in front instead of their long ones, certainly a compact wall of a whole brick thick, instead of half a brick, would be produced, and while the thickness of the wall would be double, the longitudinal bond would be shortened by one-half; a wall of any great thickness built in this manner would necessarily be composed of so many independent one-brick walls. To produce a transverse and yet preserve a true longitudinal bond, the bricks are laid in a definite arrangement of stretchers and headers. In "English bond" (fig. 5), rightly considered the most perfect in use, the bricks are laid in alternate courses of headers and stretchers, thus combining the advantages of the two previous modes of arrangement. A reference to fig. 5 will show how the process of bonding is pursued in a wall one and a half bricks in thickness, and how the quoins are formed. In walls which are a multiple of a whole brick, the appearance of the same course is similar on the elevations of the front and back faces, but in walls where an odd half brick must be used to make up the thickness, as is the case in the illustration, the appearance of the opposite sides of a course is inverted. The example illustrates the principle of English bond; thicker walls are constructed in the same manner by an extension of the same methods. It will be observed that portions of a brick have to be inserted near a vertical end or a quoin, in order to start the regular bond. These portions equal a half header in width, and are called queen closers; they are placed next to the first header. A three-quarter brick is obviously available for this purpose as a header and closer combined, but the latter method is preferred because by the use of it uniformity of appearance is preserved, and whole bricks are retained on the returns. King closers are used at rebated openings formed in walls in Flemish bond, and by reason of the greater width of the back or "tail," add strength to the work. They are cut on the splay so that the front end is half the width of a header and one side half the length of the brick. An example of their use will be seen in fig. 15. In walls of almost all thicknesses above 9 in., except in the



In this and following illustrations of bond in brickwork the position of bricks in the second course is indicated by dashed lines.

FIG. 5.—English Bond.

whole bricks are retained on the returns. King closers are used at rebated openings formed in walls in Flemish bond, and by reason of the greater width of the back or "tail," add strength to the work. They are cut on the splay so that the front end is half the width of a header and one side half the length of the brick. An example of their use will be seen in fig. 15. In walls of almost all thicknesses above 9 in., except in the

English bond, to preserve the transverse and yet not destroy the longitudinal bond, it is frequently necessary to use half bricks. It can be taken as a general rule that a brick should never be cut if it can be worked in whole, for a new joint is thereby created in a construction, the difficulty of which consists in obviating the debility arising from the constant recurrence of joints. Great insistence must be laid on this point, especially at the junctions of walls,

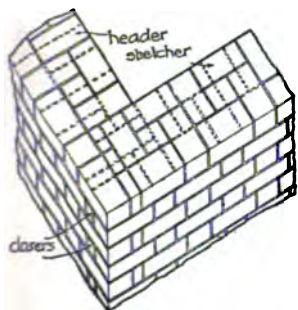

FIG. 6.—Flemish Bond.

where the admission of closers already constitutes a weakness which would only be increased by the use of other bats or fragments of bricks. Another method of bonding brickwork, instead of placing the bricks in alternate courses of headers and stretchers in the same course, the appearance of the course being the same on each face. This is called "Flemish bond." Closers are necessary to this variety of bond. From fig. 6 it will be seen that, owing to the comparative weakness of the transverse tie, and the numbers of half bricks required to be used and the thereby increased number of joints, this bond is not so perfect nor so strong as English. The arrangements of the face joints, however, presenting in Flemish bond a neater appearance than in English bond, it is generally selected for the external walls of domestic and other buildings where good effect is desirable. In buildings erected for manufacturing and similar purposes, and in engineering works where the greatest degree of strength and compactness is considered of the highest importance, English bond should have the preference.

A compromise is sometimes made between the two above-mentioned bonds. For the sake of appearance the bricks are laid to form Flemish bond on the face, while the backing is of English bond, the object being to combine the best features of the two bonds. Undoubtedly the result is an improvement on Flemish bond, obviating as it does the use of bats in the interior of the wall. This method of bonding is termed "single Flemish bond," and is shown in fig. 7.

In stretching bond, which should only be used for walls half a brick in thickness, all the bricks are laid as stretchers, a half brick being used in alternate courses to start the bond. In work curved too sharply on plan to admit of the use of stretchers, and for footings, projecting mouldings and corbels, the bricks are all laid as headers, with their ends to the front, and their length across the thickness of the wall. This is termed "heading bond."

In thick walls, three bricks thick and upwards, a saving of labour is effected without loss of strength, by the adoption of "herring bone" or "diagonal bond" in the interior of the wall, the outer faces of the wall being built in English and Flemish bond. This mode should not be had recourse to for walls of a less thickness

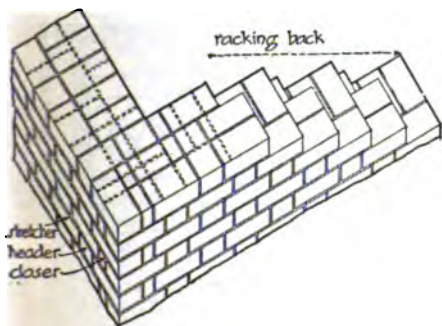

FIG. 7.—Single Flemish Bond.

than 27 in., even that being almost too thin to admit of any great advantage from it.

Hoop-iron, about 1½ in. wide and ¼ in. thick, either galvanized or well tarred and sanded to retard rusting, is used in order to obtain additional longitudinal tie. The customary practice is to use one strip of iron for each half-brick in thickness of the wall. Joints at the angles, and where necessary in the length, are formed by

bending the ends of the strips so as to hook together. A patent studded iron now on the market is perforated to provide a key for the mortar.

A difficulty often arises in bonding when facing work with bricks of a slightly different size from those used in "backing," as it is technically termed. As it is, of course, necessary to keep all brickwork in properly levelled courses, a difference has to be made in the thickness of the mortar joints. Apart from the extra labour involved, this obviously is detrimental to the stability of the wall, and is apt to produce unequal settlement and cracking. Too much care cannot be taken to obtain both facing and backing bricks of equal size.

Dishonest bricklayers do not hesitate, when using for the face of a wall bricks of a quality superior to those used for the interior, to use

"snapped headers," that is cutting the heading bricks in halves, one brick thus serving the purposes of two as regards outward appearance. This is a most pernicious practice, unworthy of adoption by any craftsman of repute, for a skin of brickwork 4½ in. thick is thus carried up with a straight mortar joint behind it, the proper bonding with the back of the wall by means of headers being destroyed.

American building acts describe the kind of bond to be used for ordinary walls, and the kind for faced walls. The courses also require an extra thickness where walls are perforated with over 30% of flues.

The importance for sanitary and other reasons of keeping walls dry is admitted by all who have observed the deleterious action of damp upon a building.

Walls are liable to become damp, (1) by wet rising up the wall from the earth; (2) by water soaking down from the top of the wall; (3) by rain being driven on to the face by wind. Dampness from the first cause may be prevented by the introduction of damp-proof courses or the construction of dry areas; from the second by means of a coping of stone, cement or other non-porous material; and from the third by covering the exterior with impervious materials or by the adoption of hollow walls.

After the footings have been laid and the wall has been brought up to not less than 6 in. above the finished surface of the ground,

and previous to fixing the plate carrying the ground floor, there should always be introduced a course of some damp-proof material to prevent the rise of moisture from the soil. There are several forms of damp-proof course. A very usual one is a double layer of roofing slates laid in neat Portland cement (fig. 8), the joints being well lapped. A course or two of Staffordshire blue bricks in cement is excellent where heavy weights have to be considered. Glazed stoneware perforated slabs about 2 in. thick are specially made for use as damp-proof courses. Asphalt (fig. 9) recently has come into great favour with architects; a layer ½ or ¾ in. thick is a good protection against damp, and not

likely to crack should a settlement occur, but in hot weather it is liable to squeeze out at the joints under heavy weights. Felt covered with bitumen is an excellent substitute for asphalt, and is not liable to crack or squeeze out. Sheet lead is efficient, but very costly and also somewhat liable to squeezing. A damp-proof course has been introduced consisting of a thin sheet of lead sandwiched between layers of asphalt. Basement storeys to be kept dry require, besides the damp-proof course horizontally in the wall, a horizontal course, usually of asphalt, in the thickness of the floor, and also a vertical damp-proof course from a level below that of the floor to about 6 in. above the level of the ground, either built in the thickness of the wall or rendered on the outside between the wall and the surrounding earth (fig. 10).

By means of dry areas or air drains (figs. 11 and 12), a hollow

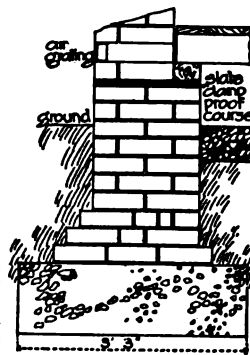

FIG. 8.



FIG. 9.

space 9 in. or more in width is formed around those portions of the walls situated below the ground, the object being to prevent them from coming into contact with the brickwork of the main walls and so imparting its moisture to the building. Arrangements should be made for keeping the area clear of vermin and for ventilating and draining it. Dry areas, being far from sanitary, are seldom adopted now, and are being superseded by asphalt or cement applied to the face of the wall.



FIG. 10.

The use of hollow walls in exposed positions has already been referred to. The by-laws dated 1891, made by the London County Council under section 16 of the Metropolitan Management and Buildings Acts Amendment Act 1879, require that "every wall of a house or building shall have a damp course composed of materials impervious to moisture approved by the district surveyor, extending throughout its whole thickness at the level of not less than 6 in. below the level of the lowest floor. Every external wall or enclosing wall of habitable rooms or their appurtenances or cellars which abuts against the earth shall be protected by materials impervious to moisture to the satisfaction of the district surveyor. . . . The top of every party-wall and parapet-wall shall be finished with one course of hard, well-burnt bricks set on edge, in cement, or by a coping of any other waterproof and fire-resisting material, properly secured."

Arches are constructions built of wedge-shaped blocks, which by reason of their shape give support one to another, and to the superimposed weight, the resulting load being transmitted through the blocks to the abutments upon which the ends of the arch rest. An arch should be composed of such materials and designed of such dimensions as to enable it to retain its proper shape and resist the crushing strain imposed upon it. The abutments also must be strong enough to take safely the thrust of the weighted arch, as the slightest movement in these supports will cause deflection and failure. The outward thrust of an arch decreases as it approaches the semi-circular form, but the somewhat prevalent idea that in the latter form no thrusting takes place is at variance with fact.



FIG. 11.

phery of the arch requires the parts of which an arch is made up to be wedge-formed, which an ordinary brick is not, the difference must be made in mortar, with the result that the joints become wedge-shaped. This obviously gives an objectionable inconsistency of material in the arch, and for this reason to obtain greatest strength it is advisable to build these arches in independent rings of half-brick thickness. The undermost rings should have thin joints, those of each succeeding ring being slightly thickened. This prevents the lowest ring from settling while those above remain in position,

which would cause an ugly fissure. In work of large span bonding blocks or "lacing courses" should be built into the arch, set in cement and running through its thickness at intervals, care being taken to introduce the lacing course at a place where the joints of the various rings coincide. Stone blocks in the shape of a voussoir (fig. 14) may be used instead. Except for these lacing courses,

hydraulic lime mortar should be used for large arches, on account of its slightly accommodating nature.

Rough-cut arches are those in which the bricks are roughly cut with an axe to a wedge form; they are used over openings such as doors and windows, where a strong arch of neat appearance is desired. The joints are usually made equal in width to those of the ordinary brickwork. Gauged arches are composed of specially made soft bricks, which are cut and rubbed to gauges or templates so as to form perfectly fitting voussoirs. Gauging is, of course, equally applicable to arches and walling, as it means no more than bringing every brick exactly to a certain form by cutting and rubbing. Gauged brickwork is set in lime putty instead of common mortar; the finished joints should not be more than $\frac{1}{4}$ in. wide. To give stability the sides of the voussoirs are gauged out hollow and grouted in Portland cement, thus connecting each brick with the next by a joggle joint. Gauged arches, being for the most part but a half-brick in thickness on the soffit and not being tied by a bond to anything behind them—for behind them is the lintel with rough discharging arch over, supporting the remaining width of the wall—require to be executed with great care and nicety. It is a common fault with workmen to rub the bricks thinner behind than before to lessen the labour required to obtain a very fine face joint. This practice tends to make the work bulge outwards; it should rather be inverted if it be done at all, though the best work is that in which the bricks are gauged to exactly the same thickness at the back as at the front. The same fault occurs when a gauged arch is inserted in an old wall, on account of the difficulty of filling up with cement the space behind the bricks.

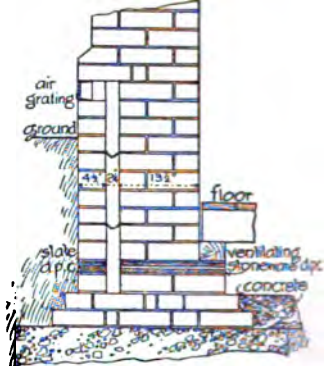

FIG. 12.

The bond of an arch obtains its name from the arrangement of headers and stretchers on its soffit. The under side of an arch built in English bond, therefore, will show the same arrangement as the face of a wall built in English bond. If the arch is in Flemish bond the soffit presents the same appearance as the elevation of a wall built in that bond. It is generally held that the building of wood into brickwork should as far as is possible be avoided. Wall plates of wood are, however, necessary where wood joists are used, and where these plates may not be supported on corbels of projecting brickwork or iron they must be let flush into the wall, taking the place of a course of bricks. They form a uniform bed for the joists, to which easy fixing is obtained. The various modes adopted for resting and fixing the ends of joists on walls are treated in the article CARPENTRY.

Lintels, which may be of iron, steel, plain or reinforced concrete, or stone, are used over square-headed openings instead of or in conjunction with arches. They are useful to preserve the square form and receive the joists fittings but except when made of steel or of concrete reinforced with steel bars, they should have relieving arches turned immediately over them (fig. 15).

"Fixing bricks" were formerly of wood of the same size as the ordinary brick, and built into the wall as required for fixing joinery. Owing to their liability to shrinkage and decay, their use is now practically abandoned, their place being taken by bricks of cork-breeze concrete, which do not shrink or rot and hold fast nails or screws driven into them. Another method often adopted for

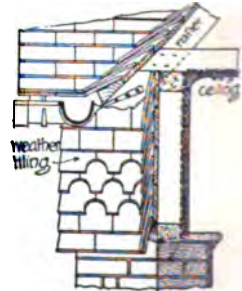

FIG. 13.

providing a fixing for joinery is to build in wood slips the thickness of a joint and $\frac{1}{4}$ in. wide. When suitable provision for fixing has not been made, wood plugs are driven into the joints of the bricks. Great care must be taken in driving these in the joints of reveals or at the corners of walls, or damage may be done.

The name "brick-ashlar" is given to walls faced with ashlar stonework backed in with brickwork. Such constructions are liable

in an aggravated degree to the unequal settling and its attendant evils pointed out as existing in walls built with different qualities of bricks. The outer face is composed of any yielding stone with few and very thin joints, which perhaps do not occupy more than a hundredth part of its height, while the back is built up of bricks with about one-

eighth its height composed of mortar joints, that is, of a material that by its nature and manner of application must both shrink in drying and yield to pressure. To obviate this tendency to settle and thus cause the bulging of the face or failure of the wall, the mortar used should be composed of Portland cement and sand with a large proportion of the former, and worked as stiff as it conveniently can be. In building such work the stones should be in height equal to an exact number of brick courses. It is a common practice in erecting buildings with a facing of Kentish rag rubble to back up the stonework with bricks. Owing to the great irregularity of the stones, great difficulty is experienced in obtaining proper bond between the two materials. Through bonding stones or

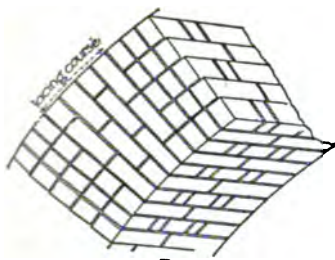

FIG. 14.

higher, if possible, than adjacent buildings, which are apt to cause down-draught and make the chimney smoke. When this is found impossible, one of the many forms of patent chimney-pots or revolving cowls must be adopted. Each flue must be separated by smoke-proof "withe" or divisions, usually half a brick in thickness; connexion between them causes smoky chimneys. The size of the flue for an ordinary grate is 14×9 in.; for a kitchen stove 14×14 in. The outer wall of a chimney stack may with advantage be made 9 in. thick. Fireclay tubes, rectangular or circular in transverse section, are largely used in place of the pargetting; although more expensive than the latter they have the advantage in point of cleanliness and durability. Fireplaces generally require more depth than can be provided in the thickness of the wall, and therefore necessitate a projection to contain the fireplace and flues, called the "chimney breast." Sometimes, especially when the wall is an external one, the projection may be made on the back, thus allowing a flush wall in the room and giving more space and a more conveniently-shaped room. The projection on the outside face of the wall may be treated as an ornamental feature. The fireplace opening is covered by a brick relieving arch, which is fortified by wrought-iron bar from $\frac{1}{2}$ to $\frac{3}{4}$ in. thick and 2 to 3 in. wide. It is usually bent to a "camber," and the brick arch built upon it naturally takes the same curve. Each end is "caulked," that is, split longitudinally and turned up and down. The interior of a chimney breast behind the stove should always be filled in solid with concrete or brickwork. The flooring in the chimney opening is called the "hearth"; the back hearth covers the space between the jambs of the chimney breast, and the front hearth rests upon the brick "trimmer arch" designed to support it. The hearth is now often formed in solid concrete, supported on the brick wall and sills fixed to the floor joists, without any trimmer arch and finished in neat cement or glazed tiles instead of stone slabs.

Tall furnace chimneys should stand as separate constructions, unconnected with other buildings. If it is necessary to bring other work close up, a straight joint should be used. The shaft of the chimney will be built "overhand," the men working from the inside. Lime mortar is used, cement being too rigid to allow the chimney to rock in the wind. Not more than 3 ft. in height should be erected in one day, the work of necessity being done in small portions to allow the mortar to set before it is required to sustain much weight. The bond usually adopted is one course of headers for four of stretchers. Scaffolding is sometimes erected outside for a height of 25 or 30 ft., to facilitate better pointing, especially where the chimney is in a prominent position. The brickwork at the top must, according to the London Building Act, be 9 in. thick (it is better 14 in. in shafts over 100 ft. high), increasing half a brick in thickness for every additional 20 ft. measured downwards. "The shaft shall taper gradually from the base to the top at the rate of at least $\frac{1}{4}$ in. in 10 ft. of height. The width of the base of the shaft if square shall be at least one-tenth of the proposed height of the shaft, or if round or any other shape, then one-twelfth of the height. Firebricks built inside the lower portion of the shaft shall be provided, as additional to and independent of the prescribed thickness of brickwork, and shall not be bonded therewith." The firebrick lining should be carried up from about 25 ft. for ordinary temperatures to double that height for very great ones, a space of 14 to 3 in. being kept between the lining and the main wall. The lining itself is usually $\frac{1}{4}$ in. thick. The cap is usually of cast iron or terra-cotta strengthened with iron bolts and straps, and sometimes of stone, but the difficulty of properly fixing this latter material causes it to be neglected in favour of one of the former. (See a paper by F. J. Bancroft on "Chimney Construction," which contains a tabulated description of nearly sixty shafts, *Proc. Civ. and Mech. Eng. Soc.*, December 1883.)

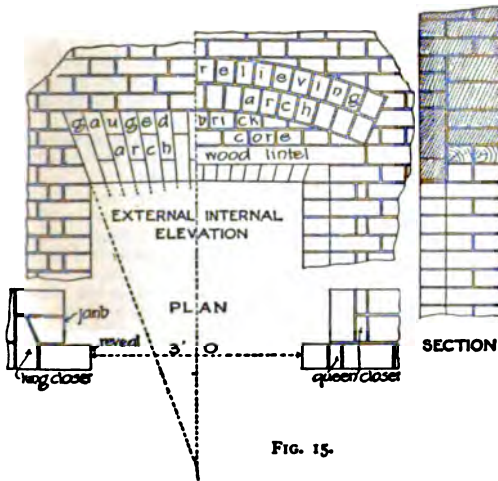

FIG. 15.

headers should be frequently built in, and the whole of the work executed in cement mortar to ensure stability.

Not the least important part of the bricklayer's art is the formation of chimney and other flues. Considerable skill is required in gathering-in-grooves properly above the fireplace so as to conduct chimneys the smoke into the smaller flue, which itself requires to be built with precision, so that its capacity may not vary in different parts. Bends must be made in gradual curves so as to offer the least possible resistance to the up-draught, and at least one bend of not less than 60° should be formed in each flue to intercept down-draughts. Every fireplace must have a separate flue. The collection of a number of flues into a "stack" is economical, and tends to increase the efficiency of the flues, the heat from one flue assisting the up-draught in those adjoining it. It is also desirable from an aesthetic point of view, for a number of single flue chimneys sticking up from various parts of the roof would appear most unsightly. The architects of the Elizabethan and later periods were masters of this difficult art of treating a stack or stacks as an architectural feature. The shaft should be carried well above the roof,

The work of laying bricks or tiles as paving falls to the lot of the bricklayer. Paving formed of ordinary bricks laid flat or on their edges was once in general use, but is now almost abandoned in favour of floors of special tiles or cement paving, the latter being practically non-porous and therefore more sanitary and cleaner. Special bricks of extremely hard texture are made for stable and similar paving, having grooves worked on the face to assist drainage and afford good foothold. A bed of concrete 6 in. thick is usually provided under paving, or when the bricks are placed on edge the concrete for external paving may be omitted and the bricks bedded in sand, the ground being previously well rammed. The side joints of the bricks are grouted in with lime or cement. Dutch clinkers are small, hard paving bricks burned at a high temperature and of a light yellow colour; they are 6 in. long, 3 in. wide, $\frac{1}{2}$ in. thick. A variety of paving tile called "oven tiles" is of similar material to the ordinary red brick, and in size is 10 or 12 in. square and 1 to 2 in. thick. An immense variety of ornamental paving and walling tiles is now manufactured of different colours, sizes and shapes, and the use of these for lining sculleries, lavatories, bathrooms, provision shops, &c., makes for cleanliness and improved sanitary conditions. Besides, however, being put to these uses, tiles are often used in the ornamentation of buildings, externally as well as internally.

Mosaic work is composed of small pieces of marble, stone, glass or pottery, laid as paving or wall lining, usually in some ornamental pattern or design. A firm bed of concrete is required, the pieces of

material being fixed in a float of cement about half or three-quarters of an inch thick. Roman mosaic is formed with cubes of marble of various colours pressed into the float. A less costly paving may be obtained by strewing irregularly-shaped marble chips over the floated surface; these are pressed into the cement with a plasterer's hand float, and the whole is then rolled with an iron roller. This is called "terrazzo mosaic." In either the Roman or terrazzo method any patterns or designs that are introduced are first worked in position, the ground-work being filled in afterwards. For the use of cement for paving see PLASTER.

The principal publications on brickwork are as follows:—Rivington, *Notes on Building Construction*, vols. i. ii. iii.; Col. H. E. Seddon, *Aide Memoir*, vol. ii.; *Specification*; J. P. Allen, *Building Construction*; F. E. Kidder, *Building Construction and Superintendence*, part I. (1903); Longmans & Green, *Building Construction*; E. Dobson, *Bricks and Tiles*; Henry Adams, *Building Construction*; C. F. Mitchell, *Building Construction*, vol. i. ii.; E. Street, *Brick and Marble Architecture in Italy*. (J. Br.)

BRICOLE (a French word of unknown origin), a military engine for casting heavy stones; also a term in tennis for a side-stroke rebounding off the wall of the court, corrupted into "brick-wall" from a supposed reference to the wall, and in billiards for a stroke off the cushion to make a cannon or hazard.

BRIDAINÉ (or **BRYDAYNE**), **JACQUES** (1701-1767), French Roman Catholic preacher, was born at Chuslan in the department of Gard on the 21st of March 1701. He was educated at Avignon, first in the Jesuit college and afterwards at the Sulpician seminary of St Charles. Soon after his ordination to the priesthood in 1725, he joined the *Missions Royales*, organized to bring back to the Catholic faith the Protestants of France. He gained their good-will and made many converts; and for over forty years he visited as a missionary preacher almost every town of central and southern France. In Paris, in 1744, his sermons created a deep impression by their eloquence and sincerity. He died at Roquemaure, near Avignon, on the 22nd of December 1767. He was the author of *Cantiques spirituels* (Montpellier, 1748, frequently reprinted, in use in most French churches); his sermons were published in 5 vols. at Avignon in 1823 (ed. Paris, 1861).

See Abbé G. Carron, *La Modèle des prêtres* (1803).

BRIDE (a common Teutonic word, e.g. Goth. *brukes*, O. Eng. *bryd*, O. H. Ger. *brât*, Mod. Ger. *Brau*, Dut. *bruid*, possibly derived from the root *bru-*, cook, brew; from the med. latinized form *brua*, in the sense of daughter-in-law, is derived the Fr. *bru*), the term used of a woman on her wedding-day, and applicable during the first year of wifehood. It appears in combination with many words, some of them obsolete. Thus "bridegroom" is the newly married man, and "bride-bell," "bride-banquet" are old equivalents of wedding-bells, wedding-breakfast. "Bridal" (from *Bride-ale*), originally the wedding-feast itself, has grown into a general descriptive adjective, e.g. the *bridal party*, the *bridal ceremony*. The *bride-cake* had its origin in the Roman *confarreatio*, a form of marriage, the essential features of which were the eating by the couple of a cake made of salt, water and flour, and the holding by the bride of three wheat-ears, symbolical of plenty. Under Tiberius the cake-eating fell into disuse, but the wheat ears survived. In the middle ages they were either worn or carried by the bride. Eventually it became the custom for the young girls to assemble outside the church porch and throw grains of wheat over the bride, and afterwards a scramble for the grains took place. In time the wheat-gains came to be cooked into thin dry biscuits, which were broken over the bride's head, as is the custom in Scotland to-day, an oatmeal cake being used. In Elizabeth's reign these biscuits began to take the form of small rectangular cakes made of eggs, milk, sugar, currants and spices. Every wedding guest had one at least, and the whole collection were thrown at the bride the instant she crossed the threshold. Those which lighted on her head or shoulders were most prized by the scramblers. At last these cakes became amalgamated into a large one which took on its full glories of almond paste and ornaments during Charles II.'s time. But even to-day in rural parishes, e.g. north Notts, wheat is thrown over the bridal couple with the cry "Bread for life and pudding for ever," expressive of a wish that the newly wed may be always affluent. The throwing of rice, a very ancient

custom but one later than the wheat, is symbolical of the wish that the bridal may be fruitful. The *bride-cup* was the bowl or loving-cup in which the bridegroom pledged the bride, and she him. The custom of breaking this wine-cup, after the bridal couple had drained its contents, is common to both the Jews and the members of the Greek Church. The former dash it against the wall or on the ground, the latter tread it under foot. The phrase "bride-cup" was also sometimes used of the bowl of spiced wine prepared at night for the bridal couple. *Bride-favours*, anciently called bride-lace, were at first pieces of gold, silk or other lace, used to bind up the sprigs of rosemary formerly worn at weddings. These took later the form of bunches of ribbons, which were at last metamorphosed into rosettes. *Bridegroom-men* and *bridesmaids* had formerly important duties. The men were called bride-knights, and represented a survival of the primitive days of marriage by capture, when a man called his friends in to assist to "lift" the bride. Bridesmaids were usual in Saxon England. The senior of them had personally to attend the bride for some days before the wedding. The making of the bridal wreath, the decoration of the tables for the wedding feast, the dressing of the bride, were among her special tasks. In the same way the senior groomsman (the *best man*) was the personal attendant of the husband. The *bride-wain*, the wagon in which the bride was driven to her new home, gave its name to the weddings of any poor deserving couple, who drove a "wain" round the village, collecting small sums of money or articles of furniture towards their housekeeping. These were called bidding-weddings, or bid-ales, which were in the nature of "benefit" feasts. So general is still the custom of "bidding-weddings" in Wales, that printers usually keep the form of invitation in type. Sometimes as many as six hundred couples will walk in the bridal procession. The *bride's wreath* is a Christian substitute for the gilt coronet all Jewish brides wore. The crowning of the bride is still observed by the Russians, and the Calvinists of Holland and Switzerland. The wearing of orange blossoms is said to have started with the Saracens, who regarded them as emblems of fecundity. It was introduced into Europe by the Crusaders. The *bride's veil* is the modern form of the *flammeum* or large yellow veil which completely enveloped the Greek and Roman brides during the ceremony. Such a covering is still in use among the Jews and the Persians.

See Brand, *Antiquities of Great Britain* (Hazlitt's ed., 1905); Rev J. Edward Vaux, *Church Folklore* (1894).

BRIDEWELL, a district of London between Fleet Street and the Thames, so called from the well of St Bride or St Bridget close by. From William the Conqueror's time, a castle or Norman tower, long the occasional residence of the kings of England, stood there by the Fleet ditch. Henry VIII., Stow says, built there "a stately and beautiful house," specially for the housing of the emperor Charles V. and his suite in 1525. During the hearing of the divorce suit by the Cardinal at Blackfriars, Henry and Catharine of Aragon lived there. In 1553 Edward VI. made it over to the city as a penitentiary, a house of correction for vagabonds and loose women; and it was formally taken possession of by the lord mayor and corporation in 1555. The greater part of the building was destroyed in the Great Fire of 1666. New Bridewell, built in 1820, was pulled down in 1864. The term has become a synonym for any reformatory.

BRIDGE, a game of cards, developed out of the game of whist. The country of its origin is unknown. A similar game is said to have been played in Denmark in the middle of the 10th century. A game in all respects the same as bridge, except that in "no trumps" each trick counted ten instead of twelve, was played in England about 1884 under the name of Dutch whist. Some connect it with Turkey and Egypt under the name of "Khedive," or with a Russian game called "Yeralash." It was in Turkey that it first won a share of popular favour. Under the synonym of "Biritch," "Bridge," or "Russian whist," it found its way to the London clubs about 1894, from which date its popularity rapidly increased.

Ordinary Bridge.—Bridge, in its ordinary form, differs from

whist in the following respects:—Although there are four players, yet in each hand the partner of the dealer takes no part in the play of that particular hand. After the first lead his cards are placed on the table exposed, and are played by the dealer as at dummy whist; nevertheless the dealer's partner is interested in the result of the hand equally with the dealer. The trump suit is not determined by the last card dealt, but is selected by the dealer or his partner without consultation, the former having the first option. It is further open to them to play without a trump suit. The value of tricks and honours varies with the suit declared as trumps. Honours are reckoned differently from whist, and on a scale which is somewhat involved. The score for honours does not count towards winning or losing the rubber, but is added afterwards to the trick score in order to determine the value of the rubber. There are also scores for holding no trumps ("chicane"), and for winning all the tricks or all but one ("slam").

The score has to be kept on paper. It is usual for the scoring book to have two vertical columns divided halfway by a horizontal line. The left column is for the scorers' side, and the right for the opponents'. Honours are scored above the horizontal line, and tricks below. The drawback to this arrangement is that, since the scores for each hand are not kept separately, it is generally impossible to trace an error in the score without going through the whole series of hands. A better plan, it seems, is to have four columns ruled, the inner two being assigned to tricks, the outer ones to honours. By this method a line can be reserved for each hand, and any discrepancy in the scores at once rectified.

The Portland Club, London, drew up a code of laws in 1895, and this code, with a few amendments, was in July 1895 adopted by a joint committee of the Turf and Portland Clubs. A revised code came into force in January 1905, the provisions of which are here summarized.

Each trick above 6 counts 2 points in a spade declaration, 4 in a club, 6 in a diamond, 8 in a heart, 12 in a no-trump declaration. The game consists of 30 points made by tricks alone. When one side has won two games the rubber is ended. The winners are entitled to add 100 points to their score. Honours consist of ace, king, queen, knave, ten, in a suit declaration. If a player and his partner conjointly hold 3 (or "simple") honours they score twice the value of a trick; if 4 honours, 4 times; if 5 honours, 5 times. If a player in his own hand hold 4 honours he is entitled to score 4 honours in addition to the score for conjoint honours; thus, if one player hold 4 honours and his partner the other their total score is 9 by honours. Similarly if a player hold 5 honours in his own hand he is entitled to score 10 by honours. If in a no-trump hand the partners conjointly hold 3 aces, they score 30 for honours; if 4 aces, 40 for honours. 4 aces in 1 hand count 100. On the same footing as the score for honours are the following: *chicane*, if a player hold no trump, in amount equal to simple honours; *grand slam*, if one side win all the tricks, 40 points; *little slam*, if they win 12 tricks, 20 points. At the end of the rubber the total scores, whether made by tricks, honours, chicane, slam, or rubber points, are added together, and the difference between the two totals is the number of points won.

At the opening of play, partners are arranged and the cards are shuffled, cut and dealt (the last card not being turned) as at whist; but the dealer cannot lose the deal by misdealing. After the deal is completed, the dealer makes the trump or no-trump (*sans atout*) declaration, or passes the choice to his partner without remark. If the dealer's partner make the declaration out of his turn, the adversary on the dealer's left may, without consultation, claim a fresh deal. If an adversary make a declaration, the dealer may claim a fresh deal or disregard the declaration. Then after the declaration, either adversary may double, the leader having first option. The effect of doubling is that each trick is worth twice as many points as before; but the scores for honours, chicane and slam are unaltered. If a declaration is doubled, the dealer and his partner have the right of redoubling, thus making each trick worth four times as much as at first. The declarer has the first option. The other side

can again redouble, and so on; but the value of a trick is limited to 100 points. In the play of the hand the laws are nearly the same as the laws of whist, except that the dealer may expose his cards and lead out of turn without penalty; after the second hand has played, however, he can only correct this lead out of turn with the permission of the adversaries. Dummy cannot revoke. The dealer's partner may take no part in the play of the hand beyond guarding the dealer against revoking.

Advice to Players.—In the choice of a suit two objects are to be aimed at: first, to select the suit in which the combined forces have the best chance of making tricks; secondly, to select the trump so that the value of the suit agrees with the character of the hand, i.e. a suit of high value when the hands are strong and of low value when very weak. As the deal is a great advantage it generally happens that a high value is to be aimed at, but occasionally a low value is desirable. The task of selection should fall to the hand which has the most distinctive features, that is, either the longest suit or unusual strength or weakness. No consultation being allowed, the dealer must assume only an average amount of variation from the normal in his partner's hand. If his own hand has distinctive features beyond the average, he should name the trump suit himself, otherwise pass it to his partner. It may here be stated what is the average in these respects.

As regards the length of a suit, a player's long suit is rather more likely to be fewer than five than over five. If the dealer has in his hand a suit of five cards including two honours, it is probable that he has a better suit to make trumps than dummy; if the suit is in hearts, and the dealer has a fair hand, he ought to name the trump. As regards strength, the average hand would contain ace, king, queen, knave and ten, or equivalent strength. Hands stronger or weaker than this by the value of a king or less may be described as featureless. If the dealer's hand is a king over the average, it is more likely than not that his partner will either hold a stronger hand, or will hold such a weak hand as will counteract the player's strength. The dealer would not generally wish such a hand declare no trump, especially as by making a no-trump declaration the dealer forfeits the advantage of holding the long trumps.

Declarations by Dealer.—In calculating the strength of a hand a knave is worth two tens, a queen worth two knaves, a king is worth a queen and knave together, and an ace is worth a king and queen together. A king unguarded is worth less than a queen guarded; a queen is not fully guarded unless accompanied by three more cards; if guarded by one small card it is worth a knave guarded. An ace also loses in value by being sole.

A hand to be strong enough for a no-trump declaration should be a king and ten above the average with all the honours guarded and all the suits protected. It must be a king and knave or two queens above the average if there is protection in three suits. It must be an ace or a king and queen above the average if only two suits are protected. An established black suit of six or more cards with a guarded king as card of entry is good enough for no trumps. With three aces no trumps can be declared. Without an ace, four kings, two queens and a knave are required in order to justify the declaration. When the dealer has a choice of declarations, a sound heart make is to be preferred to a doubtful no-trump. Four honours in hearts are to be preferred to any but a very strong no-trump declaration; but four aces counting 100 points constitute a no-trump declaration without exception.

Six hearts should be made trumps and five with two honours unless the hand is very weak; five hearts with one honour or four hearts with three honours should be declared if the hand is nearly strong enough for no trumps, also if the hand is very irregular with one suit missing or five of a black suit. Six diamonds with one honour, five with three honours or four all honours should be declared; weaker diamonds should be declared if the suits are irregular, especially if blank in hearts. Six clubs with three honours or five with four honours should be declared. Spades are practically only declared with a weak hand; with only a king in the hand a suit of five spades should be declared as a defensive measure. With nothing above a ten a suit of two or three spades can be declared, though even with the weakest hands a suit of five clubs or of six red cards will probably prove less expensive.

Declarations by Dummy.—From the fact that the call has been passed, the dealer's partner must credit the dealer with less than average strength as regards the rank of his cards, and probably a slightly increased number of black cards; he must therefore be more backward in making a high declaration whenever he can make a sound declaration of less value. On the other hand, he has not the option of passing the declaration, and may be driven to declare on less strength because the only alternative is a short suit of spades. For example, with the hand: Hearts, ace, kv. 2; diamonds, qn. 9, 7, 6, 3; clubs, kg. 10, 4; spades, 9, 2, the chances are in the dealer's favour with five trumps, but decidedly against with only two, and the diamond declaration is to be preferred to the spade. Still, a hand may be so weak that spades should be declared with two or less, but five clubs or six diamonds would be preferable with the weakest of hands.

Declarations to the Score.—When one's score is over twenty, club declarations should be made more frequently by the dealer. Spades should be declared with six at the score of twenty-six and with five at twenty-eight. When much behind in the score a risky no-trumper such as one with an established suit of seven or eight cards without a card of entry, may be declared.

Declaring to the score is often overdone; an ordinary weak no-trump declaration carries with it small chances of three by tricks unless dummy holds a no-trump hand.

Doubling.—Practically the leader only doubles a no-trump declaration when he holds what is probably an established suit of seven cards or a suit which can be established with the loss of one trick and he has good cards of re-entry. Seven cards of a suit including the ace, king and queen make a sound double without any other card of value in the hand, or six cards including king, queen and knave with two aces in other suits.

Doubling by the third hand is universally understood to mean that the player has a very strong suit which he can establish. In response to the double his partner, according to different conventions, leads either a heart or his own shortest suit as the one most likely to be the third player's strongest. Under the short suit convention, if the doubler holds six of a suit headed by the ace, king and queen, it is about an even chance that his suit will be selected; he should not double with less strength. Under the heart convention it is not necessary to have such great strength; with a strong suit of six hearts and good cards of re-entry, enough tricks will be saved to compensate for the doubled value. A player should ascertain the convention followed before beginning to play.

Before doubling a suit declaration a player should feel almost certain that he is as strong as the declarer. The minimum strength to justify the declaration is generally five trumps, but it may have been made on six. If, then, a player holds six trumps with an average hand as regards the rank of his cards, or five trumps with a hand of no-trump strength, it is highly probable that he is as strong as the declarer. It must be further taken into account that the act of doubling gives much valuable information to the dealer, who would otherwise play with the expectation of finding the trumps evenly distributed; this is counterbalanced when the doubler is on the left of the declaring hand by the intimation given to his partner to lead trumps through the strong hand. In this position, then, the player should double with the strength stated above. When on the declarer's right, the player should hold much greater strength unless his hand is free from tenaces. When a spade declaration has been made by dummy, one trump less is necessary and the doubler need not be on the declarer's left. A spade declaration by the dealer can be doubled with even less strength. A declaration can be rather more freely doubled when a single trick undoubled will take the dealer out, but even in this position the player must be cautious of informing the dealer that there is a strong hand against him.

Redoubling.—When a declaration has been doubled, the declarer knows the minimum that he will find against him; he must be prepared to find occasionally strength against him considerably exceeding this minimum. Except in the case of a spade declaration, cases in which redoubling is justifiable are very rare.

The Play of the Hand.—In a no-trump declaration the main object is to bring in a long suit. In selecting the suit to establish, the following are favourable conditions:—One hand should hold at least five cards of the suit. The two hands, unless with a sequence of high cards, should hold between them eight cards of the suit, so as to render it probable that the suit will be established in three rounds. The hand which contains the strong suit should be sufficiently strong in cards of re-entry. The suit should not be so full of possible tenaces as to make it disadvantageous to open it. As regards the play of the cards in a suit, it is not the object to make tricks early, but to make all possible tricks. Deep finesses should be made when there is no other way of stealing a trick. Tricks may be given away, if by so doing a favourable opening can be made for a finesse. When, however, it is doubtful with which hand the finesse should be made, it is better to leave it as late as possible, since the card to be finessed against may fall, or an adversary may fail, thus disclosing the suit. It is in general unsound to finesse against a card that must be unguarded. From a hand short in cards of re-entry, winning cards should not be led out so as to exhaust the suit from the partner's hand. Even a trick should sometimes be given away. For instance, if one hand holds seven cards headed by ace, king, and the other hand holds only two of the suit, although there is a fair chance of making seven tricks in the suit, it would often be right to give the first trick to the adversaries. When one of the adversaries has shown a long suit, it is frequently possible to prevent its being brought in by a device, such as holding up a winning card, until the suit is exhausted from his partner's hand, or playing in other suits so as to give the player the lead whilst his partner has a card of his suit to return, and to give the latter the lead when he has no card to return. The dealer should give as little information as possible as to what he holds in his own hand, playing frequent false cards. Usually he should play the higher or highest of a sequence; still, there are positions in which playing the higher gives more information than the lower; a strict adherence to a rule in itself assists the adversaries.

With a suit declaration, if there is no chance of letting the weak hand make a trump by ruffing, it will generally be the dealer's aim

to discard the losing cards in the declaring hand either to high cards or to the cards of an established suit in the other hand, sometimes after the adverse trumps have been taken out, but often before there being no time for drawing trumps. With no card of any value in a suit in one hand, the lead should come from that hand, but it is better, if possible, to let the adversaries open the suit. It is generally useless to lead a moderately high card from the weaker hand in order to finesse it, when holding no cards in sequence with it in either hand. Sometimes (especially in no-trumps) it is the better play to make the weak hand third player. For instance, with king, 8, 7, 5, 3 in one hand, knave, 4 in the other, the best way of opening is from the hand that holds five cards.

In a no-trump declaration the opponents of the dealer should endeavour to find the longest suit in the two hands, or the one most easily established. With this object the leader should open his best suit. If his partner next obtains the lead he ought to return the suit, unless he himself has a suit which he considers better, having due regard to the fact that the first suit is already partially established. The opponents should employ the same tactics as the dealer to prevent the latter from bringing in a long suit; they can use them with special effect when the long suit is in the exposed hand.

Against no-trumps the leader should not play his winning cards unless he has a good chance of clearing the suit without help from his partner; in most cases it is advisable to give away the first trick, especially if he has no card of re-entry, in order that his partner on gaining the lead may have a card of the suit to return; but holding ace, king and queen, or ace, king with seven in the suit, or ace, king, knave, ten with six, the player may lead out his best. With three honours any two of which are in sequence (not to the ace) the player should lead the higher of the sequence. He should lead his highest card from queen, knave, ten; from queen, knave, nine; from knave, ten, nine; knave, ten, eight; and ten, nine, eight. In other cases the player should lead a small card; according to the usual convention, the fourth best. His partner, and also the dealer, can credit him with three cards higher than the cards led, and can often place the cards of the suit; for instance, the seven is led, dummy holds queen and eight, playing the queen, the third player holds the nine and smaller cards; the unseen cards higher than the seven are ace, king, knave and ten of which the leader must hold three; he cannot hold both knave and ten or he would have led the knave; he must therefore hold the ace, king and either knave or ten. The "eleven" rule is as follows: the number of pips in the card led subtracted from eleven ($11-7=4$ in the case stated) gives the number of cards higher than the one led not in the leader's hand; the three cards seen (queen, nine and eight) leave one for the dealer to hold. The mental process is no shorter than assigning three out of the unseen cards to the leader, and by not noting the unseen cards much valuable information may be missed, as in the illustrative case given.

With a suit declared the best opening lead is a singleton, failing which a lead from a strong sequence. A lead from a tenace or a guarded king or queen is to be avoided. Two small cards may be led from, though the lead is objected to by some. A suit of three small cards of no great strength should not be opened. In cases of doubt preference should be given to hearts and to a less extent to diamonds.

To lead up to dummy's weak suits is a valuable rule. The converse, to lead through strength, must be used with caution, and does not apply to no-trump declarations. It is not advisable to adopt any of the recent whist methods of giving information. It is clear that, if the adversaries signal, the dealer's hand alone is a secret, and he, in addition to his natural advantage, has the further advantage of better information than either of the adversaries. The following signals are, however, used, and are of great trick-making value: playing an unnecessarily high card, whether to one's partner's suit or in discarding in a no-trump declaration, indicates strength in the suit; in a suit declaration a similar method of play indicates two only of the suit and a desire to ruff,—it is best used in the case of a king led by one's partner.

The highest of a sequence led through dummy will frequently tell the third player that he has a good finesse. The lowest of a sequence led through the dealer will sometimes explain the position to the third player, at the same time keeping the dealer in the dark.

When on dummy's left it is futile to finesse against a card not in dummy's hand. But with ace and knave, if dummy has either king or queen, the knave should usually be played, partly because the other high card may be in the leader's hand, partly because, if the finesse fails, the player may still hold a tenace over dummy. When a player is with any chance of success trying to establish his long suit, he should keep every card of it if possible, whether it is a suit already opened or a suit which he wishes his partner to lead; when, however, the main object of the hand is to establish one's partner's suit, it is not necessary for a player to keep his own long suit, and he should pay attention to guarding the other suits. In some circles a discard from a suit is always understood to indicate strength in the suit; this convention, while it makes the game easier for inferior players, frequently causes the player to throw away one of his most valuable cards.

Playing to the Score.—At the beginning of the hand the chances are so great against any particular result, that at the score of love-all the advantage of getting to any particular score has no appreciable

effect in determining the choice of suit. In the play of the hand, the advantage of getting to certain points should be borne in mind. The principal points to be aimed at are 6, 18, and, in a less degree, 22. The reason is that the scores 24, 12 and 8, which will just take the dealer out from the respective points, can each be made in a variety of ways, and are the most common for the dealer to make. The 2 points that take the score from 4 to 6 are worth 4, or perhaps 5, average points; and the 2 points that take the score from 6 to 8 are worth 1 point. When approaching game it is an advantage to make a declaration that may just take the player out, and, in a smaller degree, one that will not exactly take the adversaries out. When the score is 24 to 22 against the dealer, hearts and clubs are half a trick better relatively to diamonds than at the score of love-all. In the first and second games of the rubber the value of each point scored for honours is probably about a half of a point scored for tricks—in a close game rather less, in a one-sided game rather more. In the deciding game of the rubber, on account of the importance of winning the game, the value of each point scored for honours sinks to one-third of a point scored for tricks.

Other Forms of Bridge.—The following varieties of the game are also played:—

Three-handed Bridge.—The three players cut; the one that cuts the lowest card deals, and takes dummy for one deal: each takes dummy in turn. Dummy's cards are dealt face downwards, and the dealer declares without seeing them. If the dealer declares trumps, both adversaries may look at their hands; doubling and redoubling proceeds as at ordinary bridge, but dummy's hand is not exposed till the first card has been led. If the dealer passes the declaration to dummy, his right-hand adversary, who must not have looked at his own hand, examines dummy's, and declares trumps, not, however, exposing the hand. The declaration is forced: with three or four aces *sans atout* (no trumps) must be declared: in other cases the longest suit: if suits are equal in length, the strongest, *i.e.* the suit containing most pips, ace counting eleven, king, queen and knave counting ten each. If suits are equal in both length and strength, the one in which the trick has the higher value must be trumps. On the dummy's declaration the third player can only double before seeing his own cards. When the first card has been led, dummy's hand is exposed, never before the lead. The game is so: the player wins the rubber who is the first to win two games. Fifty points are scored for each game won, and fifty more for the rubber. Sometimes three games are played without reference to a rubber, fifty points being scored for a game won. No tricks score towards game except those which a player wins in his own deal; the value of tricks won in other deals is scored above the line with honours, slam and chicane. At the end of the rubber the totals are added up, and the points won or lost are adjusted thus. Suppose A is credited with 212, B with 290, and C with 312, then A owes 78 to B and 100 to C; B owes 22 to C.

Dummy Bridge.—The player who cuts the lowest card takes dummy. Dummy deals the first hand of all. The player who takes dummy always looks at his own hand first, when he deals for himself or for dummy; he can either declare trumps or "leave it" to dummy. Dummy's declaration is compulsory, as in three-handed bridge. When the dealer deals for dummy, the player on the dealer's left must not look at his cards till either the dealer has declared trumps or the declaration having been left to dummy, his own partner has led a card. The latter can double, but his partner can only double without seeing his hand. The dealer can only redouble on his own hand. When the player of dummy deals for himself, the player on his right hand looks at dummy's hand if the declaration is passed, the positions and restrictions of his partner and himself being reversed. If the player of dummy declares from his own hand, the game proceeds as in ordinary bridge, except that dummy's hand is not looked at till permission to play has been given. When the player on dummy's right deals, dummy's partner may look at dummy's hand to decide if he will double, but he may not look at his own till a card has been led by dummy. In another form of dummy bridge two hands are exposed whenever dummy's adversaries deal, but the game is unsuited for many players, as in every other hand the game is one of double-dummy.

Misery Bridge.—This is a form of bridge adapted for two players. The non-dealer has the dummy, whilst the dealer is allowed to strengthen his hand by discarding four or fewer cards and taking an equal number from the fourth packet dealt; the rest of the cards in that packet are unused and remain unseen. A novel and interesting addition to the game is that the three of clubs (called "Cato") does not rank as a club but can be played as any trick and win it. The dealer, in addition to his other calls, may declare "misery" when he has to make less than two tricks.

Draw- or Two-handed Bridge.—This is the best form of bridge for two players. Each player has a dummy, which is placed opposite to him; but the cards are so arranged that they cannot be seen by his opponent, a special stand being required for the purpose. The dealer makes the declaration or passes it to his dummy to make by the same rules as in three-handed or dummy bridge. The objection to this is that, since the opponent does not see the dealer's dummy, he has no chance of checking an erroneous declaration. This could be avoided by not allowing the dealer the option of passing.

Auction Bridge.—This variety of the game for four players, which adds an element characteristic of poker, appears to have been suggested about 1904, but was really introduced at the Bath Club, London, in 1907, and then was gradually taken up by a wider circle. The laws were settled in August 1908 by a joint committee of the Bath and Portland clubs. The scoring (except as below), value of suits, and play are as at ordinary bridge, but the variety consists in the method of declaration, the declaration not being confined in auction bridge to the dealer or his partner, and the deal being a disadvantage rather than otherwise. The dealer, having examined his hand, *must* declare to win at least one "odd" trick, and then each player in turn, beginning with the one on the dealer's left, has the right to pass the previous declaration, or double, or redouble, or overcall by making a declaration of higher value, any number of times till all are satisfied, the actual play of the combined hands (or what in ordinary bridge would be dealer and dummy) resting eventually with the partners making the final declaration; the partner who made the first call (however small) in the suit finally constituting the trump (or no-trump) plays the hands, the other being dummy. A declaration of a greater number of tricks in a suit of lower value, which equals a previous call in value of points (*e.g.* two in spades as against one in clubs) is "of higher value"; but doubling and redoubling only affect the score and not the declaration, so that a call of two diamonds overalls one no-trump even though this has been doubled. The scoring in auction bridge has the additional element that when the eventual player of the two hands wins what was ultimately declared or more, his side score the full value below the line (as tricks), but if he fails the opponents score 50 points above the line (as honours) for each under-trick (*i.e.* trick short of the declaration), or 100 or 200 if doubled or redoubled, nothing being scored by either side below the line; the loss on a declaration of one spade is limited, however, to a maximum of 100 points. A player whose declaration has been doubled and who fulfils his contract, scores a bonus of 50 points above the line and a further 50 points for each additional trick beyond his declaration; if there was a redouble and he wins, he scores double the bonus. The penalty for a revoke (unaffected by a double) is (1) in the case of the declarer, that his adversaries add 150 above the line; (2) in the case of one of his adversaries, that the declarer may either add 150 points above the line or may take three tricks from his opponents and add them to his own; in the latter case such tricks may assist him to fulfil his contract, but shall not entitle him to any bonus for a double or redouble. A revoking side may score nothing either above or below the line except for honours or chicane. As regards the essential feature of auction bridge, the competitive declaration, it is impossible here to discuss the intricacies involved. It entails, clearly, much reliance on a good partner, since the various rounds of bidding enable good players to draw inferences as to where the cards lie. The game opens the door to much larger scores than ordinary bridge, and since the end only comes from scores made below the line, there are obvious ways of prolonging it at the cost of scores above the line which involve much more of the gambling element. It by no means follows that the winner of the rubber is the winner by points, and many players prefer to go for points (*i.e.* above the line) extorted from their opponents rather than for fulfilling a declaration made by themselves.

AUTHORITIES.—"Hellepont," *Laws and Principles of Bridge*; W. Dalton, *Saturday Bridge*, containing full bibliography (London, 1906); J. B. Elwell, *Advanced Bridge*; R. F. Foster, *Bridge Tactics*; "Badsworth," *Laws and Principles of Bridge*; E. Bergholt, *Double-Dummy Bridge*; *Birlich, or Russian Whist*, pamphlet in Brit. Mus.; W. Dalton, *Auction Bridge* (1908). (W. H. W.)

BRIDGEBUILDING BROTHERHOOD, a confraternity (*Frater Pontifices*) that arose in the south of France during the latter part of the 12th century, and maintained hospices at the chief fords of the principal rivers, besides building bridges and looking after ferries. The brotherhood was recognized by Pope Clement III. in 1189.

BRIDGE-HEAD (*Fr. Ile-du-pont*), in fortification, a work designed to cover the passage of a river by means of fortifications

on one or both banks. As the process of moving an army over bridges is slow and complicated, it is usually necessary to secure it from hostile interruption, and the works constituting the bridge-head must therefore be sufficiently far advanced to keep the enemy's artillery out of range of the bridges. In addition, room is required for the troops to form up on the farther bank. In former days, with short-range weapons, a bridge-head was often little more than a screen for the bridge itself, but modern conditions have rendered necessary far greater extension of bridge defences.

BRIDGEND, a market town in the southern parliamentary division of Glamorganshire, Wales, on both sides of the river Ogwr (whence its Welsh name *Penybont-ar-Ogwr*). Pop. of urban district (1901) 6062. It has a station 165 m. from London on the South Wales trunk line of the Great Western railway, and is the junction of the Barry Company's railway to Barry via Llantwit Major. Bridgend has a good market for agricultural produce, and is an important centre owing to its being the natural outlet for the mining valleys of the Llynvi, Garw and the two Ogwr rivers, which converge about 3 m. north of the town and are connected with it by branch lines of the Great Western railway. Though without large manufacturing industries, the town has joinery works, a brass and iron foundry, a tannery and brewery. There are brick-works and stone quarries, and much lime is burnt in the neighbourhood. Just outside the town at Angelton and Parc Gwyllt are the Glamorgan county lunatic asylums.

There was no civil parish of Bridgend previous to 1905, when one was formed out of portions of the parishes of Newcastle and Coity. Of the castle of Newcastle, built on the edge of a cliff above the church of that parish, there remain a courtyard with flanking towers and a fine Norman gateway. At Coity, about 2 m. distant, there are more extensive ruins of its castle, originally the seat of the Turbervilles, lords of Coity, but now belonging to the earls of Dunraven. Coity church, dating from the 14th century, is a fine cruciform building with central embattled tower in Early Decorated style.

BRIDGE OF ALLAN, a police burgh of Stirlingshire, Scotland. Pop. (1901) 3240. It lies on the Allan, a left-hand tributary of the Forth, 3 m. N. of Stirling by the Caledonian railway and by tramway. Built largely on the well-wooded slopes of Westerton and Airthrey Hill, sheltered by the Ochils from the north and east winds, and environed by charming scenery, it has a great reputation as a health resort and watering-place, especially in winter and spring. There is a pump-room. The chief buildings are the hydropathic and the Macfarlane museum of fine art and natural history. The industries include bleaching, dyeing and paper-making. The Strathallan Gathering, usually held in the neighbourhood, is the most popular athletic meeting in mid-Scotland. Airthrey Castle, standing in a fine park with a lake, adjoins the town on the south-east, and just beyond it are the old church and burying-ground of Logie, beautifully situated at the foot of a granite spur of the Ochil range.

BRIDGEPORT, a city, a port of entry, and one of the county-seats of Fairfield county, Connecticut, U.S.A., co-extensive with the town of Bridgeport, in the S.W. part of the state, on Long Island Sound, at the mouth of the Pequonnock river; about 18 m. S.W. of New Haven. Pop. (1880) 27,643; (1890) 48,866; (1900) 70,996, of whom 22,281 were foreign-born, including 5974 from Ireland, 3172 from Hungary, 2854 from Germany, 2755 from England, and 1436 from Italy; (1910) 102,054. Bridgeport is served by the New York, New Haven & Hartford railway, by lines of coast steamers, and by steamers to New York City and to Port Jefferson, directly across Long Island Sound. The harbour, formed by the estuary of the river and Yellow Mill Pond, an inlet, is excellent. Between the estuary and the pond is a peninsula, East Bridgeport, in which are some of the largest manufacturing establishments, and west of the harbour and the river is the main portion of the city, the wholesale section extending along the bank, the retail section farther back, and numerous factories along the line of the railway far to the westward. There are two large parks,

Beardsley, in the extreme north part of the city, and Seaside, west of the harbour entrance and along the Sound; in the latter are statues of Elias Howe, who built a large sewing-machine factory here in 1863, and of P. T. Barnum, the showman, who lived in Bridgeport after 1846 and died much for the city, especially for East Bridgeport. In Seaside Park there is also a soldiers' and sailors' monument, and in the vicinity are many fine residences. The principal buildings are the St Vincent's and Bridgeport hospitals, the Protestant orphan asylum, the Barnum Institute, occupied by the Bridgeport Scientific and Historical Society and the Bridgeport Medical Society; and the United States government building, which contains the post-office and the customs house.

In 1905 Bridgeport was the principal manufacturing centre in Connecticut, the capital invested in manufacturing being \$49,381,348, and the products being valued at \$44,586,519. The largest industries were the manufacture of corsets—the product of Bridgeport was 19.9% of the total for the United States in 1905, Bridgeport being the leading city in this industry—sewing machines (one of the factories of the Singer Manufacturing Co. is here), steam-fitting and heating apparatus, cartridges (the factory of the Union Metallic Cartridge Co. is here), automobiles, brass goods, phonographs and gramophones, and typewriters. There are also large foundry and machine shops. Here, too, are the winter headquarters of "Barnum and Bailey's circus" and of "Buffalo Bill's Wild West Show." Bridgeport is a port of entry; its imports in 1908 were valued at \$656,271. Bridgeport was originally a part of the township of Stratford. The first settlement here was made in 1659. It was called Pequonnock until 1695, when its name was changed to Stratfield. During the War of Independence it was a centre of privateering. In 1800 the borough of Bridgeport was chartered, and in 1821 the township was incorporated. The city was not chartered until 1836.

See S. Orcutt's *History of the Township of Stratford and the City of Bridgeport* (New Haven, 1886).

BRIDGES, ROBERT (1844—), English poet, born on the 23rd of October 1844, was educated at Eton and at Corpus Christi College, Oxford, and studied medicine in London at St Bartholomew's hospital. He was afterwards assistant physician at the Children's hospital, Great Ormond Street, and physician at the Great Northern hospital, retiring in 1882. Two years later he married Mary, daughter of Alfred Waterhouse, R.A. As a poet Robert Bridges stands rather apart from the current of modern English verse, but his work has had great influence in a select circle, by its restraint, purity, precision, and delicacy yet strength of expression; and it embodies a distinct theory of prosody. His chief critical works are *Milton's Prosody* (1893), a volume made up of two earlier essays (1887 and 1889), and *John Keats, a Critical Essay* (1895). He maintained that English prosody depended on the number of "stresses" in a line, not on the number of syllables, and that poetry should follow the rules of natural speech. His poetry was privately printed in the first instance, and was slow in making its way beyond a comparatively small circle of his admirers. His best work is to be found in his *Shorter Poems* (1890), and a complete edition of his *Poetical Works* (6 vols.) was published in 1908-1909. His chief volumes are *Prometheus* (Oxford, 1883, privately printed), a "mask in the Greek manner"; *Eros and Psyche* (1885), a version of Apuleius; *The Growth of Love*, a series of sixty-nine sonnets printed for private circulation in 1876 and 1880; *Shorter Poems* (1890); *Nero* (1885), a historical tragedy, the second part of which appeared in 1894; *Achilles in Scyros* (1890), a drama; *Palacio* (1890), a romantic drama in the Elizabethan manner; *The Return of Ulysses* (1890), a drama in five acts; *The Christian Captives* (1890), a tragedy on the same subject as Calderon's *El Principe Constante*; *The Humours of the Court* (1893), a comedy founded on the same dramatist's *El secreto á voces* and on Lope de Vega's *El Perro del hortelano*; *The Feast of Bacchus* (1889), partly translated from the *Heautontimoroumenos* of Terence; *Hymns from the Yattendon Hymnal* (Oxford, 1899); and *Demeter, a Mask* (Oxford, 1905).

BRIDGES. 1. Definitions and General Considerations.—Bridges (old forms, *brig*, *brygge*, *brudge*; Dutch, *brug*; German, *Brücke*; a common Teutonic word) are structures carrying roadways, waterways or railways across streams, valleys or other roads or railways, leaving a passage way below. Long bridges of several spans are often termed "viaducts," and bridges carrying canals are termed "aqueducts," though this term is sometimes used for waterways which have no bridge structure. A "culvert" is a bridge of small span giving passage to drainage. In railway work an "overbridge" is a bridge over the railway, and an "underbridge" is a bridge carrying the railway. In all countries there are legal regulations fixing the minimum span and height of such bridges and the width of roadway to be provided. Ordinarily bridges are fixed bridges, but there are also movable bridges with machinery for opening a clear and unobstructed passage way for navigation. Most commonly these are "swing" or "turning" bridges. "Floating" bridges are roadways carried on pontoons moored in a stream.

In classical and medieval times bridges were constructed of timber or masonry, and later of brick or concrete. Then late in the 18th century wrought iron began to be used, at first in combination with timber or cast iron. Cast iron was about the same time used for arches, and some of the early railway bridges were built with cast iron girders. Cast iron is now only used for arched bridges of moderate span. Wrought iron was used on a large scale in the suspension road bridges of the early part of the 19th century. The great girder bridges over the Menai Strait and at Saltash near Plymouth, erected in the middle of the 19th century, were entirely of wrought iron, and subsequently wrought iron girder bridges were extensively used on railways. Since the introduction of mild steel of greater tenacity and toughness than wrought iron (*i.e.* from 1880 onwards) it has wholly superseded the latter except for girders of less than 100 ft. span. The latest change in the material of bridges has been the introduction of ferro-concrete, armoured concrete, or concrete strengthened with steel bars for arched bridges. The present article relates chiefly to metallic bridges. It is only since metal has been used that the great spans of 500 to 1800 ft. now accomplished have been made possible.

2. In a bridge there may be distinguished the *superstructure* and the *substructure*. In the former the main supporting member or members may be an arch ring or arched ribs, suspension chains or ropes, or a pair of girders, beams or trusses. The bridge flooring rests on the supporting members, and is of very various types according to the purpose of the bridge. There is also in large bridges wind-bracing to stiffen the structure against horizontal forces. The *substructure* consists of (a) the piers and end piers or abutments, the former sustaining a vertical load, and the latter having to resist, in addition, the oblique thrust of an arch, the pull of a suspension chain, or the thrust of an embankment; and (b) the foundations below the ground level, which are often difficult and costly parts of the structure, because the position of a bridge may be fixed by considerations which preclude the selection of a site naturally adapted for carrying a heavy structure.

3. *Types of Bridges.*—Bridges may be classed as *arched bridges*, in which the principal members are in compression; *suspension bridges*, in which the principal members are in tension; and *girder bridges*, in which half the components of the principal members are in compression and half in tension. But there are cases of bridges of mixed type. The choice of the type to be adopted depends on many and complex considerations:—(1) The cost, having regard to the materials available. For moderate spans brick, masonry or concrete can be used without excessive cost, but for longer spans steel is more economical, and for very long spans its use is imperative. (2) The importance of securing permanence and small cost of maintenance and repairs has to be considered. Masonry and concrete are more durable than metal, and metal than timber. (3) Aesthetic considerations sometimes have great weight, especially in towns. Masonry bridges are preferable in appearance to any others, and

metal arch bridges are less objectionable than most forms of girder.

Most commonly the engineer has to attach great importance to the question of cost, and to design his structure to secure the greatest economy consistent with the provision of adequate strength. So long as bridge building was an empirical art, great waste of material was unavoidable. The development of the theory of structures has been largely directed to determining the arrangements of material which are most economical, especially in the superstructure. In the case of bridges of large span the cost and difficulty of erection are serious, and in such cases facility of erection becomes a governing consideration in the choice of the type to be adopted. In many cases the span is fixed by local conditions, such as the convenient sites for piers, or the requirements of waterway or navigation. But here also the question of economy must be taken into the reckoning. The cost of the superstructure increases very much as the span increases, but the greater the cost of the substructure, the larger the span which is economical. Broadly, the least costly arrangement is that in which the cost of the superstructure of a span is equal to that of a pier and foundation.

For masonry, brick or concrete the arch subjected throughout to compression is the most natural form. The arch ring can be treated as a blockwork structure composed of rigid voussoirs. The stability of such structures depends on the position of the line of pressure in relation to the extrados and intrados of the arch ring. Generally the line of pressure lies within the middle half of the depth of the arch ring. In finding the line of pressure some principle such as the principle of least action must be used in determining the reactions at the crown and springings, and some assumptions must be made of not certain validity. Hence to give a margin of safety to cover contingencies not calculable, an excess of material must be provided. By the introduction of hinges the position of the line of resistance can be fixed and the stress in the arch ring determined with less uncertainty. In some recent masonry arched bridges of spans up to 150 ft. built with hinges considerable economy has been obtained.

For an elastic arch of metal there is a more complete theory, but it is difficult of application, and there remains some uncertainty unless (as is now commonly done) hinges are introduced at the crown and springings.

In suspension bridges the principal members are in tension, and the introduction of iron link chains about the end of the 18th century, and later of wire ropes of still greater tenacity, permitted the construction of road bridges of this type with spans at that time impossible with any other system of construction. The suspension bridge dispenses with the compression member required in girders and with a good deal of the stiffening required in metal arches. On the other hand, suspension bridges require lofty towers and massive anchorages. The defect of the suspension bridge is its flexibility. It can be stiffened by girders and bracing and is then of mixed type, when it loses much of its advantage in economy. Nevertheless, the stiffened suspension bridge will probably be the type adopted in future for very great spans. A bridge on this system has been projected at New York of 3200 ft. span.

The immense extension of railways since 1830 has involved the construction of an enormous number of bridges, and most of these are girder bridges, in which about half the superstructure is in tension and half in compression. The use of wrought iron and later of mild steel has made the construction of such bridges very convenient and economical. So far as superstructure is concerned, more material must be used than for an arch or chain, for the girder is in a sense a combination of arch and chain. On the other hand, a girder imposes only a vertical load on its piers and abutments, and not a horizontal thrust, as in the case of an arch or suspension chain. It is also easier to erect.

A fundamental difference in girder bridges arises from the mode of support. In the simplest case the main girders are supported at the ends only, and if there are several spans they are *discontinuous* or *independent*. But a main girder may be supported at two or more points so as to be *continuous* over two

or more spans. The continuity permits economy of weight. In a three-span bridge the theoretical advantage of continuity is about 49% for a dead load and 16% for a live load. The objection to continuity is that very small alterations of level of the supports due to settlement of the piers may very greatly alter the distribution of stress, and render the bridge unsafe. Hence many multiple-span bridges such as the Hawkesbury, Benares and Chittravatti bridges have been built with independent spans.

Lastly, some bridges are composed of cantilevers and suspended girders. The main girder is then virtually a continuous girder hinged at the points of contrary flexure, so that no ambiguity can arise as to the stresses.

Whatever type of bridge is adopted, the engineer has to ascertain the loads to be carried, and to proportion the parts so that the stresses due to the loads do not exceed limits found by experience to be safe. In many countries the limits of working stress in public and railway bridges are prescribed by law. The

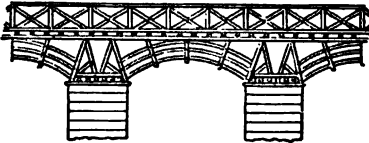

FIG. 1.—Trajan's Bridge.

development of theory has advanced *pari passu* with the demand for bridges of greater strength and span and of more complex design, and there is now little uncertainty in calculating the stresses in any of the types of structure now adopted. In the modern metal bridge every member has a definite function and is subjected to a calculated straining action. Theory has been the guide in the development of bridge design, and its trustworthiness is completely recognized. The margin of uncertainty which must be met by empirical allowances on the side of safety has been steadily diminished.

The larger the bridge, the more important is economy of material, not only because the total expenditure is more serious, but because as the span increases the dead weight of the structure becomes a greater fraction of the whole load to be supported. In fact, as the span increases a point is reached at which the dead weight of the superstructure becomes so large that a limit is imposed to any further increase of span.

HISTORY OF BRIDGE BUILDING

4. *Roman Bridges.*—The first bridge known to have been constructed at Rome over the Tiber was the timber Pons Sub-

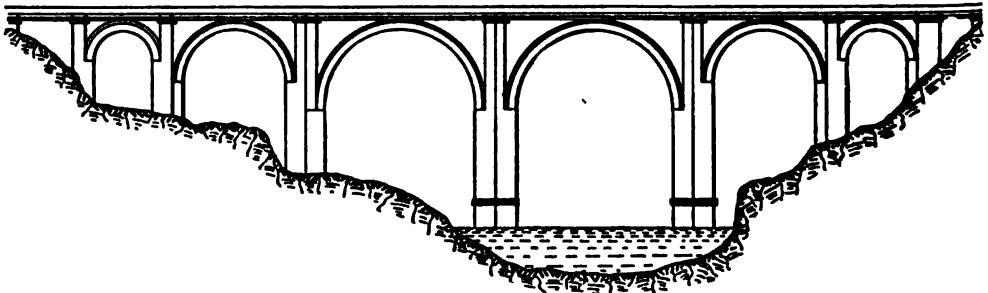

FIG. 2.—Bridge of Alcántara.

licius, the bridge defended by Horatius. The Pons Milvius, now Ponte Molle, was reconstructed in stone by M. Aemilius Scaurus in 109 B.C., and some portions of the old bridge are believed to exist in the present structure. The arches vary from 51 to 79 ft. span. The Pons Fabricius (mod. Ponte dei

Quattro Capi), of about 62 B.C., is practically intact; and the Pons Cestius, built probably in 46 B.C., retains much of the original masonry. The Pons Aelius, built by Hadrian A.D. 134 and repaired by Pope Nicholas II. and Clement IX., is now the bridge of St. Angelo. It had eight arches, the greatest span

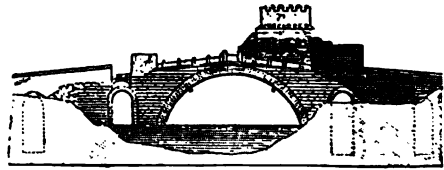

FIG. 3.—Ponte Salario.

being 62 ft.¹ Dio Cassius mentions a bridge, possibly 3000 to 4000 ft. in length, built by Trajan over the Danube in A.D. 104. Some piers are said still to exist. A bas-relief on the Trajan column shows this bridge with masonry piers and timber arches, but the representation is probably conventional (fig. 1). Trajan also constructed the bridge of Alcántara in Spain (fig. 2), of a total length of 670 ft., at 210 ft. above the stream. This had six arches and was built of stone blocks without cement. The bridge of Narses, built in the 6th century (fig. 3), carried the Via Salaria over the Anio. It was destroyed in 1867, during the approach of Garibaldi to Rome. It had a fortification such as became usual in later bridges for defence or for the enforcement of tolls. The great lines of aqueducts built by Roman engineers, and dating from 300 B.C. onwards, where they are carried above



FIG. 4.—First Span of Schaffhausen Bridge.

ground, are arched bridge structures of remarkable magnitude (see AQUEDUCTS, § Roman). They are generally of brick and concrete.

5. *Medieval and other Early Bridges.*—Bridges with stone piers and timber superstructures were no doubt constructed from Roman times onward, but they have perished. Fig. 4 shows a timber bridge erected by the brothers Grubenmann at Schaffhausen about the middle of the 18th century. It had spans of 172 and 193 ft., and may be taken as a representative

type of bridges of this kind. The Wittingen bridge by the same engineers had a span of 390 ft., probably the longest timber

¹ For the ancient bridges in Rome see further ROWE: *Archæology*, and such works as R. Lanciani, *Ruins and Excavations of Ancient Rome* (Eng. trans., 1897), pp. 16 foll.¹

span ever constructed. Of stone bridges in Great Britain, the earliest were the cyclopean bridges still existing on Dartmoor, consisting of stone piers bridged by stone slabs. The bridge over the East Dart near Tavistock had three piers, with slabs

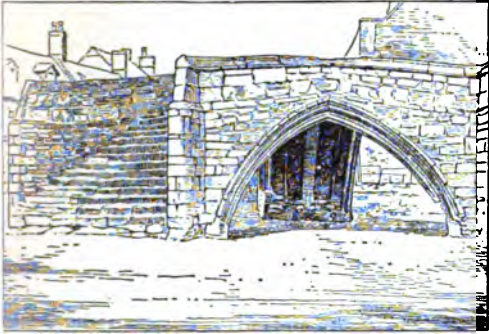

FIG. 5.—Crowland Bridge.

15 ft. by 6 ft. (Smiles, *Lives of the Engineers*, ii. 43). It is reputed to have lasted for 2000 years.

The curious bridge at Crowland near Peterborough (fig. 5) which now spans roadways, the streams which formerly flowed under it having been diverted, is one of the earliest known stone bridges in England. It is referred to in a charter of the year 943. It was probably built by the abbots. The first bridges over the Thames at London were no doubt of timber. William of Malmesbury mentions the existence of a bridge in 994. J. Stow (*Survey of the Cities of London and Westminster*) describes

was destroyed for military reasons by Carmagnola in 1416. The Rialto bridge at Venice, with a span of 91 ft., was built in 1588 by Antonio da Ponte. Fig. 7 shows the beautiful Ponte della Trinità erected at Florence in 1566 from the design of B. Ammannati.

6. *Modern Bridges.*—(a) *Timber.*—In England timber bridges of considerable span, either braced trusses or laminated arches (*i.e.* arches of planks bolted together), were built for some of the earlier railways, particularly the Great Western and the Manchester, Sheffield & Lincolnshire. They have mostly been replaced, decay having taken place at the joints. Timber bridges of large span were constructed in America between the end of the 18th and the middle of the 19th century. The Amoskeag bridge over the Merrimac at Manchester, N.H., U.S.A., built in 1792, had 6 spans of 92 ft. The Bellows Falls bridge over the Connecticut (built 1785-1792) had 2 spans of 184 ft. The singular Colossus bridge, built in 1812 over the Schuylkill, a kind of flat arched truss, had a span of 340 ft. Some of these timber bridges are said to have lasted ninety years with ordinary repairs, but they were road bridges not heavily loaded. From 1840, trusses, chiefly of timber but with wrought-iron tension-rods and cast-iron shoes, were adopted in America. The Howe truss of 1830 and the Pratt truss of 1844 are examples. The Howe truss had timber chords and a lattice of timber struts, with vertical iron ties. In the Pratt truss the struts were vertical and the ties inclined. Down to 1850 such bridges were generally limited to 150 ft. span. The timber was white pine. As railway loads increased and greater spans were demanded, the Howe truss was stiffened by timber arches on each side of each girder. Such a composite structure is, however, fundamentally defective, the distribution of loading to the two independent systems being indeterminate. Remarkably high timber piers were built. The Genesee viaduct, 800 ft. in length, built in 1851-1852 in 10 spans, had timber trestle piers 190 ft. in



From J. R. Green's *A Short History of the English People*, by permission of Macmillan & Co., Ltd.

FIG. 6.—Old London Bridge, A.D. 1600. From a Drawing in the Pepysian Library, Magdalene College, Cambridge.

the building of the first stone bridge commonly called Old London Bridge: "About the year 1176, the stone bridge was begun to be founded by Peter of Colechurch, near unto the bridge of timber, but more towards the west." It carried timber houses (fig. 6) which were frequently burned down, yet the main structure existed till the beginning of the 19th century. The span of the arches ranged from 10 to 33 ft., and the total waterway was only 337 ft. The waterway of the present London Bridge is 690 ft., and the removal of the obstruction caused by the old bridge caused a lowering of the low-water level by 5 ft.,

height. (See Mosse, "American Timber Bridges," *Proc. Inst. C.E.* xxii. p. 305, and for more modern examples, cxlii. p. 409; and clv. p. 382; Cooper, "American Railroad Bridges," *Trans. Am. Soc. C.E.* vol. xxi. pp. 1-28.) These timber framed structures served as models for the earlier metal trusses which began to be used soon after 1850, and which, except in a few localities where iron is costly, have quite superseded them.

7. (b) *Masonry.*—The present London Bridge, begun in 1824 and completed in 1831, is as fine an example of a masonry arch structure as can be found (figs. 8 and 9). The design was made



FIG. 7.—Ponte della Trinità, Florence.

and a considerable deepening of the river-bed. (See Smiles, *Lives of the Engineers*, "Rennie.")

The architects of the Renaissance showed great boldness in their designs. A granite arch built in 1377 over the Adda at Trezzo had a span at low water of 251 ft. This noble bridge

by John Rennie the elder, and the acting engineer was his son, Sir John Rennie. The semi-elliptical shape of the arches, the variation of span, the slight curvature of the roadway, and the simple yet bold architectural details, combine to make

it a singularly beautiful bridge. The centre arch has a span of 152 ft., and rises 29 ft. 6 in. above Trinity high-water mark; the arches on each side of the centre have a span of 140 ft., and the abutment arches 130 ft. The total length of the bridge is 1005 ft., its width from outside to outside 56 ft., and height above low

water 60 ft. The two centre piers are 24 ft. thick, the exterior stones are granite, the interior, half Bramley Fall and half from Painsshaw, Derbyshire. The voussoirs of the centre arch (all of granite) are 4 ft. 9 in. deep at the crown, and increase to not less than 9 ft. at the springing. The general depth at which the foundations are laid is about 29 ft. 6 in. below low water. The total cost was £1,458,311, but the contractor's tender for the bridge alone was £425,081.

Since 1867 it had been recognized that London Bridge was inadequate to carry the traffic passing over it, and a scheme for widening it was adopted in 1900. This was carried out in 1902-

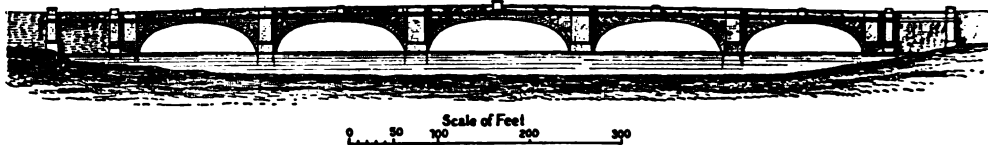

FIG. 8.—London New Bridge.

1904, the footways being carried on granite corbels, on which are mounted cornices and open parapets. The width between parapets is now 65 ft., giving a roadway of 35 ft. and two footways of 15 ft. each. The architect was Andrew Murray and the engineer, G. E. W. Cruttwell. (Cole, *Proc. Inst. C.E.* cli. p. 290.)

The largest masonry arch is the Adolphe bridge in Luxemburg, erected in 1900-1903. This has a span of 278 ft., 138 ft. rise above the river, and 102 ft. from foundation to crown. The thickness of the arch is 4 ft. 8 in. at the crown and 7 ft. 2 in. where it joins the spandrel masonry. The roadway is 52 ft. 6 in. wide. The bridge is not continuous in width, there are arch rings on each face, each 16.4 ft. wide with a space between of 19.7 ft. This space is filled with a flooring of reinforced concrete, resting on the two arches, and carrying the central roadway. By the method adopted the total masonry has been reduced one-third. One centering was used for the two arch rings, supported on dwarf walls which formed a slipway, along which it was moved after the first arch was built.

Till near the end of the 19th century bridges of masonry or brickwork were so constructed that they had to be treated as rigid blockwork structures. The stability of such structures depends on the position of the line of pressure relatively to the intrados and extrados of the arch ring. Generally, so far as

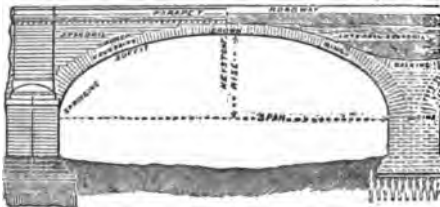

FIG. 9.—Half Elevation and Half Section of Arch of London Bridge.

could be ascertained, the line of pressure lies within the middle half of the depth of the voussoirs. In finding the abutment reactions some principle such as the principle of least action must be used, and some assumptions of doubtful validity made. But if hinges are introduced at crown and springings, the calculation of the stresses in the arch ring becomes simple, as the line of pressures must pass through the hinges. Such hinges have been used not only for metal arches, but in a modified form for masonry and concrete arches. Three cases therefore arise: (a) The arch is rigid at crown and springings; (b) the arch is two-hinged (hinges at springings); (c) the arch is three-hinged (hinges at crown and springings). For an elementary account of the theory of arches, hinged or not, reference may be made to a

paper by H. M. Martin (*Proc. Inst. C. E.* vol. xciii. p. 462); and for that of the elastic arch, to a paper by A. E. Young (*Proc. Inst. C. E.* vol. cxxxi. p. 323).

In Germany and America two- and three-hinged arches of masonry and concrete have been built, up to 150 ft. span, with much economy, and the calculations being simple, an engineer can venture to work closely to the dimensions required by theory. For hinges, Leibbrand of Stuttgart, uses sheets of lead about 1 in. thick extending over the middle third of the depth of the voussoir joints, the rest of the joints being left open. As the lead is plastic this construction is virtually an articulation. If the pressure on the lead is uniformly varying, the centre of pressure must be within the middle third of the width of the lead; that is, it cannot deviate from the centre of the voussoir

joint by more than one-eighteenth of its depth. In any case the position of the line of pressures is confined at the lead articulation within very narrow limits, and ambiguity as to the stresses is greatly diminished. The restricted area on which the pressure acts at the lead joints involves greater intensity of stress than has been usual in arched bridges. In the Württemberg hinged arches a limit of stress of 110 tons per sq. ft. was allowed, while in the unhinged arches at Cologne and Coblent the limit was 50 to 60 tons per sq. ft. (*Annales des Ponts et Chaussées*, 1891). At Rechtenstein a bridge of two concrete arches has been constructed, span 751 ft., with lead articulations: width of arch 11 ft.; depth of arch at crown and springing 2.1 and 2.96 ft. respectively. The stresses were calculated to be 15, 17 and 12 tons per sq. ft. at crown, joint of rupture, and springing respectively. At Cincinnati a concrete arch of 70 ft. span has been built, with a rise of 10 ft. The concrete is reinforced by eleven 9-in. steel-rolled joints, spaced 3 ft. apart and supported by a cross-chained joint at each springing. The arch is 15 in. thick at the crown and 4 ft. at the abutments. The concrete consisted of 1 cement, 2 sand and 3 to 4 broken stone. An important series of experiments on the strength of masonry, brick and concrete structures will be found in the *Zeitschr. des österreichischen Ing. und Arch. Vereins* (1895).

The thermal coefficient of expansion of steel and concrete is nearly the same, otherwise changes of temperature would cause shearing stress at the junction of the two materials. If the two materials are disposed symmetrically, the amount of load carried by each would be in direct proportion to the coefficient of elasticity and inversely as the moment of inertia of the cross section. But it is usual in many cases to provide a sufficient section of steel to carry all the tension. For concrete the coefficient of elasticity E varies with the amount of stress and diminishes as the ratio of sand and stone to cement increases. Its value is generally taken at 1,500,000 to 3,000,000 lb per sq. in. For steel $E = 28,000,000$ to 30,000,000, or on the average about twelve times its value for concrete. The maximum compressive working stress on the concrete may be 500 lb per sq. in., the tensile working stress 50 lb per sq. in., and the working shearing stress 75 lb per sq. in. The tensile stress on the steel may be 16,000 lb per sq. in. The amount of steel in the structure may vary from 0.75 to 1.5%. The concrete not only affords much of the strength to resist compression, but effectively protects the steel from corrosion.

8. (c) *Suspension Bridges*.—A suspension bridge consists of two or more chains, constructed of links connected by pins, or of twisted wire strands, or of wires laid parallel. The chains pass over lofty piers on which they usually rest on saddles carried by rollers, and are led down on either side to anchorages in rock chambers. A level platform is hung from the chains by suspension rods. In the suspension bridge iron or steel can be used in its strongest form, namely hard-drawn wire. Iron suspension bridges began to be used at the end of the 18th century for road bridges with spans unattainable at that time in any other system. In 1819 T. Telford began the construction of the Menai bridge (fig. 10), the span being 570 ft. and the dip 43 ft. This bridge suffered some injury in a storm, but it is still in good condition and one of the most graceful of bridges. Other bridges built soon after were the Fribourg bridge of 870 ft. span, the Hammersmith bridge of 422 ft. span, and the Pest bridge of 666 ft. span. The merit of the simple suspension bridge is its cheapness, and its defect is its flexibility. This last becomes less

serious as the dead weight of the structure becomes large in proportion to the live or temporary load. It is, therefore, a type specially suited for great spans. Some suspension bridges have broken down in consequence of the oscillations produced by bodies of men marching in step. In 1850 a suspension bridge

cable was carried on a separate saddle on rollers on each pier. The stiffening girder, constructed chiefly of timber, was a box-shaped braced girder 18 ft. deep and 25 ft. wide, carrying the railway on top and a roadway within. After various repairs and strengthenings, including the replacement of the timber girder by an iron one in 1880, this bridge in 1896-1897 was taken down and a steel arch built

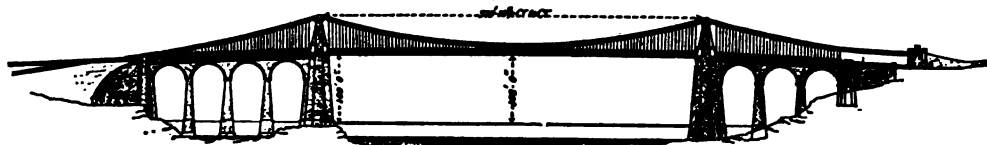

FIG. 10.—Menai Suspension Bridge.

at Angers gave way when 487 soldiers were marching over it, and 226 were killed.

To obtain greater stiffness various plans have been adopted. In the Ordish system a certain number of intermediate points in the span are supported by oblique chains, on which girders rest. The Ordish bridge built at Prague in 1868 had oblique chains supporting the stiffening girders at intermediate points of the span. A curved chain supported the oblique chains and kept them straight. In 1860 a bridge was erected over the Danube canal at Vienna, of 264 ft. span which had two parallel chains one above the other and 4 ft. apart on each side of the bridge. The chains of each pair were connected by bracing so that they formed a stiff inverted arch resisting deformation

in its place. It was not strong enough to deal with the increasing weight of railway traffic. In 1836 J. K. Brunel constructed the towers and abutments for a suspension bridge of 702 ft. span at Clifton over the Avon, but the project was not then carried further; in 1860, however, the link chains of the Hungerford suspension bridge which was being taken down were available at small cost, and these were used to complete the bridge. There are three chains on each side, of one and two links alternately, and these support wrought iron stiffening girders. There are wrought iron saddles and steel rollers on the piers. At 196 ft. on either side from the towers the chains are carried over similar saddles without rollers, and thence at 45° with the horizontal down to the anchorages. Each chain has an anchor plate 5 ft. by 6 ft. The links are 24 ft. long at the centre of the bridge, and longer as they are more inclined, so that their horizontal projection is 24 ft. The chains are so arranged that there is a suspending rod at each 8 ft., attached at the joint of one of the

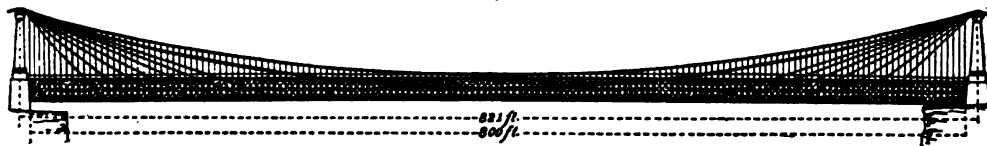

FIG. 11.—Niagara Suspension Bridge.

under unequal loading. The bridge carried a railway, but it proved weak owing to errors of calculation, and it was taken down in 1884. The principle was sound and has been proposed at various times. About 1850 it was perceived that a bridge stiff enough to carry railway trains could be constructed by combining supporting chains with stiffening girders suspended from them. W. J. M. Rankine proved (*Applied Mechanics*, p. 370) that the necessary strength of a stiffening girder would be only one-seventh part of that of an independent girder of the same span as the bridge, suited to carry the same moving load (not including the dead weight of the girder which is supported by the chain). (See "Suspension Bridge with Stiffened Roadway," by Sir G. Airy, and the discussion, *Proc. Inst. C.E.*,

three chains. For erection a suspended platform was constructed on eight wire ropes, on which the chains were laid out and connected. Another wire rope with a travelling carriage took out the links. The sectional area of the chains is 481 sq. in. at the piers and 440 sq. in. at the centre. The two stiffening girders are plate girders 3 ft. deep with flanges of 11 sq. in. area. In addition, the hand railing on each side forms a girder 4 ft. 9 in. deep, with flanges 4½ sq. in. area.

Of later bridges of great span, perhaps the bridges over the East river at New York are the most remarkable. The Brooklyn bridge, begun in 1872, has a centre span of 1595 ft. and side spans of 930 ft. The Brooklyn approach being 971 ft., and the New York approach 1562 ft., the total length of the bridge is 5989 ft. There are four cables which carry a promenade, a roadway and an electric railway. The stiffening girders of the main span are 40 ft. deep and 67 ft. apart. The saddles for the chains are 329 ft. above high water.

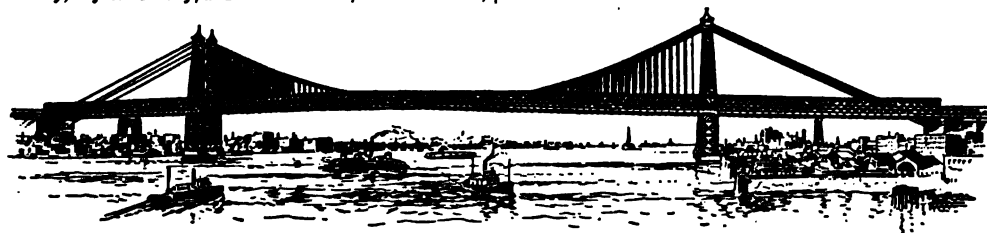

FIG. 12.—Williamsburg Bridge, New York.

1867, xvi. p. 258; also "Suspension Bridges with Stiffening Girders," by Max am Ende, *Proc. Inst. C.E.* cxxxvii. p. 306.)

The most remarkable bridge constructed on this system was the Niagara bridge built by J. A. Roebling in 1852-1855 (fig. 11). The span was 821 ft., much the largest of any railway bridge at that time, and the height above the river 245 ft. There were four suspension cables, each 10 in. in diameter; each was composed of seven strands, containing 320 parallel wires, or 3640 wires in each cable. Each

The cables are 1½ in. in diameter. Each cable has 19 strands of 278 parallel steel wires, 7 B.W.G. Each wire is taken separately across the river and its length adjusted. Roebling preferred parallel wires as 10% stronger than twisted wires. Each strand when made up and clamped was lowered to its position. The Williamsburg bridge (fig. 12), begun in 1897 and opened for traffic in 1903, has a span of 1600 ft., a versed sine of 176 ft., and a width of 118 ft. It has two decks, and carries two elevated railway tracks, four electric tramcar lines, two carriageways, two footways and two

bicycle paths. There are four cables, one on each side of the two main trusses or stiffening girders. These girders are supported by the cables over the centre span but not in the side spans. Intermediate piers support the trusses in the side spans. The cables are 18½ in. in diameter; each weighs about 1116 tons, and has a nominal breaking strength of 22,320 tons, the actual breaking strength being

the floor into rectangles 3 ft. by 3½ ft. covered with beaded plates. The roadway is of pine blocks dowelled. The bascules rotate through an angle of 82°, and their rear ends in the bascule chambers of the piers carry 365 tons of counterweight, the total weight of each being 1070 tons. They rotate on steel shafts 21 in. in diameter and 48 ft. long, and the bascules can be lifted or lowered in one minute.

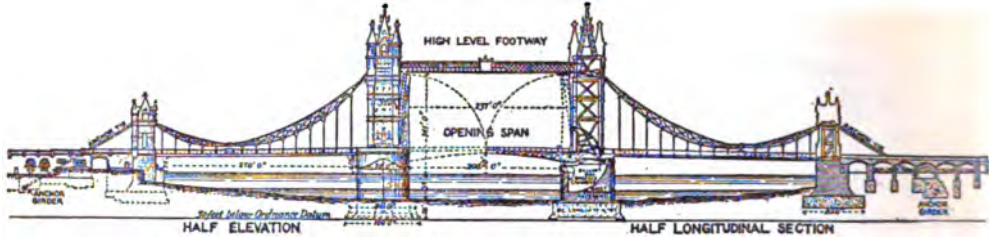

FIG. 13.—Tower Bridge, London.

probably greater. The saddles are 332 ft. above the water. The four cables support a dead load of 7140 tons and a live load of 4017 tons. Each cable is composed of 37 strands of 208 wires, or 7696 parallel steel wires, No. 8 B.W.G., or about ⅜ in. in diameter. The wire was required to have a tensile strength of 89 tons per sq. in., and 2½% elongation in 5 ft. and 5% in 8 in. Cast steel clamps hold the cable together, and to these the suspending rods are attached. The cables are wrapped in cotton duck soaked in oxidized oil and varnish, and are sheathed in sheet iron. A later bridge, the Manhattan, is designed to carry four railway tracks and four tramway lines, with a wide roadway and footpaths, supported by cables 21½ in. in diameter, each composed of 9472 galvanized steel wires ⅜ in. in diameter.

The Tower Bridge, London (fig. 13), is a suspension bridge with a secondary bascule bridge in the centre span to permit the passage of ships. Two main towers in the river and two towers on the shore abutments carry the suspension chains. The opening bridge between the river towers consists of two leaves or bascules, pivoted near the faces of the piers and rotating in a vertical plane. When raised, the width of 200 ft. between the main river piers is unobstructed up to the high-level foot-bridge, which is 141 ft. above Trinity H.W. The clear width of the two shore spans is 270 ft. The total length of the bridge is 940 ft., and that of the approaches 1260 ft. on the north and 780 ft. on the south. The width of the bridge between parapets is 60 ft., except across the centre span, where it is 49 ft. The main towers consist of a skeleton of steel, enclosed in a facing of granite and Portland stone, backed with brickwork. There are two high-level footways for use when the bascules are raised, the main girders of which are of the cantilever and suspended girder type. The cantilevers are fixed to the shore side of the towers. The middle girders are 120 ft. in length and attached to the cantilevers by links. The main suspension chains are carried across the centre span in the form of horizontal ties resting on the high-level footway girders. These ties are jointed to the hanging chains by pins 20 in. in diameter with a ring in halves surrounding it 3 in. thick. One half ring is rigidly attached to the tie and one to the hanging chain, so that the wear due to any movement is distributed over the length of the pin. A rocker bearing under these pins transmits the load at the joint to the steel columns of the towers. The abutment towers are similar to the river towers. On the abutment towers the chains are connected by horizontal links, carried on rockers, to anchor ties. The suspension chains are constructed in the form of braced girders, so that they are stiff against unsymmetrical loading. Each chain over a shore span consists of two segments, the longer attached to the tie at the top of the river tower, the shorter to the link at the top of the abutment tower, and the two jointed together at the lowest point. Transverse girders are hung from the chains at distances of 18 ft. There are fifteen main transverse girders to each shore span, with nine longitudinal girders between each pair. The trough flooring, ⅝ in. thick and 6 in. deep, is riveted to the longitudinals. The anchor ties are connected to girders embedded in large concrete blocks in the foundations of the approach viaducts.

The two bascules are each constructed with four main girders. Over the river these are lattice girders, with transverse girders 12 ft. apart, and longitudinal and subsidiary transverse girders dividing

but usually the time taken is one and a half minutes. They are worked by hydraulic machinery.

9. (d) *Iron and Steel Girder Bridges*.—The main supporting members are two or more horizontal beams, girders or trusses. The girders carry a floor or platform either on top (*deck* bridges) or near the bottom (*through* bridges). The platform is variously constructed. For railway bridges it commonly consists of cross girders, attached to or resting on the main girders, and longitudinal rail girders or stringers carried by the cross girders and directly supporting the sleepers and rails. For spans over 75 ft., expansion due to change of temperature is provided for by carrying one end of each chain girder on rollers placed between the bearing-plate on the girder and the bed-plate on the pier or abutment.

Fig. 14 shows the roller bed of a girder of the Kulenbury bridge of 490 ft. span. It will be seen that the girder directly rests on a cylindrical pin or rocker so placed as to distribute the load uniformly to all the rollers. The pressure on the rollers is limited to about $p = 600 d$ in lb per in. length of roller, where d is the diameter of the roller in inches.

In the girders of bridges the horizontal girder is almost exclusively subjected to vertical loading forces. Investigation

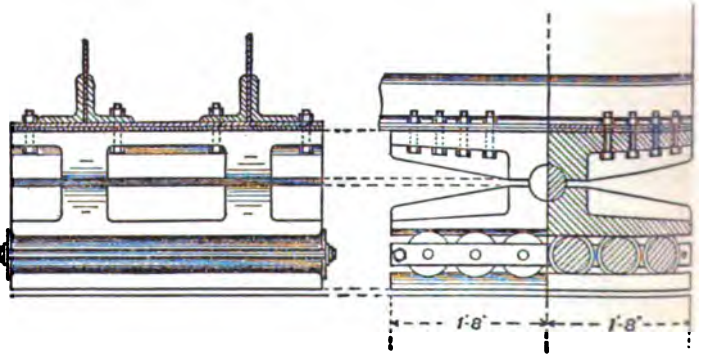

FIG. 14.—Roller Bed of a Girder.

of the internal stresses, which balance the external forces, shows that most of the material should be arranged in a top flange, boom or chord, subjected to compression, and a bottom flange or chord, subjected to tension. (See *STRENGTH OF MATERIALS*.) Connecting the flanges is a vertical web which may be a solid plate or a system of bracing bars. In any case, though the exact form of cross section of girders varies very much, it is virtually an I section (fig. 15). The function of the flanges is to resist a horizontal tension and compression distributed practically uniformly on their cross sections. The web resists forces equivalent

to a shear on vertical and horizontal planes. The inclined tensions and compressions in the bars of a braced web are equivalent to this shear. The horizontal stresses in the flanges are greatest at the centre of a span.

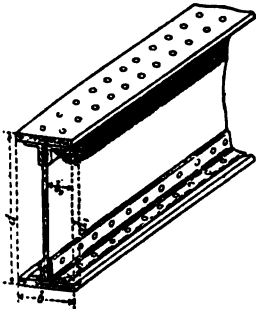

FIG. 15.—Flanged Girder.

The stresses in the web are greatest at the ends of the span. In the most numerous cases the flanges or chords are parallel. But girders may have curved chords and then the stresses in the web are diminished. At first girders had solid or plate webs, but for spans over 100 ft. the web always now consists of bracing bars. In some girder bridges the members are connected entirely by riveting, in others the principal members are connected by pin joints. The pin system of connexion used in the Chepatow, Salt-

ash, Newark Dyke and other early English bridges is now rarely used in Europe. But it is so commonly used in America as to be regarded as a distinctive American feature. With pin connexions some weight is saved in the girders, and erection is a little easier. In early pin bridges insufficient bearing area was allowed between the pins and parts connected, and they worked loose. In some cases riveted covers had to be substituted for the pins. The proportions are now better understood. Nevertheless the tendency is to use riveted connexions in preference to pins, and in any case to use pins for tension members only.

On the first English railways cast iron girder bridges for spans of 20 to 66 ft. were used, and in some cases these were trussed with wrought iron. When in 1845 the plans for carrying the Chester and Holyhead railway over the Menai Straits were considered, the conditions imposed by the admiralty in the interests of navigation involved the adoption of a new type of bridge. There was an idea of using suspension chains combined with a girder, and in fact the tower piers were built so as to accommodate chains. But the theory of such a combined structure could not be formulated at that time, and it was proved, partly by experiment, that a simple tubular girder of wrought iron was strong enough to carry the railway. The Britannia bridge (fig. 16) has two spans of 460 and two of 230 ft. at 104 ft. above high water. It consists of a pair of tubular girders with solid or plate sides stiffened by angle irons, one line of rails passing through each tube. Each girder is 1511 ft. long and weighs 4680 tons. In cross section (fig. 17), it is 15 ft. wide and varies in depth from 23 ft. at the ends to 30 ft. at the centre. Partly to counteract any tendency to buckling under compression and partly for convenience in assembling a great mass of plates, the top and bottom were made cellular, the cells being just large enough to permit passage for painting. The total

Eaton Hodgkinson, who assisted in the experimental tests and in formulating the imperfect theory then available. The Conway bridge was first completed, and the first train passed through the Britannia bridge in 1850. Though each girder has been made continuous over the four spans it has not quite the proportions over the piers which a continuous girder should have,

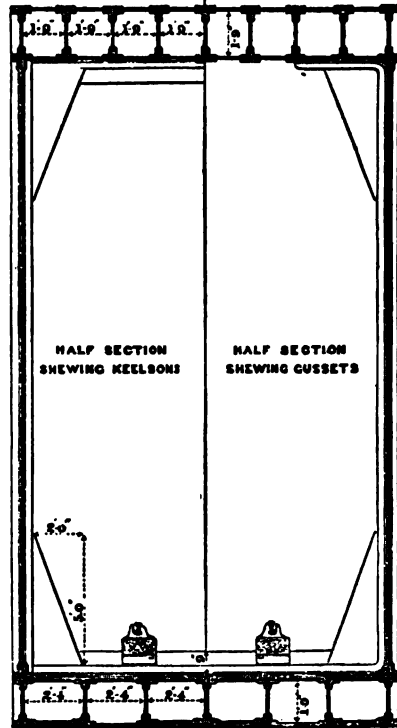

FIG. 17.—Britannia Bridge (Cross Section of Tubular Girder).

and must be regarded as an imperfectly continuous girder. The spans were in fact designed as independent girders, the advantage of continuity being at that time imperfectly known. The vertical sides of the girders are stiffened so that they amount to 40% of the whole weight. This was partly necessary to meet the uncertain conditions in floating when the distribution of supporting forces was unknown and there were chances of distortion.

Wrought iron and, later, steel plate web girders were largely

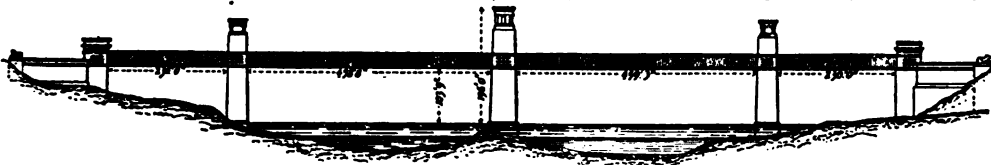

FIG. 16.—Britannia Bridge.

area of the cellular top flange of the large-span girders is 648 sq. in., and of the bottom 585 sq. in. As no scaffolding could be used for the centre spans, the girders were built on shore, floated out and raised by hydraulic presses. The credit for the success of the Conway and Britannia bridges must be divided between the engineers, Robert Stephenson and William Fairbairn, and

used for railway bridges in England after the construction of the Conway and Menai bridges, and it was in the discussions arising during their design that the proper function of the vertical web between the top and bottom flanges of a girder first came to be understood. The proportion of depth to span in the Britannia bridge was $\frac{1}{18}$. But so far as the flanges are concerned the stress

to be resisted varies inversely as the depth of the girder. It would be economical, therefore, to make the girder very deep. This, however, involves a much heavier web, and therefore for any type of girder there must be a ratio of depth to span which is most economical. In the case of the plate web there must be a considerable excess of material, partly to stiffen it against buckling and partly because an excess of thickness must be provided to reduce the effect of corrosion. It was soon found that with plate webs the ratio of depth to span could not be economically increased beyond $\frac{1}{4}$ to $\frac{1}{5}$. On the other hand a framed or braced web afforded opportunity for much better arrangement of material, and it very soon became apparent that open web or lattice or braced girders were more economical of material than solid web girders, except for small spans. In America such girders were used from the first and naturally followed the general design of the earlier timber bridges. Now plate web girders are only used for spans of less than 100 ft.

Three types of bracing for the web very early developed—the Warren type in which the bracing bars form equilateral triangles, the Whipple Murphy in which the struts are vertical and the ties inclined, and the lattice in which both struts and ties are inclined at equal angles, usually 45° with the horizontal. The earliest published theoretical investigations of the stresses in bracing bars were perhaps those in the paper by W. T. Doyne and W. B. Blood (*Proc. Inst. C.E.*, 1851, xi. p. 1), and the paper by J. Barton, "On the economic distribution of material in the sides of wrought iron beams" (*Proc. Inst. C.E.*, 1855, xiv. p. 443).

The Boyne bridge, constructed by Barton in Ireland, in



FIG. 18.—Span of Saltash Bridge.

1854-1855, was a remarkable example of the confidence with which engineers began to apply theory in design. It was a bridge for two lines of railway with lattice girders continuous over three spans. The centre span was 264 ft., and the side spans 138 ft. 8 in.; depth 22 ft. 6 in. Not only were the bracing bars designed to calculated stresses, and the continuity of the girders taken into account, but the validity of the calculations was tested by a verification on the actual bridge of the position of the points of contrary flexure of the centre span. At the cal-

culated position of one of the points of contrary flexure all the rivets of the top boom were cut out, and by lowering the end of the girder over the side span one inch, the joint was opened

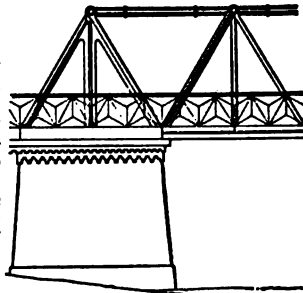

Newark Dyke Bridge.

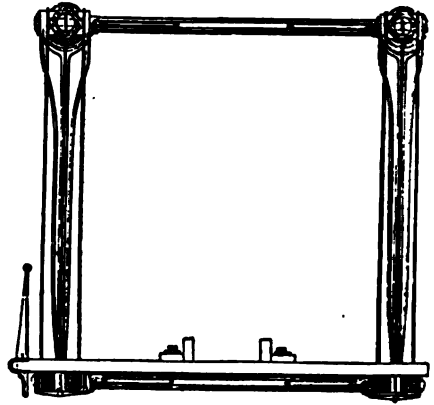

Section of Newark Dyke Bridge.

FIG. 19.

culating the position of one of the points of contrary flexure all the rivets of the top boom were cut out similarly at the other point of contrary flexure and the joint opened. The girder held its position with both joints severed, proving that, as should be the case, there was no stress in the boom where the bending moment changes sign.

By curving the top boom of a girder to form an arch and the bottom boom to form a suspension chain, the need of web except for non-uniform loading is obviated. I. K. Brunel adopted this principle for the Saltash bridge near Plymouth, built soon after the Britannia bridge. It has two spans of 455 ft. and seventeen smaller spans, the roadway being 100 ft. above high water. The top boom of each girder is an elliptical wrought iron tube 17 ft. wide by 12 ft. deep. The lower boom is a pair of chains, of wrought-iron links, 14 in each chain, of 7 in. by 1 in. section, the links being connected by pins. The suspending rods and cross bracing are very light. The depth of the girder at the centre is about one-eighth of the span.

In both England and America in early braced bridges cast iron, generally in the form of tubes circular or octagonal in section, was used for compression members, and wrought iron for the tension members. Fig. 19 shows the Newark Dyke bridge on the Great Northern railway over the Trent. It was a pin-jointed Warren girder bridge erected from designs by C. M. Wild in 1851-1853. The span between supports was 259 ft., the clear span 240½ ft.; depth between joint pins 16 ft. There were four girders, two to each line of way. The top flange consisted of cast iron hollow castings butted end to end, and the struts were of cast iron. The lower flange and ties were flat wrought iron links. This bridge has now been replaced by a stronger bridge to carry the greater loads imposed by modern traffic. Fig. 20 shows a Fink truss, a characteristic early American type, with cast iron compression and wrought iron tension members. The bridge is a deck bridge, the railway being carried on top. The transfer of the loads to the ends of the bridge by

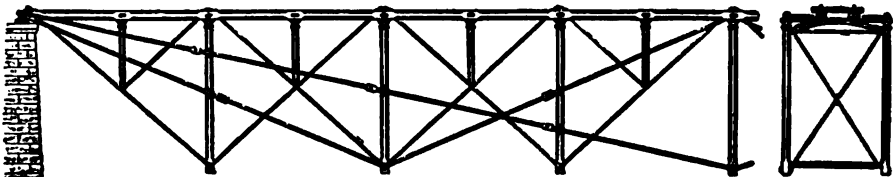

FIG. 20.—Fink Truss.

long ties is uneconomical, and this type has disappeared. The Warren type, either with two sets of bracing bars or with intermediate verticals, affords convenient means of supporting the floor girders. In 1869 a bridge of 300 ft. span was built on this system at Louisville.

Amongst remarkable American girder bridges may be mentioned the Ohio bridge on the Cincinnati & Covington railway, which is probably the largest girder span constructed. The

girders after erection. Fig. 22 shows girders erected in this way, the dotted lines being temporary members during erection, which are removed afterwards. The side spans are erected first on staging and anchored to the piers. From these, by the aid of the temporary members, the centre span is built out from both sides. The most important cantilever bridges so far erected or projected are as follows:—

(1) The Forth bridge (fig. 23). The original design was for a

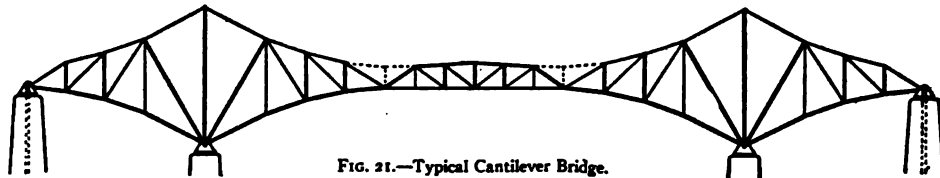

FIG. 21.—Typical Cantilever Bridge.

centre span is 550 ft. and the side spans 490 ft.—centre to centre of piers. The girders are independent polygonal girders. The centre girder has a length of 545 ft. and a depth of 84 ft. between pin centres. It is 67 ft. between parapets, and carries two lines of railway, two carriageways, and two footways. The cross girders, stringers and wind-bracing are wrought iron, the rest of mild steel. The bridge was constructed in 1888 by the Phoenix Bridge Company, and was erected on staging. The total weight of iron and steel in three spans was about 5000 tons.

10. (c) *Cantilever Bridges*.—It has been stated that if in a girder bridge of three or more spans, the girders were made continuous there would be an important economy of material, but that the danger of settlement of the supports, which would seriously alter the points of contrary flexure or points where



FIG. 22.

the bending moment changes sign, and therefore the magnitude and distribution of the stresses, generally prevents the adoption of continuity. If, however, hinges or joints are introduced at the points of contrary flexure, they become necessarily points where the bending moment is zero and ambiguity as to the stresses vanishes. The exceptional local conditions at the site of the Forth bridge led to the adoption there of the cantilever system, till then little considered. Now it is well understood that in many positions this system is the simplest and most economical method of bridging. It is available for spans greater than those practicable with independent girders; in fact, on this system the spans are virtually reduced to smaller spans so far as the stresses are concerned. There is another advantage which in many cases is of the highest importance. The cantilevers can

stiffened suspension bridge, but after the fall of the Tay bridge in 1879 this was abandoned. The bridge, which was begun in 1882 and completed in 1889, is at the only narrowing of the Forth in a distance of 50 m., at a point where the channel, about a mile in width, is divided by the island of Inchgarvie. The length of the cantilever bridge is 5330 ft., made up thus: central tower on Inchgarvie 260 ft.; File and Queensferry piers each 145 ft.; two central girders between cantilevers each 350 ft.; and six cantilevers each 680 ft. The two main spans are each 1710 ft. The clear headway is 157 ft., and the extreme height of the towers above high water 361 ft. The outer ends of the shore cantilevers are loaded to balance half the weight of the central girder, the rolling load, and 200 tons in addition. An internal viaduct of lattice girders carries a double line of rails. Provision is made for longitudinal expansion due to change of temperature, for distortion due to the sun acting on one side of the structure, and for the wind acting on one side of the bridge. The amount of steel used was 38,000 tons exclusive of approach viaducts. (See *The Forth Bridge*, by W. Westhofen; *Reports of the British Association* (1884 and 1885); *Die Forth Brücke*, von G. Barkhausen (Berlin, 1889); *The Forth Bridge*, by Philip Phillips (1890); Vernon Harcourt, *Proc. Inst. C.E.* cxxi. p. 309.)

(2) The Niagara bridge of a total length of 910 ft., for two lines of railway. Clear span between towers 495 ft. Completed in 1883, and more recently strengthened (*Proc. Inst. C.E.* cvii. p. 18, and cxlv. p. 331).

(3) The Lanadowne bridge (completed 1889) at Sukkur, over the Indus. The clear span is 790 ft., and the suspended girder 200 ft. in length. The span to the centres of the end uprights is 820 ft.; width between centres of main uprights at bed-plate 100 ft., and between centres of main members at end of cantilevers 20 ft. The bridge is for a single line of railway of 5 ft. 6 in. gauge. The back guys are the most heavily strained part of the structure, the stress provided for being 1200 tons. This is due to the half weight of centre girder, the weight of the cantilever itself, the rolling load on half the bridge, and the wind pressure. The anchors are built up of steel plates and angle bars, and are buried in a large mass of concrete. The area of each anchor plate, normal to the line of stress, is 32 ft. by 12 ft. The bridge was designed by Sir A. Rendel, the consulting engineer to the Indian government (*Proc. Inst. C.E.* ciii. p. 123).

(4) The Red Rock cantilever bridge over the Colorado river, with a centre span of 660 ft.

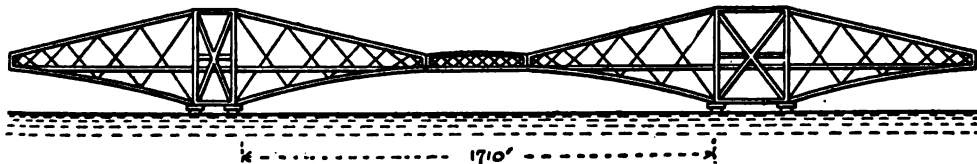

FIG. 23.—Forth Bridge.

be built out from the piers, member by member, without any temporary scaffolding below, so that navigation is not interrupted, the cost of scaffolding is saved, and the difficulty of building in deep water is obviated. The centre girder may be built on the cantilevers and rolled into place or lifted from the water-level. Fig. 21 shows a typical cantilever bridge of American design. In this case the shore ends of the cantilevers are anchored to the abutments. J. A. L. Waddell has shown that, in some cases, it is convenient to erect simple independent spans, by building them out as cantilevers and converting them into independent

(5) The Poughkeepsie bridge over the Hudson, built 1886-1887. There are five river and two shore spans. The girders over the second and fourth spans are extended as cantilevers over the adjoining spans. The shore piers carry cantilevers projecting one way over the river openings and the other way over a shore span where it is secured to an anchorage. The girder spans are 525 ft., the cantilever spans 547 ft., and the shore spans 201 ft.

(6) The Quebec bridge (fig. 25) over the St. Lawrence, which collapsed while in course of construction in 1907. This bridge, connecting very important railway systems, was designed to carry two lines of rails, a highway and electric railway on each side, all between the main trusses. Length between abutments 3240 ft.;

channel span 1800 ft.; suspended span 675 ft.; shore spans 562½ ft. Total weight of metal about 32,000 tons.

(7) The Jubilee bridge over the Hugi, designed by Sir Bradford Leslie, is a cantilever bridge of another type (fig. 26). The girders are of the Whipple Murphy type, but with curved top booms. The

bridges. Such a bridge was the Wearmouth bridge, designed by Rowland Burdon and erected in 1793-1796, with a span of 235 ft. Southwark bridge over the Thames, designed by John Rennie with cast iron ribs and erected in 1814-1819, has a centre



FIG. 24.—Lansdowne Bridge.

bridge carries a double line of railway, between the main girders. The central double cantilever is 360 ft. long. The two side span girders are 420 ft. long. The cantilever rests on two river piers 120 ft. apart, centre to centre. The side girders rest on the cantilevers on 15-in. pins, in pendulum links suspended from similar pins in saddles 9 ft. high.

11. (f) *Metal Arch Bridges.*—The first iron bridge erected was constructed by John Wilkinson (1728-1808) and Abraham Darby

span of 240 ft. and a rise of 24 ft. In Paris the Austerlitz (1800-1806) and Carrousel (1834-1836) bridges had cast iron arches. In 1858 an aqueduct bridge was erected at Washington by M. C. Meigs (1816-1892). This had two arched ribs formed by the cast iron pipes through which the water passed. The pipes were 4 ft. in diameter inside, 1½ in. thick, and were lined with staves of pine 3 in. thick to prevent freezing. The span was 200 ft.

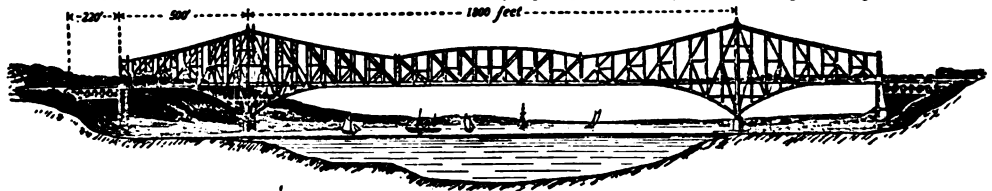

FIG. 25.—Quebec Bridge (original design).

(1750-1791) in 1773-1779 at Coalbrookdale over the Severn (fig. 27). It had five cast iron arched ribs with a centre span of 100 ft. This curious bridge is still in use. Sir B. Baker stated that it had required patching for ninety years, because the arch and the high side arches would not work together. Expansion and contraction broke the high arch and the connexions between the arches. When it broke they fished it. Then the bolts sheared or the ironwork broke in a new place. He advised that

Fig. 28 shows one of the wrought iron arches of a bridge over the Rhine at Coblenz. The bridge consists of three spans of about 315 ft. each.

Of large-span bridges with steel arches, one of the most important is the St Louis bridge over the Mississippi, completed in 1874 (fig. 29). The river at St Louis is confined to a single channel, 1600 ft. wide, and in a freshet in 1870 the scour reached a depth of 51 ft. Captain J. B. Eads, the engineer, determined to establish the piers and abutments on rock at a depth for the east pier and east abutment of 136 ft. below high water. This was effected by caissons with air



FIG. 26.—Jubilee Bridge over the Hugi.

there was nothing unsafe; it was perfectly strong and the stress in vital parts moderate. All that needed to be done was to fish the fractured ribs of the high arches, put oval holes in the fishes, and not screw up the bolts too tight.

Cast iron arches of considerable span were constructed late



FIG. 27.—Coalbrookdale Bridge

in the 18th and early in the 19th century. The difficulty of casting heavy arch ribs led to the construction of cast iron arches of cast voussoirs, somewhat like the voussoirs of masonry

chambers and air locks, a feat unprecedented in the annals of engineering. The bridge has three spans, each formed of arches of cast steel. The centre span is 520 ft. and the side spans 502 ft. is the clear. The rise of the centre arch is 47½ ft., and that of the side arches 46 ft. Each span has four steel double ribs of steel tubes butted and clasped by wrought iron couplings. The vertical bracing between the upper and lower members of each rib, which are 12 ft. apart, centre to centre, consolidates them into a single arch. The arches carry a double railway track and above this a roadway 54 ft. wide.

The St Louis bridge is not hinged, but later bridges have been constructed with hinges at the springings and sometimes with hinges at the crown also.

The Alexander III. bridge over the Seine has fifteen steel ribs hinged at crown and springings with a span of 353 ft. between centres of hinges and 358 ft. between abutments. The rise from side to centre hinges is 20 ft. 7 in. The roadway is 65½ ft. wide and footways 33 ft. (*Proc. Inst. C.E.* cxxx. p. 335).

The largest three-hinged-arch bridge constructed is the Vian viaduct in the south of France (fig. 30). The central span is 721 ft. 9 in. and the height of the rails above the valley 380 ft. It has a very fine appearance, especially when seen in perspective and not merely in elevation.

Fig. 31 shows the Douro viaduct of a total length of 1151 ft. carrying a railway 200 ft. above the water. The span of the central opening is 525 ft. The principal rib is crescent-shaped 32-6 ft. deep

at the crown. Rolling load taken at 1.2 ton per ft. Weight of centre span 727 tons. The Luiz I. bridge is another arched bridge over the Douro, also designed by T. Seyrig. This has a span of 566 ft. There are an upper and a lower roadway, 164 ft. apart vertically. The arch rests on rollers and is narrowest at the crown. The reason given for this change of form was that it more conveniently allowed the lower

the lattice girders above. The total weight of ironwork was 3200 tons and the cost £124,000 (*Annales des travaux publics*, 1884). . . . The Victoria Falls bridge over the Zambesi, designed by Sir Douglas Fox, and completed in 1905, is a combination of girder and arch having a total length of 650 ft. The centre arch is 500 ft. span, the rise of the crown 90 ft., and depth at crown 15 ft. The width



FIG. 28.—Arch of Bridge at Coblenz.

road to pass between the springings and ensured the transmission of the wind stresses to the abutments without interrupting the cross-bracing. Wire cables were used in the erection, by which the members were lifted from barges and assembled, the operations being conducted from the side piers.

The Niagara Falls and Clifton steel arch (fig. 32) replaces the older Roebling suspension bridge. The centre span is a two-hinged parabolic braced rib arch, and there are side spans of 190 and 210 ft. The bridge carries two electric-car tracks, two roadways and two footways. The main span weighed 1620 tons, the side spans 154 and 166 tons (Buck, *Proc. Inst. C.E.* cxliv. p. 70). Prof. Claxton Fidler, speaking of the arrangement adopted for putting initial stress on the top chord, stated that this bridge marked the furthest

between centres of ribs of main arch is 27½ ft. at crown and 53 ft. 9 in. at springings. The curve of the main arch is a parabola. The bridge has a roadway of 30 ft. for two lines of rails. Each half arch was supported by cables till joined at the centre. An electric cableway of 900 ft. span capable of carrying 10 tons was used in erection.

12. (g) *Movable Bridges* can be closed to carry a road or railway or in some cases an aqueduct, but can be opened to give free passage to navigation. They are of several types:—

(1) *Lifting Bridges*.—The bridge with its platform is suspended from girders above by chains and counterweights at the four corners (fig. 33 a). It is lifted vertically to the required height

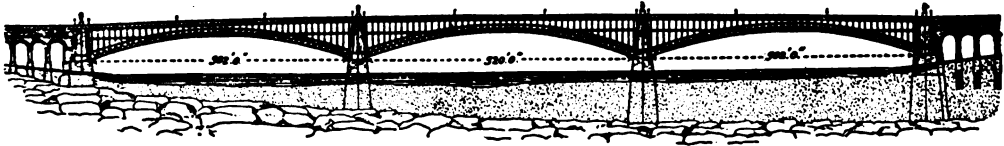

FIG. 29.—St Louis Bridge.

advance yet made in this type of construction. When such a rib is erected on centering without initial stress, the subsequent compression of the arch under its weight inflicts a bending stress and excess of compression in the upper member at the crown. But the bold expedients adopted by the engineer annulled the bending action.

The Garabit viaduct carries the railway near St Flour, in the Cantal department, France, at 420 ft. above low water. The deepest part of the valley is crossed by an arch of 541 ft. span, and 213 ft. rise. The bridge is similar to that at Oporto, also designed by Seyrig. It is formed by a crescent-shaped arch, continued on one side by four, on the other side by two lattice girder spans, on iron piers. The arch is formed by two lattice ribs hinged at the abutments. Its depth at the crown is 33 ft., and its centre line

when opened. Bridges of this type are not very numerous or important.

(2) *Rolling Bridges*.—The girders are longer than the span and the part overhanging the abutment is counter-weighted so that the centre of gravity is over the abutment when the bridge is rolled forward (fig. 33 b). To fill the gap in the approaches when the bridge is rolled forward a frame carrying that part of the road is moved into place sideways. At Sunderland, the bridge is first lifted by a hydraulic press so as to clear the roadway behind, and is then rolled back.

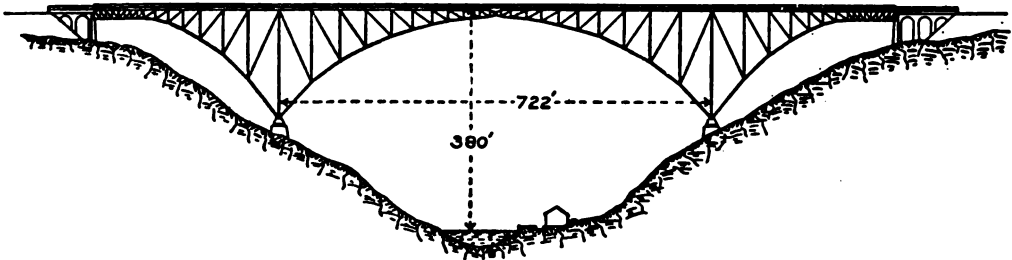

FIG. 30.—Viaur Viaduct.

follows nearly the parabolic line of pressures. The two arch ribs are 65½ ft. apart at the springings and 20½ ft. at the crown. The roadway girders are lattice, 17 ft. deep, supported from the arch ribs at four points. The total length of the viaduct is 1715 ft. The lattice girders of the side spans were first rolled into place, so as to project some distance beyond the piers, and then the arch ribs were built out, being partly supported by wire-rope cables from

(3) *Draw or Bascule Bridges*.—The fortress draw-bridge is the original type, in which a single leaf, or bascule, turns round a horizontal hinge at one abutment. The bridge when closed is supported on abutments at each end. It is raised by chains and counterweights. A more common type is a bridge with two leaves or bascules, one hinged at each abutment. When closed

the bascules are locked at the centre (see fig. 13). In these bridges each bascule is prolonged backwards beyond the hinge so as to balance at the hinge, the prolongation sinking into the piers when the bridge is opened.

(4) *Swing or Turning Bridges*.—The largest movable bridges

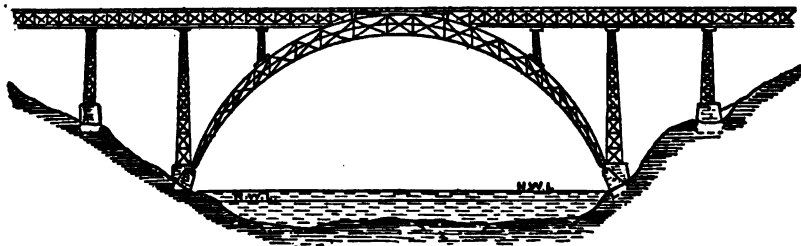

FIG. 31.—Douro Viaduct.

revolve about a vertical axis. The bridge is carried on a circular base plate with a central pivot and a circular track for a live ring and conical rollers. A circular revolving platform rests on the pivot and rollers. A toothed arc fixed to the revolving platform or to the live ring serves to give motion to the bridge.

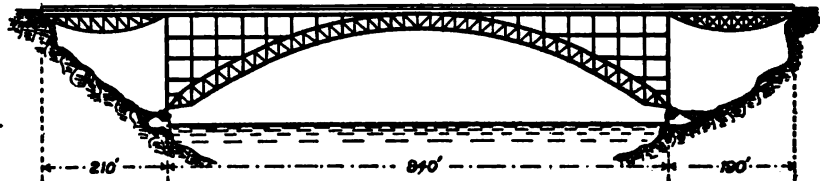
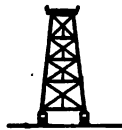

FIG. 32.—Niagara Falls and Clifton Bridge.

The main girders rest on the revolving platform, and the ends of the bridge are circular arcs fitting the fixed roadway. Three arrangements are found: (a) the axis of rotation is on a pier at the centre of the river and the bridge is equal armed (fig. 33 c), so that two navigation passages are opened simultaneously. (b) The axis of rotation is on one abutment, and the bridge is then usually unequal armed (fig. 33d), the shorter arm being over the land. (c) In some small bridges the shorter arm is vertical and the bridge turns on a kind of vertical crane post at the abutment (fig. 33e).

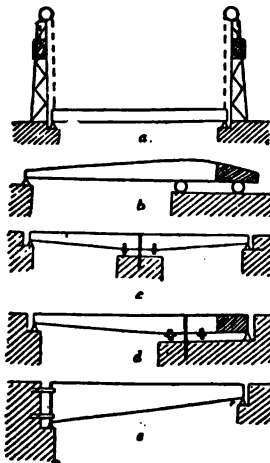

FIG. 33.

At Königsberg there is a road bridge of two fixed spans of 39 ft., and a central span of 60 ft. between bearings, or 41 ft. clear, with balanced bascules over the centre span. Each bascule consists of two main girders with cross girders and stringers. The main girders are hung at each side on a horizontal shaft 8½ in. in diameter, and are 6 ft. deep at the hinge, diminishing to 1 ft. 7 in. at the centre of

the span. The counterweight is a depressed cantilever arm 12 ft. long, overlapped by the fixed platform which sinks into a recess in the masonry when the bridge opens. In closed position the main girders rest on a bed plate on the face of the pier 4 ft. 3 in. beyond the shaft bearings. The bridge is worked by hydraulic power, an accumulator with a load of 34 tons supplying pressure water at 630 lb per sq. in. The bridge opens in 15 seconds and closes in 25 seconds.

At the opening span of the Tower bridge (fig. 13) there are four main girders in each bascule. They project 100 ft. beyond and 62 ft. 6 in. within the face of the piers. Transverse girders and bracings are inserted between the main girders at 12 ft. intervals. The floor is of buckled plates paved with wood blocks. The arc of rotation is 8½°, and the axis of rotation is 13 ft. 3 in. inside the face of the piers, and 5 ft. 7 in. below the roadway. The weight of ballast in the short arms of the bascules is 365 tons. The weight of each leaf including ballast is about 1070 tons. The axis is of forged steel 21 in. in diameter and 48 ft. long. The axis has eight bearings, consisting of rings of live rollers 4½ in. in diameter and 22 in. long. The bascules

are rotated by pinions driven by hydraulic engines working in steel sectors 42 ft. radius (*Proc. Inst. C.E.* cxvii, p. 35).

As an example of a swing bridge, that between Duluth and Superior at the head of Lake Superior over the St. Louis river may be described. The centre opening is 500 ft., spanned by a turning bridge, 58 ft. wide. The girders weighing 2000 tons carry a double track for trains between the girders and on each side on cantilevers a trolley track, roadway and footway. The bridge can be opened in 2 minutes, and is operated by two large electric motors. These have a speed reduction from armature shaft to bridge columns of 1500 to 1, through four intermediate spur gears and a worm gear. The end lifts which transfer the weight of the bridge to the piers when the span is closed consist of massive eccentrics having a throw of 4 in. The clearance is 2 in., so that the ends are lifted 2 in. This gives a load of 50 tons per eccentric. One motor is placed at each end of the span to operate the eccentrics and also to release the latches and raise the rails of the steam track.

At Riga there is a floating pontoon bridge over the Dina. It consists of fourteen rafts, 105 ft. in length, each supported by two pontoons placed 64 ft. apart. The pairs of rafts are joined by three balks 15 ft. long laid in parallel grooves in the framing. Two spans are arranged for opening easily. The total length is 1720 ft. and the width 46 ft. The pontoons are of iron, 85½ ft. in length, and their section is elliptical, 10½ ft. horizontal and 12 ft. vertical. The displacement of each pontoon is 180 tons and its weight 22 tons. The mooring chains, weighing 22 lb per ft., are taken from the upstream end of each pontoon to a downstream screw pile mooring and from the downstream end to an upstream screw pile.

13. *Transporter Bridges*.—This new type of bridge consists of a high level bridge from which is suspended a car at a low level. The car receives the traffic and conveys it across the river, being caused to travel by electric machinery on the high level bridge. Bridges of this type have been erected at Portugalet, Bizerta, Rouen, Rochefort and more recently across the Mersey between the towns of Widnes and Runcorn.

The Runcorn bridge crosses the Manchester Ship Canal and the Mersey in one span of 1000 ft., and four approach spans of 551 ft. on one side and one span on the other. The low-level approach roadways are 35 ft. wide with footpaths 6 ft. wide on each side. The supporting structure is a cable suspension bridge with stiffening girders. A car is suspended from the bridge, carried by a trolley running on the underside of the stiffening girders, the car being

propelled electrically from one side to the other. The underside of the stiffening girder is 82 ft. above the river. The car is 55 ft. long by 24½ ft. wide. The electric motors are under the control of the driver in a cabin on the car. The trolley is an articulated frame 77 ft. long in five sections coupled together with pins. To this are fixed the bearings of the running wheels, fourteen on each side. There are two steel-clad series-wound motors of 36 H.P. For a test load of 120 tons the tractive force is 70 lb per ton, which is sufficient for acceleration, and maintaining speed against wind pressure. The brakes are magnetic, with auxiliary handbrakes. Electricity is obtained by two gas engines (one spare) each of 75 H.P.

by dredging, or some form of mechanical excavator, until the formation is reached which is to support the pier; the concrete is then shot into the enclosed space from a height of about 10 ft., and rammed down in layers about 1 ft. thick; it soon consolidates into a permanent artificial stone.

Piles are used as foundations in compressible or loose soil. The heads of the piles are sawn off, and a platform of timber or concrete rests on them. Cast iron and concrete reinforced piles are now used. *Screw piles* are cast iron piles which are screwed

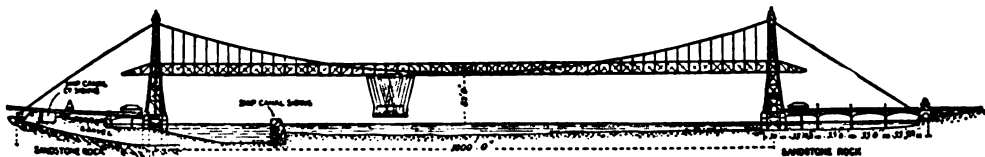

FIG. 34.—Widnes and Runcorn Transporter Bridge.

On the opening day passengers were taken across at the rate of more than 2000 per hour in addition to a number of vehicles. The time of crossing is 3 or 4 minutes. The total cost of the structure was £133,000.

14. In the United States few railway companies design or build their own bridges. General specifications as to span, loading, &c., are furnished to bridge-building companies, which make the design under the direction of engineers who are experts in this kind of work. The design, with strain sheets and detail drawings, is submitted to the railway engineer with estimates. The result is that American bridges are generally of well-settled types and their members of uniform design, carefully considered with reference to convenient and accurate manufacture. Standard patterns of details are largely adopted, and more system is introduced in the workshop than is possible where the designs are more varied. Riveted plate girders are used up to 50 ft. span, riveted braced girders for spans of 50 ft. to 75 ft., and pin-connected girders for longer spans. Since the erection of the Forth bridge, cantilever bridges have been extensively used, and some remarkable steel arch and suspension bridges have also been constructed. Overhead railways are virtually continuous bridge constructions, and much attention has been given to a study of the special conditions appertaining to that case.

Substructure.

15. The substructure of a bridge comprises the piers, abutments and foundations. These portions usually consist of masonry in some form, including under that general head stone masonry, brickwork and concrete. Occasionally metal work or woodwork is used for intermediate piers.

When girders form the superstructure, the resultant pressure on the piers or abutments is vertical, and the dimensions of these are simply regulated by the sufficiency to bear this vertical load.

When arches form the superstructure, the abutment must be so designed as to transmit the resultant thrust to the foundation in a safe direction, and so distributed that no part may be unduly compressed. The intermediate piers should also have considerable stability, so as to counterbalance the thrust arising when one arch is loaded while the other is free from load.

For suspension bridges the abutment forming the anchorage must be so designed as to be thoroughly stable under the greatest pull which the chains can exert. The piers require to be carried above the platform, and their design must be modified according to the type of suspension bridge adopted. When the resultant pressure is not vertical on the piers these must be constructed to meet the inclined pressure. In any stiffened suspension bridge the action of the pier will be analogous to that of a pier between two arches.

Concrete in a shell is a name which might be applied to all the methods of founding a pier which depend on the very valuable property which strong hydraulic concrete possesses of setting into a solid mass under water. The required space is enclosed by a wooden or iron shell; the soil inside the shell is removed

into the soil instead of being driven in. At their end is fixed a blade of cast iron from two to eight times the diameter of the shaft of the pile; the pitch of the screw varies from one-half to one-fourth of the external diameter of the blade.

Disk piles have been used in sand. These piles have a flat flange at the bottom, and water is pumped in at the top of the pile, which is weighted to prevent it from rising. Sand is thus blown or pumped from below the piles, which are thus easily lowered in ground which baffles all attempts to drive in piles by blows. In ground which is of the nature of quicksand, piles will often slowly rise to their original position after each blow.

Wells.—In some soils foundations may be obtained by the device of building a masonry casing like that of a well and excavating the soil inside; the casing gradually sinks and the masonry is continued at the surface. This method is applicable in running sands. The interior of the well is generally filled up with concrete or brick when the required depth has been reached.

Piers and Abutments.—Piers and abutments are of masonry, brickwork, or cast or wrought iron. In the last case they consist of any number of hollow cylindrical pillars, vertical or raking, turned and planed at the ends and united by a projection or socket and by flanges and bolts. The pillars are strengthened against lateral yielding by horizontal and diagonal bracing. In some cases the piers are cast iron cylinders 10 ft. or more in diameter filled with concrete.

Cylinder Foundations.—Formerly when bridge piers had to be placed where a firm bearing stratum could only be reached at a considerable depth, a timber cofferdam was used in which piles were driven down to the firm stratum. On the piles the masonry piers were built. Many bridges so constructed have stood for centuries. A great change of method arose when iron cylinders

and in some cases brick cylinders or wells were adopted for foundations. These can be sunk to almost any depth or brought up to any height, and are filled with Portland cement concrete. They are sometimes excavated by grabs. Sometimes they are closed in and kept free of water by compressed air so that excavation work can be carried on inside them (fig. 35). Sometimes in silty river beds they are sunk 100 ft. or more, for



FIG. 35.—Cylinder, Charing Cross Bridge.

security against deep scouring of the river-bed in floods. In the case of the Empress bridge over the Sutlej each pier consisted of three brick wells, 19 ft. in diameter, sunk 110 ft. The piers of the Benares bridge were single iron caissons, 65 ft. by 28 ft., sunk about 100 ft., lined with brick and filled with concrete. At the Forth bridge iron caissons 70 ft. in diameter were sunk about 40 ft. into the bed of the Forth. In this case the compressed air process was used.

16. *Erection*.—Consideration of the local conditions affecting the erection of bridges is always important, and sometimes becomes a controlling factor in the determination of the design. The methods of erection may be classed as—(1) erection on staging or falsework; (2) floating to the site and raising; (3) rolling out from one abutment; (4) building out member by member, the completed part forming the stage from which additions are handled.

(1) In erection on staging, the materials available determine the character of the staging; stacks of timber, earth banks, or built-up staging of piles and trestles have all been employed, also iron staging, which can be rapidly erected and moved from site to site. The most ordinary type of staging consists of timber piles at nearly equal distances of 20 ft. to 30 ft., carrying a timber platform, on which the bridge is erected. Sometimes a wide space is left for navigation, and the platform at this part is carried by a timber and iron truss. When the headway is great or the river deep, timber-braced piers or clusters of piles at distances of 50 ft. to 100 ft. may be used. These carry temporary trusses of timber or steel. The Kullienburg bridge in Holland, which has a span of 492 ft., was erected on a timber staging of this kind, containing 81,000 cub. ft. of timber and 5 tons of bolts. The bridge superstructure weighed 2150 tons, so that 38 cub. ft. of timber were used per ton of superstructure.

(2) The Britannia and Conway bridges were built on staging on shore, lifted by pontoons, floated out to their position between the piers, and lastly lifted into place by hydraulic presses. The Moerdyk bridge in Holland, with 14 spans of 328 ft., was erected in a similar way. The convenience of erecting girders on shore is very great, but there is some risk in the floating operations and a good deal of hauling plant is required.

(3) If a bridge consists of girders continuous over two or more spans, it may be put together on the embankment at one end and rolled over the piers. In some cases hauling tackle is used, in others power is applied by levers and ratchets to the rollers on which the girders travel. In such rolling operations the girder is subjected to straining actions different from those which it is intended to resist, and parts intended for tension may be in compression; hence it may need to be stiffened by timber during rolling. The bending action on the bottom boom in passing over the rollers is also severe. Modifications of the system have been adopted for bridges with discontinuous spans. In narrow ravines a bridge of one span may be rolled out, if the projecting end is supported on a temporary suspension cable anchored on each side. The free end is slung to a block running on the cable. If the bridge is erected when the river is nearly dry a travelling stage may be constructed to carry the projecting end of the girder while it is hauled across, the other end resting on one abutment. Sometimes a girder is rolled out about one-third of its length, and then supported on a floating pontoon.

(4) Some types of bridge can be built out from the abutments, the completed part forming an erecting stage on which lifting appliances are fixed. Generally, in addition, wire cables are stretched across the span, from which lifting tackle is suspended. In bridges so erected the straining action during erection must be studied, and material must be added to resist erecting stresses. In the case of the St. Louis bridge, half arches were built out on either side of each pier, so that the load balanced. Skeleton towers on the piers supported chains attached to the arched ribs at suitable points. In spite of careful provision, much difficulty was experienced in making the connexion at the crown, from the expansion due to temperature changes. The Douro bridge was similarly erected. The girders of the side spans were rolled out so as to overhang the great span by 105 ft., and formed a platform from which parts of the arch could be suspended. Dwarf towers, built on the arch ring at the fifth panel from either side, helped to support the girder above, in erecting the centre part of the arch (Seyrig, *Proc. Inst. C.E.* lxxiii. p. 177). The great cantilever bridges have been erected in the same way, and they are specially adapted for erection by building out.

Straining Actions and Working Stresses.

17. In metal bridges wrought iron has been replaced by mild steel—a stronger, tougher and better material. Ingot metal or mild steel was sometimes treacherous when first introduced, and accidents occurred, the causes of which were obscure. In fact, small differences of composition or variations in thermal treatment during manufacture involve relatively large differences of

quality. Now it is understood that care must be taken in specifying the exact quality and in testing the material supplied. Structural wrought iron has a tenacity of 20 to 22½ tons per sq. in. in the direction of rolling, and an ultimate elongation of 8 or 10% in 8 in. Across the direction of rolling the tenacity is about 18 tons per sq. in., and the elongation 3% in 8 in. Steel has only a small difference of quality in different directions. There is still controversy as to what degree of hardness, or (which is nearly the same thing) what percentage of carbon, can be permitted with safety in steel for structures.

The qualities of steel used may be classified as follows.—(a) Soft steel, having a tenacity of 22½ to 26 tons per sq. in., and an elongation of 32 to 24% in 8 in. (b) Medium steel, having a tenacity of 26 to 34 tons per sq. in., and 28 to 25% elongation. (c) Moderately hard steel, having a tenacity of 34 to 37 tons per sq. in., and 17% elongation. (d) Hard steel, having a tenacity of 37 to 40 tons per sq. in., and 10% elongation. Soft steel is used for rivets always, and sometimes for the whole superstructure of a bridge, but medium steel more generally for the plates, angle bars, &c., the weight of the bridge being then reduced by about 7% for a given factor of safety. Moderately hard steel has been used for the larger members of long-span bridges. Hard steel, if used at all, is used only for compression members, in which there is less risk of flaws extending than in tension members. With medium or moderately hard steel all rivet holes should be drilled, or punched ¼ in. less in diameter than the rivet and reamed out, so as to remove the ring of material strained by the punch.

In the specification for bridge material, drawn up by the British Engineering Standards Committee, it is provided that the steel shall be acid or basic open-hearth steel, containing not more than 0.06% of sulphur or phosphorus. Plates, angles and bars, other than rivet bars, must have a tensile strength of 28 to 32 tons per sq. in., with an elongation of 20% in 8 in. Rivet bars tested on a gauge length eight times the diameter must have a tensile strength of 26 to 30 tons per sq. in. and an elongation of 25%.

18. *Straining Actions*.—The external forces acting on a bridge may be classified as follows.—

(1) *The live or temporary load*, for road bridges the weight of a dense crowd uniformly distributed, or the weight of a heavy wagon or traction engine; for railway bridges the weight of the heaviest train likely to come on the bridge. (2) An allowance is sometimes made for *impact*, that is the dynamical action of the live load due to want of vertical balance in the moving parts of locomotives, to irregularities of the permanent way, or to yielding of the structure. (3) *The dead load* comprises the weight of the main girders, flooring and wind bracing, or the total weight of the superstructure exclusive of any part directly carried by the piers. This is usually treated as uniformly distributed over the span. (4) *The horizontal pressure* due to a wind blowing transversely to the span, which becomes of importance in long and high bridges. (5) *The longitudinal drag* due to the friction of a train when braked, about one-seventh of the weight of the train. (6) On a curved bridge the *centrifugal load* due to the radial acceleration of the train. If w is the weight of a locomotive in tons, r the radius of curvature of the track, v the velocity in feet per sec.; then the horizontal force exerted on the bridge is wv^2/gr tons. (7) In some cases, especially in arch and suspension bridges, changes of temperature set up stresses equivalent to those produced by an external load. In Europe a variation of temperature of 70° C. or 126° F. is commonly assumed. For this the expansion is about 1 in. in 100 ft. Generally a structure should be anchored at one point and free to move if possible in other directions. Roughly, if expansion is prevented, a stress of one ton per sq. in. is set up in steel structures for each 12° change of temperature.

1. *Live Load on Road Bridges*.—A dense crowd of people may be taken as a uniform load of 80 to 120 lb per sq. ft. But in recent times the weight of traction engines and wagons which pass over bridges has increased, and this kind of load generally produces greater straining action than a crowd of people. In manufacturing districts and near large towns loads of 30 tons may come on road bridges, and county and borough authorities insist on provision being made for such loads. In Switzerland roads are divided into three classes according to their importance, and the following loads are prescribed, the designer having to provide sufficient strength either for a uniformly distributed crowd, or for a heavy wagon anywhere on the roadway:—

	Crowd, lb per sq. ft.	Wagon, tons per axle.
Main Roads	92	10 with 13 ft. wheel base
Secondary Roads	72	6 " 10 " "
Other Roads	51	3 " 8 " "

In England still larger loads are now provided for. J. C. Inglis (*Proc. Inst. C.E. cxli. p. 35*) has considered two cases—(a) a traction engine and boiler trolley, and (b) a traction engine and trucks loaded with granite. He has calculated the equivalent load per foot of span which would produce the same maximum bending moments. The following are some of the results:—

Span Ft.	10.	20.	30.	40.	50.
Equivalent load in tons per ft. run, Case a	1.75	0.95	0.75	0.73	0.72
Do. Case b	3.25	1.7	1.3	1.2	1.15

Large as these loads are on short spans, they are not more than must often be provided for.

Live Load on Railway Bridges.—The live load is the weight of the heaviest train which can come on the bridge. In the earlier girder bridges the live load was taken to be equivalent to a uniform load of 1 ton per foot run for each line of way. At that time locomotives on railways of 4 ft. 8½ in. gauge weighed at most 35 to 45 tons, and their length between buffers was such that the average load did not exceed 1 ton per foot run. Trains of wagons did not weigh more than three-quarters of a ton per foot run when most heavily loaded. The weights of engines and wagons are now greater, and in addition it is recognized that the concentration of the loading at the axles gives rise to greater straining action, especially in short bridges, than the same load uniformly distributed along the span. Hence many of the earlier bridges have had to be strengthened to carry modern traffic. The following examples of some of the heaviest locomotives on English railways is given by W. B. Farr (*Proc. Inst. C. E. cxli. p. 12*):—

Passenger Engines.

Total weights, tons	84.35	98.90	91.90	85.48
Tons per ft. over all	1.58	1.71	1.62	1.61
Tons per ft. of wheel base	1.92	2.04	1.97	1.95
Maximum axle load, tons	19.00	16.00	18.70	18.50

Goods Engines.

Total weight, tons	77.90	78.80	76.46	75.65
Tons per ft. over all	1.54	1.50	1.54	1.51
Tons per ft. of wheel base	2.02	2.02	2.03	2.00
Maximum axle load, tons	15.90	16.00	13.65	15.50

Tank Engines.

Total weight, tons	53.80	58.61	60.80	47.00
Tons per ft. over all	1.60	1.68	1.70	1.55
Tons per ft. of wheel base	2.45	2.52	2.43	3.03
Maximum axle load, tons	17.54	15.29	17.10	15.77

Farr has drawn diagrams of bending moment for forty different very heavy locomotives on different spans, and has determined for each case a uniform load which at every point would produce as great a bending moment as the actual wheel loads. The following short abstract gives the equivalent uniform load which produces bending moments as great as those of any of the engines calculated:—

Span in Ft.	Load per ft. run equivalent to actual Wheel Loads in Tons, for each Track.
5.0	7.6
10.0	4.85
20.0	3.20
30.0	2.63
50.0	2.24
100.0	1.97

Fig. 36 gives the loads per axle and the distribution of loads in some exceptionally heavy modern British locomotives.

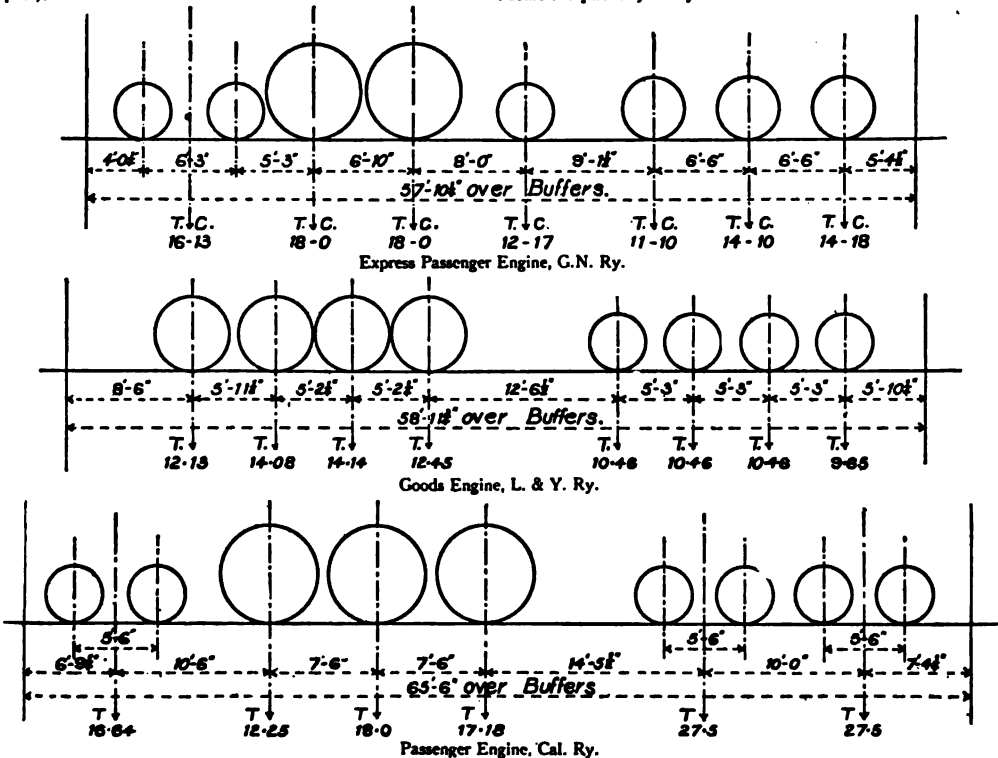

FIG. 36.

In Austria the official regulations require that railway bridges shall be designed for at least the following live loads per foot run and per track:—

Span.		Live Load in Tons.	
Metres.	Ft.	Per metre run.	Per ft. run.
1	3.3	20	6.1
2	6.6	15	4.6
5	16.4	10	3.1
20	65.6	5	1.5
30	98.4	4	1.2

It would be simpler and more convenient in designing short bridges if, instead of assuming an equivalent uniform rolling load, agreement could be come to as to a typical heavy locomotive which would produce stresses as great as any existing locomotive on each class of railway. Bridges would then be designed for these selected loads, and the process would be safer in dealing with flooring girders and shearing forces than the assumption of a uniform load.

Some American locomotives are very heavy. Thus a consolidation engine may weigh 126 tons with a length over buffers of 57 ft., corresponding to an average load of 2.55 tons per ft. run. Also long ore wagons are used which weigh loaded 20 tons per ft. run. J. A. L. Waddell (*De Pontibus*, New York, 1898) proposes to arrange railways in seven classes, according to the live loads which may be expected from the character of their traffic, and to construct bridges in accordance with this classification. For the lightest class, he takes a locomotive and tender of 93.5 tons, 52 ft. between buffers (average load 1.8 tons per ft. run), and for the heaviest a locomotive and tender weighing 144.5 tons, 52 ft. between buffers (average load 2.77 tons per ft. run). Wagons he assumes to weigh for the lightest class 1.3 tons per ft. run and for the heaviest 1.9 tons. He takes as the live load for a bridge two such engines, followed by a train of wagons covering the span. Waddell's tons are short tons of 2000 lb.

ii. *Impact*.—If a vertical load is imposed suddenly, but without velocity, work is done during deflection, and the deformation and stress are momentarily double those due to the same load at rest on the structure. No load of exactly this kind is ever applied to a bridge. But if a load is so applied that the deflection increases with speed, the stress is greater than that due to a very gradually applied load, and vibrations about a mean position are set up. The rails not being absolutely straight and smooth, centrifugal and lurching actions occur which alter the distribution of the loading. Again, rapidly changing forces, due to the moving parts of the engine which are unbalanced vertically, act on the bridge; and, lastly, inequalities of level at the rail ends give rise to shocks. For all these reasons the stresses due to the live load are greater than those due to the same load resting quietly on the bridge. This increment is larger on the flooring girders than on the main ones, and on short main girders than on long ones. The impact stresses depend so much on local conditions that it is difficult to fix what allowance should be made. E. H. Stone (*Trans. Am. Soc. of C. E.* xli. p. 467) collated some measurements of deflection taken during official trials of Indian bridges, and found the increment of deflection due to impact to depend on the ratio of dead to live load. By plotting and averaging he obtained the following results:—

Excess of Deflection and straining Action of a moving Load over that due to a resting Load.

Dead load in per cent of total load	10	20	30	40	50	70	90
Live load in per cent of total load	90	80	70	60	50	30	10
Ratio of live to dead load	9	4	2.3	1.5	1.0	0.43	0.10
Excess of deflection and stress due to moving load per cent	23	13	8	5.5	4.0	1.6	0.3

These results are for the centre deflections of main girders, but Stone infers that the augmentation of stress for any member, due to causes included in impact allowance, will be the same percentage for the same ratios of live to dead load stresses. Valuable measurements of the deformations of girders and tension members due to moving trains have been made by S. W. Robinson (*Trans. Am. Soc. C. E.* xvi.) and by F. E. Turneure (*Trans. Am. Soc. C. E.* xli.). The latter used a recording deflectometer and two recording extensometers. The observations are difficult, and the inertia of the instrument is liable to cause error, but much care was taken. The most striking conclusions from the results are that the locomotive balance weights have a large effect in causing vibration, and next, that in certain cases the vibrations are cumulative, reaching a value greater than that due to any single impact action. Generally: (1) At speeds less than 25 m. an hour there is not much vibration. (2) The increase of deflection due to impact at 40 or 50 m. an hour is likely to reach

40 to 50% for girder spans of less than 50 ft. (3) This percentage decreases rapidly for longer spans, becoming about 25% for 75-ft. spans. (4) The increase per cent of boom stresses due to impact is about the same as that of deflection; that in web bracing bars is rather greater. (5) Speed of train produces no effect on the mean deflection, but only on the magnitude of the vibrations.

A purely empirical allowance for impact stresses has been proposed, amounting to 20% of the live load stresses for floor stringers; 15% for floor cross girders; and for main girders, 10% for 40-ft. spans, and 5% for 100-ft. spans. These percentages are added to the live load stresses.

iii. *Dead Load*.—The dead load consists of the weight of main girders, flooring and wind-bracing. It is generally reckoned to be uniformly distributed, but in large spans the distribution of weight in the main girders should be calculated and taken into account. The weight of the bridge flooring depends on the type adopted. Road bridges vary so much in the character of the flooring that no general rule can be given. In railway bridges the weight of sleepers, rails, &c., is 0.2 to 0.25 tons per ft. run for each line of way, while the rail girders, cross girders, &c., weigh 0.15 to 0.2 tons. If a footway is added about 0.4 ton per ft. run may be allowed for this. The weight of main girders increases with the span, and there is for any type of bridge a limiting span beyond which the dead load stresses exceed the assigned limit of working stress.

Let W_1 be the total live load, W_2 the total flooring load on a bridge of span l , both being considered for the present purpose to be uniform per ft. run. Let $k(W_1+W_2)$ be the weight of main girders designed to carry W_1+W_2 , but not their own weight in addition. Then

$$W_0 = (W_1 + W_2)(k + l^2 + l^3 \dots)$$

will be the weight of main girders to carry W_1+W_2 , and their own weight (Buck, *Proc. Inst. C. E.* lxxiv. p. 33). Hence,

$$W_0 = (W_1 + W_2)k/(1 - k).$$

Since in designing a bridge W_1+W_2 is known, $k(W_1+W_2)$ can be found from a provisional design in which the weight W_0 is neglected. The actual bridge must have the section of all members greater than those in the provisional design in the ratio $k/(1 - k)$.

Waddell (*De Pontibus*) gives the following convenient empirical relations. Let w_1, w_2 be the weights of main girders per ft. run for a live load p per ft. run and spans l_1, l_2 . Then

$$w_2/w_1 = \frac{1}{2} \left[\frac{l_2}{l_1} + \left(\frac{l_2}{l_1} \right)^2 \right].$$

Now let w'_1, w'_2 be the girder weights per ft. run for spans l_1, l_2 and live loads p' per ft. run. Then

$$\frac{w'_2/w'_1}{w_2/w_1} = \frac{(1 + 4p'/p)}{1 + \frac{1}{2} \left[\frac{l_2}{l_1} + \left(\frac{l_2}{l_1} \right)^2 \right] (1 + 4p'/p)}.$$

A partially rational approximate formula for the weight of main girders is the following (Unwin, *Wrought Iron Bridges and Roofs*, 1869, p. 40):—

Let w = total live load per ft. run of girder; w_1 the weight of platform per ft. run; w_2 the weight of main girders per ft. run, all in tons; l = span in ft.; s = average stress in tons per sq. in. on gross section of metal; d = depth of girder at centre in ft.; r = ratio of span to depth of girder so that $r = l/d$. Then

$$w_2 = (w_1 + w_2)P / (Cd_s - l_2) = (w_1 + w_2)l / (Cs - lr),$$

where C is a constant for any type of girder. It is not easy to fix the average stress s per sq. in. of gross section. Hence the formula is more useful in the form

$$w = (w_1 + w_2)P / (Kd - P) = (w_1 + w_2)l / (K - lr)$$

where $k = (w_1 + w_2 + w_3)l / w_2$ is to be deduced from the data of some bridge previously designed with the same working stresses. From some known examples, C varies from 1500 to 1800 for iron braced parallel or bowstring girders, and from 1200 to 1500 for similar girders of steel. $K = 6000$ to 7200 for iron and $= 7200$ to 9000 for steel bridges.

iv. *Wind Pressure*.—Much attention has been given to wind action since the disaster to the Tay bridge in 1879. As to the maximum wind pressure on small plates normal to the wind, there is not much doubt. Anemometer observations show that pressures of 30 lb per sq. ft. occur in storms annually in many localities, and that occasionally higher pressures are recorded in exposed positions. Thus at Bidstone, Liverpool, where the gauge has an exceptional exposure, a pressure of 80 lb per sq. ft. has been observed. In tornadoes, such as that at St Louis in 1866, it has been calculated, from the stability of structures overturned, that pressures of 45 to 90 lb per sq. ft. must have been reached. As to anemometer pressures, it should be observed that the recorded pressure is made up of a positive front and negative (vacuum) back pressure, but in structures the latter must be absent or only partially developed. Great difference of opinion exists as to whether on large surfaces the average pressure per sq. ft. is as great as on small surfaces, such as anemometer plates. The experiments of Sir B. Baker at the Forth bridge showed that on a surface 30 ft. x 15 ft. the intensity of pressure was less than on a similarly exposed anemometer plate. In the case of bridges there is the further difficulty that some surfaces partially

shield other surfaces; one girder, for instance, shields the girder behind it (see *Brit. Assoc. Report*, 1884). In 1881 a committee of the Board of Trade decided that the maximum wind pressure on a vertical surface in Great Britain should be assumed in designing structures to be 56 lb per sq. ft. For a plate girder bridge of less height than the train, the wind is to be taken to act on a surface equal to the projected area of one girder and the exposed part of a train covering the bridge. In the case of braced girder bridges, the wind pressure is taken as acting on a continuous surface extending from the rails to the top of the carriages, plus the vertical projected area of so much of one girder as is exposed above the train or below the rails. In addition, an allowance is made for pressure on the leeward girder according to a scale. The committee recommended that a factor of safety of 4 should be taken for wind stresses. For safety against overturning they considered a factor of 2 sufficient. In the case of bridges not subject to Board of Trade inspection, the allowance for wind pressure varies in different cases. C. Shaler Smith allows 300 lb per sq. ft. run for the pressure on the side of a train, and in addition 30 lb per sq. ft. on twice the vertical projected area of one girder, treating the pressure on the train as a travelling load. In the case of bridges of less than 50 ft. span he also provides strength to resist a pressure of 50 lb per sq. ft. on twice the vertical projection of one truss, no train being supposed to be on the bridge.

10. Stresses Permitted.—For a long time engineers held the conventional opinion that, if the total dead and live load stress on any section of a structure (of iron) did not exceed 5 tons per sq. in., ample safety was secured. It is no longer possible to design by so simple a rule. In an interesting address to the British Association in 1885, Sir B. Baker described the condition of opinion as to the safe limits of stress as chaotic. "The old foundations," he said, "are shaken, and engineers have not come to an agreement respecting the rebuilding of the structure. The variance in the strength of existing bridges is such as to be apparent to the educated eye without any calculation. In the present day engineers are in accord as to the principles of estimating the magnitude of the stresses on the members of a structure, but not so in proportioning the members to resist those stresses. The practical result is that a bridge which would be passed by the English Board of Trade would require to be strengthened 5% in some parts and 60% in others, before it would be accepted by the German government, or by any of the leading railway companies in America." Sir B. Baker then described the results of experiments on repetition of stress, and added that "hundreds of existing bridges which carry twenty trains a day with perfect safety would break down quickly under twenty trains an hour. This fact was forced on my attention nearly twenty-five years ago by the fracture of a number of girders of ordinary strength under a five-minutes' train service."

Practical experience taught engineers that though 5 tons per sq. in. for iron, or 6½ tons per sq. in. for steel, was safe or more than safe for long bridges with large ratio of dead to live load, it was not safe for short ones in which the stresses are mainly due to live load, the weight of the bridge being small. The experiments of A. Wöhler, repeated by Johann Bauschinger, Sir B. Baker and others, show that the breaking stress of a bar is not a fixed quantity, but depends on the range of variation of stress to which it is subjected, if that variation is repeated a very large number of times. Let K be the breaking strength of a bar per unit of section, when it is loaded once gradually to breaking. This may be termed the static breaking strength. Let k_{max} be the breaking strength of the same bar when subjected to stresses varying from k_{max} to k_{min} alternately and repeated an indefinitely great number of times; k_{max} is to be reckoned + if of the same kind as k_{min} , and - if of the opposite kind (tension or thrust). The range of stress is therefore $k_{max} - k_{min}$, if the stresses are both of the same kind, and $k_{max} + k_{min}$, if they are of opposite kinds. Let $\Delta = k_{max} - k_{min}$ = the range of stress, where Δ is always positive. Then Wöhler's results agree closely with the rule,

$$k_{max} = \Delta + \sqrt{(K^2 - s\Delta K)}$$

where s is a constant which varies from 1.5 to 2 in various qualities of iron and steel. For ductile iron or mild steel it may be taken as 1.5. For a statical load, range of stress nil, $\Delta = 0$, $k_{max} = K$, the static breaking stress. For a bar so placed that it is alternately loaded and the load removed, $\Delta = k_{max}$, and $k_{min} = 0 = 6 K$. For a bar subjected to alternate tension and compression of equal amount, $\Delta = 2 k_{max}$, and $k_{min} = -k_{max} = -0.33 K$. The safe working stress in these different cases is k_{max} divided by the factor of safety. It is sometimes said that a bar is "fatigued" by repeated straining. The real nature of the action is not well understood, but the word fatigue may be used, if it is not considered to imply more than that the breaking stress under repetition of loading diminishes as the range of variation increases.

It was pointed out as early as 1869 (Uwlin, *Wrought Iron Bridges and Roofs*) that a rational method of fixing the working stress, so far as knowledge went at that time, would be to make it depend on the ratio of live to dead load, and in such a way that the factor of safety for the live load stresses was double that for the dead load stresses. Let A be the dead load and B the live load, producing stress in a bar; $\rho = B/A$ the ratio of live to dead load; f_1 the safe working limit of stress for a bar subjected to a dead load only and f the safe working stress in any other case. Then

$$f_1(A+B)/(A+2B) = f_1(1+\rho)/(1+2\rho)$$

The following table gives values of f so computed on the assumption that $f_1 = 7\frac{1}{2}$ tons per sq. in. for iron and 9 tons per sq. in. for steel.

Working Stress for combined Dead and Live Load. Factor of Safety twice as great for Live Load as for Dead Load.

	Ratio ρ	$\frac{1+\rho}{1+2\rho}$	Values of f , tons per sq. in.	
			Iron.	Mild Steel.
All dead load	0	1.00	7.5	9.0
	.25	0.83	6.2	7.5
	.33	0.78	5.8	7.0
	.50	0.75	5.6	6.8
	.66	0.71	5.3	6.4
Live load = Dead load	1.00	0.66	4.9	5.9
	2.00	0.60	4.5	5.4
	4.00	0.56	4.2	5.0
	∞	0.50	3.7	4.5

Bridge sections designed by this rule differ little from those designed by formulae based directly on Wöhler's experiments. This rule has been revived in America, and appears to be increasingly relied on in bridge-designing. (See *Trans. Am. Soc. C.E.* xli. p. 156.)

The method of J. J. Weyrauch and W. Launhardt, based on an empirical expression for Wöhler's law, has been much used in bridge designing (see *Proc. Inst. C.E.* lxiii. p. 275). Let t be the static breaking strength of a bar, loaded once gradually up to fracture (t = breaking load divided by original area of section); s the breaking strength of a bar loaded and unloaded an indefinitely great number of times, the stress varying from s to 0 alternately (this is termed the *primitive strength*); and, lastly, let s' be the breaking strength of a bar subjected to an indefinitely great number of repetitions of stresses equal and opposite in sign (tension and thrust), so that the stress ranges alternately from s to $-s'$. This is termed the *vibration strength*. Wöhler's and Bauschinger's experiments give values of t , s , and s' for some materials. If a bar is subjected to alternations of stress having the range $\Delta = f_{max} - f_{min}$, then, by Wöhler's law, the bar will ultimately break, if

$$f_{max} = F\Delta \tag{1}$$

where F is some unknown function. Launhardt found that, for stresses always of the same kind, $F = (1-s)/(t-f_{max})$, approximately agreed with experiment. For stresses of different kinds Weyrauch found $F = (s-s')/(2s-s'-f_{max})$ to be similarly approximate. Now let $f_{max}/f_{min} = \phi$, where ϕ is + or - according as the stresses are of the same or opposite sign. Putting the values of F in (1) and solving for f_{max} , we get for the breaking stress of a bar subjected to repetition of varying stress,

$$\begin{aligned} f_{max} &= s(1+(1-s)\phi/s) & \text{[Stresses of same sign.]} \\ f_{max} &= s(1+(s-s')\phi/s) & \text{[Stresses of opposite sign.]} \end{aligned}$$

The working stress in any case is f_{max} divided by a factor of safety. Let that factor be 3. Then Wöhler's results for iron and Bauschinger's for steel give the following equations for tension or thrust:—

$$\begin{aligned} \text{Iron, working stress, } f &= 4.4(1+\frac{1}{3}\phi) \\ \text{Steel, " " " } &= 5.87(1+\frac{1}{3}\phi) \end{aligned}$$

In these equations ϕ is to have its + or - value according to the case considered. For shearing stresses the working stress may have 0.8 of its value for tension. The following table gives values of the working stress calculated by these equations:—

Working Stress for Tension or Thrust by Launhardt and Weyrauch Formula.

	ϕ	$1+\frac{\phi}{3}$	Working Stress f , tons per sq. in.	
			Iron.	Steel.
All dead load	1.0	1.5	6.60	8.80
	0.75	1.375	6.05	8.07
	0.50	1.25	5.50	7.34
	0.25	1.125	4.95	6.60
All live load	0.00	1.00	4.40	5.87
	-0.25	0.875	3.85	5.14
	-0.50	0.75	3.30	4.40
	-0.75	0.625	2.75	3.67
	-1.00	0.500	2.20	2.93

To compare this with the previous table, $\phi = (A+B)/A = 1 + \rho$. Except when the limiting stresses are of opposite sign, the two tables agree very well. In bridge work this occurs only in some of the bracing bars.

It is a matter of discussion whether, if fatigue is allowed for by the Weyrauch method, an additional allowance should be made for impact. There was no impact in Wöhler's experiments, and therefore it would seem rational to add the impact allowance to that for fatigue; but in that case the bridge sections become larger than experience shows to be necessary. Some engineers escape this difficulty by asserting that Wöhler's results are not applicable to bridge work. They reject the allowance for fatigue (that is, the effect of repetition) and design bridge members for the total dead and live load, plus a large allowance for impact varied according to some purely empirical rule. (See Waddell, *De Pontibus*, p. 7.) Now in applying Wöhler's law, f_{max} , for any bridge member is found for the maximum possible live load, a live load which though it may sometimes come on the bridge and must therefore be provided for, is not the usual live load to which the bridge is subjected. Hence the range of stress, $f_{max} - f_{min}$, from which the working stress is deduced, is not the ordinary range of stress which is repeated a practically infinite number of times, but is a range of stress to which the bridge is subjected only at comparatively long intervals. Hence practically it appears probable that the allowance for fatigue made in either of the tables above is sufficient to cover the ordinary effects of impact also.

English bridge-builders are somewhat hampered in adopting rational limits of working stress by the rules of the Board of Trade. Nor do they all accept the guidance of Wöhler's law. The following are some examples of limits adopted. For the Dufferin bridge (steel) the working stress was taken at 6.5 tons per sq. in. in bottom booms and diagonals, 6.0 tons in top booms, 5.0 tons in verticals and long compression members. For the Stanley bridge at Brisbane the limits were 6.5 tons per sq. in. in compression boom, 7.0 tons in tension boom, 5.0 tons in vertical struts, 6.5 tons in diagonal ties, 8.0 tons in wind bracing, and 6.5 tons in cross and rail girders. In the new Tay bridge the limit of stress is generally 5 tons per sq. in., but in members in which the stress changes sign 4 tons per sq. in. In the Forth bridge for members in which the stress varied from 0 to a maximum frequently, the limit was 5.0 tons per sq. in., or if the stress varied rarely 5.6 tons per sq. in.; for members subjected to alternations of tension and thrust frequently 3.5 tons per sq. in. or 5 tons per sq. in. if the alternations were infrequent. The shearing area of rivets in tension members was made $1\frac{1}{2}$ times the useful section of plate in tension. For compression members the shearing area of rivets in butt-joints was made half the useful section of plate in compression.

20. *Determination of Stresses in the Members of Bridges.*—It is convenient to consider beam girder or truss bridges, and it is the stresses in the main girders which primarily require to be determined. A main girder consists of an upper and lower flange, boom or chord and a vertical web. The loading forces to be considered are vertical, the horizontal forces due to wind pressure are treated separately and provided for by a horizontal system of bracing. For practical purposes it is accurate enough to consider the booms or chords as carrying exclusively the horizontal tension and compression and the web as resisting the whole of the vertical and, in a plate web, the equal horizontal shearing forces. Let fig. 37 represent a beam with any system of loads W_1, W_2, \dots, W_n .

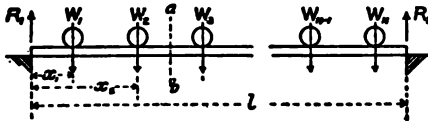

FIG. 37.

The reaction at the right abutment is $R_2 = W_1x_1/l + W_2x_2/l + \dots$

That at the left abutment is $R_1 = W_1 + W_2 + \dots - R_2$.

Consider any section $a b$. The total shear at $a b$ is $S = R - \Sigma(W_1 + W_2 \dots)$

where the summation extends to all the loads to the left of the section. Let ρ_1, ρ_2, \dots be the distances of the loads from $a b$, and ρ the distance of R_1 from $a b$; then the bending moment at $a b$ is $M = R_1\rho - \Sigma(W_1\rho_1 + W_2\rho_2 \dots)$

where the summation extends to all the loads to the left of $a b$. If the loads on the right of the section are considered the expressions are similar and give the same results.

If A_t, A_c are the cross sections of the tension and compression flanges or chords, and h the distance between their mass centres, then on the assumption that they resist all the direct horizontal forces the total stress on each flange is $H_t = H_c = M/h$

$$H_t = H_c = M/h$$

and the intensity of stress of tension or compression is

$$f_t = M/A_t h$$

$$f_c = M/A_c h$$

If A is the area of the plate web in a vertical section, the intensity of shearing stress is

$$f_s = S/A$$

and the intensity on horizontal sections is the same. If the web is a braced web, then the vertical component of the stress in the web bars cut by the section must be equal to S .

21. *Method of Sections. A. Ritter's Method.*—In the case of braced structures the following method is convenient. When a section of a girder can be taken cutting only three bars, the stresses in the bars can be found by taking moments. In fig. 38 m cuts three bars, and the forces in the three bars cut by the section are C, S and T . There are to the left of the section the external forces, R, W_1, W_2 .

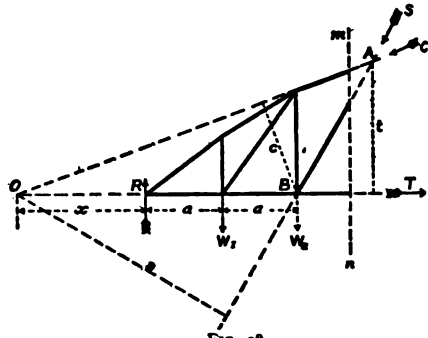

FIG. 38.

Let s be the perpendicular from O , the join of C and T on the direction of B ; t the perpendicular from A , the join of C and S on the direction of T ; and c the perpendicular from B , the join of S and T on the direction of C . Taking moments about O ,

$$Rx - W_1(x+a) - W_2(x+2a) = Ss;$$

taking moments about A ,

$$R_{3a} - W_{2a} - W_{2a} = Tt;$$

and taking moments about B ,

$$R_{2a} - W_{2a} = Cs.$$

Or generally, if M_1, M_2, M_3 are the moments of the external forces to the left of O, A , and B respectively, and s, t and c the perpendiculars from O, A and B on the directions of the forces cut by the section, then

$$Ss = M_1; Tt = M_2 \text{ and } Cs = M_3.$$

Still more generally if H is the stress on any bar, h the perpendicular distance from the join of the other two bars cut by the section, and M is the moment of the forces on one side of that join,

$$Hh = M.$$

22. *Distribution of Bending Moment and Shearing Force.*—Let a girder of span l , fig. 39, supported at the ends, carry a fixed load W at m from the right abutment. The reactions at the abutments are $R_1 = Wm/l$ and $R_2 = W(l-m)/l$. The shears on vertical sections

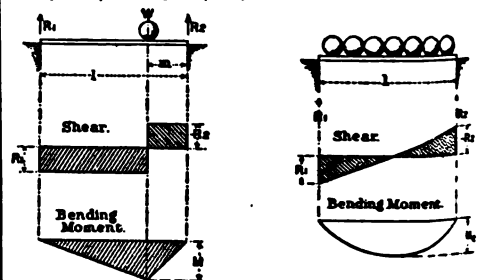

FIG. 39.

FIG. 40.

to the left and right of the load are R_1 and $-R_2$, and the distribution of shearing force is given by two rectangles. Bending moment increases uniformly from either abutment to the load, at which the bending moment is $M = R_1(l-m)$. The distribution of bending moment is given by the ordinates of a triangle. Next let the girder carry a uniform load w per ft. run (fig. 40). The total load

is w ; the reactions at abutments, $R_1 = R_2 = \frac{1}{2}wl$. The distribution of shear on vertical sections is given by the ordinates of a sloping line. The greatest bending moment is at the centre and $M_c = \frac{1}{8}wP^2$. At any point x from the abutment, the bending moment is $M = \frac{1}{2}wx(l-x)$, an equation to a parabola.

23. *Shear due to Travelling Loads.*—Let a uniform train weighing w per ft. run advance over a girder of span $2c$, from the left abutment. When it covers the girder to a distance x from the centre (fig. 41) the total load is $w(c+x)$; the reaction at B is

$$R_2 = w(c+x) \times \frac{c+x}{4c} = \frac{w}{4c}(c+x)^2,$$

which is also the shearing force at C for that position of the load. As the load travels, the shear at the head of the train will be given by the ordinates of a parabola having its vertex at A, and a maximum $F_{max} = \frac{1}{4}wl$ at B. If the load travels the reverse way, the shearing

force at the head of the train is given by the ordinates of the dotted parabola. The greatest shear at C for any position of the load occurs when the head of the train is at C. For any load p between C and B will increase the reaction at B and therefore the shear at C by part of p , but at the same time will diminish the shear at C by the whole

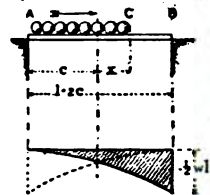

FIG. 41.

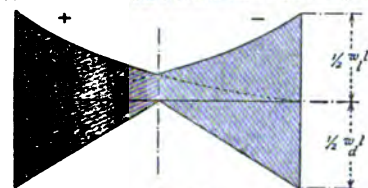

FIG. 42.

of p . The web of a girder must resist the maximum shear, and with a travelling load like a railway train, this is greater for partial than for complete loading. Generally a girder supports both a dead and a live load. The distribution of total shear, due to a dead load w_1 per ft. run and a travelling load w_2 per ft. run, is shown in fig. 42, arranged so that the dead

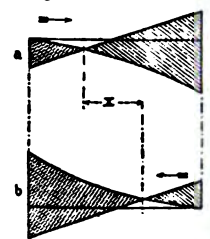

FIG. 43.

shear changes sign, according as the load advances from the left or the right. The bracing bars, therefore, for this part of the girder must be adapted to resist either tension or thrust. Further, the range of stress to which they are subjected is the sum of the stresses due to the load advancing from the left or the right.

25. *Greatest Shear when concentrated Loads travel over the Bridge.*—

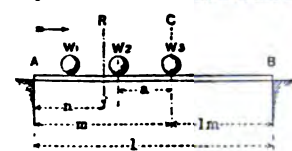

FIG. 44.

to find the greatest shear with a set of concentrated loads at fixed distances from the left abutment, and let C be the section at which the shear is required (fig. 44). The greatest shear at C may occur with W_1 at C. If W_1 passes beyond C, the shear at C will probably be greatest when W_1 is at C. Let R be the resultant of the loads on the bridge when W_1 is at C. Then the reaction at B and shear at C is Rn/l . Next let the loads advance a distance a so that W_2 comes to C. Then the shear at C is $R(n+a)/l - W_1$, plus any reaction d at B, due to any additional load which has come on the

girder during the movement. The shear will therefore be increased by bringing W_2 to C, if $Ra/l + d > W_1$, and is generally small and negligible. This result is modified if the action of the load near the section is distributed to the bracing intersections by rail and cross girders. In fig. 45 the action of W is distributed to A and B by the flooring. Then the loads at A and B are $W(p-x)/p$ and Wx/p . Now let C (fig. 46) be the section at which the greatest shear is required, and let the loads advance from the left till W_1 is at C. If R is the resultant of the loads then on the girder, the reaction at B and shear at C is Rn/l . But the shear may be greater when W_2 is at C. In that case the shear at C becomes $R(n+a)/l + d - W_1$, if $a > p$, and $R(n+a)/l + d - W_1a/p$, if $a < p$. If we neglect d , then the shear increases by moving W_2 to C, if $Ra/l > W_1$ in the first case, and if $Ra/l > W_1a/p$ in the second case.

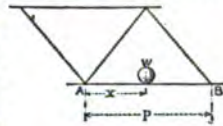

FIG. 45.

26. *Greatest Bending Moment due to travelling concentrated Loads.*—For the greatest bending moment due to a travelling live load, let a load of w per ft. run advance from the left abutment (fig. 47), and let its centre be at x from the left abutment. The reaction at B is $2wx^2/l$ and the bending moment at any section C, at m from the left abutment, is $2wx^2/(l-m)l$, which increases as x increases till the span is covered. Hence, for uniform travelling loads, the bending moments

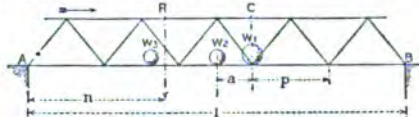

FIG. 46.

are greatest when the loading is complete. In that case the loads on either side of C are proportional to m and $l-m$. In the case of a series of travelling loads at fixed distances apart passing over the girder from the left, let W_1, W_2 (fig. 48), at distances x and $x+a$ from the left abutment, be their resultants on either side of C. Then the reaction at B is $W_1x/l + W_2(x+a)/l$. The bending moment at C is

$$M = W_1x(l-m)/l + W_2m[1 - (x+a)/l].$$

If the loads are moved a distance Δx to the right, the bending moment becomes

$$M + \Delta M = W_1(x + \Delta x)(l-m)/l + W_2m[1 - (x + \Delta x + a)/l]$$

$$\Delta M = W_1\Delta x(l-m)/l - W_2\Delta xm/l,$$

and this is positive or the bending moment increases, if $W_1(l-m) > W_2m$, or if $W_1m > W_2(l-m)$. But these are the average loads per ft. run to the left and right of C. Hence, if the average load to the left of a section is greater than that to the right, the bending moment at the section will be increased by moving the loads to the right, and vice versa. Hence the maximum bending moment at C for a series of travelling loads will occur when the average load is the same on either side of C. If one of the loads is at C, spread over a very small distance in the neighbourhood of C, then a very small displacement of the loads will permit the fulfilment of the condition. Hence the criterion for the position of the loads which makes the moment at C greatest is this: one load must be at C, and the other loads must be distributed, so that the average loads per ft. on either side of C (the load at C being neglected) are nearly equal. If the loads are very unequal in magnitude or distance this condition may be satisfied for more than one position of the loads, but it is not difficult to ascertain which position gives the maximum moment. Generally one of the largest of the loads must be at C with as many others to right and left as is consistent with that condition.

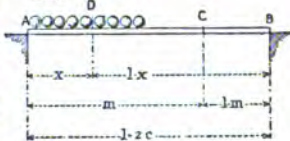

FIG. 47.

This criterion may be stated in another way. The greatest bending moment will occur with one of the greatest loads at the section, and when this further condition is satisfied. Let fig. 49 represent a beam with the series of loads travelling from the right. Let a, b be

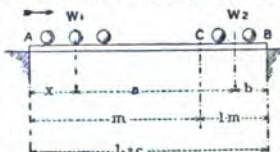

FIG. 48.

Let a, b be the distances from the left abutment to the centers of the loads W_1 and W_2 respectively. The reaction at B is $W_1x/l + W_2(x+a)/l$. The bending moment at section C is $W_1x(l-m)/l + W_2m[1 - (x+a)/l]$.

the section considered, and let W_a be the load at a when the bending moment there is greatest, and W_b the last load to the right then on the bridge. Then the position of the loads must be that which satisfies the condition

$$\frac{x}{l} \text{ greater than } \frac{W_1 + W_2 + \dots + W_{n-1}}{W_1 + W_2 + \dots + W_n}$$

$$\frac{x}{l} \text{ less than } \frac{W_1 + W_2 + \dots + W_2}{W_1 + W_2 + \dots + W_n}$$

Fig. 50 shows the curve of bending moment under one of a series of travelling loads at fixed distances. Let W_1, W_2, W_3 traverse the girder from the left at fixed distances a, b . For the position shown the distribution of bending moment due to W_1 is given by ordinates of the triangle $A'CB'$; that due to W_2 by ordinates of $A'DB'$; and that due to W_3 by ordinates of $A'EB'$. The total moment at W_1 , due to three loads, is the sum $mC + ms + ms$ of the intercepts

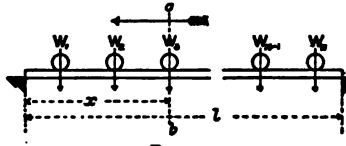

FIG. 49.

which the triangle sides cut off from the vertical under W_1 . As the loads move over the girder, the points C, D, E describe the parabolas M_1, M_2, M_3 , the middle ordinates of which are $\frac{1}{2}W_1l, \frac{1}{2}W_2l$, and $\frac{1}{2}W_3l$. If these are first drawn it is easy, for any position of the loads, to draw the lines $B'C, B'D, B'E$, and to find the sum of the intercepts which is the total bending moment under a load. The lower portion of the figure is the curve of bending moments under the leading load. Till W_1 has advanced a distance a only one load is on the girder, and the curve $A'F$ gives bending moments due to W_1 only; as W_1 advances to a distance $a+b$, two loads are on the girder, and the curve FG gives moments due to W_1 and W_2 . GB' is the curve of moments for all three loads $W_1 + W_2 + W_3$.

Fig. 51 shows maximum bending moment curves for an extreme case of a short bridge with very unequal loads. The three lightly

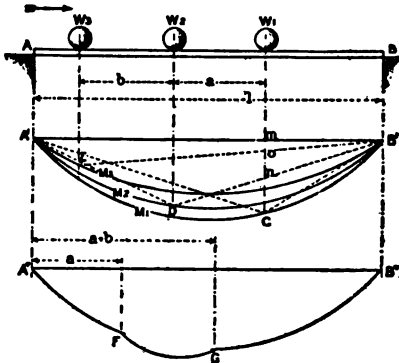

FIG. 50.

dotted parabolas are the curves of maximum moment for each of the loads taken separately. The three heavily dotted curves are curves of maximum moment under each of the loads, for the three loads passing over the bridge, at the given distances, from left to right. As might be expected, the moments are greatest in this case at the sections under the 15-ton load. The heavy continuous line gives the last-mentioned curve for the reverse direction of passage of the loads.

With short bridges it is best to draw the curve of maximum bending moments for some assumed typical set of loads in the way just described, and to design the girder accordingly. For longer bridges the funicular polygon affords a method of determining maximum bending moments which is perhaps more convenient. But very great accuracy in drawing this curve is unnecessary, because the rolling stock of railways varies so much that the precise magnitude and distribution of the loads which will pass over a bridge cannot be known. All that can be done is to assume a set of loads likely to produce somewhat severer straining than any probable actual rolling loads. Now, except for very short bridges and very unequal loads, a parabola can be found which includes the curve of maximum moments. This parabola is the curve of maximum moments for a travelling load uniform per ft. run. Let w be the load per ft. run which would produce the maximum moments

represented by this parabola. Then w may be termed the uniform load per ft. equivalent to any assumed set of concentrated loads. Waddell has calculated tables of such equivalent uniform loads. But it is not difficult to find w , approximately enough for practical purposes, very simply. Experience shows that (a) a parabola having the same ordinate at the centre of the span, or (b) a parabola having

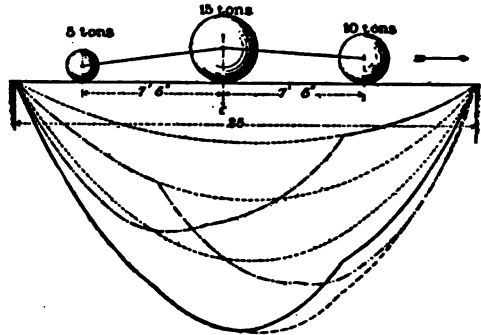

FIG. 51.

the same ordinate at one-quarter span as the curve of maximum moments, agrees with it closely enough for practical designing. A criterion already given shows the position of any set of loads which will produce the greatest bending moment at the centre of the bridge, or at one-quarter span. Let M_1 and M_2 be those moments. At a section distant x from the centre of a girder of span $2c$, the bending moment due to a uniform load w per ft. run is

$$M = \frac{1}{2}w(c-x)(c+x).$$

Putting $x = 0$, for the centre section

$$M_1 = \frac{1}{2}w_c^2;$$

and putting $x = \frac{1}{2}c$, for section at quarter span

$$M_2 = \frac{1}{8}w_c^2.$$

From these equations a value of w can be obtained. Then the bridge is designed, so far as the direct stresses are concerned, for bending moments due to a uniform dead load and the uniform equivalent load w .

27. Influence Lines.—In dealing with the action of travelling loads much assistance may be obtained by using a line termed an influence line. Such a line has for abscissa the distance of a load from one end of a girder, and for ordinate the bending moment or shear at any given section, or on any member, due to that load. Generally the influence line is drawn for unit load. In fig. 52 let $A'B'$ be a girder supported at the ends and let it be required to investigate the bending moment at C' due to unit load in any position on the girder. When the load is at F' , the reaction at B' is m/l and the moment at C' is $m(l-x)/l$, which will be reckoned positive, when it resists a tendency of the right-hand part of the girder to turn counter-clockwise. Projecting $A'F'C'B'$ on to the horizontal AB , take $Ff = m(l-x)/l$, the moment at C of unit load at F . If this process is repeated for all positions of the load, we get the influence line AGB for the bending moment at C . The area AGB is termed the influence area. The greatest moment CG at C is $x(l-x)/l$. To use this line to investigate the maximum moment at C due to a series

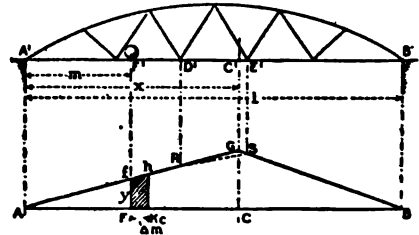

FIG. 52.

of travelling loads at fixed distances, let P_1, P_2, P_3, \dots be the loads which at the moment considered are at distances m_1, m_2, \dots from the left abutment. Set off these distances along AB and let y_1, y_2, \dots be the corresponding ordinates of the influence curve ($y = Ff$) on the verticals under the loads. Then the moment at C due to all the loads is

$$M = P_1y_1 + P_2y_2 + \dots$$

The position of the loads which gives the greatest moment at C may be settled by the criterion given above. For a uniform travelling load w per ft. of span, consider a small interval $Fk = \Delta w$ on which the load is $w\Delta w$. The moment due to this, at C, is $w\Delta w(l-x)\Delta w/l$. But $w(l-x)\Delta w/l$ is the area of the strip Fk , that is Δw . Hence the moment of the load on Δw at C is $w\Delta w$, and the moment of a uniform load over any portion of the girder is $w \times$ the area of the influence curve under that portion. If the scales are so chosen that a inch represents 1 in. of moment, and b inch represents 1 ft. of span, and w is in tons per ft. run, then w is the unit of area in measuring the influence curve.

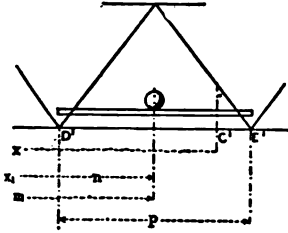

FIG. 53.

If the load is carried by a rail girder (stringer) with cross girders at the intersections of bracing and boom, its effect is distributed to the bracing intersections D'E' (fig. 53), and the part of the influence line for that bay (panel) is altered. With unit load in the position shown, the load at D' is $(\rho-n)/\rho$, and that at E' is n/ρ . The moment of the load at C is $w(l-x)/l - n(\rho-n)/\rho$. This is the equation to the dotted line RS (fig. 52).

If the unit load is at F', the reaction at B' and the shear at C' is m/l , positive if the shearing stress resists a tendency of the part of the girder on the right to move upwards; set up $Ff = m/l$ (fig. 54)

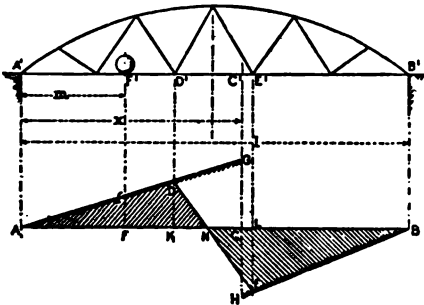

FIG. 54.

on the vertical under the load. Repeating the process for other positions, we get the influence line AGHB, for the shear at C due to unit load anywhere on the girder. $GC = x/l$ and $CH = (l-x)/l$. The lines AG, HB are parallel. If the load is in the bay D'E' and is carried by a rail girder which distributes it to cross girders at D'E', the part of the influence line under this bay is altered. Let n (fig. 55) be the distance of the load from D', s_1 the distance of D' from the left abutment, and ρ the length of a bay. The loads at D', E, due to unit weight on the rail girder are $(\rho-n)/\rho$ and n/ρ . The reaction at B' is $[(\rho-n)s_1 + n(s_1 + \rho)]/\rho$. The shear at C' is the reaction at B' less the load at E', that is,

$$\{[\rho(s_1 + n) - n]/\rho\}$$

which is the equation to the line DH (fig. 54). Clearly, the distribution of the load by the rail girder considerably alters the distribution of shear due to a load in the bay in which the section considered lies. The total shear due to a series of loads P_1, P_2, \dots at distances m_1, m_2, \dots from the left abutment, $\gamma_1, \gamma_2, \dots$ being the ordinates

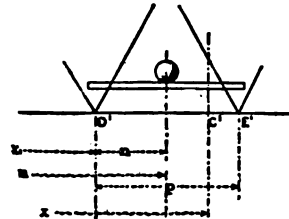

FIG. 55.

of the influence curve under the loads, is $S = P_1\gamma_1 + P_2\gamma_2 + \dots$. Generally, the greatest shear S at C will occur when the longer of the segments into which C divides the girder is fully loaded and the other is unloaded, the leading load being at C. If the loads are very unequal or unequally spaced, a trial or two will determine which position gives the greatest value of S. The greatest shear at C' of the opposite sign to that due to the loading of the longer segment

occurs with the shorter segment loaded. For a uniformly distributed load w per ft. run the shear at C is $w \times$ the area of the influence curve under the segment covered by the load, attention being paid to the sign of the area of the curve. If the load rests directly on the main girder, the greatest + and - shears at C will be $w \times AGC$ and $-w \times CHB$. But if the load is distributed to the bracing intersections by rail and cross girders, then the shear at C' will be greatest when the load extends to N, and will have the values $w \times ADN$ and $-w \times NEB$.

An interesting paper by F. C. Lea, dealing with the determination of stress due to concentrated loads, by the method of influence lines will be found in *Proc. Inst. C.E.* clxi. p. 261.

Influence lines were described by Fränkel, *Der Civilingenieur*, 1876. See also *Handbuch der Ingenieurwissenschaften*, vol. ii. ch. x. (1882), and Levy, *La Statique graphique* (1886). There is a useful paper by Prof. G. F. Swain (*Trans. Am. Soc. C.E.* xvii., 1887), and another by L. M. Hoskins (*Proc. Am. Soc. C.E.* xxv., 1899).

28. *Eddy's Method*.—Another method of investigating the maximum shear at a section due to any distribution of a travelling load has been given by Prof. H. T. Eddy (*Trans. Am. Soc. C.E.* xxii., 1890). Let hk (fig. 56) represent in magnitude and position a load W , at x from the left abutment, on a girder AB of span l . Lay off hf , hg , horizontal and equal to l . Join f and g to h and k . Draw verticals at A, B, and join no . Obviously no is horizontal and equal to l . Also $mn/mf = hk/kf$ or $mn = W(l-x)/l$, which is the reaction at A due to the load at C, and is the shear at any point of AC. Similarly, pe is the reaction at B and shear at any point of CB. The shaded rectangles represent the distribution of shear due to the load at C, while no may be termed the datum line of shear. Let the load move to D, so that its distance from the left abutment is $x+a$. Draw a vertical at D, intersecting hf , hg , in s and q . Then $q/r = hk/hg$ or $r = W(l-x-a)/l$, which is the reaction at A and shear at any point of AD, for the new position of the load. Similarly, $rs = W(x+a)/l$ is the shear on DB. The distribution of shear is given by the partially shaded rectangles. For the application of this method to a series of loads Prof. Eddy's paper must be referred to.

29. *Economic Span*.—In the case of a bridge of many spans, there is a length of span which makes the cost of the bridge least. The cost of abutments and bridge flooring is practically independent of the length of span adopted. Let P be the cost of one pier; G the cost of the main girders for one span, erected; n the number of spans; l the length of one span, and L the length of the bridge between abutments. Then, $n=L/l$ nearly. Cost of piers $(n-1)P$. Cost of main girders nG . The cost of a pier will not vary materially with the span adopted. It depends mainly on the character of the foundations and height at which the bridge is carried. The cost of the main girders for one span will vary nearly as the square of the span for any given type of girder and intensity of live load. That is, $G = a^2$, where a is a constant. Hence the total cost of that part of the bridge which varies with the span adopted is—

$$C = (n-1)P + na^2 \\ = LP/l - P + La^2$$

Differentiating and equating to zero, the cost is least when

$$\frac{dC}{dl} = -\frac{LP}{l^2} + 2La = 0, \\ P = a^2l = G;$$

that is, when the cost of one pier is equal to the cost erected of the main girders of one span. Sir Guilford Molesworth puts this in a convenient but less exact form. Let G be the cost of superstructure

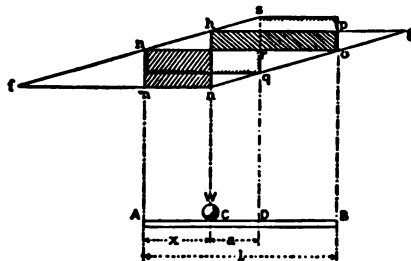

FIG. 56.

of a 100-ft. span erected, and P the cost of one pier with its protection. Then the economic span is $l = 100\sqrt{P/G}$.

30. *Limiting Span*.—If the weight of the main girders of a bridge, per ft. run in tons, is—

$$w_1 = (w_2 + w_3)l/(K-lr)$$

according to a formula already given, then w_1 becomes infinite if $h-lr = 0$, or if

$$l = K/r,$$

where l is the span in feet and r is the ratio of span to depth of girder at centre. Taking K for steel girders as 7200 to 9000, Limiting Span in Ft.

$r=12$	$l=600$ to 750
$=10$	$=720$ to 900
$=8$	$=900$ to 1120

The practical limit of span would be less than this. Professor Claxton Fidler (*Treatise on Bridge Construction*, 1887) has made a very careful theoretical analysis of the weights of bridges of different types, and has obtained the following values for the limiting spans. For parallel girders when $r=10$, the limiting span is 1070 ft. For parabolic or bowstring girders, when $r=8$, the limiting span is 1280 ft. For flexible suspension bridges with wrought iron link chains, and dip $=\frac{1}{16}$ th of the span, the limiting span is 2800 ft. For stiffened suspension bridges with wire cables, if the dip is $\frac{1}{16}$ th of the span the limiting span is 2700 to 3600 ft., and if the dip is $\frac{1}{8}$ th of the span, 3250 to 4250 ft., according to the factor of safety allowed.

31. *Braced Girders*.—A frame is a rigid structure composed of straight struts and ties. The struts and ties are called bracing bars. The frame as a whole may be subject to a bending moment, but each member is simply extended or compressed so that the total stress on a given member is the same at all its cross sections, while the intensity of stress is uniform for all the parts of any one cross section. This result must follow in any frame, the members of which are so connected that the joints offer little or no resistance to change in the relative angular position of the members. Thus if the members are pinned together, the joint consisting of a single circular pin, the centre of which lies in the axis of the piece, it is clear that the direction of the only stress which can be transmitted from pin to pin will coincide with this axis. The axis becomes, therefore, a line of resistance, and in reasoning of the stresses on frames we may treat the frame as consisting of simple straight lines from joint to joint. It is found in practice that the stresses on the several members do not differ sensibly whether these members are pinned together with a single pin or more rigidly jointed by several bolts or rivets. Frames are much used as girders, and they also give useful designs for suspension and arched bridges. A frame used to support a weight is often called a *truss*; the stresses on the various members of a truss can be computed for any given load with greater accuracy than the intensity of stress on the various parts of a continuous structure such as a tubular girder, or the rib of an arch. Many assumptions are made in treating of the flexure of a continuous structure which are not strictly true; no assumption is made in determining the stresses on a frame except that the joints are flexible, and that the frame shall be so stiff as not sensibly to alter in form under the load. Frames used as bridge trusses should never be designed so that the elongation or compression of one member can elongate or compress any other member. An example will serve to make the meaning of this limitation clearer. Let a frame consist of the five members AB, BD, DC, CA, CB (fig. 57), jointed at the points A, B, C and D, and all capable of resisting tension and compression. This frame will be *rigid*, i.e. it cannot be distorted without causing an alteration in the length of one or more of the members; but if from a change of temperature or any other cause one or all of the members change their length, this will not produce a stress on any member, but will merely cause a change in

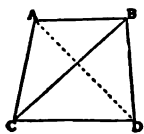

FIG. 57.

the form of the frame. Such a frame as this cannot be *self-strained*. A workman, for instance, cannot produce a stress on one member by making some other member of a wrong length. Any error of this kind will merely affect the form of the frame; if, however, another member be introduced between A and D, then if BC be shortened AD will be strained so as to extend it, and the four other members will be compressed; if CB is lengthened AD will thereby be compressed, and the four other members extended; if the workman does not make CB and AD of exactly the right length they and all the members will be permanently strained. These stresses will be unknown quantities, which the designer cannot take into account, and such a combination should if possible be avoided. A frame of this second type is said to have one *redundant member*.

32. *Types of Braced Girder Bridges*.—Figs. 58, 59 and 60 show an independent girder, a cantilever, and a cantilever and suspended girder bridge.

In a three-span bridge continuous girders are lighter than discontinuous ones by about 45% for the dead load and 15% for the live load, if no allowance is made for ambiguity due to uncertainty as to the level of the supports. The cantilever and suspended girder types are as economical and free from uncertainty as to the stresses. In long-span bridges the cantilever system permits erection by building out, which is economical and sometimes necessary. It is, however, unstable unless rigidly fixed at the piers. In the Forth bridge stability is obtained partly by the great excess of dead over live load, partly by the great width of the river piers. The majority of bridges not of great span have girders with parallel booms. This involves the fewest difficulties of workmanship and perhaps permits



FIG. 58.

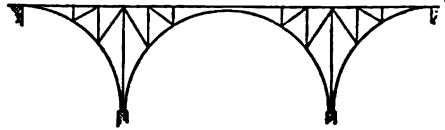

FIG. 59.

the closest approximation of actual to theoretical dimensions of the parts. In spans over 200 ft. it is economical to have one horizontal boom and one polygonal (approximately parabolic) boom. The hog-backed girder is a compromise between the two types, avoiding some difficulties of construction near the ends of the girder.

Most braced girders may be considered as built up of two simple

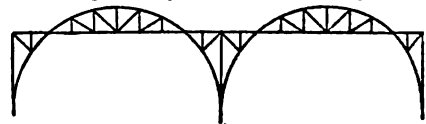

FIG. 60.

forms of truss, the king-post truss (fig. 61, a), or the queen-post truss (fig. 61, b). These may be used in either the upright or the inverted position. A *multiple truss* consists of a number of simple trusses, e.g. Bollman truss. Some timber bridges consist of queen-post trusses in the upright position, as shown diagrammatically in fig. 62, where the circles indicate points at which the flooring girders

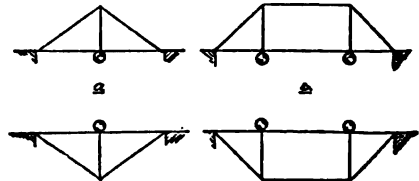

FIG. 61.

transmit load to the main girders. *Compound trusses* consist of simple trusses used as primary, secondary and tertiary trusses, the secondary supported on the primary, and the tertiary on the secondary. Thus, the Fink truss consists of king-post trusses; the Pratt truss (fig. 63) and the Whipple truss (fig. 64) of queen-post trusses alternately upright and inverted.

A combination bridge is built partly of timber, partly of steel,

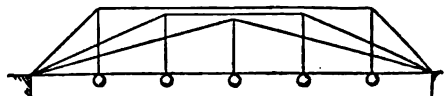

FIG. 62.

the compression members being generally of timber and the tension members of steel. On the Pacific coast, where excellent timber is obtainable and steel works are distant, combination bridges are still largely used (Ottewell, *Trans. Am. Soc. C.E.* xvii. p. 46). The combination bridge at Roseburgh, Oregon, is a cantilever bridge.

The shore arms are 147 ft. span, the river arms 105 ft., and the suspended girder 80 ft., the total distance between anchor piers being 584 ft. The floor beams, floor and railing are of timber. The compression members are of timber, except the struts and bottom chord panels next the river piers, which are of steel. The tension members are of iron and the pins of steel. The chord blocks and post shoes are of cast-iron.

33. *Graphic Method of finding the Stresses in Braced Structures.*—Fig. 65 shows a common form of bridge truss known as a *Warren girder*, with lines indicating external forces applied to the joints;

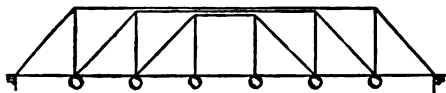

FIG. 63.

half the load carried between the two lower joints next the piers on either side is directly carried by the abutments. The sum of the two upward vertical reactions must clearly be equal to the sum of the loads. The lines in the diagram represent the directions of a series of forces which must all be in equilibrium; these lines may, for an object to be explained in the next paragraph, be conveniently named by the letters in the spaces which they separate instead of by the method usually employed in geometry. Thus we shall call the first inclined line on the left hand the line AG, the line representing the first force on the top left-hand joint AB, the first horizontal member at the top left hand the line BH, &c.; similarly each point requires at least three letters to denote it; the top first left-hand joint may be called ABHC, being the point where these four spaces meet. In this method of lettering, every enclosed space must be designated by a letter; all external forces must be represented by lines outside the frame, and each space between any two forces must receive a distinctive letter; this method of lettering was first proposed by O. Henrici and R. H. Bow (*Economics of Construction*), and is convenient in applying the theory of reciprocal figures to the computation of stresses on frames.

34. *Reciprocal Figures.*—J. Clerk Maxwell gave (*Phil. Mag.* 1864)



FIG. 64.

the following definition of reciprocal figures:—"Two plane figures are reciprocal when they consist of an equal number of lines so that corresponding lines in the two figures are parallel, and corresponding lines which converge to a point in one figure form a closed polygon in the other."

Let a frame (without redundant members), and the external forces which keep it in equilibrium, be represented by a diagram constituting one of these two plane figures, then the lines in the other plane figure or the reciprocal will represent in direction and magnitude the forces between the joints of the frame, and, consequently, the stress on each member, as will now be explained.

Reciprocal figures are easily drawn by following definite rules, and afford therefore a simple method of computing the stresses on members of a frame.

The external forces on a frame or bridge in equilibrium under those forces may, by a well-known proposition in statics, be represented by a closed polygon, each side of which is parallel to one force, and represents the force in magnitude as well as in direction. The sides of the polygon may be arranged in any order, provided care is taken so to draw them that in passing round the polygon in

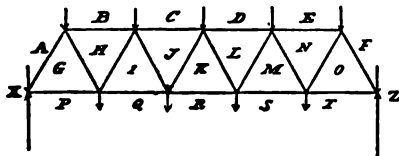

FIG. 65.

one direction this direction may for each side correspond to the direction of the force which it represents.

This polygon of forces may, by a slight extension of the above definition, be called the *reciprocal figure of the external forces*, if the sides are arranged in the same order as that of the joints on which they act, so that if the joints and forces be numbered 1, 2, 3, 4, &c., passing round the outside of the frame in one direction, and returning at last to joint 1, then in the polygon the side representing the force 2 will be next the side representing the force 1, and will be followed by the side representing the force 3, and so forth.

This polygon falls under the definition of a reciprocal figure given by Clerk Maxwell, if we consider the frame as a point in equilibrium under the external forces.

Fig. 66 shows a frame supported at the two end joints, and loaded at each top joint. The loads and the supporting forces are indicated by arrows. Fig. 67 a shows the reciprocal figure or polygon for the external forces on the assumption that the reactions are slightly inclined. The lines in fig. 67 a, lettered in the usual manner, correspond to the forces indicated by arrows in fig. 66, and lettered according to Bow's method. When all the forces are vertical, as will be the case in girders, the polygon of external forces will be reduced to two straight lines, fig. 67 b, superimposed and divided so that the length AX represents the load AX, the length AB the load AB, the length YX the reaction YX, and so forth. The line XZ consists of a series of lengths, as XA, AB, . . . DZ, representing the loads taken in their order. In subsequent diagrams the two reaction lines will, for the sake of clearness, be drawn as if slightly inclined to the vertical.

If there are no redundant members in the frame there will be only two members abutting at the point of support, for these two members will be sufficient to balance the reaction, whatever its direction may be; we can therefore draw two triangles, each having as one side the reaction YX, and having the two other sides parallel to these two members; each of these triangles will represent a polygon of forces in equilibrium at the point of support. Of these two triangles, shown in fig. 67 c, select that in which the letters X and Y are so placed that (naming the apex of the triangle E) the lines XE and YE are the lines parallel to the two members of the same name in the frame (fig. 66). Then the triangle YXE is the reciprocal

FIG. 66.

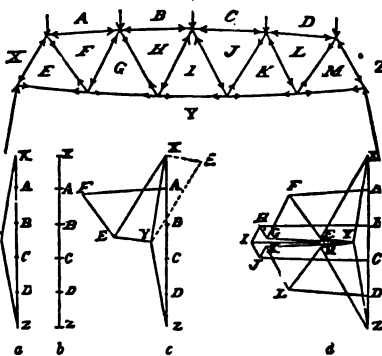

FIG. 67.

figure of the three lines YX, XE, EY in the frame, and represents the three forces in equilibrium at the point YXE of the frame. The direction of YX, being a thrust upwards, shows the direction in which we must go round the triangle YXE to find the direction of the two other forces; doing this we find that the force XE must act down towards the point YXE, and the force EY away from the same point. Putting arrows on the frame diagram to indicate the direction of the forces, we see that the member EY must pull and therefore act as a tie, and that the member XE must push and act as a strut. Passing to the point XEFA we find two known forces, the load XA acting downwards, and a push from the strut XE, which, being in compression, must push at both ends, as indicated by the arrow, fig. 66. The directions and magnitudes of these two forces are already drawn (fig. 67 a) in a fitting position to represent part of the polygon of forces at XEFA; beginning with the upward thrust EX, continuing down XA, and drawing AF parallel to AF in the frame we complete the polygon by drawing EF parallel to EF in the frame. The point F is determined by the intersection of the two lines, one beginning at A, and the other at E. We then have the polygon of forces EXAF, the reciprocal figure of the lines meeting at that point in the frame, and representing the forces at the point EXAF; the direction of the forces on EH and AX being known determines the direction of the forces due to the elastic reaction of the members AF and EF, showing AF to push as a strut, while EF is a tie. We have been guided in the selection of the particular quadrilateral adopted by the rule of arranging the order of the sides so that the same letters indicate corresponding sides in the diagram of the frame and its reciprocal. Continuing the construction of the diagram in the same way, we arrive at fig. 67 d as the complete reciprocal figure of the frame and forces upon it, and we see that each line in the reciprocal figure measures the stress on the corresponding member in the frame, and that the polygon of forces acting at any point, as IJKY, in the frame is represented by a polygon of the same name in the reciprocal

figure. The direction of the force in each member is easily ascertained by proceeding in the manner above described. A single known force in a polygon determines the direction of all the others, as these must all correspond with arrows pointing the same way round the polygon. Let the arrows be placed on the frame round each joint, and so as to indicate the direction of each force on that joint; then when two arrows point to one another on the same piece, that piece is a tie; when they point from one another the piece is a strut. It is hardly necessary to say that the forces exerted by the two ends of any one member must be equal and opposite. This method is universally applicable where there are no redundant members. The reciprocal figure for any loaded frame is a complete formula for the stress on every member of a frame of that particular class with loads on given joints.

Consider a Warren girder (fig. 68), loaded at the top and bottom joints. Fig. 69 *b* is the polygon of external forces, and 69 *c* is half the reciprocal figure. The complete reciprocal figure is shown in fig. 69 *a*. The method of sections already described is often more convenient than the method of reciprocal figures, and the method of influence lines is also often the readiest way of dealing with braced girders.

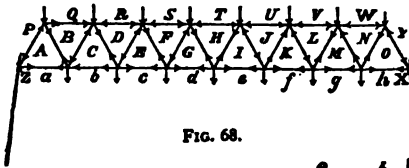

FIG. 68.

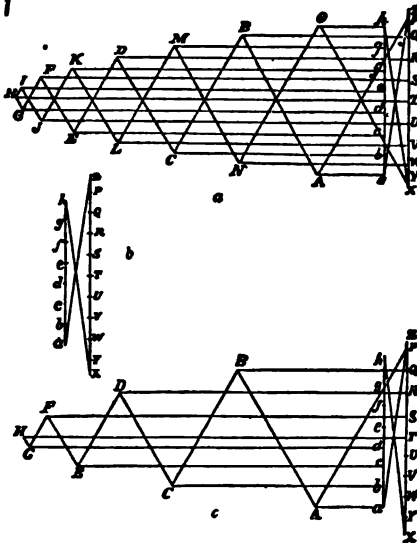

FIG. 69.

35. *Chain Loaded uniformly along a Horizontal Line*—If the lengths of the links be assumed indefinitely short, the chain under given simple distributions of load will take the form of comparatively simple mathematical curves known as catenaries. The true catenary is that assumed by a chain of uniform weight per unit of length, but the form generally adopted for suspension bridges is that assumed by a chain under a weight uniformly distributed relatively to a horizontal line. This curve is a parabola.

Remembering that in this case the centre bending moment $2wl$ will be equal to $wl^2/8$, we see that the horizontal tension H at the vertex for a span l (the points of support being at equal heights) is given by the expression

$$H = wl^2/8y,$$

or, calling x the distance from the vertex to the point of support,

$$H = wx^2/2y.$$

The value of H is equal to the maximum tension on the bottom flange, or compression on the top flange, of a girder of equal span, equally and similarly loaded, and having a depth equal to the dip of the suspension bridge.

Consider any other point F of the curve, fig. 70, at a distance x

from the vertex, the horizontal component of the resultant (tangent to the curve) will be unaltered; the vertical component V will be simply the sum of the loads between O and F , or wx . In the triangle FDC , let FD be tangent to the curve, FC vertical, and DC horizontal; these three sides will necessarily be proportional respectively to the

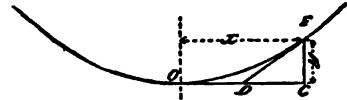

FIG. 70.

resultant tension along the chain at F , the vertical force V passing through the point D , and the horizontal tension at O ; hence

$$H : V = DC : FC = wx^2/2y : wx = x/2 : y,$$

hence DC is the half of OC , proving the curve to be a parabola. The value of R , the tension at any point at a distance x from the vertex, is obtained from the equation

$$R^2 = H^2 + V^2 = wx^2/4y^2 + w^2x^2,$$

or,

$$R = wx\sqrt{(1+x^2/4y^2)}.$$

Let i be the angle between the tangent at any point having the co-ordinates x and y measured from the vertex, then

$$\tan i = 2y/x.$$

Let the length of half the parabolic chain be called s , then

$$s = x + 2y^2/3x.$$

The following is the approximate expression for the relation between a change Δs in the length of the half chain and the corresponding change Δy in the dip:—

$$s + \Delta s = x + (2/3x)[y^2 + 2y\Delta y + (\Delta y)^2] = x + 2y^2/3x + 4y\Delta y/3x + 2\Delta y^2/3x.$$

or, neglecting the last term,

$$\Delta s = 4y\Delta y/3x,$$

and

$$\Delta y = 3x\Delta s/4y.$$

From these equations the deflection produced by any given stress on the chains or by a change of temperature can be calculated.

36. *Deflection of Girders*.—Let fig. 71 represent a beam bent by external loads. Let the origin O be taken at the lowest point of the bent beam. Then the deviation $y = DE$ of the neutral axis of the bent beam at any point D from the axis OX is given by the relation

$$\frac{dy}{dx} = \frac{M}{EI},$$

where M is the bending moment and I the amount of inertia of the beam at D , and E is the coefficient of elasticity. It is usually accurate enough in deflection calculations to take for I the moment of inertia at the centre of the beam and to consider it constant for the length of the beam. Then

$$\frac{dy}{dx} = \frac{1}{EI} \int M dx$$

$$y = \frac{1}{EI} \iint M dx^2.$$

The integration can be performed when M is expressed in terms of x . Thus for a beam supported at the ends and loaded with w per inch length $M = w(a^2 - x^2)$, where a is the half span. Then the deflection at the centre is the value of y for $x = a$, and is

$$\delta = \frac{5}{24} \frac{wa^4}{EI}$$

The radius of curvature of the beam at D is given by the relation

$$R = EI/M.$$

37. *Graphic Method of finding Deflection*.—Divide the span L into any convenient number n of equal parts of length l , so that $nl = L$; compute the radii of curvature R_1, R_2, R_3 for the several sections. Let measurements along the beam be represented according to any convenient scale, so that calling l_1 and l_2 the lengths to be drawn on paper, we have $L = al_1$; now let r_1, r_2, r_3 be a series of radii such that $r_1 = R_1/al_1, r_2 = R_2/al_2, \dots$, where b is any convenient constant chosen of such magnitude as will allow arcs with the radii, r_1, r_2, \dots , to be drawn with the means at the draughtsman's disposal. Draw a curve

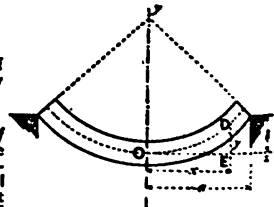

FIG. 71.

as shown in fig. 72 with arcs of the length l_1, l_2, l_3, \dots , and with the radii r_1, r_2, \dots (note, for a length l_1 , at each end the radius will be infinite, and the curve must end with a straight line tangent to the last arc), then let v be the measured deflection of this curve from the straight line, and V the actual deflection of the bridge; we have $V = \frac{v}{\delta}$, approximately. This method distorts the curve, so that vertical ordinates of the curve are drawn to a scale δ times greater than that of the horizontal ordinates. Thus if the horizontal scale be one-tenth of an inch to the foot, $g = 120$, and a beam 100 ft. in length would be drawn equal to 10 in.; then if the true radius at the centre were 10,000 ft., this radius, if the curve were undistorted,

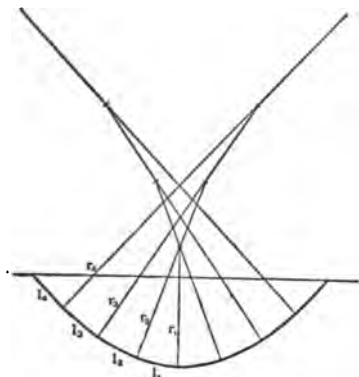

FIG. 72.

would be on paper 1000 in., but making $\delta = 50$ we can draw the curve with a radius of 20 in. The vertical distortion of the curve must not be so great that there is a very sensible difference between the length of the arc and its chord. This can be regulated by altering the value of δ . In fig. 72 distortion is carried too far; this figure is merely used as an illustration.

C. J. Camber.—In order that a girder may become straight under its working load it should be constructed with a camber or upward convexity equal to the calculated deflection. Owing to the yielding of joints when a beam is first loaded a smaller modulus of elasticity should be taken than for a solid bar. For riveted girders E is about 17,500,000 lb per sq. in. for first loading. W. J. M. Rankine gives the approximate rule

$$\text{Working deflection} = \frac{l^3}{P/10,000k},$$

where l is the span and k the depth of the beam, the stresses being those usual in bridge-work, due to the total dead and live load. (W. C. U.)

BRIDGET, SAINT, more properly BRIGID (*c.* 452-523), one of the patron saints of Ireland, was born at Faughart in county Louth, her father being a prince of Ulster. Refusing to marry, she chose a life of seclusion, making her cell, the first in Ireland, under a large oak tree, whence the place was called Kil-dara, "the church of the oak." The city of Kildare is supposed to derive its name from St Brigid's cell. The year of her death is generally placed in 523. She was buried at Kildare, but her remains were afterwards translated to Downpatrick, where they were laid beside the bodies of St Patrick and St Columba. Her feast is celebrated on the 1st of February. A large collection of miraculous stories clustered round her name, and her reputation was not confined to Ireland, for, under the name of St Bride, she became a favourite saint in England, and numerous churches were dedicated to her in Scotland.

See the five lives given in the Bollandist *Acta Sanctorum*, Feb. 1, i. 99, 119, 950. Cf. Whitley-Stokes, *Three Middle-Irish Homilies on the Lives of Saint Patrick, Brigit and Columba* (Calcutta, 1874); Colgan, *Acta SS. Hiberniæ*; D. O'Hanlon, *Lives of Irish Saints*, vol. ii.; Knowles, *Life of St Brigid* (1907); further bibliography in Ulysse Chevalier, *Répertoire des sources hist. Bio.-Bibl.* (2nd ed., Paris, 1905), s.v.

BRIDGET, BRIGITTA, BRIGITTA, OF SWEDEN, SAINT (*c.* 1302-1373), the most celebrated saint of the northern kingdoms, was the daughter of Birger Persson, governor and *lagman* (provincial judge) of Uppland, and one of the richest landowners of the country. In 1316 she was married to Ulf Gudmarson, lord of Nerica, to whom she bore eight children, one of whom was

afterwards honoured as St Catherine of Sweden. Bridget's saintly and charitable life soon made her known far and wide, she gained, too, great religious influence over her husband, with whom (1341-1343) she went on pilgrimage to St James of Compostella. In 1344, shortly after their return, Ulf died in the Cistercian monastery of Alvastra in East Gothland, and Bridget now devoted herself wholly to religion. As a child she had already believed herself to have visions; these now became more frequent, and her records of these "revelations," which were translated into Latin by Matthias, canon of Linköping, and by her confessor, Peter, prior of Alvastra, obtained a great vogue during the middle ages. It was about this time that she founded the order of St Saviour, or Bridgittines (*q.v.*), of which the principal house, at Vadstena, was richly endowed by King Magnus II. and his queen. About 1350 she went to Rome, partly to obtain from the pope the authorization of the new order, partly in pursuance of her self-imposed mission to elevate the moral tone of the age. It was not till 1370 that Pope Urban V. confirmed the rule of her order; but meanwhile Bridget had made herself universally beloved in Rome by her kindness and good works. Save for occasional pilgrimages, including one to Jerusalem in 1373, she remained in Rome till her death on the 23rd of July 1373. She was canonized in 1391 by Pope Boniface IX., and her feast is celebrated on the 9th of October.

BIBLIOGRAPHY.—Cf. the Bollandist *Acta Sanctorum*, Oct. 8, iv. 368-360; the *Vita Sanctae Brigittae*, edited by C. Annerstedt in *Scriptores rerum Suedicarum mediæ ævi*, iii. 185-244 (Upsala, 1871). The best modern work on the subject is by the comtesse Catherine de Flavigny, entitled *Sainte Brigide de Suède, sa vie, ses révélations et son œuvre* (Paris, 1892), which contains an exhaustive bibliography. The Revelations are contained in the critical edition of St Bridget's works published by the Swedish Historical Society and edited by G. E. Klemming (Stockholm, 1857-1884, 11 vols.). For full bibliography (to 1904) see Ulysse Chevalier, *Répertoire des sources hist. Bio.-Bibl.*, s.v. "Brigitte."

BRIDGETON, a city, port of entry, and the county-seat of Cumberland county, New Jersey, U.S.A., in the south part of the state, on Cohansy creek, 38 m. S. of Philadelphia. Pop. (1890) 11,424; (1900) 13,913, of whom 653 were foreign-born and 701 were negroes; (1905) 13,624; (1910) 14,200. It is served by the West Jersey & Sea Shore and the Central of New Jersey railways, by electric railways connecting with adjacent towns, and by Delaware river steamboats on Cohansy creek, which is navigable to this point. It is an attractive residential city, has a park of 650 acres and a fine public library, and is the seat of West Jersey academy and of Ivy Hall; a school for girls. It is an important market town and distributing centre for a rich agricultural region; among its manufactures are glass (the product, chiefly glass bottles, being valued in 1905 at \$1,252,705—42.3% of the value of all the city's factory products—and Bridgeton ranking eighth among the cities of the United States in this industry), machinery, clothing, and canned fruits and vegetables; it also has dyeing and finishing works. Though Bridgeton is a port of entry, its foreign commerce is relatively unimportant. The first settlement in what is now Bridgeton was made toward the close of the 18th century. A pioneer iron-works was established here in 1814. The city of Bridgeton, formed by the union of the township of Bridgeton and the township of Cohansy (incorporated in 1845 and 1848 respectively), was chartered in 1864.

BRIDGETT, THOMAS EDWARD (1829-1899), Roman Catholic priest and historical writer, was born at Derby on the 20th of January 1829. He was brought up a Baptist, but in his sixteenth year joined the Church of England. In 1847 he entered St John's College, Cambridge, with the intention of taking orders. Being unable to subscribe to the Thirty-Nine Articles he could not take his degree, and in 1850 became a Roman Catholic, soon afterwards joining the Congregation of the Redemptorists. He went through his novitiate at St Trond in Belgium, and after a course of five years of theological study at Wittem, in Holland, was ordained priest. He returned to England in 1856, and for over forty years led an active life as a missionary in England and Ireland, preaching in over 80 missions and 140 retreats to the

clergy and to nuns. His stay in Limerick was particularly successful, and he founded a religious confraternity of laymen which numbered 5000 members. Despite his arduous life as a priest, Bridgett found time to produce literary works of value, chiefly dealing with the history of the Reformation in England; among these are *The Life of Blessed John Fisher, Bishop of Rochester* (1888); *The Life and Writings of Sir Thomas More* (1890); *History of the Eucharist in Great Britain* (2 vols., 1881); *Our Lady's Dowry* (1875, 3rd ed. 1890). He died at Clapham on the 17th of February 1899.

For a complete list of Bridgett's works see *The Life of Father Bridgett*, by C. Ryder (London, 1906).

BRIDGEWATER, FRANCIS EGERTON, 3RD DUKE OF (1736-1803), the originator of British inland navigation, younger son of the 1st duke, was born on the 21st of May 1736. Scrop, 1st duke of Bridgewater (1681-1745), was the son of the 3rd earl of Bridgewater, and was created a duke in 1720; he was the great-grandson of John Egerton, 1st earl of Bridgewater (d. 1649; cr. 1617), whose name is associated with the production of Milton's *Comus*; and the latter was the son of Sir Thomas Egerton (1540-1617), Queen Elizabeth's lord keeper and James I.'s lord chancellor, who was created baron of Ellesmere in 1603, and in 1616 Viscount Brackley (q.v.).

Francis Egerton succeeded to the dukedom at the age of twelve on the death of his brother, the 2nd duke. As a child he was sickly and of such unpromising intellectual capacity that at one time the idea of cutting the entail was seriously entertained. Shortly after attaining his majority he became engaged to the beautiful duchess of Hamilton, but her refusal to give up the acquaintance of her sister, Lady Coventry, led to the breaking off of the match. Thereupon the duke broke up his London establishment, and retiring to his estate at Worsley, devoted himself to the making of canals. The navigable canal from Worsley to Manchester which he projected for the transport of the coal obtained on his estates was (with the exception of the Sankey canal) the first great undertaking of the kind executed in Great Britain in modern times. The construction of this remarkable work, with its famous aqueduct across the Irwell, was carried out by James Brindley, the celebrated engineer. The completion of this canal led the duke to undertake a still more ambitious work. In 1762 he obtained parliamentary powers to provide an improved waterway between Liverpool and Manchester by means of a canal. The difficulties encountered in the execution of the latter work were still more formidable than those of the Worsley canal, involving, as they did, the carrying of the canal over Sale Moor Moss. But the genius of Brindley, his engineer, proved superior to all obstacles, and though at one period of the undertaking the financial resources of the duke were almost exhausted, the work was carried to a triumphant conclusion. The untiring perseverance displayed by the duke in surmounting the various difficulties that retarded the accomplishment of his projects, together with the pecuniary restrictions he imposed on himself in order to supply the necessary capital (at one time he reduced his personal expenses to £400 a year), affords an instructive example of that energy and self-denial on which the success of great undertakings so much depends. Both these canals were completed when the duke was only thirty-six years of age, and the remainder of his life was spent in extending them and in improving his estates; and during the latter years of his life he derived a princely income from the success of his enterprise. Though a steady supporter of Pitt's administration, he never took any prominent part in politics.

He died unmarried on the 8th of March 1803, when the ducal title became extinct, but the earldom of Bridgewater passed to a cousin, John William Egerton, who became 7th earl. By his will he devised his canals and estates on trust, under which his nephew, the marquess of Stafford (afterwards first duke of Sutherland), became the first beneficiary, and next his son Francis Leveson Gower (afterwards first earl of Ellesmere) and his issue. In order that the trust should last as long as possible, an extraordinary use was made of the legal rule that property may be

settled for the duration of lives in being and twenty-one years after, by choosing a great number of persons connected with the duke and their living issue and adding to them the peers who had taken their seats in the House of Lords on or before the duke's decease. Though the last of the peers died in 1857, one of the commoners survived till the 19th of October 1853, and consequently the trust did not expire till the 19th of October 1903, when the whole property passed under the undivided control of the earl of Ellesmere. The canals, however, had in 1872 been transferred to the Bridgewater Navigation Company, by whom they were sold in 1887 to the Manchester Ship Canal Company.

BRIDGEWATER, FRANCIS HENRY EGERTON, 8TH EARL OF (1756-1829), was educated at Eton and Christ Church, Oxford, and became fellow of All Souls in 1780, and F.R.S. in 1781. He held the rectories of Middle and Whitchurch in Shropshire, but the duties were performed by a proxy. He succeeded his brother (see above) in the earldom in 1823, and spent the latter part of his life in Paris. He was a fair scholar, and a zealous naturalist and antiquarian. When he died in February 1829 the earldom became extinct. He bequeathed to the British Museum the valuable Egerton MSS. dealing with the literature of France and Italy, and also £12,000. He also left £8000 at the disposal of the president of the Royal Society, to be paid to the author or authors who might be selected to write and publish 1000 copies of a treatise "On the Power, Wisdom and Goodness of God, as manifested in the Creation." Mr Davies Gilbert, who then filled the office, selected eight persons, each to undertake a branch of this subject, and each to receive £1000 as his reward, together with any benefit that might accrue from the sale of his work, according to the will of the testator.

The Bridgewater treatises were published as follows:—1. *The Adaptation of External Nature to the Moral and Intellectual Condition of Man*, by Thomas Chalmers, D. D. 2. *The Adaptation of External Nature to the Physical Condition of Man*, by John Kidd, M. D. 3. *Astronomy and General Physics considered with reference to Natural Theology*, by William Whewell, D. D. 4. *The Hand, its Mechanism and Vital Endowments as evincing Design*, by Sir Charles Bell. 5. *Animal and Vegetable Physiology considered with reference to Natural Theology*, by Peter Mark Roget. 6. *Geology and Mineralogy considered with reference to Natural Theology*, by William Buckland, D. D. 7. *The Habits and Instincts of Animals with reference to Natural Theology*, by William Kirby. 8. *Chemistry, Meteorology, and the Function of Digestion, considered with reference to Natural Theology*, by William Prout, M. D. The works are of unequal merit; several of them took a high rank in apologetic literature. They first appeared during the years 1833 to 1840, and afterwards in Bohn's Scientific Library.

BRIDGITINES, an order of Augustinian canonesses founded by St Bridget of Sweden (q.v.) c. 1350, and approved by Urban V. in 1370. It was a "double order," each convent having attached to it a small community of canons to act as chaplains, but under the government of the abbess. The order spread widely in Sweden and Norway, and played a remarkable part in promoting culture and literature in Scandinavia; to this is to be attributed the fact that the head house at Vastein, by Lake Vetter, was not suppressed till 1595. There were houses also in other lands, so that the total number amounted to 80. In England, the famous Bridgettine convent of Syon at Isleworth, Middlesex, was founded and royally endowed by Henry V. in 1415, and became one of the richest and most fashionable and influential nunneries in the country. It was among the few religious houses restored in Mary's reign, when nearly twenty of the old community were re-established at Syon. On Elizabeth's accession they migrated to the Low Countries, and thence, after many vicissitudes, to Rouen, and finally in 1594 to Lisbon. Here they remained, always recruiting their numbers from England, till 1861, when they returned to England. Syon House is now established at Chudleigh in Devon, the only English community that can boast an unbroken conventual existence since pre-Reformation times. Some six other Bridgettine convents exist on the Continent, but the order is now composed only of women.

See Helyot, *Histoire des ordres religieux* (1715), iv. c. 4; Max Heimbucher, *Ordens u. Kongregationen* (1907), ii. § 83; Herzog, *Realencyclopädie* (ed. 3), art. "Birgitta"; A. Hamilton in *Dublin Review*, 1886, "The Nuns of Syon." (E. C. B.)

BRIDGMAN, FREDERICK ARTHUR (1847-), American artist, was born at Tuskegee, Alabama, on the 10th of November 1847. He began as a draughtsman in New York for the American Bank Note Company in 1864-1865, and studied art in the same years at the Brooklyn Art School and at the National Academy of Design; but he went to Paris in 1866 and became a pupil of J. L. Gérôme. Paris then became his headquarters. A trip to Egypt in 1873-1874 resulted in pictures of the East that attracted immediate attention, and his large and important composition, "The Funeral Procession of a Mummy on the Nile," in the Paris Salon (1877), bought by James Gordon Bennett, brought him the cross of the Legion of Honour. Other paintings by him were "An American Circus in Normandy," "Procession of the Bull Apis" (now in the Corcoran Art Gallery, Washington), and a "Rumanian Lady" (in the Temple collection, Philadelphia).

BRIDGMAN, LAURA DEWEY (1829-1886), American blind deaf-mute, was born on the 21st of December 1829 at Hanover, New Hampshire, U.S.A., being the third daughter of Daniel Bridgman (d. 1868), a substantial Baptist farmer, and his wife Harmony, daughter of Cushman Downer, and grand-daughter of Joseph Downer, one of the five first settlers (1761) of Thetford, Vermont. Laura was a delicate infant, puny and rickety, and was subject to fits up to twenty months old, but otherwise seemed to have normal senses; at two years, however, she had a very bad attack of scarlet fever, which destroyed sight and hearing, blunted the sense of smell, and left her system a wreck. Though she gradually recovered health she remained a blind deaf-mute, but was kindly treated and was in particular made a sort of playmate by an eccentric bachelor friend of the Bridgmans, Mr Asa Tenney, who as soon as she could walk used to take her for rambles a-field. In 1837 Mr James Barrett, of Dartmouth College, saw her and mentioned her case to Dr Mussey, the head of the medical department, who wrote an account which attracted the attention of Dr S. G. Howe (q.v.), the head of the Perkins Institution for the Blind at Boston. He determined to try to get the child into the Institution and to attempt to educate her; her parents assented, and in October 1837 Laura entered the school. Though the loss of her eye-balls occasioned some deformity, she was otherwise a comely child and of a sensitive and affectionate nature; she had become familiar with the world about her, and was imitative in so far as she could follow the actions of others; but she was limited in her communication with others to the narrower uses of touch—patting her head meant approval, rubbing her hand disapproval, pushing one way meant to go, drawing another to come. Her mother, preoccupied with house-work, had already ceased to be able to control her, and her father's authority was due to fear of superior force, not to reason. Dr Howe at once set himself to teach her the alphabet by touch. It is impossible, for reasons of space, to describe his efforts in detail. He taught words before the individual letters, and his first experiment consisting in pasting upon several common articles such as keys, spoons, knives, &c., little paper labels with the names of the articles printed in raised letters, which he got her to feel and differentiate; then he gave her the same labels by themselves, which she learnt to associate with the articles they referred to, until, with the spoon or knife alone before her she could find the right label for each from a mixed heap. The next stage was to give her the component letters and teach her to combine them in the words she knew, and gradually in this way she learnt all the alphabet and the ten digits, &c. The whole process depended, of course, on her having a human intelligence, which only required stimulation, and her own interest in learning became keener as she progressed. On the 21th of July 1839 she first wrote her own name legibly. Dr Howe devoted himself with the utmost patience and assiduity to her education and was rewarded by increasing success. On the 20th of June 1840 she had her first arithmetic lesson, by the aid of a metallic case perforated with square holes, square types being used; and in nineteen days she could add a column of figures amounting to thirty. She was in good health and happy, and was treated by Dr Howe as his daughter. Her case already began to interest the public, and others were brought to Dr Howe

for treatment. In 1841 Laura began to keep a journal, in which she recorded her own day's work and thoughts. In January 1842 Charles Dickens visited the Institution, and afterwards wrote enthusiastically in *American Notes* of Dr Howe's success with Laura. In 1843 funds were obtained for devoting a special teacher to her, and first Miss Swift, then Miss Wight, and then Miss Paddock, were appointed; Laura by this time was learning geography and elementary astronomy. By degrees she was given religious instruction, but Dr Howe was intent upon not inculcating dogma before she had grasped the essential moral truths of Christianity and the story of the Bible. She grew up a gay, cheerful girl, loving, optimistic, but with a nervous system inclining to irritability, and requiring careful education in self-control. In 1860 her eldest sister Mary's death helped to bring on a religious crisis, and through the influence of some of her family she was received into the Baptist church; she became for some years after this more self-conscious and rather pietistic. In 1867 she began writing compositions which she called poems; the best-known is called "Holy Home." In 1872, Dr Howe having been enabled to build some separate cottages (each under a matron) for the blind girls, Laura was moved from the larger house of the Institution into one of them, and there she continued her quiet life. The death of Dr Howe in 1876 was a great grief to her; but before he died he had made arrangements by which she would be financially provided for in her home at the Institution for the rest of her life. In 1887 her jubilee was celebrated there, but in 1889 she was taken ill, and she died on the 24th of May. She was buried at Hanover. Her name has become familiar everywhere as an example of the education of a blind deaf-mute, leading to even greater results in Helen Keller.

See *Laura Bridgman*, by Maud Howe and Florence Howe Hall (1903), which contains a bibliography; and *Life and Education of Laura Dewey Bridgman* (1878), by Mary S. Lamson. (H. Ch.)

BRIDGNORTH, a market town and municipal borough in the Ludlow parliamentary division of Shropshire, England, 150 m. N.W. by W. from London by the Great Western railway, on the Worcester-Shrewsbury line. Pop. (1901) 6052. The river Severn separates the upper town on the right bank from the lower on the left. A steep line of rail connects them. The upper town is built on the acclivities and summit of a rock which rises abruptly from the river to the height of 180 ft., and gives the town a very picturesque appearance. The railway passes under by a long tunnel. On the summit is the tower of the old castle, leaning about 17° from the perpendicular. There are also two parish churches. That of St Leonard, formerly collegiate, was practically rebuilt in 1862. This parish was held by Richard Barter, the famous divine, in 1640. St Mary's church is in classic style of the late 18th century. The picturesque half-timbered style of domestic building is frequently seen in the streets. In this style are the town hall (1652), and a house dated 1580, in which was born in 1720 Thomas Percy, bishop of Dromore, the editor of the *Reliques of Ancient English Poetry*. The grammar school, founded in 1503, occupies an Elizabethan building; there are also a college of divinity, a blue-coat school, and a literary institute with library and school of art. There are large charities. Near the town is a curious ancient hermitage cave, in the sandstone. At Quatford, 1 m. south-east, the site of a castle dating from 1085 may be traced. This dominated the ancient Forest of Morf. Here Robert de Belesme originally founded the college which was afterwards moved to Bridgnorth. Bridgnorth manufactures carpets; brewing is carried on, and there is trade in agricultural produce. The town is governed by a mayor, 4 aldermen and 12 councillors. Area, 3018 acres.

The early history of Bridgnorth is connected with Æthelfleda, lady of the Mercians, who raised a mound there in 912 as part of her offensive policy against the Danes of the five boroughs. After the Conquest William I. granted the manor of Bridgnorth to Earl Roger of Shrewsbury, whose son Robert de Belesme transferred his castle and borough from Quatford to Bridgnorth, but on Robert's attainder in 1102 the town became a royal borough. It is probable that Henry I. granted the burgesses certain privileges, for Henry II. confirmed to them all the franchises and customs which they had in the time of Henry I. King John in 1215 granted them freedom from toll throughout England except the city of London, and in

1227 Henry III. conferred several new rights and liberties, among which were a gild merchant with a hause. These early charters were confirmed by several succeeding kings, Henry VI. granting in addition assize of bread and ale and other privileges. Bridgnorth was incorporated by James I. in 1546. The burgesses returned two members to parliament in 1295, and continued to do so until 1867, when they were assigned only one member. The town was disfranchised in 1885. A yearly fair on the feast of the Translation of St Leonard and three following days was granted to the burgesses in 1359, and in 1630 Charles I. granted them licence to hold another fair on the Thursday before the first week in Lent and two following days.

BRIDGWATER, a market town, port and municipal borough in the Bridgwater parliamentary division of Somerset, England, on the river Parret, 10 m. from its mouth, and 151½ m. by the Great Western railway W. by S. of London. Pop. (1901) 15,209. It is pleasantly situated in a level and well-wooded country, having on the east the Mendip range and on the west the Quantock hills. The town lies along both sides of the river, here crossed by a handsome iron bridge. Among several places of worship the chief is St Mary Magdalene's church; this has a north porch and windows dating from the 14th century, besides a lofty and slender spire; but it has been much altered by restoration. It possesses a fine painted reredos. A house in Blake Street, largely restored, was the birthplace of Admiral Blake in 1598. Near the town are the three fine old churches of Weston Zoyland, Chedzoy and Middlezoy, containing some good brasses and carved woodwork. The battlefield of Sedgemoor, where the Monmouth rebellion was finally crushed in 1685, is within 3 m.; while not far off is Charlinch, the home of the Agapemonites (q.v.). Bridgwater has a considerable coasting trade, importing grain, coal, wine, hemp, tallow and timber, and exporting Bath brick, farm produce, earthenware, cement and plaster of Paris. The river is navigable by vessels of 700 tons, though liable, when spring-tides are flowing, to a bore which rises, in rough weather, to a height of 9 ft. Bath brick, manufactured only here, and made of the mingled sand and clay deposited by every tide, is the staple article of commerce; iron-founding is also carried on. The town is governed by a mayor, 6 aldermen and 18 councillors. Area, 926 acres.

A settlement probably grew up in Saxon times at Bridgwater (*Briges, Briggwalleri, Briggwaster*), owing its origin as a trade centre to its position at the mouth of the chief river in Somerset. It became a manse borough by the charter granted by John in 1201, which provided that the town should be a free borough, the burgesses to be free and quit of all tolls, and made William de Briwere overlord. Other charters were granted by Henry III. in 1227 (confirmed in 1318, 1370, 1380), which gave Bridgwater a gild merchant. It was incorporated by charter of Edward IV. (1468), confirmed in 1554, 1586, 1629 and 1684. Parliamentary representation began in 1295 and continued until the Reform Act of 1870. A Saturday market and a fair on the 24th of June were granted by the charter of 1201. Another fair at the beginning of Lent was added in 1468, and a second market on Thursday, and fairs at Midsummer and on the 21st of September were added in 1554. Charles II. granted another fair on the 20th of December. The medieval importance of these markets and fairs for the sale of wool and wine and later of cloth has gone. The shipping trade of the port revived after the construction of the new dock in 1841, and corn and timber have been imported for centuries.

See S. G. Jarman, "History of Bridgwater," *Historical MSS. Commission, Report 9, Appendix; Victoria County History: Somerset, vol. ii.*

BRIDLINGTON, a market town, municipal borough and seaside resort in the Buckrose parliamentary division of the East Riding of Yorkshire, England, 31 m. N.N.E. from Hull by a branch of the North Eastern railway. Pop. (1891) 8919; (1901) 12,482. It is divided into two parts, the ancient market town lying about 1 m. from the coast, while the modern houses of Bridlington Quay, the watering-place, fringe the shore of Bridlington Bay. Southward the coast becomes low, but northward it is steep and very fine, where the great spur of Flamborough Head (q.v.) projects eastward. In the old town of Bridlington the church of St Mary and St Nicholas consists of the fine Decorated and Perpendicular nave, with Early English portions, of the priory church of an Augustinian foundation of the time of Henry I. There remains also the Perpendicular gateway, serving as the town-hall. The founder of the priory was Walter de Gaunt, about 1114, and the institution

flourished until 1537, when the last prior was executed for taking part in the Pilgrimage of Grace. A Congregational society was founded in 1662, and its old church, dating from 1702, stood until 1906. At Bridlington Quay there is excellent sea-bathing, and the parade and ornamental gardens provide pleasant promenades. Extensive works have been carried out along the sea front. There is a chalybeate spring. The harbour is enclosed by two stone piers, and there is good anchorage in the bay. The municipal borough is under a mayor, 6 aldermen and 18 councillors, and has an area of 2751 acres.

The mention of four burgesses at Bridlington (Brellington, Burlington) in the Domesday survey shows it to have been a borough before the Conquest. With the rest of the north of England, Bridlington suffered from the ravages of the Normans, and decreased in value from £32 in the reign of Edward the Confessor, when it formed part of the possessions of Earl Morcar, to 8s. at the time of the Domesday survey. By that time it was in the hands of the king by the forfeiture of Earl Morcar. It was granted by William II. to Gilbert de Ganst, whose son and heir Walter founded the priory and endowed it with the manor of Bridlington and other lands. From this date the importance of the town steadily increased. Henry I. and several succeeding kings confirmed Walter de Gaunt's gift, Stephen granting in addition the right to have a port. In 1546 Henry IV. granted the prior and convent exemption from fifteenths, tenths and subsidies, in return for prayer for himself and his queen in every mass sung at the high altar. After the Dissolution the manor remained with the crown until 1624, when Charles I. granted it to Sir John Ramsey, whose brother and heir, Sir George Ramsey, sold it in 1633 to thirteen inhabitants of the town on behalf of all the tenants of the manor. The thirteen lords were assisted by twelve other inhabitants chosen by the freeholders, and when the number of lords was reduced to six, seven others were chosen from the assistants. A chief lord was chosen every year. This system still holds good. It is evident from the fact of thirteen inhabitants being allowed to hold the manor that the town had some kind of incorporation in the 17th century, although its incorporation charter was not granted until 1809, when it was created a municipal borough. In 1200 King John granted the prior of Bridlington a weekly market on Saturday and an annual fair on the vigil, feast and morrow of the Assumption of the Virgin Mary. Henry VI. in 1446 granted the prior three new fairs yearly on the vigil, day and morrow of the Nativity of the Virgin Mary, the Deposition of St John, late prior of Bridlington, and the Translation of the same St John. All fairs and markets were sold with the manor to the inhabitants of the town.

See J. Thompson, *Historical Sketches of Bridlington* (1821); *Victoria County History: Yorkshire*.

BRIDPORT, ALEXANDER HOOD, VISCOUNT (1727-1814), British admiral, was the younger brother of Samuel, Lord Hood, and cousin of Sir Samuel and Captain Alexander Hood. Entering the navy in January 1741, he was appointed lieutenant of the "Bridgewater" six years later, and in that rank served for ten years in various ships. He was then posted to the "Prince," the flag-ship of Rear-Admiral Saunders (under whom Hood had served as a lieutenant) and in this command served in the Mediterranean for some time. Returning home, he was appointed to the "Minerva" frigate, in which he was present at Hawke's great victory in Quiberon Bay (20th November 1759). In 1761 the "Minerva" recaptured, after a long struggle, the "Warwick" of equal force, and later in the same year Captain Alexander Hood went in the "Africa" to the Mediterranean, where he served until the conclusion of peace. From this time forward he was in continuous employment afloat and ashore, and in the "Robust" was present at the battle of Ushant in 1778. Hood was involved in the court-martial on Admiral (afterwards Viscount) Keppel which followed this action, and although adverse popular feeling was aroused by the course which he took in Keppel's defence, his conduct does not seem to have injured his professional career. Two years later he was made rear-admiral of the white, and succeeded Kempenfelt as one of Howe's flag-officers, and in the "Queen" (90) he was present at the relief of Gibraltar in 1782. For a time he sat in the House of Commons. Promoted vice-admiral in 1785, he became K.B. in the following year, and on the occasion of the Spanish armament in 1790 flew his flag again for a short time. On the outbreak of the war with France in 1793 Sir Alexander Hood once more went to sea, this time as Howe's second in command, and he had his share in the operations which culminated in the "Glorious First of June," and for his services was made Baron Bridport of Cricket St Thomas in Somerset

in the Irish peerage. Henceforth Bridport was practically independent command. In 1795 he fought the much-criticized partial action of the 23rd of June off Belle-Ile, which, however unfavourably it was regarded in some quarters, was counted as a great victory by the public. Bridport's peerage was made English, and he became vice-admiral of England. In 1796-1797 he practically directed the war from London, rarely hoisting his flag afloat save at such critical times as that of the Irish expedition in 1797. In the following year he was about to put to sea when the Spithead fleet mutinied. He succeeded at first in pacifying the crew of his flag-ship, who had no personal grudge against their admiral, but a few days later the mutiny broke out afresh, and this time was uncontrollable. For a whole week the mutineers were supreme, and it was only by the greatest exertions of the old Lord Howe that order was then restored and the men returned to duty. After the mutiny had been suppressed, Bridport took the fleet to sea as commander-in-chief in name as well as in fact, and from 1798 to 1800 personally directed the blockade of Brest, which grew stricter and stricter as time went on. In 1800 he was relieved by St Vincent, and retired from active duty after fifty-nine years' service. In reward for his fine record his peerage was made a viscounty. He spent the remaining years of his life in retirement. He died on the 2nd of May 1814. The viscounty in the English peerage died with him; the Irish barony passed to the younger branch of his brother's family, for whom the viscounty was recreated in 1868.

See Charnock, *Biographia Navalis*, vi. 133; *Naval Chronicle*, i. 265; Ralle, *Nav. Biog.* i. 202.

BRIDPORT, a market town and municipal borough in the Western parliamentary division of Dorsetshire, England, 18 m. N.W. of Dorchester, on a branch of the Great Western railway. Pop. (1901) 5710. It is pleasantly situated in a hilly district on the river Brit, from which it takes its name. The main part of the town is about a mile from the sea, with which it is connected by a winding street, ending at a quay surrounded by the fishing village of West Bay, where the railway terminates. The church of St Mary is a handsome cruciform Perpendicular building. The harbour is accessible only to small vessels. There is some import trade in flax, timber and coal. The principal articles of manufacture have long been sailcloth, cordage, linen and fishing-nets. The municipal borough is under a mayor, 6 aldermen and 18 councillors. Area, 593 acres.

Bridport was evidently of some importance before the Conquest, when it consisted of 120 houses rated for all the king's services and paying geld for five hides. By 1086 the number of houses had decreased to 100, and of these 20 were in such a wretched condition that they could not pay geld. The town is first mentioned as a borough in the Pipe Roll of 1189, which states that William de Bendenges owed 59. 10s. for the ancient farm of Bridport, and that the men of the town owed tallage to the amount of 53s. 10d. Henry III. granted the first charter in 1252-1253, making the town a free borough and granting the burgesses the right to hold it at the ancient fee farm with an increase of 40s., and to choose two bailiffs to answer at the exchequer for the farm. A deed of 1381 shows that Henry III. also granted the burgesses freedom from toll. Bridport was incorporated by James I. in 1619, but Charles II. granted a new charter in 1667, and by this the town was governed until 1835. The first existing grant of a market and fairs to Bridport is dated 1593, but it appears from the *Quo Warranto* Rolls that Edward I. possessed a market there. The town was noted for the manufacture of ropes and cables as early as 1213, and an act of parliament (21 Henry, VIII.) shows that the inhabitants had "from time out of mind" made the cables, ropes and hawsers for the royal navy and for most of the other ships. Bridport was represented in parliament by two members from 1395 to 1867. In the latter year the number was reduced to one, and in 1885 the town was disfranchised.

BRIE (*Briegus salinus*, from Celtic *brick*, clay), an agricultural district of northern France, to the E. of Paris, bounded W. and S. by the Seine, N. by the Marne. It has an area of 2400 sq. m., comprising the greater part of the department of Seine-et-Marne, together with portions of the departments of Seine, Seine-et-Oise, Aisne, Marne and Aube. The western portion was known as the *Brie française*, the eastern portion as the *Brie champenoise*. The Brie forms a plateau with few eminences, varying in altitude between 300 and 500 ft. in the west, and between 500 and 650 ft. in the east. Its scenery is varied by forests of some size—the

chief being the Forêt de Senart, the Forêt de Crécy and the Forêt d'Armainvilliers. The surface soil is clay in which are embedded fragments of siliceous sandstone, used for millstones and constructional purposes; the subsoil is limestone. The Yères, a tributary of the Seine, and the Grand Morin and Petit Morin, tributaries of the Marne, are the chief rivers, but the region is not abundantly watered and the rainfall is only between 20 and 24 in. The Brie is famous for its grain and its dairy products, especially cheeses.

BRIEF (Lat. *brevis*, short), in English legal practice, the written statement given to a barrister to form the basis of his case. It was probably so called from its at first being only a copy of the original writ. Upon a barrister devolves the duty of taking charge of a case when it comes into court, but all the preliminary work, such as the drawing up of the case, serving papers, marshalling evidence, &c., is performed by a solicitor, so that a brief contains a concise summary for the information of counsel of the case which he has to plead, with all material facts in chronological order, and frequently such observations thereon as the solicitor may think fit to make, the names of witnesses, with the "proofs," that is, the nature of the evidence which each witness is ready to give, if called upon. The brief may also contain suggestions for the use of counsel when cross-examining witnesses called by the other side. Accompanying the brief may be copies of the pleadings (see PLEADING), and of all documents material to the case. The brief is always endorsed with the title of the court in which the action is to be tried, with the title of the action, and the names of the counsel and of the solicitor who delivers the brief. Counsel's fee is also marked. The delivery of a brief to counsel gives him authority to act for his client in all matters which the litigation involves. The result of the action is noted on the brief by counsel, or if the action is compromised, the terms of the compromise are endorsed on each brief and signed by the leading counsel on the opposite side. In Scotland a brief is called a memorial.

In the United States the word has, to a certain extent, a different meaning, a brief in its English sense not being required, for the American attorney exercises all the functions distributed in England between barristers and solicitors. A lawyer sometimes prepares for his own use what is called a "trial brief" for use at the trial. This corresponds in all essential particulars with the "brief" prepared by the solicitor in England for the use of counsel. But the more distinctive use of the term in America is in the case of the brief "in error or appeal," before an appellate court. This is a written or printed document, varying according to circumstances, but embodying the argument on the question affected. Most of the appellate courts require the filing of printed briefs for the use of the court and opposing counsel at a time designated for each side before hearing. In the rules of the United States Supreme Court and circuit courts of appeals the brief is required to contain a concise statement of the case, a specification of errors relied on, including the substance of evidence, the admission or rejection of which is to be reviewed, or any extract from a charge excepted to, and an argument exhibiting clearly the points of law or fact to be discussed. This form of brief, it may be added, is also adopted for use at the trial in certain states of the Union which require printed briefs to be delivered to the court.

In English ecclesiastical law a brief meant letters patent issued out of chancery to churchwardens or other officers for the collection of money for church purposes. Such briefs were regulated by a statute of 1704, but are now obsolete, though they are still to be found named in one of the rubrics in the Communion service of the Book of Common Prayer.

The *brief-bag*, in which counsel's papers are carried to and from court, now forms an integral part of a barrister's outfit, but in the early part of the 19th century the possession of a brief-bag was strictly confined to those who had received one from a king's counsel. King's counsel were then few in number, were considered officers of the court, and had a salary of £40 a year, with a supply of paper, pens and purple bags. These bags they distributed among rising juniors of their acquaintance.

whose bundles of briefs were getting inconveniently large to be carried in their hands. These perquisites were abolished in 1830. English brief-bags are now either blue or red. Blue bags are those with which barristers provide themselves when first called, and it is a breach of etiquette to let this bag be visible in court. The only brief-bag allowed to be placed on the desks is the red bag, which by English legal etiquette is given by a leading counsel to a junior who has been useful to him in some important case.

BRIEG, a town of Germany, in the Prussian province of Silesia, on the left bank of the Oder, and on the Breslau and Beuthen railway, 27 m. S.E. of the former city. Pop. (1900) 24,090. It has a castle (the residence of the old counts of Brieg), a lunatic asylum, a gymnasium with a good library, several churches and hospitals, and a theatre. Its fortifications were destroyed by the French in 1807, and are now replaced by beautiful promenades. Brieg carries on a considerable trade, its chief manufactures being linen, embroideries, cotton and woollen goods, ribbons, leather, machinery, hats, pasteboard and cigars. Important cattle-markets are held here. Brieg, or, as it is called in early documents, *Civitas Alae Ripae*, obtained municipal rights in 1250 from Duke Henry III. of Breslau, and was fortified in 1297; its name is derived from the Polish *Brzeg* (shore). Burned by the Hussites in 1428, the town was soon afterwards rebuilt, and in 1595 it was again fortified by Joachim Frederick, duke of Brieg. In the Thirty Years' War it suffered greatly; in that of the Austrian succession it was heavily bombarded by the Prussian forces; and in 1807 it was captured by the French and Bavarians. From 1311 to 1675 Brieg was the capital of an independent line of dukes, a cadet branch of the Polish dukes of Lower Silesia, by one of whom the castle was built in 1341. In 1537 Frederick II., duke of Liegnitz, Brieg and Wohlau, concluded with Joachim II., elector of Brandenburg, a treaty according to which his duchy was to pass to the house of Brandenburg in the event of the extinction of his line. On the death of George William the last duke in 1675, however, Austria refused to acknowledge the validity of the treaty and annexed the duchies. It was the determination of Frederick II. of Prussia to assert his claim that led in 1740 to the war that ended two years later in the cession of Silesia to Prussia.

See Stokvis, *Manuel d'histoire*, iii. pp. 54, 64.

BRIEG, often now spelt **BRIG** (Fr. *Brigue*, Ital. *Briga*), a picturesque small town in the Swiss canton of the Valais, situated at the foot of the northern slope of the Simplon Pass, on the right bank of the Saline stream, and a little above its junction with the Rhone. Its older houses are very Italian in appearance, while its most prominent buildings (castle, former Jesuits' college and Ursuline convent) all date from the 17th century, and are due to the generosity of a single member of the local Stockalper family. The prosperity of Brieg is bound up with the Simplon Pass (*q.v.*), so that it gradually supplanted the more ancient village of Naters opposite, becoming a separate parish (the church is at Glis, a few minutes from the town) in 1517. Its medieval name was *Briga dives*. The opening of the carriage road across the Simplon (1807) and of the tunnel beneath the pass (1906), as well as the fact that above Brieg is the steeper and less fertile portion of the Upper Valais (now much frequented by tourists), have greatly increased the importance and size of the town. The opening of the railway tunnel beneath the Lötschen Pass, affording direct communication with Bern and the Bernese Oberland, is calculated still further to contribute to its prosperity. The new town extends below the old one and is closer to the right bank of the Rhone. In 1900 the population was 2182, almost all Romanists, while 1316 were German-speaking, 719 Italian-speaking (the Simplon tunnel workmen), and 142 French-speaking, one person only speaking Romansch.

(W. A. B. C.)

BRIELLE (*Briel* or *Briil*), a seaport in the province of South Holland, Holland, on the north side of the island of Voorn, at the mouth of the New Maas, 5½ m. N. of Hellevoetsluis. Pop. (1900) 4107. It is a fortified place and has a good harbour, arsenal, magazine and barracks. It also possesses a quaint town hall, and an orphanage dating from 1533. The tower of the Grote

Kerk of St Catherine serves as a lighthouse. Most of the trade of Brielle was diverted to Hellevoetsluis by the cutting of the Voornsche Canal in 1829, but it still has some business in corn and fodder, as well as a few factories. A large number of the inhabitants are also engaged in the fisheries and as pilots.

The chief event in the history of Brielle is its capture by the *Gueux sur Mer*, a squadron of privateers which raided the Dutch coast under commission of the prince of Orange. This event, which took place on the 1st of April 1572, was the first blow in the long war of Dutch independence, and was followed by a general outbreak of the patriotic party (Motley, *Rise of the Dutch Republic*, part iii. chapter vi.). "The Brill" was one of the four Dutch towns handed over to Queen Elizabeth in 1584 as security for English expenses incurred in aiding the Dutch. Brielle is the birthplace of the famous admiral Martin van Tromp, and also of Admiral van Almonde, a distinguished commander of the early 18th century.

BRIENNE-LE-CHÂTEAU, a town of north-eastern France, in the department of Aube, 1 m. from the right bank of the Aube and 26 m. N.E. of Troyes on the Eastern railway. Pop. (1906) 1761. The château, which overlooks the town, is an imposing building of the latter half of the 18th century, built by the cardinal de Brienne (see below). It possesses an important collection of pictures, many of them historical portraits of the 17th and 18th centuries. The church dates from the 16th century and contains good stained glass. A statue of Napoleon commemorates his sojourn at Brienne from 1779 to 1784, when he was studying at the military school suppressed in 1790. In 1814 Brienne was the scene of fighting between Napoleon and the Allies (see NAPOLEONIC CAMPAIGNS). Brewing is carried on in the town. Brienne-la-Vieille, a village 1½ m. south of Brienne-le-Château, has a church of the 12th and 16th centuries with fine stained windows. The portal once belonged to the ancient abbey of Bassecontaine, the ruins of which are situated near the village.

Counts of Brienne.—Under the Carolingian dynasty Brienne-le-Château was the capital town of a French countship. In the 10th century it was captured by two adventurers named Engelbert and Gobert, and from the first of these sprang the noble house of Brienne. In 1210 John of Brienne (1148-1237) became king of Jerusalem, through his marriage with Mary of Montferrat, heiress of the kingdom of Jerusalem. He led a crusade in Egypt which had no lasting success; and when in 1229 he was elected emperor of the East, for the period of Baldwin II.'s minority, he fought and conquered the Greek emperor John III. (Bataszes or Vatatzes). Walter V., count of Brienne and of Lecce (Apulia) and duke of Athens, fought against the Greeks and at first drove them from Thessaly, but was eventually defeated and killed near Lake Copais in 1311. His son, Walter VI., after having vainly attempted to reconquer Athens in 1331, served under Philip of Valois against the English. Having defended Florence against the Pisans he succeeded in obtaining dictatorial powers for himself in the republic; but his tyrannical conduct brought about his expulsion. He was appointed constable of France by John the Good, and was killed at the battle of Poitiers in 1356. His sister and heiress Isabella married Walter of Enghien, and so brought Brienne to the house of Enghien, and, by his marriage with Margaret of Enghien, John of Luxembourg-St Pol (d. about 1397) became count of Brienne. The house of Luxembourg retained the countship until Margaret Charlotte of Luxembourg sold it to a certain Marpon, who ceded it to Henri Auguste de Loménie (whose wife, Louise de Blois, descended from the house of Luxembourg-Brienne) in 1643. The Limousin house of Loménie (the genealogies which trace this family to the 15th century are untrustworthy) produced many well-known statesmen, among others the celebrated cardinal Étienne Charles de Loménie de Brienne (1727-1794), minister of Louis XV.; and the last lords of Brienne were members of this family. (M. P.)

BRIENZ, LAKE OF, in the Swiss canton of Bern, the first lake into which the river Aar expands. It lies in a deep hollow between the village of Brienz on the east (2580 inhabitants, the

chief centre of the Swiss wood-carving industry) and, on the west, Böigen (1515 inhabitants), close to Interlaken. Its length is about 9 m., its width 1½ m., and its maximum depth 856 ft., while its area is 11½ sq. m., and the surface is 1857 ft. above the sea-level. On the south shore are the Giesbach Falls and the hamlet of Iseltwald. On the north shore are a few small villages. The character of the lake is gloomy and sad as compared with its neighbour, that of Thum. Its chief affluent is the Lütchine (flowing from the valleys of Grindelwald and Lauterbrunnen). The first steamer was placed on the lake in 1839. (W. A. B. C.)

BRIERLEY, BENJAMIN (1825-1896), English weaver and writer in Lancashire dialect, was born near Manchester, the son of humble parents, and started life in a textile factory, educating himself in his spare time. At about the age of thirty he began to contribute articles to local papers, and the republication of some of his sketches of Lancashire character in *A Summer Day in Daisy Nook* (1859) attracted attention. In 1863 he definitely took to journalism and literature as his work, publishing in 1863 his *Chronicles of Waterlow*, and in 1864 a long story called *The Laycock of Langley Side* (afterwards dramatized), followed by others. He started in 1869 *Ben Brierley's Journal*, a weekly, which continued till 1891, and he gave public readings from his own writings, visiting America in 1880 and 1884. His various *Ab-e-th'-Yate* sketches (about America, London, &c.), and his pictures of Lancashire common life, were very popular, and were collected after his death. In 1884 he lost his savings by the failure of a building society, and a fund was raised for his support. He died on the 18th of January 1896, and two years later a statue was erected to him in Queen's Park, Manchester.

BRIERLY, SIR OSWALD WALTERS (1817-1894), English marine painter, who came of an old Cheshire family, was born at Chester. He entered Sass's art-school in London, and after studying naval architecture at Plymouth he exhibited some drawings of ships at the Royal Academy in 1839. He had a passion for the sea, and in 1841 started round the world with Benjamin Boyd (1796-1851), afterwards well known as a great Australian squatter, in the latter's ship "Wanderer," and having got to New South Wales, made his home at Auckland for ten years. Briery Point is called after him. He added to his sea experiences by voyages on H.M.S. "Rattlesnake" in 1848, and with Sir Henry Keppel on the "Meander" in 1850; he returned to England in 1851 on this ship, and illustrated Keppel's book about his cruise (1853). He was again with Keppel during the Crimean War, and published in 1855 a series of lithographs illustrating "The English and French fleets in the Baltic." He was now taken up by Queen Victoria and other members of the royal family, and was attached to the suites of the duke of Edinburgh and the prince of Wales on their tours by sea, the results being seen in further marine pictures by him; and in 1874 he was made marine-painter to the queen. He exhibited at the Academy, but more largely at the Royal Water-colour Society, his more important works including the historical pictures, "The Retreat of the Spanish Armada" (1871) and "The Loss of the *Revenge*" (1877). In 1885 he was knighted, and he died on the 14th of December 1894. He was twice married and had an active and prosperous life, but was no great artist; his best pictures are at Melbourne and Sydney.

BRIEUX, EUGÈNE (1858-), French dramatist, was born in Paris of poor parents on the 19th of January 1858. A one-act play, *Bernard Palissy*, written in collaboration with M. Gaston Salandri, was produced in 1879, but he had to wait eleven years before he obtained another hearing, his *Ménage d'artistes* being produced by Antoine at the Théâtre Libre in 1890. His plays are essentially didactic, being aimed at some weakness or iniquity of the social system. *Blanchette* (1892) pointed out the evil results of education of girls of the working classes; *M. de Réboval* (1892) was directed against pharisaism; *L'Engrenage* (1894) against corruption in politics; *Les Bienfaitiers* (1896) against the frivolity of fashionable charity; and *L'Évasion* (1896) satirized an indiscriminate belief in the doctrine of heredity. *Les Trois Filles de M. Dupont* (1897) is a powerful, somewhat brutal, study of the miseries imposed on poor middle-class girls by the French

system of dowry; *Le Résultat des courses* (1898) shows the evil results of betting among the Parisian workmen; *La Robe rouge* (1900) was directed against the injustices of the law; *Les Remplaçantes* (1901) against the practice of putting children out to nurse. *Les Avariés* (1901), forbidden by the censor, on account of its medical details, was read privately by the author at the Théâtre Antoine; and *Petite amie* (1902) describes the life of a Parisian shop-girl. Later plays are *La Cousine* (1903, acted privately at Rouen in 1893), *Maternité* (1904), *Le Déserteur* (1904), in collaboration with M. Jean Sigaux, and *Les Hannelons*, a comedy in three acts (1906).

BRIGADE (Fr. and Ger. *brigade*, Ital. *brigata*, Span. *brigada*, the English use of the word dates from the early 17th century), a unit in military organization commanded by a major-general, brigadier-general or colonel, and composed of two or more regiments of infantry, cavalry or artillery. The British infantry brigade consists as a rule of four battalions (or about 4000 bayonets) with supply, transport and medical units attached; the cavalry brigade of two or three regiments of cavalry. An artillery "brigade" (field, horse, and heavy) is in Great Britain a smaller unit, forming a lieutenant-colonel's command and consisting of two or three batteries. (See ARMY, ARTILLERY, INFANTRY, and CAVALRY.) The staff of an infantry or cavalry brigade usually consists of the brigadier commanding, his aide-de-camp, and the brigade-major, a staff officer whose duties are intermediate between those of an adjutant and those of a general staff officer.

BRIGANDAGE. The brigand is supposed to derive his name from the O. Fr. *brigans*, which is a form of the Ital. *brigante*, an irregular or partisan soldier. There can be no doubt as to the origin of the word "bandit," which has the same meaning. In Italy, which is not unjustly considered the home of the most accomplished European brigands, a *bandito* was a man declared outlaw by proclamation, or *bando*, called in Scotland "a decree of horning" because it was delivered by a blast of a horn at the town cross. The brigand, therefore, is the outlaw who conducts warfare after the manner of an irregular or partisan soldier by skirmishes and surprises, who makes the war support itself by plunder, by extorting blackmail, by capturing prisoners and holding them to ransom, who enforces his demands by violence, and kills the prisoners who cannot pay. In certain conditions the brigand has not been a mere malefactor. "It is you who are the thieves"—"*I Ladroni, siete voi*,"—was the defence of the Calabrian who was tried as a brigand by a French court-martial during the reign of Murat in Naples. Brigandage may be, and not infrequently has been, the last resource of a people subject to invasion. The Calabrians who fought for Ferdinand of Naples, and the Spanish irregular levies, which maintained the national resistance against the French from 1808 to 1814, were called brigands by their enemies. In the Balkan peninsula, under Turkish rule, the brigands (called *klephts* by the Greeks and *hayduks* or *haydutzi* by the Slavs) had some claim to believe themselves the representatives of their people against oppressors. The only approach to an attempt to maintain order was the permission given to part of the population to carry arms in order to repress the klephts. They were hence called "armatoli." As a matter of fact the *armatole* were rather the allies than the enemies of the klephts. The invader who reduces a nation to anarchy, and then suffers from the disorder he creates, always calls his opponents brigands. It is a natural consequence of such a war, but a very disastrous one, for the people who have to have recourse to these methods of defence, that the brigand acquires some measure of honourable prestige from his temporary association with patriotism and honest men. The patriot band attracts the brigand proper, who is not averse to continue his old courses under an honourable pretext. "*Viva Fernando y vamos robando*" (Long life to Ferdinand, and let us go robbing) has been said by not unfair critics to have been the maxim of many Spanish guerrilleros. Italy and Spain suffered for a long time from the disorder developed out of the popular resistance to the French. Numbers of the guerrilleros of both countries, who in normal conditions might have been honest, had acquired a preference

for living on the country, and for occasional booty, which they could not resign when the enemy had retired. Their countrymen had to work for a second deliverance from their late defenders. In the East the brigand has had a freer scope, and has even founded kingdoms. David's following in the cave of Adullam was such material as brigands are made of. "And every one that was in distress, and every one that was in debt, and every one that was discontented, gathered themselves unto him, and he became a captain over them: and there were with him about four hundred men." Nadir Shah of Persia began in just such a cave of Adullam, and lived to plunder Delhi with a host of Persians and Afghans.

The conditions which favour the development of brigandage may be easily summed up. They are first bad administration, and then, in a less degree, the possession of convenient hiding-places. A country of mountain and forest is favourable to the brigand. The highlands of Scotland supplied a safe refuge to the "gentlemen reavers," who carried off the cattle of the Sassenach landlords. The Apennines, the mountains of Calabria, the Sierras of Spain, were the homes of the Italian "banditos" and the Spanish "bandoleros" (banished men) and "salteadores" (raiders). The forests of England gave cover to the outlaws, whose very much flattered portrait is to be found in the ballads of Robin Hood. The "maquis," i.e. the bush of Corsica, and its hills, have helped the Corsican brigand, as the bush of Australia covered the bushranger. But neither forest thicket nor mountain is a lasting protection against a good police, used with intelligence by the government, and supported by the law-abiding part of the community. The great haunts of brigands in Europe have been central and southern Italy and the worst-administered parts of Spain, except those which fell into the hands of the Turks. "Whenever numerous troops of banditti, multiplied by success and impunity, publicly defy, instead of eluding, the justice of their country, we may safely infer that the excessive weakness of the government is felt and abused by the lowest ranks of the community," is the judgment passed by Gibbon on the disorders of Sicily in the reign of the emperor Gallienus. This weakness has not always been a sign of real feebleness in the government. England was vigorously ruled in the reign of William III., when "a fraternity of plunderers, thirty in number according to the lowest estimate, squatted near Waltham Cross under the shades of Epping Forest, and built themselves huts, from which they sallied forth with sword and pistol to bid passengers stand." It was not because the state was weak that the Gubbings (so called in contempt from the trimmings and refuse of fish) infested Devonshire for a generation from their headquarters near Brent Tor, on the edge of Dartmoor. It was because England had not provided herself with a competent rural police. In relatively unsettled parts of the United States there has been a considerable amount of a certain kind of brigandage. In early days the travel routes to the far West were infested by highwaymen, who, however, seldom united into bands, and such outlaws, when captured, were often dealt with in an extra-legal manner, e.g. by "vigilance committees." The Mexican brigand Cortina made incursions into Texas before the Civil War. In Canada the mounted police have kept brigandage down, and in Mexico the "Ruales" have made an end of the brigands. Such curable evils as the highwaymen of England, and their like in the States, are not to be compared with the "Écorcheurs," or Skinners, of France in the 15th century, or the "Chaufeurs" of the revolutionary epoch. The first were large bands of discharged mercenary soldiers who pillaged the country. The second were ruffians who forced their victims to pay ransom by holding their feet in fires. Both flourished because the government was for the time disorganized by foreign invasion or by revolution. These were far more terrible evils than the licence of criminals, who are encouraged by a fair prospect of impunity because there is no permanent force always at hand to check them, and to bring them promptly to justice. At the same time it would be going much too far to say that the absence of an efficient police is the sole cause of brigandage in countries not subject to foreign invasion, or where

the state is not very feeble. The Sicilian peasants of whom Gibbon wrote were not only encouraged by the hope of impunity, but were also maddened by an oppressive system of taxation and a cruel system of land tenure. So were the Gauls and Spaniards who throughout the 3rd and 4th centuries were a constant cause of trouble to the empire, under the name of Bagaudæ, a word of uncertain origin. In the years preceding the French Revolution, the royal government commanded the services of a strong army, and a numerous *maréchaussée* or gendarmerie. Yet it was defied by the troops of smugglers and brigands known as *faux sauniers*, unauthorized salt-sellers, and gangs of poachers haunted the king's preserves round Paris. The salt monopoly and the excessive preservation of the game were so oppressive that the peasantry were provoked to violent resistance and to brigandage. They were constantly suppressed, but as the cause of the disorder survived, so its effects were continually renewed. The offenders enjoyed a large measure of public sympathy, and were warned or concealed by the population, even when they were not actively supported. The traditional outlaw who spared the poor and levied tribute on the rich was, no doubt, always a creature of fiction. The ballad which tells us how "Rich, wealthy misers were abhorred, By brave, free-hearted Bliss" (a rascal hanged for highway robbery at Salisbury in 1695) must have been a mere echo of the Robin Hood songs. But there have been times and countries in which the law and its administration have been so far regarded as enemies by people who were not themselves criminals, that all who defied them have been sure of a measure of sympathy. Then and there it was that brigandage has flourished, and has been difficult to extirpate. Schinder-Hannes, Jack the Skimmer, whose real name was Johann Buckler, and who was born at Muklen on the Rhine, flourished from 1797 to 1802 because there was no proper police to stop him; it is also true that as he chiefly plundered the Jews he had a good deal of Christian sympathy. When caught and beheaded he had no successors.

The brigandage of Greece, southern Italy, Corsica and Spain had deeper roots, and has never been quite suppressed. All four countries are well provided with hiding-places in forest and mountain. In all the administration has been bad, the law and its officers have been regarded as dangers, if not as deliberate enemies, so that they have found little native help, and, what is not the least important cause of the persistence of brigandage, there have generally been local potentates who found it to their interest to protect the brigand. The case of Greece under Turkish rule need not be dealt with. Whoever was not a klepht was the victim of some official extortioner. It would be grossly unfair to apply the name brigand to the Mainotes and similar clans, who had to choose between being flayed by the Turks or living by the sword under their own law. When it became independent Greece was extremely ill administered under a nominal parliamentary government by politicians who made use of the brigands for their own purposes. The result was the state of things described with only pardonable exaggeration in Edmond About's amusing *Roi de la montagne*. An authentic and most interesting picture of the Greek brigands will be found in the story of the captivity of S. Soteropoulos, an ex-minister who fell into their hands. It was translated into English under the title of *The Brigands of the Morea*, by the Rev. J. O. Bagdon (London, 1868). The misfortunes of Soteropoulos led to the adoption of strong measures which cleared the Morea, where the peasantry gave active support to the troops when they saw that the government was in earnest. But brigandage was not yet extinct in Greece. In 1870 an English party, consisting of Lord and Lady Muncaster, Mr Vyner, Mr Lloyd, Mr Herbert, and Count de Boyl, was captured at Oropos, near Marathon, and a ransom of £25,000 was demanded. Lord and Lady Muncaster were set at liberty to seek for the ransom, but the Greek government sent troops in pursuit of the brigands, and the other prisoners were then murdered. The scoundrels were hunted down, caught, and executed, and Greece has since then been tolerably free from this reproach. In the Balkan peninsula, under Turkish rule, brigandage continued to exist in connexion

with Christian revolt against the Turk, and the race conflicts of Albanians, Walachians, Pomuks, Bulgarians and Greeks. In Corsica the "maquis" has never been without its brigand hero, because industry has been stagnant, family feuds persist, and the government has never quite succeeded in persuading the people to support the law. The brigand is always a hero to at least one faction of Corsicans.

The conditions which favour brigandage have been more prevalent, and for longer, in Italy than elsewhere in western Europe, with the standing exception of Corsica, which is Italian in all but political allegiance. Until the middle of the 19th century Italy was divided into small states, so that the brigand who was closely pursued in one could flee to another. Thus it was that Marco Sciarra of the Abruzzi, when hard pressed by the Spanish viceroy of Naples—just before and after 1600—could cross the border of the papal states and return on a favourable opportunity. When pope and viceroy combined against him he took service with Venice, from whence he could communicate with his friends at home, and pay them occasional visits. On one such visit he was led into a trap and slain. Marco Sciarra had terrorized the country far and wide at the head of 600 men. He was the follower and imitator of Benedetto Mangone, of whom it is recorded that, having stopped a party of travellers which included Torquato Tasso, he allowed them to pass unharmed out of his reverence for poets and poetry. Mangone was finally taken, and beaten to death with hammers at Naples. He and his like are the heroes of much popular verse, written in *ottava rima*, and beginning with the traditional epic invocation to the muse. A fine example is "The most beautiful history of the life and death of Pietro Mancino, chief of Banditti," which has remained popular with the people of southern Italy. It begins:—

"Io canto li ricatti, e il fiero ardire
Del gran Pietro Mancino fuoruscito"
(Pietro Mancino that great outlawed man
I sing, and all his rage.)

In Naples the number of competing codes and jurisdictions, the survival of the feudal power of the nobles, who sheltered *br-ditti*, just as a Highland chief gave refuge to "caterans" in Scotland, and the helplessness of the peasantry, made brigandage chronic, and the same conditions obtained in Sicily. The Bourbon dynasty reduced brigandage very much, and secured order on the main high-roads. But it was not extinguished, and it revived during the French invasion. This was the flourishing time of the notorious Fra Diavolo, who began as brigand and blossomed into a patriot. Fra Diavolo was captured and executed by the French. When Ferdinand was restored on the fall of Napoleon he employed an English officer, General Sir Richard Church, to suppress the brigands. General Church, who kept good order among his soldiers, and who made them pay for everything, gained the confidence of the peasantry, and restored a fair measure of security. It was he who finally brought to justice the villainous Don Ciro Anicchiario—priest and brigand—who declared at his trial with offhand indifference that he supposed he had murdered about seventy people first and last. When a brother priest was sent to give him the consolations of religion, Ciro cut him short, saying, "Stop that chatter, we are two of a trade: we need not play the fool to one another" (*Lasciate queste chiacchiere, siamo dell' istessa professione: non ci burliamo fra noi*). Every successive revolutionary disturbance in Naples saw a recrudescence of brigandage down to the unification of 1860-1861, and then it was years before the Italian government rooted it out. The source of the trouble was the support the brigands received from various kinds of "*manutengoli*" (maintainers)—great men, corrupt officials, political parties, and the peasants who were terrorized, or who profited by selling the brigands food and clothes. In Sicily brigandage has been endemic. In 1866 two English travellers, Mr E. J. C. Moens and the Rev. J. C. Murray Aynsley, were captured and held to ransom. Mr Moens found that the "*manutengoli*" of the brigands among the peasants charged famine prices for food, and extortionate prices for clothes and cartridges. What is true of Naples and Sicily is true of other parts of Italy *mutatis*

mutatis. In Tuscany, Piedmont and Lombardy the open country has been orderly, but the borders infested with brigands. The worst district outside Calabria has been the papal states. The Austrian general, Frimont, did, however, partly clear the Romagna about 1820, though at a heavy cost of life to his soldiers—mostly Bohemian Jägers—from the malaria.

The history of brigandage in Spain is very similar. It may be said to have been endemic in and south of the Sierra Morena. In the north it has flourished when government was weak, and after foreign invasion and civil war. But it has always been put down easily by a capable administration. It reached its greatest heights in Catalonia, where it began in the strife of the peasants against the feudal exactions of the landlords. It had its traditional hero, Roque Guinart, who figures in the second part of Don Quixote. The revolt against the house of Austria in 1640, and the War of the Succession (1700-1714), gave a great stimulus to Catalan brigandage. But it was then put down in a way for which Italy offers no precedent. A country gentleman named Pedro Veciana, hereditary *balio* (military and civil lieutenant) of the archbishop of Tarragona in the town of Valls, armed his farm-servants, and resisted the attacks of the brigands. With the help of neighbouring country gentlemen he formed a strong band, known as the Mozos (Boys) of Veciana. The brigands combined to get rid of him by making an attack on the town of Valls, but were repulsed with great loss. The government of Philip V. then commissioned Veciana to raise a special corps of police, the "escuadra de Cataluna," which still exists. For five generations the colonel of the escuadra was always a Veciana. At all times in central and northern Spain the country population has supported the police when the government would act firmly. Since the organization of the excellent constabulary called "La Guardia Civil" by the duke of Ahumada, about 1844, brigandage has been well kept down. At the close of the Carlist War in 1874 a few bands infested Catalonia, but one of the worst was surprised, and all its members battered to death with boxwood cudgels by a gang of charcoal-burners on the ruins of the castle of San Martín de Centellas. In such conditions as these brigandage cannot last. More sympathy is felt for "bandoleros" in the south, and there also they find Spanish equivalents for the "*manutengoli*" of Italy. The tobacco smuggling from Gibraltar keeps alive a lawless class which sinks easily into pure brigandage. Perhaps the influence of the Berber blood in the population helps to prolong this barbarism. The Sierra Morena, and the Serrania de Ronda, have produced the bandits whose achievements form the subject of popular ballads, such as Francisco Esteban El Guapo (Francis Stephen, the Buck or Dandy), Don Juan de Serralonga, Pedranza, &c. The name of José Maria has been made familiar to all the world by Merimée's story, *Carmen*, and by Bizet's opera. José Maria, called El Tempranillo (the early bird), was a historical personage, a liberal in the rising against Ferdinand VII., 1820-1823, then a smuggler, then a "bandolero." He was finally bought off by the government, and took a commission to suppress the other brigands. José Maria was at last shot by one of them, whom he was endeavouring to arrest. The civil guard prevents brigandage from reaching any great height in normal times, but in 1905 a bandit of the old stamp, popularly known as "El Vivillo" (the Vital Spark), haunted the Serrania de Ronda.

The brigand life has been made the subject of much romance. But when stripped of fiction it appears that the bands have been mostly recruited by men who had been guilty of homicide, out of jealousy or in a gambling quarrel, and who remained in them not from love of the life, but from fear of the galleys. A reformed brigand, known as Passo di Lupo (Wolf's Step), confessed to Mr McFarlane about 1820 that the weaker members of the band were terrorized and robbed by the bullies, and that murderous conflicts were constant among them.

The "dacoits" or brigands of India were of the same stamp as their European colleagues. The Pindaris were more than brigands, and the Thugs were a religious sect.

AUTHORITIES.—The literature of brigandage, apart from pure romances, or official reports of trials, is naturally extensive. Mr

McFarlane's *Lives and Exploits of Banditti and Robbers* (London, 1837) is a useful introduction to the subject. The author saw a part of what he wrote about, and gives many references, particularly for Italy. A good bibliography of Spanish brigandage will be found in the *Reseña Histórica de la Guardia Civil* of Eugenio de la Iglesia (Madrid, 1898). For actual pictures of the life, nothing is better than the *English Travellers and Italian Brigands* of W. J. C. Moens (London, 1886), and *The Brigands of the Morav*, by S. Sotopoulou, translated by the Rev. J. O. Bagdon (London, 1868). (D. H.)

BRIGANDINE, a French word meaning the armour for the brigands or brigantes, light-armed foot soldiers; part of the armour of a foot soldier in the middle ages, consisting of a padded tunic of canvas, leather, &c., and lined with closely sewn scales or rings of iron.

BRIGANTES (Celtic for "mountaineers" or "free, privileged"), a people of northern Britain, who inhabited the country from the mouth of the Abus (Humber) on the east and the Belisama (Mersey; according to others, Ribble) on the west as far northwards as the Wall of Antoninus. Their territory thus included most of Yorkshire, the whole of Lancashire, Durham, Westmorland, Cumberland and part of Northumberland. Their chief town was Eburacum (or Eboracum; York). They first came into contact with the Romans during the reign of Claudius, when they were defeated by Publius Ostorius Scapula. Under Vespasian they submitted to Petillius Cerealis, but were not finally subdued till the time of Antoninus Pius (*Tac. Agricola*, 17; Pausan. viii. 43. 4). The name of their eponymous goddess Brigantia is found on inscriptions (*Corp. Inscr. Lat.* vii. 200, 875, 1062; F. Haverfield in *Archæological Journal*, xlix., 1892), and also that of a god Bergans=Brigans (*Ephemeris Epigraphica*, vii. No. 920). A branch of the Brigantes also settled in the south-east corner of Ireland, near the river Birgus (Barrow).

See A. Holder, *Altösterreich Sprachschatz*, I. (1896), for ancient authorities; J. Rhyu, *Celtic Britain* (3rd ed., 1904); Pauly-Wissowa, *Realencyclopædie*, iii. pt. I. (1897).

BRIGG (properly GLANFORD BRIGGS or GLAMFORD BRIDGE), a market town in the North Lindsey or Brigg parliamentary division of Lincolnshire, England, situated on the river Ancholme, which affords water communication with the Humber. Pop. of urban district (1901) 3137. It is 23 m. by road north of Lincoln, and is served by the Grimsby line of the Great Central railway. Trade is principally agricultural. In 1885 a remarkable boat, assigned to early British workmanship, was unearthed near the river; it is hollowed out of the trunk of an oak, and measures 48 ft. 6 in. by about 5 ft. Other prehistoric relics have also been discovered.

BRIGGS, CHARLES AUGUSTUS (1841-), American Hebrew scholar and theologian, was born in New York City on the 15th of January 1841. He was educated at the university of Virginia (1857-1860), graduated at the Union Theological Seminary in 1863, and studied further at the university of Berlin. He was pastor of the Presbyterian church of Roselle, New Jersey, 1869-1874, and professor of Hebrew and cognate languages in Union Theological Seminary 1874-1891, and of Biblical theology there from 1891 to 1904, when he became professor of theological encyclopædia and symbolics. From 1880 to 1890 he was an editor of the *Presbyterian Review*. In 1892 he was tried for heresy by the presbytery of New York and acquitted. The charges were based upon his inaugural address of the preceding year. In brief they were as follows: that he had taught that reason and the Church are each a "fountain of divine authority which apart from Holy Scripture may and does savingly enlighten men"; that "errors may have existed in the original text of the Holy Scripture"; that "many of the Old Testament predictions have been reversed by history"; and that "the great body of Messianic prediction has not and cannot be fulfilled"; that "Moses is not the author of the Pentateuch," and that "Isaiah is not the author of half of the book which bears his name"; that "the processes of redemption extend to the world to come"—he had considered it a fault of Protestant theology that it limits redemption to this world—and that "sanctification is not complete at death." The general assembly, to which the case was appealed, suspended Dr Briggs

in 1893, being influenced, it would seem, in part, by the manner and tone of his expressions—by what his own colleagues in the Union Theological Seminary called the "dogmatic and irritating" nature of his inaugural address. He was ordained a priest of the Protestant Episcopal Church in 1899. His scholarship procured for him the honorary degree of D.D. from Edinburgh (1884) and from Glasgow (1901), and that of Litt. D. from Oxford (1901). With S. R. Driver and Francis Brown he prepared a revised *Hebrew and English Lexicon* (1891-1905), and with Driver edited the "International Commentary Series." His publications include *Biblical Study: Its Principles, Methods and History* (1883); *Hebrew Poems of the Creation* (1884); *American Presbyterianism: Its Origin and Early History* (1885); *Messianic Prophecy* (1886); *Whither? A Theological Question for the Times* (1889); *The Authority of the Holy Scriptures* (1891); *The Bible, the Church and the Reason* (1892); *The Higher Criticism of the Hexateuch* (1893); *The Messiah of the Gospels* (1894); *The Messiah of the Apostles* (1894); *New Light on the Life of Jesus* (1904); *The Ethical Teaching of Jesus* (1904); *A Critical and Exegetical Commentary on the Book of Psalms* (2 vols., 1906-1907), in which he was assisted by his daughter; and *The Virgin Birth of Our Lord* (1909).

BRIGGS, HENRY (1556-1630), English mathematician, was born at Warley Wood, near Halifax, in Yorkshire. He graduated at St John's College, Cambridge, in 1581, and obtained a fellowship in 1588. In 1592 he was made reader of the physical lecture founded by Dr Thomas Linacre, and in 1596 first professor of geometry in Gresham House (afterwards College), London. In his lectures at Gresham House he proposed the alteration of the scale of logarithms from the hyperbolic form which John Napier had given them, to that in which unity is assumed as the logarithm of the ratio of ten to one; and soon afterwards he wrote to the inventor on the subject. In 1616 he paid a visit to Napier at Edinburgh in order to discuss the suggested change, and next year he repeated his visit for a similar purpose. During these conferences the alteration proposed by Briggs was agreed upon; and on his return from his second visit to Edinburgh in 1617 he accordingly published the first table of his logarithms (See NAPIER, JOHN). In 1619 he was appointed Savilian professor of geometry at Oxford, and resigned his professorship of Gresham College on the 25th of July 1620. Soon after his settlement at Oxford he was incorporated master of arts. In 1622 he published a small tract on the *North-West Passage to the South Seas, through the Continent of Virginia and Hudson's Bay*; and in 1624 his *Arithmetica Logarithmica*, in folio, a work containing the logarithms of thirty thousand natural numbers to fourteen places of figures besides the index. He also completed a table of logarithmic sines and tangents for the hundredth part of every degree to fourteen places of figures besides the index, with a table of natural sines to fifteen places, and the tangents and secants for the same to ten places; all of which were printed at Gouda in 1631; and published in 1633 under the title of *Trigonometria Britannica* (see TABLE, MATHEMATICAL). Briggs died on the 26th of January 1630, and was buried in Merton College chapel, Oxford. Dr Smith, in his *Lives of the Gresham Professors*, characterizes him as a man of great probity, a contemner of riches, and contented with his own station, preferring a studious retirement to all the splendid circumstances of life.

His works are: *A Table to find the Height of the Pole, the Magnetic Declination being given* (London, 1602, 4to); *Tables for the Improvement of Navigation*, printed in the second edition of Edward Wright's treatise entitled *Certain Errors in Navigation detected and corrected* (London, 1610, 4to); *A Description of an Instrumental Table to find the part proportional, devised by Mr Edward Wright* (London, 1616 and 1618, 12mo); *Logarithmorum Tabula prima* (London, 1617, 8vo); *Lucubrations et Annotations in opera posthuma J. Neperi* (Edinburgh, 1619, 4to); *Enclitidis Elementorum VI. libri priores* (London, 1620, folio); *A Treatise on the North-West Passage to the South Sea* (London, 1622, 4to), reprinted in Purchas's *Pilgrims*, vol. iii. p. 852; *Arithmetica Logarithmica* (London, 1624, folio); *Trigonometria Britannica* (Gouda, 1633, folio); two *Lett.* to Archbishop Usker; *Mathematica et Astronomica minus operis*. Some other works, as his *Commentaries on the Geometry of Peter Ramus*, and *Remarks on the Treatise of Longomontanus respecting the Quadrature of the Circle*, have not been published.

BRIGHOUSE, a municipal borough in the Elland parliamentary division of the West Riding of Yorkshire, England, 5½ m. N. of Huddersfield by the Lancashire & Yorkshire railway, on the river Calder. Pop. (1901) 21,735. It is in the heart of the manufacturing district of the West Riding, and has large woollen and worsted factories; carpets, machinery and soap are also produced. The town was incorporated in 1803, and is governed by a mayor, 8 aldermen and 24 councillors. Area, 2231 acres.

BRIGHT, SIR CHARLES TILSTON (1832-1888), English telegraph engineer, who came of an old Yorkshire family, was born on the 8th of June 1832, at Wanstead, Essex. At the age of fifteen he became a clerk under the Electric Telegraph Company. His talent for electrical engineering was soon shown, and his progress was rapid; so that in 1852 he was appointed engineer to the Magnetic Telegraph Company, and in that capacity superintended the laying of lines in various parts of the British Isles, including in 1853 the first cable between Great Britain and Ireland, from Portpatrick to Donaghadee. His experiments convinced him of the practicability of an electric submarine cable connexion between Ireland and America; and having in 1855 already discussed the question with Cyrus Field, who with J. W. Brett controlled the Newfoundland Telegraph Company on the other side of the ocean, Bright organized with them the Atlantic Telegraph Company in 1856 for the purpose of carrying out the idea, himself becoming engineer-in-chief. The story of the first Atlantic cable is told elsewhere (see TELEGRAPHS), and it must suffice here to say that in 1858, after two disappointments, Bright successfully accomplished what to many had seemed an impossible feat, and within a few days of landing the Irish end of the line at Valentia he was knighted in Dublin. Subsequently Sir Charles Bright supervised the laying of submarine cables in various regions of the world, and took a leading part as pioneer in other developments of the electrical industry. In conjunction with Josiah Latimer Clark, with whom he entered into partnership in 1861, he invented improved methods of insulating submarine cables, and a paper on electrical standards read by them before the British Association in the same year led to the establishment of the British Association committee on that subject, whose work formed the foundations of the system still in use. From 1865 to 1868 he was Liberal M.P. for Greenwich. He died on the 3rd of May 1888, at Abbey Wood, near London.

See *Life Story of Sir C. T. Bright*, by his son Charles Bright (revised ed. 1908).

BRIGHT, JOHN (1811-1889), British statesman, was born at Rochdale on the 16th of November 1811. His father, Jacob Bright, was a much-respected Quaker, who had started a cotton-mill at Rochdale in 1809. The family had reached Lancashire by two migrations. Abraham Bright was a Wiltshire yeoman, who, early in the 18th century, removed to Coventry, where his descendants remained, and where, in 1775, Jacob Bright was born. Jacob Bright was educated at the Ackworth school of the Society of Friends, and was apprenticed to a fustian manufacturer at New Mills. He married his employer's daughter, and settled with his two brothers-in-law at Rochdale in 1802, going into business for himself seven years later. His first wife died without children, and in 1809 he married Martha Wood, daughter of a tradesman of Bolton-le-Moors. She had been educated at Ackworth school, and was a woman of great strength of character and refined taste. There were eleven children of this marriage, of whom John Bright was the second, but the death of his elder brother in childhood made him the eldest son. He was a delicate child, and was sent as a day-scholar to a boarding-school near his home, kept by Mr William Littlewood. A year at the Ackworth school, two years at a school at York, and a year and a half at Newton, near Clitheroe, completed his education. He learned, he himself said, but little Latin and Greek, but acquired a great love of English literature, which his mother fostered, and a love of outdoor pursuits. In his sixteenth year he entered his father's mill, and in due time became a partner in the business. Two agitations were then going on in Rochdale—the first (in which Jacob Bright was a leader) in opposition to a local church-

rate, and the second for parliamentary reform, by which Rochdale successfully claimed to have a member allotted to it under the Reform Bill. In both these movements John Bright took part. He was an ardent Nonconformist, proud to number among his ancestors John Gratton, a friend of George Fox, and one of the persecuted and imprisoned preachers of the Society of Friends. His political interest was probably first kindled by the Preston election in 1830, in which Lord Stanley, after a long struggle, was defeated by "Orator" Hunt. But it was as a member of the Rochdale Juvenile Temperance Band that he first learned public speaking. These young men went out into the villages, borrowed a chair of a cottager, and spoke from it at open-air meetings. In Mrs John Mills's life of her husband is an account of John Bright's first extempore speech. It was at a temperance meeting. Bright got his notes muddled, and broke down. The chairman gave out a temperance song, and during the singing told Bright to put his notes aside and say what came into his mind. Bright obeyed, began with much hesitancy, but found his tongue and made an excellent address. On some early occasions, however, he committed his speech to memory. In 1832 he called on the Rev. John Aldis, an eminent Baptist minister, to accompany him to a local Bible meeting. Mr Aldis described him as a slender, modest young gentleman, who surprised him by his intelligence and thoughtfulness, but who seemed nervous as they walked to the meeting together. At the meeting he made a stimulating speech, and on the way home asked for advice. Mr Aldis counselled him not to learn his speeches, but to write out and commit to memory certain passages and the peroration. Bright took the advice, and acted on it all his life.

This "first lesson in public speaking," as Bright called it, was given in his twenty-first year, but he had not then contemplated entering on a public career. He was a fairly prosperous man of business, very happy in his home, and always ready to take part in the social, educational and political life of his native town. He was one of the founders of the Rochdale Literary and Philosophical Society, took a leading part in its debates, and on returning from a holiday journey in the East, gave the society a lecture on his travels. He first met Richard Cobden in 1836 or 1837. Cobden was an alderman of the newly formed Manchester corporation, and Bright went to ask him to speak at an education meeting in Rochdale. "I found him," said Bright, "in his office in Mosley Street, introduced myself to him, and told him what I wanted." Cobden consented, and at the meeting was much struck by Bright's short speech, and urged him to speak against the Corn Laws. His first speech on the Corn Laws was made at Rochdale in 1838, and in the same year he joined the Manchester provisional committee which in 1839 founded the Anti-Corn Law League. He was still only the local public man, taking part in all public movements, especially in opposition to John Feilden's proposed factory legislation, and to the Rochdale church-rate. In 1839 he built the house which he called "One Ash," and married Elizabeth, daughter of Jonathan Priestman of Newcastle-on-Tyne. In November of the same year there was a dinner at Bolton to Abraham Paulton, who had just returned from a successful Anti-Corn Law tour in Scotland. Among the speakers were Cobden and Bright, and the dinner is memorable as the first occasion on which the two future leaders appeared together on a Free Trade platform. Bright is described by the historian of the League as "a young man then appearing for the first time in any meeting out of his own town, and giving evidence, by his energy and by his grasp of the subject, of his capacity soon to take a leading part in the great agitation." But his call had not yet come. In 1840 he led a movement against the Rochdale church-rate, speaking from a tombstone in the churchyard, where it looks down on the town in the valley below. A very happy married life at home contented him, and at the opening of the Free Trade hall in January 1840 he sat with the Rochdale deputation, undistinguished in the body of the meeting. A daughter, Helen, was born to him; but his young wife, after a long illness, died of consumption in September 1841. Three days after her death at Leamington, Cobden called to see him. "I was in the depths of grief," said Bright, when unweaving

the statue of his friend at Bradford in 1877, "I might almost say of despair, for the life and sunshine of my house had been extinguished." Cobden spoke some words of condolence, but "after a time he looked up and said, 'There are thousands of homes in England at this moment where wives, mothers and children are dying of hunger. Now, when the first paroxysm of your grief is past, I would advise you to come with me, and we will never rest till the Corn Laws are repealed.' I accepted his invitation," added Bright, "and from that time we never ceased to labour hard on behalf of the resolution which we had made." At the general election in 1841 Cobden was returned for Stockport, and in 1843 Bright was the Free Trade candidate at a by-election at Durham. He was defeated, but his successful competitor was unscathed on petition, and at the second contest Bright was returned. He was already known in the country as Cobden's chief ally, and was received in the House of Commons with a suspicion and hostility even greater than had met Cobden himself. In the Anti-Corn Law movement the two speakers were the complements and correlatives of each other. Cobden had the calmness and confidence of the political philosopher, Bright had the passion and the fervour of the popular orator. Cobden did the reasoning, Bright supplied the declamation, but like Demosthenes he mingled argument with appeal. No orator of modern times rose more rapidly to a foremost place. He was not known beyond his own borough when Cobden called him to his side in 1841, and he entered parliament towards the end of the session of 1843 with a formidable reputation as an agitator. He had been all over England and Scotland addressing vast meetings and, as a rule, carrying them with him; he had taken a leading part in a conference held by the Anti-Corn Law League in London, had led deputations to the duke of Sussex, to Sir James Graham, then home secretary, and to Lord Ripon and Mr Gladstone, the secretary and under secretary of the Board of Trade; and he was universally recognized as the chief orator of the Free Trade movement. Wherever "John Bright of Rochdale" was announced to speak, vast crowds assembled. He had been so announced, for the last time, at the first great meeting in Drury Lane theatre on 15th March 1843; henceforth his name was enough. He took his seat in the House of Commons as one of the members for Durham on 28th July 1843, and on 7th August delivered his maiden speech in support of a motion by Mr Ewart for reduction of import duties. He was there, he said, "not only as one of the representatives of the city of Durham, but also as one of the representatives of that benevolent organization, the Anti-Corn Law League." A member who heard the speech described Bright as "about the middle size, rather firmly and squarely built, with a fair, clear complexion, and an intelligent and pleasing expression of countenance. His voice is good, his enunciation distinct, and his delivery free from any unpleasant peculiarity or mannerism." He wore the usual Friend's coat, and was regarded with much interest and hostile curiosity on both sides of the House.

Mr Ewart's motion was defeated, but the movement of which Cobden and Bright were the leaders continued to spread. In the autumn the League resolved to raise £100,000; an appeal was made to the agricultural interest by great meetings in the farming counties, and in November *The Times* startled the world by declaring, in a leading article, "The League is a great fact. It would be foolish, nay, rash, to deny its importance." In London great meetings were held in Covent Garden theatre, at which William Johnson Fox was the chief orator, but Bright and Cobden were the leaders of the movement. Bright publicly deprecated the popular tendency to regard Cobden and himself as the chief movers in the agitation, and Cobden told a Rochdale audience that he always stipulated that he should speak first, and Bright should follow. His "more stately genius," as Mr John Morley calls it, was already making him the undisputed master of the feelings of his audiences. In the House of Commons his progress was slower. Cobden's argumentative speeches were regarded more sympathetically than Bright's more rhetorical appeals, and in a debate on Villiers's annual motion against the Corn Laws Bright was heard with so much impatience that

he was obliged to sit down. In the next session (1845) he moved for an inquiry into the operation of the Game Laws. At a meeting of county members earlier in the day Peel had advised them not to be led into discussion by a violent speech from the member for Durham, but to let the committee be granted without debate. Bright was not violent, and Cobden said that he did his work admirably, and won golden opinions from all men. The speech established his position in the House of Commons. In this session Bright and Cobden came into opposition, Cobden voting for the Maynooth Grant and Bright against it. On only one other occasion—a vote for South Kensington—did they go into opposite lobbies, during twenty-five years of parliamentary life. In the autumn of 1845 Bright retained Cobden in the public career to which Cobden had invited him four years before. Bright was in Scotland when a letter came from Cobden announcing his determination, forced on him by business difficulties, to retire from public work. Bright replied that if Cobden retired the mainspring of the League was gone. "I can in no degree take your place," he wrote. "As a second I can fight, but there are incapacities about me, of which I am fully conscious, which prevent my being more than second in such a work as we have laboured in." A few days later he set off for Manchester, posting in that wettest of autumns through "the rain that rained away the Corn Laws," and on his arrival got his friends together, and raised the money which tided Cobden over the emergency. The crisis of the struggle had come. Peel's budget in 1845 was a first step towards Free Trade. The bad harvest and the potato disease drove him to the repeal of the Corn Laws, and at a meeting in Manchester on 2nd July 1846 Cobden moved and Bright seconded a motion dissolving the league. A library of twelve hundred volumes was presented to Bright as a memorial of the struggle.

Bright married, in June 1847, Miss Margaret Elizabeth Leatham, of Wakefield, by whom he had seven children, Mr John Albert Bright being the eldest. In the succeeding July he was elected for Manchester, with Mr Milner Gibson, without a contest. In the new parliament, as in the previous session, he opposed legislation restricting the hours of labour, and, as a Nonconformist, spoke against clerical control of national education. In 1848 he voted for Hume's household suffrage motion, and introduced a bill for the repeal of the Game Laws. When Lord John Russell brought forward his Ecclesiastical Titles Bill, Bright opposed it as "a little, paltry, miserable measure," and foretold its failure. In this parliament he spoke much on Irish questions. In a speech in favour of the government bill for a rate in aid in 1849, he won loud cheers from both sides, and was complimented by Disraeli for having sustained the reputation of that assembly. From this time forward he had the ear of the House, and took effective part in the debates. He spoke against capital punishment, against church-rates, against flogging in the army, and against the Irish Established Church. He supported Cobden's motion for the reduction of public expenditure, and in and out of parliament pleaded for peace. In the election of 1852 he was again returned for Manchester on the principles of free trade, electoral reform and religious freedom. But war was in the air, and the most impassioned speeches he ever delivered were addressed to this parliament in fruitless opposition to the Crimean War. Neither the House nor the country would listen. "I went to the House on Monday," wrote Macaulay in March 1854, "and heard Bright say everything I thought." His most memorable speech, the greatest he ever made, was delivered on the 23rd of February 1855. "The angel of death has been abroad throughout the land. You may almost hear the beating of his wings," he said, and concluded with an appeal to the prime minister that moved the House as it had never been moved within living memory. There was a tremor in Bright's voice in the touching parts of his great speeches which stirred the feelings even of hostile listeners. It was noted for the first time in this February speech, but the most striking instance was in a speech on Mr Osborne Morgan's Burials Bill in April 1875, in which he described a Quaker funeral, and protested against the "miserable superstition of the phrase 'buried like a dog.'" "In that sense," he said,

"I shall be buried like a dog, and all those with whom I am best acquainted, whom I best love and esteem, will be 'buried like a dog.' Nay more, my own ancestors, who in past time suffered persecution for what is now held to be a righteous cause, have all been buried like dogs, if that phrase is true." The tender, half-broken tones in which these words were said, the inexpressible pathos of his voice and manner, were never forgotten by those who heard that Wednesday morning speech.

Bright was disqualified by illness during the whole of 1856 and 1857. In Palmerston's penal dissolution in the latter year, Bright was rejected by Manchester, but in August, while ill and absent, Birmingham elected him without a contest. He returned to parliament in 1858, and in February seconded the motion which threw out Lord Palmerston's government. Lord Derby thereupon came into office for the second time, and Bright had the satisfaction of assisting in the passing of two measures which he had long advocated—the admission of Jews to parliament and the transfer of the government of India from the East India Company to the crown. He was now restored to full political activity, and in October addressed his new constituents, and started a movement for parliamentary reform. He spoke at great gatherings at Edinburgh, Glasgow, Bradford and Manchester, and his speeches filled the papers. For the next nine years he was the protagonist of Reform. Towards the close of the struggle he told the House of Commons that a thousand meetings had been held, that at every one the doors were open for any man to enter, yet that an almost unanimous vote for reform had been taken. In the debates on the Reform Bills submitted to the House of Commons from 1859 to 1867, Bright's was the most influential voice. He rebuked Lowe's "Botany Bay view," and described Horsman as retiring to his "cave of Adullam," and hooking in Lowe. "The party of two," he said, "reminds me of the Scotch terrier, which was so covered with hair that you could not tell which was the head and which was the tail." These and similar phrases, such as the excuse for withdrawing the Reform Bill in the year of the great budget of 1860—"you cannot get twenty wagons at once through Temple Bar"—were in all men's mouths. It was one of the triumphs of Bright's oratory that it constantly produced these popular cries. The phrase "a free breakfast table" was his; and on the rejection of Forster's Compensation for Disturbance Bill he used the phrase as to Irish discontent, "Force is not a remedy."

During his great reform agitation Bright had vigorously supported Cobden in the negotiations for the treaty of commerce with France, and had taken, with his usual vehemence, the side of the North in the discussions in England on the American Civil War. In March 1865 Cobden died, and Bright told the House of Commons he dared not even attempt to express the feelings which oppressed him, and sat down overwhelmed with grief. Their friendship was one of the most characteristic features of the public life of their time. "After twenty years of intimate and almost brotherly friendship with him," said Bright, "I little knew how much I loved him till I had lost him." In June 1865 parliament was dissolved, and Bright was returned for Birmingham without opposition. Palmerston's death in the early autumn brought Lord John Russell into power, and for the first time Bright gave his support to the government. Russell's fourth Reform Bill was introduced, was defeated by the Adullamites, and the Derby-Disraeli ministry was installed. Bright declared Lord Derby's accession to be a declaration of war against the working classes, and roused the great towns in the demand for reform. Bright was the popular hero of the time. As a political leader the winter of 1866-1867 was the culminating point in his career. The Reform Bill was carried with a clause for minority representation, and in the autumn of 1868 Bright, with two Liberal colleagues, was again returned for Birmingham. Mr Gladstone came into power with a programme of Irish reform in church and land such as Bright had long urged, and he accepted the post of president of the Board of Trade. He thus became a member of the privy council, with the title of Right Honourable, and from this time forth was a recognized leader of the Liberal party in parliament and in the country. He made a great speech

on the second reading of the Irish Church Bill, and wrote a letter on the House of Lords, in which he said, "In harmony with the nation they may go on for a long time, but throwing themselves athwart its course they may meet with accidents not pleasant for them to think of." He also spoke strongly in the same session in favour of the bill permitting marriage with a deceased wife's sister. The next session found him disqualified by a severe illness, which caused his retirement from office at the end of the year, and kept him out of public life for four years. In August 1873 Mr Gladstone reconstructed his cabinet, and Bright returned to it as chancellor of the duchy of Lancaster. But his hair had become white, and though he spoke again with much of his former vigour, he was now an old man. In the election in January 1874 Bright and his colleagues were returned for Birmingham without opposition. When Mr Gladstone resigned the leadership of his party in 1875, Bright was chairman of the party meeting which chose Lord Hartington as his successor. He took a less prominent part in political discussion, till the Eastern Question brought Great Britain to the verge of war with Russia, and his old energy flamed up afresh. In the debate on the vote of credit in February 1878, he made one of his impressive speeches, urging the government not to increase the difficulties manufacturers had in finding employment for their workpeople by any single word or act which could shake confidence in business. The debate lasted five days. On the fifth day a telegram from Mr Layard was published announcing that the Russians were nearing Constantinople. The day, said *The Times*, "was crowded with rumours, alarms, contradictions, fears, hopes, resolves, uncertainties." In both Houses Mr Layard's despatch was read, and in the excited Commons Mr Forster's resolution opposing the vote of credit was withdrawn. Bright, however, distrusted the ambassador at the Porte, and gave reasons for doubting the alarming telegram. While he was speaking a note was put into the hands of Sir Stafford Northcote, and when Bright sat down he read it to the House. It was a confirmation from the Russian prime minister of Bright's doubts: "There is not a word of truth in the rumours which have reached you." At the general election in 1880 he was re-elected at Birmingham, and joined Mr Gladstone's new government as chancellor of the duchy of Lancaster. For two sessions he spoke and voted with his colleagues, but after the bombardment of the Alexandria forts he left the ministry and never held office again. He felt most painfully the severance from his old and trusted leader, but it was forced on him by his conviction of the danger and impolicy of foreign entanglements. He, however, gave a general support to Mr Gladstone's government. In 1883 he took the chair at a meeting of the Liberation Society in Mr Spurgeon's chapel; and in June of that year was the object of an unparalleled demonstration at Birmingham to celebrate his twenty-five years of service as its representative. At this celebration he spoke strongly of "the Irish rebel party," and accused the Conservatives of "alliance" with them, but withdrew the imputation when Sir Stafford Northcote moved that such language was a breach of the privileges of the House of Commons. At a banquet to Lord Spencer he accused the Irish members of having "exhibited a boundless sympathy for criminals and murderers." He refused in the House of Commons to apologize for these words, and was supported in his refusal by both sides of the House. At the Birmingham election in 1885 he stood for the central division of the redistributed constituency; he was opposed by Lord Randolph Churchill, but was elected by a large majority. In the new parliament he voted against the Home Rule Bill, and it was generally felt that in the election of 1886 which followed its defeat, when he was re-elected without opposition, his letters told with fatal effect against the Home Rule Liberals. His contribution to the discussion was a suggestion that the Irish members should form a grand committee to which every Irish bill should go after first reading. The break-up of the Liberal party filled him with gloom. His last speech at Birmingham was on 29th March 1888, at a banquet to celebrate Mr Chamberlain's return from his peace mission to the United States. He spoke of imperial federation as a "dream and an absurdity." In May his illness returned, he took to his bed in

October, and died on the 27th of March 1889. He was buried in the graveyard of the meeting-house of the Society of Friends in Rochdale.

Bright had much literary and social recognition in his later years. In 1882 he was elected lord rector of the university of Glasgow, and Dr Dale wrote of his rectorial address: "It was not the old Bright." "I am weary of public speaking," he had told Dr Dale; "my mind is almost a blank." He was given an honorary degree of the university of Oxford in 1886, and in 1888 a statue of him was erected at Birmingham. The 3rd marquis of Salisbury said of him, and it sums up his character as a public man: "He was the greatest master of English oratory that this generation—I may say several generations—has seen. . . . At a time when much speaking has depressed, has almost exterminated eloquence, he maintained that robust, powerful and vigorous style in which he gave fitting expression to the burning and noble thoughts he desired to utter."

See *The Life and Speeches of the Right Hon. John Bright, M.P.*, by George Barnett Smith, 2 vols. 8vo (1881); *The Life of John Bright, M.P.*, by John M'Gilchrist, in Cassell's Representative Biographies (1868); *John Bright*, by C. A. Vince (1898); *Speeches on Parliamentary Reform by John Bright, M.P.*, revised by Himself (1866); *Speeches on Questions of Public Policy*, by John Bright, M.P., edited by J. E. Thorold Rogers, 2 vols. 8vo (1868); *Public Addresses*, edited by J. E. Thorold Rogers, 8vo (1879); *Public Letters of the Right Hon. John Bright, M.P.*, collected by H. J. Leech (1885). (F. W. C.)

BRIGHTLINGSEA (pronounced BRITTLESEA), a port and fishing station in the Harwich parliamentary division of Essex, England, on a creek opening from the east shore of the Colne estuary, the terminus of a branch from Colchester of the Great Eastern railway, 62½ m. E.N.E. of London. Pop. of urban district (1901) 4501. The Colchester oyster beds are mainly in this part of the Colne, and the oyster fishery is the chief industry. Boat-building is carried on. This is also a favourite yachting centre. The church of All Saints, principally Perpendicular, has interesting monuments and brasses, and a fine lofty tower and west front. Brightlingsea, which appears in Domesday, is a member of the Cinque Port of Sandwich in Kent. Near the opposite shore of the creek is St Osyth's priory, which originated as a nunnery founded by Osyth, a grand-daughter of Penda, king of Mercia, martyred (c. 653) by Norse invaders. A foundation for Augustinian canons followed on the site early in the 12th century. The remains, incorporated with a modern residence, include a late Perpendicular gateway, abbots' tower, clock tower and crypt. The gateway, an embattled structure with flanking turrets, is particularly fine, the entire front being panelled and ornamented with canopied niches. The church of St Osyth, also Perpendicular in the main, is of interest.

BRIGHTON, a watering-place of Bourke county, Victoria, Australia, 7½ m. by rail S.E. of Melbourne, of which it is practically a suburb. It stands on the east shore of Port Phillip, and has two piers, a great extent of sandy beach and numerous beautiful villas. Pop. (1901) 10,029.

BRIGHTON, a municipal, county and parliamentary borough of Sussex, England, one of the best-known seaside resorts in the United Kingdom, 51 m. S. from London by the London, Brighton & South Coast railway. Pop. (1901) 123,478. Its ready accessibility from the metropolis is the chief factor in its popularity. It is situated on the seaward slope of the South Downs; the position is sheltered from inclement winds, and the climate is generally mild. The sea-front, overlooking the English Channel, stretches nearly 4 m. from Kemp Town on the east to Hove (a separate municipal borough) on the west. Inland, including the suburb of Preston, the town extends some 2 m. The tendency of the currents in the Channel opposite Brighton is to drive the shingle eastward, and encroachments of the sea were frequent and serious until the erection of a massive sea-wall, begun about 1830, 60 ft. high, 23 ft. thick at the base, and 3 ft. at the summit. There are numerous modern churches and chapels, many of them very handsome; and the former parish church of St Nicholas remains, a Decorated structure containing a Norman font and a memorial to the great duke of Wellington. The incumbency of Trinity Chapel was held by the famous

preacher Frederick William Robertson (1847-1853). The town hall and the parochial offices are the principal administrative buildings. Numerous institutions contribute to the entertainment of visitors. Of these the most remarkable is the Pavilion, built as a residence for the prince regent (afterwards George IV.) and remodelled in 1819 by the architect, John Nash, in a grotesque Eastern style of architecture. In 1849 it was purchased by the town for £53,000, and is devoted to various public uses, containing a museum, assembly-rooms and picture-gallery. The detached building, formerly the stables, is converted into a fine concert hall; it is lighted by a vast glazed dome approaching that of St Paul's cathedral, London, in dimensions. There are several theatres and music-halls. The aquarium, the property of the corporation, contains an excellent marine collection, but is also used as a concert hall and winter garden, and a garden is laid out on its roof. The Booth collection of British birds, bequeathed to the corporation by E. T. Booth, was opened in 1803. There are two piers, of which the Palace pier, near the site of the old chain pier (1823), which was washed away in 1866, is near the centre of the town, while the West pier is towards Hove. Preston and Queen's parks are the principal of several public recreation grounds; and the raccourse at Kemp Town is also the property of the town. Educational establishments are numerous, and include Brighton College, which ranks high among English public schools. There are municipal schools of science, technology and art. St Mary's Hall (1836) is devoted to the education of poor clergymen's daughters. Among many hospitals, the county hospital (1828), "open to the sick and lame poor of every country and nation," may be mentioned. There are an extensive mackerel and herring fishery, and motor engineering works. The parliamentary borough, which includes the parish of Hove, returns two members. The county borough was created in 1888. The municipal borough is under a mayor, 14 aldermen and 42 councillors. Area, 2536 acres.

Although there is evidence of Roman and Saxon occupation of the site, the earliest mention of Brighton (Bristelmestoc, Brichelmestone, Brighthelmon) is the Domesday Book record that its three manors belonged to Earl Godwin and were held by William de Warenne. Of these, two passed to the priories of Lewes and Michelham respectively, and after the dissolution of the monasteries were subject to frequent sale and division. The third descended to the earls of Arundel, falling to the share of the duke of Norfolk in 1415, and being divided in 1502 between the families of Howard and Berkeley. That Brighton was a large fishing village in 1086 is evident from the rent of 4000 herrings; in 1285 it had a separate constable, and in 1333 it was assessed for a tenth and fifteenth at £5:4:6½, half the assessment of Shoreham. In 1340 there were no merchants there, only tenants of lands, but its prosperity increased during the 15th and 16th centuries, and it was assessed at £6:12:8 in 1534. There is, however, no indication that it was a borough. In 1570 commissioners sent to decide disputes between the fishermen and landmen found that from time immemorial Brighton had been governed by two head boroughs sitting in the borough court, and assisted by a council called the Twelve. This constitution disappeared before 1772, when commissioners were appointed. Brighton refused a charter offered by George, prince of Wales, but was incorporated in 1854. It had become a parliamentary borough in 1832. From a fishing town in 1669 it became a fashionable resort in 1756; its popularity increased after the visit of the prince of Wales (see GEORGE IV.) to the duke of Cumberland in 1783, and was ensured by his building the Pavilion in 1784-1787, and his adoption of it as his principal residence; and his association with Mrs Fitzherbert at Brighton was the starting-point of its fashionable reputation.

See *Victoria County History—Sussex; Sussex Archaeological Society Transactions*, vol. ii.; L. Melville, *Brighton, its History, its Follies and its Fashions* (London, 1909).

BRIGHT'S DISEASE, a term in medicine applied to a class of diseases of the kidneys (acute and chronic nephritis) which have as their most prominent symptom the presence of albumen in the urine, and frequently also the coexistence of dropsy.

These associated symptoms in connexion with kidney disease were first described in 1827 by Dr Richard Bright (1789-1858). Since that period it has been established that the symptoms, instead of being, as was formerly supposed, the result of one form of disease of the kidneys, may be dependent on various morbid conditions of those organs (see KIDNEY DISEASES). Hence the term Bright's disease, which is retained in medical nomenclature in honour of Dr Bright, must be understood as having a generic application.

The symptoms are usually of a severe character. Pain in the back, vomiting and febrile disturbance commonly usher in the attack. Dropsy, varying in degree from slight puffiness of the face to an accumulation of fluid sufficient to distend the whole body, and to occasion serious embarrassment to respiration, is a very common accompaniment. The urine is reduced in quantity, is of dark, smoky or bloody colour, and exhibits to chemical reaction the presence of a large amount of albumen, while, under the microscope, blood corpuscles and casts, as above mentioned, are found in abundance.

This state of acute inflammation may by its severity destroy life, or, short of this, may by continuance result in the establishment of one of the chronic forms of Bright's disease. On the other hand an arrest of the inflammatory action frequently occurs, and this is marked by the increased amount of the urine, and the gradual disappearance of its albumen and other abnormal constituents; as also by the subsidence of the dropsy and the rapid recovery of strength.

In the treatment of acute Bright's disease, good results are often obtained from local depletion, from warm baths and from the careful employment of diuretics and purgatives. Chronic Bright's disease is much less amenable to treatment, but by efforts to maintain the strength and improve the quality of the blood by strong nourishment, and at the same time by guarding against the risks of complications, life may often be prolonged in comparative comfort, and even a certain measure of improvement be experienced.

BRIGNOLES, a town in the department of Var in the S.E. of France, 36 m. by rail N. of Toulon. Pop. (1906) 3639. It is built at a height of 754 ft. above the sea-level, in a fertile valley, and on the right bank of the Carami river. It contains the old summer palace of the counts of Provence, and has an active trade, especially in prunes, known as *prunes de Brignoles*. Its old name was *Villa Puerorum*, as the children of the counts of Provence were often brought up here. It was sacked on several occasions during the religious wars in the 16th century. Twelve miles to the N.W. is St Maximin (with a fine medieval church), which is one of the best starting-points for the most famous pilgrimage resort in Provence, the Sainte-Baume, wherein St Mary Magdalene is said to have taken refuge. This is 20 m. distant by road. (W. A. B. C.)

BRIHASPATI, or **BRAHMANASPATI** ("god of strength"), a deity of importance in early Hindu mythology. In the Rig-veda he is represented as the god of prayer, aiding Indra in his conquest of the cloud-demon, and at times appears to be identified with Agni, god of fire. He is the offspring of Heaven and Earth, the two worlds; is the inspirer of prayer and the guide and protector of the pious. He is pictured as having seven mouths, a hundred wings and horns and is armed with bow and arrows and an axe. He rides in a chariot drawn by red horses. In the later scriptures he is represented as a Rishi or seer.

See A. A. Macdonell, *Vedic Mythology* (Strassburg, 1897).

BRIL, PAUL (1554-1626), Flemish painter, was born at Antwerp. The success of his elder brother Matthew (1550-1584) in the Vatican induced him to go to Rome to live. On the death of Matthew, Paul, who far surpassed him as an artist, succeeded to his pensions and employments. He painted landscapes with a depth of chiaroscuro then little practised in Italy, and introduced into them figures well drawn and finely coloured. One of his best compositions is the "Martyrdom of St Clement," in the Sala Clementina of the Vatican.

BRILL, the name given to a flat-fish (*Psetta laevis*, or *Rhombus laevis*) which is a species closely related to the turbot, differing

from it in having very small scales, being smaller in size, having no bony tubercles in the skin, and being reddish in colour. It abounds on parts of the British coast, and is only less favoured for the table than the turbot itself.

BRILLAT-SAVARIN, ANTHELME (1755-1826), French gastronomist, was born at Belley, France, on the 1st of April 1755. In 1789 he was a deputy, in 1793 mayor of Belley. To escape proscription he fled from France to Switzerland, and went thence to the United States, where he played in the orchestra of a New York theatre. On the fall of Robespierre he returned to France, and in 1797 became a member of the court of cassation. He wrote various volumes on political economy and law, but his name is famous for his *Physiologie du goût*, a compendium of the art of dining. Many editions of this work have been published. Brillat-Savarin died in Paris on the 2nd of February 1826.

BRIMSTONE, the popular name of sulphur (*S.*), particularly of the commercial "roll sulphur." The word means literally "burning stone"; the first part being formed from the stem of the Mid. Eng. *brennen*, to burn. Earlier forms of the word are *bronestone*, *bernstone*, *brynstone*, &c.

BRIN, BENEDETTO (1833-1898), Italian naval administrator, was born at Turin on the 17th of May 1833, and until the age of forty worked with distinction as a naval engineer. In 1873 Admiral Saint-Bon, minister of marine, appointed him under-secretary of state. The two men completed each other; Saint-Bon conceived a type of ship, Brin made the plans and directed its construction. On the advent of the Left to power in 1876, Brin was appointed minister of marine by Depretis, a capacity in which he continued the programme of Saint-Bon, while enlarging and completing it in such way as to form the first organic scheme for the development of the Italian fleet. The huge warships "Italia" and "Dandolo" were his work, though he afterwards abandoned their type in favour of smaller and faster vessels of the "Varese" and the "Garibaldi" class. By his initiative Italian naval industry, almost non-existent in 1873, made rapid progress. During his eleven years' ministry (1876-1878 with Depretis, 1884-1891 with Depretis and Crispi, 1896-1898 with Rudini), he succeeded in creating large private shipyards, engine works and metallurgical works for the production of armour, steel plates and guns. In 1892 he entered the Giolitti cabinet as minister for foreign affairs, accompanying, in that capacity, the king and queen of Italy to Potsdam, but showed weakness towards France on the occasion of the massacre of Italian workmen at Aigues-Mortes. He died on the 24th of May 1898, while minister of marine in the Rudini cabinet. He, more than any other man, must be regarded as the practical creator of the Italian navy.

BRINDABAN, a town of British India, in the Muttra district of the United Provinces, on the right bank of the Jumna, 6 m. N. of Muttra. Pop. (1901) 22,717. Brindaban is one of the most popular places of pilgrimage in India, being associated with the cult of Krishna as a shepherd. It contains bathing-stairs, tanks and wells, and a great number of handsome temples, of which the finest is that of Govind Deva, a cruciform vaulted building of red sandstone, dating from 1590. The town was founded earlier in the same century.

BRINDISI (anc. *Brundisium*, *g.v.*), a seaport town and archiepiscopal see of Apulia, Italy, in the province of Lecce, 24 m. N.W. by rail from the town of Lecce, and 346 m. from Ancona. Pop. (1861) 8000; (1871) 13,755; (1901) 25,317. The chief importance of Brindisi is due to its position as a starting-point for the East. The inner harbour, admirably sheltered and 27 to 30 ft. in depth, allows ocean steamers to lie at the quays. Brindisi has, however, been abandoned by the large steamers of the Peninsular & Oriental Steam Navigation Company, which had called there since 1870, but since 1898 call at Marseilles instead; small express boats, carrying the mails, still leave every week, connecting with the larger steamers at Port Said; but the number of passengers leaving the port, which for the years 1893-1897 averaged 14,728, was only 7608 in 1905, and only 943 of these were carried by the P. & O. boats. The harbour railway station was not completed until 1905 (*Consular*

Report, No. 3672, 1906, pp. 13 sqq.). The port was cleared in 1905 by 1492 vessels of 1,486,269 tons. The imports represented a value of £629,892 and the exports a value of £663,201—an increase of £84,077 and £57,807 respectively on the figures of the previous year, while in 1899 the amounts, which were below the average, were only £298,400 and £253,000. The main imports are coal, flour, sulphur, timber and metals; and the main exports, wine and spirits, oil and dried fruits.

Frederick II. erected a castle, with huge round towers, to guard the inner harbour; it is now a convict prison. The cathedral, ruined by earthquakes, was restored in 1743-1749, but has some remains of its mosaic pavement (1178). The baptismal church of S. Giovanni al Sepolcro (11th century) is now a museum. The town was captured in 836 by the Saracens, and destroyed by them; but was rebuilt in the 11th century by Lupus the protospatharius, Byzantine governor. In 1071 it fell into the hands of the Normans, and frequently appears in the history of the Crusades. Early in the 14th century the inner port was blocked by Giovanni Orsini, prince of Taranto; the town was devastated by pestilence in 1348, and was plundered in 1352 and 1383; but even greater damage was done by the earthquake of 1456. (T. As.)

BRINDLEY, JAMES (1716-1772), English engineer, was born at Thornsett, Derbyshire, in 1716. His parents were in very humble circumstances, and he received little or no education. At the age of seventeen he was apprenticed to a millwright near Macclesfield, and soon after completing his apprenticeship he set up in business for himself as a wheelwright at Leek, quickly becoming known for his ingenuity and skill in repairing all kinds of machinery. In 1752 he designed and set up an engine for draining some coal-pits at Clifton in Lancashire. Three years later he extended his reputation by completing the machinery for a silk-mill at Congleton. In 1759, when the duke of Bridgewater was anxious to improve the outlets for the coal on his estates, Brindley advised the construction of a canal from Worsley to Manchester. The difficulties in the way were great, but all were surmounted by his genius, and his crowning triumph was the construction of an aqueduct to carry the canal at an elevation of 39 ft. over the river Irwell at Barton. The great success of this canal encouraged similar projects, and Brindley was soon engaged in extending his first work to the Mersey, at Runcorn. He then designed and nearly completed what he called the Grand Trunk Canal, connecting the Trent and Humber with the Mersey. The Staffordshire and Worcestershire, the Oxford and the Chesterfield Canals were also planned by him, and altogether he laid out over 360 m. of canals. He died at Turnhurst, Staffordshire, on the 30th of September 1772. Brindley retained to the last a peculiar roughness of character and demeanour; but his innate power of thought more than compensated for his lack of training. It is told of him that when in any difficulty he used to retire to bed, and there remain thinking out his problem until the solution became clear to him. His mechanical ingenuity and fertility of resource were very remarkable, and he undoubtedly possessed the engineering faculty in a very high degree. He was an enthusiastic believer in canals, and his reported answer, when asked the use of navigable rivers, "To feed canals," is characteristic, if not altogether authentic.

BRINTON, DANIEL GARRISON (1837-1899), American archaeologist and ethnologist, was born at Thornbury, Pennsylvania, on the 13th of May 1837. He graduated at Yale in 1858, studied for two years in the Jefferson Medical College, and then for one year travelled in Europe and continued his studies at Paris and Heidelberg. From 1862 to 1865, during the Civil War in America, he was a surgeon in the Union army, acting for one year, 1864-1865, as surgeon in charge of the U.S. Army general hospital at Quincy, Illinois. After the war he practised medicine at Westchester, Pennsylvania, for several years, was the editor of a weekly periodical, the *Medical and Surgical Reporter*, in Philadelphia, from 1874 to 1887; became professor of ethnology and archaeology in the Academy of Natural Sciences in Philadelphia in 1884, and was professor of American linguistics and archaeology in the university of Pennsylvania from 1886 until his death at Philadelphia on the 31st of July 1899.

He was a member of numerous learned societies in the United States and in Europe, and was president at different times of the Numismatic and Antiquarian Society of Philadelphia, of the American Folk-Lore Society and of the American Association for the Advancement of Science. During the period from 1859 (when he published his first book) to 1899, he wrote a score of books, several of them of great value, and a large number of pamphlets, brochures, addresses and magazine articles. His principal works are:—*The Myths of the New World* (1868), the first attempt to analyse and correlate, according to true scientific principles, the mythology of the American Indians; *The Religious Sentiment: Its Sources and Aim: A Contribution to the Science and Philosophy of Religion* (1876); *American Hero Myths* (1882); *Essays of an Americanist* (1890); *Races and Peoples* (1890); *The American Race* (1891); *The Pursuit of Happiness* (1893); and *Religions of Primitive People* (1897). In addition, he edited and published a *Library of American Aboriginal Literature* (8 vols. 1882-1890), a valuable contribution to the science of anthropology in America. Of the eight volumes, six were edited by Brinton himself, one by Horatio Hale and one by A. S. Gatschet.

BRINVILLIERS, MARIE MADELEINE MARGUERITE D'AUBRAY, MARQUISE DE (c. 1630-1676), French poisoner, daughter of Dreux d'Aubray, civil lieutenant of Paris, was born in Paris about 1630. In 1651 she married the marquis de Brinvilliers, then serving in the regiment of Normandy. Contemporary evidence describes the marquise at this time as a pretty and much-courted little woman, with a fascinating air of childlike innocence. In 1659 her husband introduced her to his friend Godin de Sainte-Croix, a handsome young cavalry officer of extravagant tastes and bad reputation, whose mistress she became. Their relations soon created a public scandal, and as the marquis de Brinvilliers, who had left France to avoid his creditors, made no effort to terminate them, M. d'Aubray secured the arrest of Sainte-Croix on a *lettre de cachet*. For a year Sainte-Croix remained a prisoner in the Bastille, where he is popularly supposed to have acquired a knowledge of poisons from his fellow-prisoner, the Italian poisoner Exili. When he left the Bastille, he plotted with his willing mistress his revenge upon her father. She cheerfully undertook to experiment with the poisons which Sainte-Croix, possibly with the help of a chemist, Christopher Glaser, prepared, and found subjects ready to hand in the poor who sought her charity, and the sick whom she visited in the hospitals. Meanwhile Sainte-Croix, completely ruined financially, enlarged his original idea, and determined that not only M. Dreux d'Aubray but also the latter's two sons and other daughter should be poisoned, so that the marquis de Brinvilliers and himself might come into possession of the large family fortune. In February 1666, satisfied with the efficiency of Sainte-Croix's preparations and with the ease with which they could be administered without detection, the marquise poisoned her father, and in 1670, with the connivance of their valet La Chaussée, her two brothers. A post-mortem examination suggested the real cause of death, but no suspicion was directed to the murderers. Before any attempt could be made on the life of Mlle Thérèse d'Aubray, Sainte-Croix suddenly died. As he left no heirs the police were called in, and discovered among his belongings documents seriously incriminating the marquise and La Chaussée. The latter was arrested, tortured into a complete confession, and broken alive on the wheel (1673), but the marquise escaped, taking refuge first probably in England, then in Germany, and finally in a convent at Liège, whence she was decoyed by a police emissary disguised as a priest. A full account of her life and crimes was found among her papers. Her attempt to commit suicide was frustrated, and she was taken to Paris, where she was beheaded and her body burned on the 16th of July 1676.

See G. Roullier, *La Marquise de Brinvilliers* (Paris, 1883); Toiselet, *Trois énigmes historiques* (Paris, 1882).

BRIONIAN ISLANDS, a group of small islands, in the Adriatic Sea, off the west coast of Istria, from which they are separated by the narrow Canale di Fasana. They belong to Austria and

are twelve in number. Up to a recent period they were chiefly noted for their quarries, which have been worked for centuries and have supplied material not only for the palaces and bridges of Venice and the whole Adriatic coast, but latterly for Vienna and Berlin also. As they command the entrance to the naval harbour of Pola, a strong fortress, "Fort Tegetthoff," has been erected on the largest of them (Brioni), together with minor fortifications on some of the others. The islands are inhabited by about 100 Italian quarrymen.

BRIOSCO, ANDREA (c. 1470-1532), Italian sculptor and architect, known as Riccio ("curly-headed"), was born at Padua. In architecture he is known by the church of Sta Giustina in his native city, but he is most famous as a worker in metal. His masterpieces are the bronze Paschal candelabrum (11 ft. high) in the choir of the Santo (S. Antonio) at Padua (1515), and the two bronze reliefs (1507) of "David dancing before the Ark" and "Judith and Holofernes" in the same church. His bronze and marble tomb of the physician Girolamo della Torre in San Fermo at Verona was beautifully decorated with reliefs, which were taken away by the French and are now in the Louvre. A number of other works which emanated from his workshop are attributed to him; and he has been suggested, but doubtfully, as the author of a fine bronze relief, a "Dance of Nymphs," in the Wallace collection at Hertford House, London.

BRIOUDE, a town of central France, capital of an arrondissement in the department of Haute-Loire, on the left bank of the Allier, 1467 ft. above the sea, 47 m. N.W. of Le Puy on the Paris-Lyon railway. Pop. (1906) 4581. Brioude has to a great extent escaped modernization and still has many old houses and fountains. Its streets are narrow and irregular, but the town is surrounded by wide boulevards lined with trees. The only building of consequence is the church of St Julian (12th and 13th centuries) in the Romanesque style of Auvergne, of which the choir, with its apse and radiating chapels and the mosaic ornamentation of the exterior, is a fine example. Brioude is the seat of a sub-prefect, and of tribunals of first instance and of commerce. The plain in which it is situated is of great fertility; the grain trade of the town is considerable, and market-gardening is carried on in the outskirts. The industries include brewing, saw-milling, lace-making and antimony mining and founding.

Brioude, the ancient *Briovis*, was formerly a place of considerable importance. It was in turn besieged and captured by the Goths (532), the Burgundians, the Saracens (732) and the Normans. In 1181 the viscount of Polignac, who had sacked the town two years previously, made public apology in front of the church, and established a body of twenty-five knights to defend the relics of St Julian. For some time after 1361 the town was the headquarters of Bérenger, lord of Castelneau, who was at the head of one of the bands of military adventurers which then devastated France. The knights (or canons, as they afterwards became) of St Julian bore the title of counts of Brioude, and for a long time opposed themselves to the civic liberties of the inhabitants.

BRIQUEMAULT (or **BRIQUEMAUT**), **FRANÇOIS DE BEAUVAIL, SEIGNEUR DE** (c. 1502-1572), leader of the Huguenots during the first religious wars, was the son of Adrien de Briquemault and Alexane de Sainte Ville, and was born about 1502. His first campaign was under the count of Brissac in the Piedmontese wars. On his return to France in 1554 he joined Admiral Coligny. Charged with the defence of Rouen, in 1562, he resigned in favour of Montgomery, to whom the prince of Condé had entrusted the task, and went over to England, where he concluded the treaty of Hampton Court on the 30th of September. He then returned to France, and took Dieppe from the Catholics before the conclusion of peace. If his share in the second religious war was less important, he played a very active part in the third. He fought at Jarnac, Roche-Abaille and Montcontour, assisted in the siege of Poitiers, was nearly captured by the Catholics at Bourg-Dieu, re-victualled Vézelay, and almost surprised Bourges. In 1570, being charged by Coligny to stop the army of the princes in its ascent of the Rhone valley, he crossed Burgundy and effected his junction

with the admiral at St Étienne in May. On the 21st of the following June he assisted in achieving the victory of Armar-le-Duc, and was then employed to negotiate a marriage between the prince of Navarre and Elizabeth of England. Being in Paris on the night of St Bartholomew he took refuge in the house of the English ambassador, but was arrested there. With his friend Arnaud de Cavagnes he was delivered over to the parliament, and failed in courage when confronted with his judges, seeking to escape death by unworthy means. He was condemned, nevertheless, on the 27th of October 1572, to the last penalty and to the confiscation of his property, and on the 29th of October he and Cavagnes were executed.

See *Histoire ecclésiastique des Églises réformées au royaume de France* (new edition, 1884), vol. ii.; *La France protestante* (2nd edition), vol. ii., article "Beauvais."

BRIQUETTE (diminutive of Fr. *brigue*, brick), a form of fuel, known also as "patent fuel," consisting of small coal compressed into solid blocks by the aid of some binding material. For making briquettes the small coal, if previously washed, is dried to reduce the moisture to at most 4%, and if necessary crushed in a disintegrator. It is then incorporated in a pug mill with from 8 to 10% of gas pitch, and softened by heating to between 70° and 90° C. to a plastic mass, which is moulded into blocks and compacted by a pressure of $\frac{1}{2}$ to 2 tons per sq. in. in a machine with a rotating die-plate somewhat like that used in making semi-plastic clay bricks. When cold, the briquettes, which usually weigh from 7 to 20 lb each, although smaller sizes are made for domestic use, become quite hard, and can be handled with less breakage than the original coal. Their principal use is as fuel for marine and locomotive boilers, the evaporative value being about the same as, or somewhat greater than, that of coal. The principal seat of the manufacture in Great Britain is in South Wales, where the dust and smalls resulting from the handling of the best steam coals (which are very brittle) are obtainable in large quantities and find no other use. Some varieties of lignite, when crushed and pressed at a steam heat, soften sufficiently to furnish compact briquettes without requiring any cementing material. Briquettes of this kind are made to a large extent from the tertiary lignites in the vicinity of Cologne; they are used mainly for house fuel on the lower Rhine and in Holland, and occasionally come to London.

BRISBANE, SIR THOMAS MAKDOUGALL (1773-1860), Scottish soldier and astronomer, was born on the 23rd of July 1773 at Brisbane House, near Largs, in Ayrshire. He entered the army in 1789, and served in Flanders, the West Indies and the Peninsula. In 1814 he was sent to North America; on the return of Napoleon from Elba he was recalled, but did not arrive in time to take part in the battle of Waterloo. In 1821 he was appointed governor of New South Wales. During the four years for which he held that office, although he allowed the finances of the colony to get into confusion, he endeavoured to improve its condition by introducing the vine, sugar-cane and tobacco plant, and by encouraging the breeding of horses and the reclamation of land. At his instigation exploring parties were sent out, and one of these discovered the Brisbane river which was named after him. He established an astronomical observatory at Paramatta in 1822, and the *Brisbane Catalogue*, which was printed in 1835 and contained 7385 stars, was the result of observations made there in 1822-1826. The observatory was discontinued in 1855. After his return to Scotland he resided chiefly at Makerstoun in Roxburghshire, where, as at Brisbane House, he had a large and admirably equipped observatory. Important magnetic observations were begun at Makerstoun in 1841, and the results gained him in 1848 the Keith prize of the Royal Society of Edinburgh, in whose *Transactions* they were published. In 1836 he was made a baronet, and G.C.B. in 1837; and in 1841 he became general. He was elected president of the Royal Society of Edinburgh after the death of Sir Walter Scott in 1833, and in the following year acted as president of the British Association. He died at Brisbane House on the 27th of January 1860. He founded two gold medals for the encouragement of scientific research, one in the

award of the Royal Society of Edinburgh, and the other in that of the Scottish Society of Arts.

BRISBANE, the capital of Queensland, Australia. It is situated in Stanley county, on the banks of the river Brisbane, 25 m. from its mouth in Moreton Bay. It is built on a series of hills rising from the river-banks, but some parts of it, such as Woolongabba and South Brisbane, occupy low-lying flats, which have sometimes been the scene of disastrous floods. The main streets and principal buildings of the city are situated on a tongue of land formed by a southward bend of the river. The extremity of the tongue, however, is open. Here, adjoining one another, are the botanical gardens, the grounds surrounding Government House, the official residence of the governor of the colony, and the Houses of Parliament, and Queen's Park, which is used as a recreation ground. From this park Albert Street runs for about three-quarters of a mile through the heart of the city, leading to Albert Park, in which is the observatory. Queen's Street, the main thoroughfare of Brisbane, crosses Albert Street midway between the two parks and leads across the Victoria Bridge to the separate city of South Brisbane on the other side of the river. The Victoria Bridge is a fine steel structure, which replaced the bridge swept away by floods in February 1893. Brisbane has a large number of buildings of architectural merit, though in some cases their effect is marred by the narrowness of the streets in which they stand. Among the most prominent are the Houses of Parliament, the great domed custom-house on the river-bank, the lands office, the general post-office, the town halls of Brisbane and South Brisbane, and the opera house. The Roman Catholic cathedral of St Stephen (Elizabeth Street) is an imposing building, having a detached campanile containing the largest bell in Australia. The foundation-stone of the Anglican cathedral, on an elevated site in Ann Street, was laid by the prince of Wales (as duke of York) in 1901. The city is the seat of a Roman Catholic archbishop and of an Anglican bishop. Many of the commercial and private buildings are also worthy of notice, especially the Queensland National Bank, a classic Italian structure, the massive treasury buildings, one of the largest erections in Australia, the Queensland Club with its wide colonnades in Italian Renaissance style, and the great buildings of the Brisbane Newspaper Company. Brisbane is well provided with parks and open spaces; the Victoria Park and Bowen Park are the largest; the high-lying Mount Coot-tha commands fine views, and there are other parks and numerous recreation grounds in various parts of the city, besides the admirable botanical gardens and the gardens of the Acclimatization Society. Electric tramways and omnibuses serve all parts of the city, and numerous ferries ply across the river. There is railway communication to north, south and west. By careful dredging, the broad river is navigable as far as Brisbane for ocean-going vessels, and the port is the terminal port for the Queensland mail steamers to Europe, and is visited by steamers to China, Japan and America, and for various inter-colonial lines. There is wharf accommodation on both banks of the river, a graving dock which can be used by vessels up to 3000 tons, and two patent slips which can take up ships of 1000 and 400 tons respectively. The exports are chiefly coal, sheep, tallow, wool, frozen meat and hides. The annual value of imports and exports exceeds seven and nine millions sterling respectively. There are boot factories, soap works, breweries, tanneries, tobacco works, &c. The climate is on the whole dry and healthy, but during summer the temperature is high, the mean shade temperature being about 70° F.

Brisbane was founded in 1825 as a penal settlement, taking its name from Sir Thomas Brisbane, then governor of Australia; in 1842 it became a free settlement and in 1859 the capital of Queensland, the town up to that time having belonged to New South Wales. It was incorporated in the same year. South Brisbane became a separate city in 1903. The municipal government of the city, and also of South Brisbane, is in the hands of a mayor and ten aldermen; the suburbs are controlled by shire councils and divisional boards. The chief suburbs are Kangaroo Point, Fortitude Valley, New Farm, Red Hill, Paddington, Milton, Toowong, Breakfast Creek, Bulimba, Woolongabba,

Highgate and Indooroopilly. The population of the metropolitan area in 1901 was 119,907; of the city proper, 28,953; of South Brisbane, 25,481.

BRISSEUX, CHARLES ÉTIENNE (c. 1680-1754), French architect. He was especially successful as a designer of internal decorations—mantelpieces, mirrors, doors and overdoors, ceilings, consoles, candelabra, wall panellings and other fittings, chiefly in the Louis Quinze mode. He was also an industrious writer on architectural subjects. His principal works are:—*L'Architecture moderne* (2 vols., 1728); *L'Art de bâtir les maisons de campagne* (2 vols., 1743); *Traité du beau essentiel dans les arts, appliqué particulièrement à l'architecture* (1752); and *Traité des proportions harmoniques*.

BRISSAC, DUKES OF. The fief of Brissac in Anjou was acquired at the end of the 15th century by a noble French family named Cossé belonging to the same province. René de Cossé married into the Gouffier family, just then very powerful at court, and became *premier panetier* (chief panter) to Louis XII. Two of his sons were marshals of France. Brissac was made a countship in 1560 for Charles, the eldest, who was grandmaster of artillery, and governor of Piedmont and of Picardy. The second, Artus, who held the offices of *grand panetier* of France and superintendent of finance, distinguished himself in the religious wars. Charles II. de Cossé fought for the League, and as governor of Paris opened the gates of that town to Henry IV., who created him marshal of France in 1594. Brissac was raised to a duchy in the peerage of France in 1611. Louis Hercule Timoléon de Cossé, duc de Brissac, and commandant of the constitutional guard of Louis XVI., was killed at Versailles on the 9th of September 1792 for his devotion to the king. (M. P.)

BRISSON, EUGÈNE HENRI (1835—), French statesman, was born at Bourges on the 31st of July 1835. He followed his father's profession of advocate, and having made himself conspicuous in opposition during the last days of the empire, was appointed deputy-mayor of Paris after its overthrow. He was elected to the Assembly on the 8th of February 1871, as a member of the extreme Left. While not approving of the Commune, he was the first to propose amnesty for the condemned (on the 13th of September 1871), but the proposal was voted down. He strongly supported obligatory primary education, and was a firm anti-clerical. He was president of the chamber from 1881—replacing Gambetta—to March 1885, when he became prime minister upon the resignation of Jules Ferry; but he resigned when, after the general elections of that year, he only just obtained a majority for the vote of credit for the Tongking expedition. He remained conspicuous as a public man, took a prominent part in exposing the Panama scandals, was a powerful candidate for the presidency after the murder of President Carnot in 1894, and was again president of the chamber from December 1894 to 1898. In June of the latter year he formed a cabinet when the country was violently excited over the Dreyfus affair; his firmness and honesty increased the respect in which he was already held by good citizens, but a chance vote on an occasion of especial excitement overthrew his ministry in October. As one of the leaders of the radicals he actively supported the ministries of Waldeck-Rousseau and Combes, especially concerning the laws on the religious orders and the separation of church and state. In 1899 he was a candidate for the presidency. In May 1906 he was elected president of the chamber of deputies by 500 out of 581 votes.

BRISSON, MATHURIN JACQUES (1723-1806), French zoologist and natural philosopher, was born at Fontenay le Comte on the 30th of April 1723. The earlier part of his life was spent in the pursuit of natural history, his published works in this department including *Le Règne animal* (1756) and *Ornithologie* (1760). After the death of R. A. F. Réaumur (1683-1757), whose assistant he was, he abandoned natural history, and was appointed professor of natural philosophy at Navarre and later at Paris. His most important work in this department was his *Poids spécifiques des corps* (1787), but he published several other books on physical subjects which were in considerable repute for a time. He died at Croissy near Paris, on the 23rd of June 1806.

BRISSOT, JACQUES PIERRE (1754-1793), who assumed the name of **DE WARVILLE**, a celebrated French Girondist, was born at Chartres, where his father was an inn-keeper, in January 1754. Brissot received a good education and entered the office of a lawyer at Paris. His first works, *Théorie des lois criminelles* (1781) and *Bibliothèque philosophique du législateur* (1782), were on the philosophy of law, and showed how thoroughly Brissot was imbued with the ethical precepts of Rousseau. The first work was dedicated to Voltaire, and was received by the old philosopher with much favour. Brissot became known as a facile and able writer, and was engaged on the *Mercure*, on the *Courrier de l'Europe*, and on other papers. Ardently devoted to the service of humanity, he projected a scheme for a general concourse of all the savants in Europe, and started in London a paper, *Journal du Lycée de Londres*, which was to be the organ of their views. The plan was unsuccessful, and soon after his return to Paris Brissot was lodged in the Bastille on the charge of having published a work against the government. He obtained his release after four months, and again devoted himself to pamphleteering, but had speedily to retire for a time to London. On this second visit he became acquainted with some of the leading Abolitionists, and founded later in Paris a *Société des Amis des Noirs*, of which he was president during 1790 and 1791. As an agent of this society he paid a visit to the United States in 1788, and in 1791 published his *Nouveaux Voyages dans les États-Unis de l'Amérique Septentrionale* (3 vols.).

From the first, Brissot threw himself heart and soul into the Revolution. He edited the *Patriote français* from 1789 to 1793, and being a well-informed and capable man took a prominent part in affairs. Upon the demolition of the Bastille the keys were presented to him. Famous for his speeches at the Jacobin club, he was elected a member of the municipality of Paris, then of the Legislative Assembly, and later of the National Convention. During the Legislative Assembly his knowledge of foreign affairs enabled him as member of the diplomatic committee practically to direct the foreign policy of France, and the declaration of war against the emperor on the 20th of April 1792, and that against England on the 1st of July 1793, were largely due to him. It was also Brissot who gave these wars the character of revolutionary propaganda. He was in many ways the leading spirit of the Girondists, who were also known as Brissotins. Vergniaud certainly was far superior to him in oratory, but Brissot was quick, eager, impetuous, and a man of wide knowledge. But he was at the same time vacillating, and not qualified to struggle against the fierce energies roused by the events of the Revolution. His party fell before the Mountain; sentence of arrest was passed against the leading members of it on the 2nd of June 1793. Brissot attempted to escape in disguise, but was arrested at Moulins. His demeanour at the trial was quiet and dignified; and on the 31st of October 1793 he died bravely with several other Girondists.

See *Mémoires de Brissot, sur ses contemporains et la Révolution française*, published by his sons, with notes by F. de Montrol (Paris, 1830); Helena Williams, *Souvenirs de la Révolution française* (Paris, 1827); F. A. Aulard, *Les Orateurs de la Législative et de la Convention* 2nd ed., Paris, 1905; F. A. Aulard, *Les Portraits littéraires de la fin du XVIII^e siècle, pendant la Révolution* (Paris, 1883).

BRISTOL, EARLS AND MARQUESSSES OF. This English title has been held in the Hervey family since 1714, though previously an earldom of Bristol, in the Digby family, is associated with two especially famous representatives, of whom separate biographies are given. The Herveys are mentioned during the 13th century as seated in Bedfordshire, and afterwards in Suffolk, where they have held the estate of Ickworth since the 15th century. John Hervey (1616-1679) was the eldest son of Sir William Hervey (d. 1660), and was born on the 18th of August 1616. He held a high position in the household of Catherine, wife of Charles II., and was for many years member of parliament for Hythe. He married Elizabeth, the only surviving child of his kinsman, William, Lord Hervey of Kidbrooke (d. 1642), but left no children when he died on the 18th of January 1679, and his estates passed to his brother, Sir Thomas Hervey. Sir Thomas, who was member of parliament for Bury St Edmunds,

died on the 27th of May 1694, and was succeeded by his son, John, who became the 1st earl of Bristol.

JOHN HERVEY, 1st earl of Bristol (1665-1751), born on the 27th of August 1665, was educated at Clare Hall, Cambridge, and became member of parliament for Bury St Edmunds in March 1694. In March 1703 he was created Baron Hervey of Ickworth, and in October 1714 was made earl of Bristol as a reward for his zeal in promoting the principles of the revolution and supporting the Hanoverian succession. He died on the 20th of January 1751. By his first wife, Isabella (d. 1693), daughter of Sir Robert Carr, Bart., of Sleaford, he had one son, Carr, Lord Hervey (1691-1723), who was educated at Clare Hall, Cambridge, and was member for Bury St Edmunds from 1713 to 1722. (It has been suggested that Carr, who died unmarried on the 14th of November 1723, was the father of Horace Walpole.) He married secondly Elizabeth (d. 1741), daughter and co-heiress of Sir Thomas Felton, Bart., of Playford, Suffolk, by whom he had ten sons and six daughters. His eldest son, John (1696-1743), took the courtesy title of Lord Hervey on the death of his half-brother, Carr; in 1723, and gained some renown both as a writer and a politician (see HERVEY OF ICKWORTH). Another son, Thomas (1699-1775), was one of the members for Bury from 1733 to 1747; held various offices at court; and eloped with Elizabeth, wife of Sir Thomas Hanmer. He had very poor health, and his reckless life frequently brought him into pecuniary and other difficulties. He wrote numerous pamphlets, and when he died Dr Johnson said of him, "Tom Hervey, though a vicious man, was one of the gentlest men who ever lived." Another of the 1st earl's sons, Felton (1712-1773), was also member for the family borough of Bury St Edmunds. Having assumed the additional name of Bathurst, Felton's grandson, Felton Elwell Hervey-Bathurst (1782-1819), was created a baronet in 1818, and on his death a year later the title descended to his brother, Frederick Anne (1783-1824), the direct ancestor of the present baronet. The 1st earl died in January 1751, the title and estates descending to his grandson.

GEORGE WILLIAM HERVEY, 2nd earl of Bristol (1721-1775), the eldest son of John, Lord Hervey of Ickworth, by his marriage with Mary (1700-1768), daughter of Nicholas Lepell, was born on the 31st of August 1721. He served for some years in the army, and in 1755 was sent to Turin as envoy extraordinary. He was ambassador at Madrid from 1758 to 1761, filling a difficult position with credit and dignity, and ranked among the followers of Pitt. Appointed lord-lieutenant of Ireland in 1766, he never visited that country during his short tenure of this office, and, after having served for a short time as keeper of the privy seal, became groom of the stole to George III. in January 1770. He died unmarried on the 18th or 20th of March 1775, and was succeeded by his brother.

AUGUSTUS JOHN HERVEY, 3rd earl of Bristol (1724-1779), was born on the 19th of May 1724, and entered the navy, where his promotion was rapid. He distinguished himself in several encounters with the French, and was of great assistance to Admiral Hawke in 1759, although he had returned to England before the battle of Quiberon Bay in November 1759. Having served with distinction in the West Indies under Rodney, his active life at sea ceased when the peace of Paris was concluded in February 1763. He was, however, nominally commander-in-chief in the Mediterranean in this year, and was made vice-admiral of the blue in January 1778. Hervey was member of parliament for Bury from 1757 to 1763, and after being for a short time member for Saltash, again represented Bury from 1768 until he succeeded his brother in the peerage in 1775. He often took part in debates in parliament, and was a frequent contributor to periodical literature. Having served as a lord of the admiralty from 1771 to 1775, he won some notoriety as an opponent of the Rockingham ministry and a defender of Admiral Keppel. In August 1744 he had been secretly married to Elizabeth Chudleigh (1720-1788), afterwards duchess of Kingston (q.v.), but this union was dissolved in 1769. The earl died in London on the 23rd of December 1779, leaving no legitimate issue, and having, as far as possible, alienated his property from the

title. He was succeeded by his brother. Many of his letters are in the Record Office, and his journals in the British Museum. Other letters are printed in the *Greenhill Papers*, vols. iii. and iv. (London, 1852-1853), and the *Life of Admiral Keppel*, by the Hon. T. Keppel (London, 1852).

FREDERICK AUGUSTUS HERVEY, bishop of Derry (1730-1803), who now became 4th earl of Bristol, was born on the 1st of August 1730, and educated at Westminster school and Corpus Christi College, Cambridge, graduating in 1754. Entering the church he became a royal chaplain; and while waiting for other preferment spent some time in Italy, whither he was led by his great interest in art. In February 1767, while his brother, the 2nd earl, was lord-lieutenant of Ireland, he was made bishop of Cloyne, and having improved the property of the see he was translated to the rich bishopric of Derry a year later. Here again he was active and philanthropic. While not neglecting his luxurious personal tastes he spent large sums of money on making roads and assisting agriculture, and his munificence was shared by the city of Londonderry. He built splendid residences at Downhill and Ballyscullion, which he adorned with rare works of art. As a bishop, Hervey was industrious and vigilant; he favoured complete religious equality, and was opposed to the system of tithes. In December 1779 he became earl of Bristol, and in spite of his brother's will succeeded to a considerable property. Having again passed some time in Italy, he returned to Ireland and in 1782 threw himself ardently into the Irish volunteer movement, quickly attaining a prominent position among the volunteers, and in great state attending the convention held in Dublin in November 1783. Carried away by his position and his popularity he talked loudly of rebellion, and his violent language led the government to contemplate his arrest. Subsequently he took no part in politics, spending his later years mainly on the continent of Europe. In 1798 he was imprisoned by the French at Milan, remaining in custody for eighteen months. He died at Albano on the 8th of July 1803, and was buried in Ickworth church. Varying estimates have been found of his character, including favourable ones by John Wesley and Jeremy Bentham. He was undoubtedly clever and cultured, but licentious and eccentric. In later life he openly professed materialistic opinions; he fell in love with the countess Lichtenau, mistress of Frederick William II., king of Prussia; and by his bearing he gave fresh point to the saying that "God created men, women and Herveys." In 1752 he had married Elizabeth (d. 1800), daughter of Sir Jermyn Davers, Bart., by whom he had two sons and three daughters. His elder son, Augustus John, Lord Hervey (1757-1796), had predeceased his father, and he was succeeded in the title by his younger son.

FREDERICK WILLIAM HERVEY, 5th earl and 1st marquess of Bristol (1769-1859), was born on the 2nd of October 1769. He married Elizabeth Albana (d. 1844), daughter of Clotworthy, 1st Baron Templeton, by whom he had six sons and three daughters. In 1826 he was created marquess of Bristol and Earl Jermyn, and died on the 15th of February 1859. He was succeeded by his son Frederick William (1800-1864), M.P. for Bury St Edmunds 1830-1859, as 2nd marquess; and by the latter's son Frederick William John (1834-1907), M.P. for West Suffolk 1859-1864, as 3rd marquess. The latter's nephew, Frederick William Fane Hervey (b. 1863), who succeeded as 4th marquess, served with distinction in the royal navy, and was M.P. for Bury St Edmunds from 1906 to 1907.

See John, Lord Hervey, *Memoirs of the Reign of George II.*, edited by J. W. Croker (London, 1884); John Hervey, 1st earl of Bristol, *Diary* (Wells, 1894); and *Letter Books of Bristol*; with *Sir T. Hervey's Letters during Courtship and Poems during Widowhood* (Wells, 1894). Also the articles in the *Dictionary of National Biography*, vol. xxvi. (London, 1891).

BRISTOL, GEORGE DIGBY, 2ND EARL OF¹ (1612-1677), eldest son of the 1st earl (see below), was born in October 1612. At the age of twelve he appeared at the bar of the House of Commons and pleaded for his father, then in the Tower, when his youth, graceful person and well-delivered speech made a great

¹ J. s. in the Digby line; for the Herveys see above.

impression. He was admitted to Magdalen College, Oxford, on the 15th of August 1626, where he was a favourite pupil of Peter Heylin, and became M.A. in 1636. He spent the following years in study and in travel, from which he returned, according to Clarendon, "the most accomplished person of our nation or perhaps any other nation," and distinguished by a remarkably handsome person. In 1638 and 1639 were written the *Letters between Lord George Digby and Sir Kenelm Digby, Knt. concerning Religion* (publ. 1651), in which Digby attacked Roman Catholicism. In June 1634 Digby was committed to the Fleet till July for striking Crofts, a gentleman of the court, in Spring Gardens; and possibly his severe treatment and the disfavour shown to his father were the causes of his hostility to the court. He was elected member for Dorsetshire in both the Short and Long parliaments in 1640, and in conjunction with Pym and Hampden he took an active part in the opposition to Charles. He moved on the 9th of November for a committee to consider the "deplorable state" of the kingdom, and on the 11th was included in the committee for the impeachment of Strafford, against whom he at first showed great zeal. He, however, opposed the attainder, made an eloquent speech on the 21st of April 1641, accentuating the weakness of Vane's evidence against the prisoner, and showing the injustice of *ex post facto* legislation. He was regarded in consequence with great hostility by the parliamentary party, and was accused of having stolen from Pym's table Vane's notes on which the prosecution mainly depended. On the 15th of July his speech was burnt by the hangman by the order of the House of Commons. Meanwhile on the 8th of February he had made an important speech in the Commons advocating the reformation and opposing the abolition of episcopacy. On the 8th of June, during the angry discussion on the army plot, he narrowly escaped assault in the House; and the following day, in order to save him from further attacks, the king called him up to the Lords in his father's barony of Digby.

He now became the evil genius of Charles, who had the incredible folly to follow his advice in preference to such men as Hyde and Falkland. In November he is recorded as performing "singular good service," and "doing beyond admiration," in speaking in the Lords against the instruction concerning evil counsellors. He suggested to Charles the impeachment of the five members, and urged upon him the fatal attempt to arrest them on the 4th of January 1642; but he failed to play his part in the Lords in securing the arrest of Lord Mandeville, to whom on the contrary he declared that "the king was very mischievously advised"; and according to Clarendon his imprudence was responsible for the betrayal of the king's plan. Next day he advised the attempt to seize them in the city by force. The same month he was ordered to appear in the Lords to answer a charge of high treason for a supposed armed attempt at Kingston, but fled to Holland, where he joined the queen, and on the 16th of February was impeached. Subsequently he visited Charles at York disguised as a Frenchman, but on the return voyage to Holland he was captured and taken to Hull, where he for some time escaped detection; and at last he cajoled Sir John Lotham, after discovering himself, into permitting his escape. Later he ventured on a second visit to Hull to persuade Lotham to surrender the place to Charles, but this project failed. He was present at Edgehill, and greatly distinguished himself at Lichfield, where he was wounded while leading the assault. He soon, however, threw down his commission in consequence of a quarrel with Prince Rupert, and returned to the king at Oxford, over whom he obtained more influence as the prospect became more gloomy. On the 28th of September 1643 he was appointed secretary of state and a privy councillor, and on the 31st of October high steward of Oxford University. He now supported the queen's disastrous policy of foreign alliances and help from Ireland, and engaged in a series of imprudent and ill-conducted negotiations which greatly injured the king's affairs, while his fierce disputes with Rupert and his party further embarrassed them. On the 14th of October 1645 he was made lieutenant-general of the royal forces north of the Trent, with the object of pushing through to join Montrose, but he was defeated on

the 15th at Sherburn, where his correspondence was captured, disclosing the king's expectations from abroad and from Ireland and his intrigues with the Scots; and after reaching Dumfries, he found his way barred. He escaped on the 24th to the Isle of Man, thence crossing to Ireland, where he caused Glamorgan to be arrested. Here, on this new stage, he believed he was going to achieve wonders. "Have I not carried my body swimmingly," he wrote to Hyde in irrepressible good spirits, "who being before so irreconcilably hated by the Puritan party, have thus reasonably made myself as odious to the Papists?"¹ His project now was to bring over Prince Charles to head a royalist movement in the island; and having joined Charles at Jersey in April 1646, he intended to entrap him on board, but was dissuaded by Hyde. He then travelled to Paris to gain the queen's consent to his scheme, but returned to persuade Charles to go to Paris, and accompanied him thither, revisiting Ireland on the 29th of June once more, and finally escaping to France on the surrender of the island to the parliament. At Paris amongst the royalists he found himself in a nest of enemies eager to pay off old scores. Prince Rupert challenged him, and he fought a duel with Lord Wilmot. He continued his adventures by serving in Louis XIV.'s troops in the war of the Fronde, in which he greatly distinguished himself. He was appointed in 1651 lieutenant-general in the French army, and commander of the forces in Flanders. These new honours, however, were soon lost. During Mazarin's enforced absence from the court Digby aspired to become his successor; and the cardinal, who had from the first penetrated his character and regarded him as a mere adventurer,² on his restoration to power sent Digby away on an expedition in Italy; and on his return informed him that he was included in the list of those expelled from France, in accordance with the new treaty with Cromwell. In August 1656 he joined Charles II. at Bruges, and desirous of avenging himself upon the cardinal offered his services to Don John of Austria in the Netherlands, being instrumental in effecting the surrender of the garrison of St Ghislain to Spain in 1657. On the 1st of January 1657 he was appointed by Charles II. secretary of state, but shortly afterwards, having become a Roman Catholic—probably with the view of adapting himself better to his new Spanish friends—he was compelled to resign office. Charles, however, on account of his "jollity" and Spanish experience took him with him to Spain in 1659, though his presence was especially deprecated by the Spanish; but he succeeded in ingratiating himself, and was welcomed by the king of Spain subsequently at Madrid.

By the death of his father Digby had succeeded in January 1659 to the peerage as 2nd earl of Bristol, and had been made K.G. the same month. He returned to England at the restoration, when he found himself excluded from office on account of his religion, and relegated to only secondary importance. His desire to make a brilliant figure induced a restless and ambitious activity in parliament. He adopted an attitude of violent hostility to Clarendon. In foreign affairs he inclined strongly to the side of Spain, and opposed the king's marriage with Catherine of Portugal. He persuaded Charles to despatch him to Italy to view the Medici princesses, but the royal marriage and treaty with Portugal were settled in his absence. In June 1663 he made an attempt to upset Clarendon's management of the House of Commons, but his intrigue was exposed to the parliament by Charles, and Bristol was obliged to attend the House to exonerate himself, when he confessed that he had "taken the liberty of enlarging," and his "comedian-like speech" excited general amusement. Exasperated by these failures, in a violent scene with the king early in July, he broke out into fierce and disrespectful reproaches, ending with a threat that unless Charles granted his requests within twenty-four hours "he would do somewhat that should awaken him out of his slumbers, and make him look better to his own business." Accordingly on the 10th he impeached Clarendon in the Lords of high treason, and on the charge being dismissed returned

his accusation, and was expelled from the court, only avoiding the warrant issued for his apprehension by a concealment of two years. In January 1664 he caused a new sensation by his appearance at his house at Wimbledon, where he publicly renounced before witnesses his Roman Catholicism, and declared himself a Protestant, his motive being probably to secure immunity from the charge of recusancy preferred against him.³ When, however, the fall of Clarendon was desired, Bristol was again welcomed at court. He took his seat in the Lords on the 29th of July 1667. "The king," wrote Pepys in November, "who not long ago did say of Bristol that he was a man able in three years to get himself a fortune in any kingdom in the world and lose all again in three months, do now hug him and commend his parts everywhere above all the world."⁴ He pressed eagerly for Clarendon's committal, and on the refusal of the Lords accused them of mutiny and rebellion, and entered his dissent with "great fury."⁵ In March 1668 he attended prayers in the Lords. On the 15th of March 1673 though still ostensibly a Roman Catholic, he spoke in favour of the Test Act, describing himself as "a Catholic of the church of Rome, not a Catholic of the court of Rome," and asserting the unfitness of Romanists for public office. His adventurous and erratic career closed by death on the 20th of March 1677.

Bristol was one of the most striking and conspicuous figures of his time, a man of brilliant abilities, a great orator, one who distinguished himself without effort in any sphere of activity he chose to enter, but whose natural gifts were marred by a restless ambition and instability of character fatal to real greatness. Clarendon describes him as "the only man I ever knew of such incomparable parts that was none the wiser for any experience or misfortune that befell him," and records his extraordinary facility in making friends and making enemies. Horace Walpole characterized him in a series of his smartest antitheses as "a singular person whose life was one contradiction." "He wrote against popery and embraced it; he was a zealous opposer of the court and a sacrifice for it; was conscientiously converted in the midst of his prosecution of Lord Strafford and was most unconscientiously a persecutor of Lord Clarendon." With great parts, he always hurt himself and his friends; with romantic bravery, he was always an unsuccessful commander. He spoke for the Test Act, though a Roman Catholic; and addicted himself to astrology on the birthday of true philosophy." Besides his youthful correspondence with Sir K. Digby on the subject of religion already mentioned, he was the author of an *Apologie* (1643, Thomason Tracts, E. 34 (32)), justifying his support of the king's cause; of *Elvira . . . a comedy* (1667), printed in R. Doddsley's *Select Collect. of Old English Plays* (Hazlitt, 1876), vol. xv., and of *Worse and Worse*, an adaptation from the Spanish, acted but not printed. Other writings are also ascribed to him, including the authorship with Sir Samuel Tuke of *The Adventures of Five Hours* (1663). His eloquent and pointed speeches, many of which were printed, are included in the article in the *Biog. Brit.* and among the *Thomason Tracts*; see also the general catalogue in the British Museum. The catalogue of his library was published in 1680. He married Lady Anne Russell, daughter of Francis, 4th earl of Bedford, by whom, besides two daughters, he had two sons, Francis, who predeceased him unmarried, and John, who succeeded him as 3rd earl of Bristol, at whose death without issue the peerage became extinct.

AUTHORITIES.—See the article in *Dict. Nat. Biog.*; Wood's *Ath. Oxon.* (Bliss), iii. 1100-1103; *Biographia Brit.* (Kippis), v. 210-238; H. Walpole's *Royal and Noble Authors* (Park, 1806), iii. 191; *Roscius Anglicanus*, by J. Downes, pp. 31, 36 (1789); Cunningham's *Lives of Eminent Englishmen* (1837), iii. 29; *Somers Tracts* (1750), iii. (1809), iv.; *Harleian Miscellany* (1808), v., vi.; *Life* by T. H. Lister (1838); *State Papers*. (P. C. Y.)

BRISTOL, JOHN DIGBY, 1ST EARL OF (1580-1653) English diplomatist, son of Sir George Digby of Colehill, Warwickshire, and of Abigail, daughter of Sir Arthur Henningham, was born in

¹ Pepys's *Diary*, iv. 51.

² *Ib.* vii. 199.

³ *Ib.* 207; *Protests of the Lords*, by J. E. T. Rogers, i. 36.

⁴ *Ia.* in the Digby line; for the Herveys see above.

¹ *Clarendon State Papers*, ii. 201.

² *Mémoires du Cardinal de Retz* (1859), app. iii. 437, 442.

1580, and entered Magdalen College, Oxford, in 1595 (M.A. 1605), becoming a member of the Inner Temple in 1598. In 1605 he was sent to James to inform him of the safety of the princess Elizabeth at the time of the Gunpowder Plot. He gained his favour, was made a gentleman of the privy chamber and one of the king's carvers, and was knighted in 1607. From 1610 to 1611 he was member of parliament for Heydon. In 1611 he was sent as ambassador to Spain to negotiate a marriage between Prince Henry and the infanta Anne, and to champion the cause of the English merchants, for whom he obtained substantial concessions, and arranged the appointment of consuls at Lisbon and Seville. He also discovered a list of the English pensioners of the Spanish court, which included some of the ministers, and came home in 1613 to communicate this important intelligence to the king. In 1614 he again went to Spain to effect a union between the infanta Maria and Charles, though he himself was in favour of a Protestant marriage, and desired a political and not a matrimonial treaty. In 1616, on the disgrace of Somerset, he was recalled home to give evidence concerning the latter's connexions with Spain, was made vice-chamberlain and a privy councillor, and obtained from James the manor of Sherborne forfeited by the late favourite. In 1618 he went once more to Spain to reopen the negotiations, returning in May, and being created Baron Digby on the 25th of November. He endeavoured to avoid a breach with Spain on the election of the elector palatine, the king's son-in-law, to the Bohemian throne; and in March 1621, after the latter's expulsion from Bohemia, Digby was sent to Brussels to obtain a suspension of hostilities in the Palatinate. On the 4th of July he went to Vienna and drew up a scheme of pacification with the emperor, by which Frederick was to abandon Bohemia and be secured in his hereditary territories, but the agreement could never be enforced. After raising money for the defence of Heidelberg he returned home in October, and on the 21st of November explained his policy to the parliament, and asked for money and forces for its execution. The sudden dissolution of parliament, however, prevented the adoption of any measure of support, and entirely ruined Digby's plans. In 1622 he returned to Spain with nothing on which to rely but the goodwill of Philip IV., and nothing to offer but entreaties.

On the 15th of September he was created earl of Bristol. He urged on the marriage treaty, believing it would include favourable conditions for Frederick, but the negotiations were taken out of his control, and finally wrecked by the arrival of Charles himself and Buckingham in March 1623. He incurred their resentment, of which the real inspiration was Buckingham's implacable jealousy, by a letter written to James informing him of Buckingham's unpopularity among the Spanish ministers, and by his endeavouring to maintain the peace with Spain after their departure. In January 1624 he left Spain, and on arriving at Dover in March, Buckingham and Charles having now complete ascendancy over the king, he was forbidden to appear at court and ordered to confine himself at Sherborne. He was required by Buckingham to answer a series of interrogatories, but he refused to inculpate himself and demanded a trial by parliament. On the death of James he was removed by Charles I. from the privy council, and ordered to absent himself from his first parliament. On his demand in January 1626 to be present at the coronation Charles angrily refused, and accused him of having tried to pervert his religion in Spain. In March 1626, after the assembling of the second parliament, Digby applied to the Lords, who supported his rights, and Charles sent him his writ accompanied by a letter from Lord Keeper Coventry desiring him not to use it. Bristol, however, took his seat and demanded justice against Buckingham (Thomason Tracts, E. 126 (20)). The king endeavoured to obstruct his attack by causing Bristol on the 1st of May to be himself brought to the bar, on an accusation of high treason by the attorney-general. The Lords, however, ordered that both charges should be investigated simultaneously. Further proceedings were stopped by the dissolution of parliament on the 15th of June; a prosecution was ordered by Charles in the Star Chamber, and Bristol was sent to the

Tower, where he remained till the 17th of March 1628, when the peers, on the assembling of Charles's third parliament, insisted on his liberation and restoration to his seat in the Lords.

In the discussions upon the Petition of Right, Bristol supported the use of the king's prerogative in emergencies, and asserted that the king besides his legal had a regal power, but joined in the demand for a full acceptance of the petition by the king after the first unsatisfactory answer. He was now restored to favour, but took no part in politics till the outbreak of the Scottish rebellion, when he warned Charles of the danger of attacking with inadequate forces. He was the leader in the Great Council held at York, was a commissioner to treat with the Scots in September 1640 at Ripon, and advised strongly the summoning of the parliament. In February 1641 he was one of the peers who advocated reforms in the administration and were given seats in the council. Though no friend to Strafford, he endeavoured to save his life, desiring only to see him excluded from office, and as a witness was excused from voting on the attainder. He was appointed gentleman of the bedchamber on the king's departure for Scotland, and on the 27th of December he was declared an evil counsellor by the House of Commons, Cromwell on the 28th moving an address to the king to dismiss him from his councils, on the plea that he had advocated the bringing up of the northern army to overawe parliament in the preceding spring. There is no evidence to support the charge, but Digby was regarded by the parliamentary party with special hatred and distrust, of which the chief causes were probably his Spanish proclivities and his indifference on the great matter of religion, to which was added the unpopularity reflected from his misguided son. On the 28th of March 1642 he was sent to the Tower for having failed to disclose to parliament the Kentish petition. Liberated in April, he spoke in the Lords on the 20th of May in favour of an accommodation, and again in June in vindication of the king; but finding his efforts ineffectual, and believing all armed rebellion against the king a wicked violation of the most solemn oaths, he joined Charles at York, was present at Edgehill and accompanied him to Oxford. On the 1st of February 1643 he was named with Lord Herbert of Raglan for removal from the court and public office for ever, and in the propositions of November 1644 was one of those excepted from pardon. In January he had endeavoured to instigate a breach of the Independents with the Scots. Bristol, however, was not in favour of continuing the war, and withdrew to Sherborne, removing in the spring of 1644 to Exeter, and after the surrender of the city retiring abroad on the 11th of July by order of the Houses, which rejected his petition to compound for his estate. He took up his residence at Caen, passing the rest of his life in exile and poverty, and occasionally attending the young king. In 1647 he printed at Caen *An Apology*, defending his support of the royal cause. This was reprinted in 1656 (Thomason Tracts, E. 807, 6). He died at Paris on the 16th of January 1653.

He is described by Clarendon as "a man of grave aspect, of a presence that drew respect, and of great parts and ability, but passionate and supercilious and too voluminous a discourses in council." His aim was to effect a political union between England and Spain apart from the religious or marriage questions—a policy which would probably have benefited both English and European interests; but it was one understood neither a Spain nor in England, and proved impracticable. He was a man of high character, who refused to compound with falsehood and injustice, whose misfortune it was to serve two Stuart sovereigns, and whose firm resistance to the king's tyranny led the way to the great movement which finally destroyed it. Besides his *Apology*, he was the author of several printed speeches and poems, and translated *A Defence of the Catholic Faith* by Peter du Moulin (1610). He married Beatrix, daughter of Charles Walcot, and widow of Sir John Dyve, and besides two daughters left two sons, George, who succeeded him as 2nd earl of Bristol, and John, who died unmarried.

BIBLIOGRAPHY.—The best account of Bristol will be found in the scattered notices of him in the *Hist. of England* and of the *Civil War*, by S. R. Gardiner, who also wrote the short sketch of his career in

the *Dict. of Nat. Biog.*; and who highly eulogizes his character and diplomacy. For lives, see *Biographia Britannica* (Kippis), v. 199; *Wood's Ath. Oxon.* (Bliss), iii. 338; *D. Lloyd's Memoirs* (1668), 579; *Collins's Peerage* (Hedges, 1812), v. 362; *Fuller's Worthies* (Nichols, 1811), ii. 412; *B. Walpole's Royal and Noble Authors* (Park, 1806), iii. 49; also *Clarendon's Hist. of the Rebellion*, esp. vi. 388; *Clarendon State Papers* and *Cal. of Cl. State Papers; Old Parliamentary History; Cabala* (1691); letters; *Camden Soc., Miscellany*, vol. vi. (1871); *Defence of his Spanish Negotiations*, ed. by S. R. Gardiner; *Somers Tracts* (1809), ii. 501; *Thomason Tracts in Brit. Museum; Hardwicks State Papers*, i. 494. The MSS. at Sherborne Castle, of which a selection was transcribed and deposited in the Public Record Office, were calendared by the *Hist. MSS. Commission in Rep. viii.* app. i. p. 213 and 10th *Rep.* app. i. p. 520; there are numerous references to Bristol in various collections calendared in the same publication and in the *Cal. of State Papers, Dom. Series*; see also *Horleian MSS.*, *Brit. Mus.* 1580, art. 31-48, and *Add. MSS. indexes and calendars.* (P. C. Y.)

BRISTOL, a township of Hartford county, Connecticut, U.S.A., in the central part of the state, about 16 m. S.W. of Hartford. It has an area of 27 sq. m., and contains the village of Forestville and the borough of Bristol (incorporated in 1893). Both are situated on the Pequabuck river, and are served by the western branch of the Midland division of the New York, New Haven & Hartford railway, and by electric railway to Hartford, New Britain and Terryville. Pop. (1890) 7382; (1900) 9643, including that of the borough, 6268 (1910) 13,502 (borough, 9527). Among the manufactures of the borough of Bristol are clocks, woollen goods, iron castings, hardware, brass ware, silverplate and bells. Bristol clocks, first manufactured soon after the War of Independence, have long been widely known. Bristol, originally a part of the township of Farmington, was first settled about 1727, but did not become an independent corporation until the formation, in 1742, of the first church, known after 1744 as the New Cambridge Society. In 1748 a Protestant Episcopal Church was organized, and before and during the War of Independence its members belonged to the Loyalist party; their rector, Rev. James Nichols, was tarred and feathered by the Whigs, and Moses Dunbar, a member of the church, was hanged for treason by the Connecticut authorities. Chippen's Hill (about 3 m. from the centre of the township) was a favourite rendezvous of the local Loyalists; and a cave there, known as "The Tories' Den," is a well-known landmark. In 1785 New Cambridge and West Britain, another ecclesiastical society of Farmington, were incorporated as the township of Bristol, but in 1806 they were divided into the present townships of Bristol and Burlington.

BRISTOL, a city, county of a city, municipal, county and parliamentary borough, and seaport of England, chiefly in Gloucestershire but partly in Somersetshire, 118½ m. W. of London. Pop. (1901) 328,945. The Avon, here forming the boundary between Gloucestershire and Somerset, though entering the estuary of the Severn (Bristol Channel) only 8 m. below the city, is here confined between considerable hills, with a narrow valley-floor on which the nucleus of the city rests. Between Bristol and the Channel the valley becomes a gorge, crossed at a single stride by the famous Clifton Suspension Bridge. Above Bristol the hills again close in at Keynsham, so that the city lies in a basin-like hollow some 4 m. in diameter, and extends up the heights to the north. The Great Western railway, striking into the Avon valley near Bath, serves Bristol from London, connects it with South Wales by the Severn tunnel, and with the southern and south-western counties of England. Local lines of this company encircle the city on the north and the south, serving the outports of Avonmouth and Portishead on the Bristol Channel. A trunk line of the Midland railway connects Bristol with the north of England by way of Gloucester, Worcester, Birmingham and Derby. Both companies use the central station, Temple Meads.

The nucleus of Bristol lies to the north of the river. The business centre is in the district traversed by Broad Street, High Street, Wine Street and Corn Street, which radiate from a centre close to the Floating Harbour. To the south of this centre, connected with it by Bristol Bridge, an island is formed between the Floating Harbour and the New Course of the Avon,

and here are Temple Meads station, above Victoria Street, two of the finest churches (the Temple and St Mary Redcliffe) the general hospital and other public buildings. Immediately above the bridge the little river Frome joins the Avon. Owing to the nature of the site the streets are irregular; in the inner part of the city they are generally narrow, and sometimes, with their ancient gabled houses, extremely picturesque. The principal suburbs surround the city to the west, north and east.

Churches, &c.—In the centre of Bristol a remarkable collection of architectural antiquities is found, principally ecclesiastical. This the city owes mainly to a few great baronial families, such as the earls of Gloucester and the Berkeleys, in its early history, and to a few great merchants, the Canynys, Shipwards and Framptons, in its later career. The see of Bristol, founded by Henry VIII. in 1542, was united to that of Gloucester in 1836; but again separated in 1896. The diocese includes parts of Gloucestershire and Wiltshire, and a small but populous portion of Somerset. The cathedral, standing above the so-called Canons' Marsh which borders the Floating Harbour, is pleasantly situated on the south side of College Green. It has two western towers and a central tower, nave, short transepts, choir with aisles, an eastern Lady chapel and other chapels; and on the south, a chapter-house and cloister court. The nave is modern (by Street, 1877), imitating the choir of the 14th century, with its curious skeleton-vaulting in the aisles. Besides the canopied tombs of the Berkeleys with their effigies in chain mail, and similarly fine tombs of the Crosier abbots, there are memorials to Bishop Butler, to Sterne's Eliza (Elizabeth Draper), and to Lady Heaketh (the friend of Cowper), who are all interred here. There is also here William Mason's fine epitaph to his wife (d. 1767), beginning "Take, holy earth, all that my soul holds dear." Of Fitz-Harding's abbey of St Augustine, founded in 1142 (of which the present cathedral was the church), the stately entrance gateway, with its sculptured mouldings, remains hardly injured. The abbot's gateway, the vestibule to the chapter-house, and the chapter-house itself, which is carved with Byzantine exuberance of decoration, and acknowledged to be one of the finest Norman chambers in Europe, are also perfect. On the north side of College Green is the small but ornate Mayor's chapel (originally St Mark's), devoted to the services of the mayor and corporation. It is mainly Decorated and Perpendicular. Of the churches within the centre of the city, the following are found within a radius of half-a-mile from Bristol Bridge. St Stephen's church, built between 1450 and 1490, is a dignified structure, chiefly interesting for its fan-traceried porch and stately tower. It was built entirely by the munificence of John Shipward, a wealthy merchant. The tower and spire of St John's (15th century) stand on one of the gateways of the city. This church is a parallelogram, without east or west windows or aisles, and is built upon a fine groined crypt. St James's church, the burial place of its founder, Robert, earl of Gloucester, dates from 1130, and fine Norman work remains in the nave. The tower is of the 14th century. St Philip's has an Early English tower, but its external walls and windows are for the most part debased Perpendicular. Robert FitzHamon's Norman tower of St Peter, the oldest church tower in Bristol, still presents its massive square to the eye. This church stands in Castle Street, which commemorates the castle of Robert, earl of Gloucester, the walls of which were 25 ft. thick at the base. Nothing remains of this foundation, but there still exist some walls and vaults of the later stronghold, including a fine Early English cell. Adjacent to the church is St Peter's hospital, a picturesque gabled building of Jacobean and earlier date, with a fine court room. St Mary le Port and St Augustine the Less are churches of the Perpendicular era, and not the richest specimens of their kind. St Nicholas church is modern, on a crypt of the date 1503, and earlier. On the island south of the Floating Harbour are two of the most interesting churches in the city. Temple church, with its leaning tower, 5 ft. off the perpendicular, retains nothing of the Templars' period, but is a fine building of the Decorated and Perpendicular periods. The church of

St Mary Redcliffe, for grandeur of proportion and elaboration of design and finish, is the first ecclesiastical building in Bristol, and takes high rank among the parish churches of England. It was built for the most part in the latter part of the 14th century by William Canyng or Canynges (*q.v.*), but the sculptured north porch is externally Decorated, and internally Early English. The fine tower is also Decorated, on an Early English base. The spire, Decorated in style, is modern. Among numerous monuments is that of Admiral Penn (d. 1718), the father of the founder of Pennsylvania. The church exhibits the rare feature of transeptal aisles. Of St Thomas's, in the vicinity, only the tower (15th century) remains of the old structure. All Hallows church has a modern Italian campanile, but is in the main of the 15th century, with the retention of four Norman piers in the nave; and is interesting from its connexion with the ancient gild of calendarers, whose office it was "to convert Jews, instruct youths," and keep the archives of the town. Theirs was the first free library in the city, possibly in England. The records of the church contain a singularly picturesque representation of the ancient customs of the fraternity.

Among conventual remains, besides those already mentioned, there exist of the Dominican priory the Early English refectory and dormitory, the latter comprising a row of fifteen original windows and an oak roof of the same date; and of St Bartholomew's hospital there is a double arch, with intervening arcades, also Early English. These, with the small chapel of the Three Kings of Cologne, Holy Trinity Hospital, both Perpendicular, and the remains of the house of the Augustinian canons attached to the cathedral, comprise the whole of the monastic relics.

There are many good specimens of ancient domestic architecture—notably some arches of a grand Norman hall and some Tudor windows of Colston's house, Small Street; and Canyng's house, with good Perpendicular oak roof. Of buildings to which historic interest attaches, there are the Merchant Venturers' almshouses (1699), adjoining their hall. This gild was established in the 16th century. A small house near St Mary Redcliffe was the school where the poet Chatterton received his education. His memorial is in the churchyard of St Mary, and in the church a chest contains the records among which he claimed to have discovered some of the manuscripts which were in reality his own. A house in Wine Street was the birthplace of the poet-laureate Robert Southey (1744).

Public Buildings, &c.—The public buildings are somewhat overshadowed in interest by the ecclesiastical. The council house, at the "Cross" of the four main thoroughfares, dates from 1827, was enlarged in 1894, and contains the city archives and many portraits, including a Van Dyck and a Kneller. The Guildhall is close by—a modern Gothic building. The exchange (used as a corn-market) is a noteworthy building by the famous architect of Bath, John Wood (1743). Edward Colston, a revered citizen and benefactor of the city (d. 1721), is commemorated by name in several buildings and institutions, notably in Colston Hall, which is used for concerts and meetings. A bank close by St Stephen's church claims to have originated in the first savings-bank established in England (1812). Similarly, the city free library (1613) is considered to be the original of its kind. The Bristol museum and reference library were transferred to the corporation in 1893. Vincent Stuckey Lean (d. 1899) bequeathed to the corporation of Bristol the sum of £50,000 for the further development of the free libraries of the city, and with especial regard to the formation and sustenance of a general reference library of a standard and scientific character. The central library was opened in 1906. An art gallery, presented by Sir William Henry Wills, was opened in 1905.

Among educational establishments, the technical college of the Company of Merchant Venturers (1885) supplies scientific, technical and commercial education. The extensive buildings of this institution were destroyed by fire in 1906. University College (1876) forms the nucleus of the university of Bristol (chartered 1909). Clifton College, opened in 1862 and incorporated in 1877, includes a physical science school, with laboratories,

a museum and observatory. Colston's girls' day school (1891) includes domestic economy and calisthenics. Among the many charitable institutions are the general hospital, opened in 1858, and since repeatedly enlarged; royal hospital for sick children and women, Royal Victoria home, and the Queen Victoria jubilee convalescent home.

Of the open spaces in and near Bristol the most extensive are those bordering the river in the neighbourhood of the gorge, Durdham and Clifton Downs, on the Gloucestershire side (see CLIFTON). Others are Victoria Park, south of the river, near the Bedminster station, Eastville Park by the Frome, on the north-east of the city beyond Stapleton Road station, St Andrew's Park near Montpellier station to the north, and Brandon Hill, west of the cathedral, an abrupt eminence commanding a fine view over the city, and crowned with a modern tower commemorating the "fourth centenary of the discovery of America by John Cabot, and sons Lewis, Sebastian and Sanctus." Other memorials in the city are the High Cross on College Green (1850), and statues of Queen Victoria (1888), Samuel Morley (1888), Edmund Burke (1894), and Edward Colston (1895), in whose memory are held annual Colston banquets.

Harbour and Trade.—Bristol harbour was formed in 1509 by the conversion of the Avon and a branch of the Frome into "the Float," by the cutting of a new channel for the Avon and the formation of two basins. Altogether the water area, at fixed level, is about 85 acres. Four dry docks open into the floating harbour. In 1884 the Avonmouth and Portishead docks at the river entrance were bought up by the city; and the port extends from Hanham Mills on the Avon to the mouth of the river, and for some distance down the estuary of the Severn. The city docks have a depth of 22 ft., while those at Avonmouth are accessible to the largest vessels. In 1902 the construction of the extensive Royal Edward dock at Avonmouth was put in hand by the corporation, and the dock was opened by King Edward VII. in 1908. It is entered by a lock 875 ft. long and 100 ft. wide, with a depth of water on the sill of 46 ft. at ordinary spring, and 36 ft. at ordinary neap tides. The dock itself has a mean length of 1120 ft. and a breadth of 1000 ft., and there is a branch and passage connecting with the old dock. The water area is about 30 acres, and the dock is so constructed as to be easily capable of extension. Portishead dock, on the Somerset shore, has an area of 12 acres. The port has a large trade with America, the West Indies and elsewhere, the principal imports being grain, fruit, oils, ore, timber, hides, cattle and general merchandise; while the exports include machinery, manufactured oils, cotton goods, tin and salt. The Elder Dempster, Dominion and other large steamship companies trade at the port. The principal industries are shipbuilding, ropewalks, chocolate factories, sugar refineries, tobacco mills and pipe-making, glass works, potteries, soaperies, shoe factories, leather works and tanneries, chemical works, saw mills, breweries, copper, lead and shot works, iron works, machine works, stained-paper works, anchors, chain cables, sail-cloth, buttons. A coalfield extending 16 m. south-east to Radstock avails much for Bristol manufactures.

The parliamentary borough is divided into four divisions, each returning one member. The government of the city is in the hands of a lord mayor, 22 aldermen and 66 councillors. The area in 1901 was 11,705 acres; but in 1904 it was increased to 17,004 acres.

History.—Bristol (Brigstow, Bristou, Bristow, Bristole) is one of the best examples of a town that has owed its greatness entirely to trade. It was never a shire town or the site of a great religious house, and it owed little to its position as the head of a feudal lordship, or as a military post. Though it is near both British and Roman camps, there is no evidence of a British or Roman settlement. It was the western limit of the Saxon invasion of Britain, and about the year 1000 a Saxon settlement began to grow up at the junction of the rivers Frome and Avon, the natural advantages of the situation favouring the growth of the township. Bristol owed much to Danish rule, and during the reign of Canute, when the wool trade with

Ireland began, it became the market for English slaves. In the reign of Edward the Confessor the town was included in the earldom of Sweyn Godwinsson, and at the date of the Domesday survey it was already a royal borough governed by a reeve appointed by the king as overlord, the king's geld being assessed at 110 marks. There was a mint at the time of the Conquest, which proves that Bristol must have been already a place of some size, though the fact that the town was a member of the royal manor of Baston shows that its importance was still of recent growth. One-third of the geld was paid to Geoffrey de Coutances, bishop of Exeter, who threw up the earthworks of the castle. He joined in a rebellion against William II., and after his death the king granted the town and castle, as part of the honour of Gloucester, to Robert FitzHamon, whose daughter Mabel, marrying Earl Robert of Gloucester in 1119, brought him Bristol as her dowry. Earl Robert still further strengthened the castle, probably with masonry, and involved Bristol in the rebellion against Stephen. From the castle he harried the whole neighbourhood, threatened Bath, and sold his prisoners as slaves to Ireland. A contemporary chronicler describes Bristol castle as "seated on a mighty mound, and garrisoned with knights and foot soldiers or rather robbers and raiders," and he calls Bristol the stepmother of England.

The history of the charters granted to Bristol begins about this time. A charter granted by Henry II. in 1172 exempted the burgesses of Bristol from certain tolls throughout the kingdom, and confirmed existing liberties. Another charter of the same year granted the city of Dublin to the men of Bristol as a colony with the same liberties as their own town.

As a result probably of the close connexion between Bristol and Ireland the growth of the wool trade was maintained. Many Bristol men settled in Dublin, which for a long time was a Bristol beyond the seas, its charters being almost duplicates of those granted to Bristol. About this time Bristol began to export wool to the Baltic, and had developed a wine trade with the south of France, while soap-making and tanning were flourishing industries. Bristol was still organized manorially rather than municipally. Its chief courts were the weekly hundred court and the court leet held three times a year, and presided over by the reeve appointed by the earl of Gloucester. By the marriage of Earl John with the heiress of Earl William of Gloucester, Bristol became part of the royal demesne, the rent payable to the king being fixed, and the town shook off the feudal yoke. The charter granted by John in 1190 was an epoch in the history of the borough. It provided that no burgess should be impeached without the walls, that no non-burgess should sell wine, cloth, wool, leather or corn in Bristol, that all should hold by burghage tenure, that corn need not be ground at the lord's mill, and that the burgesses should have all their reasonable gilds. At some uncertain date soon after this a commune was established in Bristol on the French model, Robert FitzNichol, the first mayor of Bristol, taking the oath in 1200. The mayor was chosen, not, like the reeve whom he had displaced, by the overlord, but by the merchants of Bristol who were members of the merchant gild. The first documentary evidence of the existence of the merchant gild appears in 1242. In addition, there were many craft gilds (later at least twenty-six were known to exist), the most important being the gilds of the weavers, tuckers and fullers, and the Gild of the Kalendars of Bristol, which devoted itself to religious, educational and social work. The mayor of Bristol was helped by two assistants, who were called provosts until 1267, and from 1267 to 1311 were known as stewards, and after that date as bailiffs. Before this time many religious houses had been founded. Earl Robert of Gloucester established the Benedictine priory of St James; there were Dominican and Franciscan priories, a monastery of Carmelites, and an abbey of St Augustine founded by Robert FitzHardinge.

In the reign of John, Bristol began the struggle to absorb the neighbouring manor of Bedminster, the eastern half of which was held by the Templars by gift of Earl Robert of Gloucester, and the western half, known as Redcliffe, was sold by the same earl to Robert FitzHardinge, afterwards Lord Berkeley. The

Templars acquiesced without much difficulty, but the wealthy owners of the manor of Redcliffe, who had their own manorial courts, market, fair and quay, resisted the union for nearly one hundred years. In 1247 a new course was cut for the river Frome which vastly improved the harbour, and in the same year a stone bridge was built over the Avon, bringing Temple and Redcliffe into closer touch with the city. The charter granted by Henry III. in 1256 was important. It gave the burgesses the right to choose coroners, and as they already farmed the geld payable to the king, Bristol must have been practically independent of the king. The growing exclusiveness of the merchant gild led to the great insurrection of 1312. The oligarchical party was supported by the Berkeleys, but the opposition continued their rebellion until 1313, when the town was besieged and taken by the royal forces. During the reign of Edward III, cloth manufacture developed in Bristol. Thomas Blanket set up looms in 1337, employing many foreign workmen, and in 1353 Bristol was made one of the Staple towns, the office of mayor of the staple being held by the mayor of the town.

The charter of 1373 extended the boundaries of the town to include Redcliffe (thus settling the long-standing dispute) and the waters of the Avon and Severn up to the Steep and Flat Holmes; and made Bristol a county in itself, independent of the county courts, with an elected sheriff, and a council of forty to be chosen by the mayor and sheriff. The town was divided into five wards, each represented by an alderman, the aldermen alone being eligible for the mayoralty. This charter (confirmed in 1377 and 1488) was followed by the period of Bristol's greatest prosperity, the era of William Canyng, of the foundation of the Society of Merchant Venturers, and of the voyages of John and Sebastian Cabot. William Canyng (1399-1474) was five times mayor and twice represented Bristol in parliament; he carried on a huge cloth trade with the Baltic and rebuilt St Mary Redcliffe. At the same time cloth was exported by Bristol merchants to France, Spain and the Levant. The records of the Society of Merchant Venturers began in 1467, and the society increased in influence so rapidly that in 1500 it directed all the foreign trade of the city and had a lease of the port dues. It was incorporated in 1552, and received other charters in 1638 and 1662. Henry VII. granted Bristol a charter in 1490 (confirmed in 1510) which removed the theoretically popular basis of the corporation by the provision that the aldermen were to be elected by the mayor and council. At the dissolution of the monasteries the diocese of Bristol was founded, which included the counties of Bristol and Dorset. The voyages of discovery in which Bristol had played a conspicuous part led to a further trade development. In the 16th century Bristol traded with Spain, the Canaries and the Spanish colonies in America, shared in the attempt to colonize Newfoundland, and began the trade in African slaves which flourished during the 17th century. Bristol took a great share in the Civil War and was three times besieged. Charles II. granted a formal charter of incorporation in 1664, the governing body being the mayor, 12 aldermen, 30 common councilmen, 2 sheriffs, 2 coroners, a town clerk, clerk of the peace and 39 minor officials, the governing body itself filling up all vacancies in its number. In the 18th century the cloth trade declined owing to the competition of Ireland and to the general migration of manufactures to the northern coalfields, but the prosperity of the city was maintained by the introduction of manufactures of iron, brass, tin and copper, and by the flourishing West Indian trade, sugar being taken in exchange for African slaves.

The hot wells became fashionable in the reign of Anne (who granted a charter in 1710), and a little later Bristol was the centre of the Methodist revival of Whitefield and Wesley. The city was small, densely populated and dirty, with dark, narrow streets, and the mob gained an unenviable notoriety for violence in the riots of 1708, 1753, 1767 and 1831. At the beginning of the 19th century it was obvious that the prosperity of Bristol was diminishing, comparatively if not actually, owing to (1) the rise of Liverpool, which had more natural facilities as a port than Bristol could offer, (2) the abolition of the slave trade,

which ruined the West Indian sugar trade, and (3) the extortionate rates levied by the Bristol Dock Company, incorporated in 1803. These rates made competition with Liverpool and London impossible, while other tolls were levied by the Merchant Venturers and the corporation. The decline was checked by the efforts of the Bristol chamber of commerce (founded in 1823) and by the Municipal Reform Act of 1835. The new corporation, consisting of 48 councillors and 16 aldermen who elected the mayor, being themselves chosen by the burgesses of each ward, bought the docks in 1848 and reduced the fees. In 1877-1880 the docks at the mouth of the river at Avonmouth and Portishead were made, and these were bought by the corporation in 1884. A revival of trade, rapid increase of population and enlargement of the boundaries of the city followed. The chief magistrate became a lord mayor in 1899.

See J. Corry, *History of Bristol* (Bristol, 1816); J. Wallaway, *Antiquities* (1834); J. Evans, *Chronological History of Bristol* (1821); *Bristol vol. of Brit. Archaeol. Inst.*; J. F. Nicholl and J. Taylor, *Bristol Past and Present* (Bristol and London, 1882); W. Hunt, *Bristol*, in "Historic Towns" series (London, 1887); J. Latimer, *Annals of Bristol* (various periods); G. E. Weare, *Collectanea relating to the Bristol Friars* (Bristol, 1803); Samuel Seyer, *History of Bristol and Bristol Charters* (1812); *The Little Red Book of Bristol* (1900); *The Mayor's Kalendar* (Camden Soc., 1872); *Victoria County History, Gloucester*.

BRISTOL, a borough of Bucks county, Pennsylvania, U.S.A., on the Delaware river, opposite Burlington, New Jersey, 20 m. N.E. of Philadelphia. Pop. (1890) 6553; (1900) 7104 (1134 foreign-born); (1910) 9256. It is served by the Pennsylvania railway. The borough is built on level ground elevated several feet above the river, and in the midst of an attractive farming country. The principal business houses are on Mill Street; while Radcliffe Street extends along the river. Among Bristol's manufacturing establishments are machine shops, rolling mills, a planing mill, yarn, hosiery and worsted mills, and factories for making carpets, wall paper and patent leather. Bath Springs are located just outside the borough limits; though not so famous as they were early in the 18th century, these springs are still well known for the medicinal properties of their chalybeate waters. Bristol was one of the first places to be settled in Pennsylvania after William Penn received his charter for the province in 1681, and from its settlement until 1725 it was the seat of government of the county. It was laid out in 1697 and was incorporated as a borough in 1720; the present charter, however, dates only from 1851.

BRISTOL, the shire-township of Bristol county, Rhode Island, U.S.A., about 15 m. S.S.E. of Providence, between Narragansett Bay on the W. and Mount Hope Bay on the E., thus being a peninsula. Pop. (1900) 6901, of whom 1923 were foreign-born; (1905; state census) 7512; (1910) 8565; area 12 sq. m. It is served by the New York, New Haven & Hartford, and the Rhode Island Suburban railways, and is connected with the island of Rhode Island by ferry. Mount Hope (216 ft.), on the eastern side, commands delightful views of landscape, bay and river scenery. Elsewhere in the township the surface is gently undulating and generally well adapted to agriculture, especially to the growing of onions. A small island, Hog Island, is included in the township. The principal village, also known as Bristol, is a port of entry with a capacious and deep harbour, has manufacturing of rubber and woollen goods, and is well known as a yacht-building centre, several defenders of the America's Cup, including the "Columbia" and the "Reliance," having been built in the Herreshoff yards here. At the close of King Philip's War in 1676, Mount Hope Neck (which had been the seat of the vanquished sachem), with most of what is now the township of Bristol, was awarded to Plymouth Colony. In 1680, immediately after Plymouth had conveyed the "Neck" to a company of four, the village was laid out; the following year, in anticipation of future commercial importance, the township and the village were named Bristol, from the town in England. The township became the shire-township in 1685, passed under the jurisdiction of Massachusetts in 1692, and in 1747 was annexed to Rhode Island. During the War of Independence the village was bombarded by the British on the 7th of October 1775, but

suffered little damage; on the 25th of May 1778 it was visited and partially destroyed by a British force.

BRISTOL, a city of Sullivan county, Tennessee, and Washington county, Virginia, U.S.A., 130 m. N.E. of Knoxville, Tennessee, at an altitude of about 1700 ft. Pop. (1880) 3200; (1890) 6226; (1900) 9850 (including 1981 negroes); (1910) 13,305, of whom 7148 were in Tennessee and 6247 were in Virginia. Bristol is served by the Holston Valley, the Southern, the Virginia & South-Western, and the Norfolk & Western railways, and is a railway centre of some importance. It is near the great mineral deposits of Virginia, Tennessee, West Virginia, Kentucky and North Carolina; an important distributing point for iron, coal and coke; and has tanneries and lumber mills, iron furnaces, tobacco factories, furniture factories and packing houses. It is the seat of Sullins College (Methodist Episcopal, South; 1879) for women, and of the Virginia Institute for Women (Baptist, 1884), both in the state of Virginia, and of a normal college for negroes, on the Tennessee side of the state line. The Tennessee-Virginia boundary line runs through the principal street, dividing the place into two separate corporations, the Virginia part, which before 1890 (when it was chartered as a city) was known as Goodson, being administratively independent of the county in which it is situated. Bristol was settled about 1835, and the town of Bristol, Tennessee, was first incorporated in 1856.

BRISTOW, BENJAMIN HELM (1832-1896), American lawyer and politician, was born in Elkton, Kentucky, on the 20th of June 1832, the son of Francis Marion Bristow (1804-1864), a Whig member of Congress in 1854-1855 and 1859-1861. He graduated at Jefferson College, Canonsburg, Pennsylvania, in 1851, studied law under his father, and was admitted to the Kentucky bar in 1853. At the beginning of the Civil War he became lieutenant-colonel of the 25th Kentucky Infantry; was severely wounded at Shiloh; helped to recruit the 8th Kentucky Cavalry, of which he was lieutenant-colonel and later colonel; and assisted at the capture of John H. Morgan in July 1863. In 1863-1865 he was state senator; in 1865-1866 assistant United States district-attorney, and in 1866-1870 district-attorney for the Louisville district; and in 1870-1872, after a few months' practice of law with John M. Harlan, was the (first appointed) solicitor-general of the United States. In 1873 President Grant nominated him attorney-general of the United States in case George H. Williams were confirmed as chief justice of the United States,—a contingency which did not arise. As secretary of the treasury (1874-1876) he prosecuted with vigour the so-called "Whisky Ring," the headquarters of which was at St. Louis; and which, beginning in 1870 or 1871, had defrauded the Federal government out of a large part of its rightful revenue from the distillation of whisky. Distillers and revenue officers in St. Louis, Milwaukee, Cincinnati and other cities were implicated, and the illicit gains—which in St. Louis alone probably amounted to more than \$2,500,000 in the six years 1870-1876—were divided between the distillers and the revenue officers, who levied assessments on distillers ostensibly for a Republican campaign fund to be used in furthering Grant's re-election. Prominent among the ring's alleged accomplices at Washington was Orville E. Babcock, private secretary to President Grant, whose personal friendship for Babcock led him to indiscreet interference in the prosecution. Through Bristow's efforts more than 200 men were indicted, a number of whom were convicted, but after some months' imprisonment were pardoned. Largely owing to friction between himself and the president, Bristow resigned his portfolio in June 1876; as secretary of the treasury he advocated the resumption of specie payments and at least a partial retirement of "greenbacks"; and he was also an advocate of civil service reform. He was a prominent candidate for the Republican presidential nomination in 1876. After 1878 he practised law in New York City, where he died on the 22nd of June 1896.

See *Memorial of Benjamin Helm Bristow*, largely prepared by David Willcox (Cambridge, Mass., privately printed, 1897); *Whisky Fraud*, 44th Cong., 1st Sess., Misc. Doc. No. 186; *Secrets of the Great Whisky Ring* (Chicago, 1880), by John McDonald, who for nearly six years had been supervisor of internal revenue at St. Louis,—a book by one concerned and to be considered in that light.

BRISTOW, HENRY WILLIAM (1817-1889), English geologist, son of Major-General H. Bristow, who served in the Peninsular War, was born on the 17th of May 1817. He was educated at King's College, London, under John Phillips; then professor of geology. In 1842 he was appointed assistant geologist on the Geological Survey, and in that service he remained for forty-six years, becoming director for England and Wales in 1872, and retiring in 1888. He was elected F.R.S. in 1862. He died in London on the 14th of June 1889. His publications (see *Geol. Mag.*, 1889, p. 384) include *A Glossary of Mineralogy* (1861) and *The Geology of the Isle of Wight* (1862).

BRITAIN (Gr. *Ἰππεραννάς νῆσος*, *Ἰππεραννάς*; Lat. *Britannia*, rarely *Britannia*), the anglicized form of the classical name of England, Wales and Scotland, sometimes extended to the British Isles as a whole (*Britannicæ Insulæ*). The Greek and Roman forms are doubtless attempts to reproduce a Celtic original, the exact form of which is still matter of dispute. *Brittania* (Fr. *Bretagne*) in western France derived its name from Britain owing to migrations in the 5th and 6th century A.D. The personification of Britannia as a female figure may be traced back as far as the coins of Hadrian and Antoninus Pius (early 2nd century A.D.); its first appearance on modern coins is on the copper of Charles II. (see NUMISMATICS).

In what follows, the archaeological interest of early Britain is dealt with, in connexion with the history of Britain in Pre-Roman, Roman, and Anglo-Saxon days; this account being supplementary to the articles ENGLAND; ENGLISH HISTORY; SCOTLAND, &c.

PRE-ROMAN BRITAIN

Geologists are not yet agreed when and by whom Britain was first peopled. Probably the island was invaded by a succession of races. The first, the Paleolithic men, may have died out or retired before successors arrived. During the Neolithic and Bronze Ages we can dimly trace further immigrations. Real knowledge begins with two Celtic invasions, that of the Goidels in the later part of the Bronze Age, and that of the Brythons and Belgæ in the Iron Age. These invaders brought Celtic civilization and dialects. It is uncertain how far they were themselves Celtic in blood and how far they were numerous enough to absorb or obliterate the races which they found in Britain. But it is not unreasonable to think that they were no mere conquering caste, and that they were of the same race as the Celtic-speaking peoples of the western continent. By the age of Julius Cæsar all the inhabitants of Britain, except perhaps some tribes of the far north, were Celts in speech and customs. Politically they were divided into separate and generally warring tribes, each under its own princes. They dwelt in hill forts with walls of earth or rude stone, or in villages of round huts sunk into the ground and resembling those found in parts of northern Gaul, or in subterranean chambered houses, or in hamlets of pile-dwellings constructed among the marshes. But, at least in the south, market centres had sprung up, town life was beginning, houses of a better type were perhaps coming into use, and the southern tribes employed a gold coinage and also a currency of iron bars or ingots, attested by Cæsar and by surviving examples, which weigh roughly, some two-thirds of a pound, some 2½ lb, but mostly 1½ lb. In religion, the chief feature was the priesthood of Druids, who here, as in Gaul, practised magical arts and barbarous rites of human sacrifice, taught a secret lore, wielded great influence, but, at least as Druids, took ordinarily no part in politics. In art, these tribes possessed a native Late Celtic fashion, descended from far-off Mediterranean antecedents and more directly connected with the La-Tène culture of the continental Celts. Its characteristics were a flamboyant and fantastic treatment of plant and animal (though not of human) forms, a free use of the geometrical device called the "returning spiral," and much skill in enamelling. Its finest products were in bronze, but the artistic impulse spread to humbler work in wood and pottery. The late Celtic age was one which genuinely delighted in beauty of form and detail. In this it resembled the middle ages rather than the Roman empire or the present day, and it resembled

them all the more in that its love of beauty, like theirs, was mixed with a feeling for the fantastic and the grotesque. The Roman conquest of northern Gaul (57-50 B.C.) brought Britain into definite relation with the Mediterranean. It was already closely connected with Gaul, and when Roman civilization and its products invaded Gallia Belgica, they passed on easily to Britain. The British coinage now begins to bear Roman legends, and after Cæsar's two raids (55, 54 B.C.) the southern tribes were regarded at Rome, though they do not seem to have regarded themselves, as vassals. Actual conquest was, however, delayed. Augustus planned it. But both he and his successor Tiberius realized that the greater need was to consolidate the existing empire, and absorb the vast additions recently made to it by Pompey, Cæsar and Augustus.

ROMAN BRITAIN

I. The Roman Conquest.—The conquest of Britain was undertaken by Claudius in A.D. 43. Two causes coincided to produce the step. On the one hand a forward policy then ruled at Rome, leading to annexations in various lands. On the other hand, a probably philo-Roman prince, Cunobelin (known to literature as Cymbeline), had just been succeeded by two sons, Caractacus (*q.v.*) and Togodumnus, who were hostile to Rome. Calgula, the half-insane predecessor of Claudius, had made in respect to this event some blunder which we know only through a sensational exaggeration, but which doubtless had to be made good. An immediate reason for action was the appeal of a fugitive British prince, presumably a Roman partisan and victim of Cunobelin's sons. So Aulus Plautius with a singularly well equipped army of some 40,000 men landed in Kent and advanced on London. Here Claudius himself appeared—the one reigning emperor of the 1st century who crossed the waves of ocean,—and the army, crossing the Thames, moved forward through Essex and captured the native capital, Camulodunum, now Colchester. From the base of London and Colchester three corps continued the conquest. The left wing, the Second Legion (under Vespasian, afterwards emperor), subdued the south; the centre, the Fourteenth and Twentieth Legions, subdued the midlands, while the right wing, the Ninth Legion, advanced through the eastern part of the island. This strategy was at first triumphant. The lowlands of Britain, with their partly Romanized and partly scanty population and their easy physical features, presented no obstacle. Within three or four years everything south of the Humber and east of the Severn had been either directly annexed or entrusted, as protectorates, to native client-princes.

A more difficult task remained. The wild hills and wider tribes of Wales and Yorkshire offered far fiercer resistance. There followed thirty years of intermittent hill fighting (A.D. 47-79). The precise steps of the conquest are not known. Legionary fortresses were established at Wroxeter (for a time only), Chester and Caerleon, facing the Welsh hills, and at Lincoln in the north-east. Monmouthshire, and Flintshire with its lead mines, were early overrun; in 60 Suetonius Paulinus reached Anglesea. The method of conquest was the establishment of small detached forts in strategic positions, each garrisoned by 500 or 1000 men, and it was accompanied by a full share of those disasters which vigorous barbarians always inflict on civilized invaders. Progress was delayed too by the great revolt of Boadicea (*q.v.*) and a large part of the nominally conquered Lowlands. Her rising was soon crushed, but the government was obviously afraid for a while to move its garrisons forward. Indeed, other needs of the empire caused the withdrawal of the Fourteenth Legion about 67. But the decade A.D. 70-80 was decisive. A series of three able generals commanded an army restored to its proper strength by the addition of Legio II. Adiutrix, and achieved the final subjugation of Wales and the first conquest of Yorkshire, where a legionary fortress at York was substituted for that at Lincoln.

The third and best-known, if not the ablest, of these generals, Julius Agricola, moved on in A.D. 80 to the conquest of the farther north. He established between the Clyde and Forth a frontier meant to be permanent, guarded by a line of forts,

two of which are still traceable at Camelon near Falkirk, and at Bar Hill. He then advanced into Caledonia and won a "famous victory" at Mons Graupius (sometimes, but incorrectly, spelt Grampius), probably near the confluence of the Tay and the Isla, where a Roman encampment of his date, Inchtuthill, has been partly examined (see GALGACUS). He dreamt even of invading Ireland, and thought it an easy task. The home government judged otherwise. Jealous possibly of a too brilliant general, certainly averse from costly and fruitless campaigns and needing the Legio II. Adiutrix for work elsewhere, it recalled both governor and legion, and gave up the more northerly of his nominal conquests. The most solid result of his campaigns is that his battlefield, misspelt Grampius, has provided to antiquaries, and through them to the world, the modern name of the Grampian Hills.

What frontier was adopted after Agricola's departure, whether Tweed or Cheviot or other, is unknown. For thirty years (A.D. 85-115) the military history of Britain is a blank. When we recover knowledge we are in an altered world. About 115 or 120 the northern Britons rose in revolt and destroyed the Ninth Legion, posted at York, which would bear the brunt of any northern trouble. In 122 the second reigning emperor who crossed the ocean, Hadrian, came himself to Britain, brought the Sixth Legion to replace the Ninth, and introduced the frontier policy of his age. For over 70 m. from Tyne to Solway, more exactly from Wallsend to Bowness, he built a continuous rampart, more probably of turf than of stone, with a ditch in front of it, a number of small forts along it, one or two outposts a few miles to the north of it, and some detached forts (the best-known is on the hill above Maryport) guarding the Cumberland coast beyond its western end. The details of his work are imperfectly known, for though many remains survive, it is hard to separate those of Hadrian's date from others that are later. But that Hadrian built a wall here is proved alike by literature and by inscriptions. The meaning of the scheme is equally certain. It was to be, as it were, a Chinese wall, marking the definite limit of the Roman world. It was now declared, not by the secret resolutions of cabinets, but by the work of the spade marking the solid earth for ever, that the era of conquest was ended.

But empires move, though rulers bid them stand still. Whether the land beyond Hadrian's wall became temptingly peaceful or remained in vexing disorder, our authorities do not say. We know only that about 142 Hadrian's successor, Antoninus Pius, acting through his general Lollius Urbicus, advanced from the Tyne and Solway frontier to the narrower isthmus between Forth and Clyde, 36 m. across, which Agricola had fortified before him. Here he reared a continuous rampart with a ditch in front of it, fair-sized forts, probably a dozen in number, built either close behind it or actually abutting on it, and a connecting road running from end to end. An ancient writer states that the rampart was built of regularly laid sods (the same method which had probably been employed by Hadrian), and excavations in 1891-1893 have verified the statement. The work still survives visibly, though in varying preservation, except in the agricultural districts near its two ends. Occasionally, as on Croyhill (near Kilsyth), at Westerwood, and in the covers of Bonny-side (3 m. west of Falkirk), wall and ditch and even road can be distinctly traced, and the sites of many of the forts are plain to practised eyes. Three of these forts have been excavated. All three show the ordinary features of Roman *castella*, though they differ more than one would expect in forts built at one time by one general. Bar Hill, the most completely explored, covers three acres—nearly five times as much as the earlier fort of Agricola on the same site. It had ramparts of turf, barrack-rooms of wood, and a headquarters building, storehouse and bath in stone: it stands a few yards back from the wall. Castle Cary covers nearly four acres: its ramparts contain massive and well-dressed masonry; its interior buildings, though they agree in material, do not altogether agree in plan with those of Bar Hill, and its north face falls in line with the frontier wall. Rough Castle, near Falkirk, is very much smaller; it is remarkable for the astonishing

strength of its turf-built and earthen ramparts and ravelins, and for a remarkable series of defensive pits, reminiscent of Caesar's *lilia* at Alesia, plainly intended to break an enemy's charge, and either provided with stakes to impale the assailant or covered over with hurdles or the like to deceive him. Besides the dozen forts on the wall, one or two outposts may have been held at Ardoch and Abernethy along the natural route which runs by Stirling and Perth to the lowlands of the east coast. This frontier was reached from the south by two roads. One, known in medieval times as Dere Street and misnamed Watling Street by modern antiquaries, ran from Corbridge on the Tyne past Otterburn, crossed Cheviot near Makendon Camps, and passed by an important fort at Newstead near Melrose, and another at Inveresk (outside of Edinburgh), to the eastern end of the wall. The other, starting from Carlisle, ran to Birrens, a Roman fort near Ecclefechan, and thence, by a line not yet explored and indeed not at all certain, to Carstairs and the west end of the wall. This wall was in addition to, and not instead of, the wall of Hadrian. Both barriers were held together, and the district between them was regarded as a military area, outside the range of civilization.

The work of Pius brought no long peace. Sixteen years later disorder broke out in north Britain, apparently in the district between the Cheviots and the Derbyshire hills, and was repressed with difficulty after four or five years' fighting. Eighteen or twenty years later (180-185) a new war broke out with a different issue. The Romans lost everything beyond Cheviot, and perhaps even more. The government of Commodus, feeble in itself and vexed by many troubles, could not repair the loss, and the civil wars which soon raged in Europe (193-197) gave the Caledonians further chance. It was not till 208 that Septimius Severus, the ablest emperor of his age, could turn his attention to the island. He came thither in person, invaded Caledonia, commenced the reconstruction of the wall of Hadrian, rebuilding it from end to end in stone, and then in the fourth year of his operations died at York. Amid much that is uncertain and even legendary about his work in Britain, this is plain, that he fixed on the line of Hadrian's wall as his substantive frontier. His successors, Caracalla and Severus Alexander (211-235), accepted the position, and many inscriptions refer to building or rebuilding executed by them for the greater efficiency of the frontier defences. The conquest of Britain was at last over. The wall of Hadrian remained for nearly two hundred years more the northern limit of Roman power in the extreme west.

II. *The Province of Britain and its Military System.*—Geographically, Britain consists of two parts: (1) the comparatively flat lowlands of the south, east and midlands, suitable to agriculture and open to easy intercourse with the continent, i.e. with the rest of the Roman empire; (2) the district consisting of the hills of Devon and Cornwall, of Wales and of northern England, regions lying more, and often very much more, than 600 ft. above the sea, scarred with gorges and deep valleys, mountainous in character, difficult for armies to traverse, ill fitted to the peaceful pursuits in agriculture. These two parts of the province differ also in their history. The lowlands, as we have seen, were conquered easily and quickly. The uplands were hardly subdued completely till the end of the 2nd century. They differ, thirdly, in the character of their Roman occupation. The lowlands were the scene of civil life. Towns, villages and country houses were their prominent features; troops were hardly seen in them save in some fortresses on the edge of the hills and in a chain of forts built in the 4th century to defend the south-east coast, the so-called Saxon Shore. The uplands of Wales and the north presented another spectacle. Here civil life was almost wholly absent. No country town or country house has been found more than 20 m. north of York or west of Monmouthshire. The hills were one extensive military frontier, covered with forts and strategic roads connecting them, and devoid of town life, country houses, farms or peaceful civilized industry. This geographical division was not reproduced by Rome in any administrative partitions of the province. At first the whole was governed by one *legatus Augusti* of consular standing.



Septimius Severus made it two provinces, Superior and Inferior, with a boundary which probably ran from Humber to Mersey, but we do not know how long this arrangement lasted. In the 5th century there were five provinces, Britannia Prima and Secunda, Flavia and Maxima Caesariensis and (for a while) Valentia, ruled by *praesides* and *consulares* under a *vicarius*, but the only thing known of them is that Britannia Prima included Cirencester.

The army which guarded or coerced the province consisted, from the time of Hadrian onwards, of (1) three legions, the Second at Ica Silurum (Caerleon-on-Usk, *q.s.*), the Ninth at Eburacum (*q.s.*; now York), the Twentieth at Deva (*q.s.*; now Chester), a total of some 15,000 heavy infantry; and (2) a large but uncertain number of auxiliaries, troops of the second grade, organized in infantry cohorts or cavalry *alae*, each 500 or 1000 strong, and posted in *castella* nearer the frontiers than the legions. The legionary fortresses were large rectangular

others, principally (it seems) forts built before 150, wood is used freely and only the few principal buildings seem to have been constructed throughout of stone.

We may illustrate their character from Housesteads, which, in the form in which we know it, perhaps dates from Septimius Severus. This fort measures about 360 by 600 ft. and covers a trifle less than 5 acres. Its ramparts or the great wall of Hadrian. Its interior is filled with stone buildings. Chief among these (see fig. 1), and in the centre of the whole fort, is the Headquarters, in Lat. *Principia* or, as it is often (though perhaps less correctly) styled by moderns, *Prætorium*. This is a rectangular structure with only one entrance which gives access, first, to a small cloistered court (x. 4), then to a second open court (x. 7), and finally to a row of five rooms (x. 8-12) containing the shrine for official worship, the treasury and other offices. Close by were officers' quarters, generally built round a tiny cloistered court (ix., xi., xii.),

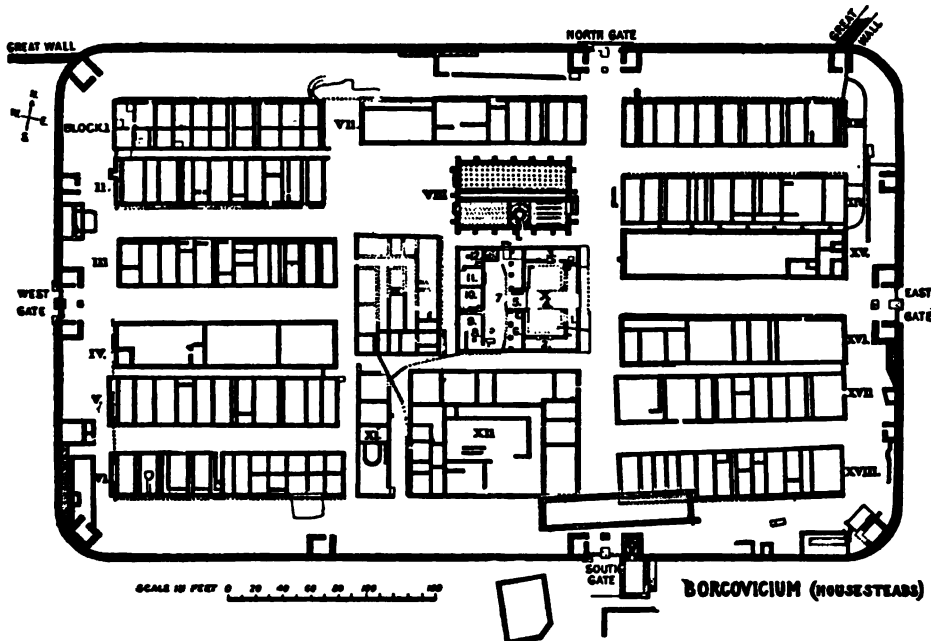

FIG. 1.—Plan of Housesteads (Borcovium) on Hadrian's Wall.

enclosures of 50 or 60 acres, surrounded by strong walls of which traces can still be seen in the lower courses of the north and east town-walls of Chester, in the abbey gardens at York, and on the south side of Caerleon. The auxiliary *castella* were hardly a tenth of the size, varying generally from three to six acres according to the size of the regiment and the need for stabling. Of these upwards of 70 are known in England and some 20 more in Scotland. Of the English examples a few have been carefully excavated, notably Gellygaer between Cardiff and Brecon, one of the most perfect specimens to be found anywhere in the Roman empire of a Roman fort dating from the end of the 1st century A.D.; Hardknott, on a Cumberland moor overhanging Upper Eskdale; and Housesteads on Hadrian's wall. In Scotland excavation has been more active, in particular at the forts of Birrens, Newstead near Melrose, Lyne near Peebles, Ardoch between Stirling and Perth, and Castle Cary, Rough Castle and Bar Hill on the wall of Pius. The internal arrangements of all these forts follow one general plan. But in some of them the internal buildings are all of stone, while in

and substantially built storehouses with buttresses and dry basements (viii.). These filled the middle third of the fort. At the two ends were barracks for the soldiers (i.-vi., xiii.-xviii.). No space was allotted to private religion or domestic life. The shrines which voluntary worshippers might visit, the public bath-house, and the cottages of the soldiers' wives, camp followers, &c., lay outside the walls. Such were nearly all the Roman forts in Britain. They differ somewhat from Roman forts in Germany or other provinces, though most of the differences arise from the different usage of wood and of stone in various places.

Forts of this kind were dotted all along the military roads of the Welsh and northern hill-districts. In Wales a road ran from Chester past a fort at Caer-hyn (near Conway) to a fort at Carnarvon (Segontium). A similar road ran along the south coast from Caerleon-on-Usk past a fort at Cardiff and perhaps others, to Carmarthen. A third, roughly parallel to the shore of Cardigan Bay, with forts at Llanio and Tommen-y-mur (near Festiniog), connected the northern and southern roads, while

the interior was held by a system of roads and forts not yet well understood but discernible at such points as Caer-gai on Bala Lake, Castle Collen near Llandrindod Wells, the Gaer near Brecon, Merthyr and Gellygaer. In the north of Britain we find three principal roads. One led due north from York past forts at Catterick Bridge, Piers Bridge, Binchester, Lanchester, Ebchester to the wall and to Scotland, while branches through Chester-le-Street reached the Tyne Bridge (Pons Aelius) at Newcastle and the Tyne mouth at South Shields. A second road, turning north-west from Catterick Bridge, mounted the Pennine Chain by way of forts at Rokeby, Bowes and Brough-under-Stainmoor, descended into the Eden valley, reached Hadrian's wall near Carlisle (Luguvallium), and passed on to Birrens. The third route, starting from Chester and passing up the western coast, is more complex, and exists in duplicate, the result perhaps of two different schemes of road-making. Forts in plenty can be detected along it, notably Manchester (Mancunium or Mamucium), Ribchester (Bremetannacum), Brougham Castle (Brocavum), Old Penrith (Voreda), and on a western branch, Watercrook near Kendal, Waterhead near the hotel of that name on Ambleside, Hardknott above Eskdale, Maryport (Uxelodūnum), and Old Carlisle (possibly Petriana). In addition, two or three cross roads, not yet sufficiently explored, maintained communication between the troops in Yorkshire and those in Cheshire and Lancashire. This road system bears plain marks of having been made at different times, and with different objectives, but we have no evidence that any one part was abandoned when any other was built. There are signs, however, that various forts were dismantled as the country grew quieter. Thus, Gellygaer in South Wales and Hardknott in Cumberland have yielded nothing later than the opening of the 2nd century.

Besides these detached forts and their connecting roads, the north of Britain was defended by Hadrian's wall (figs. 2 and 3). The history of this wall has been given above. The actual works are threefold. First, there is that which to-day forms the most striking feature in the whole, the wall of stone 6-8 ft. thick, and originally perhaps 14 ft. high, with a deep ditch in front, and forts and "mile castles" and turrets and a connecting road behind it. On the high moors between Chollerford and Gilsland its traces are still plain, as it climbs from hill to hill and winds along perilous precipices. Secondly, there is the so-called "Vallum," in reality no *vallum* at all, but a broad flat-bottomed ditch out of which the earth has been cast up on either side into

turf and Severus reconstructed it in stone. The reconstruction probably followed in general the line of Hadrian's wall in order to utilize the existing ditch, and this explains why the turf wall itself survives only at special points. In general it was destroyed to make way for the new wall in stone. Occasionally (as at Birdoswald) there was a deviation, and the older work survived.

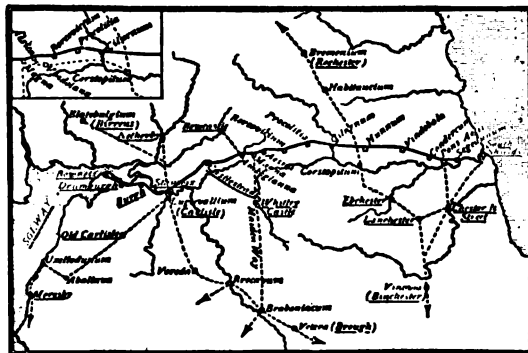

FIG. 3.—Section of Hadrian's Wall.

This conversion of earthwork into stone in the age of Severus can be paralleled from other parts of the Roman empire.

The meaning of the *vallum* is much more doubtful. John Hodgson and Bruce, the local authorities of the 19th century, supposed that it was erected to defend the wall from southern insurgents. Others have ascribed it to Agricola, or have thought it to be the wall of Hadrian, or even assigned it to pre-Roman natives. The two facts that are clear about it are, that it is a Roman work, no older than Hadrian (if so old), and that it was not intended, like the wall, for military defence. Probably it is contemporaneous with either the turf wall or the stone wall, and marked some limit of the civil province of Britain. Beyond this we cannot at present go.

III. *The Civilization of Roman Britain.*—Behind these formidable garrisons, sheltered from barbarians and in easy contact with the Roman empire, stretched the lowlands of southern and eastern Britain. Here a civilized life grew up, and Roman culture spread. This part of Britain became Romanized. In the lands looking on to the Thames estuary (Kent, Essex, Middlesex) the process had perhaps begun before the Roman conquest. It was continued after that event, and in two ways. To some extent it was definitely encouraged by the Roman government, which here, as elsewhere, founded towns peopled with Roman citizens—generally discharged legionaries—and endowed them with franchise and constitution like those of the Italian municipalities. It developed still more by its own automatic growth. The coherent civilization of the Romans was accepted by the Britons, as it was by the Gauls, with something like enthusiasm. Encouraged perhaps by sympathetic Romans, spurred on still more by their own instincts, and led no doubt by their nobles, they began to speak Latin, to use the material resources of Roman civilized life, and in time to consider themselves not the unwilling subjects of a foreign empire, but the British members of the Roman state. The steps by which these results were reached can to some extent be dated. Within a few years of the Claudian invasion a *colonia*, or municipality of time-expired soldiers, had been planted in the old native capital of Colchester (Camulodūnum), and though it served at first mainly as a fortress and thus provoked British hatred, it came soon to exercise a civilizing influence. At the same time the British town of Verulamium (St Albans) was thought sufficiently Romanized to deserve the municipal status of a *municipium*, which at this period differed little from that of a *colonia*. Romanized Britons must now have begun to be numerous. In the great revolt of Boadicea (60) the nationalist party seem to have massacred many thousands of them along with actual Romans. Fifteen or twenty years later, the movement increases. Towns spring up, such as Silchester, laid out in Roman fashion, furnished with public buildings of Roman type, and filled with houses which are Roman in fittings if not in plan. The baths of Bath (Aquæ Sulis) are exploited. Another *colonia* is planted at Lincoln (Lindum), and a third at Gloucester (Glevum) in 96. A new "chief judge" is appointed for increasing civil business. The tax-gatherer and recruiting officer begin to make their way into the hills. During the 2nd century progress was perhaps slower, hindered doubtless by the repeated risings in the north. It was not till the 3rd century that country houses and farms became common in most parts of the civilized area. In the beginning of the



From *Social England*, by permission of Cassell & Co., Ltd.

FIG. 2.—Hadrian's Wall.

regular and continuous mounds that resemble ramparts. Thirdly, nowhere very clear on the surface and as yet detected only at a few points, there are the remains of the "turf wall," constructed of sods laid in regular courses, with a ditch in front. This turf wall is certainly older than the stone wall, and, as our ancient writers mention two wall-builders, Hadrian and Septimius Severus, the natural inference is that Hadrian built his wall of

Gloucester (Glevum) in 96. A new "chief judge" is appointed for increasing civil business. The tax-gatherer and recruiting officer begin to make their way into the hills. During the 2nd century progress was perhaps slower, hindered doubtless by the repeated risings in the north. It was not till the 3rd century that country houses and farms became common in most parts of the civilized area. In the beginning of the

4th century the skilled artisans and builders, and the cloth and corp of Britain were equally famous on the continent. This probably was the age when the prosperity and Romanization of the province reached its height. By this time the town populations and the educated among the country-folk spoke Latin, and Britain regarded itself as a Roman land, inhabited by Romans and distinct from outer barbarians.

The civilization which had thus spread over half the island was genuinely Roman, identical in kind with that of the other western provinces of the empire, and in particular with that of northern Gaul. But it was defective in quantity. The elements which compose it are marked by smaller size, less wealth and less splendour than the same elements elsewhere. It was also uneven in its distribution. Large tracts, in particular Warwickshire and the adjoining midlands, were very thinly inhabited. Even densely peopled areas like north Kent, the Sussex coast, west Gloucestershire and east Somerset, immediately adjoin areas like the Weald of Kent and Sussex where Romano-British remains hardly occur.

The administration of the civilized part of the province, while subject to the governor of all Britain, was practically entrusted to local authorities. Each Roman municipality ruled itself and a territory perhaps as large as a small county which belonged to it. Some districts belonged to the Imperial Domains, and were administered by agents of the emperor. The rest, by far the larger part of the country, was divided up among the old native tribes or cantons, some ten or twelve in number, each grouped round some country town where its council (*ordo*) met for cantonal business. This cantonal system closely resembles that which we find in Gaul. It is an old native element recast in Roman form, and well illustrates the Roman principle of local government by devolution.

In the general framework of Romano-British life the two chief features were the town, and the *villa*. The towns of the province, as we have already implied, fall into two classes. Five modern cities, Colchester, Lincoln, York, Gloucester and St Albans, stand on the sites, and in some fragmentary fashion bear the names of five Roman municipalities, founded by the Roman government with special charters and constitutions. All of these reached a considerable measure of prosperity. None of them rivals the greater municipalities of other provinces. Besides them we trace a larger number of country towns, varying much in size, but all possessing in some degree the characteristics of a town. The chief of these seem to be cantonal capitals, probably developed out of the market centres or capitals of the Celtic tribes before the Roman conquest. Such are

Isurium Brigantum, capital of the Brigantes, 12 m. north-west of York and the most northerly Romano-British town; Ratae, now Leicester, capital of the Coritani; Viroconium, now Wroxeter, near Shrewsbury, capital of the Cornovii; Venta Silurum, now Caerwent, near Chepstow; Corinium, now Cirencester, capital of the Dobuni; Isca Dumnoniorum, now Exeter, the most westerly of these towns; Durnovaria, now Dorchester, in Dorset, capital of the Durotriges; Venta Belgarum, now Winchester; Calleva Atrebatum, now Silchester, 10 m. south of Reading; Durovernum Cantuarorum, now Canterbury; and Venta Icenorum, now Caistor-by-Norwich. Besides these country towns, Londinium (London) was a rich and important trading town, centre of the road system, and the seat of the finance officials of the province, as the remarkable objects discovered in it abundantly prove, while Aquae Sulis (Bath) was a spa provided with splendid baths, and a richly adorned temple of the native patron deity, Sul or Sulis, whom the Romans called Minerva. Many smaller places, too, for example, Magna or Kenchester near Hereford, Durobrivae or Rochester in Kent, another Durobrivae near Peterborough, a site of uncertain name near Cambridge, another of uncertain name near Chesterford, exhibited some measure of town life.

As a specimen we may take Silchester, remarkable as the one town in the whole Roman empire which has been completely

and systematically uncovered. As we see it to-day, it is an open space of 100 acres, set on a hill with a wide prospect east and south and west, in shape an irregular hexagon, enclosed in a circuit of a mile and a half by the massive ruins of a city wall which still stands here and there some 20 ft. high (fig. 4). Outside, on the north-east, is the grassy hollow of a tiny amphitheatre; on the west a line of earthworks runs in wider circuit than the walls. The area within the walls is a vast expanse of cultivated land, unbroken by any vestige of antiquity; yet the soil is thick with tile and potsherd, and in hot summers the unevenly growing corn reveals the remains of streets beneath the surface. Casual excavations were made here in 1744 and 1833; more systematic ones intermittently between 1864 and 1884 by the Rev. J. G. Joyce and others; finally, in May 1890, the complete uncovering of the whole site was begun by Mr G. E. Fox and others. The work was carried on with splendid perseverance, and the uncovering of the interior was completed in 1908.

The chief results concern the buildings. Though these have vanished wholly from the surface, the foundations and lowest courses of their walls survive fairly perfect below ground: thus the plan of

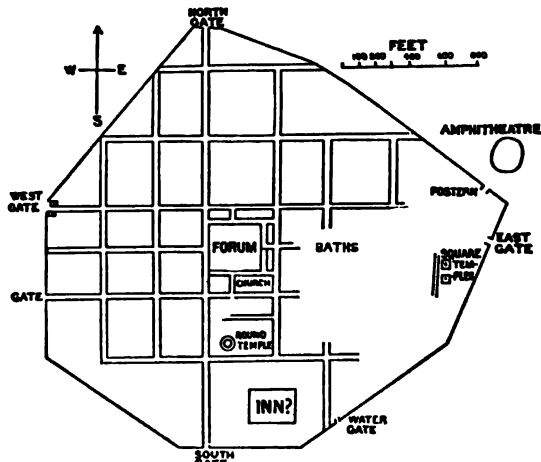

FIG. 4.—General Plan of Silchester (Calleva Atrebatum).

the town can be minutely recovered, and both the character of the buildings which make up a place like Calleva, and the character of Romano-British buildings generally, become plainer. Of the buildings the chief are:—

1. *Forum*.—Near the middle of the town was a rectangular block covering two acres. It comprised a central open court, 132 ft. by 140 ft. in size, surrounded on three sides by a corridor or cloister, with rooms opening on the cloister (fig. 5). On the fourth side was a great hall, with rooms opening into it from behind. This hall was 270 ft. long and 58 ft. wide; two rows of Corinthian columns ran down the middle, and the clerestory roof may have stood 50 ft. above the floor; the walls were frescoed or lined with marble, and for ornament there were probably statues. Finally, a corridor ran round outside the whole block. Here the local authorities had their offices, justice was administered, traders trafficked, citizens and idlers gathered. Though we cannot apportion the rooms to their precise uses, the great hall was plainly the basilica, for meetings and business; the rooms behind it were perhaps law courts, and some of the rooms on the other three sides of the quadrangle may have been shops. Similar municipal buildings existed in most towns of the western Empire, whether they were full municipalities or (as probably Calleva was) of lower rank. The Callevan Forum seems in general simpler than others, but its basilica is remarkably large. Probably the British climate compelled more indoor life than the sunnier south.

2. *Temples*.—Two small square temples, of a common western-provincial type, were in the east of the town; the cells of the larger measured 42 ft. sq., and was lined with Purbeck marble. A third, circular temple stood between the forum and the south gate. A fourth, a smaller square shrine found in 1907 a little east of the

forum, yielded some interesting inscriptions which relate to a gild (*collegium*) and incidentally confirm the name Calvea.

3. *Christian Church*.—Close outside the south-east angle of the forum was a small edifice, 42 ft. by 27 ft., consisting of a nave and two aisles which ended at the east in a porch as wide as the building, and at the west in an apse and two flanking chambers. The nave and porch were floored with plain red tesserae; in the apse was a simple mosaic panel in red, black and white. Round the building

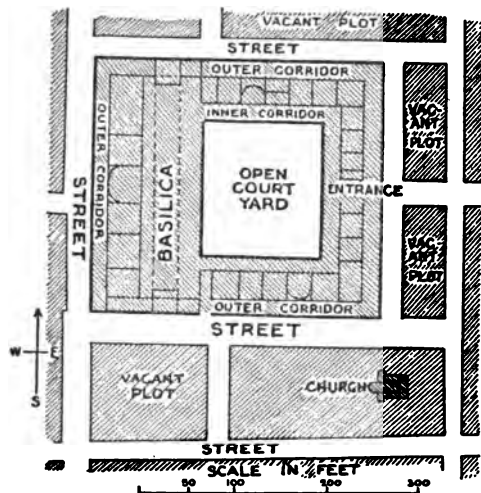

FIG. 5.—Plan of Forum, Basilica and surroundings, Silchester.

was a yard, fenced with wooden palings; in it were a well near the apse, and a small structure of tile with a pit near the east end. No direct proof of date or use was discovered. But the ground plan is that of an early Christian church of the "basilican" type. This type comprised nave and aisles, ending at one end in an apse and two chambers resembling rudimentary transepts, and at the other end in a porch (*narthex*). Previous to about A.D. 420 the porch was often at the east end and the apse at the west, and the altar, often movable, stood in the apse—as at Silchester, perhaps, on the mosaic panel. A court enclosed the whole; near the porch was a laver for the ablutions of intending worshippers. Many such churches have been found in other countries, especially in Roman Africa; no other satisfactory instance is known in Britain.

4. *Town Baths*.—A suite of public baths stood a little east of the forum. At the entrance was a peristyle court for loungers and a latrine; hence the bather passed into the Apodyterium (dressing-room), the Frigidarium (cold room) fitted with a cold bath for use at the end of the bathing ceremony, and a series of hot rooms—the whole resembling many modern Turkish baths. In their first form the baths of Silchester were about 160 ft. by 80 ft., but they were later considerably extended.

5. *Private Houses*.—The private houses of Silchester are of two types. They consist either of a row of rooms, with a corridor along them, and perhaps one or two additional rooms at one or both ends, or of three such corridors and rows of rooms, forming three sides of a large square open yard. They are detached houses, standing each in its own garden, and not forming terraces or rows. The country houses of Roman Britain have long been recognized as embodying these (or allied) types; now it becomes plain that they were the normal types throughout Britain. They differ widely from the town houses of Rome and Pompeii: they are less unlike some of the country houses of Italy and Roman Africa; but their real parallels occur in Gaul, and they may be Celtic types modified to Roman use—like Indian bungalows. Their internal fittings—hypocausts, frescoes, mosaics—are everywhere Roman; those at Silchester are average specimens, and, except for one mosaic, not individually striking. The largest Silchester house, with a special annex for baths, is usually taken to be a guest-house or inn for travellers between London and the west (fig. 6). Altogether, the town probably did not contain more than seventy or eighty houses of any size, and large spaces were not built over at all. This fact and the peculiar character of the houses must have given to Silchester rather the appearance of a village with scattered cottages, each in its own plot facing its own way, than a town with regular and continuous streets.

6. *Industries*.—Shops are conjectured in the forum and elsewhere,

but were not numerous. Many dyers' furnaces, a little silver refinery, and perhaps a bakery have also been noticed.

7. *Streets, Roads, &c.*—The streets were paved with gravel; they varied in width up to 28½ ft. They intersect regularly at right angles, dividing the town into square blocks, like modern Mannheim or Turin, according to a Roman system usual in both Italy and the provinces; plainly they were laid out all at once, possibly by Agricola (*Tac. Agr. 21*) and most probably about his time. There were four chief gates, not quite symmetrically placed. The town-walls are built of flint and concrete bonded with ironstone, and are backed with earth. In the plans, though not in the reports, of the excavations, they are shown as built later than the streets. No traces of meat-market, theatre or aqueduct have come to light; water was got from wells lined with wooden tube, and must have been scanty in dry summers. Smaller objects abound—coins, pottery, window and bottle and cup glass, bronze ornaments, iron tools, &c.—and many belong to the beginnings of Calvea, but few pieces are individually notable. Traces of late Celtic art are singularly absent; Roman fashions rule supreme, and inscriptions show that even the lower classes here spoke and wrote Latin. Outside the walls were the cemeteries, not yet explored. Of suburbs we have as yet no hint. Nor indeed is the neighbourhood of Calvea at all rich in Roman remains. In fact, as well as in Celtic etymology, it was "the town in the forest." A similar absence of remains may be noticed outside other Romano-British towns, and is significant of their economic position. Such doubtless were most of the towns of Roman Britain—thoroughly Romanized, peopled with Roman-speaking citizens, furnished with Roman appearances, living in Roman ways, but not very large, not very rich, a humble witness to the assimilating power of the Roman civilization in Britain.

The country, as opposed to the towns, of Roman Britain seems to have been divided into estates, commonly (though perhaps incorrectly) known as "villas." Many examples survive, some of them large and luxurious country-houses, some mere farms, constructed usually on one of the two patterns described in the account of Silchester above. The inhabitants were plainly as various—a few of them great nobles and wealthy landowners, others small farmers or possibly bailiffs. Some of these estates were worked on the true "villa" system, by which the lord occupied the "great house," and cultivated the land close round it by slaves, while he let the rest to half-free *coloni*. But other systems may have prevailed as well. Among the most important country-houses are those of Bignor in west Sussex, and Woodchester and Chedworth in Gloucestershire.

The wealth of the country was principally agrarian. Wheat and wool were exported in the 4th century, when, as we have said, Britain was especially prosperous. But the details of the trade are unrecorded. More is known of the lead and iron mines which, at least in the first two centuries, were worked in many

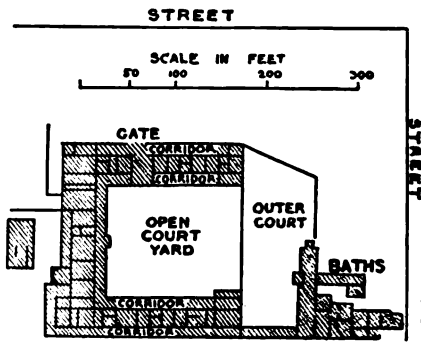

FIG. 6.—Plan of supposed Inn and Baths at Silchester.

districts—lead in Somerset, Shropshire, Flintshire and Derbyshire; iron in the west Sussex Weald, the Forest of Dean, and (to a slight extent) elsewhere. Other minerals were less notable. The gold mentioned by Tacitus proved scanty. The Cornish tin, according to present evidence, was worked comparatively little, and perhaps most in the later Empire.

Lastly, the roads. Here we must put aside all idea of "Four Great Roads." That category is probably the invention of

antiquaries, and certainly unconnected with Roman Britain (see *EAMNE STREET*). Instead, we may distinguish four main groups of roads radiating from London, and a fifth which runs obliquely. One road ran south-east to Canterbury and the Kentish ports, of which Richborough (*Rutupiae*) was the most frequented. A second ran west to Silchester, and thence by various branches to Winchester, Exeter, Bath, Gloucester and South Wales. A third, known afterwards to the English as Watling Street, ran by St Albans Wall near Lichfield (*Letocetum*), to Wroxeter and Chester. It also gave access by a branch to Leicester and Lincoln. A fourth served Colchester, the eastern counties, Lincoln and York. The fifth is that known to the English as the Fosse, which joins Lincoln and Leicester with Cirencester, Bath and Exeter. Besides these five groups, an obscure road, called by the Saxons *Akeman Street*, gave alternative access from London through Alchester (outside of Bicester) to Bath, while another obscure road winds south from near Sheffield, past Derby and Birmingham, and connects the lower Severn with the Humber. By these roads and their various branches the Romans provided adequate communications throughout the lowlands of Britain.

IV. *The End of Roman Britain.*—Early in the 4th century it was necessary to establish a special coast defence, reaching from the Wash to Spithead, against Saxon pirates: there were forts at Brancaster, Borough Castle (near Yarmouth), Bradwell (at the mouth of the Colne and Blackwater), Reculver, Richborough, Dover and Lyyme (all in Kent), Pevensey in Sussex, Porchester near Portsmouth, and perhaps also at Felixstowe in Suffolk. After about 350, barbarian assaults, not only of Saxons but also of Irish (Scotti) and Picts, became common and more terrible. At the end of the century Magnus Maximus, claiming to be emperor, withdrew many troops from Britain and a later pretender did the same. Early in the 5th century the Teutonic conquest of Gaul cut the island off from Rome. This does not mean that there was any great "departure of Romans." The central government simply ceased to send the usual governors and high officers. The Romano-British were left to themselves. Their position was weak. Their fortresses lay in the north and west, while the Saxons attacked the east and south. Their trained troops, and even their own numbers, must have been few. It is intelligible that they followed a precedent set by Rome in that age, and hired Saxons to repel Saxons. But they could not command the fidelity of their mercenaries, and the Saxon peril only grew greater. It would seem as if the Romano-Britons were speedily driven from the east of the island. Even Wroxeter on the Welsh border may have been finally destroyed before the end of the 5th century. It seems that the Saxons though apparently unable to maintain their hold so far to the west, were able to prevent the natives from recovering the lowlands. Thus driven from the centres of Romanized life, from the region of walled cities and civilized houses, into the hills of Wales and the north-west, the provincials underwent an intelligible change. The Celtic element, never quite extinct in those hills and, like most forms of barbarism, reasserting itself in this wild age—not without reinforcement from Ireland—challenged the remnants of Roman civilization and in the end absorbed them. The Celtic language reappeared; the Celtic art emerged from its shelters in the west to develop in new and medieval fashions.

AUTHORITIES.—The principal references to early Britain in classical writers occur in Strabo, Diodorus, Julius Caesar, the elder Pliny, Tacitus, Ptolemy and Cassius Dio, and in the lists of the Antonine Itinerary (probably about A.D. 210-230; ed. Parthey, 1848), the *Notitia Dignitatum* (about A.D. 400; ed. Seock, 1876), and the Ravennas 7th-century *recheuffe*; ed. Parthey 1860). The chief passages are collected in Petrie's *Monumenta Hist. Britann.* (1843), and (alphabetically) in Holder's *Altdeutsche Sprachschatz* (1896-1903). The Roman inscriptions have been collected by Hübner, *Corpus Inscriptionum Latin.* vii. (1873), and in supplements by Hübner and Haverfield in the periodical *Ephemeris epigraphica*; see also Hübner, *Inscrip. Britann. Christianae* (1876, now out of date), and J. Rhys on Pictish, &c., inscriptions, *Proceedings Soc. Antiq. Scotland*, xxvii., xxxii.

Of modern works the best summary for Roman Britain and for Caesar's invasions is T. R. Holmes, *Ancient Britain* (1907), who cites numerous authorities. See also Sir John Evans, *Stone Implements,*

Bronze Implements, and Ancient British Coins (with suppl.); Boyd Dawkins, *Early Man in Britain* (1880); J. Rhys, *Celtic Britain* (3rd ed., 1904). For late Celtic art see J. M. Kemble and A. W. Franks' *Horae Ferales* (1863), and Arthur J. Evans in *Archaeologia*, vols. lii-iv. Celtic ethnology and philology (see *CELT*) are still in the "age of discussion." For ancient earthworks see A. Hadrian Allcroft, *Earthwork of England* (1909).

For Roman Britain see, in general, Prof. F. Haverfield, *The Romanization of Roman Britain* (Oxford, 1906), and his articles in the *Victoria County History*; also the chapter in Mommsen's *Roman Provinces*; and an article in the *Edinburgh Review*, 1809. For the wall of Hadrian see John Hodgson, *History of Northumberland* (1840); J. C. Bruce, *Roman Wall* (3rd ed., 1867); reports of excavations by Haverfield in the *Cumberland Archaeological Society Transactions* (1894-1904); and R. C. Bosanquet, *Roman Camp at Housesteads* (Newcastle, 1904). For the Scottish Excavations see *Proceedings of the Society of Antiquaries of Scotland*, xx-xli, and especially J. Macdonald, *Bar Hill* (reprint, Glasgow, 1906). For other forts see R. S. Ferguson, *Cumberland Arch. Soc. Trans.* xii., on Hardknott; and J. Ward, *Roman Fort of Gellygaer* (London, 1903). For the Roman occupation of Scotland see Haverfield in *Antoniae Wall Report* (1899); J. Macdonald, *Roman Stones in Hunterian Mus.* (1897); and, though an older work, Stuart's *Caledonia Romana* (1852). For Silchester, *Archaeologia* (1800-1908); for Caerwent (*ib.* 1901-1908); for London, Charles Roach Smith, *Roman London* (1859); for Christianity in Roman Britain, *Engl. Hist. Rev.* (1896); for the villages, Gen. Pitt-Rivers' *Excavations in Cranborne Chase, &c.* (4 vols., 1887-1908), and *Proc. Soc. of Ant. xviii.* For the end of Roman Britain see *Engl. Hist. Rev.* (1904); Prof. Bury's *Life of St Patrick* (1905); Haverfield's *Romanization* (cited above); and P. Vinogradoff, *Growth of the Manor* (1905), bk. i. (F. J. H.)

ANGLO-SAXON BRITAIN

1. *History.*—The history of Britain after the withdrawal of the Roman troops is extremely obscure, but there can be little doubt that for many years the inhabitants of the provinces were exposed to devastating raids by the Picts and Scots. According to Gildas it was for protection against these incursions that the Britons decided to call in the Saxons. Their allies soon obtained a decisive victory; but subsequently they turned their arms against the Britons themselves, alleging that they had not received sufficient payment for their services. A somewhat different account, probably of English origin, may be traced in the *Historia Brittonum*, according to which the first leaders of the Saxons, Hengest and Horsa, came as exiles, seeking the protection of the British king, Vortigern. Having embraced his service they quickly succeeded in expelling the northern invaders. Eventually, however, they overcame the Britons through treachery, by inducing the king to allow them to send for large bodies of their own countrymen. It was to these adventurers, according to tradition, that the kingdom of Kent owed its origin. The story is in itself by no means improbable, while the dates assigned to the first invasion by various Welsh, Gaulish and English authorities, with one exception all fall within about a quarter of a century, viz. between the year 428 and the joint reign of Martian and Valentinian III. (450-455).

For the subsequent course of the invasion our information is of the most meagre and unsatisfactory character. According to the Anglo-Saxon Chronicle the kingdom of Sussex was founded by a certain Ella or Elle, who landed in 477, while Wessex owed its origin to Cerdic, who arrived some eighteen years later. No value, however, can be attached to these dates; indeed, in the latter case the story itself is open to suspicion on several grounds (see *WESSEX*). For the movements which led to the foundation of the more northern kingdoms we have no evidence worth consideration, nor do we know even approximately when they took place. But the view that the invasion was effected throughout by small bodies of adventurers acting independently of one another, and that each of the various kingdoms owes its origin to a separate enterprise, has little probability in its favour. Bede states that the invaders belonged to three different nations, Kent and southern Hampshire being occupied by Jutes (*q.v.*), while Essex, Sussex and Wessex were founded by the Saxons, and the remaining kingdoms by the Angli (*q.v.*). The peculiarities of social organization in Kent certainly tend to show that this kingdom had a different origin from the rest; but the evidence for the distinction between the Saxons and the Angli is of a much less satisfactory character (see *ANGLO-SAXONS*).

The royal family of Essex may really have been of Saxon origin (see Essex), but on the other hand the West Saxon royal family claimed to be of the same stock as that of Bernicia, and their connexions in the past seem to have lain with the Angli.

We need not doubt that the first invasion was followed by a long period of warfare between the natives and the invaders, in which the latter gradually strengthened their hold on the conquered territories. It is very probable that by the end of the 5th century all the eastern part of Britain, at least as far as the Humber, was in their hands. The first important check was received at the siege of "Mons Badonicus" in the year 517 (*Ann. Camb.*), or perhaps rather some fifteen or twenty years earlier. According to Gildas this event was followed by a period of peace for at least forty-four years. In the latter part of the 6th century, however, the territories occupied by the invaders seem to have been greatly extended. In the south the West Saxons are said to have conquered first Wiltshire and then all the upper part of the Thames valley, together with the country beyond as far as the Severn. The northern frontier also seems to have been pushed considerably farther forward, perhaps into what is now Scotland, and it is very probable that the basin of the Trent, together with the central districts between the Trent and the Thames, was conquered about the same time, though of this we have no record. Again, the destruction of Chester about 615 was soon followed by the overthrow of the British kingdom of Elmet in south-west Yorkshire, and the occupation of Shropshire and the Lothians took place perhaps about the same period, that of Herefordshire probably somewhat later. In the south, Somerset is said to have been conquered by the West Saxons shortly after the middle of the 7th century. Dorset had probably been acquired by them before this time, while part of Devon seems to have come into their hands soon afterwards.

The area thus conquered was occupied by a number of separate kingdoms, each with a royal family of its own. The districts north of the Humber contained two kingdoms, Bernicia (*q.v.*) and Deira (*q.v.*), which were eventually united in Northumbria. South of the Humber, Lindsey seems to have had a dynasty of its own, though in historical times it was apparently always subject to the kings of Northumbria or Mercia. The upper basin of the Trent formed the nucleus of the kingdom of Mercia (*q.v.*), while farther down the east coast was the kingdom of East Anglia (*q.v.*). Between these two lay a territory called Middle Anglia, which is sometimes described as a kingdom, though we do not know whether it ever had a separate dynasty. Essex, Kent and Sussex (see articles on these kingdoms) preserve the names of ancient kingdoms, while the old diocese of Worcester grew out of the kingdom of the Hwicce (*q.v.*), with which it probably coincided in area. The south of England, between Sussex and "West Wales" (eventually reduced to Cornwall), was occupied by Wessex, which originally also possessed some territory to the north of the Thames. Lastly, even the Isle of Wight appears to have had a dynasty of its own. But it must not be supposed that all these kingdoms were always, or even normally, independent. When history begins, Æthelberht, king of Kent, was supreme over all the kings south of the Humber. He was followed by the East Anglian king Raedwald, and the latter again by a series of Northumbrian kings with an even wider supremacy. Before Æthelberht a similar position had been held by the West Saxon king Ceawlin, and at a much earlier period, according to tradition, by Ella or Ælle, the first king of Sussex. The nature of this supremacy has been much discussed, but the true explanation seems to be furnished by that principle of personal allegiance which formed such an important element in Anglo-Saxon society.

2. *Government.*—Internally the various states seem to have been organized on very similar lines. In every case we find kingly government from the time of our earliest records, and there is no doubt that the institution goes back to a date anterior to the invasion of Britain (see OFFA; WERMUND). The royal title, however, was frequently borne by more than one person. Sometimes we find one supreme king together with a number of under-kings (*subreguli*); sometimes again, especially in the smaller kingdoms, Essex, Sussex and Hwicce, we meet with two

or more kings, generally brothers, reigning together apparently on equal terms. During the greater part of the 8th century Kent seems to have been divided into two kingdoms; but as a rule such divisions did not last beyond the lifetime of the kings between whom the arrangement had been made. The kings were, with very rare exceptions, chosen from one particular family in each state, the ancestry of which was traced back not only to the founder of the kingdom but also, in a remoter degree, to a god. The members of such families were entitled to special *wergilda*, apparently six times as great as those of the higher class of nobles (see below).

The only other central authority in the state was the king's council or court (*þeod, witan, plebs, concilium*). This body consisted partly of young warriors in constant attendance on the king, and partly of senior officials whom he called together from time to time. The terms used for the two classes by Bede are *milites* (*ministri*) and *comites*, for which the Anglo-Saxon verbs are *has þegnas* and *gesidas* respectively. Both classes alike consisted in part of members of the royal family. But they were by no means confined to such persons or even to born subjects of the king. Indeed, we are told that popular kings like Oswine attracted young nobles to their service from all quarters. The functions of the council have been much discussed, and it has been claimed that they had the right of electing and deposing kings. This view, however, seems to involve the existence of a greater feeling for constitutionalism than is warranted by the information at our disposal. The incidents which have been brought forward as evidence to this effect may with at least equal probability be interpreted as cases of profession or transference of personal allegiance. In other respects the functions of the council seem to have been of a deliberative character. It was certainly customary for the king to seek their advice and moral support on important questions, but there is nothing to show that he had to abide by the opinion of the majority.

For administrative purposes each of the various kingdoms was divided into a number of districts under the charge of royal reeves (*cyninges gerefa, praefectus, praepositus*). These officials seem to have been located in royal villages (*cyninges tun, vico regalis*) or fortresses (*cyninges burg, urbs regis*), which served as centres and meeting-places (markets, &c.) for the inhabitants of the district, and to which their dues, both in payments and services had to be rendered. The usual size of such districts in early times seems to have been 300, 600 or 1200 hides.¹ In addition to these districts we find mention also of much larger divisions containing 2000, 3000, 5000 or 7000 hides. To this category belong the shires of Wessex (Hampshire, Wiltshire, Berkshire, &c.), each of which had an earl (*aldorman, princeps, dux*) of its own, at all events from the 8th century onwards. Many, if not all, of these persons were members of the royal family, and it is not unlikely that they originally bore the kingly title. At all events they are sometimes described as *subreguli*.

3. *Social Organisation.*—The officials mentioned above, whether of royal birth or not, were probably drawn from the king's personal retinue. In Anglo-Saxon society, as in that of all Teutonic nations in early times, the two most important principles were those of kinship and personal allegiance. If a man suffered injury it was to his relatives and his lord, rather than to any public official, that he applied first for protection and redress. If he was slain, a fixed sum (*wergild*), varying according to his station, had to be paid to his relatives, while a further but smaller sum (*manbot*) was due to his lord. These principles applied to all classes of society alike, and though strife within the family was by no means unknown, at all events in royal families, the actual slaying of a kinsman was regarded as the most heinous of all offences. Much the same feeling applied to the slaying of a lord—an offence for which no compensation could be rendered. How far the armed followers of a lord were entitled to compensation when the latter was slain

¹ The hide (*hid, hwicce, familia, tributarius, cassatus, mansus*, &c.) was in later times a measure of land, usually 120 acres. In early times, however, it seems to have meant (1) household, (2) normal amount of land appertaining to a household.

is uncertain, but in the case of a king they received an amount equal to the wergild. Another important development of the principle of allegiance is to be found in the custom of heriots. In later times this custom amounted practically to a system of death-duties, payable in horses and arms or in money to the lord of the deceased. There can be little doubt, however, that originally it was a restoration to the lord of the military outfit with which he had presented his man when he entered his service. The institution of thegnhood, i.e. membership of the *comitatus* or retinue of a prince, offered the only opening by which public life could be entered. Hence it was probably adopted almost universally by young men of the highest classes. The thegn was expected to fight for his lord, and generally to place his services at his disposal in both war and peace. The lord, on the other hand, had to keep his thegns and reward them from time to time with arms and treasure. When they were of an age to marry he was expected to provide them with the means of doing so. If the lord was a king this provision took the form of a grant, perhaps normally ten hides, from the royal lands. Such estates were not strictly hereditary, though as a mark of favour they were not unfrequently re-granted to the sons of deceased holders.

The structure of society in England was of a somewhat peculiar type. In addition to slaves, who in early times seem to have been numerous, we find in Wessex and apparently also in Mercia three classes, described as *twelfhynde*, *sixhynde* and *twihynde* from the amount of their wergilds, viz. 1200, 600 and 200 shillings respectively. It is probable that similar classes existed also in Northumbria, though not under the same names. Besides these terms there were others which were probably in use everywhere, viz. *gesitcund* for the two higher classes and *ceorlisc* for the lowest. Indeed, we find these terms even in Kent, though the social system of that kingdom seems to have been of an essentially different character. Here the wergild of the *ceorlisc* class amounted to 100 shillings, each containing twenty silver coins (*scattas*), as against 200 shillings of four (in Wessex five) silver coins, and was thus very much greater than the latter. Again, there was apparently but one *gesitcund* class in Kent, with a wergild of 300 shillings, while, on the other hand, below the *ceorlisc* class we find three classes of persons described as *lacas*, who corresponded in all probability to the *liti* or freedmen of the continental laws, and who possessed wergilds of 80, 60 and 40 shillings respectively. To these we find nothing analogous in the other kingdoms, though the poorer classes of Welsh freemen had wergilds varying from 120 to 60 shillings. It should be added that the differential treatment of the various classes was by no means confined to the case of wergilds. We find it also in the compensations to which they were entitled for various injuries, in the fines to which they were liable, and in the value attached to their oaths. Generally, though not always, the proportions observed were the same as in the wergilds.

The nature of the distinction between the *gesitcund* and *ceorlisc* classes is nowhere clearly explained; but it was certainly hereditary and probably of considerable antiquity. In general we may perhaps define them as nobles and commons, though in view of the numbers of the higher classes it would probably be more correct to speak of gentry and peasants. The distinction between the *twelfhynde* and *sixhynde* classes was also in part at least hereditary, but there is good reason for believing that it arose out of the possession of land. The former consisted of persons who possessed, whether as individuals or families, at least five hides of land—which practically means a village—while the latter were landless, i.e. probably without this amount of land. Within the *ceorlisc* class we find similar subdivisions, though they were not marked by a difference in wergild. The *gafolgelda* or *tributarius* (tribute-payer) seems to have been a corvi who possessed at least a hide, while the *gebur* was without land of his own, and received his outfit as a loan from his lord.

4. *Payments and Services.*—We have already had occasion to refer to the dues which were rendered by different classes of the population, and which the reeves in royal villages had to collect and superintend. The payments seem to have varied greatly according to the class from which they were due. Those

rendered by landowners seem to have been known as *seorm* or *fostor*, and consisted of a fixed quantity of articles paid in kind. In Ine's Laws (cap. 70) we find a list of payments specified for a unit of ten hides, perhaps the normal holding of a *twelfhynde* man—though on the other hand it may be nothing more than a mere fiscal unit in an aggregate of estates. The list consists of oxen, sheep, geese, hens, honey, ale, loaves, cheese, butter, fodder, salmon and eels. Very similar specifications are found elsewhere. The payments rendered by the *gafolgelda* (*tributarius*) were known as *gafol* (*tributum*), as his name implies. In Ine's Laws we hear only of the *hwitel* or white cloak, which was to be of the value of six pence per household (hide), and of barley, which was to be six pounds in weight for each worker. In later times we meet with many other payments both in money and in kind, some of which were doubtless in accordance with ancient custom. On the other hand the *gebur* seems not to have been liable to payments of this kind, presumably because the land which he cultivated formed part of the demesne (*inland*) of his lord. The term *gafol*, however, may have been applied to the payments which he rendered to the latter.

The services required of landowners were very manifold in character. Probably the most important were military service (*frid*, *expeditio*) and the repairing of fortifications and bridges—the *trinoda necessitas* of later times. Besides these we find reference in charters of the 9th century to the keeping of the king's hunters, horses, dogs and hawks, and the entertaining of messengers and other persons in the king's service. The duties of men of the *sixhynde* class, if they are to be identified with the *radnihtas* (*radmanni*) of later times, probably consisted chiefly in riding on the king's (or their lord's) business. The services of the peasantry can only be conjectured from what we find in later times. Presumably their chief duty was to undertake a share in the cultivation of the demesne land. We need scarcely doubt also that the labour of repairing fortifications and bridges, though it is charged against the landowners, was in reality delegated by them to their dependents.

5. *Warfare.*—All classes are said to have been liable to the duty of military service. Hence, since the *ceorlisc* doubtless formed the bulk of the population, it has been thought that the Anglo-Saxon armies of early times were essentially peasant forces. The evidence at our disposal, however, gives little justification for such a view. The regulation that every five or six hides should supply a warrior was not a product of the Danish invasions, as is sometimes stated, but goes back at least to the beginning of the 9th century. Had the fighting material been drawn from the *ceorlisc* class a warrior would surely have been required from each hide, but for military service no such regulation is found. Again, the *frid* (*fyrd*) was composed of mounted warriors during the 9th century, though apparently they fought on foot, and there are indications that such was the case also in the 7th century. No doubt *ceorlisc* took part in military expeditions, but they may have gone as attendants and camp-followers rather than as warriors, their chief business being to make stockades and bridges, and especially to carry provisions. The serious fighting, however, was probably left to the *gesitcund* classes, who possessed horses and more or less effective weapons. Indeed, there is good reason for regarding these classes as essentially military.

The chief weapons were the sword and spear. The former were two-edged and on the average about 3 ft. long. The hilts were often elaborately ornamented and sometimes these weapons were of considerable value. No definite line can be drawn between the spear proper and the javelin. The spear-heads which have been found in graves vary considerably in both form and size. They were fitted on to the shaft by a socket which was open on one side. Other weapons appear to have been quite rare. Bows and arrows were certainly in use for sporting purposes, but there is no reason for believing that they were much used in warfare before the Danish invasions. They are very seldom met with in graves. The most common article of defensive armour was the shield, which was small and circular and apparently of quite thin lime-wood, the edge being formed

probably by a thin band of iron. In the centre of the shield, in order to protect the hand which held it, was a strong iron boss, some 7 in. in diameter and projecting about 3 in. It is clear from literary evidence that the helmet (*helm*) and coat of chain mail (*byrne*) were also in common use. They are seldom found in graves, however, whether owing to the custom of heriots or to the fact that, on account of their relatively high value, they were frequently handed on from generation to generation as heirlooms. Greaves are not often mentioned. It is worth noting that in later times the heriot of an "ordinary thegn" (*medema þegn*)—by which is meant apparently not a king's thegn but a man of the *twelfhynde* class—consisted of his horse with its saddle, &c. and his arms, or two pounds of silver as an equivalent of the whole. The arms required were probably a sword, helmet, coat of mail and one or two spears and shields. There are distinct indications that a similar outfit was fairly common in Ine's time, and that its value was much the same. One would scarcely be justified, however, in supposing that it was anything like universal; for the purchasing power of such a sum was at that time considerable, representing as it did about 16-20 oxen or 100-120 sheep. It would hardly be safe to credit men of the *sixhynde* class in general with more than a horse, spear and shield.

6. *Agriculture and Village Life*.—There is no doubt that a fairly advanced system of agriculture must have been known to the Anglo-Saxons before they settled in Britain. This is made clear above all by the representation of a plough drawn by two oxen in one of the very ancient rock-carvings at Tegneby in Bohuslän. In Domesday Book the heavy plough with eight oxen seems to be universal, and it can be traced back in Kent to the beginning of the 9th century. In this kingdom the system of agricultural terminology was based on it. The unit was the *sulung* (*aratrum*) or ploughland (from *sulh*, "plough"), the fourth part of which was the *geoced* or *geoc* (*jugum*), originally a yoke of oxen. An analogy is supplied by the *carucata* of the Danelagh, the eighth part of which was the *bowata* or "ox-land." In the 10th century the *sulung* seems to have been identified with the hide, but in earlier times it contained apparently two hides. The hide itself, which was the regular unit in the other kingdoms, usually contained 120 acres in later times and was divided into four *girda* (*virgatae*) or yardlands. But originally it seems to have meant simply the land pertaining to a household, and its area in early times is quite uncertain, though probably far less. For the acre also there was in later times a standard length and breadth, the former being called *jurhlang* (*jurlong*) and reckoned at one-eighth of a mile, while the *accerbædce* or "acre-breadth" (chain) was also a definite measure. We need not doubt, however, that in practice the form of the acre was largely conditioned by the nature of the ground. Originally it is thought to have been the measure of a day's ploughing, in which case the dimensions given above would scarcely be reached. Account must also be taken of the possibility that in early times lighter teams were in general use. If so the normal dimensions of the acre may very well have been quite different.

The husbandry was of a co-operative character. In the 11th century it was distinctly unusual for a peasant to possess a whole team of his own, and there is no reason for supposing the case to have been otherwise in early times; for though the peasant might then hold a hide, the hide itself was doubtless smaller and not commensurate in any way with the ploughland. The holdings were probably not compact but consisted of scattered strips in common fields, changed perhaps from year to year, the choice being determined by lot or otherwise. As for the method of cultivation itself there is little or no evidence. Both the "two-course system" and the "three-course system" may have been in use; but on the other hand it is quite possible that in many cases the same ground was not sown more than once in three years. The prevalence of the co-operative principle, it may be observed, was doubtless due in large measure to the fact that the greater part of England, especially towards the east, was settled not in scattered farms or hamlets but in compact villages with the cultivated lands lying round them.

The mill was another element which tended to promote the same principle. There can be little doubt that before the Anglo-Saxons came to Britain they possessed no instrument for grinding corn except the quern (*coeorn*), and in remote districts this continued in use until quite late times. The grinding seems to have been performed chiefly by female slaves, but occasionally we hear also of a donkey-mill (*esolcoeorn*). The mill proper, however, which was derived from the Romans, as its name (*mýlen*, from Lat. *molina*) indicates, must have come into use fairly early. In the 11th century every village of any size seems to have possessed one, while the earliest references go back to the 8th century. It is not unlikely that they were in use during the Roman occupation of Britain, and consequently that they became known to the invaders almost from the first. The mills were presumably driven for the most part by water, though we have a reference to a windmill as early as the year 833.

All the ordinary domestic animals were known. Cattle and sheep were pastured on the common lands appertaining to the village, while pigs, which (especially in Kent) seem to have been very numerous, were kept in the woods. Bee-keeping was also practised. In all these matters the invasion of Britain had brought about no change. The cultivation of fruit and vegetables on the other hand was probably almost entirely new. The names are almost all derived from Latin, though most of them seem to have been known soon after the invasion, at all events by the 7th century.

From the considerations pointed out above we can hardly doubt that the village possessed a certain amount of corporate life, centred perhaps in an ale-house where its affairs were discussed by the inhabitants. There is no evidence, however, which would justify us in crediting such gatherings with any substantial degree of local authority. So far as the limited information at our disposal enables us to form an opinion, the responsibility both for the internal peace of the village, and for its obligations to the outside world, seems to have lain with the lord or his steward (*gerefa*, *villicus*) from the beginning. A quite opposite view has, it is true, found favour with many scholars, viz. that the villages were originally settlements of free kindreds, and that the lord's authority was superimposed on them at a later date. This view is based mainly on the numerous place-names ending in *-ing*, *-ingham*, *-ington*, &c., in which the syllable *-ing* is thought to refer to kindreds of cultivators. It is more probable, however, that these names are derived from persons of the *twelfhynde* class to whom the land had been granted. In many cases indeed there is good reason for doubting whether the name is a patronymic at all.

The question how far the villages were really new settlements is difficult to answer, for the terminations *-ham*, *-ton*, &c. cannot be regarded as conclusive evidence. Thus according to the Anglo-Saxon Chronicle (ann. 571) Bensington and Eynsham were formerly British villages. Even if the first part of Eggesham is English—which is by no means certain—it is hardly sufficient reason for discrediting this statement, for Canterbury (*Canthearaburg*) and Rochester (*Hrofes ceaster*) were without doubt Roman places in spite of their English names. On the whole it seems likely that the cultivation of the land was not generally interrupted for more than a very few years; hence the convenience of utilizing existing sites of villages would be obvious, even if the buildings themselves had been burnt.

7. *Towns*.—Gildas states that in the time of the Romans Britain contained twenty-eight cities (*civitates*), besides a number of fortresses (*castella*). Most of these were situated within the territories eventually occupied by the invaders, and reappear as towns in later times. Their history in the intervening period, however, is wrapped in obscurity. Chester appears to have been deserted for three centuries after its destruction early in the 7th century, and in most of the other cases there are features observable in the situation and plan of the mediæval town which suggest that its occupation had not been continuous. Yet London and Canterbury must have recovered a certain amount of importance quite early, at all events within two centuries after the invasion, and the same is probably true of York.

Lincoln and a few other places. The term applied to both the cities and the fortresses of the Romans was *castra* (Lat. *castra*), less frequently the English word *burg*. There is little or no evidence for the existence of towns other than Roman in early times, for the word *wurb* is merely a translation of *burg*, which was used for any fortified dwelling-place, and it is improbable that anything which could properly be called a town was known to the invaders before their arrival in Britain. The Danish settlements at the end of the 9th century and the defensive system initiated by King Alfred gave birth to a new series of fortified towns, from which the boroughs of the middle ages are mainly descended.

8. *Houses*.—Owing to the fact that houses were built entirely of perishable materials, wood and wattle, we are necessarily dependent almost wholly upon literary evidence for knowledge of this subject. Stone seems to have been used first for churches, but this was not before the 7th century, and we are told that at first masons were imported from Gaul. Indeed wood was used for many churches, as well as for most secular buildings, until a much later period. The walls were formed either of stout planks laid together vertically or horizontally, or else of posts at a short distance from one another, the interstices being filled up with wattlework daubed with clay. It is not unlikely that the houses of wealthy persons were distinguished by a good deal of ornamentation in carving and painting. The roof was high-pitched and covered with straw, hay, reeds or tiles. The regular form of the buildings was rectangular, the gable sides probably being shorter than the others. There is little evidence for partitions inside, and in wealthy establishments the place of rooms seems to have been supplied by separate buildings within the same enclosure. The windows must have been mere openings in the walls or roof, for glass was not used for this purpose before the latter part of the 7th century. Stoves were known, but most commonly heat was obtained from an open fire in the centre of the building. Of the various buildings in a wealthy establishment the chief were the hall (*hall*), which was both a dining and reception room, and the "lady's bower" (*byrdwur*), which served also as a bedroom for the master and mistress. To these we have to add buildings for the attendants, kitchen, bakehouse, &c., and farm buildings. There is little or no evidence for the use of two-storied houses in early times, though in the 10th and 11th centuries they were common. The whole group of buildings stood in an enclosure (*tun*) surrounded by a stockade (*burg*), which perhaps rested on an earthwork, though this is disputed. Similarly the homestead of the peasant was surrounded by a fence (*ador*).

9. *Clothes*.—The chief material for clothing was at first no doubt wool, though linen must also have been used and later became fairly common. The chief garments were the coat (*roc*), the trousers (*brec*), and the cloak, for which there seem to have been a number of names (*loða, hacela, scicing, pad, hwitel*). To these we may add the hat (*haet*), belt (*gyrda*), stockings (*hosa*), shoes (*scok, gescy, rifeing*) and gloves (*glof*). The *crusene* was a fur coat, while the *serc* or *smoc* seems to have been an undergarment and probably sleeveless. The whole attire was of national origin and had probably been in use long before the invasion of Britain. In the great bog-deposit at Thorsbjærg in Angul, which dates from about the 4th century, there were found a coat with long sleeves, in a fair state of preservation, a pair of long trousers with remains of socks attached, several shoes and portions of square cloaks, one of which had obviously been dyed green. The dress of the upper classes must have been of a somewhat gorgeous character, especially when account is taken of the brooches and other ornaments which they wore. It is worth noting that according to Jordanes the Swedes in the 6th century were splendidly dressed.

10. *Trade*.—The few notices of this subject which occur in the early laws seem to refer primarily to cattle-dealing. But there can be no doubt that a considerable import and export trade with the continent had sprung up quite early. In Bede's time, if not before, London was resorted to by many merchants both by land and by sea. At first the chief export trade was

probably in slaves. English slaves were to be obtained in Rome even before the end of the 6th century, as appears from the well-known story of Gregory the Great. Since the standard price of slaves on the continent was in general three or four times as great as it was in England, the trade must have been very profitable. After the adoption of Christianity it was gradually prohibited by the laws. The nature of the imports during the heathen period may be learned chiefly from the graves, which contain many brooches and other ornaments of continental origin, and also a certain number of silver, bronze and glass vessels. With the introduction of Christianity the ecclesiastical connexion between England and the continent without doubt brought about a large increase in the imports of secular as well as religious objects, and the frequency of pilgrimages by persons of high rank must have had the same effect. The use of silk (*scoluc*) and the adoption of the mancus (see below) point to communication, direct or indirect, with more distant countries. In the 8th century we hear frequently of tolls on merchant ships at various ports, especially London.

11. *Coinage*.—The earliest coins which can be identified with certainty are some silver pieces which bear in Runic letters the name of the Mercian king Æthelred (675-704). There are others, however, of the same type and standard (about 21 grains) which may be attributed with probability to his father Penda (d. 655). But it is clear from the laws of Æthelberht that a regular silver coinage was in use at least half a century before this time, and it is not unlikely that many unidentified coins may go back to the 6th century. These are fairly numerous, and are either without inscriptions or, if they do bear letters at all, they seem to be mere corruptions of Roman legends. Their designs are derived from Roman or Frankish coins, especially the former, and their weight varies from about 10 to 21 grains, though the very light coins are rare. Anonymous gold coins, resembling Frankish trientes in type and standard (21 grains), are also fairly common, though they must have passed out of use very early, as the laws give no hint of their existence. Larger gold coins (*solidi*) are very rare. In the early laws the money actually in use appears to have been entirely silver. In Offa's time a new gold coin, the *mancus*, resembling in standard the Roman solidus (about 70 grains), was introduced from Mahomedan countries. The oldest extant specimen bears a faithfully copied Arabic inscription. In the same reign the silver coins underwent a considerable change in type, being made larger and thinner, while from this time onwards they always bore the name of the king (or queen or archbishop) for whom they were issued. The design and execution also became remarkably good. Their weight was at first unaffected, but probably towards the close of Offa's reign it was raised to about 23 grains, at which standard it seems to have remained, nominally at least, until the time of Alfred. It is to be observed that with the exception of Burgred's coins and a few anonymous pieces the silver was never adulterated. No bronze coins were current except in Northumbria, where they were extremely common in the 9th century.

Originally *scilling* ("shilling") and *scell* seem to have been the terms for gold and silver coins respectively. By the time of Ine, however, *pending*, *penning* ("penny"), had already come into use for the latter, while, owing to the temporary disappearance of a gold coinage, *scilling* had come to denote a mere unit of account. It was, however, a variable unit, for the Kentish shilling contained twenty *scettas* (pence), while the Mercian contained only four. The West Saxon shilling seems originally to have been identical with the Mercian, but later it contained five pence. Large payments were generally made by weight, 240-250 pence being reckoned to the pound, perhaps from the 7th century onwards. The *mancus* was equated with thirty pence, probably from the time of its introduction. This means that the value of gold relatively to silver was 10:1 from the end of Offa's reign. There is reason, however, for thinking that in earlier times it was as low as 6:1, or even 5:1. In Northumbria a totally different monetary system prevailed, the unit being the *tryms*, which contained three *scettas* or pence. As to the value of the bronze coins we are without information.

The purchasing power of money was very great. The sheep was valued at a shilling in both Wessex and Mercia, from early times till the 11th century. One pound was the normal price of a slave and half a pound that of a horse. The price of a pig was twice, and that of an ox six times as great as that of a sheep. Regarding the prices of commodities other than live-stock we have little definite information, though an approximate estimate may be made of the value of arms. It is worth noticing that we often hear of payments in gold and silver vessels in place of money. In the former case the mancus was the usual unit of calculation.

12. *Ornaments*.—Of these the most interesting are the brooches which were worn by both sexes and of which large numbers have been found in heathen cemeteries. They may be classed under eight leading types: (1) circular or ring-shaped, (2) cruciform, (3) square-headed, (4) radiated, (5) S-shaped, (6) bird-shaped, (7) disk-shaped, (8) cupelliform or saucer-shaped. Of these Nos. 5 and 6 appear to be of continental origin, and this is probably the case also with No. 4 and in part with No. 7. But the last-mentioned type varies greatly, from rude and almost plain disks of bronze to magnificent gold specimens studded with gems. No. 8 is believed to be peculiar to England, and occurs chiefly in the southern Midlands, specimens being usually found in pairs. The interiors are gilt, often furnished with detachable plates and sometimes set with brilliants. The remaining types were probably brought over by the Anglo-Saxons at the time of the invasion. Nos. 1 and 3 are widespread outside England, but No. 2, though common in Scandinavian countries, is hardly to be met with south of the Elbe. It is worth noting that a number of specimens were found in the cremation cemetery at Borgstedterfeld near Rendsburg. In England it occurs chiefly in the more northern counties. Nos. 2 and 3 vary greatly in size, from 2½ to 7 in. or more. The smaller specimens are quite plain, but the larger ones are gilt and generally of a highly ornamental character. In later times we hear of brooches worth as much as six mancuses, i.e. equivalent to six oxen.

Among other ornaments we may mention hairpins, rings and ear-rings, and especially buckles which are often of elaborate workmanship. Bracelets and necklets are not very common, a fact which is rather surprising, as in early times, before the issuing of a coinage, these articles (*beagas*) took the place of money to a large extent. The glass vessels are finely made and of somewhat striking appearance, though they closely resemble contemporary continental types. Since the art of glass-working was unknown, according to Bede, until nearly the end of the 7th century, it is probable that these were all of continental or Roman-British origin.

13. *Amusements*.—It is clear from the frequent references to dogs and hawks in the charters that hunting and falconry were keenly pursued by the kings and their retinues. Games, whether indoor or outdoor, are much less frequently mentioned, but there is no doubt that the use of dice (*taeff*) was widespread. At court much time was given to poetic recitation, often accompanied by music, and accomplished poets received liberal rewards. The chief musical instrument was the harp (*hearpe*), which is often mentioned. Less frequently we hear of the flute (*pipe*) and later also of the fiddle (*fidle*). Trumpets (*horn*, *sneghelhorn*, *byrne*) appear to have been used chiefly as signals.

14. *Writing*.—The Runic alphabet seems to have been the only form of writing known to the Anglo-Saxons before the invasion of Britain, and indeed until the adoption of Christianity. In its earliest form, as it appears in inscriptions on various articles found in Schleswig and in Scandinavian countries, it consisted of twenty-four letters, all of which occur in abecedaria in England. In actual use, however, two letters soon became obsolete, but a number of others were added from time to time, some of which are found also on the continent, while others are peculiar to certain parts of England. Originally the Runic alphabet seems to have been used for writing on wooden boards, though none of these have survived. The inscriptions which have come down to us are engraved partly on memorial stones,

which are not uncommon in the north of England, and partly on various metal objects, ranging from swords to brooches. The adoption of Christianity brought about the introduction of the Roman alphabet; but the older form of writing did not immediately pass out of use, for almost all the inscriptions which we possess date from the 7th or following centuries. Coins with Runic legends were issued at least until the middle of the 8th century, and some of the memorial stones date probably even from the 9th. The most important of the latter are the column at Bewcastle, Cumberland, believed to commemorate Alhfrith, the son of Oswio, who died about 670, and the cross at Ruthwell, Dumfriesshire, which is probably about a century later. The Roman alphabet was very soon applied to the purpose of writing the native language, e.g. in the publication of the laws of Æthelberht. Yet the type of character in which even the earliest surviving MSS. are written is believed to be of Celtic origin. Most probably it was introduced by the Irish missionaries who evangelized the north of England, though Welsh influence is scarcely impossible. Eventually this alphabet was enlarged (probably before the end of the 7th century) by the inclusion of two Runic letters for *th* and *w*.

15. *Marriage*.—This is perhaps the subject on which our information is most inadequate. It is evident that the relationships which prohibited marriage were different from those recognized by the Church; but the only fact which we know definitely is that it was customary, at least in Kent, for a man to marry his stepmother. In the Kentish laws marriage is represented as hardly more than a matter of purchase; but whether this was the case in the other kingdoms also the evidence at our disposal is insufficient to decide. We know, however, that in addition to the sum paid to the bride's guardian, it was customary for the bridegroom to make a present (*morþengifu*) to the bride herself, which, in the case of queens, often consisted of a residence and considerable estates. Such persons also had retinues and fortified residences of their own. In the Kentish laws provision is made for widows to receive a proportionate share in their husbands' property.

16. *Funeral Rites*.—Both inhumation and cremation were practised in heathen times. The former seems to have prevailed everywhere; the latter, however, was much more common in the more northern counties than in the south, though cases are fairly numerous throughout the valley of the Thames. In *Beowulf* cremation is represented as the prevailing custom. There is no evidence that it was still practised when the Roman and Celtic missionaries arrived, but it is worth noting that according to the tradition given in the Anglo-Saxon Chronicle, Oxfordshire, where the custom seems to have been fairly common, was not conquered before the latter part of the 6th century. The burnt remains were generally, if not always, enclosed in urns and then buried. The urns themselves are of clay, sometimes badly baked, and bear geometrical patterns applied with a punch. They vary considerably in size (from 4 to 12 in. or more in diameter) and closely resemble those found in northern Germany. Inhumation graves are sometimes richly furnished. The skeleton is laid out at full length, generally with the head towards the west or north, a spear at one side and a sword and shield obliquely across the middle. Valuable brooches and other ornaments are often found. In many other cases, however, the grave contained nothing except a small knife and a simple brooch or a few beads. Usually both classes of graves lie below the natural surface of the ground without any perceptible trace of a barrow.

17. *Religion*.—Here again the information at our disposal is very limited. There can be little doubt that the heathen Angli worshipped certain gods, among them *Ti* (Tig), *Woden* (Thunor) and a goddess *Frigg*, from whom the names Tuesday, Wednesday, Thursday and Friday are derived. *Ti* was probably the same god of whom early Roman writers speak under the name *Mars* (see *Tyr*), while *Thunor* was doubtless the thunder-god (see *Thor*). From *Woden* (p. 8) most of the royal families trace their descent. *Seaxneat*, the ancestor of the East Saxon dynasty was also in all probability a god (see *ESSEX, KINGDOM OF*).

Of anthropomorphic representations of the gods we have no clear evidence, though we do hear of shrines in sacred enclosures, at which sacrifices were offered. It is clear also that there were persons specially set apart for the priesthood, who were not allowed to bear arms or to ride except on mares. Notices of sacred trees and groves, springs, stones, &c., are much more frequent than those referring to the gods. We hear also a good deal of witches and valkyries, and of charms and magic; as an instance we may cite the fact that certain (Runic) letters were credited, as in the North, with the power of loosening bonds. It is probable also that the belief in the spirit world and in a future life was of a somewhat similar kind to what we find in Scandinavian religion. (See **TEUTONIC PEOPLES**, §6.)

The chief primary authorities are Gildas, *De Excidio Britanniae*, and Nennius, *Historia Britonum* (ed. San-Marie, Berlin, 1844); Th. Mommsen in *Mon. Germ. Hist., Aed. Antiquiss.*, tom. xiii. (Berlin, 1898); Bede, *Hist. Eccl.* (ed. C. Plummer, Oxford, 1896); the *Saxon Chronicle* (ed. C. Plummer, Oxford, 1892-1899); and the *Anglo-Saxon Laws* (ed. F. Liebermann, Halle, 1903); and *Charters* (W. de G. Birch, *Cartularium Saxonicum*, London, 1885-1893). Modern authorities: Sh. Turner, *History of the Anglo-Saxons* (London, 1799-1805; 7th ed., 1852); Sir F. Palgrave, *Rise and Progress of the English Commonwealth* (London, 1831-1832); J. M. Kemble, *The Saxons in England* (London, 1849; 2nd ed., 1876); K. Maurer, *Kritische Übersicht d. deutschen Gesetzgebung u. Rechtswissenschaft*, vols. i-iii. (Munich, 1853-1855); J. M. Lappenberg, *Geschichte von England* (Hamburg, 1834); *History of England under the Anglo-Saxon Kings* (London, 1845; 2nd ed., 1881); J. R. Green, *The Making of England* (London, 1881); T. Hodgkin, *History of England from the Earliest Times to the Norman Conquest* (vol. i. of *The Political History of England*) (London, 1906); F. Seebohm, *The English Village Community* (London, 1883); A. Meitzen, *Siedelung und Agrarwesen d. Westgermanen, u. Ostgermanen*, &c. (Berlin, 1895); Sir F. Pollock and F. W. Maitland, *History of English Law* (Cambridge, 1895; 2nd ed., 1898); F. W. Maitland, *Domesday Book and Beyond* (Cambridge, 1897); F. Seebohm, *Tribal Custom in Anglo-Saxon Law* (London, 1903); P. Vinogradoff, *The Growth of the Manor* (London, 1905); H. M. Chadwick, *Studies on Anglo-Saxon Institutions* (Cambridge, 1905); *The Origin of the English Nation* (ib., 1907); M. Heyne, *Über die Lage und Construction der Halle Heort* (Paderborn, 1864); R. Henning, *Das deutsche Haus (Quellen u. Forschungen*, 47) (Strasbourg, 1882); M. Heyne, *Deutsche Hausaltertümer*, i., ii., iii. (Leipzig, 1900-1903); G. Baldwin Brown, *The Arts in Early England* (London, 1903); C. F. Keary, *Catalogue of Anglo-Saxon Coins in the British Museum*, vol. I. (London, 1887); C. Roach Smith, *Collectanea Antiqua* (London, 1848-1868); R. C. Neville, *Saxon Obscurities* (London, 1852); J. Y. Akerman, *Remains of Pagan Saxondom* (London, 1853); Baron J. de Baye, *Industrie anglo-saxonne* (Paris, 1890); *The Industrial Arts of the Anglo-Saxons* (London, 1893); G. Stephens, *The Old Northern Runic Monuments* (London and Copenhagen, 1866-1901); W. Vietor, *Die northumbrischen Runensteine* (Marburg, 1895). Reference must also be made to the articles on Anglo-Saxon antiquities in the *Victoria County Histories*, and to various papers in *Archaeologia*, the *Archaeological Journal*, the *Journal of the British Archaeological Society*, the *Proceedings of the Society of Antiquaries*, the *Associated Architectural Societies' Reports*, and other antiquarian journals. (H. M. C.)

BRITANNICUS, son of the Roman emperor Claudius by his third wife Messalina, was born probably A.D. 41. He was originally called Claudius Tiberius Germanicus, and received the name Britannicus from the senate on account of the conquest made in Britain about the time of his birth. Till 48, the date of his mother's execution, he was looked upon as the heir presumptive; but Agrippina, the new wife of Claudius, soon persuaded the feeble emperor to adopt Lucius Domitius, known later as Nero, her son by a previous marriage. After the accession of Nero, Agrippina, by playing on his fears, induced him to poison Britannicus at a banquet (A.D. 55). A golden statue of the young prince was set up by the emperor Titus. Britannicus is the subject of a tragedy by Racine.

Tacitus, *Annals*, xii. 25, 41, xiii. 14-16; Suetonius, *Nero*, 33; Dio Cassius *lx. 32, 34*; works quoted under **NERO**.

BRITISH CENTRAL AFRICA, the general name given to the British protectorates in South Central Africa north of the Zambezi river, but more particularly to a large territory lying between 8° 25' S. on Lake Tanganyika and 17° 6' S. on the river Shiré, near its confluence with the Zambezi, and between 36° 10' E. (district of Mlanje) and 26° 30' E. (river Luengwe-Kafukwe). Originally the term "British Central Africa" was applied by Sir H. H. Johnston to all the territories under British

influence north of the Zambezi which were formerly intended to be under one administration; but the course of events having prevented the connexion of Barotseland (see **BAROTSE**) and the other Rhodesian territories with the more direct British administration north of the Zambezi, the name of British Central Africa was confined officially (in 1893) to the British protectorate on the Shiré and about Lake Nyasa. In 1907 the official title of the protectorate was changed to that of Nyasaland Protectorate, while the titles "North Eastern Rhodesia" and "North Western Rhodesia" (Barotseland) have been given to the two divisions of the British South Africa Company's territory north of the Zambezi. The western boundary, however, of the territory here described has been taken to be a line drawn from near the source of the Luabala on the southern boundary of Belgian Congo to the western source of the Luanga river, and thence the course of the Luanga to its junction with the Luengwe-Kafukwe, after which the main course of the Kafukwe delimits the territory down to the Zambezi. Thus, besides the Nyasaland Protectorate and North Eastern Rhodesia, part of North Western Rhodesia is included, and for the whole of this region British Central Africa is the most convenient designation.

Physical Features.—Within these limits we have a territory of about 250,000 sq. m., which includes two-thirds of Lake Nyasa, the south end of Lake Tanganyika, more than half Lake Mweru, and the whole of Lake Bangweulu, nearly the whole courses of the rivers Shiré and Luangwa (or Loangwa), the whole of the river Chambezi (the most remote of the headwaters of the river Congo), the right or east bank of the Luapula (or upper Congo) from its exit from Lake Bangweulu to its issue from the north end of Lake Mweru; also the river Luanga and the whole course of the Kafue or Kafukwe. Other lesser sheets of water included within the limits of this territory are the Great Mweru Swamp, between Tanganyika and Mweru, Moir's Lake (a small mountain tarn—possibly a crater lake—lying between the Luangwa and the Luapula), Lake Malombe (on the upper Shiré), and the salt lake Chilwa (wrongly styled Shirwa, being the Bantu word *Kūzwa*), which lies on the borders of the Portuguese province of Moçambique. The southern border of this territory is the north bank of the Zambezi from the confluence of the Kafukwe to that of the Luangwa at Zumbo. Eastwards of Zumbo, British Central Africa is separated from the river Zambezi by the Portuguese possessions; nevertheless, considerably more than two-thirds of the country lies within the Zambezi basin, and is included within the subordinate basins of Lake Nyasa and of the rivers Luangwa and Luengwe-Kafukwe. The remaining portions drain into the basins of the river Congo and of Lake Tanganyika, and also into the small lake or half-dried swamp called Chilwa, which at the present time has no outlet, though in past ages it probably emptied itself into the Lujenda river, and thence into the Indian Ocean.

As regards orographical features, much of the country is high plateau, with an average altitude of 3500 ft. above sea-level. Only a very minute portion of its area—the country along the banks of the river Shiré—lies at anything like a low elevation; though the Luangwa valley may not be more than about 900 ft. above sea-level. Lake Nyasa lies at an elevation of 1700 ft. above the sea, is about 350 m. long, with a breadth varying from 15 to 40 m. Lake Tanganyika is about 2600 ft. above sea-level, with a length of about 400 m. and an average breadth of nearly 40 m. Lake Mweru and Lake Bangweulu are respectively 3000 and 3760 ft. above sea-level; Lake Chilwa is 1946 ft. in altitude. The highest mountain found within the limits previously laid down is Mount Mlanje, in the extreme south-eastern corner of the protectorate. This remarkable and picturesque mass is an isolated "chunk" of the Archean plateau, through which at a later date there has been volcanic outburst of basalt. The summit and sides of this mass exhibit several craters. The highest peak of Mlanje reaches an altitude of 9683 ft. (In German territory, near the north end of Lake Nyasa, and close to the British frontier, is Mount Rungwe, the altitude of which exceeds 10,000 ft.) Other high mountains are Mounts Chongone and Dedza, in Angoniland, which reach an altitude of 7000 ft., and points on the Nyika Plateau and in the Konde Mountains to the north-west of Lake Nyasa, which probably exceed a height of 8000 ft. There are also Mounts Zomba (6900 ft.) and Chiradzulu (5500 ft.) in the Shiré Highlands. The principal plateaus or high ridges are (1) the Shiré Highlands, a clump of mountainous country lying between the river Shiré, the river Ruo, Lake Chilwa and the south end of Lake Nyasa; (2) Angoniland—a stretch of elevated country to the west of Lake Nyasa and the north-west of the river

¹The nomenclature of several of these rivers is perplexing. It should be borne in mind that the Luanga (also known as the Lunga) is a tributary of the Luengwe-Kafukwe, itself often called Kafue, and that the Luangwa (or Loangwa) is an independent affluent of the Zambezi (q.v.).

Shiré; (3) the Nyika Plateau, which lies to the north of Angoniland; and (4) the Nyasa-Tanganyika Plateau, between the basin of the river Luangwa, the vicinity of Tanganyika and the vicinity of Lake Mweru (highest point, 7000-8000 ft.). Finally may be mentioned the tract of elevated country between Lake Bangweulu and the river Luapula, and between Lake Bangweulu and the basin of the Luangwa; and also the Lukinga (Mushinga) or Ugwara Mountains of North Western Rhodesia, which attain perhaps to altitudes of 6000 ft.

The whole of this part of Africa is practically without any stretch of desert country, being on the whole favoured with an abundant rainfall. The nearest approach to a desert is the rather dry land to the east and north-east of Lake Mweru. Here, and in parts of the lower Shiré district, the annual rainfall probably does not exceed an average of 35 in. Elsewhere, in the vicinity of the highest mountains, the rainfall may attain an average of 75 in., in parts of Mount Mlanje possibly often reaching to 100 in. in the year. The average may be put at 50 in. per annum, which is also about the average rainfall of the Shiré Highlands, that part of British Central Africa which at present attracts the greatest number of European settlers.

Geology.—The whole formation is Archean and Primary (with a few modern plutonic outbursts), and chiefly consists of granite, felspar, quartz, gneiss, schists, amphibolite and other Archean rocks, with Primary sandstones and limestones in the basin of Lake Nyasa (a great rift depression), the river Shiré, and the regions within the northern watershed of the Zambezi river. Sandstones of Karroo age occur in the basin of the Luangwa (N.E. Rhodesia). There are evidences of recent volcanic activity on the summit of the small Mlanje plateau (S.E. corner of the protectorate; here there are two extinct craters with a basaltic outflow), and at the north end of Lake Nyasa and the eastern edge of the Tanganyika plateau. Here there are many craters and much basalt, or even lava; also hot springs.

Metals and Minerals.—Gold has been found in the Shiré Highlands, in the hills along the Nyasa-Zambezi waterparting, and in the mountainous region west of Lake Nyasa; silver (galena, silver-lead) in the hills of the Nyasa-Zambezi waterparting; lead in the same district; graphite in the western basin of Lake Nyasa; copper (pyrites and pure ore) in the west Nyasa region and in the hills of North Western and North Eastern Rhodesia; iron ore almost universally; mica almost universally; coal occurs in the north and west Nyasa districts (especially in the Karroo sandstones of the Rukuru valley), and perhaps along the Zambezi-Nyasa waterparting; limestone in the Shiré basin; malachite in south-west Angoniland and North Western Rhodesia; and perhaps petroleum in places along the Nyasa-Zambezi waterparting. (See also RHODESIA.)

Flora.—No part of the country comes within the forest region of West Africa. The whole of it may be said to lie within the savannah or park-like division of the continent. As a general rule, the landscape is of a pleasing and attractive character, well covered with vegetation and fairly well watered. Actual forests of lofty trees, forests of a West African type, are few in number, and are chiefly limited to portions of the Nyika, Angoniland and Shiré Highlands plateaus, and to a few nooks in valleys near the south end of Tanganyika. Patches of forest of tropical luxuriance may still be seen on the slopes of Mounts Mlanje and Chiradzulu. On the upper plateaus of Mount Mlanje there are forests of a remarkable conifer (*Widdringtonia whyleri*), a relation of the cypress, which in appearance resembles much more the cedar, and is therefore wrongly styled the "Mlanje cedar." This tree is remarkable as being the most northern form of a group of yew-like conifers confined otherwise to South Africa (Cape Colony). Immense areas in the lower-lying plains are covered by long, coarse grass, sometimes reaching to ft. in height. Most of the West African forest trees are represented in British Central Africa. A full list of the known flora has been compiled by Sir W. Thielton-Dyer and his assistants at Kew, and is given in the first and second editions of Sir H. H. Johnston's work on British Central Africa. Amongst the principal vegetable products of the country interesting for commercial purposes may be mentioned tobacco (partly native varieties and partly introduced); coffee (wild coffee is said to grow in some of the mountainous districts, but the actual coffee cultivated by the European settlers has been introduced from abroad); rubber—derived chiefly from the various species of *Landolphia*, *Ficus*, *Cliandra*, *Carpodinus* and *Conopharygia*, and from other apocynaceous plants; the *Strophanthus* pod (furnishing a valuable drug); ground-nuts (*Arachis* and *Voandzeia*); the cotton plant; all African cultivated cereals (*Sorghum*, *Pennisetum*, maize, rice, wheat—cultivated chiefly by Europeans—and *Eleusine*); and six species of palms—the oil palm on the north-west (near Lake Nyasa, at the south end of Tanganyika and on the Luapula), the *Borassus* and *Hyphaene*, *Phoenix* (or wild date), *Raphia* and the coco-nut palm. The last named was introduced by Arabs and Europeans, and is found on Lake Nyasa and on the lower Shiré. Most of the European vegetables have been introduced, and thrive exceedingly well, especially the potato. The mango has also been introduced from India, and has taken to the Shiré Highlands as to a second home. Oranges, lemons and limes have been planted by Europeans and Arabs in a few districts. European fruit trees do not ordinarily flourish, though apples are grown to some extent at Blantyre. The vine hitherto has proved a failure. Pineapples give the best result

among cultivated fruit, and strawberries do well in the higher districts. In the mountains the native wild brambles give blackberries of large size and excellent flavour. The vegetable product through which this protectorate first attracted trade was coffee, the export of which, however, has passed through very fluctuating fluctuations. In 1905-1906, 773,919 lb of coffee (value £16,123) were exported; but during this twelve months the crop of cotton—quite a newly developed product, rose to 776,621 lb, from 285,185 lb in 1904-1905. An equally marked increase in tobacco and ground-nuts (*Arachis*) has taken place. Beechew is a rising export.

Fauna.—The fauna is on the whole very rich. It has affinities in a few respects with the West African forest region, but differs slightly from the countries to the north and south by the absence of such animals as prefer drier climates, as for instance the oryx antelopes, gazelles and the ostrich. There is a complete blank in the distribution of this last between the districts to the south of the Zambezi and those of East Africa between Victoria Nyanza and the Indian Ocean. The giraffe is found in the Luanga valley; it is also met with in the extreme north-east of the country. The ordinary African rhinoceros is still occasionally, but very rarely, seen in the Shiré Highlands. The African elephant is fairly common throughout the whole territory. Lions and leopards are very abundant; the zebra is still found in great numbers, and belongs to the Central African variety of Burchell's zebra, which is completely striped down to the hoofs, and is intermediate in many particulars between the true zebra of the mountains and Burchell's zebra of the plains. The principal antelopes found are the sable and the roan (*Hippotragus*), five species of *Cobus* or waterbuck (the puku, the Scapa puku, the lechwe, Crawshaw's waterbuck and the common waterbuck); the pallah, *tesabee* (*Demaliticus*), hartebeest, brindbill (perhaps two species), several dyblers (including the large *Cephalopos sylvicallaris*), klipspringer, oribi, steinbok and reedbuck. Among tragelaphs are two or more bushbucks, the inyala, the water tragelaph (*Limonotragus selousi*), the kudu and Livingstone's eland. The only buffalo is the common Cape species. The hyaena is the spotted kind. The hunting dog is present. There are some seven species of monkeys, including two baboons and one colobus. The hippopotamus is found in the lakes and rivers, and all these sheets of water are infested with crocodiles, apparently belonging to but one species, the common Nile crocodile.

Inhabitants.—The human race is represented by only one indigenous native type—the Negro. No trace is anywhere found of a Hamitic intermixture (unless perhaps at the north end of Lake Nyasa, where the physique of the native Awankonde recalls that of the Nilotic negro). Arabs from Zanzibar have settled in the country, but not, as far as is known, earlier than the beginning of the 19th century. As the present writer takes the general term "Negro" to include equally the Bantu, Hottentot, Bushman and Congo Pygmy, this designation will cover all the natives of British Central Africa. The Bantu races, however, exhibit in some parts signs of Hottentot or Bushman intermixture, and there are legends in some mountain districts, especially Mount Mlanje, of the former existence of unmixt Bushman tribes, while Bushman stone implements are found at the south end of Tanganyika. At the present day the population is, as a rule, of a black or chocolate-coloured Negro type, and belongs, linguistically, entirely and exclusively to the Bantu family. The languages spoken offer several very interesting forms of Bantu speech, notably in the districts between the north end of Lake Nyasa, the south end of Lake Tanganyika, and the river Luapula. In the more or less plateau country included within these geographical limits, the Bantu dialects are of an archaic type, and to the present writer it has seemed as though one of them, Kibemba or Kivemba, came near to the original form of the Bantu mother-language, though not nearer than the interesting Subiya of southern Barotseland. Through dialects spoken on the west and north of Tanganyika, these languages of North Eastern Rhodesia and northern Nyassaland and of the Kafukwe basin are connected with the Bantu languages of Uganda. They also offer a slight resemblance to Zulu-Kaffir, and it would seem as though the Zulu-Kaffir race must have come straight down from the countries to the north-east of Tanganyika across the Zambezi, to their present home. Curiously enough some hundreds of years after this southward migration, intestine wars and conflicts actually determined a north-eastward return migration of Zulus. From Matabeleland, Zulu tribes crossed the Zambezi at various periods (commencing from about 1520) and gradually extended their ravages and dominion over the plateaus to the west, north and north-east of Lake Nyasa. The Zulu language is still spoken by the dominating caste in West

Nyasaland (see further ZULULAND: *Ethnology*; RHODESIA: *Ethnology*; and YAOS). As regards foreign settlers in this part of Africa, the Arabs may be mentioned first, though they are now met with only in very small numbers. The Arabs undoubtedly first heard of this rich country—rich not alone in natural products such as ivory, but also in slaves of good quality—from their settlements near the delta of the river Zambezi, and these settlements may date back to an early period, and might be coeval with the suggested pre-Islamite Arab settlements in the gold-bearing regions of South East Africa. But the Arabs do not seem to have made much progress in their penetration of the country in the days before firearms; and when firearms came into use they were for a long time forestalled by the Portuguese, who ousted them from the Zambezi. But about the beginning of the 19th century the increasing power and commercial enterprise of the Arab sultanate of Zanzibar caused the Arabs of Maskat and Zanzibar to march inland from the east coast. They gradually founded strong slave-trading settlements on the east and west coasts of Lake Nyassa, and thence westwards to Tanganyika and the Luapula. They never came in great numbers, however, and, except here and there on the coast of Lake Nyassa, have left no mixed descendants in the population. The total native population of all British Central Africa is about 2,000,000, that of the Nyasaland Protectorate being officially estimated in 1907 at 927,355. Of Europeans the protectorate possesses about 600 to 700 settlers, including some 100 officials. (For the European population of the other territories, see RHODESIA.) The Europeans of British Central Africa are chiefly natives of the United Kingdom or South Africa, but there are a few Germans, Dutchmen, French, Italians and Portuguese. The protectorate has also attracted a number of Indian traders (over 400), besides whom about 150 British Indian soldiers (Sikhs) are employed as the nucleus of an armed force.¹

Trade and Communications.—The total value of the trade of the protectorate in the year 1899-1900 was £255,384, showing an increase of 75% on the figures for the previous year, 1898-1899. Imports were valued at £176,035, an increase of 62%, and exports at £79,449, an increase of 109%. In 1905-1906 the imports reached £222,581 and the exports £56,778. The value of imports into the Rhodesian provinces during the same period was about £50,000, excluding railway material, and the exports £18,000. The principal exports are (besides minerals) coffee, cotton, tobacco, rubber and ivory. A number of Englishmen and Scotsmen (perhaps 200) are settled, mainly in the Shiré Highlands, as coffee planters.

From the Chinde mouth of the Zambezi to Port Herald on the lower Shiré communication is maintained by light-draught steamers, though in the dry season (April-November) steamers cannot always ascend as far as Port Herald, and barges have to be used to complete the voyage. A railway runs from Port Herald to Blantyre, the commercial capital of the Shiré Highlands. The "Cape to Cairo" railway, which crossed the Zambezi in 1905 and the Kafukwe in 1906, reached the Broken Hill mine in 1907, and in 1909 was continued to the frontier of Belgian Congo. There are regular services by steamer between the ports on Lakes Nyassa and Tanganyika. The African trans-continental telegraph line (founded by Cecil Rhodes) runs through the protectorate, and a branch line has been established from Lake Nyassa to Fort Jameson, the present headquarters of the Chartered Company in North Eastern Rhodesia.

Towns.—The principal European settlement or town is Blantyre (see), at a height of about 3000 ft. above the sea, in the Shiré Highlands. This place was named after Livingstone's birthplace, and was founded in 1876 by the Church of Scotland mission. The government capital of the protectorate, however, is Zomba, at the base of the mountain of that name. Other townships or sites of European settlements are Port Herald (on the lower Shiré), Chiromo (at the junction of the Ruo and the Shiré), Fort Anderson (on Mount Mlanje), Fort Johnston (near the outlet of the river Shiré from the south end of Lake Nyassa), Kotakota and Bandawe (on the west coast of Lake Nyassa), Likoma (on an island off the east coast of Lake Nyassa), Karonga (on the north-west coast of Lake Nyassa), Fife (on the Nyassa-Tanganyika plateau), Fort Jameson (capital of N.E. Rhodesia, near the river Luangwa), Abercorn (on the south east of Lake Tanganyika), Kalungwisi (on the east coast of Lake Mweru) and Fort Rosebery (near the Johnston Falls on the Luapula upper Congo).

Administration.—The present political divisions of the country

are as follows:—The Nyasaland Protectorate, *i.e.* the districts surrounding Lake Nyassa and the Shiré province, are administered directly under the imperial government by a governor, who acts under the orders of the colonial office. The governor is assisted by an executive council and by a nominated legislative council, which consists of at least three members. The districts to the westward, forming the provinces of North Eastern and North Western Rhodesia, are governed by two administrators of the British South Africa Chartered Company, in consultation with the governor of Nyasaland and the colonial office.

History.—The history of the territory dealt with above is recent and slight. Apart from the vague Portuguese wanderings during the 16th and 17th centuries, the first European explorer of any education who penetrated into this country was the celebrated Portuguese official, Dr F. J. M. de Lacerda e Almeida, who journeyed from Tete on the Zambezi to the vicinity of Lake Mweru. But the real history of the country begins with the advent of David Livingstone, who in 1859 penetrated up the Shiré river and discovered Lake Nyassa. Livingstone's subsequent journeys, to the south end of Tanganyika, to Lake Mweru and to Lake Bangweulu (where he died in 1873), opened up this important part of South Central Africa and centred in it British interests in a very particular manner. Livingstone's death was soon followed by the entry of various missionary societies, who commenced the evangelization of the country; and these missionaries, together with a few Scottish settlers, steadily opposed the attempts of the Portuguese to extend their sway in this direction from the adjoining provinces of Mozambique and of the Zambezi. From out of the missionary societies grew a trading company, the African Lakes Trading Corporation. This body came into conflict with a number of Arabs who had established themselves on the north end of Lake Nyassa. About 1885 a struggle began between Arab and Briton for the possession of the country, which was not terminated until the year 1896. The African Lakes Corporation in its unofficial war enlisted volunteers, amongst whom were Captain (afterwards Sir F. D.) Lugard and Mr (afterwards Sir) Alfred Sharpe. Both these gentlemen were wounded, and the operations they undertook were not crowned with complete success. In 1889 Mr (afterwards Sir) H. H. Johnston was sent out to endeavour to effect a possible arrangement of the dispute between the Arabs and the African Lakes Corporation, and also to ensure the protection of friendly native chiefs from Portuguese aggression beyond a certain point. The outcome of these efforts and the treaties made was the creation of the British protectorate and sphere of influence north of the Zambezi (see AFRICA: § 5). In 1891 Johnston returned to the country as imperial commissioner and consul-general. In the interval between 1889 and 1891 Mr Alfred Sharpe, on behalf of Cecil Rhodes, had brought a large part of the country into treaty with the British South Africa Company. These territories (Northern Rhodesia) were administered for four years by Sir Harry Johnston in connexion with the British Central Africa protectorate. Between 1891 and 1895 a long struggle continued, between the British authorities on the one hand and the Arabs and Mahomedan Yaos on the other, regarding the suppression of the slave trade. By the beginning of 1896 the last Arab stronghold was taken and the Yaos were completely reduced to submission. Then followed, during 1896-1898, wars with the Zulu (Angoni) tribes, who claimed to dominate and harass the native populations to the west of Lake Nyassa. The Angoni having been subdued, and the British South Africa Company having also quelled the turbulent Awemba and Bashukulumbwe, there is a reasonable hope of the country enjoying a settled peace and considerable prosperity. This prospect has been, indeed, already realized to a considerable extent, though the increase of commerce has scarcely been as rapid as was anticipated. In 1897, on the transference of Sir Harry Johnston to Tunis, the commissionership was conferred on Mr Alfred Sharpe, who was created a K.C.M.G. in 1903. In 1904 the administration of the protectorate, originally directed by the foreign office, was transferred to the colonial office. In 1907, on the change in the title of the protectorate, the designation of the chief official was altered from commissioner to governor, and executive and legislative councils were established. The mineral

¹ The organized armed forces and police are under the direction of the imperial government throughout British Central Africa, and number about 880 (150 Sikhs, 730 negroes and 14 British officers).

surveys and railway construction commenced under the foreign office were carried on vigorously under the colonial office. The increased revenue, from £51,000 in 1901-1902 to £76,000 in 1905-1906, for the protectorate alone (see also RHODESIA), is an evidence of increasing prosperity. Expenditure in excess of revenue is met by grants in aid from the imperial exchequer, so far as the Nyasaland Protectorate is concerned. The British South Africa Company finances the remainder. The native population is well disposed towards European rule, having, indeed, at all times furnished the principal contingent of the armed force with which the African Lakes Company, British South Africa Company or the British government endeavoured to oppose Arab, Zulu or Awemba aggression. The protectorate government maintains three gunboats on Lake Nyasa, and the British South Africa Company an armed steamer on Lake Tanganyika.

Unfortunately, though so rich and fertile, the land is not as a rule very healthy for Europeans, though there are signs of improvement in this respect. The principal scourges are black-water fever and dysentery, besides ordinary malarial fever, malarial ulcers, pneumonia and bronchitis. The climate is agreeable, and except in the low-lying districts is never unbearably hot; while on the high mountain plateaus frost frequently occurs during the dry season.

See *Narrative of an Expedition to the Zambezi, &c.*, by David and Charles Livingstone (1865); *Last Journals of David Livingstone*, edited by the Rev. Horace Waller (1874); L. Monteith Fotheringham, *Adventures in Nyasaland* (1891); Henry Drummond, *Tropical Africa* (4th ed., 1891); Rev. D. C. Scott, *An Encyclopaedic Dictionary of the Mang'anya Language, as spoken in British Central Africa* (1891); Sir H. H. Johnston, *British Central Africa* (2nd ed., 1898); Miss A. Werner, *The Notices of British Central Africa* (1906); John Buchanan, *The Shiré Highlands* (1885); Lionel Dédie, *Three Years in Savage Africa* (1895); H. L. Duff, *Nyasaland under the Foreign Office* (1903); J. E. S. Moore, *The Tanganyika Problem* (1904); articles on North Eastern and North Western Rhodesia (chiefly by Frank Melland) in the *Journal of the African Society* (1902-1906); annual *Reports on British Central Africa* published by the Colonial Office; various linguistic works by Miss A. Werner, the Rev. Govan Robertson, Dr R. Laws, A. C. Madan, Father Torrend and Monsieur E. Jacotet. (H. H. J.)

BRITISH COLUMBIA, the western province of the Dominion of Canada. It is bounded on the east by the continental watershed in the Rocky Mountains, until this, in its north-westerly course, intersects 120° W., which is followed north to 60° N., thus including within the province a part of the Peace river country to the east of the mountains. The southern boundary is formed by 49° N. and the strait separating Vancouver Island from the state of Washington. The northern boundary is 60° N., the western the Pacific Ocean, upon which the province fronts for about 600 m., and the coast strip of Alaska for a further distance of 400 m. Vancouver Island and the Queen Charlotte Islands, as well as the smaller islands lying off the western coast of Canada, belong to the province of British Columbia.

Physical Features.—British Columbia is essentially a mountainous country, for the Rocky Mountains which in the United States lie to the east of the Great Basin, on running to the north bear toward the west and approach the ranges which border the Pacific coast. Thus British Columbia comprises practically the entire width of what has been termed the Cordillera or Cordilleran belt of North America, between the parallels of latitude above indicated. There are two ruling mountain systems in this belt—the Rocky Mountains proper on the north-east side, and the Coast Range on the south-west or Pacific side. Between these are subordinate ranges to which various local names have been given, as well as the "Interior Plateau"—an elevated tract of hilly country, the hill summits having an accordant altitude, which lies to the east of the Coast Range. The several ranges, having been produced by successive foldings of the earth's crust in a direction parallel to the border of the Pacific Ocean, have a common trend which is south-east and north-west. Vancouver Island and the Queen Charlotte Islands are remnants of still another mountain range, which runs parallel to the coast but is now almost entirely submerged beneath the waters of the Pacific. The province might be said to consist of a series of parallel mountain ranges with long narrow valleys lying between them.

The Rocky Mountains are composed chiefly of palaeozoic sediments ranging in age from the Cambrian to the Carboniferous, with subordinate folded areas of Cretaceous which hold coal. The average height of the range along the United States boundary is 8000 ft., but the range culminates between the latitudes of 51° and 53°, the highest peak in the Canadian Rockies being Mount Robson, 13,700

ft., although the highest peak in British Columbia is Mount Fairweather on the International Boundary, which rises to 15,287 ft. Other high peaks in the Rocky Mountains of Canada are Columbia, 12,740 ft.; Forbes, 12,075; Assiniboine, 11,860; Bryce, 11,686; Temple, 11,626; Lyell, 11,463. There are a number of passes over the Rocky Mountains, among which may be mentioned, beginning from the south, the South Kootenay or Boundary Pass, 7100 ft.; the Crow's Nest Pass, 5500 (this is traversed by the southern branch of the Canadian Pacific railway and crosses great coal fields); the Kicking Horse or Wapta Pass, 5300 (which is traversed by the main line of the Canadian Pacific railway); the Athabasca Pass, 6025; the Yellow Head Pass, 3733 (which will probably be used by the Grand Trunk Pacific railway); the Pine River Pass, 2850; and the Peace River Pass, 2000, through which the Peace river flows.

The Coast Range, sometimes called the Cascade Range, borders the Pacific coast for 900 m. and gives to it its remarkable character. To its partially submerged transverse valleys are due the excellent harbours on the coast, the deep sounds and inlets which penetrate far inland at many points, as well as the profound and gloomy fjords and the stupendous precipices which render the coast line an exaggerated reproduction of that of Norway. The coast is, in fact, one of the most remarkable in the world, measuring with all its indentations 7000 m. in the aggregate, and being fringed with an archipelago of innumerable islands, of which Vancouver Island and the Queen Charlotte Islands are the largest.

Along the south-western side of the Rocky Mountains is a very remarkable valley of considerable geological antiquity, in which some seven of the great rivers of the Pacific slope, among them the Kootenay, Columbia, Fraser and Finlay, flow for portions of their upper courses. This valley, which is from 1 to 6 m. in width, can be traced continuously for a length of at least 800 m. One of the most important rivers of the province is the Fraser, which, rising in the Rocky Mountains, flows for a long distance to the north-west, and then turning south eventually crosses the Coast Range by a deep canyon-like valley and empties into the Strait of Georgia, a few miles south of the city of Vancouver. The Columbia, which rises farther south in the same range, flows north for about 150 m., crossing the main line of the Canadian Pacific railway at Donald, and then bending abruptly back upon its former course, flows south, recrossing the Canadian Pacific railway at Revelstoke, and on through the Arrow Lakes in the Kootenay country into the United States, emptying into the Pacific Ocean at Astoria in the state of Oregon. These lakes, as well as the other large lakes in southern British Columbia, remain open throughout the winter. In the north-western part of the province the Skeena flows south-west into the Pacific, and still farther to the north the Stikine rises in British Columbia, but before entering the Pacific crosses the coast strip of Alaska. The Liard, rising in the same district, flows east and falls into the Mackenzie, which empties into the Arctic Ocean. The headwaters of the Yukon are also situated in the northern part of the province. All these rivers are swift and are frequently interrupted by rapids, so that, as means of communication for commercial purposes, they are of indifferent value. Wherever lines of railway are constructed, they lose whatever importance they may have held in this respect previously.

At an early stage in the Glacial period British Columbia was covered by the Cordilleran glacier, which moved south-eastwards and north-westwards, in correspondence with the ruling features of the country, from a gathering-ground situated in the vicinity of the 57th parallel. Ice from this glacier poured through passes in the coast ranges, and to a lesser extent debouched upon the edge of the great plains, beyond the Rocky Mountain range. The great valley between the coast ranges and Vancouver Island was also occupied by a glacier that moved in both directions from a central point in the vicinity of Valdez Island. The effects of this glacial action and of the long periods of erosion preceding it and of other physiographic changes connected with its passing away, have most important bearings on the distribution and character of the gold-bearing alluviums of the province.

Climate.—The subjoined figures relating to temperature and precipitation are from a table prepared by Mr R. F. Stupart, director of the meteorological service. The station at Victoria may be taken as representing the conditions of the southern part of the coast of British Columbia, although the rainfall is much greater on exposed parts of the outer coast. Agassiz represents the Fraser delta and Kamloops the southern interior district. The mean temperature naturally decreases to the northward of these selected stations, both along the coast and in the interior, while the precipitation increases. The figures given for Fort Simpson are of interest, as the Pacific terminus of the Grand Trunk Pacific railway will be in this vicinity.

Fauna.—Among the larger mammals are the big-horn or mountain sheep (*Ovis montanus*), the Rocky Mountain goat (*Capra montanus*), the grizzly bear, moose, woodland caribou, black-tailed or mule deer, white-tailed deer, and coyote. All these are to be found only on the mainland. The black bear, wolf, puma, lynx, wapiti, and Columbian or coast deer are common to parts of both mainland and islands. Of marine mammals the most characteristic are the sea-lion, fur-seal, sea-otter and harbour-seal. About 340 species of birds are known to occur in the province, among which, as of special interest, may be mentioned the burrowing owl of the dry, interior region, the

	Mean Temp., Fahr.			Absolute Temperature.		Rainfall—Inches.		
	Coldest Month.	Warmest Month.	Average Annual.	Highest.	Lowest.	Wettest Month.	Driest Month.	Average Annual.
Victoria ¹	Jan. 37.5°	July 60.3°	48.8°	90°	-1°	Dec. 7.98	July .4	37.77
Agassiz ²	Jan. 33.0°	Aug. 64.7°	48.9°	97°	-13°	Dec. 9.43	July 1.55	66.85
Kamloops ³	Jan. 24.2°	Aug. 68.5°	47.1°	101°	-27°	July 1.61	April .37	11.46
Port Simpson ⁴	Jan. 34.9°	Aug. 56.9°	45.1°	88°	-10°	Oct. 12.42	June 4.37	94.63

American magpie, Steller's jay and a true nut-cracker, Clark's crow (*Picicorvus columbianus*). True jays and orioles are also well represented. The gallinaceous birds include the large blue grouse of the coast, replaced in the Rocky Mountains by the dusky grouse. The western form of the "spruce partridge" of eastern Canada is also abundant, together with several forms referred to the genus *Bonasa*, generally known as "partridges" or ruffed grouse. Ptarmigans also abound in many of the higher mountain regions. Of the *Anasidae* only passing mention need be made. During the spring and autumn migrations many species are found in great abundance, but in the summer a smaller number remain to breed, chief among which are the teal, mallard, wood-duck, spoon-bill, pin-tail, buff-head, red-head, canvas-back, scaup-duck, &c.

Area and Population.—The area of British Columbia is 357,600 sq. m., and its population by the census of 1901 was 190,000. Since that date this has been largely increased by the influx of miners and others, consequent upon the discovery of precious metals in the Kootenay, Boundary and Atlin districts. Much of this is a floating population, but the opening up of the valleys by railway and new lines of steamboats, together with the settlements made in the vicinity of the Canadian Pacific railway, has resulted in a considerable increase of the permanent population. The white population comprises men of many nationalities. There is a large Chinese population, the census of 1901 returning 14,201. The influx of Chinamen has, however, practically ceased, owing to the tax of \$500 per head imposed by the government of the dominion. Many Japanese have also come in. The Japanese are engaged chiefly in lumbering and fishing, but the Chinese are found everywhere in the province. Great objection is taken by the white population to the increasing number of "Mongolians," owing to their competition with whites in the labour markets. The Japanese do not appear to be so much disliked, as they adapt themselves to the ways of white men, but they are equally objected to on the score of cheap labour; and in 1907-1908 considerable friction occurred with the Dominion government over the Anti-Japanese attitude of British Columbia, which was shown in some rather serious riots. In the census of 1901 the Indian population is returned at 25,488; of these 20,351 are professing Christians and 5137 are pagans. The Indians are divided into very many tribes, under local names, but fall naturally on linguistic grounds into a few large groups. Thus the southern part of the interior is occupied by the Salish and Kootenay, and the northern interior by the Timneh or Athapackan people. On the coast are the Haida, Tsimshian, Kwakiatl, Nootka, and about the Gulf of Georgia various tribes related to the Salish proper. There is no treaty with the Indians of British Columbia, as with those of the plains, for the relinquishment of their title to the land, but the government otherwise assists them. There is an Indian superintendent at Victoria, and under him are nine agencies throughout the province to attend to the Indians—relieving their sick and destitute, supplying them with seed and implements, settling their disputes and administering justice. The Indian fishing stations and burial grounds are reserved, and other land has been set apart for them for agricultural and pastoral purposes. A number of schools have been established for their education. They were at one time a dangerous element, but are now quiet and peaceable.

The chief cities are Victoria, the capital, on Vancouver Island; and Vancouver on the mainland, New Westminster on the Fraser and Nanaimo on Vancouver Island. Rossland and

¹ 48° 24' N., 123° 19' W., height 85 ft.

² 49° 14' N., 121° 31' W., height 52 ft.

³ 50° 41' N., 120° 29' W., height 1193 ft.

⁴ 54° 34' N., 130° 26' W., height 26 ft.

Nelson in West Kootenay, as well as Fernie in East Kootenay and Grand Forks in the Boundary district, are also places of importance.

Mining.—Mining is the principal industry of British Columbia. The country is rich in gold, silver, copper, lead and coal, and has also iron deposits. From 1804 to 1904 the mining output increased from \$4,225,717 to \$18,077,359. In 1905 it had reached \$22,460,295. The principal minerals, in order of value of output, are gold, copper, coal, lead and silver. Between 1858—the year of the placer discoveries on the Fraser river and in the Cariboo district—and 1882, the placer yields were much heavier than in subsequent years, running from one to nearly four million dollars annually, but there was no quartz mining. Since 1899 placer mining has increased considerably, although the greater part of the return has been from lode mining. The Rossland, the Boundary and the Kootenay districts are the chief centres of vein-mining, yielding auriferous and cupriferos sulphide ores, as well as large quantities of silver-bearing lead ores. Ores of copper and the precious metals are being prospected and worked also, in several places along the coast and on Vancouver Island. The mining laws are liberal, and being based on the experience gained in the adjacent mining centres of the Western States, are convenient and effective. The most important smelting and reducing plants are those at Trail and Nelson in the West Kootenay country, and at Grand Forks and Greenwood in the Boundary district. There are also numerous concentrating plants. Mining machinery of the most modern types is employed wherever machinery is required.

The province contains enormous supplies of excellent coal, most of which are as yet untouched. It is chiefly of Cretaceous age. The producing collieries are chiefly on Vancouver Island and on the western slope of the Rockies near the Crow's Nest Pass in the extreme south-eastern portion of the provinces. Immense beds of high grade bituminous coal and semi-anthracite are exposed in the Bulkley Valley, south of the Skeena river, not far from the projected line of the Grand Trunk Pacific railway. About one-half the coal mined is exported to the United States.

Fisheries.—A large percentage of the commerce is derived from the sea, the chief product being salmon. Halibut, cod (several varieties), oolachan, sturgeon, herring, shad and many other fishes are also plentiful, but with the exception of the halibut these have not yet become the objects of extensive industries. There are several kinds of salmon, and they run in British Columbia waters at different seasons of the year. The quinnat or spring salmon is the largest and best table fish, and is followed in the latter part of the summer by the sockeye, which runs in enormous numbers up the Fraser and Skeena rivers. This is the fish preferred for canning. It is of brighter colour, more uniform in size, and comes in such quantities that a constant supply can be reckoned upon by the canneries. About the mouth of the Fraser river from 1800 to 2600 boats are occupied during the run. There is an especially large run of sockeye salmon in the Fraser river every fourth year, while in the year immediately following there is a poor run. The silver salmon or coho arrives a little later than the sockeye, but is not much used for packing except when required to make up deficiencies. The dog-salmon is not canned, but large numbers are caught by the Japanese, who salt them for export to the Orient. The other varieties are of but little commercial importance at present, although with the increasing demand for British Columbia salmon, the fishing season is being extended to cover the runs of all the varieties of this fish found in the waters of the province.

Great Britain is the largest but not the only market for British Columbia salmon. The years vary in productiveness, 1901 having been unusually large and 1903 the smallest in eleven years, but the average pack is about 700,000 cases of forty-eight 1-lb tins, the greater part of all returns being from the Fraser river canneries, the Skeena river and the Rivers Inlet coming next in order. There are between 60 and 70 canneries, of which about 40 are on the banks of

the Fraser river. There is urgent need for the enactment of laws restricting the catch of salmon, as the industry is now seriously threatened. The fish oils are extracted chiefly from several species of dog-fish, and sometimes from the basking shark, as well as from the colchican, which is also an edible fish.

The fur-seal fishery is an important industry, though apparently a declining one. Owing to the scarcity of seals and international difficulties concerning pelagic sealing in Bering Sea, where the greatest number have been taken, the business of seal-hunting is losing favour. Salmon fish-hatcheries have been established on the chief rivers frequented by these fish. Oysters and lobsters from the Atlantic coast have been planted in British Columbia waters.

Timber.—The province is rich in forest growth, and there is a steady demand for its lumber in the other parts of Canada as well as in South America, Africa, Australia and China. The following is a list of some of the more important trees—large leaved maple (*Acer macrophyllum*), red alder (*Alnus rubra*), western larch (*Larix occidentalis*), white spruce (*Picea alba*), Engelmann's spruce (*Picea Engelmannii*), Menzies's spruce (*Picea sitchensis*), white mountain pine (*Pinus monticola*), black pine (*Pinus murryana*), yellow pine (*Pinus ponderosa*), Douglas fir (*Pseudotsuga Douglasii*), western white oak (*Quercus garryana*), giant cedar (*Thuja gigantea*), yellow cypress or cedar (*Thuja excelsa*), western hemlock (*Tsuga mertensiana*). The principal timber of commerce is the Douglas fir. The tree is often found 300 ft. high and from 8 to 10 ft. in diameter. The wood is tough and strong and highly valued for ships' spars as well as for building purposes. Red or giant cedar, which rivals the Douglas fir in girth, is plentiful, and is used for shingles as well as for interior work. The western white spruce is also much employed for various purposes. There are about eighty sawmills, large and small, in the province. The amount of timber cut on Dominion government lands in 1904 was 22,760,222 ft., and the amount cut on provincial lands was 325,271,568 ft., giving a total of 348,031,790 ft. In 1905 the cut on dominion lands exceeded that in 1904, while the amount cut on provincial lands reached 450,385,554 ft. The cargo shipments of lumber for the years 1904 and 1905 were as follows:—

	1904.	1905.
	Ft.	Ft.
United Kingdom	7,498,301	13,690,869
South America	15,647,808	13,332,993
Australia	10,045,094	11,596,482
South Africa	2,517,154	7,093,681
China and Japan	4,802,426	4,787,784
Germany		983,342
Fiji Islands	308,332	29,949
France	1,308,662	
	42,199,777	51,515,100

There is a very large market for British Columbia lumber in the western provinces of Canada.

Agriculture.—Although mountainous in character the province contains many tracts of good farming land. These lie in the long valleys between the mountain ranges of the interior, as well as on the lower slopes of the mountains and on the deltas of the rivers running out to the coast. On Vancouver Island also there is much good farming land. The conditions are in most places best suited to mixed farming; the chief crops raised are wheat, oats, potatoes and hay. Some areas are especially suited for cattle and sheep raising, among which may be mentioned the Yale district and the country about Kamloops. Much attention has been given to fruit raising, especially in the Okanagan valley. Apples, plums and cherries are grown, as well as peaches, apricots, grapes and various small fruits, notably strawberries. All these are of excellent quality. Hops are also cultivated. A large market for this fruit is opening up in the rapidly growing provinces of Alberta and Saskatchewan.

Imports and Exports.—For the year ending June 30th 1905 the total exports and imports (showing a slight gradual increase on the two preceding years) were valued at \$16,677,882 and \$12,565,019 respectively. The exports were classified as follows:—Minerals, \$9,777,423; fisheries, \$2,101,533; forests, \$1,046,718; animals, \$471,231; agriculture, \$119,426; manufactures, \$1,883,777; miscellaneous, \$1,106,643; coin and bullion, \$171,131.

Railways.—The Pacific division of the Canadian Pacific railway enters British Columbia through the Rocky Mountains on the east and runs for about 500 m. across the province before reaching the terminus at Vancouver. A branch of the same railway leaves the main line at Medicine Hat, and running to the south-west, crosses the Rocky Mountains through the Crow's Nest Pass, and thus enters British Columbia a short distance north of the United States boundary. This continues across the province, running approximately parallel to the boundary as far as Midway in what is known as the Boundary district. The line has opened up extensive coal fields and crosses a productive mining district. On Vancouver Island there are two railways, the Esquimalt & Nanaimo railway (78 m.) connecting the coal fields with the southern ports, and the Victoria & Sydney railway, about 16 m. in length. The Great Northern has also a number of short lines in the southern portion of the province, connecting with its system in the United States. In 1905 there were

1627 m. of railway in the province, of which 1187 were owned or controlled by the Canadian Pacific Railway.

Shipping.—The Canadian Pacific Railway Company has two lines of mail steamer running from Vancouver and Victoria: (1) the Empress line, which runs to Japan and China once in three weeks, and (2) the Australian line to Honolulu, Fiji and Sydney, once a month. The same company also has a line of steamers running to Alaska, as well as a fleet of coasting steamers.

Government.—The province is governed by a lieutenant-governor, appointed by the governor-general in council for five years, but subject to removal for cause, an executive council of five ministers, and a single legislative chamber. The executive council is appointed by the lieutenant-governor on the advice of the first minister, and retains office so long as it enjoys the support of a majority of the legislature. The powers of the lieutenant-governor in regard to the provincial government are analogous to those of governor-general in respect of the dominion government.

The British North America Act (1867) confederating the colonies, defines the jurisdiction of the provincial legislature as distinguished from that of the federal parliament, but within its own jurisdiction the province makes the laws for its own governance. The act of the legislature may be disallowed, within one year of its passage, by the governor-general in council, and is also subject to challenge as to its legality in the supreme court of Canada or on appeal to the judicial committee of the privy council of the United Kingdom. British Columbia sends three senators and seven members to the lower house of the federal parliament, which sits at Ottawa.

Justice.—There is a supreme court of British Columbia presided over by a chief justice and five puisne judges, and there are also a number of county courts. In British Columbia the supreme court has jurisdiction in divorce cases, this right having been invested in the colony before confederation.

Religion and Education.—In 1901 the population was divided by creeds as follows: Church of England, 40,687; Methodists, 25,047; Presbyterians, 34,081; Roman Catholic, 33,659; others, 40,197; not stated, 5003; total, 178,654. The educational system of British Columbia differs slightly from that of other provinces of Canada. There are three classes of schools—common, graded and high—all maintained by the government and all free and un denominational. There is only one college in the province, the "McGill University College of British Columbia" at Vancouver, which is one of the colleges of McGill University, whose chief seat is at Montreal. The schools are controlled by trustees selected by the ratepayers of each school district, and there is a superintendent of education acting under the provincial secretary.

Finance.—Under the terms of union with Canada, British Columbia receives from the dominion government annually a certain contribution, which in 1905 amounted to \$307,076. This, with provincial taxes on real property, personal property, income tax, sales of public land, timber dues, &c., amounted in the year 1905 to \$2,920,461. The expenditure for the year was \$2,302,417. The gross debt of the province in 1905 was \$13,252,097, with assets of \$4,461,869, or a net debt of \$8,788,228. These assets do not include new legislative buildings or other public works. The income tax is on a sliding scale. In 1899 a fairly close estimate was made of the capital invested in the province, which amounted to \$97,345,000, including timber, \$100,000,000; railways and telegraphs, \$47,500,000; mining plant and smelters, \$10,500,000; municipal assessments, \$45,000,000; provincial assessments, \$51,500,000; in addition to private wealth, \$280,000,000. There are branch offices of one or more of the Canadian banks in each of the larger towns.

History.—The discovery of British Columbia was made by the Spaniard Perez in 1774. With Cook's visit the geographical exploration of the coast began in 1778. Vancouver, in 1792-1794, surveyed almost the entire coast of British Columbia with much of that to the north and south, for the British government. The interior, about the same time, was entered by Mackenzie and traders of the N.W. Company, which in 1821 became amalgamated with the Hudson's Bay Company. For the next twenty-eight years the Hudson's Bay Company ruled this immense territory with beneficent despotism. In 1849 Vancouver Island was proclaimed a British colony. In 1858, consequent on the discovery of gold and the large influx of miners, the mainland territory was erected into a colony under the name of British Columbia, and in 1866 this was united with the colony of Vancouver Island, under the same name. In 1871 British Columbia entered the confederation and became part of the Dominion of Canada, sending three senators and six (now seven) members to the House of Commons of the federal parliament. One of the conditions under which the colony entered the dominion was the speedy construction of the Canadian Pacific railway, and in 1876 the non-fulfilment of this promise and the apparent indifference of the government at Ottawa to the representations of British Columbia created

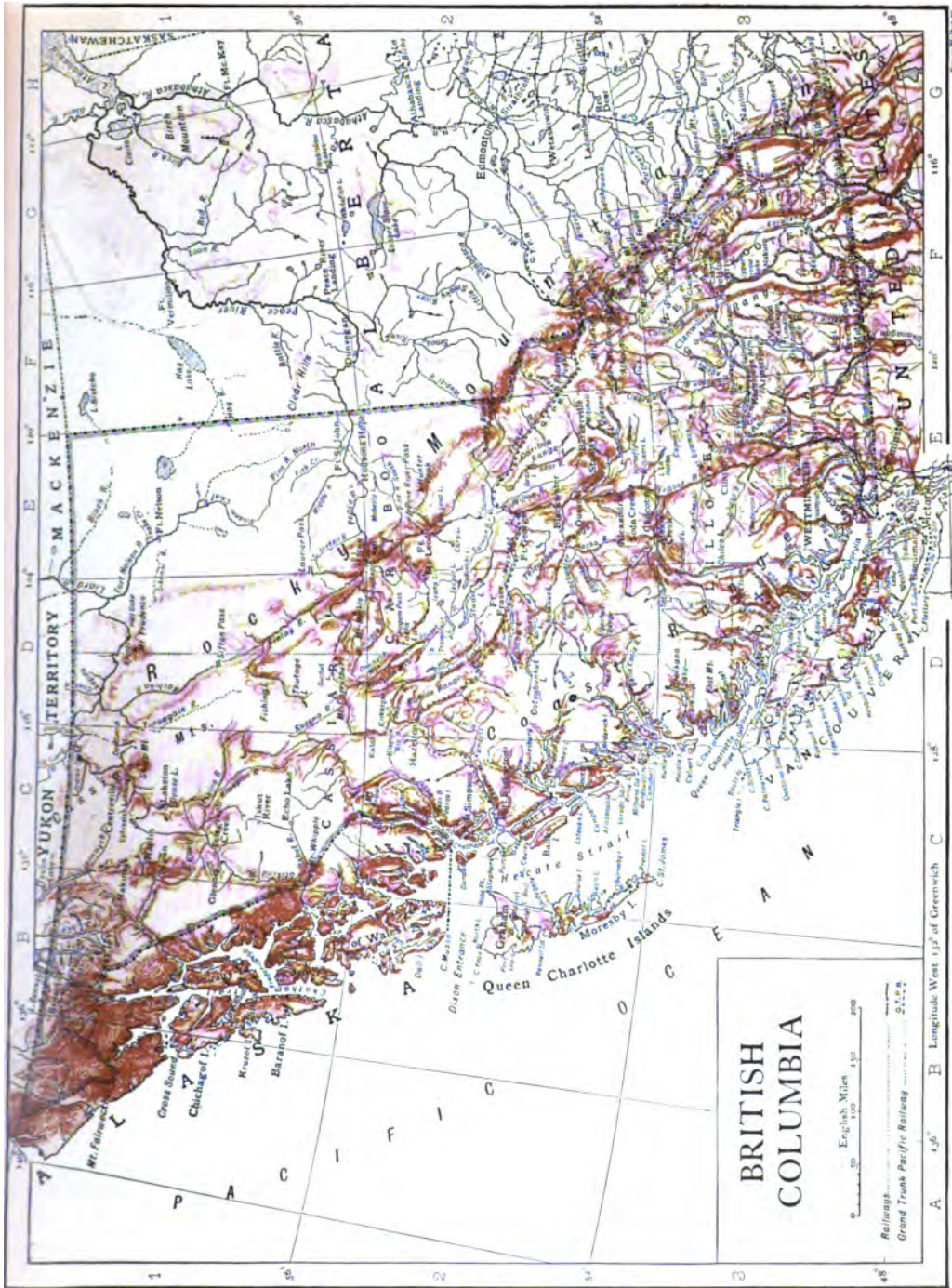

BRITISH COLUMBIA

English Miles
0 50 100 200

Railways
Grand Trunk Pacific Railway

A 130° Longitude West 132° of Greenwich C

strained relations, which were only ameliorated when the construction of a transcontinental road was begun. In subsequent years the founding of the city of Vancouver by the C.P.R., the establishment of the first Canadian steamship line to China and Japan, and that to Australia, together with the disputes with the United States on the subject of pelagic sealing, and the discovery of the Kootenay and Boundary mining districts, have been the chief events in the history of the province.

AUTHORITIES.—Cook's *Voyage to the Pacific Ocean* (London, 1784); Vancouver, *Voyage of Discovery to the Pacific Ocean* (London, 1798); H. H. Bancroft's works, vol. xxxii., *History of British Columbia* (San Francisco, 1887); Begg's *History of British Columbia* (Toronto, 1894); Gosnell, *Year Book* (Victoria, British Columbia, 1897 and 1903); *Annual Reports British Columbia Board of Trade* (Victoria); *Annual Reports of Minister of Mines and other Departmental Reports of the Provincial and Dominion Governments*; *Catalogue of Provincial Museum* (Victoria); *Reports Geological Survey of Canada* (from 1871 to date); *Reports of Canadian Pacific (Government) Surveys* (1872-1880); *Reports of Committee of Brit. Assn. Adv. Science on N.W. Tribes* (1884-1895); Lord, *Naturalist in Vancouver Island* (London, 1866); *Bering Sea Arbitration* (reprint of letters to Times), (London, 1893); *Report of Bering Sea Commission* (London, Government, 1892); A. Mélin, *La Colombie Britannique* (Paris, 1908). See also various works of reference under CANADA. (G. M. D.; M. St J.; F. D. A.)

BRITISH EAST AFRICA, a term, in its widest sense, including all the territory under British influence on the eastern side of Africa between German East Africa on the south and Abyssinia and the Anglo-Egyptian Sudan on the north. It comprises the protectorates of Zanzibar, Uganda and East Africa. Apart from a narrow belt of coastland, the continental area belongs almost entirely to the great plateau of East Africa, rarely falling below an elevation of 2000 ft., while extensive sections rise to a height of 6000 to 8000 ft. From the coast lowlands a series of

steps with intervening plateaus leads to a broad zone of high ground remarkable for the abundant traces of volcanic action. This broad upland is furrowed by the eastern "rift-valley," formed by the subsidence of its floor and occupied in parts by lakes without outlet. Towards the west a basin of lower elevation is partially occupied by Victoria Nyanza, drained north to the Nile, while still farther inland the ground again rises to a second volcanic belt, culminating in the Ruwenzori range. (See ZANZIBAR, and for Uganda protectorate see UGANDA.) The present article treats of the East Africa protectorate only.

Topography.—The southern frontier, coterminous with the northern frontier of German East Africa, runs north-west from the mouth of the Umba river in $4^{\circ} 40'$ S. to Victoria Nyanza, which it strikes at 1° S., deviating, however, so as to leave Mount Kilimanjaro wholly in German territory. The eastern boundary is the Indian Ocean, the coast line being about 400 m. On the north the protectorate is bounded by Abyssinia and Italian Somaliland; on the west by Uganda. It has an area of about 240,000 sq. m., and a population estimated at from 2,000,000 to 4,000,000, including some 25,000 Indians and 3000 Europeans. Of the Europeans many are emigrants from South Africa; they include some hundreds of Boer families.

The first of the parallel zones—the coast plain or "Temborari"—is generally of insignificant width, varying from 2 to 10 m., except in the valleys of the main rivers. The shore line is broken by bays and branching creeks, often cutting off islands from the mainland. Such are Mvita or Mombasa in $4^{\circ} 4'$ S., and the larger islands of Lamu, Mandia and Patta (the Lamu archipelago), between $2^{\circ} 20'$ and $2^{\circ} 30'$ S. Farther north the coast becomes straighter, with the one indentation of Port Durnford in $1^{\circ} 10'$ S., but skirted seawards by a row of small islands. Beyond the coast plain the country rises in a generally well defined step or steps to an altitude of some 800 ft., forming the wide level plain called "Nyika" (uplands), largely composed of quartz. It contains large waterless areas, such as the Taru desert in the Mombasa district. The next stage in the ascent is marked by an intermittent line of mountains—gneissose or schistose—running generally north-north-west, sometimes in parallel chains, and representing the primitive axis of the continent. Their height varies from 5000 to 8000 ft. Farther inland grassy uplands extend to the eastern edge of the rift-valley, though varied with cultivated ground and forest, the former especially in Kikuyu, the latter between 0° and $0^{\circ} 40'$ S. The most extensive grassy plains are those of Kapte or Kapote and Athi, between 1° and 2° S. The general altitude of these uplands, the surface of which is largely composed of lava, varies from 5000 to 8000 ft. This zone contains the highest elevations in British East Africa, including the volcanic pile of Kenya (917) (17,007 ft.), Sattima (13,214 ft.) and Nandaria (about 12,900 ft.). The Sattima (Settima) range, or Aberdare Mountains, has a general elevation of fully 10,000 ft. To the west the fall to the rift-valley is marked by a line of cliffs, of which the best-defined portions are the Kikuyu escarpment (8000 ft.), just south of 1° S., and the Laikipia escarpment, on the equator.

One of the main watersheds of East Africa runs close to the eastern wall of the rift-valley, separating the basins of inland drainage from the rivers of the east coast, of which the two largest wholly within British East Africa are the Sabaki and Tana, both separately noticed. The Guaso Nyiro rises in the hills north-west of Kenya and flows in a north-east direction. After a course of over 350 m. the river in about 1° N., $39^{\circ} 30'$ E. is lost in a marshy expanse known as the Lorian Swamp.

The rift-valley, though with a generally level floor, is divided by transverse ridges into a series of basins, each containing a lake without outlet. The southernmost section within British East Africa is formed by the arid Dogilani plains, drained south towards German territory. At their north end rise the extinct volcanoes of Suswa (7800 ft.) and Longonot (8700), the latter on the ridge dividing off the next basin—that of Lake Naivasha. This is a small fresh-water lake, 6135 ft. above the sea, measuring some 13 m. each way. Its basin is closed to the north by the ridge of Mount Buru, beyond which is the basin of the



still smaller Lakes Nakuro (5845 ft.) and Elmenteita (5860 ft.), followed in turn by that of Lakes Hannington and Baringo (*q.v.*). Beyond Baringo the valley is drained north into Lake Sugota, in 2° N., some 35 m. long, while north of this lies the much larger Lake Rudolf (*q.v.*), the valley becoming here somewhat less defined.

On the west of the rift-valley the wall of cliffs is best marked between the equator and 1° S., where it is known as the Mau Escarpment, and about 1° N., where the Elgeyo Escarpment falls to a longitudinal valley separated from Lake Baringo by the ridge of Kamasia. Opposite Lake Naivasha the Mau Escarpment is over 8000 ft. high. Its crest is covered with a vast forest. To the south the woods become more open, and the plateau falls to an open country drained towards the Dogilani plains. On the west the cultivated districts of Sotik and Lumbwa, broken by wooded heights, fall towards Victoria Nyanza. The Mau plateau reaches a height of 9000 ft. on the equator, north of which is the somewhat lower Nandi country, well watered and partly forested. In the treeless plateau of Usain Gishu, west of Elgeyo, the land again rises to a height of over 8000 ft., and to the west of this is the great mountain mass of Elgon (*q.v.*). East of Lake Rudolf and south of Lake Stefanie is a large waterless steppe, mainly volcanic in character, from which rise mountain ranges. The highest peak is Mount Kanjora, 6900 ft. high. South of this arid region, strewn with great lava stones, are the Rendile uplands, affording pasturage for thousands of camels. Running north-west and south-east between Lake Stefanie and the Daua tributary of the Juba is a mountain range with a steep escarpment towards the south. It is known as the Goro Escarpment, and at its eastern end it forms the boundary between the protectorate and Abyssinia. South-east of it the country is largely level bush covered plain, mainly waterless.

Geology.—The geological formations of British East Africa occur in four regions possessing distinct physiographical features. The coast plain, narrow in the south and rising somewhat steeply, consists of recent rocks. The foot plateau which succeeds is composed of sedimentary rocks dating from Trias to Jurassic. The ancient plateau commencing at Taru extends to the borders of Kikuyu and is composed of ancient crystalline rocks on which immense quantities of volcanic rocks—post-Jurassic to Recent—have accumulated to form the volcanic plateau of Central East Africa.

The formations recognized are given in the following table:—

		<i>Sedimentary.</i>
Recent	. . .	1. Alluvium and superficial sands.
		2. Modern lake deposits, living coral rock.
		3. Raised coral rock, conglomerate of Mombasa Island.
Pleistocene	. . .	4. Gravels with flint implements.
		5. Glacial beds of Kenya.
Jurassic	. . .	6. Shales and limestones of Changamwe.
Karoo	. . .	7. Flags and sandstones.
Carboniferous?	. . .	8. Grits and shales of Masara and Taru.
Archæan	. . .	9. Shales of the Sabaki river.
		10. Schists and quartzites of Nandi.
		11. Gneisses, schists, granites.

Igneous and Volcanic.
 Recent . . . Active, dormant and extinct volcanoes.
 Post-Jurassic . . . Kibo and volcanoes of the rift-valley.
 To Pleistocene . . . Kimawenzi, Kenya and plateau eruptions.

Archæan.—These rocks prevail in the districts of Taru, Nandi and throughout Ukimba. A coarse gneiss is the predominant rock, but is associated with garnetiferous mica-schists and much intrusive granite. Hornblende schists and beds of metamorphic limestone are rare. Cherty quartzites interbedded with mylonites occur on the flanks of the Nandi hills, but their age is not known.

Carboniferous?—From shales on the Sabaki river Dr Gregory obtained fish-scales and specimens of *Palæanodonia Fischeri*.

Karoo.—The grits of Masara, near Rabai mission station and Mombasa, have yielded specimens of *Glossopteris browniana* var. *indica*, thus indicating their Karroo age.

Jurassic.—Shales and limestones of this age are well seen along the railway near Changamwe. They contain gigantic ammonites. According to Dr Waagen the ammonites show a striking analogy to forms from the Acanthicus zone of East India. Belemnites are plentiful.

Pleistocene.—These are feebly represented by some boulder beds on the higher slopes of Kilimanjaro and Kenya. They show that in Pleistocene times the glaciers of Kilimanjaro and Kenya extended much farther down the mountain slopes.

Recent.—The ancient and more modern lake deposits have so far yielded no mammalian or other organic remains of interest.

Igneous and Volcanic.—A belt of volcanic rocks, over 150,000 sq. m. in area, extends from beyond the southern to beyond the northern territorial limits. They belong to an older and a newer set. The older group commenced with a series of fissure eruptions along the site of the present rift-valley and parallel with it. From these fissures immense and repeated flows of lava spread over the Kapte and Laikipia plateaus. At about the same time, or a little later,

Kenya and Kimawenzi, Elgon and Chibcharagaani were in eruption. The age of these volcanic outbursts cannot be more definitely stated than that they are post-Jurassic, and probably extended through Cretaceous into early Tertiary times. This great volcanic period was followed by the eruptions of Kibo and some of the larger volcanoes of the rift-valley. The flows from Kibo include nepheline and leucite basanite lavas rich in soda felspar. They bear a close resemblance to the Norwegian "Rhombenporphyra." The chain of volcanic cones along the northern lower slopes of Kilimanjaro, those of the Kyulu mountains, Donyo Longonot and numerous craters in the rift-valley region, are of a slightly more recent date. A few of the volcanoes in the latter region have only recently become extinct; a few may be only dormant. Donyo Buru still emits small quantities of steam, while Mount Teleki, in the neighbourhood of Lake Rudolf, was in eruption at the close of the 19th century.]

Climate, Flora and Fauna.—In its climate and vegetation British East Africa again shows an arrangement of zones parallel to the coast. The coast region is hot but is generally more healthy than the coast lands of other tropical countries, this being due to the constant breeze from the Indian Ocean and to the dryness of the soil. The rainfall on the coast is about 35 in. a year, the temperature tropical. The succeeding plains and the outer plateaus are more arid. Farther inland the highlands—in which term may be included all districts over 5000 ft. high—are very healthy, fever being almost unknown. The average temperature is about 66° F. in the cool season and 73° F. in the hot season. Over 7000 ft. the climate becomes distinctly colder and frosts are experienced. The average rainfall in the highlands is between 40 and 50 in. The country bordering Victoria Nyanza is typically tropical; the rainfall exceeds 60 in. in the year, and this region is quite unsuitable to Europeans. The hottest period throughout the protectorate is December to April, the coolest, July to September. The "greater rains" fall from March to June, the "smaller rains" in November and December. The rainfall is not, however, as regular as is usual in countries within the tropics, and severe droughts are occasionally experienced.

In the districts bordering Victoria Nyanza the flora resembles that of Uganda (*q.v.*). The characteristic trees of the coast regions are the mangrove and coco-nut palm. Ebony grows in the scrub-jungle. Vast forests of olives and junipers are found on the Mau escarpment; the cotton, fig and bamboo on the Kikuyu escarpment; and in several regions are dense forests of great trees whose lowest branches are 50 ft. from the ground. Two varieties of the valuable rubber-vine, *Landolphia florida* and *Landolphia Kikuyu*, are found near the coast and in the forests. The higher mountains preserve distinct species, the surviving remnants of the flora of a cooler period. The fauna is not abundant except in large mammals, which are very numerous on the drier steppes. They include the camel (confined to the arid northern regions), elephant (more and more restricted to unfrequented districts), rhinoceros, buffalo, many kinds of antelope, zebra, giraffe, hippopotamus, lion and other carnivora, and numerous monkeys. In many parts the rhinoceros is particularly abundant and dangerous. Crocodiles are common in the larger rivers and in Victoria Nyanza. Snakes are somewhat rare, the most dangerous being the puff-adder. Centipedes and scorpions, as well as mosquitoes and other insects, are also less common than in most tropical countries. In some districts bees are exceedingly numerous. The birds include the ostrich, stork, bustard and secretary-bird among the larger varieties, the guinea fowl, various kinds of spur fowl, and the lesser bustard, the wild pigeon, weaver and hornbill. By the banks of lakes and rivers are to be seen thousands of cranes, pelicans and flamingoes.

Inhabitants.—The white population is chiefly in the Kikuyu uplands, the rift-valley, and in the Kenya region. The whites are mostly agriculturists. There are also numbers of India settlers in the same districts. The African races include representatives of various stocks, as the country forms a borderland between the Negro and Hamitic peoples, and contains many tribes of doubtful affinities. The Bantu division of the negroes is represented chiefly in the south, the principal tribes being the Wakamba, Wakikuyu and Wanyika. By the north-east shores of Victoria Nyanza dwell the Kavirondo (*q.v.*), a race remarkable among the tribes of the protectorate for their nudity. Nilotic tribes, including the Nandi (*q.v.*), Lumbwa, Suk and Turkanas, are found in the north-west. Of Hamitic strain are the Massi (*q.v.*), a race of cattle-rearers speaking a Nilotic language, who occupy part of the uplands bordering on the eastern rift-valley. A branch of the Massi which has adopted the settled life of agriculturists is known as the Wakuafi. The Galla section of the Hamites is represented, among others, by Borani living

south of the Goro Escarpment (though the true Boran countries are Liban and Dirri in Abyssinian territory), while Somali occupy the country between the Tana and Juba rivers. Of the Somali tribes the Herti dwell near the coast and are more or less stationary. Further inland is the nomadic tribe of Ogaden Somali. The Gurre, another Somali tribe, occupy the country south of the lower Dana. Primitive hunting tribes are the Wandorobo in Masailand, and scattered tribes of small stature in various parts. The coast-land contains a mixed population of Swahili, Arab and Indian immigrants, and representatives of numerous interior tribes.

Provinces and Towns.—The protectorate has been divided into the provinces of Seyyidie (the south coast province, capital Mombasa); Ukamba, which occupies the centre of the protectorate (capital Nairobi); Kenya, the district of Mt. Kenya (capital Fort Hall); Tanaland, to the north of the two provinces first named (capital Lamu); Jubaland, the northern region (capital Kismayu); Naivasha (capital Naivasha); and Kisumu (capital Kisumu); each being in turn divided into districts and sub-districts. Naivasha and Kisumu, which adjoin the Victoria Nyanza, formed at first the eastern province of Uganda, but were transferred to the East Africa protectorate on the 1st of April 1902. The chief port of the protectorate is Mombasa (q.v.) with a population of about 30,000. The harbour on the south-west side of Mombasa island is known as Kilindini, the terminus of the Uganda railway. On the mainland, nearly opposite Mombasa town, is the settlement of freed slaves named Freretown, after Sir Bartle Frere. Freretown (called by the natives Kisaoni) is the headquarters in East Africa of the Church Missionary Society. It is the residence of the bishop of the diocese of Mombasa and possesses a fine church and mission house. Lamu, on the island of the same name, 150 m. north-east of Mombasa, is an ancient settlement and the headquarters of the coast Arabs. Here are some Portuguese ruins, and a large Arab city is buried beneath the sands. The other towns of note on the coast are Malindi, Patta, Kipini and Kismayu. At Malindi, the "Melind" of *Paradise Lost*, is the pillar erected by Vasco da Gama when he visited the port in 1498. The harbour is very shallow. Kismayu, the northernmost port of the protectorate, 320 m. north-east of Mombasa, is the last sheltered anchorage on the east coast and is invaluable as a harbour of refuge. Flourishing towns have grown up along the Uganda railway. The most important, Nairobi (q.v.), 327 m. from Mombasa, 257 from Port Florence, was chosen in 1907 as the administrative capital of the protectorate. Naivasha, 64 m. north-north-west of Nairobi, lies in the rift-valley close to Lake Naivasha, and is 6230 ft. above the sea. It enjoys an excellent climate and is the centre of a European agricultural settlement. Kisumu or Port Florence (a term confined to the harbour) is a flourishing town built on a hill overlooking Victoria Nyanza. It is the entrepôt for the trade of Uganda.

Communications.—Much has been done to open up the country by means of roads, including a trunk road from Mombasa, by Kibwezi in the upper Sabaki basin, and Lake Naivasha, to Berkeley Bay on Victoria Nyanza. But the most important engineering work undertaken in the protectorate was the construction of a railway from Mombasa to Victoria Nyanza, for which a preliminary survey was executed in 1892, and on which work was begun in 1896. The line chosen roughly coincides with that of the road, until the equator is reached, after which it strikes by a more direct route across the Mau plateau to the lake, which it reaches at Port Florence on Kavirondo Gulf. The railway is 584 m. long and is of metre (3.28 ft.) gauge, the Sudan, and South and Central African lines being of 3 ft. 6 in. gauge. The Uganda railway is essentially a mountain line, with gradients of one in fifty and one in sixty. From Mombasa it crosses to the mainland by a bridge half a mile long, and ascends the plateau till it reaches the edge of the rift-valley, 346 m. from its starting point, at the Kikuyu Escarpment, where it is 7600 ft. above the sea. It then descends across ravines bridged by viaducts to the valley floor, dropping to a level of 6011 ft., and next ascending the opposite (Mau) escarpment to the summit, 8221 ft. above sea-level—the highest point on the line. In the remaining 100 m. of its course the level sinks to 3738 ft., the altitude of the station at Port Florence. The railway was built by the British government at a cost of £5,331,000, or about £5000 per mile. The first locomotive reached Victoria Nyanza on the 26th of December 1901; and the permanent way was practically completed by March 1903, when Sir

George Whitehouse, the engineer who had been in charge of the construction from the beginning, resigned his post. The railway, by doing away with the carriage of goods by men, gave the final death-blow to the slave trade in that part of East Africa. It also facilitated the continued occupation and development of Uganda, which was, previous to its construction, an almost impossible task, owing to the prohibitive cost of the carriage of goods from the coast—£60 per ton. The two avowed objects of the railway—the destruction of the slave trade and the securing of the British position in Uganda—have been attained; moreover, the railway by opening up land suitable for European settlement has also done much towards making a prosperous colony of the protectorate, which was regarded before the advent of the line as little better than a desert (see below, *History*). The railway also shows a fair return on the capital expenditure, the surplus after defraying all working expenses being £56,000 in 1905-1906 and £76,000 in 1906-1907.

Mombasa is visited by the boats of several steamship companies, the German East Africa line maintaining a fortnightly service from Hamburg. There is also a regular service to and from India. A cable connecting Mombasa with Zanzibar puts the protectorate in direct telegraphic communication with the rest of the world. There is also an inland system of telegraphs connecting the chief towns with one another and with Uganda.

Agriculture and other Industries.—In the coast region and by the shores of Victoria Nyanza the products are tropical, and cultivation is mainly in the hands of the natives or of Indian immigrants. There are, however, numerous plantations owned by Europeans. Rice, maize and other grains are raised in large quantities; cotton and tobacco are cultivated. The coco-nut palm plantations yield copra of excellent quality, and the bark of the mangrove trees is exported for tanning purposes. In some inland districts beans of the castor oil plant, which grows in great abundance, are a lucrative article of trade. The sugar-cane, which grows freely in various places, is cultivated by the natives. The collection of rubber likewise employs numbers of people.

Among the European settlers in the higher regions much attention is devoted to the production of vegetables, and very large crops of potatoes are raised. Oats, barley, wheat and coffee are also grown. The uplands are peculiarly adapted for the raising of stock, and many of the white settlers possess large flocks and herds. Merino sheep have been introduced from Australia. Ostrich farms have also been established. Clover, lucerne, ryegrass and similar grasses have been introduced to improve and vary the fodder. Other vegetable products of economic value are many varieties of timber trees, and fibre-producing plants, which are abundant in the scrub regions between the coast and the higher land bordering the rift-valley. Over the greater part of the country the soil is light reddish loam; in the eastern plains it is a heavy black loam. As a rule it is easily cultivated. While the majority of the African tribes in the territory are not averse from agricultural labour, the number of men available for work on European holdings is small. Moreover, on some of the land most suited for cultivation by white men there is no native population.

In addition to the fibre industry and cotton ginning there are factories for the curing of bacon. Native industries include the weaving of cloth and the making of mats and baskets. Stone and lime quarries are worked, and copper is found in the Tsavo district. Diamonds have been discovered in the Thika river, one of the head-streams of the Tana.

Trade.—The imports consist largely of textiles, hardware and manufactured goods from India and Europe; Great Britain and India between them supplying over 50% of the total imports. Of other countries Germany has the leading share in the trade. The exports, which include the larger part of the external trade of Uganda, are chiefly copra, hides and skins, grains, potatoes, rubber, ivory, chillies, beeswax, cotton and fibre. The retail trade is largely in the hands of Indians. The value of the exports rose from £89,858 in 1900-1901 to £234,664 in 1904-1905, in which year the value of the imports for the first time exceeded £500,000. In 1906-1907 the volume of trade was £1,194,352, imports being valued at £753,647 and exports at £440,705. The United States takes 33% of the exports, Great Britain coming next with 15%.

Government.—The system of government resembles that of a British crown colony. At the head of the administration is a governor, who has a deputy styled lieutenant-governor, provincial commissioners presiding over each province. There are also executive and legislative councils, unofficial nominated members serving on the last-named council. In the "ten-mile strip" (see below, *History*), the sultan of Zanzibar being territorial sovereign, the laws of Islam apply to the native and Arab population. The extra-territorial jurisdiction granted by the sultan to various Powers was in 1907 transferred to Great Britain. Domestic slavery formerly issued; but on the advice of the British government a decree was issued by the sultan on the 1st of August 1890, enacting that no one born after that date could be a slave, and this was followed in 1907 by a decree abolishing the legal status of slavery. In the rest of the protectorate slavery is not recognized in any form. Legislation is by ordinances made by the governor, with the assent of the legislative council. The judicial system is based on Indian models, though in cases in which Africans are concerned regard is had to

native customs. Europeans have the right to trial by jury in serious cases. There is a police force of about 2000 men, and two battalions of the King's African Rifles are stationed in the protectorate. Revenue is derived chiefly from customs, licences and excise, railway earnings, and posts and telegraphs. Natives pay a hut tax. Since the completion of the Uganda railway, trade, and consequently revenue, has increased greatly. In 1900-1901 the revenue was £64,275 and the expenditure £193,438; in 1904-1905 the figures were: revenue £154,756, expenditure £302,559; in 1905-1906 the totals were £270,362 and £418,839, and in 1906-1907 (when the railway figures were included for the first time) £461,352 and £616,088. The deficiencies were made good by grants-in-aid from the imperial exchequer. The standard coin used is the rupee (16d.).

Education is chiefly in the hands of the missionary societies, which maintain many schools where instruction is given in handicrafts, as well as in the ordinary branches of elementary education. There are Arab schools in Mombasa, and government schools for Europeans and Indians at Nairobi.

History.—From the 8th century to the 11th Arabs and Persians made settlements along the coast and gained political supremacy at many places, leading to the formation of the so-called Zenz empire. The history of the coast towns from that time until the establishment of British rule is identified with that of Zanzibar (q.v.). The interior of what is now British East Africa was first made known in the middle of the 19th century by the German missionaries Ludwig Krapf and Johannes Rebmann, and by Baron Karl von der Decken (1833-1865) and others. Von der Decken and three other Europeans were murdered by Somali at a town called Bardera in October 1865, whilst exploring the Juba river. The countries east of Victoria Nyanza (Masailand, &c.) were, however, first traversed throughout their whole extent by the Scottish traveller Joseph Thomson (q.v.) in 1883-1884. In 1888 Count S. Teleki (a Hungarian) discovered Lakes Rudolf and Stefanie.

The growth of British interests in the country now forming the protectorate arises from its connexion with the sultanate of Zanzibar. At Zanzibar British influence was very strong in the last quarter of the 19th century, and the seyyid or sultan, Bargash, depended greatly on the advice of the British representative, Sir John Kirk. In 1877 Bargash offered to Mr (afterwards Sir) William Mackinnon (1823-1893), chairman of the British India Steam Navigation Company, a merchant in whom he had great confidence, or to a company to be formed by him, a lease for 70 years of the customs and administration of the whole of the mainland dominions of Zanzibar including, with certain reservations, rights of sovereignty. This was declined owing to a lack of support by the foreign office, and concessions obtained in 1884 by Mr (afterwards Sir) H. H. Johnston in the Kilimanjaro district were, at the time, disregarded. The large number of concessions acquired by Germans in 1884-1885 on the East African coast aroused, however, the interest of those who recognized the paramount importance of the maintenance of British influence in those regions. A British claim, ratified by an agreement with Germany in 1886, was made to the districts behind Mombasa; and in May 1887 Bargash granted to an association formed by Mackinnon a concession for the administration of so much of his mainland territory as lay outside the region which the British government had recognized as the German sphere of operations. By international agreement the mainland territories of the sultan were defined as extending 10 m. inland from the coast. Mackinnon's association, whose object

was to open up the hinterland as well as this ten-mile strip, became the Imperial British East Africa Company by a founder's agreement of April 1888, and received a royal charter in September of the same year. To this company the sultan made a further concession dated October 1888. On the faith of these concessions and the charters a sum of £240,000 was subscribed, and the company received formal charge of their concessions. The path of the company was speedily beset with difficulties, which in the first instance arose out of the aggressions of the German East African Company. This company had also received a grant from the sultan in October 1888, and its appearance on the coast was followed by grave disturbances among the tribes which had welcomed the British. This outbreak led to a joint British and German

blockade, which seriously hampered trade operations. It had also been anticipated, in reliance on certain assurances of Prince Bismarck, emphasized by Lord Salisbury, that German enterprise in the interior of the country would be confined to the south of Victoria Nyanza. Unfortunately this expectation was not realized. Moreover German subjects put forward claims to coast districts, notably Lamu, within the company's sphere and in many ways obstructed the company's operations. In all these disputes the German government countenanced its own subjects, while the British foreign office did little or nothing to assist the company, sometimes directly discouraging its activity. Moreover, the company had agreed by the concession of October 1888 to pay a high revenue to the sultan—Bargash had died in the preceding March and the Germans were pressing his successor to give them a grant of Lamu—in lieu of the customs collected at the ports they took over. The disturbance caused by the German claims had a detrimental effect on trade and put a considerable strain on the resources of the company. The action of the company in agreeing to onerous financial burdens was dictated partly by regard for imperial interests, which would have been seriously weakened had Lamu gone to the Germans.

By the hinterland doctrine, accepted both by Great Britain and Germany in the diplomatic correspondence of July 1887, Uganda would fall within Great Britain's "sphere of influence"; but German public opinion did not so regard the matter. German maps assigned the territory to Germany, while in England public opinion as strongly expected British influence to be paramount. In 1889 Karl Peters, a German official, led what was practically a raiding expedition into that country, after running a blockade of the ports. An expedition under F. J. Jackson had been sent by the company in the same year to Victoria Nyanza, but with instructions to avoid Uganda. In consequence of representations from Uganda, and of tidings he received of Peters's doings, Jackson, however, determined to go to that country. Peters retired at Jackson's approach, claiming, nevertheless, to have made certain treaties which constituted "effective occupation." Peters's treaty was dated the 1st of March 1890; Jackson concluded another in April. Meantime negotiations were proceeding in Europe; and by the Anglo-German agreement of the 1st of July 1890 Uganda was assigned to the British sphere. To consolidate their position in Uganda—the French missionaries there were hostile to Great Britain—the company sent thither Captain F. D. Lugard, who reached Mengo, the capital, in December 1890 and established the authority of the company despite French intrigues. In July 1890 representatives of the powers assembled at Brussels had agreed on common efforts for the suppression of the slave trade. The interference of the company in Uganda had been a material step towards that object, which they sought to further and at the same time to open up the country by the construction of a railway from Mombasa to Victoria Nyanza. But their resources being inadequate for such an undertaking they sought imperial aid. Although Lord Salisbury, then prime minister, paid the highest tribute to the company's labours and a preliminary grant for the survey had been practically agreed upon, the scheme was wrecked in parliament. At a later date, however, the railway was built entirely at government cost (*supra*, § Communications). Owing to the financial strain imposed upon it the company decided to withdraw Captain Lugard and his forces in August 1891; and eventually the British government assumed a protectorate over the country (see UGANDA).

Further difficulties now arose which led finally to the extinction of the company. Its pecuniary interests sustained a severe blow owing to the British government—which had taken Zanzibar under its protection in November 1890—declaring (June 1892) the dominions of the sultan within the free trade zone. This act extinguished the treaties regulating all tariffs and duties with foreign powers, and gave free trade all along the coast. The result for the company was that dues were now swept away without compensation, and the company was left saddled with the payment of the rent, and with the cost, in addition, of administration.

the necessary revenue for which had been derived from the dues thus abolished. Moreover, a scheme of taxation which it drew up failed to gain the approval of the foreign office.

In every direction the company's affairs had drifted into an *impasse*. Plantations had been taken over on the coast and worked at a loss, money had been advanced to native traders and lost, and expectations of trade had been disappointed. At this crisis Sir William Mackinnon, the guiding spirit of the company, died (June 1893). At a meeting of shareholders on the 8th of May 1894 an offer to surrender the charter to the government was approved, though not without strong protests. Negotiations dragged on for over two years, and ultimately the terms of settlement were that the government should purchase the property, rights and assets of the company in East Africa for £250,000. Although the company had proved unprofitable for the shareholders (when its accounts were wound up they disclosed a total deficit of £193,757) it had accomplished a great deal of good work and had brought under British sway not only the head waters of the upper Nile, but a rich and healthy upland region admirably adapted for European colonization. To the judgment, foresight and patriotism of Sir William Mackinnon British East Africa practically owes its foundation. Sir William and his colleagues of the company were largely animated by humanitarian motives—the desire to suppress slavery and to improve the condition of the natives. With this aim they prohibited the drink traffic, started industrial missions, built roads, and administered impartial justice. In the opinion of a later administrator (Sir C. Eliot), their work and that of their immediate successors was the greatest philanthropic achievement of the latter part of the 19th century.

On the 1st of July 1895 the formal transfer to the British crown of the territory administered by the company took place at Mombasa, the foreign office assuming responsibility for its administration. The territory, hitherto known as "Ibea," from the initials of the company, was now styled the East Africa protectorate. The small sultanate of Witu (q.v.) on the mainland opposite Lamu, from 1885 to 1890 a German protectorate, was included in the British protectorate. Coincident with the transfer of the administration to the imperial government a dispute as to the succession to a chieftainship in the Masrui, the most important Arab family on the coast, led to a revolt which lasted ten months and involved much hard fighting. It ended in April 1896 in the flight of the rebel leaders to German territory, where they were interned. The rebellion marks an important epoch in the history of the protectorate as its suppression definitely substituted European for Arab influence. "Before the rebellion," says Sir C. Eliot, "the coast was a protected Arab state; since its suppression it has been growing into a British colony."

From 1896, when the building of the Mombasa-Victoria Nyanza railway was begun, until 1903, when the line was practically completed, the energies of the administration were largely absorbed in that great work, and in establishing effective control over the Masai, Somali, and other tribes. The coast lands apart, the protectorate was regarded as valuable chiefly as being the high road to Uganda. But as the railway reached the high plateaus the discovery was made that there were large areas of land—very sparsely peopled—where the climate was excellent and where the conditions were favourable to European colonization. The completion of the railway, by affording transport facilities, made it practicable to open the country to settlers. The first application for land was made in April 1902 by the East Africa Syndicate—a company in which financiers belonging to the Chartered Company of South Africa were interested—which sought a grant of 500 sq. m.; and this was followed by other applications for considerable areas, a scheme being also propounded for a large Jewish settlement.

During 1903 the arrival of hundreds of prospective settlers, chiefly from South Africa, led to the decision to entertain no more applications for large areas of land, especially as questions were raised concerning the preservation for the Masai of their

rights of pasturage. In the carrying out of this policy a dispute arose between Lord Lansdowne, foreign secretary, and Sir Charles Eliot, who had been commissioner since 1900. The foreign secretary, believing himself bound by pledges given to the syndicate, decided that they should be granted the lease of the 500 sq. m. they had applied for; but after consulting officials of the protectorate then in London, he refused Sir Charles Eliot permission to conclude leases for 50 sq. m. each to two applicants from South Africa. Sir Charles thereupon resigned his post, and in a public telegram to the prime minister, dated Mombasa, the 21st of June 1904, gave as his reason:—"Lord Lansdowne ordered me to refuse grants of land to certain private persons while giving a monopoly of land on unduly advantageous terms to the East Africa Syndicate. I have refused to execute these instructions, which I consider unjust and impolitic."¹

On the day Sir Charles sent this telegram the appointment of Sir Donald W. Stewart, the chief commissioner of Ashanti, to succeed him was announced. Sir Donald induced the Masai whose grazing rights were threatened to remove to another district, and a settlement of the land claims was arranged. An offer to the Zionist Association of land for colonization by Jews was declined in August 1905 by that body, after the receipt of a report by a commissioner sent to examine the land (6000 sq. m.) offered. Sir Donald Stewart died on the 1st of October 1905, and was succeeded by Colonel Hayes Sadler, the commissioner of Uganda. Meantime, in April 1905, the administration of the protectorate had been transferred from the foreign to the colonial office. By the close of 1905 considerably over a million acres of land had been leased or sold by the protectorate authorities—about half of it for grazing purposes. In 1907, to meet the demands of the increasing number of white inhabitants, who had formed a Colonists' Association² for the promotion of their interests, a legislative council was established, and on this council representatives of the settlers were given seats. The style of the chief official was also altered, "governor" being substituted for "commissioner." In the same year a scheme was drawn up for assisting the immigration of British Indians to the regions adjacent to the coast and to Victoria Nyanza, districts not suitable for settlement by Europeans.

In general the relations of the British with the tribes of the interior have been satisfactory. The Somali in Jubaland have given some trouble, but the Masai, notwithstanding their warlike reputation, accepted peaceably the control of the whites. This was due, in great measure, to the fact that at the period in question plague carried off their cattle wholesale and reduced them for years to a state of want and weakness which destroyed their warlike habits. One of the most troublesome tribes proved to be the Nandi, who occupied the southern part of the plateau west of the Mau escarpment. They repeatedly raided their less warlike neighbours and committed wholesale thefts from the railway and telegraph lines. In September 1905 an expedition was sent against them which reduced the tribe to submission in the following November; and early in 1906 the Nandi were removed into a reserve. The majority of the natives, unaccustomed to regular work, showed themselves averse from taking service under the white farmers. The inadequacy of the labour supply was an early cause of trouble to the settlers, while the labour regulations enforced led, during 1907-1908, to considerable friction between the colonists and the administration.

For several years after the establishment of the protectorate the northern region remained very little known and no attempt was made to administer the district. The natives were frequently raided by parties of Gallas and Abyssinians, and in the absence of a defined frontier Abyssinian government posts were pushed south to Lake Rudolf. The Abyssinians also made themselves masters of the Boran country. After long negotiations an agreement as to the boundary line between the lake and

¹ See *Correspondence relating to the Resignation of Sir C. Eliot, Africa, No. 8 (1904)*.

² The Planters and Farmers' Association, as this organization was originally called, dates from 1903.

the river Juba was signed at Adis Ababa on the 6th of December 1907, and in 1908-1909 the frontier was delimited by an Anglo-Abyssinian commission, Major C. W. Gwynn being the chief British representative. Save for its north-eastern extremity Lake Rudolf was assigned to the British, Lake Stefanie falling to Abyssinia, while from about 4° 20' N. the Daua to its junction with the Juba became the frontier.

BIBLIOGRAPHY.—The most comprehensive account of the protectorate to the close of 1904, especially of its economic resources, is *The East Africa Protectorate*, by Sir Charles Eliot (London, 1905). The progress of the protectorate is detailed in the *Reports* by the governor issued annually by the British government since 1896, and in *Drumkey's Year Book for East Africa* (Bombay), first issued in 1908. The *Precis of Information* concerning the British East Africa Protectorate (issued by the War Office, London, 1901) is chiefly valuable for its historical information. The work of the Imperial British East Africa Company is concisely and authoritatively told from official documents in *British East Africa or Ibea*, by P. L. McDermott (new ed., London, 1895). Another book, valuable for its historical perspective, is *The Foundation of British East Africa*, by J. W. Gregory (London, 1901). Bishop A. R. Tucker's *Eighteen Years in Uganda and East Africa* (London, 1908) contains a summary of missionary labours. Of the works of explorers *Through Masai Land*, by Joseph Thomson (London, 1886), is specially valuable. For the northern frontier see Capt. P. Maud's report in *Africa No. 13* (1904). For geology see, besides Thomson's book, *The Great Rift Valley*, by J. W. Gregory (London, 1896); *Across an East African Glacier*, by Hans Meyer (London and Leipzig, 1896); and *Report relating to the Geology of the East Africa Protectorate*, by H. B. Muff (Colonial Office, London, 1908). For big game and ornithology see *On Safari*, by A. Chapman (London, 1908). The story of the building of the Uganda railway is summarized in the *Final Report of the Uganda Railway Committee, Africa, No. 11* (1904), published by the British government. (F. R. C.)

BRITISH EMPIRE, the name now loosely given to the whole aggregate of territory, the inhabitants of which, under various forms of government, ultimately look to the British crown as the supreme head. The term "empire" is in this connexion obviously used rather for convenience than in any sense equivalent to that of the older or despotic empires of history.

The land surface of the earth is estimated to extend over about 52,500,000 sq. m. Of this area the British empire occupies *Extent.* nearly one-quarter, extending over an area of about 12,000,000 sq. m. By far the greater portion lies within the temperate zones, and is suitable for white settlement. The notable exceptions are the southern half of India and Burma; East, West and Central Africa; the West Indian colonies; the northern portion of Australia; New Guinea, British Borneo and that portion of North America which extends into Arctic regions. The area of the territory of the empire is divided almost equally between the southern and the northern hemispheres, the great divisions of Australasia and South Africa covering between them in the southern hemisphere 5,308,506 sq. m., while the United Kingdom, Canada and India, including the native states, cover between them in the northern hemisphere 5,271,375 sq. m. The alternation of the seasons is thus complete, one-half of the empire enjoying summer, while one-half is in winter. The division of territory between the eastern and western hemispheres is less equal, Canada occupying alone in the western hemisphere 3,653,946 sq. m., while Australasia, South Africa, India and the United Kingdom occupy together in the eastern hemisphere 6,925,975 sq. m. As a matter of fact, however, the eastern portions of Australasia border so nearly upon the western hemisphere that the distribution of day and night throughout the empire is, like the alternations of the seasons, almost complete, one-half enjoying daylight, while the other half is in darkness. These alternations of time and of seasons, combined with the variety of soils and climates, are calculated to have an increasingly important effect upon the material and industrial, as well as upon the social and political developments of the empire. This will become evident in considering the industrial productions of the different divisions, and the harvest seasons which permit the summer produce of one portion of the empire to supply the winter requirements of its other markets, and conversely.

The empire contains or is bounded by some of the highest mountains, the greatest lakes, and the most important rivers

of the world. Its climates may be said to include all the known climates of the world; its soils are no less various. In the prairies of central Canada it possesses some of the most valuable wheat-producing land; in the grass lands of the interior of Australia the best pasture country; and in the uplands of South Africa the most valuable gold- and diamond-bearing beds which exist. The United Kingdom at present produces more coal than any other single country except the United States. The effect of climate throughout the empire in modifying the type of the Anglo-Saxon race has as yet received only partial attention, and conclusions regarding it are of a somewhat empiric nature. The general tendency in Canada is held to be towards somewhat smaller size, and a hardy active habit; in Australia to a tall, slight, pale development locally known as "cornstalkers," characterized by considerable nervous and intellectual activity. In New Zealand the type preserves almost exactly the characteristics of the British Isles. The South African, both Dutch and British, is readily recognized by an apparently sun-dried, lank and hard habit of body. In the tropical possessions of the empire, where white settlement does not take place to any considerable extent, the individual alone is affected. The type undergoes no modification. It is to be observed in reference to this interesting aspect of imperial development, that the multiplication and cheapening of channels of communication and means of travel throughout the empire will tend to modify the future accentuation of race difference, while the variety of elements in the vast area occupied should have an important, though as yet not scientifically traced, effect upon the British imperial type.

The white population of the empire¹ reached in 1901 a total of over 53,000,000, or something over one-eighth of its entire population, which, including native races, is estimated at about 400,000,000. The white population includes some French, Dutch and Spanish peoples, but is mainly of Anglo-Saxon race. It is distributed roughly as follows:—

United Kingdom and home dependencies	41,608,791
Australasia	4,662,000
British North America	5,500,000
Africa (Dutch and British)	1,000,000 ²
India	169,677
West Indies and Bermuda	100,000
	<hr/>
	53,040,468

The native population of the empire includes types of the principal black, yellow and brown races, classing with these the high-type races of the East, which may almost be called white. The native population of India, mainly high type, brown, was returned at the census of 1901 as 294,191,379. The population of India is divided into 118 groups on the basis of language. These may, however, be collected into the following principal groups:—

- (A) Malayo-Polynesian.
- (B) Indo-Chinese:
 - i. Mon-Khmer.
 - ii. Tibeto-Burman.
 - iii. Siamese-Chinese.
- (C) Dravido-Munda:
 - i. Munda (Kolarian).
 - ii. Dravidian.
- (D) Indo-European.
- (E) Indo-Aryan sub-family.
- (F) Semitic.
- (G) Hamitic.
- (G) Unclassed, e.g. Gipsy.

Eastern Colonies

Ceylon, high type, brown and mixed	3,568,824
Straits Settlements, brown, mixed and Chinese	570,000
Hong-Kong, Chinese and brown.	306,130
North Borneo, mixed brown and Sarawak	700,000
	<hr/>
	5,144,954

¹ The census returns for 1901 from the various parts of the empire were condensed for the first time in 1906 into a blue-book under the title of *Census of the British Empire, Report with Summary*.

² The white population of British South Africa according to the census of 1904 was 1,132,226.

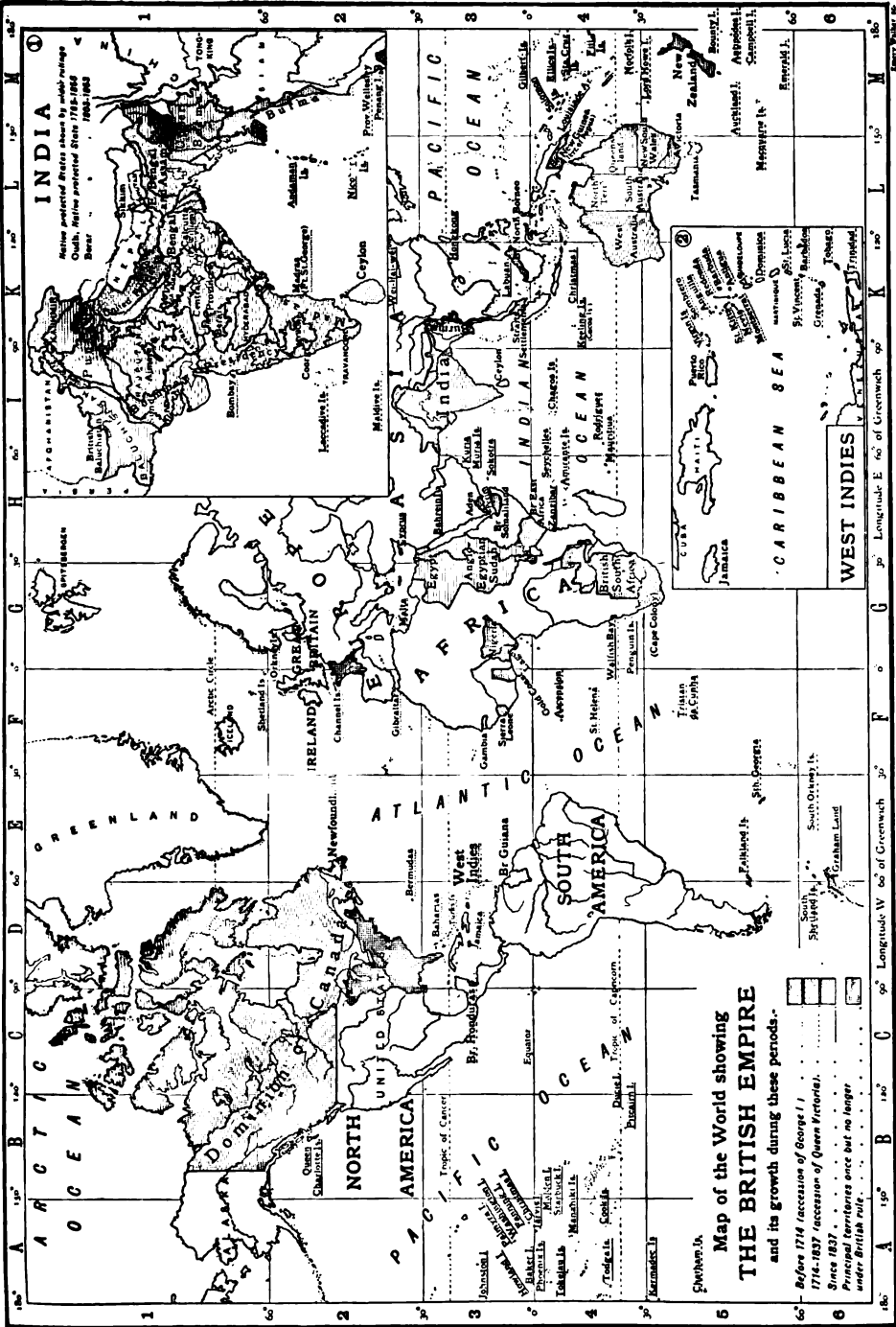

**Map of the World showing
THE BRITISH EMPIRE
and its growth during these periods.**

- Before 1714 (accession of George I)
- 1714-1837 (accession of Queen Victoria)
- Since 1837
- Principal territories once but no longer under British rule

Longitude W 60° of Greenwich 30° 0° 30° Longitude E 60° of Greenwich 90° 120° 150°

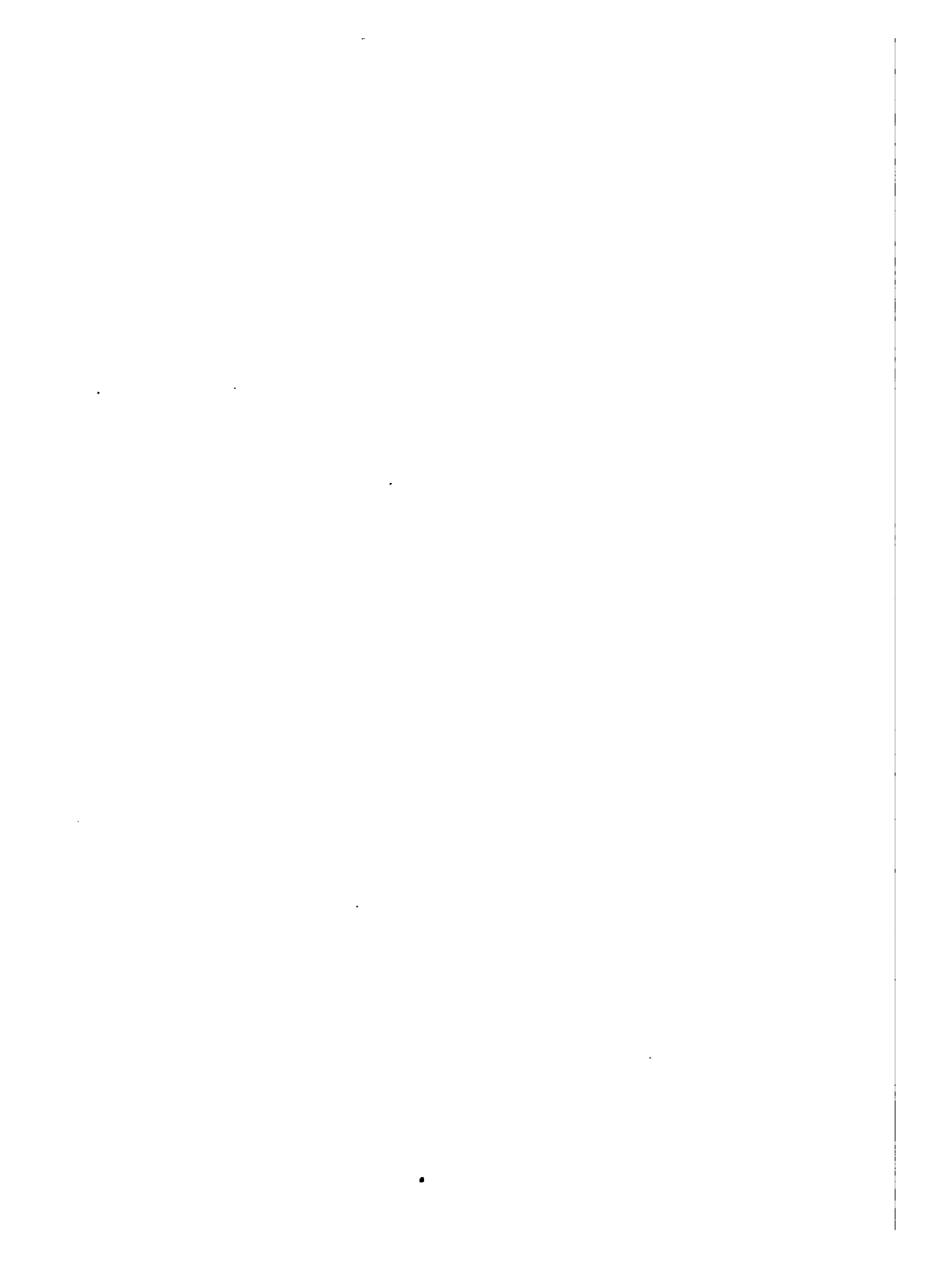

Of the various races which inhabit these Eastern dependencies the most important are the 2,000,000 Sinhalese and the 954,000 Tamil that make up the greater part of the population of Ceylon. The rest is made up of Arabs, Malays, Chinese (in the Straits Settlements and Hong-Kong), Dyaks, Eurasians and others.

West Indies.

The West Indies, including the continental colonies of British Guiana and Honduras, and seventeen islands or groups of islands, have a total coloured population of about 1,912,655. The colonies of this group which have the largest coloured populations are:—

Jamaica—Chiefly black, some brown and yellow	790,000
Trinidad and Tobago—Black and brown	250,000
British Guiana—Black and brown	286,000
	1,326,000

The populations of the West Indies are very various, being made up largely of imported African negroes. In Jamaica these contribute four-fifths of the population. There are also in the islands a considerable number of imported East Indian coolies and some Chinese. The aboriginal races include American Indians of the mainland and Caribs. With these there has been intermixture of Spanish and Portuguese blood, and many mixed types have appeared. The total European population of this group of colonies amounts to upwards of 80,000, to which 15,000 on account of Bermuda may be added.

Africa.

South	} Chiefly black, estimated {	5,211,329
Central		2,000,000

The aboriginal races of South Africa were the Bushmen and Hottentots. Both these races are rapidly diminishing in numbers, and in British South Africa it is expected that they will in the course of the twentieth century become extinct. Besides these primitive races there are the dark-skinned negroids of Bantu stock, commonly known in their tribal groups as Kaffirs, Zulu, Bechuana and Damara, which are again subdivided into many lesser groups. The Bantu compose the greater part of the native population. There are also in South Africa Malays and Indians and others, who during the last two hundred years have been introduced from Java, Ceylon, Madagascar, Mozambique and British India, and by intermarriage with each other and with the natives have produced a hybrid population generally classed together under the heading of the Mixed Races. These are of all colours, varying from yellow to dark brown. The tribes of Central Africa are as yet less known. Many of them exhibit racial characteristics allied to those of the tribes of South Africa, but with in some cases an admixture of Arab blood.

East Africa.

Protectorate—Black and brown:	
Natives } estimated {	4,000,000
Asiatics }	25,000
Zanzibar—Black and brown	200,000
Uganda	3,200,000
	7,425,000

West Africa.

	Estimated.
Nigeria (including Lagos)—Black and brown	15,000,000
Gold Coast and hinterland—Chiefly black	2,700,000
Sierra Leone	1,000,000
Gambia	163,000
	18,863,000

From east to west across Africa the aboriginal nations are mostly of the black negroid type, their varieties being only imperfectly known. The tendency of some of the lower negroid types has been to drift towards the west coast, where they still practise cannibalistic and fetish rites. On the east coast are found much higher types approaching to the Christian races of Abyssinia, and from east to west there has been a wide admixture of Arab blood producing a light-brown type. In

Uganda and Nigeria a large proportion of the population is Arab and relatively light-skinned.

Australasia.

Australia—Black, very low type	200,000
Chinese and half castes, yellow	50,000
New Zealand—Maoria, brown, Chinese and half castes	53,000
Fiji—Polynesian, black and brown	121,000
Papua—Polynesian, black and brown	400,000
	824,000

The native races of Australia and the Polynesian groups of islands are divided into two main types known as the dark and light Polynesian. The dark type, which is black, is of a very low order, and in some of the islands still retains its cannibal habits. The aboriginal tribes of Australia are of a low-class black race, but generally peaceful and inoffensive in their habits. The white Polynesian races are of a very superior type, and exhibit, as in the Maoris of New Zealand, characteristics of a high order. The natives of Papua (New Guinea) are in a very low state of civilization. The estimate given of their numbers is approximate, as no census has been taken.

Canada.

Indians—Brown	100,000
---------------	---------

The only coloured native races of Canada are the Red Indians, many in tribal variety, but few in number.

Summary.

Native Populations:	
India	294,191,379
Ceylon and Eastern Colonies	5,144,954
West Indies	1,912,655
South Africa	5,211,329
British Central Africa	2,000,000
East Africa	7,425,000
West Africa	18,863,000
Australasia and Islands	824,000
Canada	100,000
	335,672,317
White populations	53,040,468
	Total 388,712,785

This is without taking into account the population of the lesser crown colonies or allowing for the increase likely to be shown by later censuses. Throughout the empire, and notably in the United Kingdom, there is among the white races a considerable sprinkling of Jewish blood.

The latest calculation of the entire population of the world, including a liberal estimate of 650,000,000 for peoples not brought under any census, gives a total of something over 1,500,000,000. The population of the empire may therefore be calculated as amounting to something more than one-fourth of the population of the world.

It is a matter of first importance in the geographical distribution of the empire that the five principal divisions, the United Kingdom, South Africa, India, Australasia and Canada *Divisions.* are separated from each other by the three great oceans of the world. The distance as usually calculated in nautical miles: from an English port to the Cape of Good Hope is 5840 m.; from the Cape of Good Hope to Bombay is 4610; from Bombay to Melbourne is 5630; from Melbourne to Auckland is 1830; from Auckland to Vancouver is 6210; from Halifax to Liverpool is 2744. From a British port direct to Bombay by way of the Mediterranean it is 6272; from a British port by the same route to Sydney 11,548 m. These great distances have necessitated the acquisition of intermediate ports suitable for coaling stations on the trade routes, and have determined the position of many of the lesser crown colonies which are held simply for military and commercial purposes. Such are the Bermudas, Gibraltar, Malta, Aden, Ceylon, the Straits Settlements, Labuan, Hong-Kong, which complete the

chain of connexion on the eastern route, and such on other routes are the lesser West African stations, Ascension, St. Helena, the Mauritius and Seychelles, the Falklands, Tristan da Cunha, and the groups of the western Pacific. Other annexations of the British empire have been rocky islets of the northern Pacific required for the purpose of telegraph stations in connexion with an all-British cable.

For purposes of political administration the empire falls into the three sections of the United Kingdom of Great Britain and Ireland, with the dependencies of the Channel Islands and the Isle of Man; the Indian empire, consisting of British India and the feudatory native states; and the colonial empire, comprising all other colonies and dependencies.

In the modern sense of extension beyond the limits of the United Kingdom the growth of the empire is of comparatively recent date. The Channel Islands became British as a part of the Norman inheritance of William the Conqueror. The Isle of Man, which was for a short time held in conquest by Edward I. and restored, was sold by its titular sovereign to Sir William Scrope, earl of Wiltshire, in 1393, and by his subsequent attainer for high treason and the confiscation of his estates, became a fief of the English crown. It was granted by Henry IV. in 1406 to Sir John Stanley, K. C., ancestor of the earls of Derby, by whom it was held till 1736, when it passed to James Murray, 2nd duke of Atholl, as heir-general of the 10th earl. It was inherited by his daughter Charlotte, wife of the 3rd duke of Atholl, who sold it to the crown for £70,000 and an annuity of £2000. With these exceptions and the nominal possession taken of Newfoundland by Sir Humphrey Gilbert in 1583, all the territorial acquisitions of the empire have been made in the 17th and subsequent centuries.

The following is a list of the British colonies and dependencies (other than those belonging to the Indian empire) together with a summary statement of the date and method of their acquisition. Arranged in chronological order they give some idea of the rate of growth of the empire. The dates are not, however, in all cases those in which British sovereignty was established. They indicate in some instances only the first definite step, such as the building of a fort, the opening of a trading station, or other act, which led later to the incorporation in the empire of the country indicated. In the case of Australian states or Canadian provinces originally part of other states or provinces the date is that, approximately, of the first settlement of British in the district named; e.g. there were British colonists in Saskatchewan in the last half of the 18th century, but the province was not constituted until 1905. Save where otherwise stated, British authority has been continuous from the first date mentioned in the table. Reference should be made to the articles on the various colonies.

Name.	Date.	Method of Acquisition.
Newfoundland	1583	Possession taken by Sir H. Gilbert for the crown.
<i>17th Century.</i>		
Barbados	1605-1625	Settlement.
Bermudas	1609	"
Gambia	c. 1618	"
St Christopher	1623	"
Novia Scotia	1628	"
Nevis	1628	"
Montserrat	1632	"
Antigua	1632	"
Honduras	1638	"
St Lucia	1638	"
Gold Coast	c. 1650	Settlement. Danish forts bought 1850, Dutch forts 1871. Northern Territories added 1897.

Name.	Date.	Method of Acquisition.
<i>17th Century (contd.).</i>		
St Helena	1651	Settled by East India Co. Government vested in British crown 1833.
Jamaica	1655	Conquest.
Bahamas	1666	Settlement.
Virgin Islands	1666-1672	Settlement and conquest.
N. W. Territories of Canada	1669	Settlement under royal charter of Hudson's Bay Co. Purchased from imp. gov. 1869, and transferred to Canada 1870.
Turks and Caicos Is.	1678	Settlement.
<i>18th Century.</i>		
Gibraltar	1704	Capitulation.
New Brunswick	1713	Cession.
Prince Edward Is.	1758	Conquest.
Ontario	1759-1790	With New Brunswick and Nova Scotia constituted Dominion of Canada 1867.
Quebec	1759-1790	Prince Edward Is. enters the confederation 1873. In 1880 all British possessions (other than Newfoundland) in North America annexed to the Dominion.
Dominica	1761	Conquest.
St Vincent	1769	Capitulation.
Grenada	1769	"
Tobago	1763	Cession. Afterwards in French possession. Recaptured 1803.
Falkland Is.	1765	Settlement. Recaptured 1832.
Saskatchewan	1766	Settlement. Separated from N.W. Territories of Canada 1905.
Pitcairn I.	1780	Settlement.
Straits Settlements	1786	Settlement and cession. Vested (1858) in crown by E. I. Co.
	1824	Transferred from Indian to colonial possessions 1867. Malacca in British occupation 1795-1818.
Sierra Leone	1787	Settlement.
Alberta	c. 1788	Separated from N.W. Territories of Canada 1905.
New South Wales	1788	Settlement.
Ceylon	1795	Capitulation.
Trinidad	1797	"
Malta	1800	"
<i>19th Century.</i>		
British Gulans	1803	Capitulation.
Tasmania	1803	Settlement.
Cape of Good Hope	1806	Capitulation. Present limits not attained until 1895. First British occupation 1795-1803.
Seychelles	1806	Capitulation.
Mauritius	1810	"
Manitoba	1811	Settlement by Red River or Selkirk colony. Created province of Canada 1870.
Ascension and Tristan da Cunha	1813	Military occupation.
B. Columbia and Vancouver Island	1821	Settlement under Hudson's Bay Co. Entered Canadian confederation 1871.
Natal	1824	Settlement. Natal Boers submit 1843.
Queensland	1824	Separated from New South Wales 1859.
West Australia	1826	Settlement.
Victoria	1834	Separated from New South Wales 1851.
South Australia	1836	Settlement.
New Zealand	1840	Settlement and treaty.
Hong-Kong	1841	Treaties. Kowloon on the mainland added in 1860, additional area leased 1898.
Labuan	1846	Cession. Incorporated in Straits Settlements 1906.
Lagos	1861	Cession. South Nigeria amalgamated with Lagos, under style of Colony and Protectorate of Southern Nigeria 1906.
Basutoland	1868	Annexation.
Fiji	1874	Cession.

Name.	Date.	Method of Acquisition.
<i>19th Century (contd.).</i>		
W. Pacific Islands, including Union, Ellice, Gilbert, Southern Solomon, and other groups	1877	High commission created by order in council, giving jurisdiction over islands not included in other colonial governments, nor within jurisdiction of other civilized powers. Protectorates declared over all these islands by 1900.
Federated Malay States	1874-1895	Treaty.
Cyprus	1878	Occupied by treaty.
North Borneo	1881	Treaty and settlement under royal charter. Protectorate assumed 1888.
Papua	1884	Protectorate declared.
Nigeria	1884-1886	Treaty, conquest and settlement under royal charter. Chartered Co.'s territory transferred to crown, and whole divided into North and South Nigeria 1900.
Somaliland	1884-1886	Occupation and cession. Protectorate declared 1887.
Bechuanaland	1885-1891	Protectorate declared. Southern portion annexed to Cape Colony 1895.
Zululand	1887	Annexation. Incorporated in Natal 1897.
Sarawak	1888	Protectorate declared.
Brunei	1888	Protectorate declared.
British East Africa	1888	Treaty, conquest and settlement under royal charter. Transferred to crown 1895.
Rhodesia	1888-1893	Treaty, conquest and settlement under royal charter.
Zanzibar	1890	Protectorate declared.
Uganda	1890-1896	Treaty and protectorate.
Nyasaland	1891	Protectorate declared.
Ashanti	1896	Military occupation.
Wei-hai-wei	1898	Lease from China.
Pacific Islands—		
Christmas, Fanning, Penrhyn, Survarov	1898	Annexed for purposes of projected Pacific cable.
Choiseul and Isabel Is. (Solomon Group)	1899	Cession.
Tonga and Niue	1900	Protectorate declared.
Orange Free State	1900	Annexation. Formerly British 1848-1854.
Transvaal and Swaziland	1900	Annexation. Formerly British 1877-1881.
<i>20th Century.</i>		
Kelantan, Trengganu, &c.	1909	Cession from Siam.

In the Pacific are also Bird Island, Bramble Cay, Cato Island, Cook Islands, Danger Islands, Ducie Island, Dudos, Howland Island, Jarvis Island, Kermadec Islands, Macquarie Island, Manihiki Islands, Nassau Island, Palmerston Island, Palmyra Island, Phoenix Group, Purdy Group, Raine Island, Rakaanga Island, Rotumah Island, Surprise Island, Washington or New York Island, Willis Group and Wreck Reef.

In the Indian Ocean there are, besides the colonies already mentioned, Rodriguez, the Chagos Islands, St Brandon Islands, Amirante Islands, Aldabra, Kuria Muria Islands, Maldive Islands and some other small groups.

In certain dependencies the sovereignty of Great Britain is not absolute. The island of Cyprus is nominally still part of the Turkish empire, but in 1878 was handed over to Great Britain for occupation and administration; Great Britain now making to the Porte on account of the island an annual payment of £5000. The administration is in the hands of an official styled high commissioner, who is invested with the powers usually conferred on a colonial governor. In Zanzibar and other regions of equatorial Africa the native rulers retain considerable powers; in the Far East certain areas are held on lease from China.

Egypt, without forming part of the British empire, came under the military occupation of Great Britain in 1882. "By right of conquest" Great Britain subsequently claimed a share in the administration of the former Sudan provinces of Egypt, and an agreement of the 19th of January 1899 established the

joint sovereignty of Great Britain and Egypt over what is now known as the Anglo-Egyptian Sudan.

The Indian section of the empire was acquired during the 17th-19th centuries under a royal charter granted to the East India Company by Queen Elizabeth in 1600. It was transferred to the imperial government in 1858, and Queen Victoria was proclaimed empress under the Royal Titles Act in 1877. The following list gives the dates and method of acquisition of the centres of the main divisions of the Indian empire. They have, in most instances, grown by general process of extension to their present dimensions.

Name.	Date.	Method of Acquisition.
Madras	1639 to 1748	By treaty and subsequent conquest. Fort St George, the foundation of Madras, was the first territorial possession of the E.I.Co. in India. It was acquired by treaty with its Indian ruler. Madras was raised into a presidency in 1683; ceded to France 1746; recovered 1748.
Bombay	1608 to 1685	Treaty and cession. Trade first established 1608. Ceded to British crown by Portgaul 1661. Transferred to E.I. Co. 1668. Presidency removed from Surat 1687.
Bengal	1633 to 1765	Treaty and subsequent conquests. First trade settlement established by treaty at Pipili in Orissa 1633. Erected into presidency by separation from Madras 1681. Virtual sovereignty announced by E.I. Co., as result of conquests of Clive, 1765.
United Provinces of Agra and Oudh	1764 to 1856	By conquests and treaty through successive stages, of which the principal dates were 1801-3 -14-15. In 1832 the nominal sovereignty of Delhi, till then retained by the Great Mogul, was resigned into the hands of the E.I. Co. Oudh, of which the conquest may be said to have begun with the battle of Baxar in 1764, was finally annexed in 1856.
Central Provinces	1802-1817	By conquest and treaty.
Eastern Bengal and Assam	1823-1826	Conquest and cession. The Bengal portion of the province by separation from Bengal in 1905.
Burma	1824-1852	Conquest and cession.
Punjab	1849	Conquest and annexation. Made into distinct province 1859.
N.-W. Frontier Province	1901	Subdivision.
Ajmere and Merwara	1818	By conquest and cession.
Coorg	1834	Conquest and annexation.
British Baluchistan	1854-1876	Conquest and treaty.
Andaman Islands	1858	Annexation.

The following is a list of some of the principal Indian states which are more or less under the control of the British government:—

1. In direct political relations with the governor-general in council.

Hyderabad.	Mysore.
Baroda.	Kashmir.
2. Under the Rajputana agency.

Udaipur.	Bharatpur.
Jodhpur.	Dholpur.
Bikanir.	Alwar.
Jaipur (and feudatories).	Tonk.
3. Under the Central Indian agency.

Indore.	Bhopal.
Rewa.	Gwalior.
4. Under the Bombay government.

Cutch.	Khairpur (Sind).
Kolhapur (and dependencies).	Bhanagar.

5. Under the Madras government.
Travancore. Cochin.
6. Under the Central Provinces government.
Bastar.
7. Under the Bengal government.
Kuch Behar. Sikkim.
8. Under United Provinces government.
Rampur. Garhwal.
9. Under the Punjab government.
Patiala. Mandi.
Bahawalpur. Sirmur (Nabha).
Jind. Faridkot.
Nabha. Chamba.
Kapurthala.
10. Under the government of Burma.
Shan states. Karen states.

In addition to these there are British tracts known as the Upper Burma frontier and the Burma frontier. There is also a sphere of British influence in the border of Afghanistan. The state of Nepal, though independent as regards its internal administration, has been since the campaign of 1814-15 in close relations with Great Britain. It is bound to receive a British resident, and its political relations with other states are controlled by the government of India. All these native states have come into relative dependency upon Great Britain as a result of conquest or of treaty consequent upon the annexation of the neighbouring provinces. The settlement of Aden, with its dependencies of Perim and Sokotra Island, forms part of the government of Bombay.

This vast congeries of states, widely different in character, and acquired by many different methods, holds together under the supreme headship of the crown on a generally acknowledged triple principle of self-government, self-support and self-defence. The principle is more fully applied in some parts of the empire than in others; there are some parts which have not yet completed their political evolution; some others in which the principle is temporarily or for special reasons in abeyance; others, again—chiefly those of very small extent, which are held for purposes of the defence or advantage of the whole—to which it is not applicable; but the principle is generally acknowledged as the structural basis upon which the constitution of the empire exists.

In its relation to the empire the home section of the British Isles is distinguished from the others as the place of origin of the British race and the residence of the crown. The history and constitutional development of this portion of the empire will be found fully treated under separate headings. (See ENGLAND; WALES; IRELAND; SCOTLAND; UNITED KINGDOM; ENGLISH HISTORY; INDIA; AFRICA; AUSTRALIA; CANADA; &c.)

It is enough to say that for purposes of administration the Indian empire is divided into nine great provinces and four minor commissionerships. The nine great provinces are presided over by two governors (Bombay and Madras), five lieutenant-governors (Bengal, Eastern Bengal and Assam, United Provinces (Agra and Oudh), the Punjab and Burma); a chief commissioner (the Central Provinces) and an agent to the governor-general (the N.-W. Frontier Province). The four minor commissionerships are presided over each by a chief commissioner. Above these the supreme executive authority in India is vested in the viceroy in council. The council consists of six ordinary members besides the existing commander-in-chief. For legislative purposes the governor-general's council is increased by the addition of fifteen members nominated by the crown, and has power under certain restrictions to make laws for British India, for British subjects in the native states, and for native Indian subjects of the crown in any part of the world. The administration of the Indian empire in England is carried on by a secretary of state for India assisted by a council of not less than ten members. The expenditure of the revenues is under the control of the secretary in council.

The colonial empire comprises over fifty distinct governments. It is divided into colonies of three classes and dependencies; these, again, are in some instances associated for administrative purposes in federated groups. The three classes of colonies are crown colonies, colonies possessing representative institutions but not responsible government, and colonies possessing representative institutions and responsible government. In crown colonies the crown has entire control of legislation, and the public officers are under the control of the home government. In representative colonies the crown has only a veto on legislation, but the home government retains control of the public officers. In responsible colonies the crown retains a veto upon legislation, but the home government has no control of any public officer except the governor.

In crown colonies—with the exception of Gibraltar and St Helena, where laws may be made by the governor alone—laws are made by the governor with the concurrence of a council nominated by the crown. In some crown colonies, chiefly those acquired by conquest or cession, the authority of this council rests wholly on the crown; in others, chiefly those acquired by settlement, the council is created by the crown under the authority of local or imperial laws. The crown council of Ceylon may be cited as an example of the first kind, and the crown council of Jamaica of the second.

In colonies possessing representative institutions without responsible government, the crown cannot (generally) legislate by order in council, and laws are made by the governor with the concurrence of the legislative body or bodies, one at least of these bodies in cases where a second chamber exists possessing a preponderance of elected representatives. The Bahamas, Barbados, and Bermuda have two legislative bodies—one elected and one nominated by the crown; Malta and the Leeward Islands have but one, which is partly elected and partly nominated.

Under responsible government legislation is carried on by parliamentary means exactly as at home, with a cabinet responsible to parliament, the crown reserving only a right of veto, which is exercised at the discretion of the governor in the case of certain bills. The executive councils in those colonies, designated as at home by parliamentary choice, are appointed by the governor alone, and the other public officers only nominally by the governor on the advice of his executive council.

Colonial governors are classed as governors-general; governors; lieutenant-governors; administrators; high commissioners; and commissioners, according to the status of the colony and dependency, or group of colonies and dependencies, over which they preside. Their powers vary according to the position which they occupy. In all cases they represent the crown.

As a consequence of this organization the finance of crown colonies is under the direct control of the imperial government; the finance of representative colonies, though not directly controlled, is usually influenced in important departures by the opinion of the imperial government. In responsible colonies the finance is entirely under local control, and the imperial government is dissociated from either moral or material responsibility for colonial debts.

In federated groups of colonies and dependencies matters which are of common interest to a given number of separate governments are by mutual consent of the federating communities adjudged to the authority of a common government, which, in the case of self-governing colonies, is voluntarily created for the purpose. The associated states form under the federal government one federal body, but the parts retain control of local matters, and exercise all their original rights of government in regard to these. The two great self-governing groups of federated colonies within the empire are the Dominion of Canada and the Commonwealth of Australia. In South Africa unification was preferred to federation, the then self-governing colonies being united in 1910 into one state—the Union of South Africa. India, of which the associated provinces are under the control of the central government, may be given as an example of the practical federation of dependencies. Examples

of federated crown colonies and lesser dependencies are to be found in the Leeward Island group of the West Indies and the federated Malay States.

This rough system of self-government for the empire has been evolved not without some strain and friction, by the recognition through the vicissitudes of three hundred years of the value of independent initiative in the development of young countries. Queen Elizabeth's first patent to Sir Walter Raleigh permitted British subjects to accompany him to America, "with guarantee of a continuance of the enjoyment of all the rights which her subjects enjoyed at home."

This guarantee may presumably have been intended at the time only to assure the intending settlers that they should lose no rights of British citizenship at home by taking up their residence in America. Its mutual interpretation in a wider sense, serving at once to establish in the colony rights of citizenship equivalent to those enjoyed in England, and to preserve for the colonist the status of British subject at home and abroad, has formed in application to all succeeding systems of British colonialization the unconscious charter of union of the empire.

The first American colonies were settled under royal grants, each with its own constitution. The immense distance in time which in those days separated America from Great Britain secured them from interference by the home authorities. They paid their own most moderate governing expenses, and they contributed largely to their own defence. From the middle of the 17th century their trade was not free, but this was the only restriction from which they suffered. The great war with France in the middle of the 18th century temporarily destroyed this system. That war, which resulted in the conquest of Canada and the delivery of the North American colonies from French antagonism, cost the imperial exchequer £90,000,000. The attempt to avert the repetition of such expenditure by the assertion of a right to tax the colonies through the British parliament led to the one great rupture which has marked the history of the empire. It has to be noted that at home during the latter half of the 17th century and the earlier part of the 18th century parliamentary power had to a great extent taken the place of the divine right of kings. But parliamentary power meant the power of the English people and taxpayers. The struggle which developed itself between the American colonies and the British parliament was in fact a struggle on the part of the people and taxpayers of one portion of the empire to resist the domination of the people and taxpayers of another portion. In this light it may be accepted as having historically established the fundamental axiom of the constitution of the empire, that the crown is the supreme head from which the parts take equal dependence.

The crown requiring advice in the ordinary and constitutional manner receives it in matters of colonial administration from the secretaries of state for the colonies and for India. After the great rupture separate provision in the home government for the administration of colonial affairs was at first judged to be unnecessary, and the "Council of Trade and Plantations," which up to that date had supplied the place now taken by the two offices of the colonies and India, was suppressed in 1782. There was a reaction from the liberal system of colonial self-government, and an attempt was made to govern the colonies simply as dependencies.

In 1791, not long after the extension of the range of parliamentary authority in another portion of the empire, by the creation in 1784 of the Board of Control for India, Pitt made the step forward of granting to Canada representative institutions, of which the home government kept the responsible control. Similar institutions were also given at a later period to Australia and South Africa. But the long peace of the early part of the 19th century was marked by great colonial developments, Australia, Canada and South Africa became important communities. Representative institutions controlled by the home government were insufficient, and they reasserted the claim for liberty to manage their own affairs.

¹Or "Board," as it became in 1695.

Fully responsible government was granted to Canada in 1840, and gradually extended to the other colonies. In 1854 a separate secretary of state for the colonies was appointed at home, and the colonial office was established on its present footing. In India, as in the colonies, there came with the growing needs of empire a recognition of the true relations of the parts to each other and of the whole to the crown. In 1858, on the complete transference of the territories of the East India Company to the crown, the board of control was abolished, and the India Council, under the presidency of a secretary of state for India, was created. It was especially provided that the members of the council may not sit in parliament.

Thus, although it has not been found practicable in the working of the British constitution to carry out the full theory of the direct and exclusive dependence of colonial possessions on the crown, the theory is recognized as far as possible. It is understood that the principal sections of the empire enjoy equal rights under the crown, and that none is subordinate to another. The intervention of the imperial parliament in colonial affairs is only admitted theoretically in so far as the support of parliament is required by the constitutional advisers of the crown. To bring the practice of the empire into complete harmony with the theory it would be necessary to constitute, for the purpose of advising the crown on imperial affairs, a council in which all important parts of the empire should be represented.

The gradual recognition of the constitutional theory of the British empire, and the assumption by the principal colonies of full self-governing responsibilities, has cleared the way for a movement in favour of a further development which should bring the supreme headship of the empire more into accord with modern ideas.

It was during the period of domination of the "Manchester school," of which the most effective influence in public affairs was exerted for about thirty years, extending from 1845 to 1875, that the fullest development of colonial self-government was attained, the view being generally accepted at that time that self-governing institutions were to be regarded as the preliminary to inevitable separation. A general inclination to withdraw from the acceptance of imperial responsibilities throughout the world gave to foreign nations at the same time an opportunity by which they were not slow to profit, and contributed to the force of a reaction of which the part played by Great Britain in the scramble for Africa marked the culmination. Under the increasing pressure of foreign enterprise, the value of a federation of the empire for purposes of common interest began to be discussed. Imperial federation was openly spoken of in New Zealand as early as 1852. A similar suggestion was officially put forward by the general association of the Australian colonies in London in 1857. The Royal Colonial Institution, of which the motto "United Empire" illustrates its aims, was founded in 1868. First among leading British statesmen to repudiate the old interpretation of colonial self-government as a preliminary to separation, Lord Beaconsfield, in 1872, spoke of the constitutions accorded to the colonies as "part of a great policy of imperial consolidation." In 1875 W. E. Forster, afterwards a member of the Liberal government, made a speech in which he advocated imperial federation as a means by which it might become practicable to "replace dependence by association." The foundation of the Imperial Federation League—in 1884, with Forster for its first president, shortly to be succeeded by Lord Rosebery—marked a distinct step forward. The Colonial Conferences of 1887 and subsequent years (the title being changed to Imperial Conference in 1907), in which colonial opinion was sought and accepted in respect of important questions of imperial organization and defence, and the enthusiastic loyalty displayed by the colonies towards the crown on the occasion of the jubilee manifestations of Queen Victoria's reign, were further indications of progress in the same direction. Coincidentally with this development, the achievements of Sir George Goldie and Cecil Rhodes, who, the one in West Africa and the other in South Africa, added between them to the empire in a space of less than twenty years a dominion of greater extent than the whole of British

India, followed by the action of a host of distinguished disciples in other parts of the world, effectually stemmed the movement initiated by Cobden and Bright. A tendency which had seemed temporarily to point towards a complacent dissolution of the empire was arrested, and the closing years of the 19th century were marked by a growing disposition to appreciate the value and importance of the unique position which the British empire has created for itself in the world. No stronger demonstration of the reality of imperial union could be needed than that which was afforded by the support given to the imperial forces by the colonies and India in the South African War. It remained only to be seen by what process of evolution the further consolidation of the empire would find expression in the machinery of government. A step in this direction was taken in 1907, when at the Colonial Conference held in London that year it was decided to form a permanent secretariat to deal with the common interests of the self-governing colonies and the mother-country. It was further decided that conferences, to be called in future Imperial Conferences, between the home government and the governments of the self-governing dominions, should be held every four years, and that the prime minister of Great Britain should be *ex officio* president of the conference. No executive power was, however, conferred upon the conference.

The movement in favour of tariff reform initiated by Mr Chamberlain (*q.v.*) in 1903 with the double object of giving a preference to colonial goods and of protecting imperial trade by the imposition in certain cases of retaliatory duties on foreign goods, was a natural evolution of the imperialist idea, and of the fact that by this time the trade-statistics of the United Kingdom had proved that trade with the colonies was forming an increasingly large proportion of the whole. In spite of the defeat of the Unionist party in England in 1906, and the accession to power of a Liberal government opposed to anything which appeared to be inconsistent with free trade, the movement for colonial preference, based on tariff reform, continued to make headway in the United Kingdom, and was definitely adopted by the Unionist party. And at the Imperial Conference of 1907 it was advocated by all the colonial premiers, who could point to the progress made in their own states towards giving a tariff preference to British goods and to those of one another.

The question of self-government is closely associated with the question of self-support. Plenty of good land and the liberty to manage their own affairs were the causes assigned by Adam Smith for the marked prosperity of the British colonies towards the end of the 18th century. The same causes are still observed to produce the same effects, and it may be pointed out that, since the date of the latest of Adam Smith's writings, upwards of 6,000,000 sq. m. of virgin soil, rich with possibilities of agricultural, pastoral and mineral wealth, have been added to the empire. In the same period the white population has grown from about 12,000,000 to 53,000,000, and the developments of agricultural and industrial machinery have multiplied, almost beyond computation, the powers of productive labour.

It is scarcely possible within this article to deal with so widely varied a subject as that of the productions and industry of the empire. For the purposes of a general statement, it is interesting to observe that concurrently with the acquisition of the vast continental areas during the 19th century, the progress of industrial science in application to means of transport and communication brought about a revolution of the most radical character in the accepted laws of economic development. Railways did away with the old law that the spread of civilization is necessarily governed by facilities for water carriage and is consequently confined to river valleys and sea-shores. Steam and electricity opened to industry the interior of continents previously regarded as unapproachable. The resources of these vast inland spaces which have lain untouched since history began became available to individual enterprise; and over a great portion of the earth's surface were brought within the possessions of the British empire. The production of raw material within the empire increased at a rate which can only be appreciated

The imperial factor in industry and trade.

by a careful study of figures, and by a comparison of the total of these figures with the total figures of the world. The tropical and temperate possessions of the empire include every field of production which can be required for the use of man. There is no main staple of human food which is not grown; there is no material of textile industry which is not produced. The British empire gives occupation to more than one-third of the persons employed in mining and quarrying in the world. It may be interesting, as an indication of the relative position in this respect of the British empire to the world, to state that at present it produces one-third of the coal supply of the world, one-sixth of the wheat supply, and very nearly two-thirds of the gold supply. But while these figures may be taken as in themselves satisfactory, it is far more important to remember that as yet the potential resources of the new lands opened to enterprise have been barely conceived, and their wealth has been little more than scratched. Population as yet has been only very sparsely sprinkled over the surface of many of the areas most suitable for white settlement. In the wheat lands of Canada, the pastoral country of Australasia, and the mineral fields of South Africa and western Canada alone, the undeveloped resources are such as to ensure employment to the labour and satisfaction to the needs of at least as many millions as they now contain thousands of the British race. In respect of this promise of the future the position of the British empire is unique.

It is not too much to say that trade has been at once the most active cause of expansion and the most potent bond of union in the development of the empire. Trade with the tropical and settlement in the temperate regions of the world formed the basis upon which the foundations of the empire were laid. Trading companies founded most of the American and West Indian colonies; a trading company won India; a trading company colonized the north-western districts of Canada; commercial wars during the greater part of the 18th century established the British command of the sea, which rendered the settlement of Australasia possible. The same wars gave Great Britain South Africa, and chartered companies in the 19th century carried the British flag into the interior of the African continent from south and east and west. Trading companies developed Borneo and Fiji. The bonds of prosperous trade have kept the Australasian colonies within the empire. The protection of colonial commerce by the imperial navy is one of the strongest of material links which connect the crown with the outlying possessions of the empire.

The trade of the empire, like the other developments of imperial public life, has been profoundly influenced by the variety of local conditions under which it has flourished. In the early settlement of the North American colonies their trade was left practically free; but by the famous ^{imperial trade policy.} Navigation Act of 1660 the importation and exportation of goods from British colonies were restricted to British ships, of which the master and three-fourths of the mariners were English. This act, of which the intention was to encourage British shipping and to keep the monopoly of British colonial trade for the benefit of British merchants, was followed by many others of a similar nature up to the time of the repeal of the Corn Laws in 1846 and the introduction of free trade into Great Britain. The Navigation Acts were repealed in 1849. Thus for very nearly two hundred years British trade was subject to restrictions, of which the avowed intention was to curtail the commercial intercourse of the empire with the world. During this period the commercial or mercantile system, of which the fallacies were exposed by the economists of the latter half of the 18th century, continued to govern the principles of British trade. Under this system monopolies were common, and among them few were more important than that of the East India Company. In 1813 the trade of India was, however, thrown open to competition, and in 1846, after the introduction of free trade at home, the principal British colonies which had not yet at that date received the grant of responsible government were specially empowered to abolish differential duties upon foreign trade. A first result of the commercial emancipation of the

colonies was the not altogether unnatural rise in the manufacturing centres of the political school known as the Manchester school, which was disposed to question the value to Great Britain of the retention of colonies which were no longer bound to give her the monopoly of their commercial markets. An equally natural desire on the part of the larger colonies to profit by the opportunity which was opened to them of establishing local manufactures of their own, combined with the convenience in new countries of using the customs as an instrument of taxation, led to something like a reciprocal feeling of resentment, and there followed a period during which the policy of Great Britain was to show no consideration for colonial trade, and the policy of the principal colonies was to impose heavy duties upon British trade. By a gradual process of better understanding, largely helped by the development of means of communication, the antagonistic extreme was abandoned, and a tendency towards a system of preferential duties within the empire displayed itself. At the Colonial Conference held in London in 1887 a proposal was formally submitted by the South African delegate for the establishment within the empire of a preferential system, imposing a duty of

Colonial preference.

2% upon all foreign goods, the proceeds to be directed to the maintenance of the imperial navy. To this end it was requested that certain treaties with foreign nations which imposed restrictions on the trade of various parts of the empire with each other should be denounced. Some years later, a strong feeling having been manifested in England against any foreign engagement standing in the way of new domestic trade arrangements between a colony and the mother-country, the German and Belgian treaties in question were denounced (1897). Meanwhile, simultaneously with the movement in favour of reciprocal fiscal advantages to be granted within the empire by the many local governments to each other, there was a growth of the perception that an increase of the foreign trade of Great Britain, carried on chiefly in manufactured goods, was accompanied by a corresponding enlargement of the home markets for colonial raw material, and consequently that injury to the foreign trade of Great Britain, while as yet it so largely outweighed the trade between the United Kingdom and the colonies, must necessarily react upon the colonies. This view was definitely expressed at the Colonial Conference at Ottawa in 1894, and was one of the factors which led to the relinquishment of the demand that in return for colonial concessions there should be an imposition on the part of Great Britain of a differential duty upon foreign goods. Canada was the first important British colony to give substantial expression to the new imperial sentiment in commercial matters by the introduction in 1897 of an imperial tariff, granting without any reciprocal advantage a deduction of 25% upon customs duties imposed upon British goods. The same advantage was offered to all British colonies trading with her upon equal terms. In later years the South African states, Australia and New Zealand also granted preferential treatment to British goods. Meanwhile in Great Britain the system of free imports, regarded as "free trade" (though only one-sided free trade), had become the established policy, customs duties being only imposed for purposes of revenue on a few selected articles, and about half the national income was derived from customs and excise. In most of the colonies customs form of necessity one of the important sources of revenue. It is, however, worthy of remark that in the self-governing colonies, even those which are avowedly protectionist, a smaller proportion of the public revenue was derived from customs and excise than was derived from these sources in the United Kingdom. The proportion in Australasia before federation was about one quarter. In Canada it is more difficult to estimate it, as customs and excise form the principal provision made for federal finance, and note must therefore be taken of the separate sources of revenue in the provinces. With these reservations it will still be seen that customs, or, in other words, a tax upon the movements of trade, forms one of the chief sources of imperial revenue.

The development of steam shipping and electricity gave to the movements of trade a stimulus no less remarkable than that

given by the introduction of railroads and industrial machinery to production and manufactures. Whereas at the beginning of the 19th century the journey to Australia occupied eight months, and business communications between Sydney and London could not receive answers within the year, at the beginning of the 20th century the journey could be accomplished in thirty-one days, and telegraphic despatches enabled the most important business to be transacted within twenty-four hours. For one cargo carried in the year at the beginning of the 19th century at least six could now be carried by the same ship, and from the point of view of trade the difference of a venture which realizes its profits in two months, as compared with one which occupied a whole year, does not need to be insisted on. The increased rapidity of the voyage and the power of daily communication by telegraph with the most distant markets have introduced a wholly new element into the national trade of the empire, and commercial intercourse between the southern and the northern hemispheres has received a development from the natural alternation of the seasons, of which until quite recent years the value was not even conceived. Fruit, eggs, butter, meat, poultry and other perishable commodities pass in daily increasing quantities between the northern and the southern hemispheres with an alternate flow which contributes to raise in no inconsiderable degree the volume of profitable trade. Thus the butter season of Australasia is from October to March, while the butter season of Ireland and northern Europe is from March to October. In three years after the introduction of ice-chambers into the steamers of the great shipping lines, Victoria and New South Wales built up a yearly butter trade of £1,000,000 with Great Britain without seriously affecting the Irish and Danish markets whence the summer supply is drawn. These facilities, combined with the enormous additions made to the public stock of land and labour, contributed to raise the volume of trade of the empire from a total of less than £100,000,000 in the year 1800 to a total of nearly £1,500,000,000 in 1900. The declared volume of British exports to all parts of the world in 1800 was £38,120,120, and the value of British imports from all parts of the world was £30,570,605; total, £68,690,725. As in those days the colonies were not allowed to trade with any other country this must be taken as representing imperial trade. The exact figures of the trade of India, the colonies, and the United Kingdom for 1900 were: imports, £809,178,209; exports, £657,899,363; total, £1,467,077,572.

A question of sovereign importance to the continued existence of the empire is the question of defence. A country of which the main thoroughfares are the oceans of the world demands in the first instance a strong navy. It has *imperial defence.* of late years been accepted as a fundamental axiom of defence that the British navy should exceed in strength any reasonable combination of foreign navies which could be brought against it, the accepted formula being the "two-power standard," i.e. a 10% margin over the joint strength of the two next powers. The expense of maintaining such a floating armament must be colossal, and until within the decade 1890-1900 it was borne exclusively by the taxpayers of the United Kingdom. As the benefits of united empire have become more consciously appreciated in the colonies, and the value of the fleet as an insurance for British commerce has been recognized, a desire has manifested itself on the part of the self-governing colonies to contribute towards the formation of a truly imperial navy. In 1895 the Australasian colonies voted a subsidy of £126,000 per annum for the maintenance of an Australasian squadron, and in 1897 the Cape Colony also offered a contribution of £30,000 a year to be used at the discretion of the imperial government for naval purposes. The Australian contribution was in 1902 increased to £240,000, and that of the Cape to £50,000, while Natal voted £35,000 a year and Newfoundland £3000. But apart from these comparatively slight contributions, and the local up-keep of colonial fortifications,—and the beginning in 1908-1909 of an Australian torpedo-boat flotilla provided by the Commonwealth,—the whole cost of the imperial navy, on which ultimately the security of the empire rested, remained to be

borne by the taxpayers in the British islands. The extent of this burden was emphasized in 1909 by the revelations as to the increase of the German (and the allied Austrian) fleet. At this crisis in the history of the two-power standard a wave of enthusiasm started in the colonies, resulting in the offer of "Dreadnoughts" from New Zealand and elsewhere; and the British government called an Imperial Conference to consider the whole question afresh.

Land defence, though a secondary branch of the great question of imperial defence, has been intimately connected with the development and internal growth of the empire. In the case of the first settlement of the American colonies they were expected to provide for their own land defence. To some extent in the early part of their career they carried out this expectation, and even on occasion, as in the taking of Louisburg, which was subsequently given back at the peace of Aix-la-Chapelle as the price of the French evacuation of Madras, rendered public service to the empire at large. In India the principle of local self-defence was from the beginning carried into practice by the East India Company. But in America the claim of the French wars proved too heavy for local resources. In 1755 Great Britain intervened with troops sent from home under General Braddock, and up to the outbreak of the American War the cost of the defence of the North American colonies was borne by the imperial exchequer. To meet this expense the imperial parliament took upon itself the right to tax the American colonies. In 1765 a Quartering Act was passed by which 10,000 imperial troops were quartered in the colonies. As a result of the American War which followed and led to the loss of the colonies affected, the imperial authorities accepted the charge of the land defences of the empire, and with the exception of India and the Hudson Bay territories, where the trading companies determined to pay their own expenses, the whole cost of imperial defence was borne, like the cost of the navy, by the taxpayers of the United Kingdom. This condition of affairs lasted till the end of the Napoleonic Wars. During the thirty years' peace which followed there came time for consideration. The fiscal changes which towards the middle of the 19th century gave to the self-governing colonies the command of their own resources very naturally carried with them the consequence that a call should be made on colonial exchequers to provide for their own governing expenses. Of these defence is obviously one of the most essential. Coincidentally, therefore, with the movements of free trade at home, the renunciation of what was known as the mercantile system and the accompanying grants of constitutional freedom to the colonies, a movement for the reorganization of imperial defence was set on foot. In the decade which elapsed between 1846 and 1856 the movement as regards the colonies was confined chiefly to calls made upon them to contribute to their own defence by providing barracks, fortifications, &c., for the accommodation of imperial troops, and in some cases paying for the use of troops not strictly required for imperial purposes. In 1857 the Australian colonies agreed to pay the expenses of the imperial garrison quartered in Australia. This was a very wide step from the imperial attempt to tax the American colonies for a similar purpose in the preceding century. Nevertheless, in evidence given before a departmental committee in 1859, it was shown that at that time the colonies of Great Britain were free from almost every obligation of contributing either by personal service or money payment towards their own defence, and that the cost of military expenditure in the colonies in the preceding year had amounted in round figures to £4,000,000. A committee of the House of Commons sat in 1861 to consider the question, and in 1862 it was resolved, without a division, that "colonies exercising the right of self-government ought to undertake the main responsibility of providing for their own internal order and security, and ought to assist in their own external defence." The decision was accepted as the basis of imperial policy. The first effect was the gradual withdrawing of imperial troops from the self-governing colonies, together with the encouragement of the development of local military systems by the loan, when desired, of imperial military experts. A call was also made for larger military contributions from some of

the crown colonies. The committee of 1859 had emphasized in its report the fact that the principal dependence of the colonies for defence is necessarily upon the British navy, and in 1865, exactly 100 years after the Quartering Act, which had been the cause of the troubles that led to the independence of the United States, a Colonial Naval Defence Act was passed which gave power to the colonies to provide ships of war, steamers, and volunteers for their own defence, and in case of necessity to place them at the disposal of the crown. In 1868 the Canadian Militia Act gave the fully organized nucleus of a local army to Canada. In the same year the imperial troops were withdrawn from New Zealand, leaving the colonial militia to deal with the native war still in progress. In 1870 the last imperial troops were withdrawn from Australia, and in 1873 it was officially announced that military expenditure in the colonies was almost "wholly for imperial purposes." In 1875 an imperial officer went to Australia to report for the Australian government upon Australian defence. The appointment in 1879 of a royal commission to consider the question of imperial defence, which presented its report in 1882, led to a considerable development and reorganization of the system of imperial fortifications. Coaling stations were also selected with reference to the trade routes. In 1885 rumours of war roused a very strong feeling in connexion with the still unfinished and in many cases unwarmed condition of the fortifications recommended by the commission of 1879. Military activity was stimulated throughout the empire, and the Colonial Defence Committee was created to supply a much-felt need for organized direction and advice to colonial administrations acting necessarily in independence of each other. The question of colonial defence was among the most important of the subjects discussed at the colonial conference held in London in 1887, and it was at this conference that the Australasian colonies first agreed to contribute to the expense of their own naval defence. From this date the principle of local responsibility for self-defence has been fully accepted. India has its own native army, and pays for the maintenance within its frontiers of an imperial garrison. Early in the summer of 1890, when hostilities in South Africa appeared to be imminent, the governments of the principal colonies took occasion to express their approval of the South African policy pursued by the imperial government, and offers were made by the governments of India, the Australasian colonies, Canada, Hong-Kong, the Federal Malay states, some of the West African and other colonies, to send contingents for active service in the event of war. On the outbreak of hostilities these offers, on the part of the self-governing colonies, were accepted, and colonial contingents upwards of 30,000 strong were among the most efficient sections of the British fighting force. The manner in which these colonial contingents were raised, their admirable fighting qualities, and the service rendered by them in the field, disclosed altogether new possibilities of military organization within the empire, and in subsequent years the subject continued to engage the attention of the statesmen of the empire. Progress in this field lay chiefly in the increased support given in the colonial states to the separate local movements for self-defence; but in 1909 a scheme was arranged by Mr Haldane, by which the British War Office should co-operate with the colonial governments in providing for the training of officers and an interchange of views on a common military policy.

The important questions of justice, religion and instruction will be found dealt with in detail under the headings of separate sections of the empire. Systems of justice throughout the empire have a close resemblance to each other, and the judicial committee of the privy council, on which the self-governing colonies and India are represented, constitutes a supreme court of appeal (q.v.) for the entire empire. In the matter of religion, while no imperial organization in the strict sense is possible, the progress made by the Lambeth Conferences and otherwise (see ANGLICAN COMMUNION) has done much to bring the work of the Church of England in different parts of the world into a co-operative system. Religion, of which the forms are infinitely varied, is however everywhere free,

except in cases where the exercise of religious rites leads to practices foreign to accepted laws of humanity. It is perhaps interesting to state that the number of persons in the empire nominally professing the Christian religion is 58,000,000, of Mahomedans 94,000,000, of Buddhists 12,000,000, of Hindus 208,000,000, of pagans and others 25,000,000. Systems of instruction, of which the aim is generally similar in the white portions of the empire and is directed towards giving to every individual the basis of a liberal education, are governed wholly by local requirements. Native schools are established in all settled communities under British rule.

LITERATURE.—In recent years the subject of British imperialism has inspired a growing literature, and it is only possible here to name a selected number of the more important works which may usefully be consulted on different topics: Sir C. P. Lucas, *Historical Geography of the British Colonies* (1888, ed. sec.); H. E. Egerton, *Short History of British Colonial Policy* (1897); H. J. Mackinder, *Britain and the British Seas* (1902); Sir J. R. Seeley, *Expansion of England* (1883); *Growth of British Policy* (1895); Sir Charles Dilke, *Greater Britain* (1869), *Problems of Greater Britain* (1890), *The British Empire* (1899); G. R. Parkin, *Imperial Federation* (1892); Sir John Colomb, *Imperial Federation, Naval and Military* (1886); Sir G. S. Clarke, *Imperial Defence* (1897); Sidney Goldmann and others, *The Empire and the Century* (1905); J. L. Garvin, *Imperial Reciprocity* (1903); J. W. Welsford, *The Strength of a Nation* (1907); *Compatriots Club Essays* (1906); Sir H. Jenkyns, *British Rule and Jurisdiction beyond the Seas* (1902); Bernard Holland, *Imperium et Libertas* (1901); (for an anti-imperialist view) J. A. Hobson, *Imperialism* (1902). See also the Reports of the various colonial conferences, especially that of the Imperial Conference of 1907; and for trade statistics, J. Holt *Schooling a British Trade Book*. For the tariff reform movement in England see the articles **FREE TRADE AND PROTECTION**. (F. L. L.)

BRITISH HONDURAS, formerly called **BALIZE**, or **BELIZE**, a British crown colony in Central America; bounded on the N. and N.W. by the Mexican province of Yucatan, N.E. and E. by the Bay of Honduras, an inlet of the Caribbean Sea, and S. and W. by Guatemala. (For map, see **CENTRAL AMERICA**.) Pop. (1905) 40,372; area, 7562 sq. m. The frontier of British Honduras, as defined by the conventions of 1859 and 1893 between Great Britain and Guatemala, begins at the mouth of the river Sarstoon or Sarstun, in the Bay of Honduras; ascends that river as far as the rapids of Gracias à Dios; and thence, turning to the right, runs in a straight line to Garbutt's Rapids, on the Belize river. From this point it proceeds due north to the Mexican frontier, where it follows the river Hondo to its mouth in Chetumal Bay.

British Honduras differs little from the rest of the Yucatan peninsula. The approach to the coast is through the islets known as cays, and through coral reefs. It is both difficult and dangerous. For some miles inland the ground is low and swampy, thickly covered with mangroves and tropical jungle. Next succeeds a narrow belt of rich alluvial land, not exceeding a mile in width, beyond which, and parallel to the rivers, are vast tracts of sandy, arid land, called "pine ridges," from the red pines with which they are covered. Farther inland these give place, first, to the less elevated "broken ridges," and then to what are called "cahoon ridges," with a deep rich soil covered with myriads of palm trees. Next come broad savannas, studded with clumps of trees, through which the streams descending from the mountains wind in every direction. The mountains themselves rise in a succession of ridges parallel to the coast. The first are the Manatee Hills, from 800 to 1000 ft. high; and beyond these are the Cockscomb Mountains, which are about 4000 ft. high. No less than sixteen streams, large enough to be called rivers, descend from these mountains to the sea, between the Hondo and Sarstoon. The uninhabited country between Garbutt's Rapids and the coast south of Deep river was first explored in 1879, by Henry Fowler, the colonial secretary of British Honduras; it was then found to consist of open and undulating grasslands, affording fine pasturage in the west and of forests full of valuable timber in the east. Its elevation varies from 1200 to 3300 ft. Auriferous quartz and traces of other minerals have been discovered, but not in sufficient quantity to repay the cost of mining. The geology, fauna and flora of British Honduras do not materially differ from those of the neighbouring regions (see **CENTRAL AMERICA**).

Although the colony is in the tropics, its climate is subtropical. The highest shade temperature recorded is 98° F., the lowest 50°. Easterly sea-winds prevail during the greater part of the year. The dry season lasts from the middle of February to the middle of May; rain occurs at intervals during the other months, and almost continuously in October, November and December. The annual rainfall averages about 81½ in., but rises in some districts to 150 in. or more. Cholera, yellow fever and other tropical diseases occur sporadically, but, on the whole, the country is not unhealthy by comparison with the West Indies or Central American states.

Inhabitants.—British Honduras is a little larger than Wales, and has a population smaller than that of Chester (England). In 1904 the inhabitants of European descent numbered 1500, the Europeans 253, and the white Americans 118. The majority belong to the hybrid race descended from negro slaves, aboriginal Indians and white settlers. At least six distinct racial groups can be traced. These consist of (1) native Indians, to be found chiefly in forest villages in the west and north of the colony away from the sea coast; (2) descendants of the English buccaners, mixed with Scottish and German traders; (3) the woodcutting class known as "Belize Creoles," of more or less pure descent from African negroes imported, as slaves or as labourers, from the West Indies; (4) the Caribs of the southern districts, descendants of the population deported in 1796 from St Vincent, who were of mixed African and Carib origin; (5) a mixed population in the south, of Spanish-Indian origin, from Guatemala and Honduras; and (6) in the north another Spanish-Indian group which came from Yucatan in 1848. The population tends slowly to increase; about 45% of the births are illegitimate, and males are more numerous than females. Many tracts of fallow land and forest were once thickly populated, for British Honduras has its ruined cities, and other traces of a lost Indian civilization, in common with the rest of Central America.

Natural Products.—For more than two centuries British Honduras has been supported by its trade in timber, especially in mahogany, logwood, cedar and other dye-woods and cabinet-woods, such as lignum-vitae, fustic, bullet-wood, santa-maria, ironwood, rosewood, &c. The coloured inhabitants are unsurpassed as woodmen, and averse from agriculture; so that there are only about 90 sq. m. of tilled land. Sugar-cane, bananas, cocconut-palms, plantains, and various other fruits are cultivated; vanilla, sarsaparilla, sapodilla or chewing-gum, rubber, and the cahoon or coyol palm, valuable for its oil, grow wild in large quantities. In September 1903 all the pine trees on crown lands were sold to Mr B. Chipley, a citizen of the United States, at one cent (¼d.) per tree; the object of the sale being to secure the opening up of undeveloped territory. Unsuccessful attempts have been made to establish sponge fisheries on a large scale.

Chief Towns and Communications.—Belize (pop. in 1904, 9969), the capital and principal seaport, is described in a separate article. Other towns are Stann Creek (2439), Corozal (1696), Orange Walk (1244), Punta Gorda (706), the Cayo (421), Monkey River (384) and Mullins River (243). All these are administered by local boards, whose aggregate revenue amounts to some £7000. Telegraph and telephone lines connect the capital with Corozal in the north, and Punta Gorda in the south; but there are no railways, and few good roads beyond municipal limits. Thus the principal means of communication are the steamers which ply along the coast. Mail steamers from New Orleans, Liverpool, Colon and Puerto Cortes in Honduras, regularly visit Belize.

Commerce and Finance.—Between 1901 and 1905 the tonnage of vessels accommodated at the ports of British Honduras rose from 300,000 to 496,465; the imports rose from £252,500 to £386,123; the exports from £285,500 to £377,623. The exports consist of the timber, fruit and other vegetable products already mentioned, besides rum, deer-skins, tortoiseshell, turtles and sponges, while the principal imports are cotton goods, hardware, beer, wine, spirits, groceries and specie. The sea-borne trade is mainly shared by Great Britain and the United States. On the 14th of October 1894, the American gold dollar was adopted as the standard coin, in place of the Guatemalan dollar; and the silver of North, South and Central America ceased to be legal tender. Government notes are issued to the value of 1, 2, 5, 10, 50 and 100 dollars, and there is a local currency of one cent bronze pieces, and of 5, 10, 25 and 50 cent silver pieces. The British sovereign and half-sovereign are legal tender. In 1846 the government savings bank was founded in Belize; branches were afterwards opened in the principal towns; and in 1903 the British Bank of Honduras was established at Belize. The revenue, chiefly derived from customs, rose from £60,150 in 1901 to £68,335 in 1905. The expenditure, in which the cost of police

and education are important items, rose, during the same period, from £51,210 to £61,800. The public debt, amounting in 1905 to £34,736, represents the balance due on three loans which were raised in 1885, 1887, and 1891, for public works in Belize. The loans are repayable between 1916 and 1923.

Constitution and Administration.—From 1638 to 1786 the colonists were completely independent, and elected their own magistrates, who performed all judicial and executive functions. The customs and precedents thus established were codified and published under the name of "Burnaby's Laws," after the visit of Admiral Sir W. Burnaby, in 1756, and were recognized as valid by the crown. In 1786 a superintendent was appointed by the home government, and although this office was vacant from 1790 to 1797, it was revived until 1862. An executive council was established in 1839, and a legislative assembly, of three nominated and eighteen elected members, in 1853. British Honduras was declared a colony in 1862, with a lieutenant governor, subject to the governor of Jamaica, as its chief magistrate. In 1870 the legislative assembly was abolished, and a legislative council substituted—the constitution of this body being fixed, in 1892, at three official and five unofficial members. In 1884 the lieutenant governor was created governor and commander-in-chief, and rendered independent of Jamaica. He is assisted by an executive council of three official and three unofficial members. For administrative purposes the colony is divided into six districts—Belize, Corozal, Orange Walk, the Cayo, Stann Creek and Toledo. The capital of the last named is Punta Gorda; the other districts take the names of their chief towns. English common law is valid throughout British Honduras, subject to modification by local enactments, and to the operation of the *Consolidated Laws of British Honduras*. This collection of ordinances, customs, &c., was officially revised and published between 1884 and 1888. Appeals may be carried before the privy council or the supreme court of Jamaica.

Religion and Education.—The churches represented are Roman Catholic, Anglican, Wesleyan, Baptist and Presbyterian; but none of them receives assistance from public funds. The bishopric of British Honduras is part of the West Indian province of the Church of England. Almost all the schools, secondary as well as primary, are denominational. School fees are charged, and grants-in-aid are made to elementary schools. Most of these, since 1894, have been under the control of a board, on which the religious bodies managing the schools are represented.

Defence.—The Belize volunteer light infantry corps, raised in 1897, consists of about 200 officers and men; a mounted section, numbering about 40, was created in 1904. For the whole colony, the police number about 120. There is also a volunteer fire brigade of 335 officers and men.

History.—"His Majesty's Settlement in the Bay of Honduras," as the territory was formerly styled in official documents, owes its origin, in 1638, to log-wood cutters who had formerly been buccaners. These were afterwards joined by agents of the Chartered Company which exploited the pearl fisheries of the Mosquito coast. Although thus industriously occupied, the settlers so far retained their old habits as to make frequent descents on the logwood establishments of the Spaniards, whose attempts to expel them were generally successfully resisted. The most formidable of these was made by the Spaniards in April 1754, when, in consequence of the difficulty of approaching the position from the sea, an expedition, consisting of 1500 men, was organized inland at the town of Peten. As it neared the coast, it was met by 250 British, and completely routed. The log-wood cutters were not again disturbed for a number of years, and their position had become so well established that, in the treaty of 1763 with Spain, Great Britain, while agreeing to demolish "all fortifications which English subjects had erected in the Bay of Honduras," insisted on a clause in favour of the cutters of logwood, that "they or their workmen were not to be disturbed or molested, under any pretext whatever, in their said places of cutting and loading logwood." Strengthened by the recognition of the crown, the British settlers made fresh encroachments on Spanish territory. The Spaniards, asserting that they were engaged in smuggling and other illicit practices, organized a large force, and on the 15th of September 1779, suddenly attacked and destroyed the establishment at Belize, taking the inhabitants prisoners to Mérida in Yucatan, and afterwards to Havana, where most of them died. The survivors were liberated in 1782, and allowed to go to Jamaica. In 1783 they returned with many new adventurers, and were soon engaged in cutting woods. On the 3rd of September in that year a new treaty was signed between Great Britain and Spain, in which it was expressly agreed that his Britannic Majesty's subjects should have "the right of cutting, loading, and carrying away logwood

in the district lying between the river Wallis or Belize and Rio Hondo, taking the course of these two rivers for unalterable boundaries." These concessions "were not to be considered as derogating from the rights of sovereignty of the king of Spain" over the district in question, where all the English dispersed in the Spanish territories were to concentrate themselves within eighteen months. This did not prove a satisfactory arrangement; for in 1786 a new treaty was concluded, in which the king of Spain made an additional grant of territory, embracing the area between the rivers Sibun or Jabon and Belize. But these extended limits were coupled with still more rigid restrictions. It is not to be supposed that a population composed of so lawless a set of men was remarkably exact in its observance of the treaty. They seem to have greatly annoyed their Spanish neighbours, who eagerly availed themselves of the breaking out of war between the two countries in 1796 to concert a formidable attack on Belize. They concentrated a force of 3000 men at Campeachy, which, under the command of General O'Neill, set sail in thirteen vessels for Belize, and arrived on the 10th of July, 1798. The settlers, aided by the British sloop of war "Merlin," had strongly fortified a small island in the harbour, called St George's Cay. They maintained a determined resistance against the Spanish forces, which were obliged to retire to Campeachy. This was the last attempt to dislodge the British.

The defeat of the Spanish attempt of 1798 has been adduced as an act of conquest, thereby permanently establishing British sovereignty. But those who take this view overlook the important fact that, in 1814, by a new treaty with Spain, the provisions of the earlier treaty were revived. They forget also that for many years the British government never laid claim to any rights acquired in virtue of the successful defence; for so late as 1817-1819 the acts of parliament relating to Belize always refer to it as "a settlement, for certain purposes, under the protection of His Majesty." After Central America had attained its independence (1819-1822) Great Britain secured its position by incorporating the provisions of the treaty of 1786 in a new treaty with Mexico (1826), and in the drafts of treaties with New Granada (1825) and the United States of Central America (1831). The territories between the Belize and Sarstoon rivers were claimed by the British in 1836. The subsequent peaceful progress of the country under British rule; the exception of Belize from that provision of the Clayton-Bulwer Treaty (q.v.) of 1850 which forbade Great Britain and the United States to fortify or colonize any point on the Central American mainland; and the settlement of the boundary disputes with Guatemala in 1859, finally confirmed the legal sovereignty of Great Britain over the whole colony, including the territories claimed in 1836. The Bay Islands were recognized as part of the republic of Honduras in 1859. Between 1849, when the Indians beyond the Hondo rose against their Mexican rulers, and 1901, when they were finally subjugated, rebel bands occasionally attacked the northern and north-western marches of the colony. The last serious raid was foiled in 1872.

BIBLIOGRAPHY.—For all statistical matter relating to the colony, see the annual reports to the British Colonial Office (London). For the progress of exploration, see *A Narrative of a Journey across the unexplored Portion of British Honduras*, by H. Fowler (Belize, 1873); and "An Expedition to the Cockscomb Mountains," by J. Bellamy, in *Proceedings of the Royal Geographical Society*, vol. xi. (London, 1889). A good general description is given in the *Handbook of British Honduras*, by L. W. Bristowe and P. B. Wright (Edinburgh, 1892); and the local history is recounted in the *History of British Honduras*, by A. R. Gibbs (London, 1883); in *Notes on Central America*, by E. J. Squier (New York, 1855); and in *Belize or British Honduras*, a paper read before the Society of Arts by Chief Justice Temple (London, 1847). (K. G. J.)

BRITOMARTIS ("sweet maiden"), an old Cretan goddess, later identified with Artemis. According to Callimachus (*Hymn to Diana*, 190), she was a nymph, the daughter of Zeus and Carme, and a favourite companion of Artemis. Being pursued by Minos, king of Crete, who was enamoured of her, she sprang from a rock into the sea, but was saved from drowning by falling into some fishermen's nets. She was afterwards made a goddess by Artemis under the name of Dictynna (*Metam.*, "a

net"). She was the patroness of hunters, fishermen and sailors, and also a goddess of birth and health. The centre of her worship was Cydonia, whence it extended to Sparta and Aegina (where she was known as Aphaea) and the islands of the Mediterranean. By some she is considered to have been a moon-goddess, her flight from Minoas and her leap into the sea signifying the revolution and disappearance of the moon (Pausanias ii. 30, iii. 14; Antoninus Liberalis 40).

BRITON-FERRY, a seaport in the mid-parliamentary division of Glamorganshire, Wales, on the eastern bank of the estuary of the Neath river in Swansea Bay, with stations on the Great Western and the Rhondda & Swansea Bay railways, being 174 m. by rail from London. Pop. of urban district (1901) 6973. A tram-line connects it with Neath, 2 m. distant, and the Vale of Neath Canal (made in 1797) has its terminus here. The district was formerly celebrated for its scenery, but this has been considerably marred by industrial development which received its chief impetus from the construction in 1861 of a dock of 13 acres, the property of the Great Western Railway Company, and the opening up about the same time of the mining districts of Glyncoerrwg and Maesteg by means of the South Wales mineral railway, which connects them with the dock and supplies it with its chief export, coal. Steel and tinplates are manufactured here on a large scale. There are also iron-works and a foundry.

The name La Brittonne was given by the Norman settlers of the 12th century to its ferry across the estuary of the Neath (where Archbishop Baldwin and Giraldus crossed in 1188, and which is still used), but the Welsh name of the town from at least the 16th century has been Llansawel.

BRITANNY, or **BRITANNY** (Fr. *Bretagne*), known as Armorica (q.v.) until the influx of Celts from Britain, an ancient province and duchy of France, consisting of the north-west peninsula, and nearly corresponding to the departments of Finistère, Côtes-du-Nord, Morbihan, Ille-et-Vilaine and Lower Loire. It is popularly divided into Upper or Western, and Lower or Eastern Brittany. Its greatest length between the English Channel and the Atlantic Ocean is 250 kilometres (about 155 English miles), and its superficial extent is 30,000 sq. kilometres (about 18,630 English sq. m.). It comprises two distinct zones, a maritime zone and an inland zone. In the centre there are two plateaus, partly covered with *landes*, unproductive moorland: the southern plateau is continued by the Montagnes Noires, and the northern is dominated by the Monts d'Arrée. These ranges nowhere exceed 1150 ft. in height, but from their wild nature they recall the aspect of high mountains. The waterways of Brittany are for the most part of little value owing to their torrent-like character. The only river basin of any importance is that of the Vilaine, which flows through Rennes. The coast is very much indented, especially along the English Channel, and is rocky and lined with reefs and islets. The mouths of the rivers form deep estuaries. Thus nature itself condemned Brittany to remain for a long time shut out from civilization. But in the 19th century the development of railways and other means of communication drew Brittany from its isolation. In the 19th century also agriculture developed in a remarkable manner. Many of the *landes* were cleared and converted into excellent pasturage, and on the coast market-gardening made great progress. In the fertile districts cereals too are cultivated. Industrial pursuits, except in a few seaport towns, which are rather French than Breton, have hitherto received but little attention.

The Bretons are by nature conservative. They cling with almost equal attachment to their local customs and their religious superstitions. It was not till the 17th century that paganism was even nominally abolished in some parts, and there is probably no district in Europe where the popular Christianity has assimilated more from earlier creeds. Witchcraft and the influence of fairies are still often believed in. The costume of both sexes is very peculiar both in cut and colour, but varies considerably in different districts. Bright red, violet and blue are much used, not only by the women, but in the coats and waistcoats of the men. The reader will find full illustrations of the different styles in Bouet's *Dress-ind. ou vie des Bretons de l'Armorique* (1844).

The Celtic language is still spoken in lower Brittany. Four dialects are pretty clearly marked (see the article *CELT: Language*, "*Breton*," p. 328). Nowhere has the taste for marvellous legends been kept so green as in Brittany; and an entire folk-literature still flourishes there, as is manifested by the large number of folk-tales and folk-songs which have been collected of late years.

The whole duchy was formerly divided into nine bishoprics:—Rennes, Dol, Nantes, St Malo and St Brieuc, in Upper Brittany and Tréguier, Vannes, Quimper and St Pol de Léon in Lower.

History.—Of Brittany before the coming of the Romans we have no exact knowledge. The only traces left by the primitive populations are the megalithic monuments (dolmens, menhirs and cromlechs), which remain to this day in great numbers (see *STONE MONUMENTS*). In 56 B.C. the Romans destroyed the fleet of the Veneti, and in 52 the inhabitants of Armorica took part in the great insurrection of the Gauls against Caesar, but were subdued finally by him in 51. Roman civilization was then established for several centuries in Brittany.

In the 5th century numbers of the Celtic inhabitants of Britain, flying from the Angles and Saxons, emigrated to Armorica, and populated a great part of the peninsula. Converted to Christianity, the new-comers founded monasteries which helped to clear the land, the greater part of which was barren and wild. The Celtic immigrants formed the counties of Vannes, Cornouaille, Léon and Domnonée. A powerful aristocracy was constituted, which owned estates and had them cultivated by serfs or villeins. The Celts sustained a long struggle against the Frankish kings, who only nominally occupied Brittany. Louis the Pious placed a native chief Nomenoë at the head of Brittany. There was then a fairly long period of peace; but Nomenoë rebelled against Charles the Bald, defeated him, and forced him, in 845, to recognize the independence of Brittany. The end of the 9th century and the beginning of the 10th were remarkable for the invasions of the Northmen. On several occasions they were driven back—by Salomon (d. 874) and afterwards by Alain, count of Vannes (d. 907)—but it was Alain Barbetorte (d. 952) who gained the decisive victory over them.

In the second half of the 10th century and in the 11th century the counts of Rennes were predominant in Brittany. Geoffrey, son of Conan, took the title of duke of Brittany in 992. Conan II., Geoffrey's grandson, threatened by the revolts of the nobles, was attacked also by the duke of Normandy (afterwards William I. of England). Alain Fergent, one of his successors, defeated William in 1085, and forced him to make peace. But in the following century the Plantagenets succeeded in establishing themselves in Brittany. Conan IV., defeated by the revolted Breton nobles, appealed to Henry II. of England, who, in reward for his help, forced Conan to give his daughter in marriage to his son Geoffrey. Thus Henry II. became master of Brittany, and Geoffrey was recognized as duke of Brittany. But this new dynasty was not destined to last long. Geoffrey's posthumous son, Arthur, was assassinated by John of England in 1203, and Arthur's sister Alix, who succeeded to his rights, was married in 1212 to Pierre de Dreux, who became duke. This was the beginning of a ducal dynasty of French origin, which lasted till the end of the 15th century.

From that moment the ducal power gained strength in Brittany and succeeded in curbing the feudal nobles. Under French influence civilization made notable progress. For more than a century peace reigned undisturbed in Brittany. But in 1341 the death of John III., without direct heir, provoked a war of succession between the houses of Blois and Montfort, which lasted till 1364. This war of succession was, in reality, an incident of the Hundred Years' War, the partisans of Blois and Montfort supporting respectively the kings of France and England. In 1364 John of Montfort (d. 1399) was recognized as duke of Brittany under the style of John IV.,¹ but his reign

¹ Certain authorities count the father of this duke, another John of Montfort (d. 1345), among the dukes of Brittany, and according to this enumeration the younger John becomes John V., not John IV., and his successor John VI. and not John V.

was constantly troubled, notably by his struggle with Olivier de Clisson (1336-1407). John V. (d. 1442), on the other hand, distinguished himself by his able and pacific policy. During his reign and the reigns of his successors, Francis I., Peter II. and Arthur III., the ducal authority developed in a remarkable manner. The dukes formed a standing army, and succeeded in levying hearth taxes (*foages*) throughout Brittany. Francis II. (1435-1488) fought against Louis XI., notably during the War of the Public Weal, and afterwards engaged in the struggle against Charles VIII., known as "The Mad War" (*La Guerre Folle*). After the death of Francis II. the king of France invaded Brittany, and forced Francis's daughter, Anne of Brittany, to marry him in 1491. Thus the reunion of Brittany and France was prepared. After the death of Charles VIII. Anne married Louis XII. Francis I., who married Claude, the daughter of Louis XII. and Anne, settled the definitive annexation of the duchy by the contract of 1532, by which the maintenance of the privileges and liberties of Brittany was guaranteed. Until the Revolution Brittany retained its own estates. The royal power, however, was exerted to reduce the privileges of the province as much as possible. It often met with vigorous resistance, notably in the 18th century. The struggle was particularly keen between 1760 and 1769, when E. A. de V. du Plessis Richelieu, duc d'Aiguillon, had to fight simultaneously the estates and the parliament, and had a formidable adversary in L. R. de C. de la Chalotais. But under the monarchy the only civil war in Brittany in which blood was shed was the revolt of the duc de Mercœur (d. 1602) against the crown at the time of the troubles of the League, a revolt which lasted from 1589 to 1598. Mention, however, must also be made of a serious popular revolt which broke out in 1675—"the revolt of the stamped paper."

See Bertrand d'Argentré, *Histoire de Bretagne* (Paris, 1586); Dom Lobineau, *Histoire de Bretagne* (Paris, 1702); Dom Morice, *Histoire de Bretagne* (1742-1756); T. A. Trollope, *A Summer in Brittany* (1840); A. du Chatelet, *L'Agriculture et les classes agricoles de la Bretagne* (1862); F. M. Luzel, *Légendes chrétiennes de la Basse-Bretagne* (Paris, 1881), and *Villages bretonnes* (Paris, 1879); A. Dupuy, *La Réunion de la Bretagne à la France* (Paris, 1880), and *Études sur l'administration municipale en Bretagne au XVIII^e siècle* (1891); J. Loth, *L'Émigration bretonne en Armorique du V^e au VII^e siècle* (Rennes, 1883); H. du Cleuziou, *Bretagne artistique et pittoresque* (Paris, 1886); Arthur de la Borderie, *Histoire de Bretagne* (Rennes, 1896 seq.); J. Lemoine, *La Révolte du papier timbré ou des deniers rouges en Bretagne en 1675* (1898); M. Marion, *La Bretagne et le duc d'Aiguillon* (Paris, 1898); B. Pocquet, *Le Duc d'Aiguillon et la Chalotais* (Paris, 1900-1902); Anatole le Duc, *Vieilles Histoires du pays breton* (1897), and *La Légende de la mort* (Paris, 1902); Ernest Lavisse, *Histoire de France*, vol. i. (Paris, 1903); Henri Sée, *Étude sur les classes rurales en Bretagne au moyen âge* (1896), and *Les Classes rurales en Bretagne du XVI^e siècle à la Révolution* (1906).

BRITTON, JOHN (1771-1857), English antiquary, was born on the 7th of July 1771 at Kingston-St-Michael, near Chippenham. His parents were in humble circumstances, and he was left an orphan at an early age. At sixteen he went to London and was apprenticed to a wine merchant. Prevented by ill-health from serving his full term, he found himself adrift in the world, without money or friends. In his fight with poverty he was put to strange shifts, becoming cellarman at a tavern and clerk to a lawyer, reciting and singing at a small theatre, and compiling a collection of common songs. After some slight successes as a writer, a Salisbury publisher commissioned him to compile an account of Wiltshire and, in conjunction with his friend Edward Wedlake Brayley, Britton produced *The Beauties of Wiltshire* (1801; 2 vols., a third added in 1825), the first of the series *The Beauties of England and Wales*, nine volumes of which Britton and his friend wrote. Britton was the originator of a new class of literary works. "Before his time," says Digby Wyatt, "popular topography was unknown." In 1805 Britton published the first part of his *Architectural Antiquities of Great Britain* (9 vols., 1805-1814); and this was followed by *Cathedral Antiquities of England* (14 vols., 1814-1835). In 1845 a Britton Club was formed, and a sum of £1000 was subscribed and given to Britton, who was subsequently granted a civil list pension by Disraeli, then chancellor of the exchequer. Britton was an earnest advocate of the preservation of national monuments, proposing

in 1837 the formation of a society such as the modern Society for the Preservation of Ancient Monuments. Britton himself supervised the reparation of Waltham Cross and Stratford-on-Avon church. He died in London on the 1st of January 1857.

Among other works with which Britton was associated either as author or editor are *Historical Account of Rediff Church*, Britton (1813); *Illustrations of Fonthill Abbey* (1823); *Architectural Antiquities of Normandy*, with illustrations by Pugin (1825-1827); *Picturesque Antiquities of English Cities* (1830); and *History of the Palace and Houses of Parliament at Westminster* (1834-1836), the joint work of Britton and Brayley. He contributed much to the *Gentleman's Magazine* and other periodicals.

His *Autobiography* was published in 1850. *A Descriptive Account of his Literary Works* was published by his assistant T. E. Jones.

BRITTON, the title of the earliest summary of the law of England in the French tongue, which purports to have been written by command of King Edward I. The origin and authorship of the work have been much disputed. It has been attributed to John le Breton, bishop of Hereford, on the authority of a passage found in some MSS. of the history of Matthew of Westminster; there are difficulties, however, involved in this theory inasmuch as the bishop of Hereford died in 1275, whereas allusions are made in *Britton* to several statutes passed after that time, and more particularly to the well-known statute *Quia emptores terrarum*, which was passed in 1290. It was the opinion of Selden that the book derived its title from Henry de Bracton, the last of the chief justiciaries, whose name is sometimes spelled in the fine Rolls "Bratton" and "Bretton," and that it was a royal abridgment of Bracton's great work on the custom and laws of England, with the addition of certain subsequent statutes. The arrangement, however, of the two works is different, and but a small proportion of Bracton's work is incorporated in *Britton*. The work is entitled in an early MS. of the 14th century, which was once in the possession of Selden, and is now in the Cambridge university library, *Summe de legibus Anglie que vocatur Bretonne*; and it is described as "a book called Bretoun" in the will of Andrew Horn, the learned chamberlain of the city of London, who bequeathed it to the chamber of the Guildhall in 1329, together with another book called *Miroir des Justices*.

Britton was first printed in London by Robert Redman, without a date, probably about the year 1530. Another edition of it was printed in 1640, corrected by E. Wingate. A third edition of it, with an English translation, was published at the University Press, Oxford, 1865, by F. M. Nichol. An English translation of the work without the Latin text had been previously published by R. Kitchin in 1762.

BRITZSKA, or **BRITSKA** (from the Polish *bryczka*; a diminutive of *bryka*, a goods-wagon), a form of carriage, copied in England from Austria early in the 19th century; as used in Poland and Russia it had four wheels, with a long wicker-work body constructed for reclining and a calash (hooded) top.

BRIVE, or **BRIVES-LA-GAILLARDE**, a town of south-central France, capital of an arrondissement in the département of Corrèze, 62 m. S.E.E. of Limoges on the main line of the Orleans railway from Paris to Montauban. Pop. (1906) town 12,751; commune 20,636. It lies on the left bank of the Corrèze in a ample and fertile plain, which is the meeting-place of important roads and railways. The *encintes* which formerly surrounded the town has been replaced by shady boulevards, and a few wide thoroughfares have been made, but many narrow winding streets and ancient houses still remain. Outside the boulevards lie the modern quarters, also the fine promenade planted with plane trees which stretches to the Corrèze and contains the chief restaurants and the theatre. Here also is the statue of Marshal Guillaume Marie Anne Brune, who was a native of Brive. A fine bridge leads over the river to suburbs on its right bank. The public buildings are of little interest apart from the church of St Martin, which stands in the heart of the old town. It is a building of the 12th century in the Romanesque style of Limousin, with three narrow naves of almost equal height. The ecclesiastical seminary occupies a graceful mansion of the 16th century, with a façade, a staircase and fireplaces of fine Renaissance workmanship. Brive is the seat of a sub-prefect.

and has a tribunal of first instance, a tribunal of commerce, a communal college and a school of industry. Its position makes it a market of importance, and it has a very large trade in the early vegetables and fruit of the valley of the Corréze, and in grain, live-stock and earthenware. Table-delicacies, paper, wooden shoes, hats, wax and earthenware are manufactured, and there are slate and millstone workings and dye-works.

In the vicinity are numerous rock caves, many of them having been used as dwellings in prehistoric times. The best known are those of Lamouroux, excavated in stages in a vertical wall of rock, and four grotto-chapels resorted to by pilgrims in memory of St Anthony of Padua, who founded a Franciscan monastery at Brive in 1226. Under the Romans Brive was known as *Briva Curretios* (bridge of the Corréze). In the middle ages it was the capital of lower Limousin.

BRIXEN (Ital. *Bressanone*), a small city in the Austrian province of Tirol, and the chief town of the administrative district of Brixen. Pop. (1900) 5767. It is situated in the valley of the Eisack, at the confluence of that stream with the Rienz, and is a station on the Brenner railway, being 34 m. south-east of that pass, and 24 m. north-east of Botzen. The aspect of the city is very ecclesiastical; it is still the see of a bishop, and contains an 18th-century cathedral church, an episcopal palace and seminary, twelve churches and five monasteries. The see was founded at the end of the 8th century (possibly by the 6th century) at Säben on the rocky heights above the town of Klausen (some way to the south of Brixen), but in 992 was transferred to Brixen, which, perhaps a Roman station, became later a royal estate, under the name of *Prickna*, and in 901 was given by Louis the Child to the bishop. In 1027 the bishop received from the emperor Conrad II. very extensive temporal powers, which he only lost to Austria in 1803. The town was surrounded in 1030 by walls. In 1525 it was the scene of the first outbreak of the great peasants' revolt. About 53 m. north of Brixen is the great fortress of Franzensfeste, built 1833-1838, to guard the route over the Brenner and the way to the east up the Pusterthal. (W. A. B. C.)

BRIXHAM, a seaport and market town in the Torquay parliamentary division of Devonshire, England, 33 m. S. of Exeter, on a branch of the Great Western railway. Pop. of urban district (1901) 8092. The town is irregularly built on the cliffs to the south of Torbay, and its harbour is sheltered by a breakwater. Early in the 19th century it was an important military post, with fortified barracks on Berry Head. It is the headquarters of the Devonshire sea-fisheries, having also a large coasting trade. Shipbuilding and the manufacture of ropes, paint and sails are industries. There is excellent bathing, and Brixham is in favour as a seaside resort. St Mary's, the ancient parish church, has an elaborate 14th-century font and some monuments of interest. At the British Seamen's Orphans' home boys are fed, clothed and trained as apprentices for the merchant service. A statue commemorates the landing, in 1668, of William of Orange.

Brixham Cave, called also Windmill Hill Cavern, is a well-known ossiferous cave situated near Brixham, on the brow of a hill composed of Devonian limestone. It was discovered by chance in 1858, having been until then hermetically sealed by a mass of limestone breccia. Dr Hugh Falconer with the assistance of a committee of geologists excavated it. The succession of beds in descending order is as follows:—(1) Shingle consisting of pebbles of limestone, slate and other local rocks, with fragments of stalagmite and containing a few bones and worked flints. The thickness varies from five to sixteen feet. (2) Red cave earth with angular fragments of limestone, bones and worked flints, and having a thickness of 3 to 4 ft. (3) Remnants (*in situ*) of an old stalagmitic floor about nine inches thick. (4) Black peaty soil varying in thickness, the maximum being about a foot. (5) Angular debris fallen from above varying in thickness from one to ten feet. (6) Stalagmite with a few bones and antlers of reindeer, the thickness varying from one to fifteen inches. Of particular interest is the presence of patches or ledges of an old stalagmitic floor, three to four feet above the present floor.

On the under-side, there are found attached fragments of limestone and quartz, showing that the shingle bed once extended up to it, and that it then formed the original floor. The shingle therefore stood some feet higher than it does now, and it is supposed that a shock or jar, such as that of an earthquake, broke up the stalagmite, and the pebbles and sand composing the shingle sunk deeper into the fissures in the limestone. This addition to the size of the cave was partially filled up by the cave earth. At a later period the fall of angular fragments at the entrance finally closed the cave, and it ceased to be accessible except to a few burrowing animals, whose remains are found above the second and newer stalagmite floor.

The fauna of Brixham cavern closely resembles that of Kent's Hole. The bones of the bear, horse, rhinoceros, lion, elephant, hyena and of many birds and small rodents were unearthed. Altogether 1621 bones, nearly all broken and gnawed, were found; of these 691 belonged to birds and small rodents of more recent times. The implements are of a roughly-chipped type resembling those of the Mousterian period. From these structural and palaeontological evidences, geologists suppose that the formation of the cave was carried on simultaneously with the excavation of the valley; that the small streams, flowing down the upper ramifications of the valley, entered the western opening of the cave, and traversing the fissures in the limestone, escaped by the lower openings in the chief valley; and that the rounded pebbles found in the shingle bed were carried in by these streams. It would be only at times of drought that the cave was frequented by animals, a theory which explains the small quantity of animal remains in the shingle. The implements of man are relatively more common, seventeen chipped flints having been found. As the excavation of the valley proceeded, the level of the stream was lowered and its course diverted; the cave consequently became drier and was far more frequently inhabited by predatory animals. It was now essentially an animal den, the occasional visits of man being indicated by the rare occurrence of flint-implements. Finally, the cave became a resort of bears; the remains of 354 specimens, in all stages of growth, including even sucking cubs, being discovered.

See Sir Joseph Prestwich, *Geology* (1888); Sir John Evans, *Ancient Stone Implements of Great Britain*, p. 512; Report on the Cave, *Phil. Trans.* (Royal Society, 1873).

BRITTON, a district in the south of London, England, included in the metropolitan borough of Lambeth (*q.v.*).

BRIZEUX, JULIEN AUGUSTE PÉLAGE (1803-1898), French poet, was born at Lorient (Morbihan) on the 12th of September 1803. He belonged to a family of Irish origin, long settled in Brittany, and was educated for the law, but in 1827 he produced at the Théâtre Français a one-act verse comedy, *Racine*, in collaboration with Philippe Buson. A journey to Italy in company with Auguste Barbier made a great impression on him, and a second visit (1834) resulted in 1841 in the publication of a complete translation of the *Divina Commedia in terza rima*. With *Primer di Nola* (1852) he included poems written under Italian influence, entitled *Les Ternaires* (1841), but in the rustic idyl of *Marie* (1836) turned to Breton country life; in *Les Bretons* (1845) he found his inspiration in the folklore and legends of his native province, and in *Telen-Avror* (1844) he used the Breton dialect. His *Histoires politiques* (1855) was crowned by the French Academy. His work is small in bulk, but is characterized by simplicity and sincerity. Brizeux was an ardent student of the philology and archaeology of Brittany, and had collected materials for a dictionary of Breton place-names. He died at Montpellier on the 3rd of May 1898.

His *Œuvres complètes* (2 vols., 1860) were edited with a notice of the author by Saint-René Taillandier. Another edition appeared in 1880-1884 (4 vols.). A long list of articles on his work may be consulted in an exhaustive monograph, *Brizeux; sa vie et ses œuvres* (1898), by the abbé C. Lecigne.

BRIZO, an ancient goddess worshipped in Delos. She delivered oracles in dreams to those who consulted her about fishery and seafaring. The women of Delos offered her presents consisting of little boats filled with all kinds of eatables (with the exception of

fish) in order to obtain her protection for those engaged on the sea (Athenaeus viii. p. 335).

BROACH, or **BEARUCH**, an ancient city and modern district of British India, in the northern division of Bombay. The city is on the right bank of the Nerbudda, about 30 m. from the sea, and 203 m. N. of Bombay. The area, including suburbs, occupies 2½ sq. m. Pop. (1901) 42,896. The sea-borne trade is confined to a few coasting vessels. Handloom-weaving is almost extinct, but several cotton mills have been opened. There are also large flour-mills. Broach is the Barakacheva of the Chinese traveller Hsüan Tsang and the Barygaza of Ptolemy and Arrian. Upon the conquest of Gujarat by the Mahomedans, and the formation of the state of that name, Broach formed part of the new kingdom. On its overthrow by Akbar in 1572, it was annexed to the Mogul empire and governed by a Nawab. The Mahrattas became its masters in 1685, from which period it was held in subordination to the peshwa until 1772, when it was captured by a force under General Wedderburn (brother to Lord Loughborough), who was killed in the assault. In 1783 it was ceded by the British to Sindhia in acknowledgment of certain services. It was stormed in 1803 by a detachment commanded by Colonel Woodington, and was finally ceded to the East India Company by Sindhia under the treaty of Sarji Anjangam.

The DISTRICT OF BROACH contains an area of 1467 sq. m. Consisting chiefly of the alluvial plain at the mouth of the river Nerbudda, the land is rich and highly cultivated, and though it is without forests it is not wanting in trees. The district is well supplied with rivers, having in addition to the Nerbudda the Mahi in the north and the Kim in the south. The population comprises several distinct races or castes, who, while speaking a common dialect, Gujarati, inhabit separate villages. Thus there are Koli, Kumbi or Voro (Bora) villages, and others whose lands are almost entirely held and cultivated by high castes, such as Rajputs, Brahmins or Parsees. In 1901 the population was 291,763, showing a decrease of 15%, compared with an increase of 5% in the preceding decade. The principal crops are cotton, millet, wheat and pulse. Dealing in cotton is the chief industry, the dealers being organized in a guild. Besides the cotton mills in Broach city there are several factories for ginning and pressing cotton, some of them on a very large scale. The district is traversed throughout its length by the Bombay & Baroda railway, which crosses the Nerbudda opposite Broach city on an iron-girder bridge of 67 spans. The district suffered severely from the famine of 1899-1900.

BROACH (Fr. *broche*, a pointed instrument, Med. Lat. *brocca*, cf. the Latin adjective *brochus* or *broccus*, projecting, used of teeth), a word, of which the doublet "brooch" (*g.s.*) has a special meaning, for many forms of pointed instruments, such as a bodkin, a wooden needle used in tapestry-making, a spit for roasting meat, and a tool, also called a "rimer," used with a wrench for enlarging or smoothing holes (see TOOL). From the use of a similar instrument to tap casks, comes "to broach" or "tap" a cask. A particular use in architecture is that of "broach-spire," a term employed to designate a particular form of spire, found only in England, which takes its name from the stone roof of the lower portion. The stone spire being octagonal and the tower square on plan, there remained four angles to be covered over. This was done with a stone roof of slight pitch, compared with that of the spire, and it is the intersection of this roof with the octagonal faces of the spire which forms the broach.

BROADSIDE, sometimes termed **BROADSHEET**, a single sheet of paper containing printed matter on one side only. The broadside seems to have been employed from the very beginning of printing for royal proclamations, papal indulgences and similar documents. England appears to have been its chief home, where it was used chiefly for ballads, particularly in the 16th century, but also as a means of political agitation and for personal statements of all kinds, especially for the dissemination of the dying speeches and confessions of criminals. It is prominent in the history of literature because, particularly during the later part of the 17th century, several important poems, by Dryden,

Butler and others, originally appeared printed on the "broadside" of a sheet. The term is also used of the simultaneous discharge of the guns on one side of a ship of war.

BROADSTAIRS, a watering-place in the Isle of Thanet parliamentary division of Kent, England, 3 m. S.E. of Margate, on the South-Eastern & Chatham railway. Pop. of urban district, Broadstairs and St Peter's (1901) 6466. From 1837 to 1851 Broadstairs was a favourite summer resort of Charles Dickens, who, in a sketch called "Our English Watering-Place," described it as a place "left high and dry by the tide of years." This seaside village, with its "semicircular sweep of houses," grew into a considerable town owing to the influx of summer visitors, for whose entertainment there are, besides the "Albion" mentioned by Dickens, numerous hotels and boarding-houses, libraries, a bathing establishment and a fine promenade. Dickens' residence was called Fort House, but it became known as Bleak House, through association with his novel of that name, though this was written after his last visit to Broadstairs in 1851. Broadstairs has a small pier for fishing-boats, first built in the reign of Henry VIII. An archway leading down to the shore bears an inscription showing that it was erected by George Culmer in 1540, and not far off is the site of a chapel of the Virgin, to which ships were accustomed to lower their top-sails as they passed. St Peter's parish, lying on the landward side of Broadstairs, and included in the urban district, has a church dating from the 12th to the end of the 16th century. Kingsgate, on the North Foreland, north of Broadstairs on the coast, changed its name from St Bartholomew's Gate in honour of Charles II.'s landing here with the duke of York in 1683 on his way from London to Dover. Stonehouse, close by, now a preparatory school for boys, was the residence of Archbishop Tait, whose wife established the orphanage here.

BROCA, PAUL (1824-1880), French surgeon and anthropologist, was born at Sainte-Foy la Grande, Gironde, on the 28th of June 1824. He early developed a taste for higher mathematics, but circumstances decided him in adopting medicine as his profession. Beginning his studies at Paris in 1841, he made rapid progress, becoming house-surgeon in 1844, assistant anatomical lecturer in 1846, and three years later professor of surgical anatomy. He had already gained a reputation by his pathological researches. In 1853 he was named fellow of the Faculty of Medicine, and in 1867 became member of the Academy of Medicine and professor of surgical pathology to the Faculty. During the years occupied in winning his way to the head of his profession he had published treatises of much value on cancer, aneurism and other subjects. It was in 1861 that he announced his discovery of the seat of articulate speech in the left side of the frontal region of the brain, since known as the convolution of Broca. But famous as he was as a surgeon, his name is associated most closely with the modern school of anthropology. Establishing the Anthropological Society of Paris in 1859, of which he was secretary till his death, he was practically the inventor of the modern science of craniology. He rendered distinguished service in the Franco-German War and during the Commune by his organization and administration of the public hospitals. He founded *La Revue d'Anthropologie* in 1872, and it was in its pages that the larger portion of his writings appeared. In his last years Broca turned from his labours in the region of craniology to the exclusive study of the brain, in which his greatest triumphs were achieved (see APHASIA). He was decorated with the Legion of Honour in 1868, and was honorary fellow of the leading anatomical, biological and anthropological societies of the world. He died on the 9th of July 1880. A statue of him by Cheppa was erected in 1887 in front of the Faculty of Medicine in Paris.

BROCADE, the name usually given to a class of richly decorative shuttle-woven fabrics, often made in coloured silks and with or without gold and silver threads. Ornamental features in brocade are emphasized and wrought as additions to the main fabric, sometimes stiffening it, though more frequently producing on its face the effect of low relief. These additions present a distinctive appearance on the back of the stuff, where

the weft or floating threads of the brocaded or broached parts hang in loose groups or are clipped away.

The Latin word *broccus* is related equally to the Italian

kincobs, with Lyons silks that are *brochets* with threads of gold, silk or other material. Notwithstanding this, many Indian kincobs and dainty gold and coloured silk-weavings of Persian workmanship, both without floating threads, are often called

brocades, although in neither is the ornamentation really *broché* or brocaded. Contemporary in use with the Spanish *brocats* is the word *brocado*. In addition to *brocarts* the French now use the word *brocher* in connexion with certain silk stuffs which however are not brocades in the same sense as the *brocarts*. A wardrobe account of King Edward IV. (1480) has an entry of "satyn broched with gold"—a description that fairly applies to such an enriched satin as that for instance shown in fig. 4. But some three centuries earlier than the date of that specimen, decorative stuffs were partly *brochets* with gold threads by oriental weavers, especially those of Persia, Syria and parts of southern Europe and northern Africa under the domination of the Saracens, to whom the earlier germs, so to speak, of brocading may be traced. Of such is the 11th or 12th century Siculo-Saracenic specimen in fig. 1, in which the heads only of the pairs of animals and birds are broched with gold thread. Another sort of brocaded material is indicated in fig. 2, taken from a part of a sumptuous Siculo-Saracenic weaving produced in coloured silks and gold threads at the famous Hotel des Tiraz in Palermo for an official robe of Henry IV. (1165-1197) as emperor of the Holy Roman Empire, and still preserved in the cathedral of Regensburg. Fig. 3 is a further variety of textile that would be classed as *brocat*. This is of the 12th or 13th century manufacture, possibly by German or Rhenish-Byzantine weavers, or even by Spanish weavers, many of whom at Almeria, Malaga, Grenada and Seville rivalled those at Palermo. In the 14th century the making of satins heavily brocaded with gold threads was associated conspicuously with such Italian towns as Lucca, Genoa, Venice and Florence. Fig. 4 is from a piece of 14th-century dark-blue satin broached in relief with gold thread in a design the like of which appears in the background of Orcagna's "Coronation of the Virgin," now in the National Gallery, London. During the 17th century Genoa, Florence and Lyons vied with each other in making brocades in which the enrichments were as frequently of coloured silks as of gold intermixed with silken threads. Fig. 5 is from a piece of crimson silk *damaak* flatly brocaded with flowers, scroll forms, fruit and birds in gold. This is probably of Florentine workmanship. Rather more closely allied to modern brocades is the Lyons specimen given in fig. 6, in which the brocading is done not only with silver but also with coloured silks. Early in the 18th century Spitalfields was



FIG. 3.—Piece of stuff woven or brocaded with red silk and gold thread, with an oval framing enclosing alternately, pairs of parrots, *adoros*, *regardas*, and a well-known Persian (or Sassanian) leaf-shaped fruit device. Probably of Rhenish-Byzantine manufacture in the 12th or 13th century. 9 in. long.



FIG. 1.—Brocade woven in red and olive green silks and gold thread on a cream-coloured ground. Along the top is the Kufic inscription "Arrahmân" (The Merciful) several times repeated in olive green on a gold-thread ground. Pairs of seated animals, *adoros* and *regardas* and geese *vis-à-vis* are worked within the lozenge-shaped compartments of the trellis framework which regulates the pattern. Both animals and birds are separated by conventional trees, and the latter are enclosed in inscriptions of Kufic characters. Siculo-Saracenic; 11th or 12th century. 5½ in. sq.

brocato, the Spanish *brocar* and the French *brocarts* and *brocher*, and implies a form of stitching or broaching, so that textile fabrics woven with an appearance of stitching or broaching have consequently come to be termed "brocades." A Spanish docu-

ment dated 1375 distinguishes between *los draps d'or & d'argent o de seda* and *brocats d'or & d'argent*, a difference which is readily perceived, upon comparing for instance cloths of gold, Indian

busy as a competitor with Lyons in manufacturing many sorts of brocades, specified in a collection of designs preserved in the national art library of the Victoria and



FIG. 2.—Part of a Siculo-Saracenic brocade woven in the 12th century. 16½ in. wide.

ment dated 1375 distinguishes between *los draps d'or & d'argent o de seda* and *brocats d'or & d'argent*, a difference which is readily perceived, upon comparing for instance cloths of gold, Indian

Albert Museum, under such trade titles as "brocade lut-string, brocade tabby, brocade tissue, brocade damask, brocade

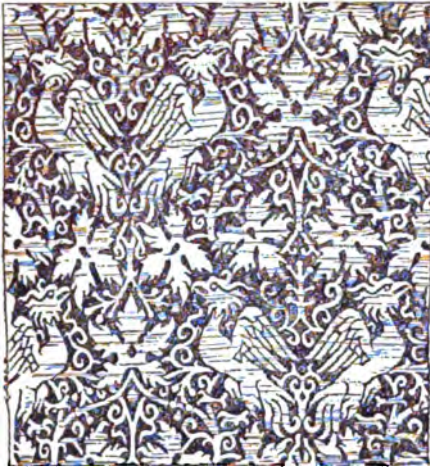

FIG. 4.—Piece of blue satin brocaded with gold threads. The unit of the pattern is a symmetrical arrangement of fantastic birds, vine leaves and curving stems. The bird shapes are remotely related to, if not derived from, the Chinese mystical "fonghoang." North Italian weaving of the 14th century; about 11 in. square.

satin, Venetian brocade, and India figured brocade." Brocading in China seems to be of considerable antiquity, and Dr Bushell in his valuable handbook on Chinese art cites a notice of five



FIG. 5.—Piece of crimson silk damask brocaded in gold thread with symmetrical arranged flowers, scrolls, birds, &c. Italian (?Florentine). Late 17th century; about 2 ft. 6 in. long.

rolls of brocade with dragons woven upon a crimson ground, presented by the emperor Ming Ti of the Wei dynasty, in the

year A.D. 238, to the reigning empress of Japan; and varieties of brocade patterns are recorded as being in use during the Sung dynasty (960-1279). The first edition of an illustrated work upon tillage and weaving was published in China in 1210, and contains an engraving of a loom constructed to weave flowered-silk brocades such as are woven at the present time at Suchow and Hangchow and elsewhere. On the other hand, although they are described usually as brocades, certain specimens of imperial Chinese robes sumptuous in ornament, sheen of coloured silks and the glisten of golden threads, are woven in the tapestry-weaving manner and without any floating threads. It seems reasonable to infer that Persians and Syrians derived the art of

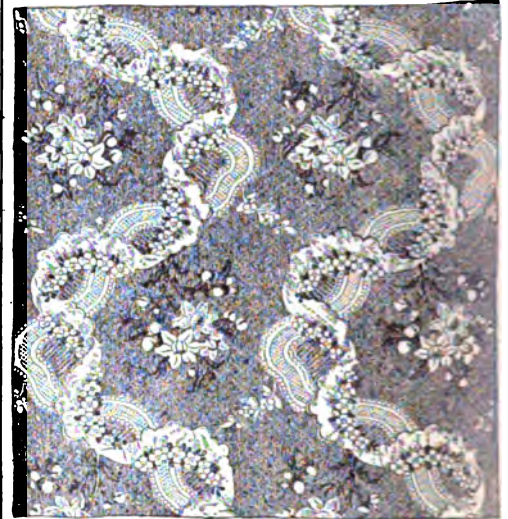

FIG. 6.—Piece of pink silk brocaded in silver and white and coloured silks. French middle 18th century; about 15 in. square.

weaving brocades from the Chinese, and as has been indicated, passed it on to Saracens as well as Europeans. (A. S. C.)

BROCCHI, GIOVANNI BATTISTA (1772-1826), Italian mineralogist and geologist, was born at Bassano on the 18th of February 1772. He studied at the university of Pisa, where his attention was turned to mineralogy and botany. In 1802 he was appointed professor of botany in the new lyceum of Brescia; but he more especially devoted himself to geological researches in the adjacent districts. The fruits of these labours appeared in different publications, particularly in his *Trattato mineralogico e chimico sulle miniere di ferro del dipartimento del Mella* (1808)—treatise on the iron mines of Mella. These researches procured him the office of inspector of mines in the recently established kingdom of Italy, and enabled him to extend his investigations over great part of the country. In 1811 he produced a valuable essay entitled *Memoria mineralogica sulla Valle di Fassa in Tirolo*; but his most important work is the *Conchiologia fossile subapennina con osservazioni geologiche sugli Apennini, e sul suolo adiacente* (2 vols., 4to, Milan, 1814), containing accurate details of the structure of the Apennine range, and an account of the fossils of the Italian Tertiary strata compared with existing species. These subjects were further illustrated by his geognostic map, and his *Catalogo ragionato di una raccolta di rocce, disposto per ordine geografico, per servire alla geognosia dell'Italia* (Milan, 1817). His work *Dello stato fisico del suolo di Roma* (1820), with its accompanying map, is likewise noteworthy. In it he corrected the erroneous views of Breislak, who conceived that Rome occupies the site of a volcano, to which he ascribed the volcanic materials that cover the seven hills. Brocchi pointed out that these materials were derived either from Mont Albano,

an extinct volcano, 12 m. from the city, or from Mont Cimini, still farther to the north. Several papers by him, on mineralogical subjects, appeared in the *Biblioteca Italiana* from 1816 to 1833. In the latter year Brocchi sailed for Egypt, in order to explore the geology of that country and report on its mineral resources. Every facility was granted by Mehemet Ali, who in 1825 appointed him one of a commission to examine the district of Sennaar; but Brocchi, unfortunately for science, fell a victim to the climate, and died at Khartum on the 25th of September 1826.

BROCHANT DE VILLIERS, ANDRÉ JEAN FRANÇOIS MARIE (1772-1840), French mineralogist and geologist, was born at Villiers, near Nantes, on the 6th of August 1772. After studying at the École Polytechnique, he was in 1794 the first pupil admitted to the Ecole des Mines. In 1804 he was appointed professor of geology and mineralogy in the École des Mines, which had been temporarily transferred to Pezay in Savoy, and he returned with the school to Paris in 1815. Later on he became inspector general of mines and a member of the Academy of Sciences. He investigated the transition strata of the Tarantaise, wrote on the position of the granite rocks of Mont Blanc, and on the lead minerals of Derbyshire and Cumberland. He was charged with the superintendence of the construction of the geological map of France, undertaken by his pupils Dufrenoy and Elie de Beaumont. He died in Paris on the 16th of May 1840. His publications include *Traité élémentaire de minéralogie* (2 vols., 1801-1802; 2nd ed., 1808), and *Traité abrégé de cristallographie* (Paris, 1818).

BROCHANTITE, a mineral species consisting of a basic copper sulphate $\text{Cu}_2(\text{OH})_2\text{SO}_4$, crystallizing in the orthorhombic system. The crystals are usually small and are prismatic or acicular in habit; they have a perfect cleavage parallel to the face lettered *a* in the adjoining figure. They are transparent to translucent, with a vitreous lustre, and are of an emerald-green to blackish-green colour. Specific gravity 3.907; hardness 3½-4. The mineral was first found associated with malachite and native copper in the copper mines of the Urals, and was named by A. Lévy in 1824 after A. J. M. Brochant de Villiers. Several varieties, differing somewhat in crystalline form, have been distinguished, some of them having originally been described as distinct species, but afterwards proved to be essentially identical with brochantite; these are königine from the Urals, bronziarinite from Mexico, krisuvigite from Iceland, and warringtonite from Cornwall. Of other localities, mention may be made of Roughen Gill, Caldbeck Fells, Cumberland, where small brilliant crystals are associated with malachite and chrysocolla in a quartzose rock; Rézbánya in the Bihar Mountains, Hungary; Atacama in Chile, with atacamite, which closely resembles brochantite in general appearance; the Tintic district in Utah. A microscopical examination of the green copper ores of secondary origin in the Clifton and Morenci district of Arizona proves brochantite to be of extremely common occurrence mostly intergrown with malachite which effectually masks its presence: it is not unlikely that the malachite of other localities will on examination be found to be intergrown with brochantite.

Mention may be here made of another orthorhombic basic copper sulphate not unlike brochantite in general characters, but differing from it in containing water of crystallization and in its fine blue colour; this is the Cornish mineral langite, which has the composition $\text{CuSO}_4 \cdot 3\text{Cu}(\text{OH})_2 + \text{H}_2\text{O}$. (L. J. S.)

BROCK, SIR ISAAC (1769-1812), British soldier and administrator, was born at St Peter Port, Guernsey, on the 6th of October 1769. Joining the army at the age of fifteen as an ensign of the 8th regiment, he became a lieutenant-colonel in 1797, after less than thirteen years' service. He commanded the 49th regiment in the expedition to North Holland in 1799,

was wounded at the battle of Egmont-op-Zee, and subsequently served on board the British fleet at the battle of Copenhagen. From 1802 to 1805 he was with his regiment in Canada, returning thither in 1806 in view of the imminence of war between Great Britain and the United States. From September 1806 till August 1810 he was in charge of the garrison at Quebec; in the latter year he assumed the command of the troops in Upper Canada, and soon afterwards took over the civil administration of that province as provisional lieutenant-governor. On the outbreak of the war of 1812 Brock had to defend Upper Canada against invasion by the United States. In the face of many difficulties and not a little disaffection, he organized the militia of the province, drove back the invaders, and on the 16th of August 1812, with about 730 men and 600 Indians commanded by their chief Tecumseh, compelled the American force of 2500 men under General William Hull (1753-1825) to surrender at Detroit, an achievement which gained him a knighthood of the Bath and the popular title of "the hero of Upper Canada." From Detroit he hurried to the Niagara frontier, but on the 13th of October in the same year was killed at the battle of Queenston Heights. The House of Commons voted a public monument to his memory, which was erected in Saint Paul's cathedral, London. On the 13th of October 1824, the twelfth anniversary of his death, his remains were removed from the bastions of Fort George, where they had been originally interred, and placed beneath a monument on Queenston Heights, erected by the provincial legislature. This was blown up by a fanatic in 1840, but as the result of a mass-meeting of over 8000 citizens held on the spot, a new and more stately monument was erected.

His *Life and Correspondence* by his nephew, Ferdinand Brock Tupper (2nd edition, London, 1847), still remains the best; later lives are by D. R. Read (Toronto, 1894), and by Lady Edgar (Toronto and London, 1905). (W. L. G.)

BROCK, THOMAS (1847-), English sculptor, was the chief pupil of Foley, and later became influenced by the new romantic movement. His group "The Moment of Peril" was followed by "The Genius of Poetry," "Eve," and other ideal works that mark his development. His busts, such as those of Lord Leighton and Queen Victoria; his statues, such as "Sir Richard Owen" and "Dr Philpott, bishop of Worcester"; his sepulchral monuments, such as that to Lord Leighton in St Paul's cathedral, a work of singular significance, refinement and beauty; and his memorial statues of Queen Victoria, at Hove and elsewhere, are examples of his power as a portraitist, sympathetic in feeling, sound and restrained in execution, and dignified and decorative in arrangement. The colossal equestrian statue of "Edward the Black Prince" was set up in the City Square in Leeds in 1901, the year in which the sculptor was awarded the commission to execute the vast Imperial Memorial to Queen Victoria in front of Buckingham Palace. Brock was elected an associate of the Royal Academy in 1883 and full member in 1891.

BROCKEN, a mountain of Germany, in Prussian Saxony, the highest point (3733 ft.) of the Harz. It is a huge, bare, granite-strewn, dome-shaped mass and, owing to its being the greatest elevation in north Germany, commands magnificent views in all directions. From it Magdeburg and the Elbe, the towers of Leipzig and the Thuringian forest are distinctly visible in clear weather. Access to the summit is attained by a mountain railway (12 m.) from Dreiannen-Hohne, a station on the normal gauge line Wernigerode-Nordhausen, and by two carriage roads from the Bodetal and Ilsenburg respectively. In the folklore of north Germany the Brocken holds an important place, and to it cling many legends. Long after Christianity had penetrated to these regions, the Brocken remained a place of heathen worship. Annually, on Walpurgis night (1st of May), curious rites were here enacted, which, condemned by the priests of the Christian church, led to the belief that the devil and witches here held their orgies. Even to this day, this superstition possesses the minds of many country people around, who believe the mountain to be haunted on this night. In literature

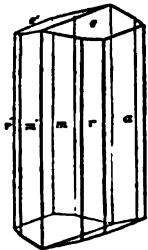

it is represented by the famous "Brocken scene" in Goethe's *Faust*.

See Jacobs, *Der Brocken in Geschichte und Sage* (Halle, 1878); and Pröhle, *Brockenlagen* (Magdeburg, 1888).

BROCKEN, SPECTRE OF THE (so named from having been first observed in 1780 on the Brocken), an enormously magnified shadow of an observer cast upon a bank of cloud when the sun is low in high mountain regions, reproducing every motion of the observer in the form of a gigantic but misty image of himself.

BROCKES, BARTHOLD HEINRICH (1680-1747), German poet, was born at Hamburg on the 22nd of September 1680. He studied jurisprudence at Halle, and after extensive travels in Italy, France and Holland, settled in his native town in 1704. In 1720 he was appointed a member of the Hamburg senate, and entrusted with several important offices. Six years (from 1735 to 1741) he spent as *Amtmann* (magistrate) at Ritzebüttel. He died in Hamburg on the 16th of January 1747. Brockes' poetic works were published in a series of nine volumes under the fantastic title *Irisches Vergnügen in Gott* (1721-1748); he also translated Marini's *La Strage degli innocenti* (1715), Pope's *Essay on Man* (1740) and Thomson's *Seasons* (1745). His poetry has small intrinsic value, but it is symptomatic of the change which came over German literature at the beginning of the 18th century. He was one of the first German poets to substitute for the bombastic imitations of Marini, to which he himself had begun by contributing, a clear and simple diction. He was also a pioneer in directing the attention of his countrymen to the new poetry of nature which originated in England. His verses, artificial and crude as they often are, express a reverential attitude towards nature and a religious interpretation of natural phenomena which was new to German poetry and prepared the way for Klopstock.

Brockes' autobiography was published by J. M. Lappenberg in the *Zeitschrift des Vereins für Hamburger Geschichte*, ii. pp. 167 ff. (1847). See also A. Brandl, *B. H. Brockes* (1878), and D. F. Strauss, *Brockes und H. S. Reimarus* (*Gesammelte Schriften*, ii.). A short selection of his poetry will be found in vol. 39 (1883) of *Kürschner's Deutsche National-Literatur*.

BROCKHAUS, FRIEDRICH ARNOLD (1772-1823), German publisher, was born at Dortmund, on the 4th of May 1772. He was educated at the gymnasium of his native place, and from 1788 to 1793 served an apprenticeship in a mercantile house at Düsseldorf. He then devoted two years at Leipzig to the study of modern languages and literature, after which he set up at Dortmund an emporium for English goods. In 1801 he transferred this business to Arnheim, and in the following year to Amsterdam. In 1805, having given up his first line of trade, he began business as a publisher. Two journals projected by him were not allowed by the government to survive for any length of time, and in 1810 the complications in the affairs of Holland induced him to return homewards. In 1811 he settled at Altenburg. About three years previously he had purchased the copyright of the *Konversations-Lexikon*, started in 1796, and in 1810-1811 he completed the first edition of this celebrated work (14th ed. 1901-4). A second edition under his own editorship was begun in 1812, and was received with universal favour. His business extended rapidly, and in 1818 Brockhaus removed to Leipzig, where he established a large printing-house. Among the more extensive of his many literary undertakings were the critical periodicals—*Hermes*, the *Literarisches Konversationsblatt* (afterwards the *Blätter für literarische Unterhaltung*), and the *Zeitgenossen*, and some large historical and bibliographical works, such as Raumer's *Geschichte der Hohenstaufen*, and Ebert's *Allgemeines bibliographisches Lexikon*. F. A. Brockhaus died at Leipzig on the 20th of August 1823. The business was carried on by his sons, Friedrich Brockhaus (1800-1865) who retired in 1850, and Heinrich Brockhaus (1804-1874), under whom it was considerably extended. The latter especially rendered great services to literature and science, which the university of Jena recognized by making him, in 1858, honorary doctor of philosophy. In the years 1842-1848, Heinrich Brockhaus was member of the Saxon second chamber, as repre-

sentative for Leipzig, was made honorary citizen of that city in 1872, and died there on the 15th of November 1874.

See H. E. Brockhaus, *Friedrich A. Brockhaus, sein Leben und Wirken nach Briefen und andern Aufzeichnungen* (3 vols., Leipzig, 1872-1881); also by the same author, *Die Firma F. A. Brockhaus von der Begründung bis zum hundertjährigen Jubiläum* (1805-1905, Leipzig, 1905).

Another of Friedrich's sons, **HERMANN BROCKHAUS** (1806-1877), German Orientalist, was born at Amsterdam on the 23rd of January 1806. While his two brothers carried on the business he devoted himself to an academic career. He was appointed extraordinary professor in Jena in 1838, and in 1841 received a call in a similar capacity to Leipzig, where in 1848 he was made ordinary professor of ancient Semitic. He died at Leipzig on the 5th of January 1877. Brockhaus was an Oriental scholar in the old sense of the word, devoting his attention, not to one language only, but to acquiring a familiarity with the principal languages and literature of the East. He studied Hebrew, Arabic and Persian, and was able to lecture on Sanskrit, afterwards his speciality, Pali, Zend and even on Chinese. His most important work was the *editio princeps* of the *Kathā-sarī-sūtra*, "The Ocean of the Streams of Story," the large collection of Sanskrit stories made by Soma Deva in the 12th century. By this publication he gave the first impetus to a really scientific study of the origin and spreading of popular tales, and enabled Prof. Benfey and others to trace the great bulk of Eastern and Western stories to an Indian, and more especially to a Buddhist source. Among Prof. Brockhaus's other publications were his edition of the curious philosophical play *Prabodha-chandrodaya*, "The Rise of the Moon of Intelligence," his critical edition of the "Songs of Hafiz," and his publication in Latin letters of the text of the "Zend-Avesta."

BROCKLEBY, RICHARD (1722-1797), English physician, was born at Minehead, Somersetshire, on the 11th of August 1722. He was educated at Ballitore, in Ireland, where Edmund Burke was one of his schoolfellows, studied medicine at Edinburgh, and finally graduated at Leiden in 1745. Appointed physician to the army in 1758, he served in Germany during part of the Seven Years' War, and on his return settled down to practise in London. In 1764 he published *Economical and Medical Observations*, which contained suggestions for improving the hygiene of army hospitals. In his latter years he withdrew altogether into private life. The circle of his friends included some of the most distinguished literary men of the age. He was warmly attached to Dr Johnson, to whom about 1784 he offered an annuity of £100 for life, and whom he attended on his death-bed, while in 1788 he presented Burke, of whom he was an intimate friend, with £1000, and offered to repeat the gift "every year until your merit is rewarded as it ought to be at court." He died on the 11th of December 1797, leaving his house and part of his fortune to his grand-nephew, Dr Thomas Young.

BROCKTON, a city of Plymouth county, Massachusetts, U.S.A., about 20 m. S. of Boston, and containing an area of 21 sq. m. of rolling surface. Pop. (1870) 8007; (1880) 13,662; (1890) 27,294; (1900) 40,063, of whom 9484 were foreign-born, including 2667 Irish, 2199 English Canadians and 1973 Swedes; (1910, census) 56,878. It is served by the New York, New Haven & Hartford railway. Brockton has a public library, with 54,000 volumes, in 1908. By popular vote, beginning in 1893 (except in 1898), the liquor traffic was prohibited annually. The death-rate, 13.18 in 1907, is very low for a manufacturing city of its size. Brockton is the industrial centre of a large population surrounding it (East and West Bridgewater, North Easton, Avon, Randolph, Holbrook and Whitman), and is an important manufacturing place. Both in 1900 and in 1905 it ranked first among the cities of the United States in the manufacture of boots and shoes. The city's total factory product in 1900 was valued at \$24,855,362, and in 1905 at \$37,790,081, an increase during the five years of 52%. The boot and shoe product in 1905 was valued at \$30,073,014 (9.4% of the value of the total boot and shoe product of the United States), the boot

and shoe cut stock at \$1,344,977, and the boot and shoe findings at \$2,435,137—the three combined representing 89.6% of the city's total manufactured product. In 1908 there were 35 shoe factories, including the W. L. Douglas, the Ralston, the Walkover, the Eaton, the Keith and the Packard establishments, and, in 1905, 14,000,000 (in 1907 about 17,000,000) pairs of shoes were produced in the city. Among the other products are lasts, blacking, paper and wooden packing boxes, nails and spikes, and shoe fittings and tools. The assessed valuation of the city rose from \$6,876,427 in 1881 to \$37,408,332 in 1907. Brockton was a part of Bridgewater until 1821, when it was incorporated as the township of North Bridgewater. Its present name was adopted in 1874, and it was chartered as a city in 1881. Brockton was the first city in Massachusetts to abolish all grade crossings (1806) within its limits.

BROCKVILLE, a town and port of entry of Ontario, Canada, and capital of Leeds county, named after General Sir Isaac Brock, situated 119 m. S. W. of Montreal, on the left bank of the St. Lawrence, and on the Grand Trunk, and Brockville & Westport railways. A branch line connects it with the Canadian Pacific. It has steamer communication with the St. Lawrence and Lake Ontario ports, and is a summer resort. The principal manufactures are hardware, furnaces, agricultural implements, carriages and chemicals. It is the centre of one of the chief dairy districts of Canada, and ships large quantities of cheese and butter. Pop. (1881) 7609; (1901) 8940.

BROD, a town of Croatia-Slavonia, in the county of Požega, on the left bank of the river Save, 124 m. by rail S. E. by E. of Agram. Pop. (1900) 7310. The principal Bosnian railway here crosses the river, to meet the Hungarian system. Brod has thus a considerable transit trade, especially in cereals, wine, spirits, prunes and wood. It is sometimes called Slavonisch-Brod, to distinguish it from Bosna-Brod, or Bosnisch-Brod, across the river. The town owes its name to a ford (Servian *brod*) of the Save, and dates at least from the 15th century. Brod was frequently captured and recaptured in the wars between Turkey and Austria; and it was here that the Austrian army mustered, in 1879, for the occupation of Bosnia.

BRODERIP, WILLIAM JOHN (1789–1859), English naturalist, was born in Bristol on the 21st of November 1789. After graduating at Oxford he was called to the bar in 1817, and for some years was engaged in law-reporting. In 1822 he was appointed a metropolitan police magistrate, and filled that office until 1856, first at the Thames police court and then at Westminster. His leisure was devoted to natural history, and his writings did much to further the study of zoology in England. The zoological articles in the *Penny Cyclopaedia* were written by him, and a series of articles contributed to *Fraser's Magazine* were reprinted in 1848 as *Zoological Recreations*, and were followed in 1852 by *Leaves from the Note-book of a Naturalist*. He was one of the founders of the Zoological Society of London, and a large collection of shells which he formed was ultimately bought by the British Museum. He died in London on the 27th of February 1859.

BRODHEAD, JOHN ROMEYN (1814–1873), American historical scholar, was born in Philadelphia, Pennsylvania, on the 2nd of January 1814, the son of Jacob Brodhead (1782–1855), a prominent clergyman of the Dutch Reformed Church. He graduated at Rutgers College in 1831, and in 1835 was admitted to the bar in New York City. After 1837, however, he devoted himself principally to the study of American colonial history, and in order to have access to the records of the early Dutch settlements in America he obtained in 1839 an appointment as attaché of the American legation at the Hague. His investigations here soon proved that the Dutch archives were rich in material on the early history of New York, and led the state legislature to appropriate funds for the systematic gathering from various European archives of transcripts of documents relating to New York. Brodhead was appointed (1841) by Governor William H. Seward to undertake the work, and within several years gathered from England, France and Holland some eighty manuscript volumes of transcriptions, largely of

documents which had not hitherto been used by historians. These transcriptions were subsequently edited by Edward O'Callaghan (vols. i.-xi., incl.) and by Berthold Fernow (vols. xii.-xv., incl.), and published by the state under the title *Documents relating to the Colonial History of New York* (15 vols., 1853–1883). From 1846 to 1849, while George Bancroft was minister to Great Britain, Brodhead held under him the post of secretary of legation. In 1853–1857 he was naval officer of the port of New York. He published several addresses and a scholarly *History of the State of New York* (2 vols., 1853–1871), generally considered the best for the brief period covered (1609–1690). He died in New York City on the 6th of May 1873.

BRODIE, SIR BENJAMIN COLLINS, 1st Bart. (1783–1862), English physiologist and surgeon, was born in 1783 at Winter-slow, Wiltshire. He received his early education from his father; then choosing medicine as his profession he went to London in 1801, and attended the lectures of John Abernethy. Two years later he became a pupil of Sir Everard Home at St George's hospital, and in 1808 was appointed assistant surgeon at that institution, on the staff of which he served for over thirty years. In 1810 he was elected a fellow of the Royal Society, to which in the next four or five years he contributed several papers describing original investigations in physiology. At this period also he rapidly obtained a large and lucrative practice, and from time to time he wrote on surgical questions, contributing numerous papers to the Medical and Chirurgical Society, and to the medical journals. Probably his most important work is that entitled *Pathological and Surgical Observations on the Diseases of the Joints*, in which he attempts to trace the beginnings of disease in the different tissues that form a joint, and to give an exact value to the symptom of pain as evidence of organic disease. This volume led to the adoption by surgeons of measures of a conservative nature in the treatment of diseases of the joints, with consequent reduction in the number of amputations and the saving of many limbs and lives. He also wrote on diseases of the urinary organs, and on local nervous affections of a surgical character. In 1854 he published anonymously a volume of *Psychological Inquiries*; to a second volume which appeared in 1862 his name was attached. He received many honours during his career. He attended George IV., was sergeant-surgeon to William IV. and Queen Victoria, and was made a baronet in 1834. He became a corresponding member of the French Institute in 1844, D.C.L. of Oxford in 1855, and president of the Royal Society in 1858, and he was the first president of the general medical council. He died at Broome Park, Surrey, on the 21st of October 1862. His collected works, with autobiography, were published in 1865 under the editorship of Charles Hawkins.

His eldest son, Sir Benjamin Collins Brodie, 2nd Bart. (1817–1880), was appointed professor of chemistry at Oxford in 1865, and is chiefly known for his investigations on the allotropic states of carbon and for his discovery of graphitic acid.

BRODIE, PETER BELLINGER (1815–1897), English geologist, son of P. B. Brodie, barrister, and nephew of Sir Benjamin C. Brodie, was born in London in 1815. While still residing with his father at Lincoln's Inn Fields, he gained some knowledge of natural history and an interest in fossils from visits to the museum of the Royal College of Surgeons, at a time when W. Clift was curator. Through the influence of Clift he was elected a fellow of the Geological Society early in 1834. Proceeding afterwards to Emmanuel College, Cambridge, he came under the spell of Sedgwick, and henceforth devoted all his leisure time to geology. Entering the church in 1838, he was curate at Wylve in Wiltshire, and for a short time at Steeple Claydon in Buckinghamshire, becoming later rector of Down Hatherley in Gloucestershire, and finally (1855) vicar of Rowington in Warwickshire, and rural dean. Records of geological observations in all these districts were published by him. At Cambridge he obtained fossil shells from the Pleistocene deposit at Barnwell; in the Vale of Wardour he discovered in Purbeck Beds the isopod named by Milne-Edwards *Archaeoniscus Brodiei*; in Buckinghamshire he described the outliers of Purbeck and

Portland Beds; and in the Vale of Gloucester the Lias and Oolites claimed his attention. Fossil insects, however, formed the subject of his special studies (*History of the Fossil Insects of the Secondary Rocks of England*, 1845), and many of his published papers relate to them. He was an active member of the Cotteswold Naturalists' Club and of the Warwickshire Natural History and Archaeological Society, and in 1854 he was chief founder of the Warwickshire Naturalists' and Archaeologists' Field Club. In 1887 the Murchison medal was awarded to him by the Geological Society of London. He died at Rowington, on the 1st of November 1897.

See Memoir by H. B. Woodward in *Geological Magazine*, 1897, p. 481 (with portrait).

BRODY, a town of Austria, in Galicia, 62 m. E. of Lemberg by rail. Pop. (1900) 17,360, of which about two-thirds are Jews. It is situated near the Russian frontier, and has been one of the most important commercial centres in Galicia, especially for the trade with Russia. But since 1879, when its charter as a free commercial city was withdrawn, its trade has also greatly diminished. Brody was created a town in 1684, and was raised to the rank of a free commercial city in 1779.

BROEKHUIZEN, JAN VAN [JANUS BROUKHUSIUS], (1649-1707), Dutch classical scholar and poet, was born on the 20th of November 1649, at Amsterdam. Having lost his father when very young, he was placed with an apothecary, with whom he lived several years. Not liking this employment, he entered the army, and in 1674 was sent with his regiment to America, in the fleet under Admiral de Ruyter, but returned to Holland the same year. In 1678 he was sent to the garrison at Utrecht, where he contracted a friendship with the celebrated Graevius; here he had the misfortune to be so deeply implicated in a duel that, according to the laws of Holland, his life was forfeited. Graevius, however, wrote immediately to Nicholas Heinsius, who obtained his pardon. Not long afterwards he became a captain of one of the companies then at Amsterdam. After the peace of Ryswick, 1697, his company was disbanded, and he retired on a pension to a country house near Amsterdam and pursued his classical and literary studies at leisure. His Dutch poems, in which he followed the model of Pieter Hooft, were first published in 1677; a later edition, with a biography by D. van Hoogstraten, appeared in 1712, the last edition, 1883, was edited by R. A. Kollwijn. His classical reputation rests on his editions of Propertius (1702) and Tibullus (1707). His Latin poems (*Carmina*) appeared in 1684; a later edition (*Poemata*) by D. van Hoogstraten appeared in 1711. The *Select Letters (Jani Broekhusii Epistolae Selectae*, 1809 and 1893) were edited by J. A. Worp, who also wrote his biography, 1891. Broekhuizen died on the 15th of December 1707.

BRÜGGER, WALDEMAR CHRISTOFER (1851-), Norwegian geologist, was born in Christiania on the 10th of November 1851, and educated in that city. In 1876 he was appointed curator of the geological museum in his native city, and assistant on the Geological Survey. He was professor of mineralogy and geology from 1881 to 1890 in the university of Stockholm, and from 1890 in the university of Christiania. He also became rector and president of the senate of the royal university of Christiania. His observations on the igneous rocks of south Tirol compared with those of Christiania afford much information on the relations of the granitic and basic rocks. The subject of the differentiation of rock-types in the process of solidification as plutonic or volcanic rocks from a particular magma received much attention from him. He dealt also with the Palaeozoic rocks of Norway, and with the late glacial and post-glacial changes of level in the Christiania region. The honorary degree of Ph.D. was conferred upon him by the university of Heidelberg and that of LL.D. by the university of Glasgow. The Murchison medal of the Geological Society of London was awarded to him in 1891.

BROGLIE, DE, the name of a noble French family which, originally Piedmontese, emigrated to France in the year 1643. The head of the family, FRANÇOIS MARIE (1611-1656), then took the title of comte de Broglie. He had already distinguished

himself as a soldier, and died, as a lieutenant-general, at the siege of Valenza on the 2nd of July 1656. His son, VICTOR MAURICE, COMTE DE BROGLIE (1649-1727), served under Condé, Turenne and other great commanders of the age of Louis XIV., becoming *maréchal de camp* in 1676, lieutenant-general in 1688, and finally marshal of France in 1724.

The eldest son of Victor Marie, FRANÇOIS MARIE, afterwards DUC DE BROGLIE (1671-1745), entered the army at an early age, and had a varied career of active service before he was made, at the age of twenty-three, lieutenant-colonel of the king's regiment of cavalry. He served continuously in the War of the Spanish Succession and was present at Malplaquet. He was made lieutenant-general in 1710, and served with Villars in the last campaign of the war and at the battle of Denain. During the peace he continued in military employment, and in 1710 he was made director-general of cavalry and dragoons. He was also employed in diplomatic missions, and was ambassador in England in 1724. The war in Italy called him into the field again in 1733, and in the following year he was made marshal of France. In the campaign of 1734 he was one of the chief commanders on the French side, and he fought the battles of Parma and Guastalla. A famous episode was his narrow personal escape when his quarters on the Secchia were raided by the enemy on the night of the 14th of September 1734. In 1733 he directed a war of positions with credit, but he was soon replaced by Marshal de Noailles. He was governor-general of Alsace when Frederick the Great paid a secret visit to Strassburg (1740). In 1742 de Broglie was appointed to command the French army in Germany, but such powers as he had possessed were falling him, and he had always been the "man of small means," safe and cautious, but lacking in elasticity and daring. The only success obtained was in the action of Sahay (25th May 1742), for which he was made a duke. He returned to France in 1743, and died two years later.

His son, VICTOR FRANÇOIS, DUC DE BROGLIE (1718-1804), served with his father at Parma and Guastalla, and in 1744 obtained a colonelcy. In the German War he took part in the storming of Prague in 1742, and was made a brigadier. In 1744 and 1745 he saw further service on the Rhine, and in 1756 he was made *maréchal de camp*. He subsequently served with Marshal Saxe in the low countries, and was present at Rocoux, Val and Maastricht. At the end of the war he was made a lieutenant-general. During the Seven Years' War he served successively under d'Estrées, Soubise and Contades, being present at all the battles from Hastenbeck onwards. His victory over Prince Ferdinand at Bergen (1759) won him the rank of marshal of France from his own sovereign and that of prince of the empire from the emperor Francis I. In 1760 he won an action at Corbach, but was defeated at Vellinghausen in 1761. After the war he fell into disgrace and was not recalled to active employment until 1778, when he was given command of the troops designed to operate against England. He played a prominent part in the Revolution, which he opposed with determination. After his emigration, de Broglie commanded the "army of the princes" for a short time (1792). He died at Münster in 1804.

Another son of the first duke, CHARLES FRANÇOIS, COMTE DE BROGLIE (1719-1781), served for some years in the army, and afterwards became one of the foremost diplomatists in the service of Louis XV. He is chiefly remembered in connection with the *Secret du Roi*, the private, as distinct from the official, diplomatic service of Louis, of which he was the ablest and most important member.

The son of Victor François, VICTOR CLAUDE, PRINCE DE BROGLIE (1757-1794), served in the army, attaining the rank of *maréchal de camp*. He adopted revolutionary opinions, served with Lafayette and Rochambeau in America, was a member of the Jacobin Club, and sat in the Constituent Assembly, constantly voting on the Liberal side. He served as chief of the staff to the Republican army on the Rhine; but in the Terror he was denounced, arrested and executed at Paris on the 27th of June 1794. His dying admonition to his little son was to remain

faithful to the principles of the Revolution, however unjust and ungrateful.

ACHILLE CHARLES LÉONCE VICTOR, DUC DE BROGLIE (1785-1870), statesman and diplomatist, son of the last-named, was born at Paris on the 28th of November 1785. His mother had shared her husband's imprisonment, but managed to escape to Switzerland, where she remained till the fall of Robespierre. She now returned to Paris with her children and lived there quietly until 1796, when she married a M. d'Argenson, grandson of Louis XV.'s minister of war. Under the care of his step-father young de Broglie received a careful and liberal education and made his entrée into the aristocratic and literary society of Paris under the Empire. In 1809, he was appointed a member of the council of state, over which Napoleon presided in person; and was sent by the emperor on diplomatic missions, as attaché, to various countries. Though he had never been in sympathy with the principles of the Empire, de Broglie was not one of those who rejoiced at its downfall. In common with all men of experience and sense he realized the danger to France of the rise to power of the forces of violent reaction. With Decazes and Richelieu he saw that the only hope for a calm future lay in "the reconciliation of the Restoration with the Revolution." By the influence of his uncle, Prince Amédée de Broglie, his right to a peerage had been recognized; and to his own great surprise he received, in June 1814, a summons from Louis XVIII. to the Chamber of Peers. There, after the Hundred Days, he distinguished himself by his courageous defence of Marshal Ney, for whose acquittal he, alone of all the peers, both spoke and voted. After this defiant act of opposition it was perhaps fortunate that his impending marriage gave him an excuse for leaving the country. On the 15th of February 1816, he was married at Leghorn to the daughter of Madame de Staël. He returned to Paris at the end of the year, but took no part in politics until the elections of September 1817 broke the power of the "ultra-royalists" and substituted for the *Chambre introuvable* a moderate assembly. De Broglie's political attitude during the years that followed is best summed up in his own words: "From 1812 to 1822 all the efforts of men of sense and character were directed to reconciling the Restoration and the Revolution, the old régime and the new France. From 1822 to 1827 all their efforts were directed to resisting the growing power of the counter-revolution. From 1827 to 1830 all their efforts aimed at moderating and regulating the reaction in a contrary sense." During the last critical years of Charles X.'s reign, de Broglie identified himself with the *doctrinaires*, among whom Royer-Collard and Guizot were the most prominent. The July revolution placed him in a difficult position; he knew nothing of the intrigues which placed Louis Philippe on the throne; but, the revolution once accomplished, he was ready to uphold the *fait accompli* with characteristic loyalty, and on the 9th of August took office in the new government as minister of public worship and education. As he had foreseen, the ministry was short-lived, and on the 2nd of November he was once more out of office. During the critical time that followed he consistently supported the principles which triumphed with the fall of Lafayette and the accession to power of Casimir Périer in March 1832. After the death of the latter and the insurrection of June 1832, de Broglie took office once more as minister for foreign affairs (October 11th). His tenure of the foreign office was coincident with a very critical period in international relations. But for the sympathy of Great Britain under Palmerston, the July monarchy would have been completely isolated in Europe; and this sympathy the aggressive policy of France in Belgium and on the Mediterranean coast of Africa had been in danger of alienating. The Belgian crisis had been settled, so far as the two powers were concerned, before de Broglie took office; but the concerted military and naval action for the coercion of the Dutch, which led to the French occupation of Antwerp, was carried out under his auspices. The good understanding of which this was the symbol characterized also the relations of de Broglie and Palmerston during the crisis of the first war of Mehemet Ali (g. z.) with the Porte, and in the affairs of the Spanish peninsula

their common sympathy with constitutional liberty led to an agreement for common action, which took shape in the treaty of alliance between Great Britain, France, Spain and Portugal, signed at London on the 22nd of April 1834. De Broglie had retired from office in the March preceding, and did not return to power till March of the following year, when he became head of the cabinet. In 1836, the government having been defeated on a proposal to reduce the five per cents, he once more resigned, and never returned to official life. He had remained in power long enough to prove what honesty of purpose, experience of affairs, and common sense can accomplish when allied with authority. The debt that France and Europe owed him may be measured by comparing the results of his policy with that of his successors under not dissimilar circumstances. He had found France isolated and Europe full of the rumours of war; he left her strong in the English alliance and the respect of Liberal Europe, and Europe freed from the restless apprehensions which were to be stirred into life again by the attitude of Thiers in the Eastern Question and of Guizot in the affair of the "Spanish marriages." From 1836 to 1848 de Broglie held almost completely aloof from politics, to which his scholarly temperament little inclined him, a disinclination strengthened by the death of his wife on the 22nd of September 1838. His friendship for Guizot, however, induced him to accept a temporary mission in 1845, and in 1847 to go as French ambassador to London. The revolution of 1848 was a great blow to him, for he realized that it meant the final ruin of the Liberal monarchy—in his view the political system best suited to France. He took his seat, however, in the republican National Assembly and in the Convention of 1848, and, as a member of the section known as the "Burgresses," did his best to stem the tide of socialism and to avert the reaction in favour of autocracy which he foresaw. He shared with his colleagues the indignity of the *coup d'état* of the 2nd of December 1851, and remained for the remainder of his life one of the bitterest enemies of the imperial régime, though he was heard to remark, with that caustic wit for which he was famous, that the empire was "the government which the poorer classes in France desired and the rich deserved." The last twenty years of his life were devoted chiefly to philosophical and literary pursuits. Having been brought up by his step-father in the sceptical opinions of the time, he gradually arrived at a sincere belief in the Christian religion. "I shall die," said he, "a penitent Christian and an impenitent Liberal." His literary works, though few of them have been published, were rewarded in 1856 by a seat in the French Academy, and he was also a member of another branch of the French Institute, the Academy of Moral and Political Science. In the labours of those learned bodies he took an active and assiduous part. He died on the 25th of January 1870.

Besides his *Souvenirs*, in 4 vols. (Paris, 1885-1888), the duc de Broglie left numerous works, of which only some have been published. Of these may be mentioned *Écrits et discours* (3 vols., Paris, 1863); *Le Libre Échange et l'impôt* (Paris, 1879); *Vues sur le gouvernement de la France* (Paris, 1861). This last was confiscated before publication by the imperial government. See Guizot, *Le Duc de Broglie* (Paris, 1870), and *Mémoires* (Paris, 1856-1867); and the histories of Thureau-Dangin and Duvergier de Hauranne.

JACQUES VICTOR ALBERT, DUC DE BROGLIE (1821-1901), his eldest son, was born at Paris on the 13th of June 1821. After a brief diplomatic career at Madrid and Rome, the revolution of 1848 caused him to withdraw from public life and devote himself to literature. He had already published a translation of the religious system of Leibnitz (1846). He now at once made his mark by his contributions to the *Revue des deux Mondes* and the Orleanist and clerical organ *Le Correspondant*, which were afterwards collected under the titles of *Études morales et littéraires* (1853) and *Questions de religion et d'histoire* (1860). These were supplemented in 1869 by a volume of *Nouvelles études de littérature et de morale*. His *L'Église et l'empire romain au IV^e siècle* (1856-1866) brought him the succession to Lacordaire's seat in the Academy in 1862. In 1870 he succeeded his father in the dukedom, having previously been known as the prince de Broglie. In the following year he was elected to the National

Assembly for the department of the Eure, and a few days later (on the 19th of February) was appointed ambassador in London; but in March 1872, in consequence of criticisms upon his negotiations concerning the commercial treaties between England and France, he resigned his post and took his seat in the National Assembly, where he became the leading spirit of the monarchical campaign against Thiers. On the replacement of the latter by Marshal MacMahon, the duc de Broglie became president of the council and minister for foreign affairs (May 1873), but in the reconstruction of the ministry on the 26th of November, after the passing of the septennate, transferred himself to the ministry of the interior. His tenure of office was marked by an extreme conservatism, which roused the bitter hatred of the Republicans, while he alienated the Legitimist party by his friendly relations with the Bonapartists, and the Bonapartists by an attempt to effect a compromise between the rival claimants to the monarchy. The result was the fall of the cabinet on the 16th of May 1874. Three years later (on the 16th of May 1877) he was entrusted with the formation of a new cabinet, with the object of appealing to the country and securing a new chamber more favourable to the reactionaries than its predecessor had been. The result, however, was a decisive Republican majority. The duc de Broglie was defeated in his own district, and resigned office on the 20th of November. Not being re-elected in 1885, he abandoned politics and reverted to his historical work, publishing a series of historical studies and biographies written in a most pleasing style, and especially valuable for their extensive documentation. He died in Paris on the 19th of January 1901.

Besides editing the *Souvenirs* of his father (1886, &c.), the *Mémoires* of Talleyrand (1891, &c.), and the *Letters* of the Duchess Albertine de Broglie (1896), he published *Le Secret du roi, Correspondance secrète de Louis XV avec ses agents diplomatiques, 1752-1774* (1873); *Frédéric II et Marie Thérèse* (1883); *Frédéric II et Louis XV* (1885); *Marie Thérèse Impératrice* (1888); *Le Père Lacordaire* (1889); *Maurice de Saxe et le marquis d'Argenson* (1891); *La Peix d'Aix-la-Chapelle* (1892); *L'Alliance autrichienne* (1895); *La Mission de M. de Gontaut-Biron à Berlin* (1896); *Voltaire avant et pendant la Guerre de Sept Ans* (1898); *Saint Ambroise*, translated by Margaret Maitland in the series of "The Saints" (1899).

BROGUE. (1) A rough shoe of raw leather (from the Gael. *bróg*, a shoe) worn in the wilder parts of Ireland and the Scottish Highlands. (2) A dialectal accent or pronunciation (of uncertain origin), especially used of the Irish accent in speaking English.

BROHAN, AUGUSTINE SUSANNE (1807-1887), French actress, was born in Paris on the 22nd of January 1807. She entered the Conservatoire at the age of eleven, and took the second prize for comedy in 1820, and the first in 1821. She served her apprenticeship in the provinces, making her first Paris appearance at the Odéon in 1832 as Dorine in *Tartuffe*. Her success there and elsewhere brought her a summons to the Comédie Française, where she made her *début* on the 15th of February 1834, as Madelon in *Les Précieuses ridicules*, and Suzanne in *Le Mariage de Figaro*. She retired in 1842, and died on the 16th of August 1887.

Her elder daughter, **JOSEPHINE FÉLICITÉ AUGUSTINE BROHAN** (1824-1893), was admitted to the Conservatoire when very young, twice taking the second prize for comedy. The soubrette part, entrusted for more than 150 years at the Comédie Française to a succession of artists of the first rank, was at the moment without a representative, and Mdlle Augustine Brohan made her *début* there on the 19th of May 1841, as Dorine in *Tartuffe*, and Lise in *Rivaux d'eux-mêmes*. She was immediately admitted *pensionnaire*, and at the end of eighteen months unanimously elected *sociétaire*. She soon became a great favourite, not only in the plays of Molière and de Regnard, but also in those of Marivaux. On her retirement from the stage in 1866, she made an unhappy marriage with Edmond David de Gheest (d. 1885), secretary to the Belgian legation in Paris.

Suzanne Brohan's second daughter, **ÉMILIE MADELEINE BROHAN** (1833-1900), also took first prize for comedy at the Conservatoire (1850). She was engaged at once by the Comédie Française, but instead of making her *début* in some play of the

répertoire of the theatre, the management put on for her benefit a new comedy by Scribe and Legouvè, *Les Contes de la reine de Navarre*, in which she created the part of Marguerite on the 1st of September 1850. Her talents and beauty made her a success from the first, and in less than two years from her *début* she was elected *sociétaire*. In 1853 she married Mario Uchard, from whom she was soon separated, and in 1858 she returned to the Comédie Française in leading parts, until her retirement in 1866. Her name is associated with a great number of plays, besides those in the classical *répertoire*, notably *Le Monde où l'on s'ennuie*, *Par droit de conquête*, *Les Deux Veuves*, and *Le Lion amoureux*, in which, as the "marquise de Maupas," she had one of her greatest successes.

BROKE, or **BROOKE, ARTHUR** (d. 1563), English author, wrote the first English version of the story of Romeo and Juliet. *The Tragicall Historie of Romeus and Juliect* (1562) is a rhymed account of the story, taken, not directly from Banello's collection of novels (1554), but from the French translation (*Histoires tragiques*) of Pierre Boastiau or Boisteau, surnamed Laumay, and François de Belleforest. Broke adds some detail to the story as told by Boisteau. As the poem contains many scenes which are not known to exist elsewhere, but which were adopted by Shakespeare in *Romeo and Juliet*, there is no reasonable doubt that it may be regarded as the main source of the play. Broke perished by shipwreck in 1563, on his way from Newhaven to join the English troops fighting on the Huguenot side in France.

The genesis of the Juliet story, and a close comparison of Shakespeare's play with Broke's version, are to be found in a reprint of the poem and of William Paynter's prose translation from the *Palace of Pleasure*, edited by Mr F. A. Daniel for the New Shakespeare Society (1875).

BROKE, SIR PHILIP BOWES VERE, BART. (1776-1841), British rear-admiral, was born at Broke Hall, near Ipswich, on the 9th of September 1776, a member of an old Suffolk family. Entering the navy in June 1792, he saw active service in the Mediterranean from 1793 to 1795, and was with the British fleet at the battle of Cape St Vincent, 1797. In 1798 he was present at the defeat and capture of the French squadron of the north coast of Ireland. From 1799 to 1801 he served with the North Sea fleet, and in the latter year was made captain. Unemployed for the next four years, he commanded in 1805 a frigate in the English and Irish Channels. In 1806 he was appointed to the command of the "Shannon," 38-gun frigate, remaining afloat, principally in the Bay of Biscay, till 1811. The "Shannon" was then ordered to Halifax, Nova Scotia. For a year after the declaration of war between Great Britain and the United States in 1812, the frigate saw no important service, though she captured several prizes. Broke utilised this period of comparative inactivity to train his men thoroughly. He paid particular attention to gunnery, and the "Shannon" ere long gained a unique reputation for excellence of shooting. Broke's opportunity came in 1813. In May of that year the "Shannon" was cruising off Boston, watching the "Chesapeake," an American frigate of the same nominal force but heavier armament. On the 1st of June Broke, finding his water supply getting low, wrote to Lawrence, the commander of the "Chesapeake," asking for a meeting between the two ships, stating the "Shannon's" force, and guaranteeing that no other British ship should take part in the engagement. Before this letter could be delivered, however, the "Chesapeake," under full sail, ran out of Boston harbour, crowds of pleasure-boats accompanying her to witness the engagement. Broke briefly addressed his men. "Don't cheer," he concluded, "go quietly to your quarters. I feel sure you will all do your duty." As the "Chesapeake" rounded to on the "Shannon's" weather quarter, at a distance of about fifty yards, the British frigate received her with a broadside. A hundred of the "Chesapeake's" crew were struck down at once, Lawrence himself being mortally wounded. A second broadside, equally well-aimed, increased the confusion, and, her tiller-ropes being shot away, the American frigate drifted foul of the "Shannon." Broke sprang on board with some sixty of his men following him. After a brief struggle

the fight was over. Within fifteen minutes of the firing of the first shot, the "Chesapeake" struck her flag, but Broke himself was seriously wounded. For his services he was rewarded with a baronetcy, and subsequently was made a K.C.B. His exploit captivated the public fancy, and his popular title of "Brave Broke" gives the standard by which his action was judged. Its true significance, however, lies deeper. Broke's victory was due not so much to courage as to forethought. "The 'Shannon,'" said Admiral Jurien de La Gravière, "captured the 'Chesapeake' on the 1st of June 1813; but on the 14th of September 1806, when he took command of his frigate, Captain Broke had begun to prepare the glorious termination to this bloody affair." Broke's wound incapacitated him from further service, and for the rest of his life caused him serious suffering. He died in London on the 2nd of January 1841.

BROKEN HILL, a silver-mining town of Yancowinna county, New South Wales, Australia, 92½ m. directly W. by N. of Sydney, and connected with Adelaide by rail. Pop. (1901) 27,518. One of the neighbouring mines, the Proprietary, is the richest in the world; gold is associated with the silver; large quantities of lead, good copper lodes, zinc and tin are also found. The problem of the profitable treatment of the sulphide ores has been practically solved here. In addition Broken Hill is the centre of one of the largest pastoral districts in Australia. The town is the seat of the Roman Catholic bishop of Wilcannia.

BROKER (according to the *New English Dictionary*, from Lat. *brocco*, spit, spike, *broccare*, to "broach"—another Eng. form of the same word; hence O. Fr. *vendre à broche*, to retail, e.g. wine, from the tap, and thus the general sense of dealing; see also for a discussion of the etymology and early history of the use of the word, J. R. Dos Passos, *Law of Stockbrokers*, chap. i., New York, 1905). In the primary sense of the word, a broker is a mercantile agent, of the class known as general agents, whose office is to bring together intending buyers and sellers and make a contract between them, for a remuneration called brokerage or commission; e.g. cotton brokers, wool brokers or produce brokers. Originally the only contracts negotiated by brokers were for the sale or purchase of commodities; but the word in its present use includes other classes of mercantile agents, such as stockbrokers, insurance-brokers, ship-brokers or bill-brokers. Pawnbrokers are not brokers in any proper sense of the word; they deal as principals and do not act as agents. In discussing the chief questions of modern legal interest in connexion with brokers, we shall deal with them, firstly, in the original sense of agents for the purchase and sale of goods.

Relations between Broker and Principal.—A broker has not, like a factor, possession of his principal's goods, and, unless expressly authorized, cannot buy or sell in his own name; his business is to bring into privity of contract his principal and the third party. When the contract is made, ordinarily he drops out altogether. Brokers very frequently act as factors also, but, when they do so, their rights and duties as factors must be distinguished from their rights and duties as brokers. It is a broker's duty to carry out his principal's instructions with diligence, skill and perfect good faith. He must see that the terms of the bargain accord with his principal's orders from a commercial point of view, e.g. as to quality, quantity and price; he must ensure that the contract of sale effected by him be legally enforceable by his principal against the third party; and he must not accept any commission from the third party, or put himself in any position in which his own interest may become opposed to his principal's. As soon as he has made the contract which he was employed to make; in most respects his duty to, and his authority from, his principal alike cease; and consequently the law of brokers relates principally to the formation of contracts by them.

The most important formality in English law, in making contracts for the sale of goods, with which a broker must comply, in order to make the contract legally enforceable by his principal against the third party, is contained in section 4 of the Sale of Goods Act 1893, which (in substance re-enacting section 17 of the Statute of Frauds) provides as follows:—"A contract for the

sale of any goods of the value of ten pounds or upwards shall not be enforceable by action unless the buyer shall accept part of the goods as sold, and actually receive the same, or give something in earnest to bind the contract, or in part payment, or unless some note or memorandum in writing of the contract be made and signed by the party to be charged or his agent in that behalf."

From the reign of James I. till 1884 brokers in London were admitted and licensed by the corporation, and regulated by statute; and it was common to employ one broker only, who acted as intermediary between, and was the agent of both buyer and seller. When the Statute of Frauds was passed in the reign of Charles II., it became the practice for the broker, acting for both parties, to insert in a formal book, kept for the purpose, a memorandum of each contract effected by him, and to sign such memorandum on behalf of both parties, in order that there might be a written memorandum of the contract of sale, signed by the agent of the parties as required by the statute. He would then send to the buyer a copy of this memorandum, called the "bought note," and to the seller a "sold note," which would run as follows:—

"I have this day bought for you from A B [or "my principal"]
..... [signed] "M. Broker."

"I have this day sold for you to A B [or "my principal"].
..... [signed] "M. Broker."

There was in the earlier part of the 19th century considerable discussion in the courts as to whether the entry in a broker's book, or the bought and sold notes (singly or together), constituted the statutory memorandum; and judicial opinion was not unanimous on the point. But at the present day brokers are no longer regulated by statute, either in London or elsewhere, and keep no formal book; and as an entry made in a private book kept by the broker for another purpose, even if signed, would probably not be regarded as a memorandum signed by the agent of the parties in that behalf, the old discussion is now of little practical interest.

Under modern conditions of business the written memorandum of the contract of sale effected by the broker is usually to be found in a "contract note"; but the question whether, in the particular circumstances of each case, the contract note affords a sufficient memorandum in writing, depends upon a variety of considerations—e.g. whether the transaction is effected through one or through two brokers; whether the contract notes are rendered by one broker only, or by both; and, if the latter, whether exchanged between the brokers, or rendered by each broker to his own client; for under present practice any one of these methods may obtain, according to the trade in which the transaction is effected, and the nature of the particular transaction.

Where one and the same broker is employed by both seller and buyer, bought and sold notes rendered in the old form provide the necessary memorandum of the contract. Where two brokers are employed, one by the seller and one by the buyer, sometimes one drops out as soon as the terms are negotiated, and the other makes out, signs and sends to the parties the bought and sold notes. The latter then becomes the agent of both parties for the purpose of signing the statutory memorandum, and the position is the same as if one broker only had been employed. On the other hand, if one broker does not drop out of the transaction, each broker remains to the end the agent of his own principal only, and neither becomes the agent of the other party for the purpose of signing the memorandum. In such a case it is the usual practice for the buyer's broker to send to the seller's broker a note of the contract,—“I, acting on account of A. B. [or, “of my principal,”], have this day bought from you, acting on account of C. D. [or, “of your principal,”],—and to receive a corresponding note from the seller's broker. Thus each of the parties receives through his own agent a memorandum signed by the other party's agent. These contract notes are usually known as, and serve the purpose of, “bought” and “sold” notes. In all the above three cases the broker's duty of compliance with all formalities necessary to make the contract of sale legally enforceable is performed,

and both parties obtain a written memorandum of the contract upon which they can sue.

The broker, on performing his duty in accordance with the terms upon which he is employed, is entitled to be paid his "brokerage." This usually takes the form of a percentage, varying according to the nature and conditions of the business, upon the total price of the goods bought or sold through him. When he guarantees the solvency of the other party, he is said to be employed upon *del credere* terms, and is entitled to a higher rate of remuneration. In some trades it is the custom for the selling broker to receive payment from the buyer or his broker; and in such case it is his duty to account to his principal for the purchase money. A broker who properly expends money or incurs liability on his principal's behalf in the course of his employment, is entitled to be reimbursed the money, and indemnified against the liability. Not having, like a factor, possession of the goods, a broker has no lien by which to enforce his rights against his principal. If he fails to perform his duty, he loses his right to remuneration, reimbursement and indemnity, and further becomes liable to an action for damages for breach of his contract of employment, at the suit of his principal.

Relations between Broker and Third Party.—A broker who signs a contract note as broker on behalf of a principal, whether named or not, is not personally liable on the contract to the third party. But if he makes the contract in such a way as to make himself a party to it, the third party may sue either the broker or his principal, subject to the limitation that the third party, by his election to treat one as the party to the contract, may preclude himself from suing the other. In this respect the ordinary rules of the law of agency apply to a broker. Generally, a broker has not authority to receive payment, but in trades in which it is customary for him to do so, if the buyer pays the seller's broker, and is then sued by the seller for the price by reason of the broker having become insolvent or absconded, he may set up the payment to the broker as a defence to the action by the broker's principal. Brokers may render themselves liable for damages in tort for the conversion of the goods at the suit of the true owner if they negotiate a sale of the goods for a selling principal who has no title to the goods.

The Influence of Exchanges.—The relations between brokers and their principals, and also between brokers and third parties as above defined, have been to some extent modified in practice by the institution since the middle of the 19th century in important commercial centres of "Exchanges," where persons interested in a particular trade, whether as merchants or as brokers, meet for the transaction of business. By the contract of membership of the association in whose hands is vested the control of the exchange, every person on becoming a member agrees to be bound by the rules of the association, and to make his contracts on the market in accordance with them. A governing body or committee elected by the members enforces observance of the rules, and members who fail to meet their engagements on the market, or to conform to the rules, are liable to suspension or expulsion by the committee. All disputes between members on their contracts are submitted to an arbitration tribunal composed of members; and the arbitrators in deciding the questions submitted to them are guided by the rules. A printed book of rules is available for reference; and various printed forms of contract suited to the various requirements of the business are specified by the rules and supplied by the association for the use of members. In order to simplify the settlement of accounts between members, particularly in respect of "futures," *i.e.* contracts for future delivery, a weekly or other periodical settlement is effected by means of a clearing-house; each member paying or receiving in respect of all his contracts which are still open, the balance of his weekly "differences," *i.e.* the difference between the contract price and the market price fixed for the settlement, or between the last and the present settlement prices.

As all contracts on the market are made subject to the rules, it follows that so far as the rules alter the rights and liabilities attached by law, the ordinary law is modified. The most

important modification in the position of brokers effected by membership of such an exchange is due to the rule that as, between themselves, all members are principals, on the market no agents are recognized; a broker employed by a non-member to buy for him on the market is treated by the rules as buying for himself, and is, therefore, personally liable on the contract. If it be a contract in futures, he is required to conform to the weekly settlement rules. If his principal fails to take delivery, the engagement is his and he is required to make good to the member who sold to him any difference between the contract and market price at the date of delivery. But whilst this practice alters directly the relations of the broker to the third party, it also affects or tends to affect indirectly the relations of the broker to his own principal. The terms of the contract of employment being a matter of negotiation and agreement between them, it is open to a broker, if he chooses, to stipulate for particular terms; and it is the usual practice of exchanges to supply printed contract forms for the use of members in their dealings with non-members who employ them as brokers, containing a stipulation that the contract is made subject to the rules of the exchange; and frequently also a clause that the contract is made with the broker as principal. In addition to these express terms, there is in the contract of employment the term, implied by law in all trade contracts, that the parties consent to be bound by such trade usages as are consistent with the express terms of the contract, and reasonable. On executing an order the broker sends to his client a contract-note either in the form of the old bought and sold notes "I have this day bought for you," or, when the principal clause is inserted, "I have this day sold to you." These are not bought and sold notes proper, for the broker is not the agent of the third party for the purpose of signing them as statutory memoranda of sale. But they purport to record the terms of the contract of employment, and the principal may treat himself as bound by their provisions. Sometimes they are accompanied by a detachable form, known as the "client's return contract note," to be filled in, signed and returned by the client; but even the "client's return contract note" is retained by the client's own broker, and is only a memorandum of the terms of employment. The following is a form of contract note rendered by a broker to his client for American cotton, bought on the Liverpool Cotton Exchange for future delivery. The client's contract note is attached to it, and is in precisely corresponding form.

AMERICAN COTTON,
Delivery Contract Note.

Liverpool,

M.....

DEAR SIRS,

We have this day to you
..... from
..... lb American Cotton, net weight, to be contained
in American Bales, more or less, to be delivered in
Liverpool, during on the basis of per lb
for on the terms of the rules, bye-laws, and Clearing
House regulations of the Liverpool Cotton Association, Limited,
whether endorsed hereon or not.

The contract, of which this is a note, is made between ourselves and yourselves, and not by or with any person, whether disclosed or not, on whose instructions or for whose benefit the same may have been entered into. Yours faithfully,

.....
The contract, of which the above is a note, was made on the date specified, within the business hours fixed by the Liverpool Cotton Association, Limited.

..... per cent to us.

Please confirm by signing and returning the contract attached.

The above form of contract note illustrates the tendency of exchanges to alter the relations between the broker and his principal. The object of inserting in the printed form the provision that the contract is made subject to the rules of the

Liverpool Cotton Association is to make those rules binding upon the principal, and if he employs his broker upon the basis of the printed form, he does bind himself to any modification of the relations between himself and his broker which those rules may effect. The object of the principal clause in the above and similar printed forms is apparently to entitle the broker to sell to or buy from his principal on his own account and not as agent at all, thus disregarding the duty incumbent upon him as broker of making for his principal a contract with a third party.

It is not possible, except very generally, to state how far exchanges have succeeded in imposing their own rules and usages on non-members, but it is probably correct to say that in most cases if the question came before the courts, the outside client would be held to have accepted the rules of the exchange so far as they did not alter the fundamental duties to him of his broker. On the other hand, provisions purporting to entitle the broker in disregard of his duties as broker himself to act as principal, would be rejected by the courts as radically inconsistent with the primary object of the contract of brokerage and, therefore, meaningless. But it is undoubtedly too often the practice of brokers who are members of exchanges to consider themselves entitled to act as principals and sell on their own account to their own clients, particularly in futures. The causes of this opinion, erroneously, though quite honestly held, are probably to be looked for partly in the habit of acting as principal on the market in accordance with the rules, partly in the forms of contract notes containing "principal clauses" which they send to their clients, and perhaps, also, in the occasional difficulty of effecting actual contracts on the market at the time when they are instructed so to do.

A *stockbroker* is a broker who contracts for the sale of stocks and shares. Stockbrokers differ from brokers proper chiefly in that stocks and shares are not "goods," and the requirement of a memorandum in writing, enacted by the Sale of Goods Act 1893, does not apply. Hence actions may be brought by the principals to a contract for the sale of stocks and shares although no memorandum in writing exists. For instance, the jobber, on failing to recover from the buyer's broker the price of shares sold, by reason of the broker having failed and been declared a defaulter, may sue the buyer whose "name was passed" by the broker. The employment of a stockbroker is subject to the rules and customs of the Stock Exchange, in accordance with the principles discussed above, which apply to the employment of brokers proper. A custom which is illegal, such as the Stock Exchange practice of disregarding Leeman's Act (1867), which enacts that contracts for the sale of joint-stock bank shares shall be void unless the registered numbers of the shares are stated therein, is not binding on the client to the extent of making the contract of sale valid. But if a client chooses to instruct his broker to buy bank shares in accordance with that practice, the broker is entitled to be indemnified by his client for money which he pays on his behalf, even though the contract of sale so made is unenforceable. For further information the reader is referred to the article STOCK EXCHANGE and to the treatises on stock exchange law.

An *insurance broker* is an agent whose business is to effect policies of marine insurance. He is employed by the person who has an interest to insure, pays the premiums to the underwriter, takes up the policy, and receives from the underwriter payment in the event of a loss under the policy. By the custom of the trade the underwriter looks solely to the broker for payment of premiums, and has no right of action against the assured; and, on the other hand, the broker is paid his commission by the underwriter, although he is employed by the assured. Usually the broker keeps a current account with the underwriter, and premiums and losses are dealt with in account. It is only in the event of the underwriter refusing to pay on a loss, that the broker drops out and the assured sues the underwriter direct. Agents who effect life, fire or other policies, are not known as insurance brokers.

Ship-brokers are, firstly, "commission agents," and, secondly, very often also ships' managers. Their office is to act as agents for owners of ships to procure purchasers for ships, or ships for intending purchasers, in precisely the same manner as house-agents act in respect of houses. They also act as agents for ship-owners in finding charterers for their ships, or for charterers in finding ships available for charter, and in either case they effect the charter-party (see AFFRAGMENT).

Chartering brokers are customarily paid by the ship-owner, when the charter-party is effected, whether originally employed by him or by the charterer. Charter-parties effected through brokers often contain a provision—"2½% on estimated amount of freight to be paid to A B, broker, on the signing of this charter-party, and the ship

to be consigned to him for ship's business at the port of X [inserting the name of the port where A B carries on business]." The broker cannot sue on the charter-party contract because he is not a party to it, but the insertion of the clause practically prevents his right from being disputed by the ship-owner. When the broker does the ship's business in port, it is his duty to clear her at the customs and generally to act as "ship's husband."

A *bill-broker* was originally an agent who, for a commission, procured for country bankers the discounting of their bills in London. But the practice arose of the broker guaranteeing the London banker or financier; and finally the brokers ceased to deposit with the London bankers the bills they received, and at the present day a bill-broker, as a rule, buys bills on his own account at a discount, borrows money on his own account and upon his own security at interest, and makes his profit out of the difference between the discount and the interest. When acting thus the bill-broker is not a broker at all, as he deals as principal and does not act as agent.

AUTHORITIES.—Story, *Commentaries on the Law of Agency* (Boston, 1882); Brodhurst, *Law and Practice of the Stock Exchange* (London, 1897); Gow, *Handbook of Marine Insurance* (London, 1900); Arnould, *On Marine Insurance*, edited by Messrs Hart & Simey (1901); J. R. Dos Passos, *Law of Stock-Brokers and Stock Exchanges* (New York, 1905). (L. F. S.)

BROMBERG, a town of Germany, in the Prussian province of Posen, 32 m. by rail W.N.W. from the fortress of Thorn, 7 m. W. from the bank of the Vistula, and at the centre of an important network of railways, connecting it with the strategical points on the Prusso-Russian frontier. Pop. (1900) 52,082; (1905) 54,229. Its public buildings comprise two Roman Catholic and three Protestant churches, a Jewish synagogue, a seminary, high grade schools and a theatre. The town also possesses a bronze statue of the emperor William I., a monument of the war of 1870-71, and a statue of Benkenhoff, the constructor of the Bromberg Canal. This engineering work, constructed in 1773-1774, by command of Frederick II., connects the Brahe with the Netze, and thus establishes communication between the Vistula, the Oder and the Elbe. The principal industrial works are iron foundries and machine shops, paper factories and flour mills; the town has, moreover, an active trade in agricultural and other products. In view of its strategical position, a large garrison is concentrated in and about the town. Bromberg is mentioned as early as 1252. It fell soon afterwards into the hands of the Poles, from whom it was taken in 1327 by the Teutonic Order, which held it till 1343, when the Poles recaptured it. Destroyed in the course of these struggles, it was restored by Casimir of Poland in 1346, and down to the close of the 16th century it continued to be a flourishing commercial city. It afterwards suffered so much from war and pestilence that about 1772, when the Prussians took possession, it contained only from five to six hundred inhabitants. By the treaty of Tilsit it was transferred to the duchy of Warsaw; in 1813 it was occupied by the Russians, and in 1815 was restored to Prussia.

BROME, ALEXANDER (1620-1666), English poet, was by profession an attorney, and was the author of many drinking songs and of satirical verses in favour of the Royalists and against the Rump. He published in 1661 *Songs and other Poems*, containing songs on various subjects, followed by a series of political songs; ballads, epistles, elegies and epitaphs; epigrams and translations. Izaak Walton wrote an introductory eclogue for this volume in praise of the writer, and his gaiety and wit won for him the title of the "English Anacreon" in Edward Phillips's *Theatrum Poetarum*. Brome published in 1666 a translation of Horace by himself and others, and was the author of a comedy entitled *The Cunning Lovers* (1654). He also edited two volumes of Richard Brome's plays.

BROME, RICHARD (d. 1652), English dramatist, was originally a servant of Ben Jonson, and owed much to his master. The development of his plots, the strongly marked characters and the amount of curious information to be found in his work, all show Jonson's influence. The relation of master and servant developed into friendship, and our knowledge of Brome's personal character is chiefly drawn from Ben Jonson's lines to him, prefixed to *The Northern Lasse* (1632), the play which made Brome's reputation. Brome's genius lay entirely in comedy. He has left fifteen pieces. *Five New Plays* (ed. by Alex. Brome, 1652?) contained *Madd Couple Well Match* (acted 1639?);

Novella (acted 1632); *Court Begger* (acted 1632); *City Witt*; *The Damselle or the New Ordinary*. Five New Playes (1650) included *The English Moor*, or *The Mock Marriage*; *The Love-Sick Court*, or *The Ambitious Politique*; *Covent Garden Weeded*; *The New Academy*, or *The New Exchange*; and *The Queen and Concubine*. *The Antipodes* (acted 1638, pr. 1640); *The Sparagus Garden* (acted 1635, pr. 1640); *A Joviall Crew*, or *the Merry Beggars* (acted 1641, pr. 1652, revised in 1731 as an "opera"), and *The Queenes Exchange* (pr. 1657), were published separately. He collaborated with Thomas Heywood in *The late Lancashire Witches* (pr. 1634).

See A. W. Ward, *History of English Dramatic Literature*, vol. iii. pp. 125-131 (1899). *The Dramatic Works of Richard Brome* . . . were published in 1873.

BROMELIACEAE, in botany, a natural order of Monocotyledons, confined to tropical and sub-tropical America. It includes the pine-apple (fig. 1) and the so-called Spanish moss (fig. 2), a rootless plant, which hangs in long grey lichen-like festoons from the branches of trees, a native of Mexico and the southern United States; the water required for food is absorbed from the moisture in the air by peculiar hairs which cover the

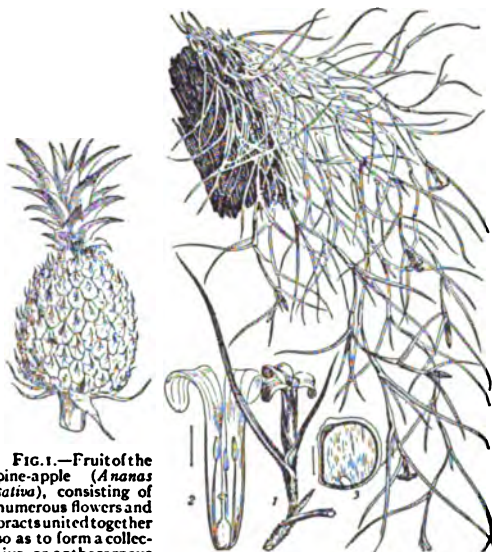

FIG. 1.—Fruit of the pine-apple (*Ananas sativa*), consisting of numerous flowers and bracts united together so as to form a collective or anthocarpous fruit. The crown of the pine-apple, *c.*, consists of a series of empty bracts prolonged beyond the fruit.

(From *The Botanical Magazine*, by permission of Lovell, Reeve & Co.)

FIG. 2.—*Tillandsia usneoides*, Spanish moss, slightly reduced. 1, Small branch with flower; 2, flower cut vertically; 3, section of seed of *Bromelia*.

surface of the shoots. The plants are generally herbs with a much shortened stem bearing a rosette of leaves and a spike or panicle of flowers. They are eminently dry-country plants (xerophytes); the narrow leaves are protected from loss of water by a thick cuticle, and have a well-developed sheath which embraces the stem and forms, with the sheaths of the other leaves of the rosette, a basin in which water collects, with fragments of rotting leaves and the like. Peculiar hairs are developed on the inner surface of the sheath by which the water and dissolved substances are absorbed, thus helping to feed the plant. The leaf-margins are often spiny, and the leaf-spines of *Puya chilensis* are used by the natives as fish-hooks. Several species are grown as hot-house plants for the bright colour of their flowers or flower-bracts, e.g. species of *Tillandsia*, *Billbergia*, *Aechmea* and others.

BROMINE (symbol Br, atomic weight 79.96), a chemical element of the halogen group, which takes its name from its pungent unpleasant smell (*βρωμος*, a stench). It was first isolated by A. J. Balard in 1826 from the salts in the waters of the Mediterranean. He established its elementary character, and his researches were amplified by K. J. Löwig (1803-1869) in *Das Brom und seine chemischen Verhältnisse* (1829). Bromine does not occur in nature in the uncombined condition, but in combination with various metals is very widely but sparingly distributed. Potassium, sodium and magnesium bromides are found in mineral waters, in river and sea-water, and occasionally in marine plants and animals. Its chief commercial sources are the salt deposits at Stassfurt in Prussian Saxony, in which magnesium bromide is found associated with various chlorides, and the brines of Michigan, Ohio, Pennsylvania and West Virginia, U.S.A.; small quantities are obtained from the mother liquors of Chile saltpetre and kelp. In combination with silver it is found as the mineral bromargyrite (bromite).

Manufacture.—The chief centres of the bromine industry are Stassfurt and the central district of Michigan. It is manufactured from the magnesium bromide contained in "bitters" (the mother liquor of the salt industry), by two processes, the continuous and the periodic. The continuous process depends upon the decomposition of the bromide by chlorine, which is generated in special stills. A regular current of chlorine mixed with steam is led in at the bottom of a tall tower filled with broken bricks, and there meets a descending stream of hot bittern: bromine is liberated and is swept out of the tower together with some chlorine, by the current of steam, and then condensed in a worm. Any uncondensed bromine vapour is absorbed by moist iron borings, and the resulting iron bromide is used for the manufacture of potassium bromide. The periodic process depends on the interaction between manganese dioxide (pyrolusite), sulphuric acid, and a bromide, and the operation is carried out in sandstone stills heated to 60° C., the product being condensed as in the continuous process. The substitution of potassium chlorate for pyrolusite is recommended when calcium chloride is present in the bittern. The crude bromine is purified by repeated shaking with potassium, sodium or ferrous bromide and subsequent redistillation. Commercial bromine is rarely pure, the chief impurities present in it being chlorine, hydrobromic acid, and bromoform (M. Hermann, *Annalen*, 1855, 95, p. 211). E. Gessner (*Berlin*, 1876, 9, p. 1507) removes chlorine by repeated shaking with water, followed by distillation over sulphuric acid; hydrobromic acid is removed by distillation with pure manganese dioxide, or mercuric oxide, and the product dried over sulphuric acid. J. S. Stas, in his stoichiometric researches, prepared chemically pure bromine from potassium bromide, by converting it into the bromate which was purified by repeated crystallization. By heating the bromate it was partially converted into the bromide, and the resulting mixture was distilled with sulphuric acid. The distillate was further purified by digestion with milk of lime, precipitation with water, and further digestion with calcium bromide and barium oxide, and was finally redistilled.

Characters.—Bromine at ordinary temperatures is a mobile liquid of fine red colour, which appears almost black in thick layers. It boils at 59° C. According to Sir W. Ramsay and S. Young, bromine, when dried over sulphuric acid, boils at 57.65° C., and when dried over phosphorus pentoxide, boils at 58.85° C. (under a pressure of 755.8 mm.), forming a deep red vapour, which exerts an irritating and directly poisonous action on the respiratory organs. It solidifies at -21° C. (Quincke) to a dark brown solid. Its specific gravity is 3.1828 (2/3), latent heat of fusion 16-185 calories, latent heat of vaporization 45.6 calories, specific heat 0.1071. The specific heat of bromine vapour, at constant pressure, is 0.05504 and at constant volume is 0.04251 (K. Strecker). Bromine is soluble in water, to the extent of 3.226 grammes of bromine per 100 grammes of solution at 15° C., the solubility being slightly increased by the presence of potassium bromide. The solution is of an orange-red colour, and is quite permanent in the dark, but on exposure to light, gradually becomes colourless, owing to decomposition into hydrobromic acid and oxygen. By cooling the aqueous solution, hyacinth-red octahedra of a crystalline hydrate of composition $Br_4 \cdot 4H_2O$ or $Br_2 \cdot 8H_2O$ are obtained (Bakhuys Roozeboom, *Zeits. phys. Chem.*, 1888, 2, p. 449). Bromine is readily soluble in chloroform, alcohol and ether. Its chemical properties are in general intermediate between those of chlorine and iodine; thus it requires the presence of a catalytic agent, or a fairly high temperature, to bring about its union with hydrogen. It does not combine directly with oxygen, nitrogen or carbon. With the other elements it unites to form bromides, often with explosive violence; phosphorus detonates in liquid bromine and inflames in the vapour; iron is occasionally used to absorb bromine vapour, potassium reacts energetically, but sodium requires to be heated to 200° C. The chief use of bromine in analytical chemistry is based upon the oxidizing action of bromine waters. Bromine and bromine water both bleach organic colouring matters.

The use of bromine in the extraction of gold (*q.v.*) was proposed by R. Wagner (*Dingler's Journal*, 218, p. 253) and others, but its cost has restricted its general application. Bromine is used extensively in organic chemistry as a substituting and oxidizing agent and also for the preparation of addition compounds. Reactions in which it is used in the liquid form, in vapour, in solution, and in the presence of the so-called "bromine carriers," have been studied. Sunlight affects the action of bromine vapour on organic compounds in various ways, sometimes retarding or accelerating the reaction, while in some cases the products are different (J. Schramm, *Monatshfte für Chemie*, 1887, 8, p. 101). Some reactions, which are only possible by the aid of nascent bromine, are carried out by using solutions of sodium bromide and bromate, with the amount of sulphuric acid calculated according to the equation $5\text{NaBr} + \text{NaBrO}_3 + 6\text{H}_2\text{SO}_4 = 6\text{NaHSO}_4 + 3\text{H}_2\text{O} + 6\text{Br}$. (German Patent, 26642.) The diluents in which bromine is employed are usually ether, chloroform, acetic acid, hydrochloric acid, carbon bisulphide and water, and, less commonly, alcohol, potassium bromide and hydrobromic acid; the excess of bromine being removed by heating, by sulphurous acid or by shaking with mercury. The choice of solvent is important, for the velocity of the reaction and the nature of the product may vary according to the solvent used, thus A. Baeyer and F. Blom found that on brominating orthoacetamidio-acetophenone in presence of water or acetic acid, the bromine goes into the benzene nucleus, whilst in chloroform or sulphuric acid or by use of bromine vapour it goes into the side chain as well. The action of bromine is sometimes accelerated by the use of compounds which behave catalytically, the more important of these substances being iodine, iron, ferric chloride, ferric bromide, aluminium bromide and phosphorus. For oxidizing purposes bromine is generally employed in aqueous and in alkaline solutions, one of its most important applications being by Emil Fischer (*Berichte*, 1889, 22, p. 362) in his researches on the sugars. The atomic weight of bromine has been determined by J. S. Stas and C. Marignac from the analysis of potassium bromide, and of silver bromide. G. P. Baxter (*Zeit. anorg. Chem.* 1906, 50, p. 389) determined the ratios $\text{Ag} : \text{AgBr}$, and $\text{AgCl} : \text{Ag Br}$.

Hydrobromic Acid.—This acid, HBr , the only compound of hydrogen and bromine, is in many respects similar to hydrochloric acid, but is rather less stable. It may be prepared by passing hydrogen gas and bromine vapour through a tube containing a heated platinum spiral. It cannot be prepared with any degree of purity by the action of concentrated sulphuric acid on bromides, since secondary reactions take place, leading to the liberation of free bromine and formation of sulphur dioxide. The usual method employed for the preparation of the gas consists in dropping bromine on to a mixture of amorphous phosphorus and water, when a violent reaction takes place and the gas is rapidly liberated. It can be obtained also, although in a somewhat impure condition, by the direct action of bromine on various saturated hydrocarbons (*e.g.* paraffin-wax), while an aqueous solution may be obtained by passing sulphuretted hydrogen through bromine water. Alexander Scott (*Journal of Chem. Soc.*, 1900, 77, p. 648) prepares pure hydrobromic acid by covering bromine, which is contained in a large flask, with a layer of water, and passing sulphur dioxide into the water above the surface of the bromine, until the whole is of a pale yellow colour; the resulting solution is then distilled in a slow current of air and finally purified by distillation over barium bromide. At ordinary temperatures hydrobromic acid is a colourless gas which fumes strongly in moist air, and has an acid taste and reaction. It can be condensed to a liquid, which boils at -64.9°C . (under a pressure of 738.2 mm.), and by still further cooling, gives colourless crystals which melt at -88.4°C . It is readily soluble in water, forming the aqueous acid, which when saturated at 0°C . has a specific gravity of 1.78. When boiled, the aqueous acid loses either acid or water until a solution of constant boiling point is obtained, containing 48% of the acid and boiling at 126°C . under atmospheric pressure; should the pressure, however, vary, the strength of the solution boiling at a constant temperature varies also. Hydrobromic acid is one of the "strong" acids, being ionized to a very large extent even in concentrated solution, as shown by the molecular conductivity increasing by only a small amount over a wide range of dilution.

Bromides.—Hydrobromic acid reacts with metallic oxides, hydrides and carbonates to form bromides, which can in many cases be obtained also by the direct union of the metals with bromine. As a class, the metallic bromides are solids at ordinary temperatures, which fuse readily and volatilize on heating. The majority are soluble in water, the chief exceptions being silver bromide, mercurous bromide, palladium bromide and lead bromide; the last is, however, soluble in hot water. They are decomposed by chlorine, with liberation of bromine and formation of metallic chlorides; concentrated sulphuric acid also decomposes them, with formation of a metallic sulphate and liberation of bromine and sulphur dioxide. The non-metallic bromides are usually liquids, which are readily decomposed by water. Hydrobromic acid and its salts can be readily detected by the addition of chlorine water to their aqueous solutions, when bromine is liberated; or by warming with concentrated sulphuric acid and manganese dioxide, the same result being obtained. Silver nitrate in the presence of nitric acid gives with bromides a pale yellow precipitate of silver bromide, AgBr , which is sparingly soluble in ammonia. For their quantitative

determination they are precipitated in nitric acid solution by means of silver nitrate, and the silver bromide well washed, dried and weighed.

No oxides of bromine have as yet been isolated, but three oxy-acids are known, namely hypobromous acid, HBrO , bromous acid, HBrO_2 , and bromic acid, HBrO_3 . Hypobromous acid is obtained by shaking together bromine water and precipitated mercuric oxide, followed by distillation of the dilute solution *in vacuo* at low temperature (about 40°C .). It is a very unstable compound, breaking up, on heating, into bromine and oxygen. The aqueous solution is light yellow in colour, and possesses strong bleaching properties. Bromous acid is formed by adding bromine to a saturated solution of silver nitrate (A. H. Richards, *J. Soc. Chem. Ind.*, 1906, 25, p. 4). Bromic acid is obtained by the addition of the calculated amount of sulphuric acid (previously diluted with water) to the barium salt; by the action of bromine on the silver salt, in the presence of water, $5\text{AgBrO}_2 + 3\text{Br}_2 + 3\text{H}_2\text{O} = 5\text{AgBr} + 6\text{HBrO}_3$; or by passing chlorine through a solution of bromine in water. The acid is only known in the form of its aqueous solution; this is, however, very unstable, decomposing on being heated to 100°C . into water, oxygen and bromine. By reducing agents such, for example, as sulphuretted hydrogen and sulphur-dioxide, it is rapidly converted into hydrobromic acid. Hydrobromic acid decomposes it according to the equation $\text{HBrO}_3 + 5\text{HBr} = 3\text{H}_2\text{O} + 3\text{Br}_2$. Its salts are known as bromates, and are as a general rule difficultly soluble in water, and decomposed by heat, with evolution of oxygen.

Applications.—The salts of bromine are widely used in photography, especially bromide of silver. For antiseptic purposes it has been prepared as "bromum solidificatum" which consists of kieselguhr or similar substance impregnated with about 75% of its weight of bromine. In medicine it is largely employed in the form of bromides of potassium, sodium and ammonium, as well as in combination with alkaloids and other substances.

Medicinal Use.—Bromide of potassium is the safest and most generally applicable sedative of the nervous system. Whilst very weak, its action is perfectly balanced throughout all nervous tissue, so much so that Sir Thomas Lauder Brunton has suggested its action to be due to its replacement of sodium chloride (common salt) in the fluids of the nervous system. Hence bromide of potassium—or bromide of sodium, which is possibly somewhat safer still though not quite so certain in its action—is used as a hypnotic, as the standard anaphrodisiac, as a sedative in mania and all forms of morbid mental excitement, and in hyperaesthesia of all kinds. Its most striking success is in epilepsy, for which it is the specific remedy. It may be given in doses of from ten to fifty grains or more, and may be continued without ill effect for long periods in grave cases of epilepsy (*grand mal*). Of the three bromides in common use the potassium salt is the most rapid and certain in its action, but may depress the heart in morbid states of that organ; in such cases the sodium salt—of which the base is inert—may be employed. In whooping-cough, when a sedative is required but a stimulant is also indicated, ammonium bromide is often invaluable. The conditions in which bromides are most frequently used are insomnia, epilepsy, whooping-cough, delirium tremens, asthma, migraine, laryngismus stridulus, the symptoms often attendant upon the climacteric in women, hysteria, neuralgia, certain nervous disorders of the heart, strychnine poisoning, nymphomania and spermatorrhoea. Hydrobromic acid is often used to relieve or prevent the headache and ringing in the ears that may follow the administration of quinine and of salicylic acid or salicylates.

BROMLEY, SIR THOMAS (1530-1587), English lord chancellor, was born in Staffordshire in 1530. He was educated at Oxford University and called to the bar at the Middle Temple. Through family influence as well as the patronage of Sir Nicholas Bacon, the lord keeper, he quickly made progress in his profession. In 1566 he was appointed recorder of London, and in 1569 he became solicitor-general. He sat in parliament successively for Bridgnorth, Wigan and Guildford. On the death of Sir Nicholas Bacon in 1579 he was appointed lord chancellor. As an equity judge he showed great and profound knowledge, and his judgment in Shelley's case (*q.v.*) is a landmark in the history of English real property law. He presided over the commission which tried Mary, queen of Scots, in 1586, but the strain of the trial, coupled with the responsibility which her execution involved upon him, proved too much for his strength, and he died on the 12th of April 1587. He was buried in Westminster Abbey.

See Foss, *Lives of the Judges*; Campbell, *Lives of the Lord Chancellors*.

BROMLEY, a municipal borough in the Sevenoaks parliamentary division of Kent, England, 10½ m. S.E. by S. of London by the South Eastern & Chatham railway. Pop. (1901) 27,354. It lies on high ground north of the small river Ravensbourne, in a well-wooded district, and has become a favourite residential locality for those whose business lies in London. The former palace of the bishops of Rochester was erected in 1777 in room

of an older structure. The manor belonged to this see as early as the reign of Ethelbert. In the gardens is a chalybeate spring known as St Blaize's Well, which was in high repute before the Reformation. The church of St Peter and St Paul, mainly Perpendicular, retains a Norman font and other remains of an earlier building. Here is the gravestone of the wife of Dr Johnson. Bromley College, founded by Bishop Warner in 1666 for "twenty poor widows of loyal and orthodox clergymen," has been much enlarged, and forty widows are in receipt of support. Sheppard College (1840) is an affiliated foundation for unmarried daughters of these widows. In the vicinity of Bromley, Bickley is a similar residential township, Hayes Common is a favourite place of excursion, and at Holwood Hill near Keston are remains of a large encampment known as Caesar's Camp. Bromley was incorporated in 1903, and is governed by a mayor, 6 aldermen and 18 councillors. Area, 4703 acres.

BROMLITE, a member of the aragonite group of minerals. It consists of an isomorphous mixture of calcium and barium carbonates in various proportions, (Ca, Ba) CO₃, and thus

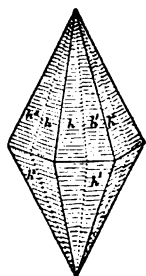

differs chemically from barytocalcite (*q.v.*) which is a double salt of these carbonates in equal molecular proportions. Being isomorphous with aragonite, it crystallizes in the orthorhombic system, but simple crystals are not known. The crystals are invariably complex twins, and have the form of doubly terminated pseudo-hexagonal pyramids, like those of witherite but more acute; the faces are horizontally striated and are divided down their centre by a twinning, as represented in the adjoining figure. The examination in polarized light of a transverse section shows that each compound crystal is built up of six differently orientated individuals arranged in twelve segments.

The crystals are translucent and white, sometimes with a shade of pink. Sp. gr. 3.706; hardness 4-4½. The mineral has been found at only two localities, both of which are in the north of England. At the Fallowfield lead mine, near Hexham in Northumberland, it is associated with witherite; and at Bromley Hill, near Alston in Cumberland, it occurs in veins with galena. The species was named bromlite by T. Thomson in 1837, and also named by A. Breithaupt in 1841, both of which names, derived from the locality, have been in common use. (L. J. S.)

BROMPTON, a western district of London; England, in the south-east of the metropolitan borough of Kensington. Brompton Road, leading south-west from Knightsbridge, is continued as Old Brompton Road and Richmond Road, to join Lillie Road, at which point are the District and West London railway stations of West Brompton. The Oratory of St Philip Neri, commonly called Brompton Oratory, close by the Victoria and Albert Museum, the Brompton consumption hospital and the West London or Brompton cemetery are included in this district, which is mainly occupied by residences of the better class. (See KENSINGTON.)

BROMSGROVE, a market town in the Eastern parliamentary division of Worcestershire, England, 12 m. N.N.E. of Worcester, with a station 1 m. from the town on the Bristol-Birmingham line of the Midland railway. Pop. of urban district (1901) 8418. It lies in a pleasant undulating district near the foot of the Lickey Hills, to surmount which the railway towards Birmingham here ascends for 2 m. one of the steepest gradients in England over such a distance. There remain several picturesque half-timbered houses, dating from 1572 and later. The church of St John is a fine building, Perpendicular and earlier in date, picturesquely placed on an elevation above the town, with a lofty tower and spire. There are a well-known grammar-school, founded by Edward VI., with university scholarships; a college school, a literary institute, and a school of art. Birmingham Sanatorium stands in the parish. Cloth was formerly a staple of trade, but manufactures of nails and buttons are now pre-eminent, while the river Salwarpe works a number of mills

in the neighbourhood, and near the town are carriage works belonging to the Midland railway.

BRONCHIECTASIS (Gr. *βρόγχια*, bronchial tubes, and *ektasis*, extension), dilatation of the bronchi, a condition occurring in connexion with many diseases of the lungs. Bronchitis both acute and chronic, chronic pneumonia and phthisis; acute pneumonia and broncho-pneumonia, may all leave after them a bronchiectasis whose position is determined by the primary lesion. Other causes, acting mechanically, are tracheal and bronchial obstruction, as from the pressure of an aneurism, new growth, &c. It used to be considered a disease of middle age, but of late years Dr Walter Carr has shown that the condition is a fairly common one among debilitated children after measles, whooping cough, &c. The dilatation is commonly cylindrical, more rarely saccular, and it is the medium and smaller sized tubes that are generally affected, except where the cause is mechanical. The affection is usually of one lung only. Emphysema is a very common accompaniment. Though at first the symptoms somewhat resemble those of bronchitis, later they are quite distinctive. Cough is very markedly paroxysmal in character, and though severe is intermittent, the patient being entirely free for many hours at the time. The effect of posture is very marked. If the patient lie on the affected side, he may be free from cough the whole night, but if he turn to the sound side, or if he rises and bends forward, he brings up large quantities of bronchial secretion. The expectoration is characterized by its abundance and manner of expulsion. Where the dilatation is of the saccular variety, it may come up in such quantities and with so much suddenness as to gush from the mouth. It is very commonly foetid, as it is retained and decomposed *in situ*. Dyspnoea and hæmoptysis occasionally occur, but are by no means the rule. If pyrexia is present, it is a serious symptom, as it is a sign of septic absorption in the bronchi, and may be the forerunner of gangrene. If gangrene does set in, it will be accompanied by severe attacks of shivering and sweating. Where the disease has lasted long clubbing of fingers and toes is very common. The diagnosis from putrid bronchitis is usually fairly easily made, but at times it may be a matter of extreme difficulty to distinguish between this condition and a tuberculous cavity in the lung. Nothing can be done directly to cure this disease, but the patient's condition can be greatly alleviated. Creosote vapour baths are eminently satisfactory. A mechanical treatment much recommended by some of the German physicians is that of forced expiration.

BRONCHITIS, the name given to inflammation of the mucous membrane of the bronchial tubes (see RESPIRATORY SYSTEM: Pathology). Two main varieties are described, specific and non-specific bronchitis. The bronchitis which occurs in infectious or specific disorders, as diphtheria, influenza, measles, pneumonia, &c., due to the micro-organisms observed in these diseases, is known as specific; whereas that which results from extension from above, or from chemical or mechanical irritation, is known as non-specific. It is convenient to describe it, however, under the chemical divisions of *acute* and *chronic* bronchitis.

Acute bronchitis, like other inflammatory affections of the chest, generally arises as the result of exposure to cold, particularly if accompanied with damp, or of sudden change from a heated to a cool atmosphere. The symptoms vary according to the severity of the attack, and more especially according to the extent to which the inflammatory action spreads in the bronchial tubes. The disease usually manifests itself at first in the form of a catarrh, or common cold; but the accompanying feverishness and general constitutional disturbance proclaim the attack to be somewhat more severe, and symptoms denoting the onset of bronchitis soon present themselves. A short, painful, dry cough, accompanied with rapid and wheezing respiration, a feeling of rawness and pain in the throat and behind the breast bone, and of oppression or tightness throughout the chest, mark the early stages of the disease. In some cases, from the first, symptoms of the form of asthma (*q.v.*) known as the *bronchic* are superadded, and greatly aggravate the patient's suffering.

After a few days expectoration begins to come with the cough, at first scanty and viscid or frothy, but soon becoming copious and of purulent character. In general, after free expectoration has been established the more urgent and painful symptoms abate; and while the cough may persist for a length of time, often extending to three or four weeks, in the majority of instances convalescence advances, and the patient is ultimately restored to health, although there is not infrequently left a tendency to a recurrence of the disease on exposure to its exciting causes.

When the ear or the stethoscope is applied to the chest of a person suffering from such an attack as that now described, there are heard in the earlier stages snoring or cooing sounds, mixed up with others of wheezing or fine whistling quality, accompanying respiration. These are denominated dry sounds, and they are occasionally so abundant and distinct, as to convey their vibrations to the hand applied to the chest, as well as to be audible to a bystander at some distance. As the disease progresses these sounds become to a large extent replaced by others of crackling or bubbling character, which are termed moist sounds or râles. Both these kinds of abnormal sounds are readily explained by a reference to the pathological condition of the parts. One of the first effects of inflammation upon the bronchial mucous membrane is to cause some degree of swelling, which, together with the presence of a tough secretion closely adhering to it, tends to diminish the calibre of the tubes. The respired air as it passes over this surface gives rise to the dry or sonorous breath sounds, the coarser being generated in the large, and the finer or wheezing sounds in the small divisions of the bronchi. Before long, however, the discharge from the bronchial mucous membrane becomes more abundant and less glutinous, and accumulates in the tubes till dislodged by coughing. The respired air, as it passes through this fluid, causes the moist râles above described. In most instances both moist and dry sounds are heard abundantly in the same case, since different portions of the bronchial tubes are affected at different times in the course of the disease.

Such are briefly the main characteristics presented by an ordinary attack of acute bronchitis running a favourable course. The case is, however, very different when the inflammation spreads into, or when it primarily affects, the minute ramifications of the bronchial tubes which are in immediate relation to the air-cells of the lungs, giving rise to that form of the disease known as *capillary bronchitis* or *broncho-pneumonia* (see **RESPIRATORY SYSTEM: Pathology; and PNEUMONIA**). When this takes place all the symptoms already detailed become greatly intensified, and the patient's life is placed in imminent peril in consequence of the interruption to the entrance of air into the lungs, and thus to the due aeration of the blood. The feverishness and restlessness increase, the cough becomes incessant, the respiration extremely rapid and laboured, the nostrils dilating with each effort, and evidence of impending suffocation appears. The surface of the body is pale or dusky, the lips are livid, while breathing becomes increasingly difficult, and is attended with suffocative paroxysms which render the recumbent posture impossible. Unless speedy relief is obtained by successful efforts to clear the chest by coughing and expectoration, the patient's strength gives way, somnolence and delirium set in and death ensues. All this may be brought about in the space of a few days, and such cases, particularly among the very young, sometimes prove fatal within forty-eight hours.

Acute bronchitis must at all times be looked upon as a severe and even serious ailment, but there are certain circumstances under which its occurrence is a matter of special anxiety to the physician. It is pre-eminently dangerous at the extremes of life, and mortality statistics show it to be one of the most fatal of the diseases of those periods. This is to be explained not only by the well-recognized fact that all acute diseases tell with great severity on the feeble frames alike of infants and aged people, but more particularly by the tendency which bronchitis undoubtedly has in attacking them to assume the capillary form, and when it does so to prove quickly fatal. The importance, therefore,

of early attention to the slightest evidence of bronchitis among the very young or the aged can scarcely be overrated.

Bronchitis is also apt to be very severe when it occurs in persons who are addicted to intemperance. Again, in those who suffer from any disease affecting directly or indirectly the respiratory functions, such as consumption or heart disease, the supervention of an attack of acute bronchitis is an alarming complication, increasing, as it necessarily does, the embarrassment of breathing. The same remark is applicable to those numerous instances of its occurrence in children who are or have been suffering from such diseases as have always associated with them a certain degree of bronchial irritation, such as measles and whooping-cough.

One other source of danger of a special character in bronchitis remains to be mentioned, viz. collapse of the lung. Occasionally a branch of a bronchial tube becomes plugged up with secretion, so that the area of the lung to which this branch conducts ceases to be inflated on inspiration. The small quantity of air imprisoned in the portion of lung gradually escapes, but no fresh air enters, and the part collapses and becomes of solid consistence. Increased difficulty of breathing is the result, and where a large portion of lung is affected by the plugging up of a large bronchus, a fatal result may rapidly follow, the danger being specially great in the case of children. Fortunately, the obstruction may sometimes be removed by vigorous coughing, and relief is then obtained.

With respect to the treatment of acute bronchitis, in those mild cases which are more of the nature of a simple catarrh, little else will be found necessary than confinement in a warm room, or in bed, for a few days, and the use of light diet, together with warm diluent drinks. Additional measures are however called for when the disease is more markedly developed. Medicines to allay fever and promote perspiration are highly serviceable in the earlier stages. Later, with the view of soothing the pain of the cough, and favouring expectoration, mixtures of tolu, with the addition of some opiate, such as the ordinary paregorics, may be advantageously employed. The use of opium, however, in any form should not be resorted to in the case of young children without medical advice, since its action on them is much more potent and less under control than it is in adults. Not a few of the so-called "soothing mixtures" have been found to contain opium in quantity sufficient to prove dangerous when administered to children, and caution is necessary in using them.

From the outset of the attack the employment of fomentations, or especially a turpentine stupe, gives great relief, and occasionally in the non-specific form this treatment, combined with a good dose of calomel and salts, may render the attack abortive. Some relief is always obtained by inhalations, and theoretically, an acute specific bronchitis should be successfully treated by inhalation of antiseptic and soothing remedies. In practice, however, it is found that the strength cannot be sufficiently strong to destroy the bacteria in the bronchial tubes. However, much relief is obtained from the use of steam atomizers filled with an aqueous solution of compound tincture of benzoin, creosote or guaiacol. A still more practicable means of introducing volatile antiseptic oils is the globe nebulizer, which throws oleaginous solutions in the form of a fine fog, that can be deeply inhaled. Menthol, eucalyptol and white pine extract are some of the remedies that may be tried dissolved in benzoinol, to which cocaine or opium may be added if the cough is troublesome.

When the bronchitis is of the capillary form, the great object is to maintain the patient's strength, and to endeavour to secure the expulsion of the morbid secretion from the fine bronchi. In addition to the remedies already alluded to, stimulants are called for from the first; and should the cough be ineffectual in relieving the bronchial tubes, the administration of an emetic dose of sulphate of zinc may produce a good effect.

During the whole course of any attack of bronchitis attention must be paid to the due nourishment of the patient; and during the subsequent convalescence, which, particularly in elderly persons, is apt to be slow, tonics and stimulants may have to be prescribed.

Chronic bronchitis may arise as the result of repeated attacks of the acute form, or it may exist altogether independently. It occurs more frequently among persons advanced in life than among the young, although no age is exempt from it. The usual history of this form of bronchitis is that of a cough recurring during the colder seasons of the year, and in its earlier stages, departing entirely in summer, so that it is frequently called "winter cough." In many persons subject to it, however, attacks are apt to be excited at any time by very slight causes, such as changes in the weather; and in advanced cases of the disease the cough is seldom altogether absent. The symptoms and auscultatory signs of chronic bronchitis are on the whole similar to those pertaining to the acute form, except that the febrile disturbance and pain are much less marked. The cough is usually more troublesome in the morning than during the day. There is usually free and copious expectoration, and occasionally this is so abundant as to constitute what is termed *bronchorrhoea*.

Chronic bronchitis leads to alterations of structure in the affected bronchial tubes, their mucous membrane becoming thickened or even ulcerated, while occasionally permanent dilatation of the bronchi takes place, often accompanied with profuse foetid expectoration. In long-standing cases of chronic bronchitis the nutrition of the lungs becomes impaired, and dilatation of the air-tubes (*emphysema*) and other complications result, giving rise to more or less constant breathlessness.

Chronic bronchitis may arise secondarily to some other ailment. This is especially the case in Bright's disease of the kidneys and in heart disease, of both of which maladies it often proves a serious complication, also in gout and syphilis. The influence of occupation is seen in the frequency in which persons following certain employments suffer from chronic bronchitis. Hirt has shown that the inhalation of vegetable dust is very liable to produce bronchitis through the irritation produced by the dust particles and the growth of organisms carried in with the dust. Consequently, millers and grain-shovelers are especially liable to it, while next in order come weavers and workers in cotton factories.

The treatment to be adopted in chronic bronchitis depends upon the severity of the case, the age of the patient and the presence or absence of complications. Attention to the general health is a matter of prime importance in all cases of the disease, more particularly among persons whose avocations entail exposure, and tonics with cod-liver oil will be found highly advantageous. The use of a respirator in very cold or damp weather is a valuable means of protection. In those aggravated forms of chronic bronchitis, where the slightest exposure to cold air brings on fresh attacks, it may become necessary, where circumstances permit, to enjoin confinement to a warm room or removal to a more genial climate during the winter months.

BRONCHOTOMY (Gr. *βρόγχος*, wind-pipe, and *τέμνω*, to cut), a medical term used to describe a surgical incision into the throat; now largely superseded by the terms laryngotomy, thyrotomy and tracheotomy, which indicate more accurately the place of incision.

BRONCO, usually incorrectly spelt *BRONCHO* (a Spanish word meaning rough, rude), an unbroken or untamed horse, especially in the United States, a mustang; the word entered America by way of Mexico.

BRÖNDSTED, PETER OLUF (1780-1842), Danish archaeologist and traveller, was born at Fruring in Jutland on the 17th of November 1780. After studying at the university of Copenhagen he visited Paris in 1806 with his friend Georg Koes. After remaining there two years, they went together to Italy. Both were zealously attached to the study of antiquities; and congeniality of tastes and pursuits induced them, in 1810, to join an expedition to Greece, where they excavated the temples of Zeus in Aegina and of Apollo at Bassae in Arcadia. After three years of active researches in Greece, Bröndsted returned to Copenhagen, where, as a reward for his labours, he was appointed professor of Greek in the university. He then began to arrange and prepare for publication the vast materials he had collected during his travels; but finding that Copenhagen

did not afford him the desired facilities, he exchanged his professorship for the office of Danish envoy at the papal court in 1818, and took up his abode at Rome. In 1820 and 1821 he visited Sicily and the Ionian Isles to collect additional materials for his great work. In 1826 he went to London, chiefly with a view of studying the Elgin marbles and other remains of antiquity in the British Museum, and became acquainted with the principal archaeologists of England. From 1828-1832 he resided in Paris, to superintend the publication of his *Travels*, and then returned to Copenhagen on being appointed director of the museum of antiquities and the collection of coins and medals. In 1842 he became rector of the university; but a fall from his horse caused his death on the 26th of June. His principal work was the *Travels and Archaeological Researches in Greece* (in German and French, 1826-1830), of which only two volumes were published, dealing with the island of Ceos and the metopes of the Parthenon.

BRONGNIART, ADOLPHE THÉODORE (1801-1876), French botanist, son of the geologist Alexandre Brongniart, was born in Paris on the 14th of January 1801. He soon showed an inclination towards the study of natural science, devoting himself at first more particularly to geology, and later to botany, thus equipping himself for what was to be the main occupation of his life—the investigation of fossil plants. In 1826 he graduated as doctor of medicine with a dissertation on the *Rhamnaceae*; but the career which he adopted was botanical, not medical. In 1831 he became assistant to R. L. Desfontaines at the *Musée d'Histoire Naturelle*, and two years later succeeded him as professor, a position which he continued to hold until his death in Paris on the 18th of February 1876.

Brongniart was an indefatigable investigator and a prolific writer, so that he left behind him, as the fruit of his labours, a large number of books and memoirs. As early as 1822 he published a paper on the classification and distribution of fossil plants (*Mém. Mus. Hist. Nat.* viii.). This was followed by several papers chiefly bearing upon the relation between extinct and existing forms—a line of research which culminated in the publication of the *Histoire des végétaux fossiles*, which has earned for him the title of "father of palaeobotany." This great work was heralded by a small but most important "Prodrome" (contributed to the *Grand Dictionnaire d'Hist. Nat.*, 1828, t. lvii.) which brought order into chaos by a classification in which the fossil plants were arranged, with remarkably correct insight, along with their nearest living allies, and which forms the basis of all subsequent progress in this direction. It is of especial botanical interest, because, in accordance with Robert Brown's discoveries, the *Cycadeae* and *Coniferae* were placed in the new group *Phanerogames gymnospermes*. In this book attention was also directed to the succession of forms in the various geological periods, with the important result (stated in modern terms) that in the Palaeozoic period the Pteridophyta are found to predominate; in the Mesozoic, the Gymnosperms; in the Cainozoic, the Angiosperms, a result subsequently more fully stated in his "Tableau des genres de végétaux fossiles" (*D'Orbigny, Dict. Univ. d'Hist. Nat.*, 1849). But the great *Histoire* itself was not destined to be more than a colossal fragment; the publication of successive parts proceeded regularly from 1828 to 1837, when the first volume was completed, but after that only three parts of the second volume appeared. Brongniart, no doubt, was overwhelmed with the continually increasing magnitude of the task that he had undertaken. Apart from his more comprehensive works, his most important palaeontological contributions are perhaps his observations on the structure of *Sigillaria* (*Arch. Mus. Hist. Nat.* i., 1839) and his researches (almost the last he undertook) on fossil seeds, of which a full account was published posthumously in 1880. His activity was by no means confined to palaeobotany, but extended into all branches of botany, more particularly anatomy and phanerogamic taxonomy. Among his achievements in these directions the most notable is the memoir "Sur la génération et le développement de l'embryon des Phanérogames" (*Ann. Sci. Nat.* xii., 1827). This is remarkable in that it contains the

first account of any value of the development of the pollen; as also a description of the structure of the pollen-grain, the confirmation of G. B. Amici's (1823) discovery of the pollen-tube, the confirmation of R. Brown's views as to the structure of the unimpregnated ovule (with the introduction of the term "sac embryonnaire"); and in that it shows how nearly Brongniart anticipated Amici's subsequent (1846) discovery of the entrance of the pollen-tube into the micropyle, fertilizing the female cell which then develops into the embryo. Of his anatomical works, those of the greatest value are probably the "Recherches sur la structure et les fonctions des feuilles" (*Ann. Sci. Nat.* xxi., 1830), and the "Nouvelles Recherches sur l'Épiderme" (*Ann. Sci. Nat.* l., 1834), in which, among other important observations, the discovery of the cuticle is recorded; and, further, the "Recherches sur l'organisation des tiges des Cycadées" (*Ann. Sci. Nat.* xvi., 1829), giving the results of the first investigation of the anatomy of those plants. His systematic work is represented by a large number of papers and monographs, many of which relate to the flora of New Caledonia; and by his *Énumération des genres de plantes cultivées au Musée d'Histoire Naturelle de Paris* (1843), which is an interesting landmark in the history of classification in that it forms the starting-point of the system, modified successively by A. Braun, A. W. Eichler and A. Engler, which is now adopted in Germany. In addition to his scientific and professorial labours, Brongniart held various important official posts in connexion with the department of education, and interested himself greatly in agricultural and horticultural matters. With J. V. Audouin and J. B. A. Dumas, his future brothers-in-law, he established the *Annales des Sciences Naturelles* in 1824; he also founded the *Société Botanique de France* in 1854, and was its first president.

For accounts of his life and work see *Bull. de la Soc. Géol. de France*, 1876, and *La Nature*, 1876; the *Bulletin de la Soc. Bot. de France* for 1876, vol. xxiii., contains a list of his works and the orations pronounced at his funeral. (S. H. V.)

BRONGNIART, ALEXANDRE (1770-1847), French mineralogist and geologist, son of the eminent architect who designed the Bourse and other public buildings of Paris, was born in that city on the 5th of February 1770. At an early age he studied chemistry, under Lavoisier, and after passing through the *École des Mines* he took honours at the *École de Médecine*; subsequently he joined the army of the Pyrenees as *pharmacien*; but having committed some slight political offence, he was thrown into prison and detained there for some time. Soon after his release he was appointed professor of natural history in the *Collège des Quatre Nations*. In 1800 he was made director of the Sèvres porcelain factory, a post which he retained to his death, and in which he achieved his greatest work. In his hands Sèvres became the leading porcelain factory in Europe, and the researches of an able band of assistants enabled him to lay the foundations of ceramic chemistry. In addition to his work at Sèvres, quite enough to engross the entire energy of any ordinary man, he continued his more purely scientific work. He succeeded Hatty as professor of mineralogy in the *Museum of Natural History*; but he did not confine himself to mineralogy, for it is to him that we owe the division of Reptiles into the four orders of Saurians, Batrachians, Chelonians and Ophidians. Fossil as well as living animals engaged his attention, and in his studies of the strata around Paris he was instrumental in establishing the Tertiary formations. In 1816 he was elected to the *Academy*; and in the following year he visited the Alps of Switzerland and Italy, and afterwards Sweden and Norway. The result of his observations was published from time to time in the *Journal des Mines* and other scientific journals. Wide as was the range of his interests his most famous work was accomplished at Sèvres, and his most enduring monument is his classic *Traité des arts céramiques* (1844). He died in Paris on the 7th of October 1847.

His other principal works are:—*Traité élémentaire de minéralogie, avec des applications aux arts* (2 vols., Paris, 1807); *Histoire naturelle des crustacés fossiles* (Paris, 1822); *Classification et caractères minéralogiques des roches homogènes et hétérogènes* (Paris, 1827); the *Tableaux des terrains qui composent l'écorce du globe, ou Essai sur*

la structure de la partie connue de la terre (Paris, 1829); and the *Traité des arts céramiques* (1844). Brongniart was also the coadjutor of Cuvier in the admirable *Essai sur la géographie minéralogique des environs de Paris* (Paris, 1811); originally published in *Ann. Mus. Hist. Nat.* (Paris, xi., 1808).

BRONN, HEINRICH GEORG (1800-1862), German geologist, was born on the 3rd of March 1800 at Ziegelhausen near Heidelberg. Studying at the university at Heidelberg he took his doctor's degree in the faculty of medicine in 1821, and in the following year was appointed professor of natural history. He now devoted himself to palaeontological studies, and to field-work in various parts of Germany, Italy and France. From its commencement in 1830 to 1862 he assisted in editing the *Jahrbuch für Mineralogie, &c.*, continued as *Neues Jahrbuch*. His principal work, *Lehreo Geognostica* (2 vols., Stuttgart, 1834-1838; 3rd ed. with F. Römer, 3 vols., 1851-1856), has been regarded as one of the foundations of German stratigraphical geology. His *Handbuch einer Geschichte der Natur*, of which the first part was issued in 1841, gave a general account of the physical history of the earth, while the second part dealt with the life-history, species being regarded as direct acts of creation. The third part included his famous *Index Palaeontologicus*, and was issued in 3 vols., 1848-1849, with the assistance of H. von Meyer and H. R. Göppert. This record of fossils has proved of inestimable value to all palaeontologists. An important work on recent and fossil zoology, *Die Klassen und Ordnungen des Thier-Reichs*, was commenced by Bronn. He wrote the volumes dealing with Amorphozoa, Actinozoa, and Malacozoa, published 1859-1862; the work was continued by other naturalists. In 1861 Bronn was awarded the Wollaston medal by the Geological Society of London. He died at Heidelberg on the 5th of July 1862.

BRONSART VON SCHELLENDORF, PAUL (1832-1891), Prussian general, was born at Danzig in 1832. He entered the Prussian Guards in 1849, and was appointed to the general staff in 1861 as a captain; after three years of staff service he returned to regimental duty, but was soon reappointed to the staff, and lectured at the war academy, becoming major in 1865 and lieutenant-colonel in 1869. During the war of 1870 he was chief of a section on the Great General Staff, and conducted the preliminary negotiations for the surrender of the French at Sedan. After the war Bronsart was made a colonel and chief of staff of the Guard army corps, becoming major-general in 1876 and lieutenant-general (with a division command) in 1881. Two years later he became war minister, and during his tenure of the post (1883-1889) many important reforms were carried out in the Prussian army, in particular the introduction of the magazine rifle. He was appointed in 1889 to command the I. army corps at Königsberg. He died on the 23rd of June 1891 at his estate near Braunsberg. Bronsart's military writings include two works of great importance—*Ein Rückblick auf die taktischen Rückblicke* (2nd ed., Berlin, 1870), a pamphlet written in reply to Captain May's *Tactical Retrospect of 1866*; and *Der Dienst des Generalstabes* (1st ed., Berlin, 1876; 3rd ed. revised by General Meckel, 1893; new ed. by the author's son, Major Bronsart von Schellendorf, Berlin, 1904, a comprehensive treatise on the duties of the general staff. The third edition of this work was soon after its publication translated into English and issued officially to the British army as *The Duties of the General Staff*. Major Bronsart's new edition of 1904 was reissued in English by the General Staff, under the same title, in 1905.

BRONTÉ, CHARLOTTE (1816-1855), **EMILY** (1818-1848), and **ANNE** (1820-1849), English novelists, were three of the six children of Patrick Brontë, a clergyman of the Church of England, who for the last forty-one years of his life was perpetual incumbent of the parish of Haworth in the West Riding of Yorkshire. Patrick Brontë was born at Embsdale, Co. Down, Ireland, on the 17th of March 1777. His parents were of the peasant class, their original name of Brunty apparently having been changed by their son on his entry at St John's College, Cambridge, in 1802. In the intervening years he had been successively a weaver and schoolmaster in his native country. From Cambridge

he became a curate, first at Wethersfield in Essex, in 1806, then for a few months at Wellington, Salop, in 1809. At the end of 1809 he accepted a curacy at Dewsbury, Yorkshire, following up this by one at Hartshead-cum-Clifton in the same county. At Hartshead Patrick Brontë married in 1812 Maria Branwell, a Cornishwoman, and there two children were born to him, Maria (1813-1825) and Elizabeth (1814-1825). Thence Patrick Brontë removed to Thornton, some 3 m. from Bradford, and here his wife gave birth to four children, Charlotte, Patrick Branwell (1817-1848), Emily Jane, and Anne, three of whom were to attain literary distinction.

In April 1820, three months after the birth of Anne Brontë, her father accepted the living of Haworth, a village near Keighley in Yorkshire, which will always be associated with the romantic story of the Brontës. In September of the following year his wife died. Maria Brontë lives for us in her daughter's biography only as the writer of certain letters to her "dear saucy Pat," as she calls her lover, and as the author of a recently published manuscript, an essay entitled *The Advantages of Poverty in Religious Concerns*, full of a sentimentousness much affected at the time.

Upon the death of Mrs Brontë her husband invited his sister-in-law, Elizabeth Branwell, to leave Penzance and to take up her residence with his family at Haworth. Miss Branwell accepted the trust and would seem to have watched over her nephew and five nieces with conscientious care. The two eldest of those nieces were not long in following their mother. Maria and Elizabeth, Charlotte and Emily, were all sent to the Clergy Daughters' school at Cowan Bridge in 1824, and Maria and Elizabeth returned home in the following year to die. How far the bad food and drastic discipline were responsible cannot be accurately demonstrated. Charlotte gibbeted the school long years afterwards in *Jane Eyre*, under the thin disguise of "Lowood," and the principal, the Rev. William Carus Wilson (1792-1859), has been universally accepted as the counterpart of Mr Naomi Brocklehurst in the same novel. But congenital disease more probably accounts for the tragedy from which happily Charlotte and Emily escaped, both returning in 1825 to a prolonged home life at Haworth. Here the four surviving children amused themselves in intervals of study under their aunt's guidance with precocious literary aspirations. The many tiny booklets upon which they laboured in the succeeding years have been happily preserved. We find stories, verses and essays, all in the minutest handwriting, none giving any indication of the genius which in the case of two of the four children was to add to the indisputably permanent in literature.

At sixteen years of age—in 1831—Charlotte Brontë became a pupil at the school of Miss Margaret Wooler (1792-1885) at Roe Head, Dewsbury. She left in the following year to assist in the education of the younger sisters, bringing with her much additional proficiency in drawing, French and composition; she took with her also the devoted friendship of two out of her ten fellow-pupils—Mary Taylor (1817-1893) and Ellen Nussey (1817-1897). With Miss Taylor and Miss Nussey she corresponded for the remainder of her life, and her letters to the latter make up no small part of what has been revealed to us of her life story. Her next three years at Haworth were varied by occasional visits to one or other of these friends. In 1835 she returned to Miss Wooler's school at Roe Head as a governess, her sister Emily accompanying her as a pupil, but remaining only three months, and Anne then taking her place. The year following the school was removed to Dewsbury. In 1838 Charlotte went back to Haworth and soon afterwards received her first offer of marriage—from a clergyman, Henry Nussey, the brother of her friend Ellen. This was followed a little later by a second offer from a curate named Bryce. She refused both and took a situation as nursery governess, first with the Sidgwicks of Stonegappe, Yorkshire, and later with the Whites at Rawdon in the same county. A few months of this, however, filled her with an ambition to try and secure greater independence as the possessor of a school of her own, and she planned to acquire more proficiency in "languages" on the continent, as a pre-

liminary step. The aunt advanced some money, and accompanied by her sister Emily she became in February 1842 a pupil at the Pensionnat Héger, Brussels. Here both girls worked hard, and won the goodwill and indeed admiration of the principal teacher, M. Héger, whose wife was at the head of the establishment. But the two girls were hastily called back to England before the year had expired by the announcement of the critical illness of their aunt. Miss Branwell died on the 29th of October 1842. She bequeathed sufficient money to her nieces to enable them to reconsider their plan of life. Instead of a school at Bridlington which had been talked of, they could now remain with their father, utilize their aunt's room as a classroom, and take pupils. But Charlotte was not yet satisfied with what the few months on Belgian soil had done for her, and determined to accept M. Héger's offer that she should return to Brussels as a governess. Hence the year 1843 was passed by her at the Pensionnat Héger in that capacity, and in this period she undoubtedly widened her intellectual sphere by reading the many books in French literature that her friend M. Héger lent her. But life took on a very sombre shade in the lonely environment in which she found herself. She became so depressed that on one occasion she took refuge in the confessional precisely as did her heroine Lucy Snowe in *Villette*. In 1844 she returned to her father's house at Haworth, and the three sisters began immediately to discuss the possibilities of converting the vicarage into a school. Prospectuses were issued, but no pupils were forthcoming.

Matters were complicated by the fact that the only brother, Patrick Branwell, had about this time become a confirmed drunkard. Branwell had been the idol of his aunt and of his sisters. Educated under his father's care, he had early shown artistic leanings, and the slender resources of the family had been strained to provide him with the means of entering at the Royal Academy as a pupil. This was in 1835. Branwell, it would seem, indulged in a glorious month of extravagance in London and then returned home. His art studies were continued for a time at Leeds, but it may be assumed that no commissions came to him, and at last he became tutor to the son of a Mr Postlethwaite at Barrow-in-Furness. Ten months later he was a booking-clerk at Sowerby Bridge station on the Leeds & Manchester railway, and later at Luddenden Foot. Then he became tutor in the family of a clergyman named Robinson at Thorp Green, where his sister Anne was governess. Finally he returned to Haworth to loaf at the village inn, shock his sisters by his excesses, and to fritter his life away in painful sottishness. He died in September 1848, having achieved nothing reputable, and having disappointed all the hopes that had been centred in him. "My poor father naturally thought more of his only son than of his daughters," is one of Charlotte's dreary comments on the tragedy. In early years he had himself written both prose and verse; and a foolish story invented long afterwards attributed to him some share in his sisters' novels, particularly in Emily Brontë's *Wuthering Heights*. But Charlotte distinctly tells us that her brother never knew that his sisters had published a line. He was too much under the effects of drink, too besotted and muddled in that last year or two of life, to have any share in their intellectual enthusiasms.

The literary life had, however, opened bravely for the three girls during those years. In 1846 a volume of verse appeared from the shop of Aylott & Jones of Paternoster Row: "*Poems*," by Currer, Ellis and Acton Bell," was on the title-page. These names disguised the identity of Charlotte, Emily and Anne Brontë. The venture cost the sisters about £50 in all, but only two copies were sold. There were nineteen poems by Charlotte, twenty-one by Emily, and the same number by Anne. A consensus of criticism has accepted the fact that Emily's verse alone revealed true poetic genius. This was unrecognized then except by her sister Charlotte. It is obvious now to all.

The failure of the poems did not deter the authors from further effort. They had each a novel to dispose of. Charlotte Brontë's was called *The Master*, which before it was sent off to London was retitled *The Professor*. Emily's story was entitled

Wuthering Heights, and Anne's *Agnès Gray*. All these stories travelled from publisher to publisher. At last *The Professor* reached the firm of Smith, Elder & Co., of Cornhill. The "reader" for that firm, R. Smith Williams (1800-1875), was impressed, as were also his employers. Charlotte Brontë received in August 1847 a letter informing her that whatever the merits of *The Professor*—and it was hinted that it lacked "varied interest"—it was too short for the three-volume form then counted imperative. The author was further told that a longer novel would be gladly considered. She replied in the same month with this longer novel, and *Jane Eyre* appeared in October 1847, to be wildly acclaimed on every hand, although enthusiasm was to receive a counterblast when more than a year later, in December 1848, Miss Rigby, afterwards Lady Eastlake (1809-1893), reviewed it in the *Quarterly*.

Meanwhile the novels of Emily and Anne had been accepted by T. C. Newby. They were published together in three volumes in December 1847, two months later than *Jane Eyre*, although the proof sheets had been passed by the authors before their sister's novel had been sent to the publishers. The dilatoriness of Mr Newby was followed up by considerable energy when he saw the possibility of the novels by Ellis and Acton Bell sailing on the wave of Currer Bell's popularity, and he would seem very quickly to have accepted another manuscript by Anne Brontë, for *The Tenant of Wildfell Hall* was published by Newby in three volumes in June 1848. It was Newby's clever efforts to persuade the public that the books he published were by the author of *Jane Eyre* that led Charlotte and Anne to visit London this summer and interview Charlotte's publishers in Cornhill with a view to establishing their separate identity. Soon after their return home Branwell died (the 24th of September 1848), and less than three months later Emily died also at Haworth (the 19th December 1848). Then Anne became ill and on the 24th of May 1849 Charlotte accompanied her to Scarborough in the hope that the sea air would revive her. Anne died there on the 28th of May, and was buried in Scarborough churchyard. Thus in exactly eight months Charlotte Brontë lost all the three companions of her youth, and returned to sustain her father, fast becoming blind, in the now desolate home at Haworth.

In the interval between the death of Branwell and of Emily, Charlotte had been engaged upon a new novel—*Shirley*. Two-thirds were written, but the story was then laid aside while its author was nursing her sister Anne. She completed the book after Anne's death, and it was published in October 1849. The following winter she visited London as the guest of her publisher, Mr George Smith, and was introduced to Thackeray, to whom she had dedicated *Jane Eyre*. The following year she repeated the visit, sat for her portrait to George Richmond, and was considerably lionized by a host of admirers. In August 1850 she visited the English lakes as the guest of Sir James Kay-Shuttleworth, and met Mrs Gaskell, Miss Martineau, Matthew Arnold and other interesting men and women. During this period her publishers assiduously lent her books, and her criticisms of them contained in many letters to Mr George Smith and Mr Smith Williams make very interesting reading. In 1851 she received a third offer of marriage, this time from Mr James Taylor, who was in the employment of her publishers. A visit to Miss Martineau at Ambleside and also to London to the Great Exhibition made up the events of this year. On her way home she visited Manchester and spent two days with Mrs Gaskell. During the year 1852 she worked hard with a new novel, *Villette*, which was published in January of 1853. In September of that year she received a visit from Mrs Gaskell at Haworth; in May 1854 she returned it, remaining three days at Manchester, and planning with her hostess the details of her marriage, for at this time she had promised to unite herself with her father's curate, Arthur Bell Nicholls (1817-1906), who had long been a pertinacious suitor for her hand but had been discouraged by Mr Brontë. The marriage took place in Haworth church on the 29th of June 1854, the ceremony being performed by the Rev. Sutcliffe Sowden, Miss Wooler and Miss Nussey acting as witnesses. The wedded pair spent their honeymoon in Ireland,

returning to Haworth, where they made their home with Mr Brontë, Mr Nicholls having pledged himself to continue in his position as curate to his father-in-law. After less than a year of married life, however, Charlotte Nicholls died of an illness incidental to childbirth, on the 31st of March 1855. She was buried in Haworth church by the side of her mother, Branwell and Emily. The father followed in 1861, and then her husband returned to Ireland, where he remained some years afterwards, dying in 1906.

The bare recital of the Brontë story can give no idea of its undying interest, its exceeding pathos. Their life as told by their biographer Mrs Gaskell is as interesting as any novel. Their achievement, however, will stand on its own merits. Anne Brontë's two novels, it is true, though constantly reprinted, survive principally through the exceeding vitality of the Brontë tradition. As a hymn writer she still has a place in most religious communities. Emily is great alike as a novelist and as a poet. Her "Old Stoic" and "Last Lines" are probably the finest achievement of poetry that any woman has given to English literature. Her novel *Wuthering Heights* stands alone as a monument of intensity owing nothing to tradition, nothing to the achievement of earlier writers. It was a thing apart, passionate, unforgettable, haunting in its grimness, its grey melancholy. Among women writers Emily Brontë has a sure and certain place for all time. As a poet or maker of verse Charlotte Brontë is undistinguished, but there are passages of pure poetry of great magnificence in her four novels, and particularly in *Villette*. The novels *Jane Eyre* and *Villette* will always command attention whatever the future of English fiction, by virtue of their intensity, their independence, their rough individuality.

The Life of Charlotte Brontë, by Mrs Gaskell, was first published in 1857. Owing to the many controversial questions it aroused, as to the identity of Lowood in *Jane Eyre* with Cowan Bridge school, as to the relations of Branwell Brontë with his employer's wife, as to the supposed peculiarities of Mr Brontë, and certain other minor points, the third edition was considerably changed. The *Life* has been many times reprinted, but may be read in its most satisfactory form in the Haworth edition (1902), issued by the original publishers, Smith, Elder & Co. To this edition are attached a great number of letters written by Miss Brontë to her publisher, George Smith. The first new material supplied to supplement Mrs Gaskell's *Life* was contained in *Charlotte Brontë: a Monograph*, by T. Wemyss Reid (1877). This book inspired Mr A. C. Swinburne to issue separately a forcible essay on Charlotte and Emily Brontë, under the title of *A Note on Charlotte Brontë* (1877). A further collection of letters written by Miss Brontë was contained in *Charlotte Brontë and her Circle*, by Clement Shorter (1896), and interesting details can be gathered from *The Life of Charlotte Brontë*, by Augustine Birrell (1887), *The Brontës in Ireland*, by William Wright, D.D. (1893), *Charlotte Brontë and her Sisters*, by Clement Shorter (1906), and the Brontë Society publications, edited by Butler Wood (1895-1907). Miss A. Mary F. Robinson (Madame Duclaux) wrote a separate biography of Emily Brontë in 1883, and an essay in her *Grands Écrivains d'entre-Manche. The Brontës: Life and Letters*, by Clement Shorter (1907), contains the whole of C. Brontë's letters in chronological order. (C. K. S.)

BRONTE, a town of the province of Catania, Sicily, on the western slopes of Mt. Etna, 24 m. N.N.W. of Catania direct, and 34 m. by rail. Pop. (1901) 20,366. It was founded by the emperor Charles V. The town, with an extensive estate which originally belonged to the monastery of Maniacium (Maniace), was granted, as a dukedom, to Nelson by Ferdinand IV. of Naples in 1799.

BRONX, THE, formerly a district comprising several towns in Westchester county, New York, U.S.A., now (since 1898) the northernmost of the five boroughs of New York City (q.v.). Several settlements in the Bronx were made by the English and the Dutch between 1640 and 1650.

BRONZE, an alloy formed wholly or chiefly of copper and tin in variable proportions. The word has been etymologically connected with the same root as appears in "brown," but according to M. P. E. Berthelot (*La Chimie au moyen âge*) it is a place-name derived from *aes Brundisianum* (cf. *Pliny, Nat. Hist.* xxxiii. ch. ix. § 45, "specula optima apud majores fuerunt Brundisiana, stanno et aere mixtis"). A Greek MS. of about the 11th century in the library of St Mark's, Venice, contains

the form *βροπτήσιον*, and gives the composition of the alloy as 1 lb of copper with 2 oz. of tin. The product obtained by adding tin to copper is more fusible than copper and thus better suited for casting; it is also harder and less malleable. A soft bronze or *gun-metal* is formed with 16 parts of copper to 1 of tin, and a harder gun-metal, such as was used for bronze ordnance, when the proportion of tin is about doubled. The *steel bronze* of Colonel Franz Uchatius (1811-1881) consisted of copper alloyed with 8% of tin, the tenacity and hardness being increased by cold-rolling. Bronze containing about 7 parts of copper to 1 of tin is hard, brittle and sonorous, and can be tempered to take a fine edge. *Bell-metal* varies considerably in composition, from about 3 to 5 parts of copper to 1 of tin. In *speculum metal* there are 2 to 2½ parts of copper to 1 of tin. Statuary bronze may contain from 80 to 90% of copper, the residue being tin, or tin with zinc and lead in various proportions. The bronze used for the British and French copper coinage consists of 95% copper, 4% tin and 1% zinc. Many copper-tin alloys employed for machinery-bearings contain a small proportion of zinc, which gives increased hardness. "Anti-friction metals," also used in bearings, are copper-tin alloys in which the amount of copper is small and there is antimony in addition. Of this class an example is "Babbitt's metal," invented by Isaac Babbitt (1799-1862); it originally consisted of 24 parts of tin, 8 parts of antimony and 4 parts of copper, but in later compositions for the same purpose the proportion of tin is often considerably higher. Bronze is improved in quality and strength when fluxed with phosphorus. Alloys prepared in this way, and known as *phosphor bronze*, may contain only about 1% of phosphorus in the ingot, reduced to a mere trace after casting, but their value is nevertheless enhanced for purposes in which a hard strong metal is required, as for pump plungers, valves, the bushes of bearings, &c. Bronze again is improved by the presence of manganese in small quantity, and various grades of *manganese bronze*, in some of which there is little or no tin but a considerable percentage of zinc, are extensively used in mechanical engineering. Alloys of copper with aluminium, though often nearly or completely destitute of tin, are known as *aluminium bronze*, and are valuable for their strength and the resistance they offer to corrosion. By the addition of a small quantity of silicon the tensile strength of copper is much increased; a sample of such *silicon bronze*, used for telegraph wires, on analysis was found to consist of 99.94% of copper, 0.03% of tin, and traces of iron and silicon.

The bronze (Gr. *χαλκός*, Lat. *aes*) of classical antiquity consisted chiefly of copper, alloyed with one or more of the metals, zinc, tin, lead and silver, in proportions that varied as times changed, or according to the purposes for which the alloy was required. Among bronze remains the copper is found to vary from 67 to 95%. From the analysis of coins it appears that for their bronze coins the Greeks adhered to an alloy of copper and tin till 400 B.C., after which time they used also lead with increasing frequency. Silver is rare in their bronze coins. The Romans also used lead as an alloy in their bronze coins, but gradually reduced the quantity, and under Caligula, Nero, Vespasian and Domitian, coined pure copper coins; afterwards they reverted to the mixture of lead. So far the words *χαλκός* and *aes* may be translated as bronze. Originally, no doubt, *χαλκός* was the name for pure copper. It is so employed by Homer, who calls it *ἐρυθρός* (red), *αἰθυψ* (glittering), *φαιερός* (shining), terms which apply only to copper. But instead of its following from this that the process of alloying copper with other metals was not practised in the time of the poet, or was unknown to him, the contrary would seem to be the case from the passage (*Iliad* xviii. 474) where he describes Hephaestus as throwing into his furnace copper, tin, silver and gold to make the shield of Achilles, so that it is not always possible to know whether when he uses the word *χαλκός* he means copper pure or alloyed. Still more difficult is it to make this distinction when we read of the mythical Dactyls of Ida in Crete or the Telchines or Cyclopes being acquainted with the smelting of *χαλκός*. It is not, however, likely that later Greek writers, who knew bronze

in its true sense, and called it *χαλκός*, would have employed this word without qualification for objects which they had seen unless they had meant it to be taken as bronze. When Pausanias (iii. 17. 6) speaks of a statue, one of the oldest figures he had seen of this material, made of separate pieces fastened together with nails, we understand him to mean literally bronze, the more readily since there exist very early figures and utensils of bronze so made.

For the use of bronze in art, see METAL-WORK.

BRONZE AGE, the name given by archaeologists to that stage in human culture, intermediate between the Stone and Iron Ages, when weapons, utensils and implements were, as a general rule, made of bronze. The term has no absolute chronological value, but marks a period of civilization through which it is believed that most races passed at one time or another. The "finds" of stone and bronze, of bronze and iron, and even of stone and iron implements together in tumuli and sepulchral mounds, suggest that in many countries the three stages in man's progress overlapped. From the similarity of types of weapons and implements of the period found throughout Europe a relatively synchronous commencement has been inferred for the Bronze Age in Europe, fixed by most authorities at between 2000 B.C. to 1800 B.C. But it must have been earlier in some countries, and is certainly known to have been later in others; while the Mexicans and Peruvians were still in their bronze age in recent times. Not a few archaeologists have denied that there ever was a distinct Bronze Age. They have found their chief argument in the fact that weapons of these ages have been found side by side in prehistoric burial-places. But when it is admitted that the ages must have overlapped, it is fairly easy to understand the mixed "finds." The beginning, the prevalence and duration of the Bronze Age in each country would have been ordered by the accessibility of the metals which form the alloy. Thus in some lands bronze may have continued to be a substance of extreme value until the Iron Age was reached, and in tumuli in which more than one body was interred, as was frequently the case, it would only be with the remains of the richer tenants of the tomb that the more valuable objects would be placed. There is, moreover, much reason to believe that sepulchral mounds were opened from age to age and fresh interments made, and in such a practice would be found a simple explanation of the mixing of implements. Another curious fact has been seized on by those who argue against the existence of a Bronze Age. Among all the "finds" examined in Europe there is a most remarkable absence of copper implements. The sources of tin in Europe are practically restricted to Cornwall and Saxony. How then are we to explain on the one hand the apparent stride made by primitive man when from a Stone Age civilization he passed to a comparatively advanced metallurgical skill? On the other, how account for a comparatively synchronous commencement of bronze civilization when one at least of the metals needed for the alloy would have been naturally difficult of access, if not unknown to many races? The answer is that there can be but little doubt that the knowledge of bronze came to the races of Europe from outside. Either by the Phoenicians or by the Greeks metallurgy was taught to men who no sooner recognized the nature and malleable properties of copper than they learnt that by application of heat a substance could be manufactured with tin far better suited to their purposes. Copper would thus have been but seldom used unalloyed; and the relatively synchronous appearance of bronze in Europe, and the scanty "finds" of copper implements, are explained. We may conclude then that there was a Bronze Age in most countries; that it was the direct result of increasing intercommunication of races and the spread of commerce; and that the discovery of metals was due to information brought to Stone-Age man in Europe by races which were already skilful metallurgists.

The Bronze Age in Europe is characterized by weapons, utensils and implements, distinct in design and size from those in use in the preceding or succeeding stage of man's civilization. Moreover—and this has been employed as an argument in favour of the foreign origin of the knowledge of bronze—all the

objects in one part of Europe are identical in pattern and size with those found in another part. The implements of the Bronze Age include swords, awls, knives, gouges, hammers, daggers and arrow-heads. A remarkable confirmation of the theory that the Bronze Age culture came from the East is to be found in the patterns of the arms, which are distinctly oriental; while the handles of swords and daggers are so narrow and short as to make it unlikely that they would be made for use by the large-handed races of Europe. The Bronze Age is also characterized by the fact that cremation was the mode of disposal of the dead, whereas in the Stone Age burial was the rule. Barrows and sepulchral mounds strictly of the Bronze Age are smaller and less imposing than those of the Stone Age. Besides varied and beautiful weapons, frequently exhibiting high workmanship, amulets, coronets, diadems of solid gold, and vases of elegant form and ornamentation in gold and bronze are found in the barrows. These latter appear to have been used as tribal or family cemeteries. In Denmark as many as seventy deposits of burnt bones have been found in a single mound, indicating its use through a long succession of years. The ornamentation of the period is as a rule confined to spirals, bosses and concentric circles. What is remarkable is that the swords not only show the design of the cross in the shape of the handle, but also in tracery what is believed to be an imitation of the Svastika, that ancient Aryan symbol which was probably the first to be made with a definite intention and a consecutive meaning. The pottery is all "hand-made," and the bulk of the objects excavated are cinerary urns, usually found full of burnt bones. These vary from 12 to 18 in. in height. Their decoration is confined to a band round the upper part of the pot, or often only a projecting flange lapped round the whole rim. A few have small handles, formed of pierced knobs of clay and sometimes projecting rolls of clay, looped, as it were, all round the urn. The ornamentation consists of dots, zigzags, chevrons or crosses. The lines were frequently made by pressing a twisted thong of skin against the moist clay; the patterns in all cases being stamped into the pot before it was hardened by fire.

See ARCHAEOLOGY, &c. Also Lord Avebury, *Prehistoric Times* (1900); Sir J. Evans, *Ancient Bronze Implements of Great Britain* (1881); Chartre's *Age du bronze en France*.

BRONZING, a process by which a bronze-like surface is imparted to objects of metal, plaster, wood, &c. On metals a green bronze colour is sometimes produced by the action of such substances as vinegar, dilute nitric acid and sal-ammoniac. An antique appearance may be given to new bronze articles by brushing over the clean bright metal with a solution of sal-ammoniac and salt of sorrel in vinegar, and rubbing the surface dry, the operation being repeated as often as necessary. Another solution for the same purpose is made with sal-ammoniac, cream of tartar, common salt and silver nitrate. With a solution of platinic chloride almost any colour can be produced on copper, iron, brass or new bronze, according to the dilution and the number of applications. Articles of plaster and wood may be bronzed by coating them with size and then covering them with a bronze powder, such as Dutch metal, beaten into fine leaves and powdered. The bronzing of gun-barrels may be effected by the use of a strong solution of antimony trichloride.

BRONZINO, IL, the name given to ANGELO ALLORI (1502-1572), the Florentine painter. He became the favourite pupil of J. da Pontormo. He painted the portraits of some of the most famous men of his day, such as Dante, Petrarch and Boccaccio. Most of his best works are in Florence, but examples are in the National Gallery, London, and elsewhere.

BRONZITE, a member of the pyroxene group of minerals, belonging with enstatite and hypersthene to the orthorhombic series of the group. Rather than a distinct species, it is really a ferrous variety of enstatite, which owing to partial alteration has acquired a bronze-like sub-metallic lustre on the cleavage surfaces. Enstatite is magnesium metasilicate, $MgSiO_3$, with the magnesia partly replaced by small amounts (up to about 5%) of ferrous oxide; in the bronzite variety, $(Mg,Fe)SiO_3$, the ferrous oxide ranges from about 5 to 14%, and with still more

iron there is a passage to hypersthene. The ferrous varieties are liable to a particular kind of alteration, known as "schillerization," which results in the separation of the iron as very fine films of oxide and hydroxides along the cleavage cracks of the mineral. The cleavage surfaces therefore exhibit a metallic sheen or "schiller," which is even more pronounced in hypersthene than in bronzite. The colour of bronzite is green or brown; its specific gravity is about 3.2-3.3, varying with the amount of iron present. Like enstatite, bronzite is a constituent of many basic igneous rocks, such as norites, gabbros, and especially peridotites, and of the serpentines which have been derived from them. It also occurs in some crystalline schists.

Bronzite is sometimes cut and polished, usually in convex forms, for small ornamental objects, but its use for this purpose is less extensive than that of hypersthene. It often has a more or less distinct fibrous structure, and when this is pronounced the sheen has a certain resemblance to that of cat's-eye. Masses sufficiently large for cutting are found in the norite of the Kupferberg in the Fichtelgebirge, and in the serpentine of Kraubart near Leoben in Styria. In this connexion mention may be made of an altered form of enstatite or bronzite known as *bastite* or *schiller-spar*. Here, in addition to schillerization, the original enstatite has been altered by hydration and the product has approximately the composition of serpentine. In colour bastite is brown or green with the same metallic sheen as bronzite. The typical locality is Baste in the Radauthal, Harz, where patches of pale greyish-green bastite are embedded in a darker-coloured serpentine. This rock when cut and polished makes an effective decorative stone, although little used for that purpose. (L. J. S.)

BROOCH, or **BROACH** (from the Fr. *broche*, originally an awl or bodkin; a spit is sometimes called a broach, and hence the phrase "to broach a barrel"; see **BROKER**), a term now used to denote a clasp or fastener for the dress, provided with a pin, having a hinge or spring at one end, and a catch or loop at the other.

Brooches of the safety-pin type (*fibulae*) were extensively used in antiquity, but only within definite limits of time and place. They seem to have been unknown to the Egyptians, and to the oriental nations untouched by Greek influence. In lands adjacent to Greece, they do not occur in Crete or at Hisarlik. The place of origin cannot as yet be exactly determined, but it would seem to have been in central Europe, towards the close of the Bronze Age, somewhat before 1000 B.C. The earliest form is little more than a pin, bent round for security, with the point caught against the head. One such actual pin has been found. In its next simplest form, very similar to that of the modern safety-pin (in which the coiled spring forces the point against the catch), it occurs in the lower city of Mycenae, and in late deposits of the Mycenaean Age, such as at Enkomi in Cyprus. It occurs also (though rarely) in the "terramare" deposits of the Po valley, in the Swiss lake-dwellings of the later Bronze Age, in central Italy, in Hungary and in Bosnia (fig. 1).¹



From the comparatively simple initial form, the fibula developed in different lines of descent, into different shapes, varying according to the structural feature which was emphasized. On account of the number of local variations, the subject is extremely complex, but the main lines of development were approximately as follows.

Towards the end of the Bronze Age the safety-pin was arched into a bow, so as to include a greater amount of stuff in its compass.

In the older Iron Age or "Hallstatt period" the bow and its accessories are thickened and modified in various directions, so as to give greater rigidity, and prominences or surfaces for decoration. The chief types have been conveniently classed by

¹ The illustrations of this article are from Dr Robert Forrer's *Reallexikon*, by permission of W. Spemann, Berlin and Stuttgart.

Montelius in four main groups, according to the characteristic forms:—

I. The wire of the catch-plate is hammered into a flat disk, on which the pin rests (fig. 2).

II. The bow is thickened towards the middle, so as to assume the "leech" shape, or it is hollowed out underneath, into the "boat" form. The catch-plate is only slightly turned up, but it becomes elongated, in order to mask the end of a long pin (fig. 3).

FIG. 2.—Type I. with disk for catch-plate.

III. The catch-plate is flattened out as in group I., but additional convolutions are added to the bow (fig. 4).

IV. The bow is convoluted (but the convolutions are sometimes represented by knobs); the catch-plate develops as in group II. (fig. 5). For further examples of the four types, see *Antiquities of Early Iron Age in British Museum*, p. 32.

Among the special variations of the early form, mention should be made of the fibulae of the geometric age of Greece,

with an exaggerated development of the vertical portion of the catch-plate (fig. 6).

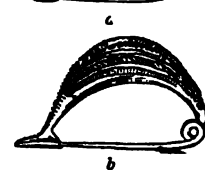

FIG. 3.—Type II. with turned-up and elongated catch-plate. a, "Leech" fibula; b, "Boat" fibula; c, variation of "Boat" fibula.

of the axis of the bow, and thence the wire was taken to the other side of the axis, and again coiled in a corresponding manner before starting in a straight line to form the pin. Once invented, the bilateral spring became almost universal, and its introduction serves to divide the whole mass of ancient fibulae into an older and a younger group.

With the progress of the La Tène period (300-1 B.C.) the reflection of the catch-plate terminal became yet more marked, until it became practically merged in the bow (fig. 9). Meanwhile, the bilateral spring described above was developing into



FIG. 4.—Type III. with disk for catch-plate, and convoluted bow.

by its own spring.

The T-shaped or "cross-bow" fibula was thus developed. During the first centuries of the Empire it attained great size and importance (figs. 10-12). The form is conveniently dated at its highest development by its occurrence on the ivory diptych of Stilicho at Monza (c. A.D. 400).

In the tombs of the Frankish and kindred Teutonic tribes between the 5th and 9th centuries the crossbar of the T becomes

a yet more elaborately decorated semicircle, often surrounded by radial knobs and a chased surface. The base of the shaft is flattened out, and is no less ornate (fig. 13). At the beginning of this period the fibula of King Childeric (A.D. 481) has a singularly complicated pin-fastening.

So far we have traced the history of the safety-pin form of



FIG. 5.—Type IV. with turned-up catch-plate and convoluted bow.



FIG. 6.—Greek geometric fibula.

brooch. Concurrently with it, other forms of brooch were developed in which the safety-pin principle is either absent or effectually disguised. One such form is that of the circular medallion brooch. It is found in Etruscan deposits of a fully developed style, and is commonly represented in Greek and Roman sculptures as a stud to fasten the cloak on the shoulder.

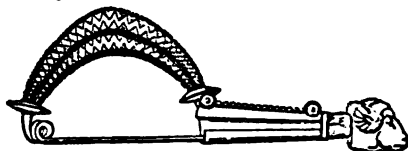

FIG. 7.—Gold fibula from Naples.

In the Roman provinces the circular brooches are very numerous, and are frequently decorated with inlaid stone, paste or enamel. Another kind of brooch, also known from early times, is in the form of an animal. In the early types the animal is a decorative appendage, but in later examples it forms the body of the brooch, to which a pin like the modern brooch-pin is attached underneath. Both of these shapes, namely the medallion and the animal form, are found in Frankish cemeteries, together with the later variations of the T-shaped brooch described above. Such



FIG. 8.—Early La Tène period. Reflexed terminal ornament.

fibulae were made in gold, silver or bronze, adorned with precious stones, filigree work, or enamel; but whatever the richness of the material, the pin was nearly always of iron.

The Scandinavian or northern group of T-shaped brooches are in their early forms indistinguishable from those of the Frankish tombs, but as time went on they became more massive, and richly decorated with intricate devices (perhaps brought

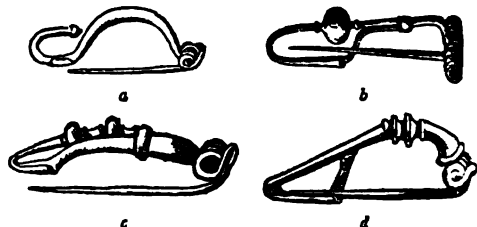

FIG. 9, a-d.—Fibulae of the La Tène period, showing the development of the reflexed terminal, and the bilateral spring.

in by Irish missionary influence), into which animal forms were introduced. The period covered is from the 5th to the 8th centuries.

The T-form, the medallion-form, and (occasionally) the animal forms occur in Anglo-Saxon graves in England. In Kent the medallion-form predominates. The Anglo-Saxon brooches

were exquisite works of art, ingeniously and tastefully constructed. They are often of gold, with a central boss, exquisitely decorated, the flat part of the brooch being a mosaic of turquoises, garnets on gold foil, mother of pearl, &c. arranged in

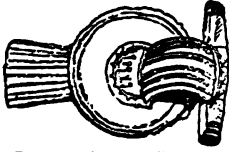

FIG. 10.—Military Fibula.
3rd century A.D.

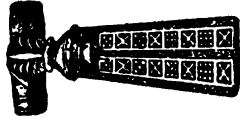

FIG. 11.—Fibula with niello
work. 3rd century A.D.

geometric patterns, and the gold work enriched with filigree or decorated with dragoesque engravings.

The Scandinavian brooches of the 'Viking period' (A.D. 800-1050) were oval and convex, somewhat in the form of a tortoise. In their earliest form they occur in the form of a frog-like animal, itself developed from the previous Teutonic T-shaped type. With the introduction of the intricate system of ornament described above, the frog-like animal is gradually superseded by purely decorative lines. The convex bowls are then worked *à jour* with a perforated upper shell of chased work over an under shell of impure bronze, gilt on the convex side. These outer cases are at last decorated with open crown-like ornament and massive projecting bosses.

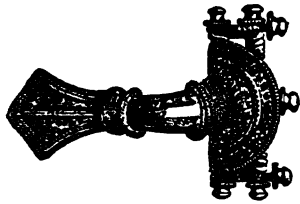

FIG. 12.—Gold Fibula. 4th century A.D.

The Celtic group is characterized by the penannular form of the ring of the brooch and the greater length of the pin. The penannular ring, inserted through a hole at the head of the long pin, could be partially turned when the pin had been thrust through the material in such a way that the brooch became in effect a buckle. These brooches are usually of bronze or silver, chased or engraved with intricate designs of interlaced or dragoesque work in the style of the illuminated Celtic manuscripts of the 7th, 8th and 9th centuries. The Hunterston brooch, which was found at Hawking Craig in Ayrshire, is a well-known example of this style. Silver brooches of immense size, some having pins 15 in. in length, and the penannular ring of the brooch terminating in large knobs resembling thistle heads, are occasionally found in Viking hoards of this period, consisting of bullion, brooches and Cufic and Anglo-Saxon coins buried on Scottish soil.

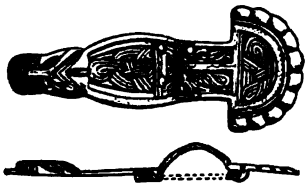

FIG. 13.—Fibula of the Frankish period.

The Highland brooches were commonly of this form, but the disk was broader, and the central opening smaller in proportion to the size of the brooch. They were ornamented in the style so common on Highland powder-horns, with engraved patterns of interlacing work and foliage, arranged in geometrical spaces, and sometimes mingled with figures of animals. (A. H. SM.)

BROOKE, FRANCES (1724-1789), English novelist and dramatist, whose maiden name was Moore, was born in 1724. Of her novels, some of which enjoyed considerable popularity in their day, the most important were *The History of Lady Julia Mandeville* (1763), *Emily Montague* (1769) and *The Excursion* (1777). Her dramatic pieces and translations from the French are now forgotten. She died in January 1789.

BROOKE, FULKE GREVILLE, 1ST BARON (1554-1628); English poet, only son of Sir Fulke Greville, was born at Beauchamp Court, Warwickshire. He was sent in 1564, on the same day as his life-long friend, Philip Sidney, to Shrewsbury school. He matriculated at Jesus College, Cambridge, in 1568. Sir Henry Sidney, president of Wales, gave him in 1576 a post connected with the court of the Marches, but he resigned it in 1577 to go to court with Philip Sidney. Young Greville became a great favourite with Queen Elizabeth, who treated him with less than her usual caprice, but he was more than once disgraced for leaving the country against her wishes. Philip Sidney, Sir Edward Dyer and Greville were members of the "Areopagus," the literary clique which, under the leadership of Gabriel Harvey, supported the introduction of classical metres into English verse. Sidney and Greville arranged to sail with Sir Francis Drake in 1585 in his expedition against the Spanish West Indies, but Elizabeth peremptorily forbade Drake to take them with him, and also refused Greville's request to be allowed to join Leicester's army in the Netherlands. Philip Sidney, who took part in the campaign, was killed on the 17th of October 1586, and Greville shared with Dyer the legacy of his books, while in his *Life of the Renowned Sir Philip Sidney* he raised an enduring monument to his friend's memory. About 1591 Greville served for a short time in Normandy under Henry of Navarre. This was his last experience of war. In 1583 he became secretary to the principality of Wales, and he represented Warwickshire in parliament in 1592-1593, 1597, 1601 and 1620. In 1598 he was made treasurer of the navy, and he retained the office through the early years of the reign of James I. In 1614 he became chancellor and under-treasurer of the exchequer, and throughout the reign he was a valued supporter of the king's party, although in 1615 he advocated the summoning of a parliament. In 1618 he became commissioner of the treasury, and in 1621 he was raised to the peerage with the title of Baron Brooke, a title which had belonged to the family of his paternal grandmother, Elizabeth Willoughby. He received from James I. the grant of Warwick Castle, in the restoration of which he is said to have spent £20,000. He died on the 30th of September 1628 in consequence of a wound inflicted by a servant who was disappointed at not being named in his master's will. Brooke was buried in St Mary's church, Warwick, and on his tomb was inscribed the epitaph he had composed for himself: "Folk Grevill Servant to Queene Elizabeth Conceller to King James Friend to Sir Philip Sidney. Trophaeum Peccati."

A rhyming elegy on Brooke, published in Huth's *Inedited Poetical Miscellanies*, brings charges of extreme penuriousness against him, but of his generous treatment of contemporary writers there is abundant testimony. His only works published during his lifetime were four poems, one of which is the elegy on Sidney which appeared in *The Phoenix Nest* (1593), and the *Tragedy of Mustapha*. A volume of his works appeared in 1633, another of *Remains* in 1670, and his biography of Sidney in 1652. He wrote two tragedies on the Senecan model, *Alaham* and *Mustapha*. The scene of *Alaham* is laid in Ormuz. The development of the piece fully bears out the gloom of the prologue, in which the ghost of a former king of Ormuz reveals the magnitude of the curse about to descend on the doomed family. The theme of *Mustapha* is borrowed from Madeleine de Scudéry's *Ibrahim ou l'illustre Bassa*, and turns on the ambition of the sultana Rossa. The choruses of these plays are really philosophical dissertations, and the connexion with the rest of the drama is often very slight. In *Mustapha*, for instance, the third chorus is a dialogue between Time and Eternity, while the fifth consists of an invective against the evils of superstition, followed by a chorus of priests that does nothing to dispel

the impression of scepticism contained in the first part. He tells us himself that the tragedies were not intended for the stage. Charles Lamb says they should rather be called political treatises. Of Brooke Lamb says, "He is nine parts Machiavel and Tacitus, for one of Sophocles and Seneca. . . . Whether we look into his plays or his most passionate love-poems, we shall find all frozen and made rigid with intellect." He goes on to speak of the obscurity of expression that runs through all Brooke's poetry, an obscurity which is, however, due more to the intensity and subtlety of the thought than to any lack of mere verbal lucidity.

It is by his biography of Sidney that Fulke Greville is best known. The full title expresses the scope of the work. It runs: *The Life of the Renowned Sr. Philip Sidney. With the true Interest of England as it then stood in relation to all Forrain Princes: And particularly for suppressing the power of Spain Stated by Him: His principal Actions, Counsels, Designs, and Death. Together with a short account of the Maxims and Policies used by Queen Elizabeth in her Government.* He includes some autobiographical matter in what amounts to a treatise on government. He had intended to write a history of England under the Tudors, but Robert Cecil refused him access to the necessary state papers.

Brooke left no sons, and his barony passed to his cousin, Robert Greville (c. 1608–1643), who thus became 2nd Lord Brooke. This nobleman was imprisoned by Charles I. at York in 1639 for refusing to take the oath to fight for the king, and soon became an active member of the parliamentary party; taking part in the Civil War he defeated the Royalists in a skirmish at Kington in August 1642. He was soon given a command in the midland counties, and having seized Lichfield he was killed there on the 2nd of March 1643. Brooke, who is eulogized as a friend of toleration by Milton, wrote on philosophical, theological and current political topics. In 1746 his descendant, Francis Greville, the 8th Baron (1719–1773), was created earl of Warwick, a title still in his family.

Dr A. B. Grosart edited the complete works of Fulke Greville for the Fuller Worthies Library in 1870, and made a small selection, published in the *Elizabethan Library* (1894). Besides the works above mentioned, the volumes include *Poems of Monarchy, A Treatise of Religion, A Treatise of Humane Learning, An Inquisition upon Fame and Honour, A Treatise of Warres, Castica in CX Sonnets*, a collection of lyrics in various forms, a letter to an "Honourable Lady," a letter to Grevill Varney in France, and a short speech delivered on behalf of Francis Bacon, some minor poems, and an introduction including some of the author's letters. The life of Sidney was reprinted by Sir S. Egerton Brydges in 1816; and with an introduction by N. Smith in the "Tudor and Stuart Library" in 1907; *Castica* was reprinted in M. F. Crow's "Elizabethan Sonnet Cycles" in 1898. See also an essay in Mrs. C. C. Stope's *Shakespeare's Warwickshire Contemporaries* (1907).

BROOKE, HENRY (c. 1703–1783), Irish author, son of William Brooke, rector of Killinkere, Co. Cavan, was born at Rantavan in the same county, about 1703. His mother was a daughter of Simon Digby, bishop of Elphin. Dr Thomas Sheridan was one of his schoolmasters, and he was entered at Trinity College, Dublin, in 1720; in 1724 he was sent to London to study law. He married his cousin and ward, Catherine Meares, before she was fourteen. Returning to London he published a philosophical poem in six books entitled *Universal Beauty* (1735). He attached himself to the party of the prince of Wales, and took a small house at Twickenham near to Alexander Pope. In 1738 he translated the first and second books of Tasso's *Gerusalemme liberata*, and in the next year he produced a tragedy, *Gustavus Vasa, the Deliverer of his Country*. This play had been rehearsed for five weeks at Drury Lane, but at the last moment the performance was forbidden. The reason of this prohibition was a supposed portrait of Sir Robert Walpole in the part of Trollio. In any case the spirit of fervent patriotism which pervaded the play was probably disliked by the government. The piece was printed and sold largely, being afterwards put on the Irish stage under the title of *The Patriot*. This affair provoked a satirical pamphlet from Samuel Johnson, entitled "A Complete Vindication of the Licensers of the Stage from the malicious and

scandalous Aspersions of Mr Brooke" (1739). His wife feared that his connexion with the opposition was imprudent, and induced him to return to Ireland. He interested himself in Irish history and literature, but a projected collection of Irish stories and a history of Ireland from the earliest times were abandoned in consequence of disputes about the ownership of the materials. During the Jacobite rebellion of 1745 Brooke issued his *Farmer's Six Letters to the Protestants of Ireland* (collected 1746) the form of which was suggested by Swift's *Draper's Letters*. For this service he received from the government the post of barrack-master at Mullingar, which he held till his death. He wrote other pamphlets on the Protestant side, and was secretary to an association for promoting projects of national utility. About 1760 he entered into negotiations with leading Roman Catholics, and in 1761 he wrote a pamphlet advocating alleviation of the penal laws against them. He is said to have been the first editor of the *Freeman's Journal*, established at Dublin in 1763. Meanwhile he had been obliged to mortgage his property in Cavan, and had removed to Co. Kildare. Subsequently a bequest from Colonel Robert Brooke enabled him to purchase an estate near his old home, and he spent large sums in attempting to reclaim the waste-land. His best-known work is the novel entitled *The Fool of Quality; or the History of Henry Earl of Moreland*, the first part of which was published in 1765; and the fifth and last in 1770. The characters of this book, which relates the education of an ideal nobleman by an ideal merchant-prince, are gifted with a "passionate and tearful sensibility," and reflect the real humour and tenderness of the writer. Brooke's religious and philanthropic temper recommended the book to John Wesley, who edited (1780) an abridged edition, and to Charles Kingsley, who published it with a eulogistic notice in 1850. Brooke had a large family, but only two children survived him. His wife's death seriously affected him, and he died at Dublin in a state of mental infirmity on the 10th of October 1783.

His daughter, Charlotte Brooke, published *The Poetical Works of Henry Brooke* in 1792, but was able to supply very little biographical material. Other sources for Brooke's biography are C. H. Wiser's *Brookiana* (2 vols., 1804), and a biographical preface by E. A. Baker prefixed to a new edition (1906) of *The Fool of Quality*. Brooke's other works include several tragedies, only some of which were actually staged. He also wrote: *Jack the Giant Killer* (1748) as operatic satire, the repetition of which was forbidden on account of its political allusions; "Constantia, or the Man of Law's Text" (1741), contributed to George Ogle's *Canterbury Tales modernized: Juliet Grenville; or the History of the Human Heart* (1773), a novel, and some fables contributed to Edward Moore's *Fables for the Female Sex* (1744).

BROOKE, SIR JAMES (1803–1868), English soldier, traveller and raja of Sarawak, was born at Coombe Grove near Bath on the 29th of April 1803. His father, a member of the civil service of the East India Company, had long lived in Bengal. His mother was a woman of superior mind, and to her care he owed his careful early training. He received the ordinary school education, entered the service of the East India Company, and was sent out to India about 1825. On the outbreak of the Burmese War he was despatched with his regiment to the valley of the Brahmaputra; and, being dangerously wounded in an engagement near Rungpore, was compelled to return home (1827). After his recovery he travelled on the continent before going to India, and circumstances led him soon after to leave the service of the company. In 1830 he made a voyage to China, and during his passage among the islands of the Indian Archipelago, so rich in natural beauty, magnificence and fertility, but occupied by a population of savage tribes, continually at war with each other, and carrying on a system of piracy on a vast scale and with relentless ferocity, he conceived the great design of rescuing them from barbarism and bringing them within the pale of civilization. His purpose was confirmed by observations made during a second visit to China, and on his return to England he applied himself in earnest to making the necessary preparations. Having succeeded on the death of his father to a large property, he bought and equipped a yacht, the "Royalist," of 140 tons burden, and for three years tested its capacities and trained his crew of

twenty men, chiefly in the Mediterranean. At length, on the 27th of October 1838, he sailed from the Thames on his great adventure. On reaching Borneo, after various delays, he found the raja Muda Hassim, uncle of the reigning sultan, engaged in war in the province of Sarawak with several of the Dyak tribes, who had revolted against the sultan. He offered his aid to the raja; and with his crew, and some Javanese who had joined them, he took part in a battle with the insurgents, and they were defeated. For his services the title of raja of Sarawak was conferred on him by Muda Hassim, the former raja being deprived in his favour. It was, however, some time before the sultan could be induced to confirm his title (September 1841). During the next five years Raja Brooke was engaged in establishing his power, in making just reforms in administration, preparing a code of laws and introducing just and humane modes of dealing with the degraded subjects of his rule. But this was not all. He looked forward to the development of commerce as the most effective means of putting an end to the worst evils that afflicted the archipelago; and in order to make this possible, the way must first be cleared by the suppression, or a considerable diminution, of the prevailing piracy, which was not only a curse to the savage tribes engaged in it, but a standing danger to European and American traders in those seas. Various expeditions were therefore organized and sent out against the marauders, Dyaks and Malays, and sometimes even Arabs. Captain (afterwards Admiral Sir Harry) Keppel, and other commanders of British ships of war, received permission to co-operate with Raja Brooke in these expeditions. The pirates were attacked in their strongholds, they fought desperately, and the slaughter was immense. Negotiations with the chiefs had been tried, and tried in vain. The capital of the sultan of Borneo was bombarded and stormed, and the sultan with his army routed. He was, however, soon after restored to his dominion. So large was the number of natives, pirates and others, slain in these expeditions, that the "head-money" awarded by the British government to those who had taken part in them amounted to no less than £20,000. In October 1847 Raja Brooke returned to England, where he was well received by the government; and the corporation of London conferred on him the freedom of the city. The island of Labuan, with its dependencies, having been acquired by purchase from the sultan of Borneo, was erected into a British colony, and Raja Brooke was appointed governor and commander-in-chief. He was also named consul-general in Borneo. These appointments had been made before his arrival in England. The university of Oxford conferred on him the honorary degree of D. C. L., and in 1848 he was created K. C. B. He soon after returned to Sarawak, and was carried thither by a British man-of-war. In the summer of 1849 he led an expedition against the Seribas and Sakuran Dyaks, who still persisted in their piratical practices and refused to submit to British authority. Their defeat and wholesale slaughter was a matter of course. At the time of this engagement Sir James Brooke was lying ill with dysentery. He visited twice the capital of the sultan of Sala, and concluded a treaty with him, which had for one of its objects the expulsion of the sea-gypsies and other tribes from his dominions. In 1851 grave charges with respect to the operations in Borneo were brought against Sir James Brooke in the House of Commons by Joseph Hume and other members, especially as to the "head-money" received. To meet these accusations, and to vindicate his proceedings, he came to England. The evidence adduced was so conflicting that the matter was at length referred to a royal commission, to sit at Singapore. As the result of its investigation the charges were declared to be "not proven." Sir James, however, was soon after deprived of the governorship of Labuan, and the head-money was abolished. In 1867 his house in Sarawak was attacked and burnt by Chinese pirates, and he had to fly from the capital, Kuching. With a small force he attacked the Chinese, recovered the town, made a great slaughter of them, and drove away the rest. In the following year he came to England, and remained there for three years. During this time he was attacked by paralysis, a public subscription was raised, and an estate

in Devonshire was bought and presented to him. He made two more visits to Sarawak, and on each occasion had a rebellion to suppress. He spent his last days on his estate at Burrator in Devonshire, and died there, on the 11th of June 1868, being succeeded as raja of Sarawak by his nephew. Sir James Brooke was a man of the highest personal character, and he displayed rare courage both in his conflicts in the East and under the charges advanced against him in England.

His *Private Letters* (1838 to 1853) were published in 1853. Portions of his *Journal* were edited by Captains Munday and Keppel. (See also SARAWAK.)

BROOKE, STOPFORD AUGUSTUS (1832-), English divine and man of letters, born at Letterkenny, Donegal, Ireland, in 1832; was educated at Trinity College, Dublin. He was ordained in the Church of England in 1857, and held various charges in London. From 1863 to 1865 he was chaplain to the empress Frederick in Berlin, and in 1872 he became chaplain in ordinary to Queen Victoria. But in 1880 he seceded from the Church, being no longer able to accept its leading dogmas, and officiated as a Unitarian minister for some years at Bedford chapel, Bloomsbury. Bedford chapel was pulled down about 1894, and from that time he had no church of his own, but his eloquence and powerful religious personality continued to make themselves felt among a wide circle. A man of independent means, he was always keenly interested in literature and art, and a fine critic of both. He published in 1865 his *Life and Letters of F. W. Robertson* (of Brighton), and in 1876 wrote an admirable primer of *English Literature* (new and revised ed., 1900), followed in 1892 by *The History of Early English Literature* (2 vols., 1892) down to the accession of Alfred, and *English Literature from the Beginnings to the Norman Conquest* (1898). His other works include various volumes of sermons; *Poems* (1888); *Dove Cottage* (1890); *Theology in the English Poets—Cowper, Coleridge, Wordsworth, Burns* (1874); *Tennyson, his Art and Relation to Modern Life* (1894); *The Poetry of Robert Browning* (1902); *On Ten Plays of Shakespeare* (1905); and *The Life Superlative* (1906).

BROOK FARM, the name applied to a tract of land in West Roxbury, Massachusetts, on which in 1841-1847 a communistic experiment was unsuccessfully tried. The experiment was one of the practical manifestations of the spirit of "Transcendentalism," in New England, though many of the more prominent transcendentalists took no direct part in it. The project was originated by George Ripley, who also virtually directed it throughout. In his words it was intended "to insure a more natural union between intellectual and manual labour than now exists; to combine the thinker and the worker, as far as possible, in the same individual; to guarantee the highest mental freedom by providing all with labour adapted to their tastes and talents, and securing to them the fruits of their industry; to do away with the necessity of menial services by opening the benefits of education and the profits of labour to all; and thus to prepare a society of liberal, intelligent and cultivated persons whose relations with each other would permit a more simple and wholesome life than can be led amidst the pressure of our competitive institutions." In short, its aim was to bring about the best conditions for an ideal civilization, reducing to a minimum the labour necessary for mere existence, and by this and by the simplicity of its social machinery saving the maximum of time for mental and spiritual education and development. At a time when Ralph Waldo Emerson could write to Thomas Carlyle, "We are all a little wild here with numberless projects of social reform; not a reading man but has a draft of a new community in his waistcoat pocket,"—the Brook Farm project certainly did not appear as impossible a scheme as many others that were in the air. At all events it enlisted the co-operation of men whose subsequent careers show them to have been something more than visionaries. The association bought a tract of land about 10 m. from Boston, and in the summer of 1841 began its enterprise with about twenty members. In September the "Brook Farm Institute of Agriculture and Education" was formally organized, the members

signing the Articles of Association and forming an unincorporated joint-stock company. The farm was assiduously, if not very skillfully, cultivated, and other industries were established—most of the members paying by labour for their board—but nearly all of the income, and sometimes all of it, was derived from the school, which deservedly took high rank and attracted many pupils. Among these were included George William Curtis and his brother James Burrill Curtis, Father Isaac Thomas Hecker (1819–1888), General Francis C. Barlow (1834–1896), who as attorney-general of New York in 1871–1873 took a leading part in the prosecution of the “Tweed Ring.” For three years the undertaking went on quietly and simply, subject to few outward troubles other than financial, the number of associates increasing to seventy or eighty. It was during this period that Nathaniel Hawthorne had his short experience of Brook Farm, of which so many suggestions appear in the *Blithedale Romance*, though his preface to later editions effectually disposed of the idea—which gave him great pain—that he had either drawn his characters from persons there, or had meant to give any actual description of the colony. Emerson refused, in a kind and characteristic letter, to join the undertaking, and though he afterwards wrote of Brook Farm with not uncharitable humour as “a perpetual picnic, a French Revolution in small, an age of reason in a patty-pan,” among its founders were many of his near friends. In 1844 the growing need of a more scientific organization, and the influence which F. M. C. Fourier’s doctrines, as modified by Albert Brisbane (1809–1890), had gained in the minds of Ripley and many of his associates, combined to change the whole plan of the community. It was transformed, with the strong approval of all its chief members and the consent of the rest, into a Fourierist “phalanx” in 1845. There was an accession of new members, a momentary increase of prosperity, a brilliant new undertaking in the publication of a weekly journal, the *Harbinger*, in which Ripley, Charles A. Dana, Francis G. Shaw and John S. Dwight were the chief writers, and to which James Russell Lowell, J. G. Whittier, George William Curtis, Parke Godwin, T. W. Higginson, Horace Greeley and many more now and then contributed. But the individuality of the old Brook Farm was gone. The association was not rescued even from financial troubles by the change. With increasing difficulty it kept on till the spring of 1846, when a fire which destroyed its nearly completed “phalanstery” brought losses which caused, or certainly gave the final ostensible reason for, its dissolution. The experiment was abandoned in the autumn of 1847. Besides Ripley and Hawthorne, the principal members of the community were Charles A. Dana, John S. Dwight, Minot Pratt (c. 1805–1878), the head farmer, who, like George Partridge Bradford (1808–1890), left in 1845, and Warren Burton (1810–1866) a preacher and, later, a writer on educational subjects. Indirectly connected with the experiment, also, as visitors for longer or shorter periods but never as regular members, were Emerson, Amos Bronson Alcott, Orestes A. Brownson, Theodore Parker and William Henry Channing, Margaret Fuller and Elizabeth Palmer Peabody. The estate itself, after passing through various hands, came in 1870 into the possession of the “Association of the Evangelical Lutheran Church for Works of Mercy,” which established here an orphanage, known as the “Martin Luther Orphan Home.”

The best account of Brook Farm is Lindsay Swift’s *Brook Farm, Its Members, Scholars and Visitors* (New York, 1900). *Brook Farm: Historic and Personal Memoirs* (Boston, 1894), is by Dr J. T. Codman, one of the pupils in the school. See also Morris Hillquit’s *History of Socialism in the United States* (New York, 1903). (E. L. B.)

BROOKITE, one of the three modifications in which titanium dioxide (TiO_2) occurs in nature; the other minerals with the same chemical composition, but with different physical and crystallographic characters, being rutile (*q.v.*) and anatase (*q.v.*). The two latter are tetragonal in crystallization, whilst brookite is orthorhombic. The name was given by A. Lévy in 1825 in honour of the English mineralogist H. J. Brooke (1771–1857). Two types of brookite crystals may be distinguished. The commoner type of crystals are thin and tabular, and often terminated by numerous small and brilliant faces (fig. 1); the faces of the

orthopinacoid (*a*) and of the prisms (*m*, *l*) are vertically striated. These crystals are of a rich reddish-brown colour and are often translucent. Crystals of the second type have the appearance of six-sided bipyramids (fig. 2) owing to the equal development of the prism *m* {110} and the pyramid *e* {122}; these crystals are black and opaque, and constitute the variety known as arkansite.

The lustre of brookite is metallic-adamantine. There is no distinct cleavage (rutile and anatase have cleavages); hardness 5½–6; sp. gr. 4.0. The optical characters are interesting: the

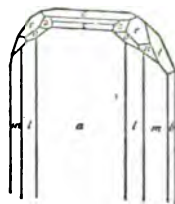

FIG. 1.

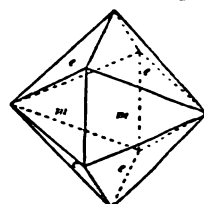

FIG. 2.

optic axes for red and for blue light lie in planes at right angles to each other, whilst for yellow-green light the crystals are uniaxial. The acute bisectrix of the optic axes is perpendicular to the orthopinacoid (*a*) for all colours, so that this phenomenon of the crossing of the optic axial planes may be readily observed in the thin tabular crystals of the first-mentioned type.

Brookite occurs only as crystals, never in compact masses, and is usually associated with either anatase or rutile. The crystals are found attached to the walls of cavities in decomposed igneous rocks and crystalline schists; it is also found as minute isolated crystals in many sedimentary rocks. The best-known locality is Fronolen near Tremadoc in North Wales, where crystals of the thin tabular habit occur with crystallized quartz, albite and anatase on the walls of crevices in diabase. Similar crystals of relatively large size are found attached to gneiss at several places in the Swiss and Tirolese Alps. Thicker crystals of prismatic, rather than tabular, habit and of a rich red colour combined with considerable transparency and brilliancy are found in the gold-washings of the Sanarka river in the southern Urals. The arkansite variety occurs with rutile in the elacolite-syenite of Magnet Cove in Hot Spring county, Arkansas. Minute crystals of brookite have been detected with anatase and rutile in the iron-ore of Cleveland in Yorkshire.

Crystals of brookite, as well as of anatase and rutile, have been prepared artificially by the interaction of steam and titanium fluoride, the particular modification of titanium dioxide which results depending on the temperature at which the reaction takes place. Brookite is liable to become altered to rutile aggregates of rutile needles with the form of brookite (arkansite) are not uncommon at Magnet Cove, Arkansas. (L. J. S.)

BROOKLIME, known botanically as *Veronica Beccabunga* (natural order Scrophulariaceae), a succulent herb growing on margins of brooks and ditches in the British Isles, and a native of Europe, north Africa and north and western Asia. It has smooth spreading branches, blunt oblong leaves and small bright blue or pink flowers.

BROOKLINE, a township of Norfolk county, Massachusetts, U.S.A., about 3 m. S.W. of Boston, lying immediately S. of the Back Bay district. Pop. (1890) 12,103; (1900) 10,935, of whom 6536 were foreign-born; (1910, census) 27,702. The area of the township in 1906 was 6.75 sq. m. It is served by the Boston & Albany railway, and is connected with Boston by an electric line. Brookline is the wealthiest of the residential suburbs of Boston; and contains a number of beautiful estates and homes. Within its limits are the villages of Cottage Farm, Longwood, and Reservoir Station, or Chestnut Hill—the Chestnut Hill reservoir is just beyond the township. Brookline has an excellent public library. At Clyde Park are the grounds and club-house of the Boston Country Club. Brookline has long been regarded as a model city suburb. It is connected with

Boston Common by boulevards of the Metropolitan Park System. The first settlement was probably made about 1635, and it was called Muddy River until 1705, when it was created a township under the name of Brookline. Up to 1793 it belonged to Suffolk county, of which Boston is a part, and since that time it has belonged to Norfolk county; but Boston has in its growth almost surrounded it, and because of its great wealth there has been a long struggle for and against its merger in Boston. Frederick Law Olmsted, the famous landscape gardener, had his home in Brookline, where there are various examples of his work.

See H. F. Woods, *Historical Sketches of Brookline* (Boston, 1874); C. K. Bolton, *Brookline, The History of a Favored Town* (Brookline, 1897); and J. W. Denehy, *History of Brookline, 1630-1906* (Allston, Mass., 1907).

BROOKLYN, formerly a city of New York state, U.S.A., but since 1898 a borough of New York City (q.v.), situated at the S.W. extremity of Long Island. It is continuous with Kings county, and is bounded N. by the borough of Queens, from which it is in part separated by Newtown Creek; E. by the borough of Queens and Jamaica Bay; S. by the Atlantic Ocean; W. by Gravesend Bay, the Narrows, Upper New York Bay and East river, which separate it from Staten Island, Jersey City and the borough of Manhattan. It has a water-front of 33 m. and extends over an area of 77.62 sq. m. Pop. (1866) 279,122; (1870) 419,921; (1880) 599,495; (1890, then Kings county) 838,547; (1900) 1,166,582; (1905, state census) 1,358,686; (1910) 1,634,351. In 1900 only 310,501, or 26.6%, were native-born of native white parents; 355,697 were foreign-born, 18,367 were negroes, and 1206 were Chinese. Out of 332,715 males of voting age (21 years and over), 15,415 were illiterate (unable to write), and of these 14,159 were foreign-born.

Brooklyn is connected with Manhattan by three bridges across the East river—the lowest, known as the Brooklyn, opened in 1883; another, known as the Williamsburg or East River bridge, opened in 1903; and a third, the Manhattan, was opened in 1909. And a tunnel directly across from the south terminus of Manhattan was completed in 1907. Ferries ply at frequent intervals between numerous points on its west water-front and points in Manhattan; there is also ferry connexion with Jersey City. Brooklyn is served directly by the Long Island railway; by about fifty regular coast-wise and trans-Atlantic steamship lines; and by elevated or surface car lines on a large number of its streets. Subway lines, begun in 1904, connect Brooklyn with the subway system of Manhattan.

Streets and Buildings.—The surface of Brooklyn in the west section, from the lower course of the East river to Gravesend Bay, varies in elevation from a few inches to nearly 200 ft. above sea-level, the highest points being in Prospect Park; but steep street grades even in this section are rare, and elsewhere the surface is either only slightly undulating or, as in the east and south, flat. Most of the streets are from 60 to 100 ft. wide. The principal business thoroughfare is Fulton Street, which begins at Fulton ferry nearly under the Brooklyn bridge, runs to City Hall Park, and thence across the north central section of the borough. In the City Hall Park are the old city hall (now the borough hall), the hall of records, and the county court-house. Two blocks to the north (on Washington Street) is the post-office, a fine granite Romanesque building. The manufacturing and shipping districts are mostly along the west water-front. Here, on Wallabout Bay at the bend of the East river to the westward, is the New York navy yard, the principal navy yard of the United States, established in 1801, and commonly but incorrectly called the Brooklyn navy yard. It occupies altogether about 144 acres, contains a trophy park, parade grounds, the United States Naval Lyceum (founded 1833), officers' quarters, barracks, and three large dry docks (respectively 564, 465 and 307 ft. long), foundries and machine shops. A naval hospital (having accommodation for about 500 patients) to the east is separated from the navy yard by the largest and most interesting of Brooklyn's markets, the Wallabout (about 45 acres). The

buildings of this market are Dutch in style and have a quaint clock tower. A little to the north of the navy yard are immense refineries of sugar. About 2 m. to the south, opposite Governor's Island, is the Atlantic Basin of 40 acres, with a wharfage of about 3 m. and brick and granite warehouses used largely for the storage of grain. A little farther south, on Gowanus Bay, is another basin, the Erie, of 161 acres, protected by a breakwater 1 m. in length, occupied by piers, warehouses, lumber depots and some of the largest dry docks in the United States; it also provides protection during winter to hundreds of canal boats. In this vicinity, too, are several yards for building yachts, launches and other boats. At the lower end of the west water-front, facing the Narrows, are a United States reservation and the harbour defences of Fort Hamilton.

For a considerable portion of its inhabitants Brooklyn is only a place of residence, their business interests being in the borough of Manhattan; hence Brooklyn has been called the "city of homes" and the "dormitory of New York." Residential districts with social lines more or less distinctly drawn are numerous. The oldest is that on Brooklyn (or Columbia) Heights, west of City Hall Park, rising abruptly from the river to a height of from 70 to 100 ft., and commanding a delightful view of the harbour. Here are hotels, large apartment-houses, many private residences and a number of clubs, including the Brooklyn, the Crescent, the Hamilton, the Jefferson and the Germania. On Park Slope, immediately west of Prospect Park, and St Mark's Avenue, in another part of the borough, are also attractive residential districts. The south shore of the borough has various summer pleasure resorts, of which Coney Island is the most popular.

Parks and Cemeteries.—One of the most attractive features of Brooklyn is Prospect Park, occupying about 516 acres of high ground in the west central part of the borough, on a site made memorable by the battle of Long Island. Its large variety of trees and shrubs, including oak, hickory, elm, maple, chestnut, birch, ash, cedar, pine, larch and sumach, its flower gardens, a palm house, ponds, a lake of 61 acres for boating, skating and curling, a parade ground of 40 acres for other athletic sports, a menagerie, and numerous pieces of statuary, are among its objects of interest or beauty. From the southern entrance to this park, Ocean Parkway, a fine boulevard, 210 ft. wide and planted with six rows of trees, extends 5½ m. south to Seaside Park (15 acres), on Brighton Beach, Coney Island. From the same entrance Fort Hamilton Parkway extends 4½ m. south-east to Fort Hamilton, and to Dyker Beach Park (144 acres) which face the lower end of the Narrows; and from Fort Hamilton, Shore Road and Bay Ridge Parkway extend north 4½ m. to Bay Ridge Park overlooking Upper New York Bay. From the northern entrance to Prospect Park, Eastern Parkway, another fine boulevard, 200 ft. wide, extends east 2½ m. to a point from which Rockaway Parkway runs 3 m. south-east to Canarsie Beach Park (40 acres), on Jamaica Bay; and extensions of Eastern Parkway run north-east through Highland Park (55 acres), to Brooklyn Forest Park (535 acres, on the border of the borough of Queens), abounding in beautiful trees and delightful views. Half a mile east of the borough hall is Washington or Fort Greene Park (30 acres), laid out on the site of earthworks (known as Fort Greene) constructed during the War of Independence, and commanding good views.

Greenwood cemetery, one of the most beautiful cemeteries in the United States, ½ m. east of Prospect Park, occupies about 478 acres. Among the principal monuments are those erected to Roger Williams, S.F.B. Morse, Elias Howe, De Witt Clinton (colossal bronze statue by Henry Kirke Brown), Henry Ward Beecher, Peter Cooper, Horace Greeley, Henry Bergh, Henry George and James Gordon Bennett. At the main entrance is a beautiful gateway (of elaborately wrought brown stone), 142 ft. wide and having a central tower 100 ft. in height. Along the north-east border of the borough are Cypress Hills cemetery (400 acres), adjoining Brooklyn Forest Park, and the cemetery of the Evergreens (about 375 acres), adjoining Highland Park and partly in the borough of Queens.

In the plaza at the northern entrance to Prospect Park is a soldiers' and sailors' memorial arch (80 ft. in width and 71 ft. in height), adorned with high-reliefs of Lincoln and Grant on horseback (by O'Donovan and Eakins) and with three large bronze groups (by Frederick MacMonnies). Immediately within the park there is a statue (also by MacMonnies) of J. S. T. Stranahan (1808-1898), who did more than any other man for the development of Brooklyn's system of parks and boulevards. On the slope of Lookout Hill (185 ft.) within the park is a shaft erected in 1895 to the memory of the Maryland soldiers who valiantly defended the rear of the American army at the battle of Long Island. A bronze statue of Abraham Lincoln overlooks the lake. In Fort Greene Park is a monument to the memory of the soldiers who died in the British prison ships during the War of Independence, many of them having been buried in a vault below. Facing the borough hall is a statue in bronze (by J. Q. A. Ward) of Henry Ward Beecher, mounted on a granite pedestal with a figure at one side to commemorate Beecher's sympathy for the slave. A fine bronze statue of Alexander Hamilton (by W. O. Partridge, b. 1861) stands at the entrance of the Hamilton Club in Clinton Street and one of U. S. Grant (also by Partridge) stands at the entrance of the Union League Club in Bedford Avenue.

Education.—The Brooklyn Institute of Arts and Sciences embraces twenty-six departments, of which those of music, philology and the fine arts have each more than 1000 members; the total membership of all departments in 1906 was 5894. The museum building of this institution is in Institute Park, which is separated from Prospect Park on the north-east by Flatbush Avenue. It contains, besides paintings and statuary, special collections for service in nearly all of the departments; among its purely art collections the most notable is that of J. J. Tissot's water-colour drawings, to illustrate the life of Christ. Since 1890 the Institute has received appropriations from the city, but it is maintained chiefly by private contributions: It is the outgrowth of the Apprentices' Library Association, founded in 1824, of which General Lafayette laid the corner-stone on the 4th of July of that year. In 1888 Franklin W. Hooper (b. 1851), who did much to increase the efficiency of the work of the Institute, became director. Pratt Institute, founded in 1887 by Charles Pratt (1830-1891), and the residuary legatee of his wife, who died in 1907, is one of the most successful manual and industrial training schools in the country, and its kindergarten normal is one of the best known in the United States. The Polytechnic Institute, opened in 1855, is a high-grade school of science and liberal arts. It has two general departments, the college of arts and engineering and the preparatory school, which are conducted independently of one another. In connexion with the college there is provision for graduate study and for night courses, and there are teachers' courses to which women are admitted. The Packer Collegiate Institute, opened as the successor of the Brooklyn Female Academy, in 1854, and endowed by Mrs Harriet L. Packer, an institution for women, has primary, preparatory, academic and collegiate departments. Adelphi College, opened in 1896, is for both sexes and gives special attention to normal training; it is the outgrowth of Adelphi Academy, founded in 1869, now the preparatory department. St Francis' College, opened in 1858, and St John's College, opened in 1870, are institutions maintained by Roman Catholics. Here, too, are the law school of St Lawrence University, the Long Island Hospital Medical College, with a training school for nurses, the Brooklyn College of Pharmacy and several schools of music. Brooklyn's public schools rank especially high; among them there is a commercial high school and a manual training high school. Among the larger libraries of the borough are the Brooklyn public library, those of the Long Island Historical Society, on Brooklyn Heights, of Pratt Institute, and of the King's County Medical Society, and a good law library. The *Brooklyn Daily Eagle*, which occupies an attractive building near the borough hall, has been a newspaper of strong influence in the community. It was established in 1841 as a Democratic organ, and Walt Whitman was its editor for about a year during its early history.

Brooklyn is well provided with charitable institutions, and has long been known as the "city of churches," probably from the famous clergymen who have lived there. Among them were Henry Ward Beecher, pastor of Plymouth church (Congregational) from 1847 to 1887; Lyman Abbott, pastor of the same church from 1887 to 1898; Thomas De Witt Talmage, pastor of the Brooklyn Tabernacle (Presbyterian) from 1860 to 1894; Richard Salter Storrs (1821-1900), pastor of the church of the Pilgrims (Congregational) from 1846 to 1899; and Theodore L. Cuyler (1822-1909), pastor of the Lafayette Avenue Presbyterian church from 1860 to 1890.

Manufactures and Commerce.—The borough of Brooklyn is one of the most important manufacturing centres in the United States, most of the factories being located along or near the East river north of the Brooklyn bridge. The total value of the manufactured products in 1890 was \$270,823,754 and in 1900, \$342,127,124, an increase during the decade of 26.1%. In 1905 the total value of the borough's manufactured product (under the factory system) was \$373,462,630, or 15% of the total manufactured product of the state of New York. Brooklyn's largest manufacturing industry is the refining of sugar, about one-half of the sugar consumed in the United States being refined here; in 1900 the product of the sugar and molasses refining establishments was valued at \$77,942,997. Brooklyn is also an important place for the milling of coffee and spices (the 1905 product was valued at \$15,274,092), the building of steel boats, and the manufacture of foundry and machine shop products, malt liquors, barrels, shoes, chemicals, paints, cordage twine, and hosiery and other knitted goods. Of its large commerce, grain is the chief commodity; it is estimated that about four-fifths of that exported from the port of New York is shipped from here, and the borough's grain elevators have an estimated storage capacity of about 20,000,000 bushels.

The water-supply system is owned and operated by the borough; the water is derived from streams flowing southward in the sparsely settled area east of the borough, and also from driven wells in the same region; it is pumped by ten engines at Ridgewood to a reservoir having a capacity of about 300,000,000 gallons, while a part of it is re-pumped to a high service reservoir near the north entrance to Prospect Park for the service of the most elevated part of the borough. Besides this system several towns in the south section recently annexed have their own water-supply.

History.—The first settlement within the present limits of Brooklyn was made in 1636, when some Dutch farmers took up their residence along the shore of Gowanus Bay. About the same time other Dutch farmers founded Flatlands (at first called Amersfoort), on Jamaica Bay, and a few Walloons founded Wallabout, where the navy yard now is. In 1642 a ferry was established across East river from the present foot of Flatbush Street, and a settlement grew up here which was known as The Ferry. The next year Lady Deborah Moody with some followers from New England founded Gravesend near the southern extremity of the borough. Finally, in the year 1651 a settlement was established near the site of the present borough hall, and was called Breucklen (also spelled Breucklyn, Breuckland, Brucklyn, Broucklyn, Brookland and Brookline) until about the close of the 18th century, when its orthography became fixed as Brooklyn. The name, Breuckelen, meaning marsh-land, seems to have been suggested by the resemblance of the situation of the settlement to that of Breuckelen, Holland. Of the other towns which were later united to form the borough, New Utrecht was settled about 1650, Flatbush (at first called Midwout or Midwood) about 1651, Bushwick and Williamsburg in 1660. All of the settlements were for a long time chiefly agricultural communities. Flatbush was for a few years immediately preceding 1675 the largest; but Brooklyn was the first (1646) to have a township organization, and within a few years Wallabout, Gowanus, The Ferry, and Bedford—a new settlement to the south-east of Wallabout, established in 1662—were included within its jurisdiction. In 1654 the municipal privileges of Brooklyn as well as of two of the other towns were enlarged.

but with Dutch rule there was general discontent, and when, in 1664, Colonel Richard Nicolls came to overthrow it and establish English rule these towns offered no resistance. Nicolls erected the region composed of Long Island, Staten Island and Westchester into a county under the name of Yorkshire, and divided it into three ridings, of which Staten Island, the present county of Kings, and the town of Newtown in Queens, formed one. In 1683 the present county of Kings was organized by the first colonial legislature. During the War of Independence the chief event was the battle of Long Island, fought on the 27th of August 1776. In 1816, when the population of the town of Brooklyn was about 4500, its most populous section was incorporated as a village; and in 1834, when its population had increased to 23,310, the whole town was incorporated as a city. By 1850 its population had increased to 138,882. In 1855 Williamsburg, which had been incorporated as a city in 1851, and the town of Bushwick were annexed. Other annexations followed until the city of Brooklyn was continuous with Kings county; and finally, on the 1st of January 1898, the city of Brooklyn became a borough of New York City.

See S. M. Ostrander, *A History of Brooklyn and Kings County* (Brooklyn, 1894); H. W. B. Howard (ed.), *History of the City of Brooklyn* (Brooklyn, 1893); and H. Putnam, *Brooklyn*, in L. P. Powell's *Historic Towns of the Middle States* (New York, 1899).

BROOKS, CHARLES WILLIAM SHIRLEY (1816-1874), English novelist, playwright and journalist, was born on the 30th of April 1816. He was the son of a London architect, and was articled in 1832 to a solicitor for five years. He became parliamentary reporter for the *Morning Chronicle*, and in 1853 was sent by that paper as special commissioner to investigate the subject of labour and the poor in southern Russia, Egypt and Syria; the result of his inquiries appearing first in the form of letters to the editor, and afterwards in a separate volume, under the title of *The Russians of the South* (1856). He wrote, sometimes alone, sometimes in conjunction with others, slight dramatic pieces of the burlesque kind, among which may be mentioned *Anything for a Change* (1848), *The Daughter of the Stars* (1850). Brooks was for many years on the staff of the *Illustrated London News*, contributing the weekly article on the politics of the day, and the two series entitled "Nothing in the Papers" and "By the Way." In 1851 he joined the staff of *Punch*, and noteworthy among his numerous contributions were the weekly satirical summaries of the parliamentary debates, entitled "The Essence of Parliament." His long service as newspaper reporter gave him special aptitude for this playful parody. In 1870, on the death of Mark Lemon, "dear old Shirley," as his friends used to call him, was chosen to succeed to the editorial chair. His first novel, *Aspen Court*, was published in 1855. It was followed by *The Gordian Knot* (1860), *The Silver Cord* (1861) and *Sooner or Later* (1868). Brooks was a great letter-writer, deliberately cultivating the practice as an art, and imitating the style in vogue before newspapers and telegraphs suppressed private letters. He had an astonishing memory, was brilliant as an epigrammatist, was a great reader and a most genial companion. He was in his element with a group of children, reading to them, sharing their fun and always remembering the birthdays. He died in London, on the 23rd of February 1874, and was buried near his friends Leach and Thackeray, in Kensal Green cemetery.

See C. S. Layard, *A Great "Punch" Editor: Being the Life, Letters and Diaries of Shirley Brooks* (1907.)

BROOKS, PHILLIPS (1835-1893), American clergyman and author, was born in Boston, Mass., on the 13th of December 1835. Through his father, William Gray Brooks, he was descended from the Rev. John Cotton; through his mother, Mary Ann Phillips, a woman of rare force of character and religious faith, he was a great-grandson of the founder of Phillips Academy, Andover, Mass. Of the six sons, four—Phillips, Frederic, Arthur and John Cotton—entered the ministry of the Protestant Episcopal Church. Phillips Brooks prepared for college at the Boston Latin school and graduated at Harvard in 1855. After a short and unsuccessful experience as a teacher

in the Boston Latin school, he began in 1856 to study for the ministry of the Protestant Episcopal Church in the theological seminary at Alexandria, Virginia. In 1859 he graduated, was ordained deacon by Bishop William Meade of Virginia, and became rector of the church of the Advent, Philadelphia. In 1860 he was ordained priest, and in 1862 became rector of the church of the Holy Trinity, Philadelphia, where he remained seven years, gaining an increasing name as preacher and patriot. Endowed by inheritance with a rich religious character, evangelical traditions, ethical temper and strong intellect, he developed, by wide reading in ancient and modern literature, a personality and attitude of mind which appealed to the characteristic thought and life of the period. With Tennyson, Coleridge, Frederic D. Maurice and F. W. Robertson he was in strong sympathy. During the Civil War he upheld with power the cause of the North and the negro, and his sermon on the death of President Lincoln was an eloquent expression of the character of both men. In 1869 he became rector of Trinity church, Boston. In 1877 the present church was finished, the architect being his friend H. H. Richardson. Here Phillips Brooks preached Sunday after Sunday to great congregations, until he was consecrated bishop of Massachusetts in 1891. In 1886 he declined an election as assistant bishop of Pennsylvania. He was for many years an overseer and preacher of Harvard University, his influence upon the religious life of the university being deep and wide. In 1881 he declined an invitation to be the sole preacher to the university and professor of Christian ethics. On the 30th of April 1891 he was elected sixth bishop of Massachusetts, and on the 14th of October was consecrated to that office in Trinity church, Boston. After a brief but great episcopate of fifteen months, he died, unmarried, on the 23rd of January 1893. Phillips Brooks was a tall, well-proportioned man of fine physique, his height being six feet four inches. In character he was pure, simple, endowed with excellent judgment and a keen sense of humour, and quick to respond to any call for sympathy. When kindled by his subject it seemed to take possession of him and pour itself out with overwhelming speed of utterance, with heat and power. His sympathy with men of other ways and thought, and with the truth in other ecclesiastical systems gained for him the confidence and affection of men of varied habits of mind and religious traditions, and was thus a great factor in gaining increasing support for the Episcopal Church. As years went by his influence as a religious leader became unique. The degree of S.T.D. had been conferred upon him by the universities of Harvard (1877), and of Columbia (1887), and the degree of D.D. by the university of Oxford, England (1885). In 1877 he published a course of lectures upon preaching, which he had delivered at the theological school of Yale University, and which are an expression of his own experience. In 1879 appeared the Bohlen Lectures on "The Influence of Jesus." In 1878 he published his first volume of sermons, and from time to time issued other volumes, including *Sermons Preached in English Churches* (1883).

In 1901, at New York, was published, in two volumes, *Phillips Brooks, Life and Letters*, by the Rev. A. V. G. Allen, D.D., professor of ecclesiastical history, Episcopal Theological school, Cambridge, Mass., who in 1907 published at New York, in a single volume, *Phillips Brooks*, an abbreviation and revision of the earlier biography. (W. L.)

BROOKS'S, a London club in St James's Street. It was founded in 1764 by the dukes of Roxburghe and Portland. The building had been previously opened as a gaming-house by William Macall (Almack), and afterwards by Brooks, a wine merchant and money-lender, whose name it retained.

BROOM, known botanically as *Cytisus*, or *Sarothamnus scoparius*, a member of the natural order Leguminosae, a shrub found on heaths and commons in the British Isles, and also in Europe (except the north) and temperate Asia. The leaves are small, and the function of carbon-assimilating is shared by the green stems. The bright yellow flowers scatter their pollen by an explosive mechanism; the weight of a bee alighting on the flower causes the keel to split and the pollen to be shot out on to the insect's body. When ripe the black pods explode with a

sudden twisting of the valves and scatter the seeds. The twigs have a bitter and nauseous taste and have long had a popular reputation as a diuretic; the seeds have similar properties.

"Butcher's broom," a very different plant, known botanically as *Ruscus aculeatus*, is a member of the natural order Liliaceae. It is a small evergreen shrub found in copses and woods, but rare

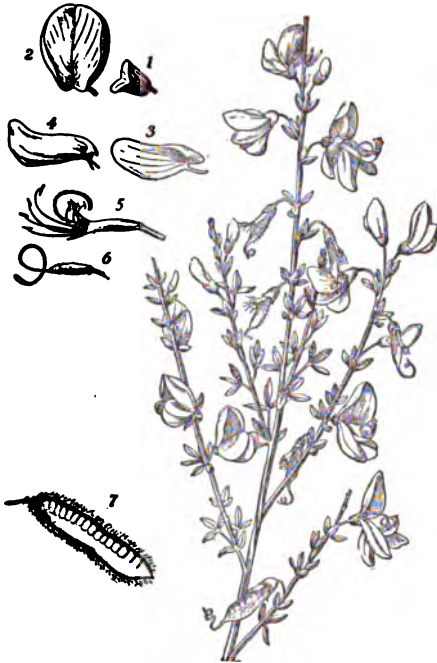

Cytisus scoparius, Common Broom.

1. Two-lipped calyx.
2. Broadly ovate vexillum or standard.
3. One of the alae or wings of the corolla.
4. Carina or keel.
5. Monadelphous stamens.
6. Hairy ovary with the long style, thickened upwards, and spirally curved.
7. Legume or pod.

in the southern half of England. The stout angular stems bear leaves reduced to small scales, which subtend flattened leaf-like branches (cladodes) with a sharp apex. The small whitish flowers are borne on the face of the cladodes, and are succeeded by a bright red berry.

BROOME, WILLIAM (1689-1745), English scholar and poet, the son of a farmer, was born at Haslington, Cheshire, where he was baptized on the 3rd of May 1689. He was educated at Eton, where he became captain of the school, and at St John's College, Cambridge. He collaborated with John Ozell and William Oldisworth in a translation (1712) of the *Iliad* from the French version of Madame Dacier, and he contributed in the same year some verses to *Lintot's Miscellany*. He was introduced to Pope, who was at that time engaged on his translation of the *Iliad*. Pope asked Broome to make a digest for him of the notes of Eustathius, the 12th-century annotator of Homer. This task Broome executed to Pope's entire satisfaction, refusing any payment. He was rector of Sturston, Norfolk, and his prosperity was further assured by his marriage in 1716 with a rich widow, Mrs Elizabeth Clarke. When Pope undertook the translation of the *Odyssey*, he engaged Elijah Fenton and Broome to assist him. Broome's facility in verse had gained for him at college the nickname of "the poet," and he adapted his style very closely to Pope's. He translated the 2nd, 6th, 8th, 11th, 12th,

16th, 18th and 23rd books, and practically provided all the notes. He was a vain, talkative man, and did not fail to make known his real share in the translation, of which Pope had given a very misleading account in the "proposals" issued to subscribers. He casually mentioned Broome as his coadjutor, as though his assistance was of an entirely subsidiary character. His influence over Broome was so strong that the latter was induced to write a note at the end of the translation minimizing his own share and implicating Fenton, who, moreover, had not wished his name to appear, in the deception. "If my performance," he said, "has merit either in these [the notes] or in any part of the translation, namely the 6th, 11th and 18th books, it is but just to attribute it to the judgment and care of Mr Pope, by whose hand every sheet was corrected." For the *Odyssey* Pope received £4500, of which Broome, who had provided a third of the text and the notes, received £570. He had hoped to secure fame from his connexion with Pope, and when he found that Pope had no intention of praising him he complained bitterly of being underpaid. Pope thought that Broome's garrulity had caused the reports which were being circulated to his disadvantage, and ungenerously made satirical allusions to him in the *Dunciad* and the *Bathos*. After these insults Broome's patience gave way, and there is a gap in his correspondence with Pope, but in 1730 the intercourse was renewed on friendly terms. In 1728 the degree of LL.D. was conferred on him by the university of Cambridge, and he was presented to the rectory of Pulham, Norfolk, and subsequently by Charles, 1st Earl Cornwallis, who had been his friend at Cambridge, to two livings, Oakley Magna in Essex, and Eye in Suffolk. He died at Bath on the 16th of November 1745.

Broome was also the author of some translations from Anacreon printed in the *Gentleman's Magazine*, and of *Poems on Several Occasions* (1727). His poems are included in Johnson's and other collections of the British poets. His connexion with Pope is exhaustively discussed in Elwin and Courthope's edition of *Pope's Works* (viii. pp. 30-186), where the correspondence between the two is reproduced.

BROOM-RAPE, known botanically as *Orobancha*, a genus of brown leafless herbs growing attached to the roots of other plants from which they derive their nourishment. The usually stout stem bears brownish scales, and ends in a spike of yellow, reddish-brown or purplish flowers, with a gaping two-lipped corolla. Several species occur in the British Isles; the largest, *Orobancha major*, is parasitic on roots of shrubby leguminous plants, and has a stout stem 1 to 2 ft. high.

BROSCH, MORITZ (1829-1907), German historian, was born at Prague on the 7th of April 1829, was educated at Prague and Vienna, and became a journalist. Later he devoted himself to historical study, and he died on the 14th of July 1907 at Venice, where he had resided for over thirty years. To the series *Geschichte der europäischen Staaten* Brosch contributed *England 1509-1850* (6 vols., Gotha, 1884-1899), a continuation of the work of J. M. Lappenberg and R. Pauli, and *Der Kirchenstaat* (Gotha, 1880-1882). He gave further proof of his interest in English history by writing *Lord Bolingbroke und die Whigs und Tories seiner Zeit* (Frankfurt, 1883), and *Oliver Cromwell und die puritanische Revolution* (Frankfurt, 1886). He also wrote *Johann II. und die Gründung des Kirchenstaats* (Gotha, 1878), while one of his last pieces of work was to contribute a chapter on "The height of the Ottoman power" to vol. iii. of the *Cambridge Modern History*.

See A. W. Ward in the *English Historical Review*, vol. xxii. (1907).

BROSELEY, a market town in the municipal borough of Wenlock (q.v.) and the Wellington (Mid) parliamentary division of Shropshire, England, on the right bank of the Severn. It has a station (Ironbridge and Broseley) on the Great Western railway, 158 m. N.W. from London. There is trade in coal, but

¹ i. 146, "worthy Settle Banks and Broome." A footnote (1743) explained away the allusion by making it apply to Richard Broome, the disciple of Ben Jonson. Also iii. 332, of which the original rendering was:—

"Hibernian politics, O Swift, thy doom.

And Pope's, translating tea whole years with Broome."

In the *Bathos* he was clasped with the parrots and the tortoises.

the town is most famous for the manufacture of tobacco-pipes, a long-established industry. Pottery and bricks are also produced, and at Benthall, 1 m. W., are large encaustic tile works. The early name of the town was Burwardesley.

BROSSES, CHARLES DE (1709-1777), French magistrate and scholar, was born at Dijon and studied law with a view to the magistracy. The bent of his mind, however, was towards literature and science, and, after a visit to Italy in 1739 in company with his friend Jean Baptiste de Lacurne de Sainte-Palaye, he published his *Lettres sur l'état actuel de la ville souterraine d'Hercule* (Dijon, 1750), the first work upon the ruins of Herculanum. It was during this Italian tour that he wrote his famous letters on Italy, which remained in MS. till long after his death. In 1760 he published a dissertation, *Du culte des dieux fétiches*, which was afterwards inserted in the *Encyclopédie méthodique*. At the solicitation of his friend Buffon, he undertook his *Histoire des navigations aux terres australes*, which was published in 1756, in two vols. 4to, with maps. It was in this work that de Brosse first laid down the geographical divisions of Australasia and Polynesia, which were afterwards adopted by John Pinkerton and succeeding geographers. He also contributed to the *Encyclopédie* the articles "Langues," "Musique," "Étymologie." In 1765 appeared his work on the origin of language, *Traité de la formation mécanique des langues*, the merits of which are recognized by E. B. Tylor in *Primitive Culture*. De Brosse had been occupied, during a great part of his life, on a translation of Sallust, and in attempting to supply the lost chapters in that celebrated historian. At length in 1777 he published *L'Histoire du septième siècle de la république romaine*, 3 vols. 4to, to which is prefixed a learned life of Sallust, reprinted at the commencement of the translation of that historian by Jean Baptiste Dureau de La Malle. These literary occupations did not prevent the author from discharging with ability his official duties as first president of the parliament of Burgundy, nor from carrying on a constant and extensive correspondence with the most distinguished literary characters of his time. In 1758 he succeeded the marquis de Caumont in the Académie des Belles-lettres; but when in 1770 he presented himself at the French Academy, his candidature was rejected owing to Voltaire's opposition on personal grounds. Besides the works already mentioned, he wrote several memoirs and dissertations in the collections of the Academy of Inscriptions, and in those of the Academy of Dijon, and he left behind him several MSS., which were unfortunately lost during the Revolution. His letters on Italy were, however, found in MS. in the confiscated library by his son, the émigré officer René de Brosse, and were first published in 1790, in the uncritical edition of Antoine Serieys, under the title of *Lettres historiques et critiques*. A fresh edition, freed from errors and interpolations, by R. Colomb, with the title *L'Italie il y a cent ans*, was issued in 1836; and two subsequent reprints appeared, one edited by Poulet-Malassis, under the title *Lettres familières* (1858); the other, a re-impression of Colomb's edition, under that of *Le Président de Brosse en Italie* (1858).

See H. Mamet, *Le Président de Brosse, sa vie et ses ouvrages* (Lille, 1874); also Cunisset-Carnot, "La Querelle de Voltaire et du président de Brosse," in the *Revue des Deux Mondes* (February 15, 1888).

BROTHER, a male person in his relation to the other children of the same father and mother. "Brother" represents in English the Teutonic branch of a word common to the Indo-European languages, cf. Ger. *Bruder*, Dutch *broeder*, Dan. and Swed. *broder*, &c. In Celtic languages, Gaelic and Irish have *brathair*, and Welsh *bradw*; in Greek the word is *φάτρης*, in Lat. *frater*, from which come the Romanic forms, Fr. *frère*, Ital. *fratello*; the Span. *fray*, Port. *frés*, like the Ital. *frate*, *fra*, are only used of "friars." The Span. *hermano* and the Port. *irmão*, the regular words for brother, are from Lat. *germanus*, born of the same father and mother. The Sanskrit word is *bhrâter*, and the ultimate Indo-European root is generally taken to be *bhor*, to bear (cf. M. H. Ger. *barn*, Scot. *barin*, child, and such words as "birth," "burden"). "Brother" has often been loosely used of kinsmen generally, or for members of the same

tribe; also for quite fictitious relationships, e.g. "blood-brothers," through a sacramental rite of mutual blood-tasting, "foster-brothers," because suckled by the same nurse. Christianity, through the idea of the universal fatherhood of God, conceives all men as brothers; but in a narrower sense "the brethren" are the members of the Church, or, in a narrower still, of a confraternity or "brotherhood" within the Church. This latter idea is reproduced in those fraternal societies, e.g. the Freemasons, the members of which become "brothers" by initiation. "Brother" is also used symbolically, as implying equality, by sovereigns in addressing one another, and also by bishops.

BROTHERS, RICHARD (1757-1824), British religious fanatic, was born in Newfoundland on Christmas day, 1757, and educated at Woolwich. He entered the navy and served under Keppel and Rodney. In 1783 he became lieutenant, and was discharged on half-pay. He travelled on the continent, made an unhappy marriage in 1786, and again went to sea. But he felt that the military calling and Christianity were incompatible and abandoned the former (1789). Further scruples as to the oath required on the receipt of his half-pay reduced him to serious pecuniary straits (1791), and he divided his time between the open air and the workhouse, where he developed the idea that he had a special divine commission, and wrote to the king and the parliament to that effect. In 1793 he declared himself the apostle of a new religion, "the nephew of the Almighty, and prince of the Hebrews, appointed to lead them to the land of Canaan." At the end of 1794 he began to print his interpretations of prophecy, his first book being *A Revealed Knowledge of the Prophecies and Times*. In consequence of prophesying the death of the king and the end of the monarchy, he was arrested for treason in 1795, and confined as a criminal lunatic. His case was, however, brought before parliament by his ardent disciple, Nathaniel Halhed, the orientalist, a member of the House of Commons, and he was removed to a private asylum in Islington. Here he wrote a variety of prophetic pamphlets, which gained him many believers, amongst them William Sharp, the engraver, who afterwards deserted him for Joanna Southcott. Brothers, however, had announced that on the 10th of November 1795 he was to be "revealed" as prince of the Hebrews and ruler of the world; and when this date passed without any such manifestation, what enthusiasm he had aroused rapidly dwindled, despite the fact that some of his earlier political predictions (e.g. the violent death of Louis XVI.) had been fulfilled. He died in London on the 25th of January 1824, in the house of John Finlayson, who had secured his release, and who afterwards pestered the government with an enormous claim for Brothers's maintenance. The supporters of the Anglo-Israelite theory claim him as the first writer on their side.

BROTHERS OF COMMON LIFE, a religious community formerly existing in the Catholic Church. Towards the end of his career Gerhard Groot (q.v.) retired to his native town of Deventer, in the province of Overijssel and the diocese of Utrecht, and gathered around him a number of those who had been "converted" by his preaching or wished to place themselves under his spiritual guidance. With the assistance of Florentius Radewyn, who resigned for the purpose a canonry at Utrecht, he was able to carry out a long-cherished idea of establishing a house wherein devout men might live in community without the monastic vows. The first such community was established at Deventer in the house of Florentius himself (c. 1380), and Thomas à Kempis, who lived in it from 1399 to 1399, has left a description of the manner of life pursued.—

"They humbly imitated the manner of the Apostolic life, and having one heart and mind in God, brought every man what was his own into the common stock, and receiving simple food and clothing avoided taking thought for the morrow. Of their own will they devoted themselves to God, and all busied themselves in obeying their rector or his vicar. . . . They laboured carefully in copying books, being instant continually in sacred study and devout meditation. In the morning having said Matins, they went to the church (for Mass). . . . Some who were priests and were learned in the divine law preached earnestly in the church."

Other houses of the Brothers of Common Life, otherwise called the "Modern Devotion," were in rapid succession established in the chief cities of the Low Countries and north and central Germany, so that there were in all upwards of forty houses of men; while those of women doubled that figure, the first having been founded by Groot himself at Deventer.

The ground-idea was to reproduce the life of the first Christians as described in Acts iv. The members took no vows and were free to leave when they chose; but so long as they remained they were bound to observe chastity, to practise personal poverty, putting all their money and earnings into the common fund, to obey the rules of the house and the commands of the rector, and to exercise themselves in self-denial, humility and piety. The rector was chosen by the community and was not necessarily a priest, though in each house there were a few priests and clerics. The majority, however, were laymen, of all kinds and degrees—nobles, artisans, scholars, students, labouring men. The clerics preached and instructed the people, working chiefly among the poor; they also devoted themselves to the copying of manuscripts, in order thereby to earn something for the common fund; and some of them taught in the schools. Of the laymen, the educated copied manuscripts, the others worked at various handicrafts or at agriculture. After the religious services of the morning the Brothers scattered for the day's work, the artisans going to the workshops in the city,—for the idea was to live and work in the world, and not separated from it, like the monks. Their rule was that they had to earn their livelihood, and must not beg. This feature seemed a reflection on the mendicant orders, and the idea of a community life without vows and not in isolation from everyday life, was looked upon as something new and strange, and even as bearing affinities to the Beghards and other sects, at that time causing trouble to both Church and state. And so opposition arose to the Modern Devotion, and the controversy was carried to the legal faculty at Cologne University, which gave a judgment strongly in their favour. The question, for all that, was not finally settled until the council of Constance (1414), when their cause was triumphantly defended by Pierre d'Ailly and Gerson. For a century after this the Modern Devotion flourished exceedingly, and its influence on the revival of religion in the Netherlands and north Germany in the 15th century was wide and deep. It has been the fashion to treat Groot and the Brothers of Common Life as "Reformers before the Reformation"; but Schulze, in the Protestant *Realencyklopädie*, is surely right in pronouncing this view quite unhistorical—except on the theory that all interior spiritual religion is Protestant: he shows that at the Reformation hardly any of the Brothers embraced Lutheranism, only a single community going over as a body to the new religion. During the second half of the 16th century the institute gradually declined, and by the middle of the 17th all its houses had ceased to exist.

AUTHORITIES.—The chief authorities are Thomas à Kempis, *Lines of Groot and his Disciples* and *Chronicle of Mount St Agnes* (both works translated by J. P. Arthur, the former under the title *Founders of the New Devotion*, 1905); Busch, *Chronicle of Windesheim* (ed. Grube, 1887). Much has been written on the subject in Dutch and German; in English, S. Kettlewell, *Thomas à Kempis and the Brothers of Common Life* (1882) (but see Arthur in the Prefaces to above-named books); for a shorter sketch, F. R. Cruise, *Thomas à Kempis* (1887). An excellent article in Herzog-Hauck, *Realencyklopädie* (3rd ed.), "Brüder des gemeinsamen Lebens," supplies copious information with references to all the literature; see also Max Heimbücher, *Orden und Kongregationen* (1897), ii. § 123. The part played by the Brothers of Common Life in the religious and educational movements of the time may be studied in Ludwig Pastor's *History of the Popes from the close of the Middle Ages*, or J. Janssen's *History of the German People*. (E. C. B.)

BROUGH, ROBERT (1872–1905), British painter, was born at Invergordon, Ross-shire. He was educated at Aberdeen, and, whilst apprenticed for over six years as lithographer to Messrs Gibb & Co., attended the night classes at the local art school. He then entered the Royal Scottish Academy, and in the first year took the Stuart prize for figure painting, the Chalmers painting bursary, and the MacLaine-Walters medal for com-

position. After two years in Paris under J. P. Laurens and Benjamin-Constant at Julian's atelier, he settled in Aberdeen in 1894 as a portrait painter and political cartoonist. A portrait of Mr W. D. Ross first drew attention to his talent in 1896, and in the following year he scored a marked success at the Royal Academy with his "Fantaisie en Folie," now at the National Gallery of British Art (Tate Gallery). Two of his paintings, "Twist Sun and Moon" and "Childhood of St Anne of Brittany," are at the Venice municipal gallery. Brough's art is influenced by Raeburn and by modern French training, but it strikes a very personal note. Robert Brough met his death from injuries received in a railway disaster in 1905, his early death being a notable loss to British art.

BROUGHAM, JOHN (1814–1880), British actor, was born at Dublin on the 6th of May 1814, and was educated for a surgeon. Owing to family misfortunes he was thrown upon his own resources and made his first appearance on the London stage in 1830, at the Tottenham Street theatre in *Tom and Jerry*, in which he played six characters. In 1831 he was a member of Madame Vestris's company, and wrote his first play, a burlesque. He remained with Madame Vestris as long as she and Charles Mathews retained Covent Garden, and he collaborated with Dion Boucicault in writing *London Assurance*, Dazzle being one of his best parts. In 1840 he managed the Lyceum theatre, for which he wrote several light burlesques, but in 1842 he moved to the United States, where he became a member of W. E. Burton's company, for which he wrote several comedies. Later he was the manager of Niblo's Garden, and in 1850 opened Brougham's Lyceum, which, like his next speculation, the lease of the Bowery theatre, was not financially a success. He was later connected with Wallack's and Daly's theatres, and wrote plays for both. In 1860 he returned to London, where he adapted or wrote several plays, including *The Duke's Men* for Fechter. After the Civil War he returned to New York. Brougham's theatre was opened in 1869 with his comedy *Better Late than Never*, but this managerial experience was also unfortunate, and he took to playing with various stock companies. His last appearance was in 1879 as O'Reilly, the detective, in Boucicault's *Rescued*, and he died in New York on the 7th of June 1880. Brougham was the author of nearly 100 plays, most of them now forgotten. He was the founder of the Lotus Club in New York, and for a time its president. He also edited there in 1852 a comic paper called *The Lantern*, and published two collections of miscellaneous writings, *A Basket of Chips* and *The Bunby Papers*. Brougham is said to have been the original of Harry Lorrequer in Charles Lever's novel. He was twice married, in 1838 to Emma Williams (d. 1865), and in 1841 to Mrs Annette Hawley (d. 1870), both actresses.

BROUGHAM, a four-wheeled closed carriage, seating two or more persons, and drawn by a single horse or pair, or propelled by motor. The modern "brougham" has developed and taken its name from the "odd little kind of garden-chair" described by Thomas Moore, which the first Lord Brougham had made by a coachmaker to his own design.

BROUGHAM AND VAUX, HENRY PETER BROUGHAM, 1ST BARON (1778–1868), lord chancellor of England, was born at Edinburgh on the 19th of September 1778. He was the eldest son of Henry Brougham and Eleanor, daughter of the Rev. James Syme. In his later years he was wont to trace his paternal descent to Uduardus de Broham, in the reign of Henry II., but no real connexion has been established between the ancient lords of Brougham castle, whose inheritance passed by marriage from the Viponts into the family of the De Cliffords, and the Broughams of Scales Hall, from whom the chancellor was really descended. Entering the high school of Edinburgh when barely seven, he left, having risen to be head of the school in 1791. He entered the university of Edinburgh in 1792, and devoted himself chiefly to the study of natural science and mathematics, contributing in 1795 a paper to the Royal Society on some new phenomenon of light and colours, which was printed in the *Transactions* of that body. A paper on poisons was published in the same manner in 1798, and in 1803 his scientific

reputation was so far established that he was elected F.R.S. But in spite of his taste for mathematical reasoning, Brougham's mind was not an accurate or exact one; and his pursuit of physical science was rather a favourite recreation than a solid advantage to him.

For two years of his university career he had attended lectures in civil law, and having adopted law as a profession he was admitted to the faculty of advocates in 1800. It does not appear that he ever held a brief in the court of session, but he went a circuit or two, where he defended or prosecuted a few prisoners, and played a series of tricks on the presiding judge, Lord Eskgrove, which almost drove that learned person to distraction. The Scottish bar, however, as he soon perceived, offered no field sufficiently ample for his talents and his ambition. He resolved to go to London, where he had already appeared as junior counsel in a Scottish appeal to the House of Lords. In 1803 he entered at Lincoln's Inn, and in 1808 he was called to the English bar. In the meantime he had turned to literature as a means of subsistence. When in 1802 the *Edinburgh Review* was founded by the young and aspiring lights of the northern metropolis, Brougham was the most ready, the most versatile and the most satirical of all its contributors. To the first twenty numbers he contributed eighty articles, wandering through every imaginable subject,—science, politics, colonial policy, literature, poetry, surgery, mathematics and the fine arts. The prodigious success of the *Review*, and the power he was known to wield in it, made him a man of mark from his first arrival in London. He obtained the friendship of Lord Grey and the leading Whig politicians. His wit and gaiety made him an ornament of society, and he sought to extend his literary and political reputation by the publication of an elaborate work on the colonial policy of the empire. In 1806, Fox being then in office, he was appointed secretary to a mission of Lord Rosslyn and Lord St Vincent to the court of Lisbon, with a view to counteract the anticipated French invasion of Portugal. The mission lasted two or three months; Brougham came home out of humour and out of pocket; and meantime the death of Fox put an end to the hopes of the Whigs.

Brougham was disappointed by the abrupt fall of the ministry, and piqued that his Whig friends had not provided him with a seat in parliament. Nevertheless, he exerted his pen with prodigious activity during the election of 1809; and Lord Holland declared that he had filled the booksellers' shops with articles and pamphlets. The result was small. No seat was placed at his disposal, and he was too poor to contest a borough. He was fortunate at this time to ally himself with the movement for the abolition of the slave-trade, and he remained through life not only faithful, but passionately attached to the cause. Indeed, one of the first measures he carried in the House of Commons was a bill to make the slave-trade felony, and he had the happiness, as chancellor of England, to take a part in the final measure of negro emancipation throughout the colonies.

Previous to his entering on practice at the English bar, Brougham had acquired some knowledge of international law, and some experience of the prize courts. This circumstance probably led to his being retained as counsel for the Liverpool merchants who had petitioned both Houses of Parliament against the Orders in Council. Brougham conducted the lengthened inquiry which took place at the bar of the House, and he displayed on this occasion a mastery over the principles of political economy and international law which at that time was rare. Nevertheless, he was unsuccessful, and it was not until 1812, when he was himself in parliament, that he resumed his attack on the Orders in Council, and ultimately conquered. It was considered inexpedient and impossible that a man so gifted, and so popular as Brougham had now become, should remain out of parliament, and by the influence of Lord Holland the duke of Bedford was induced to return him to the House of Commons for the borough of Camelford. He took his seat early in 1810, having made a vow that he would not open his mouth for a month. The vow was kept, but kept for that month only. He spoke in March in condemnation of the conduct of Lord Chatham at Walcheren,

and he went on speaking for the rest of his life. In four months such was the position he had acquired in the House that he was regarded as a candidate for the leadership of the Liberal party, then in the feeble hands of George Ponsoby. However, the Tories continued in power. Parliament was dissolved. Camelford passed into other hands. Brougham was induced to stand for Liverpool, with Thomas Creevey against Canning and General Gascoyne. The Liberals were defeated by a large majority, and what made the sting of defeat more keen was that Creevey retained his old seat for Thetford, while Brougham was left out in the cold.

He remained out of parliament during the four eventful years from 1812 to 1816, which witnessed the termination of the war, and he did not conceal his resentment against the Whigs. But in the years he spent out of parliament occurrences took place which gave ample employment to his bustling activity, and led the way to one of the most important passages of his life. He had been introduced in 1809 to the princess of Wales (afterwards Queen Caroline). But it was not till 1812 that the princess consulted him on her private affairs, after the rupture between the prince regent and the Whigs had become more decided. From that time, Brougham, in conjunction with Samuel Whitbread, became one of the princess's chief advisers; he was attached to her service, not so much from any great liking or respect for herself, as from an indignant sense of the wrongs and insults inflicted upon her by her husband. Brougham strongly opposed her departure from England in 1814, as well as her return in 1820 on the accession of George IV.

In 1816 he had again been returned to parliament for Winchelsea, a borough of the earl of Darlington, and he instantly resumed a commanding position in the House of Commons. He succeeded in defeating the continuance of the income-tax; he distinguished himself as an advocate for the education of the people; and on the death of Romilly he took up with ardour the great work of the reform of the law. Nothing exasperated the Tory party more than the select committee which sat, with Brougham in the chair, in 1816 and the three following years, to investigate the state of education of the poor in the metropolis. But he was as far as ever from obtaining the leadership of the party to which he aspired. Indeed, as was pointed out by Lord Lansdowne in 1817, the opposition had no recognized efficient leaders; their warfare was carried on in separate courses, indulging their own tastes and tempers, without combined action. Nor was Brougham much more successful at the bar. The death of George III. suddenly changed this state of things. Queen Caroline at once, in April 1820, appointed Brougham her attorney-general, and Denman her solicitor-general; and they immediately took their rank in court accordingly; this was indeed the sole act of royal authority on the part of the unhappy queen. In July Queen Caroline came from St Omer to England; ministers sent down to both Houses of Parliament the secret evidence which they had long been collecting against her; and a bill was brought into the House of Lords for the deposition of the queen, and the dissolution of the king's marriage. The defence of the queen was conducted by Brougham, assisted by Denman, Lushington and Wilde, with equal courage and ability. His conduct of the defence was most able, and he wound up the proceedings with a speech of extraordinary power and effect. The peroration was said to have been written and rewritten by him seventeen times. At moments of great excitement such declamation may be of value, and in 1820 it was both heard and read with enthusiasm. But to the calmer judgment of later generations this celebrated oration seems turgid and overstrained. Such immense popular sympathy prevailed on the queen's behalf, that the ministry did not proceed with the bill in the Commons, and the result was a virtual triumph for the queen.

This victory over the court and the ministry raised Henry Brougham at once to the pinnacle of fame. He shared the triumph of the queen. His portrait was in every shop window. A piece of plate was presented to him, paid for by a penny subscription of peasants and mechanics. He refused to accept a sum of £4000 which the queen herself placed at his disposal;

he took no more than the usual fees of counsel, while his salary as Her Majesty's attorney-general remained unpaid, until it was discharged by the treasury after her death. But from that moment his fortune was made at the bar. His practice on the northern circuit quintupled. One of his finest speeches was a defence of a Durham newspaper which had attacked the clergy for refusing to allow the bells of churches to be tolled on the queen's death; and by the admission of Lord Campbell, a rival advocate and an unfriendly critic, he rose suddenly to a position unexampled in the profession. The meanness of George IV. and of Lord Eldon refused him the silk gown to which his position at the bar entitled him, and for some years he led the circuit as an outer barrister, to the great loss of the senior members of the circuit, who could only be employed against him. His practice rose to about £7000 a year, but it was again falling off before he became chancellor.

It may here be mentioned that in 1825 the first steps were taken, under the auspices of Brougham, for the establishment of a university in London, absolutely free from all religious or sectarian distinctions. In 1827 he contributed to found the "Society for the Diffusion of Useful Knowledge"—an association which gave an immense impulse to sound popular literature. Its first publication was an essay on the "Pleasures and Advantages of Science" written by himself. In the following year (1828) he delivered his great speech on law reform, which lasted six hours, in a thin and exhausted House,—a marvellous effort, embracing every part of the existing system of judicature.

The death of Canning, the failure of Lord Goderich, and the accession of the duke of Wellington to power, again changed the aspect of affairs. The progress of the movement for parliamentary reform had numbered the days of the Tory government. At the general election of 1830 the county of York spontaneously returned Brougham to the new House of Commons as their representative. The parliament met in November. Brougham's first act was to move for leave to bring in a bill to amend the representation of the people; but before the debate came on the government was defeated on another question; the duke resigned, and Earl Grey was commanded by William IV. to form an administration.

Amongst the difficulties of the new premier and the Whig party were the position and attitude of Brougham. He was not the leader of any party, and had no personal following in the House of Commons. Moreover, he himself had repeatedly declared that nothing would induce him to exchange his position as an independent member of parliament for any office, however great. On the day following the resignation of the Tory government, he reluctantly consented to postpone for one week his motion on parliamentary reform. The attorney-generalship was offered to him and indignantly refused. He himself affirms that he desired to be master of the rolls, which would have left him free to sit in the House of Commons. But this was positively interdicted by the king, and objected to by Lord Althorp, who declared that he could not undertake to lead the House with so insubordinate a follower behind him. But as it was impossible to leave Brougham out of the ministry, it was determined to offer him the chancellorship. Brougham himself hesitated, or affected to hesitate, but finally yielded to the representations of Lord Grey and Lord Althorp. On the 22nd of November the great seal was delivered to him by the king, and he was raised to the peerage as Baron Brougham and Vaux. His chancellorship lasted exactly four years.

Lord Brougham took a most active and prominent part in all the great measures promoted by Grey's government, and the passing of the Reform Bill was due in a great measure to the vigour with which he defended it. But success developed traits which had hitherto been kept in the background. His manner became dictatorial and he exhibited a restless eccentricity, and a passion for interfering with every department of state, which alarmed the king. By his insatiable activity he had contrived to monopolize the authority and popularity of the government, and notwithstanding the immense majority by which it was supported in the reformed parliament, a crisis was not long in arriving. Lord Grey resigned, but very much by Brougham's

exertions the cabinet was reconstructed under Lord Melbourne, and he appeared to think that his own influence in it would be increased. But the irritability of his temper and the egotism of his character made it impossible for his colleagues to work with him; and the extreme mental excitement under which he laboured at this time culminated during a journey to Scotland in a behavior so extravagant, that it gave the final stroke to the confidence of the king. At Lancaster he joined the bar-mess, and spent the night in an orgy. In a country house he lost the great seal, and found it again in a game of blindman's-buff. At Edinburgh, in spite of the coldness which had sprung up between himself and the Grey family, he was present at a banquet given to the late premier, and delivered a harangue on his own services and his public virtue. All this time he continued to correspond with the king in a strain which created the utmost irritation and amazement at Windsor.

Shortly after the meeting of parliament in November the king dismissed his ministers. The chancellor, who had dined at Holland House, called on Lord Melbourne on his way home, and learned the intelligence. Melbourne made him promise that he would keep it a secret until the morrow, but the moment he quitted the ex-premier he sent a paragraph to *The Times* relating the occurrence, and adding that "the queen had done it all." That statement, which was totally unfounded, was the last act of his official life. The Peel ministry, prematurely and rashly summoned to power, was of no long duration, and Brougham naturally took an active part in overthrowing it. Lord Melbourne was called upon in April 1835 to reconstruct the Whig government with his former colleagues. But, formidable as he might be as an opponent, the Whigs had learned by experience that Brougham was even more dangerous to them as an ally, and with one accord they resolved that he should not hold the great seal or any other office. The great seal was put in commission, to divert for a time his resentment, and leave him, if he chose, to entertain hopes of recovering it. These hopes, however, were soon dissipated, and although the late chancellor assumed an independent position in the House of Lords, and even affected to protect the government, his resentment against his "noble friends" soon broke out with uncontrolled vehemence. Throughout the session of 1835 his activity was undiminished. Bills for every imaginable purpose were thrown by him on the table of the House, and his stands recorded in Hansard that he made no less than 221 reported speeches in parliament in that year. But in the course of the vacation a heavier blow was struck: Lord Cottenham was made lord chancellor. Brougham's daring and arrogant spirit sank for a time under the shock, and during the year 1836 he never spoke in parliament. Among the numerous expedients resorted to in order to keep his name before the public, was a false report of his death by a carriage accident, sent up from Westmorland in 1830. He was accused, with great probability, of being himself the author of the report. Such credence did not obtain that all the newspapers of October 22, excepting *The Times*, had obituary notices. However, for more than thirty years after his fall he continued to take an active part in the judicial business of the House of Lords, and in its debates; but it would have been better for his reputation if he had died earlier. His reappearance in parliament on the accession of Queen Victoria was marked by sneers at the court, and violent attacks on the Whigs for their loyal and enthusiastic attachment to their young sovereign; and upon the outbreak of the insurrection in Canada, and the miscarriage of Lord Durham's mission, he overwhelmed his former colleagues, and especially Lord Glenelg, with a torrent of invective and sarcasm, equal in point of oratory to the greatest of his earlier speeches. Indeed, without avowedly relinquishing his political principles, Brougham estranged himself from the whole party by which those principles were defended; and his conduct in general during the years following his loss of office revealed his character in a very unfavourable light. He continued, however, to render judicial services in the privy council and the House of Lords. The privy council, especially when hearing appeals from the colonies, India, and the courts maritime and ecclesiastical was his favourite tribunal; its vast range of

jurisdiction, varied by questions of foreign and international law, suited his discursive genius. He had remodelled the judicial committee in 1833, and it still remains one of the most useful of his creations.

In the year 1860 a second patent was conferred upon him by Queen Victoria, with a reversion of his peerage to his youngest brother, William Brougham (d. 1886). The preamble of this patent stated that this unusual mark of honour was conferred upon him by the crown as an acknowledgment of the great services he had rendered, more especially in promoting the abolition of slavery, and the emancipation of the negro race. The peerage was thus perpetuated in a junior branch of the family, Lord Brougham himself being without an heir. He had married in 1821 Mrs Spalding (d. 1865), daughter of Thomas Eden, and had two daughters, the survivor of whom died in 1839. Brougham's last days were passed at Cannes, in the south of France. An accident having attracted his attention to the spot about the year 1838, when it was little more than a fishing village on a picturesque coast, he bought there a tract of land and built on it. His choice and his example made it the sanatorium of Europe. He died there on the 7th of May 1868, in the ninetieth year of his age.

The verdict of the time has proved that there was nothing of permanence, and little of originality in the prodigious efforts of Brougham's genius. He filled the office of chancellor during times burning with excitement, and he himself embodied and expressed the fervour of the times. He affected at first to treat the business of the court of chancery as a light affair, though in truth he had to work hard to master the principles of equity, of which he had no experience. His manner in court was desultory and dictatorial. Sometimes he would crouch in his chair, muffled in his wig and robes, like a man asleep; at other times he would burst into restless activity, writing letters, working problems, interrupting counsel. But upon the whole Brougham was a just and able judge, though few of his decisions are cited as landmarks of the law.

As a parliamentary figure Brougham's personality excited for many years an immense amount of public interest, now somewhat hard to comprehend. His boundless command of language, his animal spirits and social powers, his audacity and well-stored memory enabled him to dominate the situation. His striking and almost grotesque personal appearance, added to the effect of his voice and manner—a tall disjointed frame, with strong bony limbs and hands, that seemed to interpret the power of his address; strange angular motions of the arms; the incessant jerk of his harsh but expressive features; the modulations of his voice, now thundering in the loudest tones of indignation, now subdued to a whisper—all contributed to give him the magical influence such as is excited by a great actor. But his eccentricity rose at times to the verge of insanity; and with all his powers he lacked the moral elevation which inspires confidence and wins respect.

The activity of Lord Brougham's pen was only second to the volubility of his tongue. He carried on a vast and incessant correspondence of incredible extent. For thirty years he contributed largely to the *Edinburgh Review*, and he continued to write in that journal even after he held the great seal. The best of his writings, entitled "Sketches of the Statesmen of the time of George III.," first appeared in the *Review*. These were followed by the "Lives of Men of Letters and Science," of the same period. Later in life he edited Paley's *Natural Theology*; and he published a work on political philosophy, besides innumerable pamphlets and letters to public men on the events of the day. He published an incorrect translation of Demosthenes' *De Corona*. A novel entitled *Albert Lunel* was attributed to him. A fragment of the *History of England under the House of Lancaster* employed his retirement. In 1838 was published an edition of his speeches in four volumes, elaborately corrected by himself. The last of his works was his posthumous *Autobiography*. Ambitious as he was of literary fame, and jealous of the success of other authors, he has failed to obtain any lasting place in English literature. His style was slovenly, involved and in-

correct; and his composition bore marks of haste and carelessness, and nowhere shows any genuine originality of thought. The collected edition of his works and speeches carefully revised by himself (Edinburgh, 1857 and 1872) is the best. His *Autobiography* is of some value from the original letters with which it is interspersed. But Lord Brougham's memory was so much impaired when he began to write his recollections that no reliance can be placed on his statements, and the work abounds in manifest errors. Nor was his regard for truth at any time unimpeachable, and the accounts which he gave of more than one transaction in which he played a prominent part were found on investigation to be unfounded.

The best modern account of Brougham is J. B. Atlay's, in his *Victorian Chancellors* (1906); Lord Campbell's, in *Lives of the Chancellors*, is spiteful, and by an unfriendly though well-informed critic; the Rev. W. Hunt's judicious and careful biography in the *D.N.B.* is somewhat lacking in colour; Henry Reeve's article in the 9th ed. of the *Ency. Brit.*, which is frequently drawn upon above, now requires a good many corrections in points of fact and perspective, but gives a brilliant picture by an appreciative critic, much behind the scenes." See also references in the *Greville Memoirs* and *Creevey Papers*; S. Walpole, *History of England* (1809); J. A. Roebuck, *History of the Whig Ministry* (1852); Lord Holland, *Memoirs of the Whig Party* (1854); *Brougham and his Early Friends: Letters to James Loch, 1798-1809* (3 vols., London, 1908, privately printed).

BROUGHTON, HUGH (1540-1612), English scholar and divine, was born at Owlbury, Bishop's Castle, Shropshire, in 1540. He was educated by Bernard Gilpin at Houghton-le-Spring and at Cambridge, where he became fellow of St John's and then of Christ's, and took orders. Here he laid the foundation of the Hebrew scholarship for which he was afterwards so distinguished. From Cambridge he went to London, where his eloquence gained him many and powerful friends. In 1588 he published his first work, "a little book of great pains," entitled *A Concord of Scripture*. This work, dealing with biblical chronology and textual criticism, was attacked at both universities, and the author was obliged to defend it in a series of lectures. In 1589 he went to Germany, where he frequently engaged in discussions both with Romanists and with the learned Jews whom he met at Frankfort and elsewhere. In 1591 he returned to England, but his Puritan leanings incurred the hostility of Whitgift. Accordingly in 1592 he once more went abroad, and cultivated the acquaintance of the principal scholars of Europe, including Scaliger and Rabbi Elias. Such was the esteem in which he was held, even by his opponents, that he might have had a cardinal's hat if he had been willing to change his faith. In 1599 he published his "Explication" of the article "He descended into hell," in which he maintained that Hades means simply the abode of departed spirits, not the place of torment. On the accession of James he returned to England; but not being engaged to co-operate in the new translation of the Bible (though he had for some years planned a similar work), he retired to Middleburg in Holland, where he preached to the English congregation. In 1611 he returned to England, where he died on the 4th of August 1612.

Some of his works were collected and published in a large folio volume in 1662, with a sketch of his life by John Lightfoot, but many of his theological MSS. remain still unedited in the British Museum.

BROUGHTON, JOHN CAM HOBHOUSE, BARON (1786-1869), English writer and politician, was the eldest son of Sir Benjamin Hobhouse, Bart., by his wife Charlotte, daughter of Samuel Cam of Chantry House, Bradford, Wiltshire. Born at Bristol on the 27th of June 1786, he was educated at Westminster school and Trinity College, Cambridge, where he graduated in 1808. He took the Hulsean prize in 1808 for his *Essay on the Origin and Intention of Sacrifices*. At Cambridge he founded the "Whig Club," and the "Amicable Society," and became very intimate with Byron, who accompanied him on a tour in Spain, Greece and Turkey in 1809. Hobhouse was present at the battle of Dresden in August 1813, and, following the allied army into France, saw Louis XVIII. enter Paris in May 1814. He was again in Paris after the return of Napoleon from Elba, and showed his dislike of the Bourbons and his sympathy with

Bonaparte by writing in 1816 a pamphlet entitled *The substance of some letters written by an Englishman resident in Paris during the last reign of the emperor Napoleon*. This caused some offence in England and more in France, and the French translation was seized by the government and both translator and printer were imprisoned. A further period of travel with Byron followed, and at this time Hobhouse wrote some notes to the fourth canto of *Childe Harold*. This canto was afterwards dedicated to him, and a revised edition of a part of his notes entitled *Historical illustrations of the fourth canto of "Childe Harold" containing dissertations on the ruins of Rome and an essay on Italian literature*, was published in 1818. In February 1819 Hobhouse was the Radical candidate at a by-election for the representation of the city of Westminster, but he failed to secure election. He had already gained some popularity by writing in favour of reform, and in 1819 he issued *A defence of the People in reply to Lord Erskine's "Two Defences of the Whigs,"* followed by *A trifling mistake in Thomas, Lord Erskine's recent preface*. The House of Commons declared this latter pamphlet a breach of privilege; its author was arrested on the 14th of December 1819, and in spite of an appeal to the court of king's bench he remained in custody until the end of the following February. But this proceeding only increased his popularity, and at the general election of 1820 he was returned for Westminster. Hobhouse shared Byron's enthusiasm for the liberation of Greece; after the poet's death in 1824 he proved his will, and superintended the arrangements for his funeral. In parliament he proved a valuable recruit to the party of reform; and having succeeded his father as 2nd baronet in 1831, was appointed secretary at war in the ministry of Earl Grey in February 1832, and was made a privy councillor. He effected some reforms and economies during his tenure of this office, but, unable to carry out all his wishes, became chief secretary for Ireland in March 1833. He had only held this post for a few weeks when, in consequence of his refusal to vote with the government against the abolition of the house and window tax, he resigned both his office and his seat in parliament. At the subsequent election he was defeated, but joined the cabinet as first commissioner of woods and forests when Lord Melbourne took office in July 1834, and about the same time was returned at a by-election as one of the members for Nottingham. In Melbourne's government of 1835 he was president of the board of control, in which position he strongly supported the Indian policy of Lord Auckland; he returned to the same office in July 1846 as a member of Lord John Russell's cabinet; and in February 1851 he went to the House of Lords as Baron Broughton of Broughton Gyfford. He left office when Russell resigned in February 1852, and took little part in political life, being mainly occupied in literary pursuits and in correspondence. He died in London on the 3rd of June 1869.

He had married in July 1828 Lady Julia Tomlinson Hay, daughter of George, 7th marquess of Tweeddale, by whom he had three daughters, but being without heir male the barony lapsed on his death, the baronetcy passing to his nephew, Charles Parry Hobhouse. Lord Broughton was a partner in Whitbread's brewery, a fellow of the Royal Society, and one of the founders of the Royal Geographical Society. He was responsible for the passing of the Vestry Act of 1831, and is said to have first used the phrase "his majesty's opposition." He was a good classical scholar, and although not eloquent, an able debater. In addition to the works already enumerated he wrote *A journey through Albania and other provinces of Turkey in Europe and Asia to Constantinople during the years 1809 and 1810* (London, 1813), revised edition (London, 1855); and *Italy: Remarks made in Several Visits from the Year 1816 to 1854* (London, 1859). A collection of his diaries, correspondence and memoranda is in the British Museum.

See T. Moore, *Life of Lord Byron* (London, 1837-1840); *Greville Memoirs* (London, 1896); *Dictionary of National Biography*, vol. xxvii. (London, 1891); *The Times*, June 4, 1869; Spencer Walpole, *History of England* (London, 1890). Broughton also wrote *Recollections of a Long Life*, printed privately in 1865, and in 1909 published with additions in 2 vols. edited by his daughter, Lady Dorchester, with a preface by the earl of Rosebery.

BROUGHTY FERRY, a municipal and police burgh, seaport and watering-place of Forfarshire, Scotland, on the Firth of Tay, 4 m. E. of Dundee by the North British railway. Pop. (1901) 10,484. The name is a corruption of Brugh or Burgh Tay, in allusion to the fortress standing on the rock that juts into the Firth. It is believed that a stronghold has occupied this site since Pictish times. The later castle, built in 1498, fell into the hands of the English in 1547 and was held by them for three years. Gradually growing more or less ruinous it was acquired by government in 1855, repaired, strengthened and converted into a Tay defence, mounting several heavy guns. Owing to its healthy and convenient situation, Broughty Ferry has become a favourite residence of Dundee merchants. Fishery and shipping are carried on to a limited extent. Before the erection of the Tay Bridge the town was the scene of much traffic, as the railway ferry from Tayport was then the customary access to Dundee from the south. Monifeth (pop. 2134), 2½ m. north-east of Broughty Ferry, with a station on the North British railway, is noted for its golf links. About 2 m. north rises the conical hill of Laws (400 ft. high), on the top of which are the remains of a vitrified fort, 300 ft. long by 198 ft. in breadth.

BROUSSAIS, FRANÇOIS JOSEPH VICTOR (1772-1851), French physician, was born at St Malo on the 17th of December 1772. From his father, who was also a physician, he received his first instructions in medicine, and he studied for some years at the college of Dinan. At the age of seventeen he entered one of the newly-formed republican regiments, but ill-health compelled him to withdraw after two years. He resumed his medical studies, and then obtained an appointment as surgeon in the navy. In 1799 he proceeded to Paris, where in 1803 he graduated as M.D. In 1805 he again joined the army in a professional capacity, and served in Germany and Holland. Returning to Paris in 1808 he published his *Histoire des phlegmasies ou inflammations chroniques*; then left again for active service in Spain. In 1814 he returned to Paris, and was appointed assistant-professor to the military hospital of the Val-de-Grace, where he first promulgated his peculiar doctrines on the relation between "life" and "stimulus," and on the physiological interdependence and sympathies of the various organs. His lectures were attended by great numbers of students, who received with the utmost enthusiasm the new theories which he propounded. In 1816 he published his *Examen de la doctrine médicale généralement adoptée*, which drew down upon its author the hatred of the whole medical faculty of Paris; but by degrees his doctrines triumphed, and in 1831 he was appointed professor of general pathology in the academy of medicine. In 1828 he published a work *De l'irritation et de la folie*, and towards the end of his life he attracted large audiences by his lectures on phrenology. He died at Vitry-sur-Seine on the 17th of November 1858.

BROUSSONNET, PIERRE MARIE AUGUSTE (1761-1807), French naturalist, was born at Montpellier on the 28th of February 1761, and was educated for the medical profession. Visiting England, he was admitted in 1772 an honorary member of the Royal Society, and in the same year published at London the first part of his work on fishes, *Ichthyologie Decas I*, material for which was communicated to him by Sir Joseph Banks. On his return to Paris he was appointed perpetual secretary to the Society of Agriculture, and in 1789 became a member of the National Assembly. Under the convention he had to leave Paris, and after some dangers he made his way to Madrid. The enmity of the French emigrants, however, drove him from Spain, and afterwards from Lisbon, but at last he found a refuge in Morocco as physician to an embassy sent out by the United States. Later he obtained permission from the Directory to return to France, and in 1805 was appointed professor of botany at Montpellier, where he died on the 17th of January 1807.

BROUWER, or BRAUWER, ADRIAN (1608-1640), Dutch painter, was born at Haarlem, of very humble parents, who bound him apprentice to the painter Frans Hals. Brouwer had an admirable eye for colour, and much spirit in design; and these gifts his master appears to have turned to his own profit, while his pupil was half starved. As the result of this ungenerous

treatment, Brouwer was frequently brought into low company and dissipated scenes, which he delineated with great spirit and vivid colouring in his pictures. The unfortunate artist died in a hospital at Antwerp at the early age of thirty-two, consequently his works are few and rarely met with. The largest collection of his masterpieces is in the Pinakothek at Munich.

BROWN, CHARLES BROCKDEN (1771-1810), American novelist, was born of Quaker parents in Philadelphia, on the 17th of January 1771. Of delicate constitution and retiring habits, he early devoted himself to study; his principal amusement was the invention of ideal architectural designs, devised on the most extensive and elaborate scale. This characteristic talent for construction subsequently assumed the shape of Utopian projects for perfect commonwealths, and at a later period of a series of novels distinguished by the ingenuity and consistent evolution of the plot. The transition between these intellectual phases is marked by a juvenile romance entitled *Cervel*, not published until after the author's death, which professes to depict an imaginary community, and shows how thoroughly the young American was inspired by Godwin and Mary Wollstonecraft, whose principal writings had recently made their appearance. From the latter he derived the idea of his next work, *The Dialogue of Alcvin* (1797), an enthusiastic but inexperienced essay on the question of woman's rights and liberties. From Godwin he learned his terse style, condensed to a fault, but too laconic for eloquence or modulation, and the art of developing a plot from a single psychological problem or mysterious circumstance. The novels which he now rapidly produced offer the strongest affinity to *Caleb Williams*, and if inferior to that remarkable work in subtlety of mental analysis, greatly surpass it in affluence of invention and intensity of poetical feeling. All are wild and weird in conception, with incidents bordering on the preternatural, yet the limit of possibility is never transgressed. In *Wieland; or the Transformation* (1798), the first and most striking, a seemingly inexplicable mystery is resolved into a case of ventriloquism. *Arthur Mervyn; or Memoirs of the Year 1793* (1798-1800), is remarkable for the description of the epidemic of yellow fever in Philadelphia. *Edgar Huntly* (Philadelphia, 1801), a romance rich in local colouring, is remarkable for the effective use made of somnambulism, and anticipates Cooper's introduction of the American Indian into fiction. *Ormond* (1799) is less powerful, but contains one character, Constantia Dudley, which excited the enthusiastic admiration of Shelley. Two subsequent novels, *Clara Howard* (1801) and *Jane Talbot* (1804), dealing with ordinary life, proved failures, and Brown betook himself to compiling a general system of geography, editing a periodical, and an annual register, and writing political pamphlets. He died of consumption on the 22nd of February 1810. He is depicted by his biographer as the purest and most amiable of men, and in spite of a certain formality, due perhaps to his Quaker education, the statement is borne out by his correspondence.

The life of Charles Brockden Brown was written by his friend William Dunlap (Philadelphia, 1815). See also William H. Prescott, *Biographical and Critical Miscellanies* (New York, 1845). His works in 6 vols. were published at Philadelphia in 1857 with a "life," and in a limited and more elaborate edition (1887).

BROWN, FORD MADOX (1821-1893), English painter, was born at Calais on the 16th of April 1821. His father was Ford Brown, a retired purser in the navy; his mother, Caroline Madox, of an old Kentish family. His paternal grandfather was Dr John Brown, who established the Brunonian Theory of Medicine. Ford Madox Brown was the only child of his parents, save for a daughter who died young. In childhood he was shifted about a good deal between France and England; and having shown from the age of six or seven a turn for drawing he was taken, when fourteen years old, and with meagre acquisitions in the way of general tuition, to Bruges, and placed under the instruction of Gregorius, a pupil of David. His principal instructor, however, from about 1837, was Baron Wappers, of Antwerp, then regarded as a great light of the Belgian school. From him the youth learned the technique not only of oil painting but of various other branches of art. At a very early age Brown

attained a remarkable degree of force in drawing and painting, as attested by an extant oil-portrait of his father, done at an age not exceeding fifteen. His first composition, towards 1836, represented a blind beggar and his child; his first exhibited work, 1837, was "Job on the Ash-heap"; the first exhibited work in London (at the Royal Academy, 1840), "The Giaour's Confession," from Byron's poem. Both his parents died before 1840, leaving to the young painter a moderate competence, which soon was materially reduced. In 1840 Brown completed a large picture, "The Execution of Mary, queen of Scots," strong in dramatic effect and in handling, with rather sombre colour; from this time forth he must be regarded as a proficient artist, independent in his point of view and strenuous in execution. He contributed to the cartoon competitions, 1844 and 1845, for the Houses of Parliament—"Adam and Eve after the Fall," "The Body of Harold brought to William the Conqueror," and "The Spirit of Justice." These highly remarkable cartoons passed not wholly unobserved, but not one of them obtained a prize. The years 1840 to 1845 were passed in Paris, London and Rome: towards the middle of 1846 Brown settled permanently in London. In 1841 he had married his cousin Elizabeth Bromley, who died of consumption in 1846, leaving a daughter, Lucy, who in 1874 became the wife of William M. Rossetti. Not long after being left a widower, Brown took a second wife, Emma Hill, who figures in many of his pictures. She had two children who grew up: Catherine, who married Dr Franz Hueffer, the musical scholar and critic, and Oliver, who died in 1874 in his twentieth year. All three children showed considerable ability in painting, and Oliver in romance as well. The second Mrs Brown died in 1890.

The most marked distinction of Brown as an artist may be defined as vigorous invention of historic or dramatic scenes, carried out with a great regard to individuality in the personages, expressions and accessories of incident and detail, not excluding the familiar, the peculiar and the semi-grotesque, when these seem to subserve the general intent. Owing, however, to his association with artists of the so-called "pre-Raphaelite" movement (which began late in 1848), and especially with Dante Gabriel Rossetti, who received some training in his studio in the spring of that year, he has been regarded sometimes as the precursor or initiator of this movement, and sometimes as a direct co-operator in it. His claim to be regarded as a precursor or initiator is not strong; though it is true that even before 1841 he had pondered the theory (not then much in vogue) that a picture ought to present the veritable light and shade proper to some one moment in the day, and his "Manfred on the Jungfrau" (1841) exemplifies this principle to some extent; it reappears in his very large picture of "Chaucer at the Court of Edward III." (now in the public gallery of Sydney, Australia), which, although projected in 1845, was not brought to completion until 1851. As to becoming a direct co-operator in the pre-Raphaelite movement, he did not join the "Brotherhood," though it would have been open to him to do so; but for some years his works exhibited a marked influence derived from the movement, not on the whole to their clear advantage. The principal pictures of this class are: "The Pretty Baa-lambs"; "Work" (a street scene at Hampstead); and "The Last of England" (an emigration subject, one of his most excellent achievements): dating between 1851 and 1863. "Christ Washing Peter's Feet" (now in the National Gallery of British Art) comes within the same range of dates, and is a masterly work; here the pre-Raphaelite influence is less manifest. Altogether it may be averred that the conception and introduction of the pre-Raphaelite scheme, such as it appeared to the public eye in 1849 and 1850, belong to Millais, Holman Hunt and Rossetti, rather than to Brown.

Other leading pictures by Brown are the following:—"Cordelia at the Bedside of Lear"; "Shakespeare"; "Jacob and Joseph's Coat"; "Elijah and the Widow's Son"; "Cordelia's Portion"; "The Entombment"; "Romeo and Juliet" (the parting on the balcony); "Don Juan and Haidee"; "Cromwell on his Farm"; "Cromwell, Protector of the

Vaudouis":—covering the period from 1849 to 1877. "Sardanapalus and Myrrha." begun within the same period, was finished later. He produced, moreover, a great number of excellent cartoons for stained glass, being up to 1874 a member of the firm of decorative art, Morris, Marshall, Faulkner and Co. He also executed, in colours or in crayons, various portraits, including his own. From 1878 he was almost engrossed by work which he undertook for the town hall of Manchester, and which entailed his living for some few years in that city—twelve large wall paintings, some of them done in a modified form of the Gambier-Parry process, and others in oils on canvas applied to the wall surface. They present a compendium of the history of Manchester and its district, from the building of the Roman camp at Mancunium to the experimental work of Dalton in elaborating the atomic theory. This is an extremely fine series, though with some diversity of individual merit in the paintings, and is certainly the chief representative, in the United Kingdom, of any such form of artistic effort—if we leave out of count the works (by various painters) in the Houses of Parliament.

Madox Brown was never a popular or highly remunerated artist. Up to near middle age he went through trying straits in money matters; afterwards his circumstances improved, but he was not really well off at any time. In youth he followed the usual course as an exhibiting painter, but after some mortifications and heart-burnings he did little in this way after 1852. He held, however, in 1865, an exhibition of his own then numerous paintings and designs. He also delivered a few lectures on fine art from time to time. From 1868 he suffered from gout; and this led to an attack of apoplexy, from which he died in London on the 6th of October 1893. He was a man of upright, independent and honourable character, of warm affections, a steady and self-sacrificing friend; but he took offence rather readily, and viewed various persons and institutions with a degree of suspicion which may be pronounced excessive. He felt interest in many questions outside the range of his art, and, being a good and varied talker, had often something apposite and suggestive to say about them. On more than one occasion he exerted himself very zealously for the benefit of the working classes. In politics he was a consistent Democrat, and on religious questions an Agnostic.

The life of this artist has been well written by his grandson, Ford M. Hueffer, in a handsomely illustrated volume entitled *Ford Madox Brown* (London, 1896). This volume contains some extracts from Brown's diary, extending in the whole from 1847 to 1865; and other lengthier extracts appear in two books edited by William M. Rossetti—*Ruskin, Rossetti, Pre-Raphaelitism* (1896), and *Pre-Raphaelite Diaries and Letters* (1899). See also the *Preferences in Art, &c.*, by Harry Quilter (1892), and a pamphlet, *Ford Madox Brown* (1901), by Helen Rossetti (Angeli), applicable to a collection of his works exhibited in the Whitechapel Art Gallery. (W. M. R.)

BROWN, FRANCIS (1849—), American Semitic scholar, was born in Hanover, New Hampshire, on the 26th of December 1849, the son of Samuel Gilman Brown (1813–1885), president of Hamilton College from 1867 to 1881, and the grandson of Francis Brown (1784–1820), whose removal from the presidency of Dartmouth College and later restoration were incidental to the famous "Dartmouth College case." The younger Francis graduated from Dartmouth in 1870 and from the Union Theological Seminary in 1877, and then studied in Berlin. In 1879 he became instructor in biblical philology at the Union Theological Seminary, in 1881 an associate professor of the same subject, and in 1890 professor of Hebrew and cognate languages. Dr Brown's published works have won him honorary degrees from the universities of Glasgow and Oxford, as well as from Dartmouth and Yale; they are, with the exception of *The Christian Point of View* (1902; with Profs. A. C. McGiffert and G. W. Knox), almost purely linguistic and lexical, and include *Assyriology: its Use and Abuse in Old Testament Study* (1885), and the important revision of Gesenius, undertaken with S. R. Driver and C. A. Briggs, *A Hebrew and English Lexicon of the Old Testament* (1891–1905).

¹ In 1908 he succeeded Charles Cuthbert Hall (1852–1908) as president of the seminary.

BROWN, SIR GEORGE (1790–1865), British soldier, was born and educated in Elgin, Scotland. He obtained a commission in the 43rd (now 1st Bn. Oxfordshire) Light Infantry in 1806, was promoted lieutenant a few months later, and saw active service for the first time in the Mediterranean and at Copenhagen, 1806 and 1807. The 43rd was one of the earliest arrivals in Spain when the Peninsular War broke out, and Brown was with his regiment at Vimero, and in the Corunna retreat. Later in 1809 the famous Light Division was formed, and with Craufurd he was present at all the actions of 1810–1811, being severely wounded at Talavera; he was then promoted captain and attended the Staff College at Great Marlow until (late in 1811) he returned to the Peninsula as a captain in the 85th. With this regiment he served under Major-General Lord Aylmer at the Nivelle and Nive, his conduct winning for him the rank of major. The 85th was next employed under General Robert Ross in America, and Brown, who received a severe wound at the action of Bladensburg, was promoted to a lieutenant-colonelcy. At the age of twenty-five, with a brilliant war record, he received an appointment at the Horse Guards, and remained in London for over twenty-five years in various staff positions. He was made a colonel and K.H. in 1831, and by 1852 had arrived at the rank of lieutenant-general and the dignity of K.C.B. At this time he was adjutant-general, but on the appointment of Lord Hardinge to the post of commander-in-chief, Brown left the Horse Guards. In 1854, on the despatch of a British force to the East, Sir George Brown was appointed to command the Light Division. This he led in action, and administered in camp, on Peninsular principles, and, whilst preserving the strictest discipline to a degree which came in for criticism, he made himself beloved by his men. At Alma he had a horse shot under him. At Inkerman he was wounded whilst leading the French Zouaves into action. In the following year, when an expedition against Kertch and the Russian communications was decided upon, Brown went in command of the British contingent. He was invalided home on the day of Lord Raglan's death. From March 1860 to March 1865 he was commander-in-chief in Ireland. At the time of his death in 1865 he was general and G.C.B., colonel of the 32nd Regiment and colonel-in-chief of the Rifle Brigade.

BROWN, GEORGE (1818–1880), Canadian journalist and statesman, was born in Edinburgh on the 29th of November 1818, and was educated in his native city. With his father Peter Brown (d. 1865), he emigrated to New York in 1838, and in 1843 they removed to Toronto, and began the publication of *The Banner*, a politico-religious paper in support of the newly formed Free Church of Scotland. In 1844 he began, independently of his father, the issue of the *Toronto Globe*. This paper at first weekly, became in 1853 a daily, and through the ability and energy of Brown, came to possess an almost tyrannical influence over the political opinion of Ontario. In 1851 he entered the Canadian parliament as member for Kent county. Though giving at first a modified support to the Reform government, he soon broke with it and became leader of the Radical or "Clear Grit" party. His attacks upon the Roman Catholic church and on the supposed domination in parliament of the French Canadian section made him very unpopular in Lower Canada, but in Upper Canada his power was great. Largely owing to his attacks, the Clergy Reserves were secularized in 1854. He championed the complete laicization of the schools in Ontario but unsuccessfully, the Roman Catholic church maintaining its right to separate schools. He also fought for the representation by population of the two provinces in parliament. The Act of Union (1841) having granted an equal number of representatives to each. This principle of "Rep. by Pop." was conceded by the British North America Act (1867). In 1858 Brown became premier of "The Short Administration," which was defeated and compelled to resign after an existence of two days.

He was one of the earliest advocates of a federation of the British colonies in North America, and in 1864, to accomplish this end, entered into a coalition with his bitter personal political opponent, Mr (afterwards Sir) John A. Macdonald.

Largely owing to Brown's efforts, Federation was carried through the House, but on the 21st of December 1865 he resigned from the Coalition government, though continuing to support its Federation policy, and in 1867 he was defeated in South Ontario and never again sat in the House. In great measure owing to his energy, and in spite of much concealed opposition from the French-Canadians, the North-West Territories were purchased by the new Dominion. In December 1873 he was called to the Canadian senate, and in 1874 was appointed by the imperial government joint plenipotentiary with Sir Edward Thornton to negotiate a reciprocity treaty between Canada and the United States. The negotiations were successful, but the draft treaty failed to pass the United States Senate. Soon afterwards Brown refused the lieutenant-governorship of Ontario, and on two subsequent occasions the offer of knighthood, devoting himself to the *Globe* and to a model farm at Bow Park near Brantford. On the 25th of March 1880 he was shot by a discharged employé, and died on the 9th of May.

His candour, enthusiasm and open tolerance of the opinions of others made him many warm friends and many fierce enemies. He was at his best in his generous protests against all privileges, social, political and religious, and in the self-sacrificing patriotism which enabled him to fling aside his personal prejudices, and so to make Federation possible.

See J. C. Dent, *Canadian Portrait Gallery* (Toronto, 1800). The official *Life*, by the Hon. Alexander Mackenzie, is decidedly partisan. A life by John Lewis is included in the *Makers of Canada* series (Toronto). (W. L. G.)

BROWN, HENRY KIRKE (1814-1886), American sculptor, was born in Leyden, Massachusetts, on the 24th of February 1814. He began to paint portraits while quite a boy, studied painting in Boston under Chester Harding, learned a little about modelling, and in 1836-1839 spent his summers working as a railroad engineer to earn enough to enable him to study further. He spent four years (1842-1846) in Italy; but returning to New York he remained distinctively American, and was never dominated, as were so many of the early American sculptors, by Italian influence. He died on the 10th of July 1886 at Newburgh, New York. His equestrian statues are excellent, notably that of General Winfield Scott (1874) in Washington, D.C., and one of George Washington (1856) in Union Square, New York City, which was the second equestrian statue made in the United States, following by three years that of Andrew Jackson in Washington by Clark Mills (1815-1883). Brown was one of the first in America to cast his own bronzes. Among his other works are: Abraham Lincoln (Union Square, New York City); Nathanael Greene, George Clinton, Philip Kearny, and Richard Stockton (all in the National Statuary Hall, Capitol, Washington, D.C.); De Witt Clinton and "The Angel of the Resurrection," both in Greenwood cemetery, New York City; and an "Aboriginal Hunter."

His nephew and pupil, Henry Kirke Bush-Brown (b. 1857), also became prominent among American sculptors, his "Buffalo Hunt," equestrian statues of Generals Meade and Reynolds at Gettysburg, and "Justinian" in the New York appellate court-house, being his chief works.

BROWN, JACOB (1775-1828), American soldier, was born of Quaker ancestry, in Bucks county, Pennsylvania, on the 9th of May 1775. From 1796 to 1798 he was engaged in surveying public lands in Ohio; in 1798 he settled in New York City, and during the period (1798-1800) when war with France seemed imminent he acted as military secretary to Alexander Hamilton, then inspector-general of the United States army. Subsequently he purchased a large tract of land in Jefferson county, New York, where he founded the town of Brownville. There he served as county judge, and attained the rank (1810) of brigadier-general in the state militia. On the outbreak of the second war with Great Britain (1812) he was placed in command of the New York state frontier from Oswego to Lake St Francis (near Cornwall, Ontario) and repelled the British attacks on Ogdensburg (October 4, 1812) and Sackett's Harbor (May 29, 1813). In July 1813 he was commissioned brigadier-general in the regular army, and

in January 1814 he was promoted major-general and succeeded General James Wilkinson in command of the forces at Niagara. Early in the summer of 1814 he undertook offensive operations, and his forces occupied Fort Erie, and, on the 5th of July, at Chippawa, Ontario, defeated the British under General Phineas Riall (c. 1769-1851). On the 25th of July, with General Winfield Scott, he fought a hotly contested, but indecisive, battle with the British under General Gordon Drummond (1771-1854) at Lundy's Lane, where he was twice wounded. After the war he remained in the army, of which he was the commanding general from March 1821 until his death at Washington, D.C., on the 24th of February 1828.

BROWN, JOHN (1715-1766), British divine and author, was born at Rothbury, Northumberland, on the 5th of November 1715. His father, a descendant of the Browns of Coalston, near Haddington, became vicar of Wigton in that year. Young Brown was educated at St John's College, Cambridge; and after graduating at the head of the list of wranglers in 1735, he took holy orders, and was appointed minor canon and lecturer at Carlisle. In 1745 he distinguished himself in the defence of Carlisle as a volunteer, and in 1747 was appointed chaplain to Dr Osbaldiston, on his admission to the bishopric of Carlisle. His poem, entitled "Honour" (1743), was followed by the "Essay on Satire." This gained for him the friendship of William Warburton, who introduced him to Ralph Allen, of Prior Park, near Bath. In 1751 Brown dedicated to Allen his *Essay on the Characteristics of Lord Shaftesbury*, containing an able defence of the utilitarian philosophy, praised later by John Stuart Mill (*Westminster Review*, vol. xxix. p. 477). In 1756 he was promoted by the earl of Hardwicke to the living of Great Horkeley in Essex, and in the following year he took the degree of D.D. at Cambridge. He was the author of two plays, *Barbarossa* (1754) and *Althelstane* (1756); Garrick played in both, and the first was a success. The most popular of his works was the *Estimate of the Manners and Principles of the Times* (2 vols., 1757-1758), a bitter satire which pleased a public depressed by the ill-success in the conduct of the war, and ready to welcome an attack on luxury and kindred evils. Other works are the *Additional Dialogue of the Dead between Pericles and Cosmo* . . . (1760), in vindication of Chatham's policy; and the *Dissertation on the Rise, Union and Power, &c., of Poetry and Music* (1763). He was consulted in connexion with a scheme of education which Catherine II. of Russia desired to introduce into her dominions. A memorandum on the subject by Dr Brown led to an offer on her part to entertain him at St Petersburg as her adviser on the subject. He had bought a postchaise and various other things for the journey, when he was persuaded to relinquish the design on account of his gout. He had been subject to fits of melancholy, and, influenced perhaps by disappointment, he committed suicide on the 23rd of September 1766.

There is a detailed account of John Brown by Andrew Kippis in *Biographia Britannica* (1780), containing the text of the negotiations for his journey to Russia, and of a long letter in which he outlines the principles of the scheme he would have proposed. See also T. Davies, *Memoirs of . . . David Garrick* (1780), chap. xix.

BROWN, JOHN (1722-1787), Scottish divine, was born at Carpow, in Perthshire. He was almost entirely self-educated, having acquired a knowledge of Latin, Greek and Hebrew while employed as a shepherd. His early career was varied, and he was in succession a packman, a soldier in the Edinburgh garrison in 1745, and a school-master. He was, from 1750 till his death, minister of the Burgher branch of the Secession church (see UNITED PRESBYTERIAN CHURCH) in Haddington. From 1786 he was professor of divinity for his denomination, and was mainly responsible for the training of its ministry. He gained a just reputation for learning and piety. The best of his many works are his *Self-Interpreting Bible* and *Dictionary of the Bible*, works that were long very popular. The former was translated into Welsh. He also wrote an *Explication of the Westminster Confession*, and a number of biographical and historical sketches.

BROWN, JOHN (1735-1788), Scottish physician, was born in 1735 at Lintlaws or at Preston, Berwickshire. After attending the parish school at Duns, he went to Edinburgh and entered

the divinity classes at the university, supporting himself by private tuition. In 1759 he seems to have discontinued his theological studies, and to have begun the study of medicine. He soon attracted the notice of William Cullen, who engaged him as private tutor to his family, and treated him in some respects as an assistant professor. In time, however, he quarrelled with Cullen, as with the professors of the university in general, and from about 1778 his public lectures contained vigorous attacks on all preceding systems of medicine and Cullen's in particular. In 1780 he published his *Elementa Medicinæ*, expounding his own, or as it was then called the Brunonian, theory of medicine, which for a time had a great vogue. In 1786 he set out for London in the vain hope of bettering his fortunes, and died there of apoplexy on the 17th of October 1788.

An edition of his works, with notice of his life by his son, William Cullen Brown, appeared in 1804.

BROWN, JOHN (1784-1858), Scottish divine, grandson of the last-named, was born at Whitburn, Linlithgowshire, on the 12th of July 1784. He studied at Glasgow university, and afterwards at the divinity hall of the "Burgher" branch of the "Secession" church at Selkirk, under the celebrated George Lawson. In 1806 he was ordained minister of the Burgher congregation at Biggar, Lanarkshire, where he laboured for sixteen years. While there he had an interesting controversy with Robert Owen the socialist. Transferred in 1822 to the charge of Rose Street church, Edinburgh, he at once took a high rank as a preacher. In 1829 he succeeded James Hall at Broughton Place church, Edinburgh. In 1835 he was appointed one of the professors in the theological hall of the Secession church, and, great as was his ability as a preacher and pastor, it was probably in this sphere that he rendered his most valuable service. He had been the first in Scotland to use in the pulpit the exegetical method of exposition of Scripture, and as a professor he illustrated the method and extended its use. To him chiefly is due the abandonment of the principle of interpretation according to the "analogy of faith," which practically subordinated the Bible to the creed. Brown's exegesis was marked by rare critical sagacity, exact and extensive scholarship, unwavering honesty, and a clear, logical style; and his expository works have thus a permanent value. He had a considerable share in the Apocrypha controversy, and he was throughout life a vigorous and consistent upholder of anti-state-church or "voluntary" views. His two sermons on *The Law of Christ respecting civil obedience, especially in the payment of tribute*, called forth by a local grievance from which he had personally suffered, were afterwards published with extensive additions and notes, and are still regarded as an admirable statement and defence of the voluntary principle. The part he took in the discussion on the Atonement, which agitated all the Scottish churches, led to a formal charge of heresy against him by those who held the doctrine of a limited atonement. In 1845, after a protracted trial, he was acquitted by the synod. From that time he enjoyed the thorough confidence of his denomination (after 1847 merged in "the United Presbyterian church"), of which in his later years he was generally regarded as the leading representative. He died on the 13th of October 1858. His chief works were: *Expository Discourses on First Peter* (1848); *Exposition of the Discourses and Sayings of our Lord* (1850); *Exposition of our Lord's Intercessory Prayer* (1850); *The Resurrection of Life* (1851); *Expository Discourses on Galatians* (1853); and *Analytical Exposition of the Epistle to the Romans* (1857).

See *Memoir of John Brown, D.D.*, by John Cairns (1860).

BROWN, JOHN (1800-1859), American abolitionist, leader of the famous attack upon Harper's Ferry, in 1859, was born on the 9th of May 1800, at Torrington, Connecticut. He is said to have been descended from Peter Brown, who went to America in the *Mayflower*, and he was the grandson of Captain John Brown, who served in the War of Independence. He was taken by his father, Owen Brown, to Hudson, Ohio, in 1805. At the age of eighteen he began to prepare himself for the Congregational ministry, but soon changed his mind and turned his attention

to land surveying. He engaged successively in the tanning business, in sheep-raising, and in the wool trade, but met with little success and in 1849, at Akron, Ohio, became bankrupt. In 1849, after having lived in Ohio, Pennsylvania, and Massachusetts, he removed to North Elba, N.Y., where he engaged in farming on part of the land which was being given in small tracts by its owner Gerrit Smith, to negro settlers. Long before this he had conceived a strong hatred for the institution of slavery, and had determined to do what he could to bring about its destruction. In 1854 five of his sons removed to Kansas, where the violent conflict was beginning between the "free-state" and the pro-slavery settlers, and in the following year Brown, leaving the rest of his family at North Elba, joined them, settling near Osawatimie and immediately becoming a conspicuous figure in the border warfare. His name became particularly well known in connexion with the so-called "Pottawatomie massacre," the killing in cold blood, on the 25th of May 1856, by men under his orders, of five pro-slavery settlers in retaliation for the murder a short time previously of five "free-state" settlers. He also on the 2nd of June, at the head of about thirty men, captured Captain H. C. Pate and twenty-two pro-slavery men at Black Jack, and on the 30th of August 1856, with a small body of supporters, vigorously resisted an attack of a superior pro-slavery force upon Osawatimie. Brown then visited the Eastern states for the purpose of raising money to be used in the Kansas struggle and of arousing the people against slavery. After spending a short time in Kansas, in 1858-1859 he proceeded to carry out a long-cherished scheme for facilitating the escape of fugitive slaves by establishing in the mountains of Virginia a stronghold in which such fugitives could take refuge and defend themselves against their pursuers. At Chatham, Canada, with eleven white and thirty-five negro associates, he adopted a "Provisional Constitution and Ordinance for the People of the United States." Brown was elected commander-in-chief, and from among this group a secretary of state, a secretary of war, and a secretary of the treasury, and members of Congress were chosen. Later, with only twenty-two men supplied with arms furnished by the Massachusetts-Kansas committee, and with funds contributed (in ignorance of Brown's plans) by his intimate associates, Theodore Parker, George L. Stearns, T. W. Higginson, and F. B. Sanborn, all of Boston, and Gerrit Smith of Peterboro, New York, he removed to a farm near Harper's Ferry the site of a Federal arsenal, which he intended to capture as a preliminary to the carrying out of the main part of his plan. On the night of the 16th of October 1859, with only eighteen men, five of whom were negroes, he made the attack, easily capturing the arsenal and taking about sixty of the leading citizens prisoners to be used as hostages. On the following morning Brown and his followers were vigorously attacked, and on the 18th—a small force of United States marines under Colonel Robert E. Lee having arrived—were overpowered, Brown being seriously wounded after he had surrendered. Of the twenty-two men who had participated in the raid, ten were killed, seven were taken prisoners, and five escaped. On the other side five were killed and nine wounded. Brown was committed to the Charlestown, Virginia (now West Virginia), goal on the 19th of October; on the 27th his trial began; on the 31st he was convicted of "treason, and conspiring and advising with slaves and other rebels, and murder in the first degree"; and on the 2nd of December he was hanged at Charlestown. His fellow-prisoners were likewise hanged soon afterwards. Brown was buried at North Elba, New York. The attack upon Harper's Ferry created widespread excitement, particularly in the Southern states; and among the abolitionists in the North Brown was looked upon as a martyr to their cause. Shortly after his death a famous popular song became widely current in the North, beginning:—

John Brown's body lies a-mouldering in the grave,
But his soul goes marching on.

Intensely religious in his nature, Brown possessed something of the gloomy fanaticism of his Puritan ancestors. The secret of his whole career lies in his emphatic conviction, to use the

words of Wendell Phillips, that he had "letters of marque from God"; that he had a divine commission to destroy slavery by violent means. He scouted the "milk and water principles" of the milder abolitionists, advocated vigorous resistance to the slave power, and expressed his ideas by actions rather than by words. It now seems that this policy aided very little in making Kansas a free state, and that the attack on Harper's Ferry, while creating much feeling at the moment, had very little effect on the subsequent course of events. It is safe to assume that secession and civil war would have followed the election of Lincoln if there had been no such raid into Virginia.

Brown was twice married and was the father of twenty children, eight of whom died in early childhood. His sons aided him in all his undertakings, two of them being killed at Harper's Ferry; and Owen Brown, who died in 1889, was long the only survivor of the attack.

See the life (1910) by O. G. Villard, and F. B. Sanborn's *Life and Letters of John Brown* (Boston, 1885); R. J. Hinton's *John Brown and His Men* (New York, 1894); James Redpath's *Public Life of Captain John Brown* (Boston, 1862); Von Holst's essay, *John Brown* (Boston, 1889); and J. F. Rhoads, *History of the United States from the Compromise of 1850* (New York, 1890-1906).

BROWN, JOHN (1810-1882), Scottish physician and author, son of John Brown (1784-1858), was born at Biggar, Scotland, on the 22nd of September 1810. He graduated as M.D. at the university of Edinburgh in 1833, and practised as a physician in that city. His reputation, however, is based on the two volumes of essays, *Horae Subsecivae* (i.e. "leisure hours") (1858, 1861), *John Leech and other Papers* (1882), *Rab and His Friends* (1859), and *Marjorie Fleming: a Sketch* (1863). The first volume of *Horae Subsecivae* deals chiefly with the equipment and duties of a physician, the second with subjects outside his profession. He was emphatic in his belief that an author should publish nothing "unless he has something to say, and has done his best to say it aright." Acting on this principle, he published little himself, and only after subjecting it to the severest criticism. His work is invariably characterized by humour and tenderness. He suffered during the latter years of his life from pronounced attacks of melancholy, and died on the 11th of May 1882.

See also E. T. M'Laren, *Dr John Brown and his Sister Isabella* (4th ed., 1890); and *Letters of Dr John Brown*, edited by his son and D. W. Forrest, with biography by E. T. M'Laren (1907).

BROWN, SIR JOHN (1816-1896), English armour plate manufacturer, was born at Sheffield on the 6th of December 1816, the son of a slater. He was apprenticed when fourteen years old to a Sheffield firm who manufactured files and table cutlery. Impressed with Brown's ability, the senior partner offered him the control of the business (Earl Horton and Co.) and advanced some of the necessary capital. Brown invented in 1848 the conical steel spring buffer for railway wagons, and in 1860, after seeing the French ship "La Gloire" armoured with hammered plate, he determined to attempt the production of armour for the British navy by a rolling process. The experiment was successful, and led to admiralty orders for armour plate sufficient to protect about three-quarters of the navy. In 1856 Brown had started the Atlas Works in Sheffield, which soon produced, beside armour plates and railway buffers, ordnance forgings, steel rails, railway carriage axles and tires. The works covered thirty acres and employed eventually more than four thousand workmen. Besides supplying iron to the Sheffield steel trade, Brown himself successfully developed the Bessemer process. In 1864, after his business had been converted into a limited company, he retired. He died at Bromley, Kent, on the 27th of December 1896. Among the honours conferred upon him was a knighthood in 1867, the office of mayor of Sheffield in 1862 and 1863, and that of Master Cutler in 1865 and 1866.

BROWN, JOHN GEORGE (1831-), American painter, was born in Durham, England, on the 11th of November 1831. He studied at Newcastle-on-Tyne, in the Edinburgh Academy, and after removing to New York City in 1853, at the schools of the National Academy of Design, of which he afterwards became a member. In 1866 he became one of the charter members of the Water-Colour Society, of which he was president from 1887

to 1904. He generally confined himself to representations of street child life, bootblacks, newsboys, &c.; his "Passing Show" (Paris, Salon, 1877) and "Street Boys at Play" (Paris Exhibition, 1900) are good examples of his popular talent.

BROWN, ROBERT (1773-1858), British botanist, was born on the 21st of December 1773 at Montrose, and was educated at the grammar school of his native town, where he had as contemporaries Joseph Hume and James Mill. In 1787 he entered Marischal College, Aberdeen, but two years afterwards removed to Edinburgh University, where his taste for botany attracted the attention of John Walker (1731-1803), then professor of natural history in the university. In 1795 he obtained a commission in the Forfarshire regiment of Fencible Infantry as "ensign and assistant surgeon," and served in the north of Ireland. In 1798 he made the acquaintance of Sir Joseph Banks, by whom in 1801 he was offered the post of naturalist to the expedition fitted out under Captain Matthew Flinders for the survey of the then almost unknown coasts of Australia. Ferdinand Bauer, afterwards familiarly associated with Brown in his botanical discoveries, was draughtsman; William Westall was landscape painter; and among the midshipmen was one afterwards destined to rise into fame as Sir John Franklin. In 1805 the expedition returned to England, having obtained, among other acquisitions, nearly 4000 species of plants, many of which were new. Brown was almost immediately appointed librarian of the Linnean Society. In this position, though one of no great emolument, he had abundant opportunities of pursuing his studies; but it was not until 1820 that he published the first volume of his great work, in Latin, the *Prodromus Florae Novae Hollandiae et Insulae Van Diemen*, which did much to further the general adoption of A. L. de Jussieu's natural system of plant classification. Its merits were immediately recognized, and it gave its author an international reputation among botanists. It is rare in its original edition, the author having suppressed it, hurt at the *Edinburgh Review* having fallen foul of its Latinity. With the exception of a supplement published in 1830, no more of the work appeared. In 1810 Brown became librarian to Sir Joseph Banks, who on his death in 1820 bequeathed to him the use and enjoyment of his library and collections for life. In 1827 an arrangement was made by which these were transferred to the British Museum, with Brown's consent and in accordance with Sir Joseph's will. Brown then became keeper of this new botanical department, an office which he held until his death. Soon after Banks's decease he resigned the librarianship of the Linnean Society, and from 1849 to 1853 he served as its president. He received many honours. Elected a fellow of the Royal Society in 1811, he received its Copley medal in 1839, for his "discoveries on the subject of vegetable impregnation," and in 1833 he was elected one of the five foreign associates of the Institute of France. Among his other distinctions was membership of the order "pour le Mérite" of Prussia. In the *Academia Caesarea Naturae Curiosorum* he sat under the cognomen of Ray. He died on the 10th of June 1858, in the house in Soho Square, London, bequeathed to him by Sir Joseph Banks. His works, which embrace not only systematic botany, but also plant anatomy and physiology, are distinguished by their thoroughness and conscientious accuracy, and display powers at once of minute detail and of broad generalization. The continual movements observed by the microscope among minute particles suspended in a liquid were noticed by him in 1827, and hence are known as "Brownian movements."

In 1825-1834 his works up to that date were collected and published in four divisions by Nees von Euenbeck, in German, under the title of *Vermischte botanische Schriften* (Leipzig and Nuremberg). In 1866 the Ray Society reprinted, under the editorship of his friend and successor in the keepership of the Botanical Department of the British Museum, J. J. Bennet, his complete writings, the *Prodromus* alone excepted. In these *Miscellaneous Works* (2 vols., with atlas of plates) the history of his discoveries can be best followed.

BROWN, SAMUEL MORISON (1817-1856), Scottish chemist, poet and essayist, born at Haddington on the 23rd of February 1817, was the fourth son of Samuel Brown, the founder of

itinerating libraries, and grandson of John Brown, author of the *Self-Interpreting Bible*. In 1832 he entered the university of Edinburgh, where, after studying in Berlin and St Petersburg, he graduated as M.D. in 1839. About 1840 he was engaged in experiments by which he sought to prove that "carbon in certain states of combination is susceptible of conversion into silicon," and his failure to establish this proposition had much to do with his want of success as a candidate for the chair of chemistry at Edinburgh in 1843. He held the doctrine that the chemical elements are compounds of equal and similar atoms, and might therefore possibly be all derived from one generic atom. In 1850 he published a tragedy, *Galileo Galilei*, and two volumes of his *Lectures on the Atomic Theory and Essays Scientific and Literary* appeared in 1858, with a preface by his kinsman Dr John Brown, the author of *Horae Subsecivae*. He died at Edinburgh on the 20th of September 1856.

BROWN, THOMAS (1663-1704), English satirist, of "facetious memory" as Addison designates him, was the son of a farmer at Shifnal, in Shropshire, and was born in 1663. He was entered in 1678 at Christ Church, Oxford, where he is said to have escaped expulsion by the famous lines beginning, "I do not love thee, Dr Fell." He was for three years schoolmaster at Kingston-on-Thames, and afterwards settled in London. Under the pseudonym of Dudley Tomkinson he wrote a satire on Dryden, *The Reasons of Mr Bays changing his Religion: considered in a Dialogue between Crites, Eugenius and Mr Bays*, with two other parts having separate titles (1688-1690, republished with additions in 1691). He was the author of a great variety of poems, letters, dialogues and lampoons, full of humour and erudition, but coarse and scurrilous. His writings have a certain value for the knowledge they display of low life in London. He died on the 16th of June 1704, and was buried in the cloister of Westminster Abbey.

His collected works were published in 1707-1708. The second volume contains a collection of *Letters from the Dead to the Living*, some of which are translated from the French. His *Comical Romance done into English* (1772, the *Roman Comique* of Scarron) was reprinted in 1892.

BROWN, THOMAS (1778-1820), Scottish philosopher, was born at Kirkmabreck, Kirkcudbright, where his father was parish clergyman. He was a boy of a refined nature, a wide reader and an eager student. Educated at several schools in London, he went to Edinburgh University in 1792, where he attended Dugald Stewart's moral philosophy class. His attendance was desultory, and he does not appear to have completed his arts course. After studying law for a time he took up medicine; his graduation thesis *De Somno* was well received. But his great strength lay in metaphysical analysis, as was shown in his answer to the objections raised against the appointment of Sir John Leslie to the mathematical professorship (1805). Leslie, a follower of Hume, was attacked by the clerical party as a sceptic and an infidel, and Brown took the opportunity to defend Hume's doctrine of causality as in no way inimical to religion. His defence, at first only a pamphlet, became in its third edition a lengthy treatise entitled *Inquiry into the Relation of Cause and Effect*, and is a fine specimen of Brown's analytical faculty. In 1806 he became a medical practitioner in partnership with James Gregory, but, though successful in his profession, preferred literature and philosophy. After twice failing in the attempt to gain a professorship in the university, he was invited, during an illness of Dugald Stewart in the session of 1808-1809, to act as his substitute, and during the following session he undertook a great part of Stewart's work. The students received him with enthusiasm, due partly to his splendid rhetoric and partly to the novelty and ingenuity of his views. In 1810 he was appointed as colleague to Stewart, a position which he held for the rest of his life. He wrote his lectures at high pressure, and devoted much time to the editing and publication of the numerous poems which he had written at various times during his life. He was also engaged in preparing an abstract of his lectures as a handbook for his class. His health, never strong, gave way under the strain of his work. He was advised to take a voyage to London, where he died on the 2nd of April 1820.

His friend and biographer, David Welsh (1795-1845), superintended the publication of his text-book, the *Physiology of the Human Mind*, and his *Lectures on the Philosophy of the Human Mind* was published by his successors, John Stewart and the Rev. E. Milroy. The latter was received with great enthusiasm both in England (where it reached its 19th edition) and in America, but recent criticism has lessened its popularity and it is now almost forgotten.

Brown's philosophy occupies an intermediate place between the earlier Scottish school and the later analytical or associational psychology. To the latter Brown really belonged, but he had preserved certain doctrines of the older school which were out of harmony with his fundamental view. He still retained a small quantum of intuitive beliefs, and did not appear to see that the very existence of these could not be explained by his theory of mental action. This intermediate or wavering position accounts for the comparative neglect into which his works have now fallen. They did much to excite thinking, and advanced many problems by more than one step, but they did not furnish a coherent system, and the doctrines which were then new have since been worked out with greater consistency and clearness.

Brown wrote a criticism of Darwin's *Zoonomia* (1796), and was one of the first contributors to the *Edinburgh Review*, in the second number of which he published a criticism of the Kantian philosophy, based entirely on Villers's French account of it. Among his poems, which are modelled on Pope and Akenside and rather commonplace, may be mentioned: *Paradise of Coquettes* (1814); *Wanderer in Norway* (1815); *Warfield* (1816); *Bower of Spring* (1817); *Agnes* (1818); *Emily* (1819); a collected edition in 4 vols. appeared in 1820.

For a severe criticism of Brown's philosophy, see Sir W. Hamilton's *Discussions and Lectures on Metaphysics*; and for a high estimate of his merits, see J. S. Mill's *Examination of Hamilton*. See also D. Welsh's *Account of the Life and Writings, &c.* (1825); McCosh's *Scottish Philosophy*, pp. 317-337. The only German writer who seems to have known anything of Brown is Beneke, who found in him anticipations of some of his own doctrines. See *De nova Psychologie*, pp. 320-330.

BROWN, THOMAS EDWARD (1830-1897), British poet, scholar and divine, was born on the 5th of May 1830, at Douglas, Isle of Man. His father, the Rev. Robert Brown, held the living of St Matthew's—a homely church in a poor district. His mother came of Scottish parentage, though born in the island. Thomas, the sixth of ten children, was but two years old when the family removed to Kirk Braddan vicarage, a short distance from Douglas, where his father (a scholar of no university, but so fastidious about composition that he would have some sentences of an English classic read to him before answering an invitation) took share with the parish schoolmaster in tutoring the clever boy until, at the age of fifteen, he was entered at King William's College. Here his abilities soon declared themselves, and hence he proceeded to Christ Church, Oxford, where his position (as a servitor) cost him much humiliation, which he remembered to the end of his life. He won a double first, however, and was elected a fellow of Oriel in April 1854. Dean Gaisford having refused to promote him to a senior studentship of his own college, on the ground that no servitor had ever before attained to that honour. Although at that time an Oriel fellowship conferred a deserved distinction, Brown never took kindly to the life, but, after a few terms of private pupils, returned to the Isle of Man as vice-principal of his old school. He had been ordained deacon, but did not proceed to priest's orders for many years. In 1857 he married his cousin, Miss Stowell, daughter of Dr Stowell of Ramsey, and soon afterwards left the island once more to become headmaster of the Crypt school, Gloucester—a position which in no long time he found intolerable. From Gloucester he was summoned by the Rev. John Percival (afterwards bishop of Hereford), who had recently been appointed to the struggling young foundation of Clifton College, which he soon raised to be one of the great public schools. Percival wanted a master for the modern side, and made an appointment to meet Brown at Oxford; "and there," he writes, "as chance would have it, I met him standing at the corner of St Mary's

Entry, in a somewhat Johnsonian attitude, four-square, his hands deep in his pockets to keep himself still, and looking decidedly volcanic. We very soon came to terms, and I left him there under promise to come to Clifton as my colleague at the beginning of the following term." At Clifton Brown remained from September 1863 to July 1892, when he retired—to the great regret of boys and masters alike, who had long since come to regard "T.E.B.'s" genius, and even his eccentricities, with a peculiar pride—to spend the rest of his days upon the island he had worshipped from childhood and often celebrated in song. His poem "Betsy Lee" appeared in *Macmillan's Magazine* (April and May 1873), and was published separately in the same year. It was included in *Poet's's Yarns* (1881), which reached a second edition in 1889. This volume included at least three other notable poems—"Tommy Big-eyes," "Christmas Rose," and "Captain Tom and Captain Hugh." It was followed by *The Doctor and other Poems* (1887), *The Manx Witch and other Poems* (1889), and *Old John and other Poems*—a volume mainly lyrical (1893). Since his death all these and a few additional lyrics and fragments have been published in one volume by Messrs Macmillan under the title of *The Collected Poems of T. E. Brown* (1900). His familiar letters (edited in two volumes by an old friend, Mr S. T. Irwin, in 1900) bear witness to the zest he carried back to his native country, although his thoughts often reverted to Clifton. In October 1897 he returned to the school on a visit. He was the guest of one of the house-masters, and on Friday evening, 29th October, he gave an address to the boys of the house. He had spoken for some minutes with his usual vivacity, when his voice grew thick and he was seen to stagger. He died in less than two hours. Brown's more important poems are narrative, and written in the Manx dialect, with a free use of pauses, and sometimes with daring irregularity of rhythm. A rugged tenderness is their most characteristic note; but the emotion, while almost equally explosive in mirth and in tears, remains an educated emotion, disciplined by a scholar's sense of language. They breathe the fervour of an island patriotism (humorously aware of its limits) and of a simple natural piety. In his lyrics he is happiest when yoking one or the other of these emotions to serve a philosophy of life, often audacious, but always genial. (A. T. Q.-C.)

BROWN, SIR WILLIAM, BART. (1784–1864), British merchant and banker, founder of the banking-house of Brown, Shipley & Co., was born at Ballymena, Ireland, on the 30th of May 1784, the son of an Irish linen-merchant. At the age of sixteen he accompanied his father and brothers to Baltimore, Maryland, U.S.A., whither it had been decided to transfer the family business, but in 1809 left America for Liverpool. Here he established a branch of the firm, which had now begun to deal largely in raw cotton as well as linen and soon afterwards developed into one of general merchants and finally bankers. Brown became one of the leaders in Liverpool commerce, and in 1832 took a principal share in the reform of the system of dock-management then in vogue at that port. The great financial crisis of 1837 seriously threatened the ruin of the firm, but on Brown's urgent representations as to the multiplicity of interests involved the Bank of England agreed to advance him £2,000,000 to tide matters over. Actually Brown only found it necessary to apply for £1,000,000, which he repaid within six months. His business, both mercantile and banking, continued to increase, and in 1844 he was in possession of a sixth of the trade between Great Britain and the United States. "There is hardly," declared Richard Cobden at this period, "a wind that blows, or a tide that flows in the Mersey, that does not bring a ship freighted with cotton or some other costly commodity for Mr Brown's house." In 1856 the friction between the British and American governments due to the enlistment by British consuls of recruits for the Crimean War was largely allayed by the action of Brown, who in an interview with Lord Palmerston, then prime-minister, explained the objections taken in America. From 1846 to 1859 he was Liberal M.P. for South Lancashire. In 1860 he presented Liverpool with a public library and museum, and in 1863 was made a baronet. He died at Liverpool in 1864.

BROWN, WILLIAM LAURENCE (1755–1830), Scottish divine, was born on the 7th of January 1755 at Utrecht, where his father was minister of the English church. The father, having been appointed professor of ecclesiastical history at St Andrews, returned to Scotland in 1757, and his son went to the grammar school of that city, and then to the university. After passing through the divinity classes, he went in 1774 to the university of Utrecht, where he studied theology and civil law. In 1777 he was appointed to the English church in Utrecht, and about 1788 to the professorship of moral philosophy and ecclesiastical history in the university, to which was soon added the professorship of the law of nature. The war which followed the French Revolution finally drove Brown in January 1795 to London, where he was cordially welcomed. In 1795 the magistrates of Aberdeen appointed him to the chair of divinity, and soon after he was made principal of Marischal College. In the year 1800 he was appointed chaplain in ordinary to the king, and in 1804 dean of the chapel royal, and of the order of the Thistle. He died on the 11th of May 1830. His most widely-known works were an *Essay on the Natural Equality of Men* (1793), which gained the Teylet Society's prize; a treatise *On the Existence of the Supreme Creator* (1816), to which was awarded the first Burnet prize of £1250; and *A Comparative View of Christianity, and of the other Forms of Religion with regard to their Moral Tendency* (2 vols., 1826).

BROWN BESS, a name given in the British army to the flint-lock musket with which the infantry were formerly armed. The term is applied generally to the weapon of the 18th and early 19th centuries, and became obsolete on the introduction of the rifle. The first part of the name derives from the colour of the wooden stock, for the name is found much earlier than the introduction of "browning" the barrel of muskets; "Bess" may be either a humorous feminine equivalent of the "brown-bill," the old weapon of the British infantry, or a corruption of the "buss," i.e. box, in "blunderbuss."

BROWNE, EDWARD HAROLD (1811–1891), English bishop, was born at Aylesbury and educated at Eton and Cambridge. He was ordained in 1836, and two years later was elected senior tutor of Emmanuel College, Cambridge. From 1843 to 1849 he was vice-principal of St David's College, Lampeter, and in 1854 was appointed Norrisian professor of divinity at Cambridge. His best-known book is the *Exposition of the Thirty-nine Articles* (vol. i., Cambridge, 1850; vol. ii., London, 1853), which remained for many years a standard work on the subject. In 1864 he was consecrated bishop of Ely, and proceeded to reorganize his diocese. He maintained that the deposition of Bishop Colenso endangered the independence of bishops. Nevertheless, he was opposed to Colenso's criticism of the Bible, and replied to it in *The Pentateuch and the Elohistic Psalms* (1863), written from a conservative standpoint. In 1866 he was one of the consecrating prelates when Temple became bishop of Exeter, and endeavoured to remove the prejudice against his appointment by showing that Temple was not responsible for the views of other writers in the famous *Essays and Reviews* (1860). He was bishop of Winchester from 1873 till 1890, when ill-health compelled him to resign.

BROWNE, HABLÖT KNIGHT (1815–1882), English artist, famous as "Phiz," the illustrator of the best-known books by Charles Dickens, Charles Lever and Harrison Ainsworth in their original editions. His talents in other directions of art were of a very ordinary kind. As an interpreter and illustrator of Dickens's characters, "Phiz," as he always signed his drawings, was in some respects the equal of his rivals Cruikshank and Leech, while, in his own way, he excelled them both. Of Huguenot extraction, he was born in Lambeth on the 11th of June 1815. His father died early and left the family badly off. Browne was apprenticed to Finden, the eminent engraver on steel, in whose studio he obtained his only artistic education. To engraving, however, he was entirely unsuited, and having in 1833 secured an important prize from the Society of Arts for a drawing of "John Gilpin," he abandoned engraving in the following year and took to other artistic work, with the ultimate object of becoming a painter. In the spring of 1836 he met Charles

Dickens. It was at the moment when the serial publication of *Pickwick* was in danger from the want of a capable interpreter for the illustrations. Dickens knew Browne slightly as the illustrator of his little pamphlet *Sunday under Three Heads*, and probably this slight knowledge of his work stood the draughtsman in good stead. In the original edition of *Pickwick*, issued in shilling monthly parts from early in 1836 until the end of 1837, the first seven plates were drawn by Robert Seymour, a clever illustrator who committed suicide in April 1836. The next two plates were by R. W. Buss, an otherwise successful portrait-painter and lecturer, but they were so poor that a change was imperative. Browne and W. M. Thackeray called independently at the publishers' office with specimens of their powers for Dickens's inspection. The novelist preferred Browne. Browne's first two etched plates for *Pickwick* were signed "Nemo," but the third was signed "Phiz," a pseudonym which was retained in future. When asked to explain why he chose this name he answered that the change from "Nemo" to "Phiz" was made "to harmonize better with Dickens's Box." Possibly Browne adopted it to conceal his identity, hoping one day to become famous as a painter. It is to be noted, however, that "Phiz" is usually attached to his better work and H. K. B. to his less successful drawings. "Phiz" undoubtedly created Sam Weller, so far as his well-known figure is concerned, as Seymour had created Pickwick. Dickens and "Phiz" were personally good friends in early days, and in 1838 travelled together to Yorkshire to see the schools of which Nicholas Nickleby became the hero; afterwards they made several journeys of this nature in company to facilitate the illustrator's work. The other Dickens characters which "Phiz" realized most successfully are perhaps Squeers, Micawber, Guppy, Major Bagstock, Mrs Gamp, Tom Finch and, above all, David Copperfield. Of the books by Dickens which "Phiz" illustrated the best are *David Copperfield*, *Pickwick*, *Dombey and Son*, *Martin Chuzzlewit* and *Bleak House*. Browne made several drawings for *Punch* in early days and also towards the end of his life; his chief work in this direction being the clever design for the wrapper which was used for eighteen months from January 1842. He also contributed to *Punch's Pocket Books*. In addition to his work for Dickens, "Phiz" illustrated over twenty of Lever's novels (the most successful being *Harry Lorrequer*, *Charles O'Malley*, *Jack Hinton* and the *Knight of Gwynne*). He also illustrated Harrison Ainsworth's and Frank Smedley's novels. *Merryn Clitheroe* by Ainsworth is one of the most admirable of the artist's works. Browne was in continual employment by publishers until 1867, when he had a stroke of paralysis. Although he recovered slightly and made many illustrations on wood, they were by comparison inferior productions which the draughtsman's admirers would willingly ignore. In 1878 he was awarded an annuity by the Royal Academy. He gradually became worse in health, until he died on the 8th of July 1882.

Most of Browne's work was etched on steel plates because these yielded a far larger edition than copper. Browne was annoyed at some of his etchings being transferred to stone by the publishers and printed as lithographic reproductions. Partly with the view to prevent this treatment of his work he employed a machine to rule a series of lines over the plate in order to obtain what appeared to be a tint; when manipulated with acid this tint gave an effect somewhat resembling mezzotint, which at that time it was found practically impossible to transfer to stone. The illustrations executed by Browne are particularly noteworthy because they realized exactly what the reader most desired to see represented. So skillful was he in drawing and composition that no part of the story was avoided by reason of the elaborateness of the subject. Whatever was the best incident for illustration was always the one selected.

See D. Croll Thomson, *Habitu Knight Browne, "Phiz": Life and Letters* (London, 1884); John Forster, *Life of Charles Dickens* (London, 1871-1874); F. G. Kitton, "Phiz": *A Memoir* (London, 1882); *Charles Dickens and his Illustrators* (London, 1890); M. H. Spielmann, *The History of Punch* (London, 1895). (D. C. T.)

BROWNE, ISAAC HAWKINS (1705-1760), English poet, was born on the 21st of January 1705 at Burton-upon-Trent, of

which place his father was vicar. He was educated at Lichfield, at Westminster school, and at Trinity College, Cambridge. After taking his M.A. degree he removed to Lincoln's Inn, and was called to the bar, but never practised. He was the author of "Design and Beauty," a poem addressed to his friend Joseph Highmore the painter; and of "The Pipe of Tobacco" which parodied Cibber, Ambrose Philips, Thomson, Young, Pope and Swift, who were then all living. He was elected to Parliament through private interest in 1744 and again in 1747 for the borough of Wenlock in Shropshire. In 1754 he published his chief work, *De Animi Immortalitate*, a Latin poem much admired by the scholars of his time. The best of the many translations of these verses is by Soame Jenyns. Browne is said by Johnson to have been "one of the first wits of this country." He was a brilliant talker in private life, especially when his tongue was loosed by wine; but he made no mark in public life. He died in London on the 14th of February 1760.

Two editions of his *Poems on Various Subjects, Latin and English* were published in 1767 by his son Isaac Hawkins Browne (1745-1812), the author of two volumes of essays on religion and morals. One of these was printed for private circulation, and is said to have contained a memoir. A full account by Andrew Kippis in *Biographia Britannica* (1780) includes large extracts from his poems.

BROWNE, JAMES (1793-1841), Scottish man of letters, was born at Whitefield, Perthshire, in 1793. He was educated at Edinburgh and at the university of St Andrews, where he studied for the church. He wrote a "Sketch of the History of Edinburgh," for Ewbank's *Picturesque Views* of that city, 1823-1825. In 1826 he became a member of the Faculty of Advocates, and obtained the degree of LL.D. from King's College, Aberdeen. His works include a *Critical Examination of Macculloch's Work on the Highlands and Islands of Scotland* (1826), *Aperçu sur les Hiéroglyphes d'Égypte* (Paris, 1827), a *Vindication of the Scottish Bar from the Attacks of Mr Bronghton*, and *History of the Highlands and Highland Clans* (1834-1835). He was appointed editor of the *Caledonian Mercury* in 1837, and two years later he became sub-editor of the seventh edition of the *Encyclopædia Britannica*, to which he contributed a large number of articles. He died in April 1841.

BROWNE, SIR JAMES (1839-1866), Anglo-Indian engineer and administrator, was the son of Robert Browne of Falkirk in Scotland. He was educated at the military college, Addiscombe, and received a commission in the Bengal engineers in 1857. He served in the expedition against the Mahsud Wazirs in 1860, being mentioned in despatches, and in 1863 in the Umbeyla campaign, when he was three times mentioned. In January 1875 he became superintendent of works for the building of the Indus bridge. In 1877 he was promoted lieutenant-colonel, and in 1878-1879 accompanied Sir Donald Stewart as political officer during the Afghan War. He took part in several engagements, was mentioned in despatches, and received the C.B. In 1881 he became colonel, and in 1882 commanded the Indian engineer contingent sent to Egypt, being present at the battle of Tell-el-Kebir. For his services in Egypt he received the 3rd class of the Osmanieh Order and the khedive's star. In 1884 he was appointed engineer in chief of the Sind-Punjab railway. In 1888 he was made a K.C.S.I. and in 1889 quarter-master-general for India. In 1892 he was appointed agent to the governor-general in Baluchistan, in succession to Sir Robert Sandeman, his intimate experience of the Baluchis gained during his railway work, having specially fitted him for this post. He died suddenly on the 13th of June 1896. Sir James Browne was a man of splendid courage and physique, and many tales are told of the personal prowess which, together with his sympathetic knowledge of the natives, made him a popular hero among the frontier tribesmen.

See General McLeod Innes, *The Life and Times of Sir James Browne* (1905).

BROWNE, MAXIMILIAN ULYSSES, COUNT VON, BARON DE CAMUS and MOUNTANY (1705-1757), Austrian field marshal, was born at Basel on the 23rd of October 1705. His father (Ulysses Freiherr v. Browne, d. 1731) was an Irish exile of 1609, who entered the imperial service and in 1716 was made a count

of the Empire (*Reichsgraf*) by the emperor Charles VI. His uncle Georg, Reichsgraf von Browne (1698-1792), was a distinguished soldier; who rose to the rank of field marshal in the Russian army, and was made Reichsgraf by the emperor Joseph II. in 1779. The powerful influence which he commanded, through his father and his wife (*née* Countess Marie Philippine v. Martinitz), advanced the young officer through the subordinate grades so rapidly that at the age of twenty-nine he was colonel of an infantry regiment. But he justified his early promotion in the field, and in the Italian campaign of 1734 he greatly distinguished himself. In the Tirolese fighting of 1735, and in the unfortunate Turkish war, he won further distinction as a general officer. He was a lieutenant field marshal in command of the Silesian garrisons when in 1740 Frederick II. and the Prussian army overran the province. His careful employment of such resources as he possessed materially hindered the king in his conquest and gave time for Austria to collect a field army (see AUSTRIAN SUCCESSION, WAR OF THE). He was present at Mollwitz, where he received a severe wound. His vehement opposition to all half-hearted measures brought him frequently into conflict with his superiors, but contributed materially to the unusual energy displayed by the Austrian armies in 1742 and 1743. In the following campaigns Browne exhibited the same qualities of generalship and the same impatience of control. In 1745 he served under Count Traun, and was promoted to the rank of Feldzeugmeister. In 1746 he was present in the Italian campaign and the battles of Piacenza and Rottofredo. Browne himself with the advanced guard forced his way across the Apennines and entered Genoa. He was thereafter placed in command of the army intended for the invasion of France, and early in 1747 of all the imperial forces in Italy. At the end of the war Browne was engaged in the negotiations which led to the convention of Nice (January 21st, 1749). He became commander-in-chief in Bohemia in 1751, and field marshal two years later. He was still in Bohemia when the Seven Years' War opened with Frederick's invasion of Saxony (1756). Browne's army, advancing to the relief of Pirna (see SEVEN YEARS' WAR), was met, and, after a hard struggle, defeated by the king at Lobositz, but he drew off in excellent order, and soon made another attempt with a picked force to reach Pirna, by wild mountain tracks. The field marshal never spared himself, bivouacking in the snow with his men, and Carlyle records that private soldiers made rough shelters over him as he slept. He actually reached the Elbe at Schandau, but as the Saxons were unable to break out Browne retired, having succeeded, however, in delaying the development of Frederick's operations for a whole campaign. In the campaign of 1757 he voluntarily served under Prince Charles of Lorraine (*q.v.*) who was made commander-in-chief, and on the 6th of May in that year, while leading a bayonet charge at the battle of Prague, Browne, like Schwerin on the same day, met his death. He was carried mortally wounded into Prague, and there died on the 26th of June, his last days embittered by the knowledge that he was unjustly held responsible for the failure of the campaign. His name has been borne, since 1888, by the 36th Austrian infantry.

See *Zweizeilige Lebensbeschreibung U.M. Reichsgrafen, v. B. . K.-K. Gen.-Feldmarschall (Frankfurt and Leipzig, 1757)*; Baron O'Callil, *Gesch. der grössten Herrführer* (Rastadt, 1785, v. ii. pp. 264-316).

BROWNE, PETER (?1665-1735), Irish divine and bishop of Cork and Ross, was born in Co. Dublin, not long after the Restoration. He entered Trinity College, Dublin, in 1682, and after ten years' residence obtained a fellowship. In 1699 he was made provost of the college, and in the same year published his *Letter in answer to a Book entitled "Christianity not Mysterious,"* which was recognized as the ablest reply yet written to Toland. It expounds in germ the whole of his later theory of analogy. In 1710 he was made bishop of Cork and Ross, which post he held till his death in 1735. In 1713 he had become somewhat notorious from his vigorous pamphleteering attack on the fashion of drinking healths, especially "to the glorious and immortal memory." His two most important works are the

Procedure, Extent, and Limits of the Human Understanding (1728), an able though sometimes captious critique of Locke's essay, and *Things Divine and Supernatural conceived by Analogy with Things Natural and Human*, more briefly referred to as the *Divine Analogy* (1733). The doctrine of analogy was intended as a reply to the deistical conclusions that had been drawn from Locke's theory of knowledge. Browne holds that not only God's essence, but his attributes are inexpressible by our ideas, and can only be conceived analogically. This view was vigorously assailed as leading to atheism by Berkeley in his *Alciphron* (Dialogue iv.), and a great part of the *Divine Analogy* is occupied with a defence against that criticism. The bishop emphasizes the distinction between metaphor and analogy; though the conceived attributes are not thought as they are in themselves, yet there is a reality corresponding in some way to our ideas of them. His analogical arguments resemble those found in the Bampton Lectures of Dean Mansel. Browne was a man of abstemious habits, charitable disposition, and impressive eloquence. He died on the 27th of August 1735.

BROWNE, ROBERT (1550-1633), a leader among the early Separatist Puritans (hence sometimes called Brownists), was born about 1550 at Tolethorpe, near Stamford. He was of an ancient family, several members of which had been distinguished as merchants, county magnates and local benefactors. He was educated at Corpus Christi College, Cambridge, "commencing B.A." in 1572. For some years he was a schoolmaster, but in what place is uncertain. In 1579, on a brother's application and without his own consent, he was licensed to preach, and actually preached for some six months in Cambridge, where he gained considerable popularity; but impugning the episcopal order of the Established Church, he had his licence revoked early in the following year. He then went, on the invitation of Robert Harrison, "Maister in the Hospitall," to Norwich, where he soon gathered a numerous congregation, the members of which became associated in a religious "covenant," to the refusing of "all ungodlie communion with wicked persons." He seems also to have preached in various parts of Norfolk and Suffolk, especially at Bury St Edmunds, and vigorously denounced the form of government existing in the Church, which at this time he held incompatible with true "preaching of the word." Dr Freake, bishop of Norwich, caused him to be imprisoned early in 1581, but he was ere long released through the influence of his remote kinsman, the Lord Treasurer Burghley. Before the end of 1581, however, he incurred two more imprisonments, and, apparently in January 1582, migrated with his whole company to Middelburg in Zealand. There they organized a church on what they conceived to be the New Testament model, but the community broke up within two years owing to internal dissensions.

Meanwhile, Browne issued two most important works, *A Treatise of Reformation without Tarrying for Anie*, in which he asserts the inalienable right of the church to effect necessary reforms without the authorization or permission of the civil magistrate; and *A Booke which sheweth the life and manners of all True Christians*, in which he enunciates the theory of Congregational independency (see CONGREGATIONALISM). These, with a third tract (*A Treatise upon the 23. of Matthew*; see C. Burrage, as below, pp. 21-25), making together a thin quarto, were published at Middelburg in 1582. The following year two men were hanged at Bury St Edmunds for circulating them. In January 1584¹ Browne and some of his company came to Edinburgh, after visiting Dundee and St Andrews. He remained some months in Scotland, endeavouring to commend his ecclesiastical theories, but had no success. He then returned to Stamford, in which town or neighbourhood he seems to have resided chiefly for the next two years, his residence being broken by visits to London and probably to the continent (early in 1585), and by at least one imprisonment (summer, 1585). His attitude to the lawfulness of occasional attendance at services in parish churches seems to have been changing about this time; on the

¹ Probably after writing *A True and Short Declaration*, the main source of our knowledge of his life hitherto.

7th of October 1585 he was induced to make a qualified submission to the established order. The story that this result was brought about by excommunication, actual or threatened, is very doubtful, and rests on late and questionable authority. A further submission prepared the way for his appointment, in November 1586, to the mastership of St Olave's grammar school, Southwark, which he held for more than two years. During part of this time he was much engaged in controversy, on the one hand with Stephen Bredwell, an uncompromising advocate of the established order, and on the other with some of those who more or less occupied his own earlier position, and now looked upon him as a renegade. In particular he several times replied to Barrowe and Greenwood; one of his replies, entitled *A Reproofe of certaine schismatical persons and their doctrine touching the hearing and preaching of the word of God* (1587-1588), has recently been recovered, and sheds a flood of light upon the development of Browne's later views (see Burrage, pp. 45-62, for this whole period).

Before the 20th of June 1589 his mastership of St Olave's seems to have terminated, and after being rector of Little Casterton (in the gift of his eldest brother) for a month or two, he finally, in September 1591, accepted episcopal ordination and the rectory of Achurch-cum-Thorpe Waterville, in Northamptonshire. There he ministered for forty-two years, with one lengthy interval, 1617-1626, which is only partly accounted for (see Burrage, pp. 68-71). There is reason to believe that he never entirely abandoned his early ideal, but latterly thought it possible to maintain a spiritual fellowship within the framework of the Established Church. The closing years of his life seem to have been clouded, due partly to separation among his own flock, and partly to growing irritability in himself, a lonely and disappointed man. When over eighty years old he had a dispute with the parish constable about a rate, blows were struck, and before a magistrate he behaved so stubbornly that he was sent to Northampton gaol, where he died in October 1633. He was buried in St Giles's churchyard, Northampton. In spite of his later attitude of compromise with expediency, which he felt forced on him by external conditions too strong to defy or ignore, Robert Browne remains a pioneer in ecclesiastical theory in England, the first formulator of an ideal which subsequently became known as Congregationalism (*q.v.*). He rediscovered certain forgotten aspects of primitive church life, and did not shrink from suffering for the sake of what he held to be the truth. In addition to the works above-mentioned, Browne wrote several controversial and apologetic treatises, of which some remained in MS. until quite recently, and some are still missing.

See H. M. Dexter, *The Congregationalism of the Last Three Hundred Years* (1880); C. Burrage, *The True Story of Robert Browne* (Oxford, 1906); *Congregational Historical Society's Transactions*, *passim* (1901-1906).

BROWNE, SIR THOMAS (1605-1682), English author and physician, was born in London, on the 19th of October 1605. He was admitted as a scholar of Winchester school in 1616, and matriculated at Broadgates Hall (Pembroke College), Oxford, in 1623, where he graduated B.A. in January 1626. He took the further degree of M.A. in 1629, studied medicine, and practised for some time in Oxfordshire. Between 1630 and 1633 he left England, travelled in Ireland, France and Italy, and on his way home received the degree of M.D. at the university of Leiden. He returned to London in 1634, and, after a short residence at Shipden Hall, near Halifax, settled in practice at Norwich in 1637. He married in 1641 Dorothy Mileham. Their eldest son, Edward, became president of the Royal College of Physicians, and glimpses of their happy family life are obtainable in the fragmentary correspondence contained in Simon Wilkin's edition. In 1642 a copy of his *Religio Medici*, which he describes as "a private exercise directed to myself," was printed from one of his MSS. without his knowledge, and reviewed by Sir Kenelm Digby in *Observations* . . . (1643). The interest aroused by this edition compelled Browne to put forth a correct version (1643) of the work, in which letters between Digby and Browne

were included. The book was probably written as early as 1635, for he describes himself as still under thirty. In 1646 he published *Pseudodoxia Epidemica; Enquiries into very many commonly received Tenents and commonly presumed Truths* (1646), and in 1658 *Hydriothopia, Urne-Buriall; or, a discourse of the sepulchrall urnes lately found in Norfolk. Together with the Garden of Cyrus, or the quincunciall, lazenge, or net-work plantations of the ancients, artificially, naturally, and mystically considered. With Sundry observations* (1658). These four works were all that he published, though several tracts, notably the *Christian Morals*¹ intended as a continuation of *Religio Medici*, were prepared for publication, and appeared posthumously. In 1671 he received the honour of knighthood from Charles II. on his visit to Norwich. He began a correspondence with John Evelyn in 1658. Very few of the letters are extant, but the diarist has left an account of a visit to Browne (*Diary*, 17th of October 1671). He died in 1682 on his seventy-seventh birthday, and was buried at St Peter's, Mancroft, Norwich. His coffin was accidentally broken in 1840, and his skull is preserved in the museum of the Norwich hospital.

Browne's writings are among the few specimens of purely literary work produced during a period of great political excitement and discord. He remained to all appearance placidly indifferent to the struggle going on around him. His first book appeared in the year of the outbreak of the Civil War; *Pseudodoxia Epidemica* in the critical year of 1646; and *Hydriothopia*, the reflections on the shortness of human life inspired by the unearthing of some funeral urns, on the eve of the Restoration. A mind as aloof as his is a psychological curiosity, and its peculiarities are faithfully reflected in the form and matter of his works. His display of erudition, his copious citations from authorities, his constant use of metaphor and analogy, and his elaborate diction, are common qualities of the writers of the 17th century, but Browne stands apart from his contemporaries by reason of the peculiar cast of his mind. Imbued with the Platonic mysticism which taught him to look on this world as only the image, the shadow of an invisible system, he regarded the whole of experience as only food for contemplation. Nothing is too great or too small for him; all finds a place in the universe of being, which he seems to regard almost from the position of an outsider. He did not speculate systematically on the problems of existence, but he meditates repeatedly on the outward and visible signs of mortality, and on what lies beyond death. Of Browne, as of the greatest writers, it is true that the style is the man. The form of his thought is as peculiar and remarkable as the matter; the two, indeed, react on one another. Much of the quaintness of his style, no doubt, depends on the excessive employment of latinized words, many of which have failed to justify their existence; but the peculiarities of his vocabulary do not explain the unique character of his writing, which is appreciated to-day as much as ever.

The *Religio Medici* was a puzzle to his contemporaries, and it is still hard to reconcile its contradictions. A Latin translation appeared at Leiden in 1644, and it was widely read on the continent, being translated subsequently into Dutch, French and German. In Paris it was issued in the belief that Browne was really a Roman Catholic, but in Rome the authorities thought otherwise, and the book was placed on the *Index Expurgatorius*. It is the confession of a mind keen and sceptical in some aspects, and credulous in others. Browne professes to be absolutely free from heretical opinions, but asserts the right to be guided by his own reason in cases where no precise guidance is given either by Scripture or by Church teaching. "I love," he says, "to lose myself in a mystery, to pursue my reason to an O. Altitudol" The *Pseudodoxia Epidemica*, written in a more direct and simple style than is usual with Browne, is a wonderful storehouse of out-of-the-way facts and scraps of erudition.

¹ Ed. John Jeffery, archdeacon of Norwich, 1716. The signed "Letter to a Friend, upon the occasion of the Death of his Intimate Friend" (written about 1672, pr. 1690) has been generally supposed to be a preliminary sketch for *Christian Morals*, but Dr W. A. Greenhill thinks it was written later.

exhibiting a singular mixture of credulity and shrewdness. Sir Thomas evidently takes delight in discussing the wildest fables. That he himself was by no means free from superstition is proved by the fact that the condemnation of two unfortunate women, Amy Duny and Rose Cullender, for witchcraft at Norwich in 1664 was aided by his professional evidence. The *Garden of Cyrus* is a continued illustration of one quaint conceit. The whole universe is ransackered for examples of the *Quincunx*, and he discovers, as Coleridge says, "quincunxes in heaven above, quincunxes in earth below, quincunxes in the mind of man, quincunxes in tones, in optic nerves, in roots of trees, in leaves, in everything!" But the whole strength of his genius and the wonderful charm of his style are to be sought in the *Urburial*, the concluding chapter of which, for richness of imagery and majestic pomp of diction, can hardly be paralleled in the English language. For anything at all resembling it we must turn to the finest passages of Jeremy Taylor or of Milton's prose writings.

In 1684 appeared a collection of *Certain Miscellaneous Tracts* (ed. Tenison), and in 1712 *Posthumous Works of the learned Sir Thomas Browne*. The first collected edition of Browne's works appeared in 1686. It is said to have been edited by Dr. afterwards Archbishop Tenison. Sir Thomas Browne's *Works, including his Life and Correspondence*, were carefully edited by Simon Wilkin in 1835-1836. Among modern reprints may be mentioned Dr. W. A. Greenhill's editions in the "Golden Treasury" series of the *Religio Medici, Letter to a Friend and Christian Morals* (1881), with an admirable bibliographical note on the complicated subject of the numerous editions of the *Religio Medici*; of the *Hydriotaphia and the Garden of Cyrus* (1896), completed by Mr. E. H. Marshall; a complete edition for the English Library, edited by Mr. Charles Sayle (1924, &c.). Browne's interest in bird-lore is noted by Evelyn, and some *Fishes and Letters on the Natural History of Norfolk* were collected from his MSS. in the Sloane Collection, and edited by Thomas Southwell in 1902.

BROWNE, WILLIAM (1591-1643), English pastoral poet, was born at Tavistock, Devonshire, in 1591, of a branch of the family of Browne of Betchworth Castle, Surrey. He received his early education at the grammar school of his native town, and is said to have proceeded to Oxford about 1603. After a short residence at Clifford's Inn he entered the Inner Temple in 1611. His elegy on the death of Henry, prince of Wales, and the first book of *Britannia's Pastorals* appeared in 1613; the *Shepherd's Pipe*, which contained some eclogues by other poets, in 1614. The second book of the pastorals (1616) is dedicated to William Herbert, earl of Pembroke, whose seat at Wilton was Browne's home for some time. In 1624 he returned to Oxford as tutor to Robert Dormer, afterwards earl of Carnarvon, matriculating at Exeter College in April and receiving his M.A. degree in November of the same year. Nearly all Browne's poetic work dates from his early manhood, before his marriage in 1628 with Timothy, daughter of Sir Thomas Eversham of Horsham, Essex. In the fourth eclogue of George Withers's *Shepherd's Hunting*, written as early as 1613-1614, Philarete (Wither) asks Willy (Browne) why he is silent, and the reply is that some "my music do contemne." The times were unfavourable to his tranquil talent, and the second half of his life was spent in retirement. He died some time before 1645, when letters of administration were granted to his widow, and he may have been the William Browne whose burial is recorded in the Tavistock registers under the date of the 27th of March 1643.

Browne was the pupil and friend of Michael Drayton, who associates "my Browne" in the "Epistle to Henry Reynolds" with the two Beaumonts as "my dear companions whom I freely chose, My bosom friends." But directly indebted as Browne is for the form of his poems, for the slight story and the rather wearisome allegory, to Spenser, Sidney, Drayton and especially to Fletcher's *Faithful Shepherdess*, his poetry is no mere copy of any of these models. His Arcadia is localized in his native Devonshire. He was untiring in his praises of "Tavy's voiceful stream (to whom I owe more strains than from my pipe can ever flow)." He knew local history and traditions, and he celebrates the gallant sailors who "by their power made the Devonian shore Mock the proud Tagus." (*Brit. Past.* bk. ii., song 3). It is for his truthful, affectionate pictures of his country

life and its surroundings that the stories of Marina and Celandine, Doridon and the rest are still read. A copy of Browne's pastorals with annotations in Milton's handwriting is preserved in the Huth library, and there are many points of likeness between Lycidas and the elegy on Philarete (Thomas Manwood) in the fourth eclogue of the *Shepherd's Pipe*. Keats was a student of Browne, and Herrick's fairy fantasies are thought to owe something to the third book of the pastorals.

The first two books of *Britannia's Pastorals* were re-issued in 1625. The third, though it had no doubt circulated in the author's lifetime, remained unknown until Beriah Botfield discovered a copy of it in the library of Salisbury cathedral, bound up with the 1613 and 1616 editions of the first and second books. This MS. was edited for the Percy Society by T. C. Croker in 1852. A collected edition of Browne's works was published in 1772 by John Davies. It is not known whether *The Inner Temple Masque* on the story of Ulysses and Circe, which was written for performance on the 13th of January 1615, was ever actually represented. A series of sonnets to Caelia, some epistles, elegies and epitaphs, with some other miscellaneous poems, complete the list of Browne's works. These have been collected from various sources, the most important being Lansdowne MS. 777 (British Museum), and they were printed for the first time by Sir S. E. Brydges in 1815. Excellent modern complete editions of Browne and Mr. W. C. Hazlitt's (1868-1869) for the Roxburghe library, and a more compact one (1894) by Mr. Gordon Goodwin, with an introduction by Mr. A. H. Bullen, for the "Muse's Library." For an elaborate analysis of Browne's obligations to earlier pastoral writers see F. W. Moorman, "William Browne" (*Quellen und Forschungen zur Sprach- und Culturgeschichte der Germanischen Völker Strassburg*, 1897). A translation of Marin le Roy de Gomberville's *Polexandre*, by William Browne (1647), may be a posthumous work of the poet's.

BROWNE, WILLIAM GEORGE (1768-1813), English traveller, was born at Great Tower Hill, London, on the 25th of July 1768. At seventeen he was sent to Oriel College, Oxford. Having had a moderate competence left him by his father, on quitting the university he applied himself entirely to literary pursuits. But the fame of James Bruce's travels, and of the first discoveries made by the African Association, determined him to become an explorer of Central Africa. He went first to Egypt, arriving at Alexandria in January 1792. He spent some time in visiting the oasis of Siwa or Jupiter Ammon, and employed the remainder of the year in studying Arabic and in examining the ruins of ancient Egypt. In the spring of 1793 he visited Sinai, and in May set out for Darfur, joining the great caravan which every year went by the desert route from Egypt to that country. This was his most important journey, in which he acquired a great variety of original information. He was forcibly detained by the sultan of Darfur and endured much hardship, being unable to effect his purpose of returning by Abyssinia. He was, however, allowed to return to Egypt with the caravan in 1796; after this he spent a year in Syria, and did not arrive in London till September 1798. In 1799 he published his *Travels in Africa, Egypt and Syria, from the year 1792 to 1798*. The work was full of valuable information; but, from the abruptness and dryness of the style, it never became popular. In 1806 Browne again left England, and spent three years in visiting Greece, some parts of Asia Minor and Sicily. In 1812 he once more set out for the East, proposing to penetrate to Samarkand and survey the most interesting regions of central Asia. He spent the winter in Smyrna, and in the spring of 1813 travelled through Asia Minor and Armenia, made a short stay at Erzerum, and arrived on the 1st of June at Tabriz. About the end of the summer of 1813 he left Tabriz for Teheran, intending to proceed thence into Tartary, but was shortly afterwards murdered. Some bones, believed to be his, were afterwards found and interred near the grave of Jean de Thevenot, the French traveller.

Robert Walpole published, in the second volume of his *Memoirs relating to European and Asiatic Turkey* (1820), from papers left by Browne, the account of his journey in 1802 through Asia Minor to Antioch and Cyprus; also *Remarks written at Constantinople* (1802).

BROWNHILLS, an urban district in the Lichfield parliamentary division of Staffordshire, England, 6 m. W. of Lichfield, on branch lines of the London & North-Western and Midland railways, and near the Essington Canal. Pop. (1891) 11,820; (1901) 15,252. There are extensive coal-mines in the district.

forming part of the Canhoek Chase deposit. The town lies on the Roman Watling Street, and remains of earthworks are seen at Knave's Castle, on the Street, and at Castle Old Fort, 2 m. S.E. Ogley Hay, the parish of which partly covers Brownhills, is a large adjoining village; there are also Great Wyrley and Norton-under-Cannock or Norton Canes to the N.W. and N., with collieries, and at Church Bridge are brick, tile, and edge-tool works. Wyrley Grove is a picturesque mansion of the 17th century.

BROWNING, ELIZABETH BARRETT (1806-1861), English poet, wife of the poet Robert Browning, was born probably at Coxhoe Hall, Durham, for this was the home of her father and mother for some time after their marriage in 1805. Her baptismal register gives the date of her birth as the 6th of March 1806, and that of her christening as the 10th of February 1808. The long misunderstanding as to her age, whereby she was supposed to have been born three years later, was shared by her contemporaries and even for a time by her husband. She was the daughter and eldest child of Edward Barrett Moulton, who added the surname of Barrett on the death of his maternal grandfather, whose estates in Jamaica he inherited. His wife was Mary Graham-Clarke, daughter of J. Graham-Clarke of Fenham Hall, Newcastle-on-Tyne. She died when her illustrious daughter was twenty-two years old. Elizabeth's childhood was passed in the country, chiefly at Hope End, a house bought by her father in the beautiful country in sight of the Malvern Hills. "They seem to me," she wrote, "my native hills; for though I was born in the county of Durham, I was an infant when I went first into their neighbourhood, and lived there until I had passed twenty by several years." Her country poems, such as "The Lost Bower," "Hector in the Garden," and "The Deserted Garden," refer to the woods and gardens of Hope End. Elizabeth Barrett was much the companion of her father, who pleased himself with printing fifty copies of what she calls her "great epic of eleven or twelve years old, in four books"—*The Battle of Marathon* (sent to the printer in 1819). She owns this to have been "a curious production for a child," but disclaims for it anything more than "an imitative faculty." The love of Pope's Homer, she adds, led her to the study of Greek, and of Latin as a help to Greek, "and the influence of all those tendencies is manifest so long afterwards as in my *Essay on Mind* [*Essay on Mind and other Poems*, 1826], a didactic poem written when I was seventeen or eighteen, and long repented of." She was a keen student, and it is told of her that when her health failed she had her Greek books bound so as to look like novels, for fear her doctor should forbid her continuous study. At this time began her friendship with the blind scholar Hugh Stuart Boyd, with whom she read Greek authors, and especially the Greek Christian Fathers and Poets. To him she addressed later three of her sonnets, and he was one of her chief friends until his death in 1848. In 1832 Mr Barrett sold his house of Hope End, and brought his family to Sidmouth, Devon, for some three years. There Elizabeth made a translation of the *Prometheus Bound* of Aeschylus, published with some original poems (1833). After that time London became the home of the Barretts until the children married and the father died. The temporary dwelling was at 74 Gloucester Place, Portman Square, and in 1838 the lease was taken of the final house, 50 Wimpole Street.

It is in the middle of the year 1836 that Elizabeth Barrett's active literary life began. She then made the acquaintance of R. H. Horne, afterwards famous for a time as the author of *Orion*, but perhaps best remembered as her correspondent (*Letters to R. H. Horne*, 2 vols. 1877), and this acquaintance led to the appearance of rather frequent poems by Miss Barrett in the *New Monthly Magazine*, edited by Bulwer (Lord Lytton), and in other magazines or annuals. But the publication of *The Seraphim and other Poems* (1838) was a graver step. "My present attempt," she writes in this year, "is actually, and will be considered by others, more a trial of strength than either of my preceding ones." There was at that date a lull in the production of conspicuous books of poetry. Wordsworth had

ceased, Browning and Tennyson had hardly begun to write their best. Miss Barrett's volume was well reviewed, but not popular, and no second edition was required; of the poems afterwards famous it contained three, "Cowper's Grave," "My Doves," and "The Sea-Mew," the first impressed and the other two very quiet, which a fine taste must rank high among all her works. *The Quarterly Review* (September 1840), in an article on "Modern English Poetesses," criticizes *The Seraphim* with *Prometheus*, and treats the former with respect, but does not lift the author out of the quite unequal company of Mrs Norton, "V," and other contemporary women. In the previous year Elizabeth had made the memorable acquaintance of Wordsworth. "No," she writes, "I was not at all disappointed in Wordsworth, although perhaps I should not have singled him from the multitude as a great man. There is a reserve even in his countenance; . . . his eyes have more meekness than brilliancy; and in his slow, even articulation there is rather the solemnity and calmness of truth itself than the animation and energy of those who seek for it . . . He was very kind, and sat near me and talked to me as long as he was in the room, and recited a translation by Cary of a sonnet of Dante's—and altogether it was a dream." With Lander, at the same date, a meeting took place that had long results. At this time, too, began another of Elizabeth's valued friendships—that with Miss Mitford, author of *Our Village* and other works less well remembered. Mr John Kenyon also became at about this time a dear and intimate friend. He was a distant cousin of the Barretts, had published some verse, and was a warm and generous friend to men of letters. From the date of the birth of their child (1849) he gave the Brownings a hundred pounds a year, and when he died in 1856 he bequeathed to them eleven thousand pounds. To him a great number of Elizabeth's letters are addressed, and to him in later years was *Aurora Leigh* dedicated. Elizabeth Barrett began also in London an acquaintance with Harriet Martineau.

Full of the interest of friendship and literature, the residence in London was unfavourable to Elizabeth's health. In early girlhood she had a spinal affection, and her lungs became delicate. She broke a blood-vessel in the beginning of the Barretts' life in town, and was thereafter an invalid—by no means entirely confined to her room, but often imprisoned there, and generally a recluse, until her marriage. Her state was so threatening that in 1838 it was found necessary to remove her to Torquay, where she spent three years, accompanied by her brother Edward, the dearest of her eight brothers, the only one, she said many years later, who ever comprehended her, and for a time by her father and sisters. During this time of physical suffering she underwent the greatest grief of her life by the drowning of her beloved brother, who with two friends went sailing in a small boat and was lost in Babbacombe Bay. Rumours of the foundering reached the unhappy sister, who was assured of the worst after three days, when the bodies were found. The accident of Edward Barrett's meeting with his death through her residence at Torquay, and the minor accident of her having parted from him on the day of his death, as she said, "with pettish words," increased her anguish of heart to horror. A few days before she had written, "There are so many mercies close around me that God's being seems proved to me, demonstrated to me, by His manifested love." When the blow came, its heavy weight and closeness to her heart convinced her, she wrote, through a awful experience of suffering, of divine action. But many years later the mention of her brother's death was intolerable to her. At the time she only did not die. She had to remain for nearly a year day and night within hearing of the sea, of which the sound seemed to her the moan of a dying man.

There is here an interval of silence in the correspondence which busied her secluded life at all ages; but with an impulse of self-protection she went to work as soon as her strength sufficed. One of her tasks was a part taken in the *Chaucer Modernised* (1841), a work suggested by Wordsworth, to which he, Leigh Hunt, Horne and others contributed. In 1841 she returned to Wimpole Street, and in that and the

following year she was at work on two series of articles on the Greek Christian poets and on the English poets, written for the *Athenaeum* under the editorship of Mr C. W. Dilke. In work she found some interest and even some delight: "Once I wished not to live, but the faculty of life seems to have sprung up in me again from under the crushing foot of heavy grief. Be it all as God will."

It is in 1842 that we notice the name of Robert Browning in her letters: "Mr Home the poet and Mr Browning the poet were not behind in approbation," she says in regard to her work on the poets. "Mr Browning is said to be learned in Greek, especially the dramatists." In this year also she declares her love for Tennyson. To Kenyon she writes, "I ought to be thanking you for your great kindness about this divine Tennyson." In 1842, moreover, she had the pleasure of a letter from Wordsworth, who had twice asked Kenyon for permission to visit her. The visit was not permitted on account of Miss Barrett's ill-health. Now Haydon sent her his unfinished painting of the great poet musing upon Helvellyn; she wrote her sonnet on the portrait, and Haydon sent it to Rydal Mount. Wordsworth's commendation is rather cool. In August 1843 "The Cry of the Children" appeared in *Blackwood's Magazine*, and during the year she was associated with her friend Home in a critical work, *The New Spirit of the Age*, rather by advice than by direct contribution. Her two volumes of poems (1844) appeared, six years after her former book, under the title of *Poems, by Elizabeth Barrett Barrett*. The warmest praises that greeted the new poems were H. F. Chorley's in the *Athenaeum*, John Forster's in the *Examiner*, and those conveyed in *Blackwood*, the *Dublin Review*, the *New Quarterly* and the *Atlas*. Letters came from Carlyle and others. Both he and Miss Martineau selected as their favourite poem "Lady Geraldine's Courtship," a violent piece of work. In the beginning of the following year came the letter from a stranger that was to be so momentous to both. "I had a letter from Browning the poet last night," she writes to her old friend Mrs Martin, "which threw me into ecstasies—Browning, the author of *Paracelsus*, the king of the mystics." She is flattered, though not to "ecstasies," at about the same time by a letter from E. A. Poe, and by the dedication to her, as "the noblest of her sex," of his own work. "What is to be said, I wonder, when a man calls you the 'noblest of your sex'?" "Sir, you are the most discerning of yours." America was at least as quick as England to appreciate her poetry; among other messages thence came in the spring letters from Lowell and from Mrs Sigourney. "She says that the sound of my poetry is stirring the 'deep green forests of the New World'; which sounds pleasantly, does it not?" It is in the same year that the letters first speak of the hope of a journey to Italy. The winters in London, with the imprisonment which—according to the medical practice of that day—they entailed, were lowering Elizabeth's strength of resistance against disease. She longed for the change of light, scene, manners and language, and the longing became a hope, until her father's prohibition put an end to it, and doomed her, as she and others thought, to death, without any perceptible reason for the denial of so reasonable a desire.

Meanwhile the friendship with Browning had become the chief thing in Elizabeth Barrett's life. The correspondence, once begun, had not flagged. In the early summer they met. The allusion to his poetry in "Lady Geraldine's Courtship" had doubtless put an edge to his already keen wish to know her. He became her frequent visitor and kept her room fragrant with flowers. He never lagged, whether in friendship or in love. We have the strange privilege, since the publication of the letters between the two, of following the whole course of this noble love-story from beginning to end, and day by day. Browning was six years younger than the woman he so passionately admired, and he at first believed her to be confined by some hopeless physical injury to her sofa. But of his own wish and resolution he never doubted. Her hesitation, in her regard for his liberty and strength, to burden his with an ailing wife, she has recorded in the Sonnets after-

wards published under a slight disguise as *Sonnets from the Portuguese*. She refused him once "with all her will, but much against her heart," and yielded at last for his sake rather than her own. Her father's will was that his children should not marry, and, kind and affectionate father though he was, the prohibition took a violent form and struck terror into the hearts of the three dutiful and sensitive girls. Robert Browning's addresses were, therefore, kept secret, for fear of scenes of anger which the most fragile of the three could not face. Browning was reluctant to practise the deception; Elizabeth alone knew how impossible it was to avoid it. When she was persuaded to marry, it was she who insisted, in mental and physical terror, upon a secret wedding. Throughout the summer of 1846 her health improved, and on the 12th of September the two poets were married in St Marylebone parish church. Browning visited it on his subsequent journeys to England to give thanks for what had taken place at its altar. Elizabeth's two sisters had been permitted to know of the engagement, but not of the wedding, so that their father's anger might not fall on them too heavily. For a week Mrs Browning remained in her father's house. On the 19th of September she left it, taking her maid and her little dog, joined her husband, and crossed to the Continent. She never entered that home again, nor did her father ever forgive her. Her letters, written with tears to entreat his pardon, were never answered. They were all subsequently returned to her unopened. Among them was one she had written, in the prospect of danger, before the birth of her child. With her sisters her relations were, as before, most affectionate. Her brothers, one at least of whom disapproved of her action, held for a time aloof. All others were taken entirely by surprise. Mrs Jameson, who had been one of the few intimate visitors to Miss Barrett's room, had offered to take her to Italy that year, but met her instead on her way thither with a newly-married husband. The poets' journey was full of delight. Where she could not walk, up long staircases or across the waters of the stream at Vaucluse, Browning carried her. In October they reached Pisa, and there they wintered, Mrs Jameson keeping them company for a time lest ignorance of practical things should bring them, in their poverty, to trouble. She soon found that they were both admirable economists; not that they gave time and thought to husbandry, but that they knew how to enjoy life without luxuries. So they remained to the end, frugal and content with little.

For climate and cheapness they settled in Italy, choosing Florence in the spring of 1847, and remaining there, with the interruptions of a change to places in Italy such as Siena and Rome, and to Paris and England, until Mrs Browning's death. It was at Pisa that Robert Browning first saw the *Sonnets from the Portuguese*, poems which his wife had written in secret and had no thought of publishing. He, however, resolved to give them to the world. "I dared not," he said, "reserve to myself the finest sonnets written in any language since Shakespeare's." The judgment, which the existence of Wordsworth's sonnets renders obviously absurd, may be pardoned. The sonnets were sent to Miss Mitford and published at Reading, as *Sonnets by E. B. B.*, in 1847. In 1850 they were included, under their final title, in a new issue of poems. During the Pisan autumn appeared in *Blackwood's Magazine* seven poems by Mrs Browning which she had sent some time before, and the publication of which at that moment disturbed her as likely to hurt her father by an apparent reference to her own story. At Pisa also she wrote and sent to America a poem, "The Runaway Slave at Pilgrim Point," which was published in Boston, in *The Liberty Bell*, in 1848, and separately in England in 1849. In the summer of 1847 the Brownings left their temporary dwelling in Florence and took the apartment in Casa Guidi, near the Pitti Palace, which was thenceforth their chief home. Early in their residence began that excited interest in Italian affairs which made so great a part of Mrs Browning's emotional life. The Florentines, under the government of the grand duke, were prosperous but disturbed by national aspirations. Mrs Browning, by degrees, wrote *Casa Guidi Windows* on their behalf and as an appeal to the always impulsive sympathies of England. In 1849 was born

the Brownings' only child, their beloved son Robert Wiedemann Barrett. After this event Mrs Browning resumed her literary activities, preparing a new issue, with some additions, of her poems (1850). A poem on the death of a friend's child appeared in the *Athenaeum* (1849), and there the new volumes were warmly praised. *Casa Guidi's Windows* followed in 1851. Visiting England in that year, the Brownings saw much of the Proctors, and something of Florence Nightingale, Kingsley, Ruskin, Rogers, Patmore and Tennyson, and also of Carlyle, with whom they went to Paris, where they saw George Sand, and where they passed the December days of the *coup d'état*. Mrs Browning happened to take a political fancy to Napoleon III., whom she would probably have denounced if a title of his tyrannies had occurred in Italy, and the fancy became more emotional in after years.

A new edition of Mrs Browning's poems was called for in 1853, and at about this time, in Florence, she began to work on *Aurora Leigh*. She was still writing this poem when the Brownings were again in England, in 1855. Tennyson there read to them his newly-written *Maud*. After another interval in Paris they were in London again—Mrs Browning for the last time. She was with her dear cousin Kenyon during the last months of his life. In October 1856 the Brownings returned to their Florentine home, Mrs Browning leaving her completed *Aurora Leigh* for publication. The book had an immediate success; a second edition was required in a fortnight, a third a few months later. In the fourth edition (1859) several corrections were made. The review in *Blackwood* was written by W. E. Aytoun, that in the *North British* by Coventry Patmore.

In 1857 Mrs Browning addressed a petition, in the form of a letter, to the emperor Napoleon begging him to remit the sentence of exile upon Victor Hugo. We do not hear of any reply. In 1857 Mrs Browning's father died, unreconciled. Henrietta Barrett had married, like her sister, and like her was unforgiven. In 1858 occurred another visit to Paris, and another to Rome, where Hawthorne and his family were among the Brownings' friends. In 1859 came the Italian war in which Mrs Browning's hasty sympathies were hotly engaged. Her admiration of Italy's champion, Napoleon III., knew no bounds, and did not give way when, by the peace of Villafranca, Venice and Rome were left unannexed to the kingdom of Italy, and the French frontiers were "rectified" by the withdrawal from that kingdom of Savoy and Nice. That peace, however, was a bitter disappointment, and her fragile health suffered. At Siena and Florence this year the Brownings were very kind to Landor, old, solitary, and ill. Mrs Browning's poem, "A Tale of Villafranca," was published in the *Athenaeum* in September, and afterwards included in *Poems before Congress* (1860). Then followed another long visit to Rome, and there Mrs Browning prepared for the press this, her last volume. The little book was judged with some impatience, *A Curse for a Nation* being mistaken for a denunciation of England, whereas it was aimed at America and her slavery. The *Athenaeum*, amongst others, committed this error. The *Saturday Review* was hard on the volume, so was *Blackwood*; the *Atlas* and *Daily News* favourable. In July 1860 was published "A Musical Instrument," in the young *Cornhill Magazine*, edited by the author's friend W. M. Thackeray. The last blow she had to endure was the death of her sister Henrietta, in the same year.

On the 30th of June 1861 Elizabeth Barrett Browning died. Her husband, who tended her alone on the night of her decease, wrote to Miss Blagden: "Then came what my heart will keep till I see her again and longer—the most perfect expression of her love to me within my whole knowledge of her. . . Always smilingly, happily, and with a face like a girl's, and in a few minutes she died in my arms, her head on my cheek. . . There was no lingering, nor acute pain, nor consciousness of separation, but God took her to himself as you would lift a sleeping child from a dark uneasy bed into your arms and the light. Thank God." Her married life had been supremely happy. Something has been said of the difference between husband and wife in regard to "spiritualism," in which Mrs Browning had interest and faith, but no division ever interrupted their entirely perfect affection

and happiness. Of her husband's love for her she wrote at the time of her marriage, "He preferred . . . of free and deliberate choice, to be allowed to sit only an hour a day by my side, to the fulfilment of the brightest dream which should exclude me in any possible world." "I am still doubtful whether all the brightness can be meant for me. It is just as if the sun rose again at 7 o'clock P.M." "I take it for pure magic, this life of mine. Surely nobody was ever so happy before." "I must say to you [Mrs Jameson] who saw the beginning with us, that this end of fifteen months is just fifteen times better and brighter; the mystical 'moon' growing larger and larger till scarcely room is left for any stars at all: the only differences which have touched me being the more and more happiness." Browning buried his wife in Florence, under a tomb designed by their friend Frederick Leighton. On the wall of Casa Guidi is placed the inscription: "Qui scrisse e morì Elisabetta Barrett Browning, che in cuore di donna conciliava scienza di dotto e spirito di poeta, e face del suo verso aureo anello fra Italia e Inghilterra. . . . Pome questa lapide Firenze grata 1861." In 1866 Robert Browning published a volume of selections from his wife's works.

The place of Elizabeth Barrett Browning in English literature is high, if not upon the summits. She had an original genius, a fervent heart, and an intellect that was, if not great, exceedingly active. She seldom has composure or repose, but it is not true that her poetry is purely emotional. It is full of abundant, and even over-abundant, thoughts. It is intellectually restless. The impassioned peace of the greatest poetry, such as Wordsworth's, is not hers. Nor did she apparently seek to attain those heights. Her Greek training taught her little of the economy that such a poetic education is held to impose; she "dashed" not by reason of feminine weakness, but as it were to prove her possession of masculine strength. Her gentler work, as in the *Sonnets from the Portuguese*, is beyond praise. There is in her poetic personality a glory of righteousness, of spirituality, and of ardour that makes her name a splendid one in the history of an incomparable literature.

See the *Letters of Elizabeth Barrett Browning addressed to R. H. Horns*, with *Comments on Contemporaries*, edited by S. R. Townshend Mayer (2 vols., 1877); *The Poetical Works of Elizabeth Barrett Browning from 1826 to 1844*, edited with memoir by J. H. Ingram (1887); *Elizabeth Barrett Browning* (Eminent Women series), by J. H. Ingram, 1888; *Records of Tennyson, Ruskin and the Brownings*, by Anne Ritchie (1892); *The Letters of Elizabeth Barrett Browning*, edited with biographical additions by Frederick G. Kenyon (2 vols., 1897); *The Letters of Robert Browning and Elizabeth Barrett Barrett* (2 vols., 1899); *La Vie et l'œuvre d'Elizabeth Browning*, by Mlle. Germaine-Marie Merlette (Paris, 1906). (A. M.)

BROWNING, OSCAR (1837—), English writer, was born in London on the 17th of January 1837, the son of a merchant, William Shipton Browning. He was educated at Eton and at King's College, Cambridge, of which he became fellow and tutor, graduating fourth in the classical tripos of 1860. He was for fifteen years a master at Eton College, resuming residence in 1876 at Cambridge, where he became university lecturer in history. He soon became a prominent figure in college and university life, encouraging especially the study of political science and modern political history, the extension of university teaching and the movement for the training of teachers. He is well known to Dante students by his *Dante; Life and Works* (1891), and to the study of Italian history he has contributed *Guelphs and Ghibellines* (1903). His works on modern history include *England and Napoleon in 1805* (1887), *History of England* (4 vols., 1890), *Wars of the Nineteenth Century* (1899), *History of Europe 1814-1815* (1901), *Napoleon, the first Phase* (1905).

BROWNING, ROBERT (1812-1886), English poet, was born at Camberwell, London, on the 7th of May 1812. He was the son of Robert Browning (1781-1866), who for fifty years was employed in the Bank of England. Earlier Brownings had been settled in Wiltshire and Dorsetshire, and there is no ground for the statement that the family was partly of Jewish origin. The poet's mother was a daughter of William Wiedemann, a German who had settled in Dundee and married a Scottish wife. His parents had one other child, a daughter, Sarianna, born in 1814. They lived quietly in Camberwell. The elder Brownings

had a sufficient income and was indifferent to money-making. He had strong literary and artistic tastes. He was an ardent book collector, and so good a draughtsman that paternal authority alone had prevented him from adopting an artistic career. He had, like his son, a singular faculty for versifying, and helped the boy's early lessons by twisting the Latin grammar into grotesque rhymes. He lived, as his father had done, to be 84, with unbroken health. The younger Robert inherited, along with other characteristics, much of his father's vigour of constitution. From the mother, who had delicate health, he probably derived his excessive nervous irritability; and from her, too, came his passion for music. The family was united by the strongest mutual affection, and the parents erred, if anything, on the side of indulgence. Browning was sent to a school in the neighbourhood, but left it when fourteen, and had little other teaching. He had a French tutor for the next two years, and in his eighteenth year he attended some Greek lectures at the London University. At school he never won a prize, though it was more difficult to avoid than to win prizes. He was more conspicuous for the love of birds and beasts, which he always retained, than for any interest in his lessons. He rather despised his companions and made few friends. A precocious poetical capacity, however, showed itself in extra-scholastic ways. He made his schoolfellows act plays, partly written by himself. He had composed verses before he could write, and when twelve years old completed a volume of poems called *Inconclita*. His parents tried unsuccessfully to find a publisher; but his verses were admired by Sarah Flower, afterwards Mrs Adams, a well-known hymn-writer of the day, and by W. J. Fox, both of whom became valuable friends. A copy made by Miss Flower was in existence in 1871, but afterwards destroyed by the author. Browning had the run of his father's library, and acquired a very unusual amount of miscellaneous reading. Quarles' *Emblems* was an especial favourite; and besides the Elizabethan dramatists and standard English books, he had read all the works of Voltaire. Byron was his first master in poetry, but about the age of fourteen he fell in accidentally with Shelley and Keats. For Shelley in particular he conceived an enthusiastic admiration which lasted for many years, though it was qualified in his later life.

The more aggressive side of Browning's character was as yet the most prominent; and a self-willed lad, conscious of a growing ability, found himself cramped in Camberwell circles. He rejected the ordinary careers. He declined the offer of a clerkship in the Bank of England; and his father, who had found the occupation ungenial, not only approved the refusal but cordially accepted the son's decision to take poetry for his profession. For good or evil, Browning had been left very much to his own guidance, and if his intellectual training suffered in some directions, the liberty permitted the development of his marked originality. The parental yoke, however, was too light to provoke rebellion. Browning's mental growth led to no violent breach with the creeds of his childhood. His parents became Dissenters in middle life, but often attended Anglican services; and Browning, though he abandoned the dogmas, continued to sympathize with the spirit of their creed. He never took a keen interest in the politics of the day, but cordially accepted the general position of contemporary Liberalism. His worship of Shelley did not mean an acceptance of his master's hostile attitude towards Christianity, still less did he revolt against the moral discipline under which he had been educated. He frequented literary and artistic circles, and was passionately fond of the theatre; but he was entirely free from a coarse Bohemianism, and never went to bed, we are told, without kissing his mother. He lived with his parents until his marriage. His mother lived till 1849, and his father till 1866, and his affectionate relations to both remained unaltered. Browning's first published poem, *Pauline*, appeared anonymously in 1833. He always regarded it as crude, and destroyed all the copies of this edition that came within his reach. It was only to avoid unauthorized reprints that he consented with reluctance to republishing it in the collected works of 1868. The indication of genius was recognized by W. J. Fox, who hailed it in the *Monthly Repository* as

marking the advent of a true poet. *Pauline* contains an enthusiastic invocation of Shelley, whose influence upon its style and conception is strongly marked. It is the only one of Browning's works which can be regarded as imitative. In the winter of 1833 he went to St Petersburg on a visit to the Russian consul-general, Mr Benckhausen. There he wrote the earliest of his dramatic lyrics, "Porphyria's Lover" and "Johannes Agricola." In the spring of 1834 he visited Italy for the first time, going to Venice and Asolo.

Browning's personality was fully revealed in his next considerable poems, *Paracelsus* (1835) and *Sordello* (1840). With *Pauline*, however, they form a group. In an essay (prefixed to the spurious Shelley letters of 1851), Browning describes Shelley's poetry "as a sublime fragmentary essay towards a presentment of the correspondency of the universe to Deity." The phrase describes his own view of the true functions of a poet, and Browning, having accepted the vocation, was meditating the qualifications which should fit him for his task. The hero of *Pauline* is in a morbid state of mind which endangers his fidelity to his duty. *Paracelsus* and *Sordello* are studies in the psychology of genius, illustrating its besetting temptations. *Paracelsus* fails from intellectual pride, not balanced by love of his kind, and from excessive ambition, which leads him to seek success by unworthy means. *Sordello* is a poet distracted between the demands of a dreamy imagination and the desire to utter the thoughts of mankind. He finally gives up poetry for practical politics, and gets into perplexities only to be solved by his death. *Pauline* might in some indefinite degree reflect Browning's own feelings, but in the later poems he adopts his characteristic method of speaking in a quasi-dramatic mood. They are, as he gave notice, "poems, not dramas." The interest is not in the external events, but in the "development of a soul"; but they are observations of other men's souls, not direct revelations of his own. *Paracelsus* was based upon a study of the original narrative, and *Sordello* was a historical though a very indefinite person. The background of history is intentionally vague in both cases. There is one remarkable difference between them. The *Paracelsus*, though full of noble passages, is certainly diffuse. Browning heard that John Sterling had complained of its "verbosity," and tried to remedy this failing by the surgical expedient of cutting out the usual connecting words. Relative pronouns henceforth become scarce in his poetry, and the grammatical construction often a matter of conjecture. Words are forcibly jammed together instead of being articulately combined. To the ordinary reader many passages in his later work are both crabbéd and obscure, but the "obscurity" never afterwards reached the pitch of *Sordello*. It is due to the vagueness with which the story is rather hinted than told, as well as to the subtlety and intricacy of the psychological expositions. The subtlety and vigour of the thought are indeed surprising, and may justify the frequent comparisons to Shakespeare; and it abounds in descriptive passages of genuine poetry.

Still, Browning seems to have been misled by a fallacy. It was quite legitimate to subordinate the external incidents to the psychological development in which he was really interested, but to secure the subordination by making the incidents barely intelligible was not a logical consequence. We should not understand Hamlet's psychological peculiarities the better if we had to infer his family troubles from indirect hints. Browning gave more time to *Sordello* than to any other work, and perhaps had become so familiar with the story which he professed to tell that he failed to make allowance for his readers' difficulties. In any case it was not surprising that the ordinary reader should be puzzled and repelled, and the general recognition of his genius long delayed, by his reputation for obscurity. It might, however, be expected that he would make a more successful appeal to the public by purely dramatic work, in which he would have to limit his psychological speculation and to place his characters in plain situations. *Paracelsus* and *Sordello* show so great a power of reading character and appreciating subtler springs of conduct that its author clearly had one, at least, of the essential qualifications of a dramatist.

Before *Sordello* appeared Browning had tried his hand in this direction. He was encouraged by outward circumstances as well as by his natural bent. He was making friends and gaining some real appreciative admirers. John Forster had been greatly impressed by *Paracelsus*. Browning's love of the theatre had led to an introduction to Macready in the winter of 1835-1836; and Macready, who had been also impressed by *Paracelsus*, asked him for a play. Browning consented and wrote *Strafford*, which was produced at Covent Garden in May 1837, Macready taking the principal part. Later dramas were *King Victor and King Charles*, published in 1842; *The Return of the Druses* and *A Blot on the 'Scutcheon* (both in 1843), *Colombe's Birthday* (1844), *Luria* and *A Soul's Tragedy* (both in 1846), and the fragmentary *In a Balcony* (1853). *Strafford* succeeded fairly, though the defection of Vandenhoff, who took the part of Pym, stopped its run after the fifth performance. *The Blot on the 'Scutcheon*, produced by Macready as manager of Drury Lane on the 11th of February 1843, led to an unfortunate quarrel. Browning thought that Macready had felt unworthy jealousy of another actor, and had gratified his spite by an inadequate presentation of the play. He remonstrated indignantly and the friendship was broken off for years. Browning was disgusted by his experience of the annoyances of practical play-writing, though he was not altogether discouraged. The play had apparently such a moderate success as was possible under the conditions, and a similar modest result was attained by *Colombe's Birthday*, produced at Covent Garden on the 25th of April 1853. Browning, like other eminent writers of the day, failed to achieve the feat of attracting the British public by dramas of high literary aims, and soon gave up the attempt. It has been said by competent critics that some of the plays could be fitted for the stage by judicious adaptation. *The Blot on the 'Scutcheon* has a very clear and forcibly treated situation; and all the plays abound in passages of high poetic power. Like the poems, they deal with situations involving a moral probation of the characters, and often suggesting the ethical problems which always interested him. The speeches tend to become elaborate analyses of motive by the persons concerned, and try the patience of an average audience. For whatever reason, Browning, though he had given sufficient proofs of genius, had not found in these works the most appropriate mode of utterance.

The dramas, after *Strafford*, formed the greatest part of a series of pamphlets called *Bells and Pomegranates*, eight of which were issued from 1841 to 1846. The name, he explained, was intended to indicate an "alternation of poetry and thought." The first number contained the fanciful and characteristic *Pippa Passes*. The seventh, significantly named *Dramatic Romances and Lyrics*, contained some of his most striking shorter poems. In 1844 he contributed six poems, among which were "The Flight of the Duchess" and "The Bishop orders his Tomb at St Praxed's Church," to Hood's *Magazine*, in order to help Hood, then in his last illness. These poems take the special form in which Browning is unrivalled. He wrote very few lyrical poems of the ordinary kind purporting to give a direct expression of his own personal emotions. But, in the lyric which gives the essential sentiment of some impressive dramatic situation, he has rarely been approached. There is scarcely one of the poems published at this time which can be read without fixing itself at once in the memory as a forcible and pungent presentation of a characteristic mood. Their vigour and originality failed to overcome at once the presumption against the author of *Sordello*. Yet Browning was already known to and appreciated by such literary celebrities of the day as Talfourd, Leigh Hunt, Procter, Monckton Milnes, Carlyle and Landor. His fame began to spread among sympathetic readers. The *Bells and Pomegranates* attracted the rising school of "pre-Raphaelites," especially D. G. Rossetti, who guessed the authorship of the anonymous *Pauline* and made a transcript from the copy in the British Museum. But his audience was still select.

Another recognition of his genius was of incomparably more personal importance and vitally affected his history. In 1844 Miss Barrett (see BROWNING, ELIZABETH BARRETT) published

a volume of poems containing "Lady Geraldine's Courtship," with a striking phrase about Browning's poems. He was naturally gratified, and her special friend and cousin, John Kenyon, encouraged him to write to her. She admitted him to a personal interview after a little diffidence, and a hearty appreciation of literary genius on both sides was speedily ripened into genuine and most devoted love. Miss Barrett was six years older than Browning and a confirmed invalid with shaken nerves. She was tenderly attached to an autocratic father who objected on principle to the marriage of his children. The correspondence of the lovers (published in 1899) shows not only their mutual devotion, but the chivalrous delicacy with which Browning behaved in a most trying situation. Miss Barrett was gradually encouraged to disobey the utterly unreasonable despotism. They made a clandestine marriage on the 12th of September 1846. The state of Miss Barrett's health suggested misgivings which made Browning's parents as well as his bride's disapprove of the match. She, however, appears to have become stronger for some time, though always fragile and incapable of much active exertion. She had already been recommended to pass a winter in Italy. Browning had made three previous tours there, and his impressions had been turned to account in *Sordello* and *Pippa Passes*, in *The Englishman in Italy* and *Home Thoughts from Abroad*. For the next fifteen years the Brownings lived mainly in Italy, making their headquarters at Florence in the Casa Guidi. A couple of winters were passed in Rome. In the summer of 1849 they were at Siena, where Browning was helpful to Landor, then in his last domestic troubles. They also visited England and twice spent some months in Paris. Their only child, Robert Wiedemann Browning, was born at Florence in 1849. Browning's literary activity during his marriage seems to have been comparatively small; *Christmas Eve and Easter Day* appeared in 1850, while the two volumes called *Men and Women* (1855), containing some of his best work, showed that his power was still growing. His position involved some sacrifice and imposed limitations upon his energies. Mrs Browning's health required a secluded life; and Browning, it is said, never dined out during his marriage, though he enjoyed society and made many and very warm friendships. Among their Florence friends were Margaret Fuller Ossoli, Isa Blagden, Charles Lever and others. The only breach of complete sympathy with his wife was due to his contempt for "spiritualists" and "mediums," in whom she fully believed. His portrait of Daniel Dunglas Home as "Sludge the Medium" only appeared after her death. This domestic happiness, however, remained essentially unbroken until she died on 30th June 1861. The whole love-story had revealed the singular nobility of his character, and, though crushed for a time by the blow, he bore it manfully. Browning determined to return to England and superintend his boy's education at home. He took a house at 19 Warwick Crescent, Paddington, and became gradually acclimatized in London. He resumed his work and published the *Dramatis Personae* in 1864. The publication was well enough received to mark the growing recognition of his genius, which was confirmed by *The Ring and the Book*, published in four volumes in the winter of 1868-1869. In 1867 the university of Oxford gave him the degree of M.A. "by diploma," and Balliol College elected him as an honorary fellow. In 1868 he declined a virtual offer of the rectorship of St Andrews. He repeated the refusal on a later occasion (1884) from a dislike to the delivery of a public address. The rising generation was now beginning to buy his books, and he shared the homage of thoughtful readers with Tennyson, though in general popularity he could not approach his friendly rival. *The Ring and the Book* has been generally accepted as Browning's masterpiece. It was based on a copy of the *proci verbal* of Guido Franceschini's case discovered by him at Florence.

The audacity of the scheme is surprising. To tell the story of a hideous murder twelve times over, to verify the arguments of counsel and the gossip of quidnuncs, and to insist upon every detail with the minuteness of a law report, could have occurred to no one else. The poem is so far at the opposite pole from *Sordello*. Vagueness of environment is replaced by a photographic

distinctness, though the psychological interest is dominant in both. Particular phrases may be crabbed, but nothing can be more distinct and vivid in thought and conception. If some of those "dramatic monologues" of which the book is formed fail to be poetry at all, some of them—that of Pompilia the victim, her champion Caponsacchi, and the pope who gives judgment—are in Browning's highest mood, and are as impressive from the ethical as from the poetical point of view. Pompilia was no doubt in some respects an idealized portrait of Mrs Browning. Other pieces may be accepted as a background of commonplace to throw the heroic into the stronger relief. *The Ring and the Book* is as powerful as its method is unique.

Browning became gentler and more urbane as he grew older. His growing fame made him welcome in all cultivated circles, and he accepted the homage of his admirers with dignity and simplicity. He exerted himself to be agreeable in private society, though his nervousness made him invariably decline ever to make public speeches. He was an admirable talker, and took pains to talk his best. A strong memory supplied him with abundant anecdotes; and though occasionally pugnacious, he allowed a fair share of the conversation to his companions. Superficial observers sometimes fancied that the poet was too much sunk in the man of the world; but the appearance was due to his characteristic reluctance to lay bare his deeper feelings. When due occasion offered, the underlying tenderness of his affections was abundantly manifest. No one could show more delicate sympathy. He made many warm personal friendships in his later years, especially with women, to whom he could most easily confide his feelings. In the early years of this period he paid visits to country houses, but afterwards preferred to retire farther from the London atmosphere into secluded regions. He passed some holidays in remote French villages, Pornic, Le Croisic and St Aubyn, which have left traces in his poetry. *Gold Hair* is a legend of Pornic, and *Herb Riel* was written at Le Croisic. At St Aubyn he had the society of Joseph Milsand, who had shown his warm appreciation of Browning's poetry by an article in the *Revue des Deux Mondes*, which in 1852 had led to a personal friendship lasting till Milsand's death in 1886. Browning sent to him the proof-sheets of all his later works for revision. In 1877 Browning was at La Saixiaz on the Salève, near Geneva, where an old friend, Miss Egerton Smith, was staying. She died suddenly almost in his presence. She had constantly accompanied him to concerts during his London life. After her death he almost ceased to care for music. The shock of her loss produced the singular poem called *La Saixiaz*, in which he argues the problem of personal immortality with a rather indefinite conclusion. In later years Browning returned to Italy, and passed several autumns at Venice. He never visited Florence after his wife's death there.

Browning's literary activity continued till almost the end of his life. He wrote constantly, though he composed more slowly. He considered twenty-five or thirty lines to be a good day's work. His later writings covered a very great variety of subjects, and were cast in many different forms. They show the old characteristics and often the old genius. Browning's marked peculiarity, the union of great speculative acuteness with intense poetical insight, involved difficulties which he did not always surmount. He does not seem to know whether he is writing poetry or when he is versifying logic; and when the speculative impulse gets the upper hand, his work suggests the doubt whether an imaginary dialogue in prose would not have been a more effective medium. He is analysing at length when he ought to be presenting a concrete type, while the necessities of verse complicate and obscure the reasoning. A curious example is the *Prince Hohenstiel-Schwangou* (1871), an *alias* for Louis Napoleon. The attempt to show how a questionable hero apologizes to himself recalls the very powerful "Bishop Blougram," and "Studge, the medium," of earlier works, but becomes prolix and obscure. *Fifine at the Fair* (1872) is another curious speculation containing a defence of versatility in love-making by an imaginary Don Juan. Its occasionally cynical tone rather scandalized admirers, who scarcely made due

allowance for its dramatic character. Browning's profound appreciation of high moral qualities is, however, always one main source of his power. In later years he became especially interested in stories of real life, which show character passing through some sharp ordeal. *The Red Cotton Nightcap Country* (1873), describing a strange tragedy which had recently taken place in France, and especially *The Inn Album* (1875), founded on an event in modern English society, are powerful applications of the methods already exemplified in *The Ring and the Book*. The *Dramatic Idylls* (1879 and 1880) are a collection of direct narratives, with less analytical disquisition, which surprised his readers by their sustained vigour. In the last volumes, *Jocoseria* (1883), *Ferishtak's Fancies* (1884), *Parleyings with Certain People* (1887) and *Asolando* (1889), the old power is still apparent but the hand is beginning to fail. They contain discussions of metaphysical problems, such as the origin of evil, which are interesting as indications of his creed, but can scarcely be regarded as successful either poetically or philosophically.

Another group of poems showed Browning's interest in Greek literature. *Balouston's Adventure* (1871) includes a "transcript from Euripides," a translation, that is, of part of the *Alcestis*. *Aristophanes' Apology* (1875) included another translation from the *Heracles*, and in 1877 he published a very literal translation of the *Agamemnon*. This, it seems, was meant to disprove the doctrine that Æschylus was a model of literary style. Browning shared his wife's admiration for Euripides, and takes a phrase from one of her poems as a motto for *Balouston's Adventure*. In the *Aristophanes' Apology* this leads characteristically to a long exposition by Aristophanes of his unsatisfactory reasons for ridiculing Euripides. It recalls the apologies of "Blougram" and Louis Napoleon, and contains some interesting indications of his poetical theory. Browning was to many readers as much prophet as poet. His religious position is most explicitly, though still not very clearly, set forth in the *Christmas Eve and Easter Day* (1850). Like many eminent contemporaries, he combined a disbelief in orthodox dogma with a profound conviction of the importance to the religious instincts of the symbols incorporated in accepted creeds. *Soul* (1845), *A Death in the Desert* (1864), and similar poems, show his strong sympathy with the spirit of the old belief, though his argumentative works have a more or less sceptical turn. It was scarcely possible, if desirable, to be original on such topics. His admirers hold that he shows an affinity to German metaphysicians, though he had never read their works nor made any express study of metaphysical questions. His distinctive tendency is to be found rather in the doctrine of life and conduct which both suggests and is illustrated by his psychological analyses. A very characteristic thought emphatically set forth in the *Rabbi Ben Esra* (1864) and the *Grammarian's Funeral* (1855) is that a man's value is to be measured, not by the work done, but by the character which has been moulded. He delights in exhibiting the high moral instinct which dares to override ordinary convictions, or which is content with discharge of obscure duties, or superior to vulgar ambition and capable of self-sacrifice, because founded upon pure love and sympathy for human suffering. Browning's limitations are characteristic of the poetry of strong ethical preoccupations. His strong idiosyncrasy, his sympathy with the heroic and hatred of the base, was hardly to be combined with the Shakespearian capacity for sympathizing with the most varied types of character. Though he deals with a great variety of motive with singularly keen analysis, he takes almost exclusively the moral point of view. That point of view, however, has its importance, and his morality is often embodied in poetry of surpassing force. Browning's love of the grotesque, sometimes even of the horrible, creates many most graphic and indelible portraits. The absence of an exquisite sense for the right word is compensated by the singular power of striking the most brilliant flashes out of obviously wrong words, and forcing comic rhymes to express the deepest and most serious thoughts. Though he professed to care little for motive as apart from human interest, his incidental touches of description are unsurpassably vivid.

The appreciation of Browning's genius became general in his later years, and zeal was perhaps a little heightened by the complacency of disciples able to penetrate a supposed mist of obscurity. The Browning Society, founded in 1881 by Dr F. J. Furnivall and Miss E. H. Hickey, was a product of this appreciation, and helped to extend the study of the poems. Browning accepted the homage in a simple and friendly way, though he avoided any action which would make him responsible for the publications. He received various honours: LL.D. degree from Cambridge in 1879, the D.C.L. from Oxford in 1882, and LL.D. from Edinburgh in 1884. He became foreign correspondent to the Royal Academy in 1886. His son, who had settled at Venice, married in 1887, and Browning moved to De Vere Gardens. In the autumn of 1889 he went with his sister to visit his son, and stayed on the way at Asolo, which he had first seen in 1838, when it supplied the scenery of *Pippa Passes*. He was charmed with the place, and proposed to buy a piece of ground and to build upon it a house to be called "Pippa's Tower"—in memory of his early heroine. While his proposal was under consideration he went to his son at Venice. His health had been breaking for some time, and a cold, aggravated by weakness of the heart, brought on a fatal attack. He died on the 12th of December 1889. He was buried in Westminster Abbey on 31st December. It was suggested that his wife's body should be removed from Florence to be placed beside him; but their son rightly decided that her grave should not be disturbed.

Browning's personal characteristics are so strongly stamped upon all his works that it is difficult to assign his place in contemporary thought. He is unique and outside of all schools. His style is so peculiar that he is the easiest of all poets to parody and the most dangerous to imitate. In spite of his early Shelley worship he is in certain respects more closely related to Wordsworth. Both of them started by accepting the poet's mission as quasi-prophetic or ethical. In other respects they are diametrically contrasted. Wordsworth expounded his philosophy by writing a poetical autobiography. Browning adheres to the dramatic method of which Wordsworth was utterly incapable. He often protested against the supposition that he put himself into his books. Yet there is no writer whose books seem to readers to be clearer revelations of himself. Nothing, in fact, is more characteristic of a man than his judgments of other men, and Browning's are keen and unequivocal. The revolutionary impulse had died out, and Browning has little to say either of the political questions which had moved Shelley and Byron, or of the social problems which have lately become more prominent. He represents the thought of a quieter epoch. He was little interested, too, in the historical or "romantic" aspect of life. He takes his subjects from a great variety of scenes and places—from ancient Greece, medieval Italy and modern France and England; but the interest for him is not in the picturesque surroundings, but in the human being who is to be found in all periods. Like Balzac, whom he always greatly admired, he is interested in the eternal tragedy and comedy of life. His problem is always to show what are the really noble elements which are eternally valuable in spite of failure to achieve tangible results. He gives, so far, another version of Wordsworth's doctrine of the cultivation of the "moral being." The psychological acuteness and the subtle analysis of character are, indeed, peculiar to himself. Like Carlyle, with whom he had certain points of affinity, he protests, though rather by implication than direct denunciation, against the utilitarian or materialistic view of life, and finds the divine element in the instincts which guide and animate every noble character. When he is really inspired by sympathy for such emotions he can make his most grotesque fancies and his most far-fetched analyses subservient to poetry of the highest order. It can hardly be denied that his intellectual ingenuity often tempts him to deviate from his true function, and that his observations are not to be excused because they result from an excess, instead of a deficiency, of intellectual acuteness. But the variety of his interests—æsthetic, philosophical and ethical—is astonishing,

and his successes are poems which stand out as unique and unsurpassable in the literature of his time.

The Life and Letters of Browning, by Mrs Sutherland Orr (1891), one of his most intimate friends in later years, and *The Last Letters of Robert Browning and Elizabeth Barrett Barrett, 1845-1846*, published by his son in 1899, are the main authorities. A collection of Browning's poems in 2 vols. appeared in 1849, another in 3 vols. in 1863, another in 6 vols. in 1868, and a revised edition in 16 vols. in 1888-1889; in 1896 Mr Augustine Birrell and Mr F. G. Kenyon edited a complete edition in 2 vols.; another two-volume edition was issued by Messrs Smith, Elder, in 1900. Among commentaries on Browning's works, Mrs Sutherland Orr's *Handbook to the Works of Browning* was approved by the poet himself. See also the *Browning Society's Papers*; and Mr T. J. Wise's *Materials for a Bibliography of the Writings of Robert Browning*, included in the *Literary Anecdotes of the Nineteenth Century* (1895), by W. Robertson Nicoll and T. J. Wise; Mr Edmund Gosse's *Robert Browning: Personalities* (1890), from notes supplied by Browning himself. Among biographical and critical authorities may be mentioned: J. T. Nettleship, *Essays* (1868); Arthur Symonds, *An Introduction to the Study of Browning* (1886); Stopford Brooke, *The Poetry of Robert Browning* (1902); G. K. Chesterton, *Browning* (1908) in the "English Men of Letters" series. (L. S.)

BROWN-SÉQUARD, CHARLES EDWARD (1817-1894), British physiologist and neurologist, was born at Port Louis, Mauritius, on the 8th of April 1817. His father was an American and his mother a Frenchwoman, but he himself always desired to be looked upon as a British subject, though in the restlessness of his life and the enthusiasm of his disposition, characteristics of his mother's nation were plainly visible. After graduating in medicine at Paris in 1846 he returned to Mauritius with the intention of practising there, but in 1852 he went to America. Subsequently he returned to Paris, and in 1859 he migrated to London, becoming physician to the national hospital for the paralysed and epileptic. There he stayed for about five years, expounding his views on the pathology of the nervous system in numerous lectures which attracted considerable attention. In 1864 he again crossed the Atlantic, and was appointed professor of physiology and neuro-pathology at Harvard. This position he relinquished in 1867, and in 1869 became professor at the Ecole de Médecine in Paris, but in 1873 he again returned to America and began to practise in New York. Finally, he went back to Paris to succeed Claude Bernard in 1878 as professor of experimental medicine in the Collège de France, and he remained there till his death, which occurred on the 2nd of April 1894 at Sceaux. Brown-Séquard was a keen observer and experimentalist. He contributed largely to our knowledge of the blood and animal heat, as well as many facts of the highest importance on the nervous system. He was the first scientist to work out the physiology of the spinal cord, demonstrating that the decussation of the sensory fibres is in the cord itself. He also did valuable work on the internal secretion of organs, the results of which have been applied with the most satisfactory results in the treatment of myxoedema. Unfortunately in his extreme old age, he advocated the hypodermic injection of a fluid prepared from the testicles of sheep, as a means of prolonging human life. It was known, among scientists, derisively, as the Brown-Séquard Elixir. His researches, published in about 500 essays and papers, especially in the *Archives de Physiologie*, which he helped to found in 1868, cover a very wide range of physiological and pathological subjects.

BROWNSON, ORESTES AUGUSTUS (1803-1876), American theological, philosophical and sociological writer, was born in Stockbridge, Vermont, on the 16th of September 1803. Having spent some time in active religious, reformatory and political (Democratic) work in the interior of New York state, and at Walpole, New Hampshire, and Canton, Massachusetts, Brownsong removed in 1839 to Chelsea, Mass. He at once began to take an independent part in the movements then agitating New England, which between 1830 and 1850 was stirred by discussions pertaining to Unitarianism, transcendentalism, spiritualism, abolitionism and various schemes for communistic living. He was one of the founders, in New York, of the short-lived Workingman's party in 1828, and established the *Eastern Quarterly Review*, mainly written by himself, in 1838. This periodical was merged in the *U.S. Democratic Review* of New York in 1842.

In religion he first became a Prebysterian (1822); was a Universalist minister from 1826 to 1831, editing for some time the chief journal of this church, the *Gospel Advocate*; was an independent preacher at Ithaca, N.Y., in 1831; became a Unitarian minister in 1832, and in 1836 organized in Boston the Society for Christian Union and Progress, of which he was the pastor for seven years. In 1844 he became a Roman Catholic and so remained, though the question of the orthodoxy of his writings was at one time submitted by the pope to Cardinal Franzelin, who recommended Brownson, to little purpose, to express his views with more moderation. In his philosophy Brownson was a more or less independent follower of Comte for a short time, and of Victor Cousin, who, in his *Fragments philosophiques*, praised him; he may be said to have taught a modified intuitionism. In his schemes for social reform he was at first a student of Robert Owen, until his later views led him to accept Roman Catholicism. His first quarterly was followed, in 1844, by *Brownson's Quarterly Review* (first published in Boston and after 1855 in New York), in which he expressed his opinions on many themes until its suspension in 1864, and after its revival for a brief period in 1873-1875. Of his numerous publications in book form, the chief during his lifetime were *Charles Elwood, or the Infidel Converted* (1840, autobiographical), in which he strongly favoured the Roman Catholic Church; and *The American Republic: its Constitution, Tendencies and Destiny* (1865), in which he based government on ethics, declaring the national existence to be a moral and even a theocratic entity, not depending for validity upon the sovereignty of the people. Brownson died in Detroit, Michigan, on the 17th of April 1876.

After his death, his son, Henry F. Brownson, collected and published his various political, religious, philosophical, scientific and literary writings, in twenty octavo volumes (Detroit, 1883-1887), of which a condensed summary appeared in a single volume, also prepared by his son, entitled *Literary and Political Views* (New York, 1893). The son also published a biography in three volumes (Detroit, 1898-1900).

His daughter, Sarah M. Brownson (1839-1876), who married in 1873 William J. Tenney, was the author of several novels, and wrote a *Life of Demetrius Augustine Gallitzin, Prince and Priest* (1873).

BROWNSVILLE, a city and the county-seat of Cameron county, Texas, U.S.A., situated near the S. extremity of the state, on the Rio Grande river about 22 m. above its mouth, and opposite Matamoros, Mexico. Pop. (1890) 6134; (1900) 6305, including 2462 foreign-born and 18 negroes; (1910) 10,517. It is served by the St Louis, Brownsville & Mexico, and the Rio Grande railways, being connected by the former with Houston and Galveston and by the latter with Point Isabel on the Gulf coast. Its chief importance lies in its being the commercial and distributing centre for a rich and extensive agricultural region in southern Texas and northern Mexico, and an important market for rice, sugar-cane, fruit, vegetables and live-stock. It has a United States custom house, the Cameron county court house, a Roman Catholic cathedral, St Joseph's College (Roman Catholic), and the Incarnate Word Academy (Roman Catholic). Before the Mexican War there was a small Mexican settlement on the site of Brownsville. In March 1846 General Zachary Taylor erected fortifications here, and upon his withdrawal to Point Isabel, left a small garrison in command of Major Jacob Brown. The fort was assaulted by General Arista and shelled by batteries from the Mexican shore, and at last on the 20th of May was relieved by General Taylor, who in advancing to its aid had won the battles of Palo Alto (8th of May) and Resaca de la Palma (9th of May). The fort, originally named Fort Taylor, was renamed Fort Brown, by order of General Taylor, in memory of Major Brown, who was mortally wounded during the bombardment. In 1859 Brownsville was captured by a band of Mexican raiders under Juan Nepomuceno Cortina. During the Civil War, until its temporary occupation by Federal forces in 1863, and subsequent effective blockade, it was an active centre of operations of Confederate blockade runners. At Palmetto Ranch, near the battlefield of Palo Alto, took place (13th of May 1865), more than a month after General Lee's surrender, the last engagement between Federal and Confederate

troops in the Civil War. In Brownsville, on the night of the 13th of August 1906, certain persons unknown fired into houses and at citizens on the streets, killing one man and injuring two. Suspicion pointed to negro soldiers of Companies B, C and D of the 25th Infantry, stationed at Fort Brown, and as it appeared that the culprits were being shielded by their comrades by a "conspiracy of silence," President Roosevelt dismissed the 170 men of the three companies "without honor." Both in Congress and in the press a bitter attack was made on the president for his action. In 1907 the military reservation of Fort Brown was transferred to the Department of Agriculture. In March 1909 Congress provided for a commission of army officers to report as to the eligibility of members of the negro regiments for re-enlistment.

BRUAY, a town of northern France, in the department of Pas-de-Calais, on the Lawe, 19 m. N.N.W. of Arras by road. Pop. (1906) 16,169. The town is situated in a rich coal-mining district. Brewing is also a leading industry.

BRUCE, the name of an old Scottish family of Norman descent, taken from Bruis between Cherbourg and Vallonges. Variations of the name are Braose, Breaux and Brus. The first Robert de Brus, a follower of William the Conqueror, was rewarded by the gift of many manors, chiefly in Yorkshire, of which Skelton was the principal. His son, the second Robert, received from David I., his comrade at the court of Henry I., a grant of the lordship of Annandale. The fourth Robert married Isabel, natural daughter of William the Lion, and their son, the fifth Robert, married Isabel, second daughter of David, earl of Huntingdon, niece of the same Scottish king. The most famous member of the family is the eighth Robert, "the Bruce," who became king of Scotland in 1306. (See **ROBERT THE BRUCE**.)

BRUCE, ALEXANDER BALMAIN (1831-1899), Scottish divine, was born at Aberargie near Perth on the 31st of January 1831. His father suffered for his adherence to the Free Church at the Disruption in 1843, and removed to Edinburgh, where the son was educated, showing exceptional ability from the first. His early religious doubts, awakened especially by Strauss's *Life of Jesus*, made him throughout life sympathetic with those who underwent a similar stress. After serving as assistant first at Ancrum, then at Lochwinnoch, he was called to Cardross in Dumbartonshire in 1859, and to Broughty Ferry in 1868. There he published his first considerable exegetical work, the *Training of the Twelve*. In 1874 he delivered his Cunningham Lectures, afterwards published as *The Humiliation of Christ*, and in the following year was appointed to the chair of Apologetics and New Testament exegesis at the Free Church College, Glasgow. This post he held for twenty-four years. He was one of the first British New Testament students whose work was received with consideration by German scholars of repute. The character and work of Christ were, he held, the ultimate proof and the best defence of Christianity; and his tendency was to concentrate attention somewhat narrowly on the historic Jesus. In *The Kingdom of God* (1889), which first encountered serious hostile criticism in his own communion, he accounted for some of the differences between the first and third evangelists on the principle of accommodation—maintaining that Luke had altered both the text and the spirit of his sources to suit the needs of those for whom he wrote. It was held that these admissions were not consistent with the views of inspiration professed by the Free Church. When the case was tried, the assembly held that the charge of heresy was based on a misunderstanding, but that "by want of due care in his mode of statement he had given some ground for the painful impressions which had existed."

Bruce rendered signal service to his own communion in connexion with its service of praise. He was convener of the committee which issued the Free Church hymn book, and he threw into this work the same energy and catholicity of mind which marked the rest of his activities. He died on the 7th of August 1899, and was buried at Broughty Ferry. His chief works, beside the above, are: *The Chief End of Revelation* (Lond., 1881); *The Parabolic Teaching of Christ* (Lond., 1882); *F. C. Bow and his Theory of the Origin of Christianity and of the*

New Testament Writings in "Present Day Tracts" (Lond., 1885); Apologetics, or Christianity Defensively Stated (Edin., 1892); St Paul's Conception of Christianity (Lond., 1894); Expos. Gk. Test. (the Synoptic Gospels, Lond., 1897). With Open Face (Lond., 1896); The Epistle to the Hebrews (Edin., 1899); The Providential Order of the World, and the Moral Order of the World in Ancient and Modern Thought (Gifford Lectures, 1896-1897; Lond., 1897, 1899). (D. Mn.)

BRUCE, JAMES (1730-1794), Scottish explorer in Africa, was born at Kinnaird House, Stirlingshire, on the 14th of December 1730. He was educated at Harrow and Edinburgh University, and began to study for the bar; but his marriage to the daughter of a wine merchant resulted in his entering that business. His wife died in October 1754, within nine months of marriage, and Bruce thereafter travelled in Portugal and Spain. The examination of oriental MSS. at the Escorial led him to the study of Arabic and Gees and determined his future career. In 1758 his father's death placed him in possession of the estate of Kinnaird. On the outbreak of war with Spain in 1762 he submitted to the British government a plan for an attack on Ferrol. His suggestion was not adopted, but it led to his selection by the 2nd earl of Halifax for the post of British consul at Algiers, with a commission to study the ancient ruins in that country, in which interest had been excited by the descriptions sent home by Thomas Shaw¹ (1694-1751), consular chaplain at Algiers, 1719-1731. Having spent six months in Italy studying antiquities, Bruce reached Algiers in March 1763. The whole of his time was taken up with his consular duties at the piratical court of the dey, and he was kept without the assistance promised. But in August 1765, a successor in the consulate having arrived, Bruce began his exploration of the Roman ruins in Barbary. Having examined many ruins in eastern Algeria, he travelled by land from Tunis to Tripoli, and at Ptolemeta took passage for Candia; but was shipwrecked near Bengazi and had to swim ashore. He eventually reached Crete, and sailing thence to Sidon, travelled through Syria, visiting Palmyra and Baalbek. Throughout his journeyings in Barbary and the Levant, Bruce made careful drawings of the many ruins he examined. He also acquired a sufficient knowledge of medicine to enable him to pass in the East as a physician.

In June 1768 he arrived at Alexandria, having resolved to endeavour to discover the source of the Nile, which he believed to rise in Abyssinia. At Cairo he gained the support of the Mameluke ruler, Ali Bey; after visiting Thebes he crossed the desert to Kosseir, where he embarked in the dress of a Turkish sailor. He reached Jidda in May 1769, and after some stay in Arabia he recrossed the Red Sea and landed at Massawa, then in possession of the Turks, on the 19th of September. He reached Gondar, then the capital of Abyssinia, on the 14th of February 1770, where he was well received by the negus Tekla Haimanot II., by Ras Michael, the real ruler of the country, by the ras's wife, Ozoro Esther, and by the Abyssinians generally. His fine presence (he was 6 ft. 4 in. high), his knowledge of Gees, his excellence in sports, his courage, resource and self-esteem, all told in his favour among a people who were in general distrustful of all foreigners. He stayed in Abyssinia for two years, gaining knowledge which enabled him subsequently to present a perfect picture of Abyssinian life. On the 14th of November 1770 he reached the long-sought source of the Blue Nile. Though admitting that the White Nile was the larger stream, Bruce claimed that the Blue Nile was the Nile of the ancients and that he was thus the discoverer of its source. The claim, however, was not well founded (see NIXE: *Story of Exploration*). Setting out from Gondar in December 1771, Bruce made his way, in spite of enormous difficulties, by Sennar to Nubia, being the first to trace the Blue Nile to its confluence with the White Nile. On the 29th of November 1772 he reached Assuan, presently returning to the desert to recover his journals and his baggage, which had been abandoned in consequence of the death of all his camels. Cairo was reached in January 1773, and in March

¹ Dr Shaw's *Travels . . . relating to Several Parts of Barbary* was first printed at Oxford (1738).

Bruce arrived in France, where he was welcomed by Buffon and other savants. He came to London in 1774, but, offended by the incredulity with which his story was received, retired to his home at Kinnaird. It was not until 1790 that, urged by his friend Daines Barrington, he published his *Travels to Discover the Source of the Nile in the Years 1768-73*, in five octavo volumes, lavishly illustrated. The work was very popular, but was assailed by other travellers as being unworthy of credence. The manner in which the book was written—twelve years after Bruce's return from Africa and without reference to his journals—gave some handle to his critics, but the substantial accuracy of every statement concerning his Abyssinian travels has since been amply demonstrated. He died on the 27th of April 1794.

Bruce wrote an autobiography, part of which is printed in editions of his *Travels*, published in 1805 and 1813, accompanied by a biographical notice by the editor, Alexander Murray. The best edition of the *Travels* is the third (Edinburgh, 1813, 8 vols.). Of the abridgements the best is that of Major (afterwards Sir Francis) Head, the author of a well-informed *Life of Bruce* (London, 1830). The best account of Bruce's travels in Barbary is contained in Sir R. Lambert Playfair's *Travels in the Footsteps of Bruce* (London, 1877), in which a selection of his drawings was published for the first time. Several of Bruce's drawings were presented to George III. and are in the royal collection at Windsor.

BRUCE, MICHAEL (1746-1767), Scottish poet, was born at Kinrosswood in the parish of Portmouk, Kinross-shire, on the 27th of March 1746. His father, Alexander Bruce, was a weaver, and a man of exceptional ability. Michael was taught to read before he was four years old, and one of his favourite books was a copy of Sir David Lyndsay's works. He was early sent to school, but his attendance was often interrupted. He had frequently to herd cattle on the Lomond Hills in summer, and this early companionship with nature greatly influenced his poetic genius. He was a delicate child, and grew up contemplative, devotional and humorous, the pet of his family and his friends. His parents gave him an education superior to their position; he studied Latin and Greek, and at fifteen, when his school education was completed, a small legacy left to his mother, with some additions from kindly neighbours, provided means to send Michael to Edinburgh University, which he attended during the four winter sessions 1762-1765. In 1765 he taught during the summer months at Gairney Bridge, receiving about £11 a year in fees and free board in one or other of the homes of his pupils. He became a divinity student at Kinross of a Scottish sect known as the Burghers, and in the first summer (1766) of his divinity course accepted the charge of a new school at Forest Hill, near Clackmannan, where he led a melancholy life. Poverty, disease and want of companions depressed his spirits, but there he wrote "Lochleven," a poem inspired by the memories of his childhood. He had before been threatened with consumption, and now became seriously ill. During the winter he returned on foot to his father's house, where he wrote his last and finest poem, "Elegy written in Spring," and died on the 5th of July 1767.

As a poet his reputation has been spread, first, through sympathy for his early death; and secondly, through the alleged theft by John Logan (*q.v.*) of several of his poems. Logan, who had been a fellow-student of Bruce, obtained Bruce's MSS. from his father, shortly after the poet's death. For the letters, poems, &c., that he allowed to pass out of his hands, Alexander Bruce took no receipt, nor did he keep any list of the titles. Logan edited in 1770 *Poems on Several Occasions, by Michael Bruce*, in which the "Ode to the Cuckoo" appeared. In the preface he stated that "to make up a miscellany, some poems written by different authors are inserted." In a collection of his own poems in 1781, Logan printed the "Ode to the Cuckoo" as his own; of this the friends of Bruce were aware, but did not challenge its appropriation publicly. In a MS. *Pious Memorials of Portmouk*, drawn up by Bruce's friend, David Pearson, Bruce's authorship of the "Ode to the Cuckoo" is emphatically asserted. This book was in the possession of the Birrell family, and John Birrell, another friend of the poet, adds a testimony to the same effect. Pearson and Birrell also wrote to Dr Robert Anderson while he was publishing his *British Poets*, pointing out Bruce's claims. Their

communications were used by Anderson in the "Life" prefixed to Logan's works in the *British Poets* (vol. ii. p. 1029). The volume of 1770 had struck Bruce's friends as being incomplete, and his father missed his son's "Gospel Sonnets," which are supposed by the partisans of Bruce against Logan to have been the hymns printed in the 1781 edition of Logan's poems. Logan tried to prevent by law the reprinting of Bruce's poems (see James Mackenzie's *Life of Michael Bruce*, 1905, chap. xii.), but the book was printed in 1782, 1784, 1796 and 1807. Dr William M'Kelvie revived Bruce's claims in *Lochleven and Other Poems, by Michael Bruce, with a Life of the Author from Original Sources* (1837). Logan's authorship rests on the publication of the poems under his own name, and his reputation as author during his lifetime. His failure to produce the "poem book" of Bruce entrusted to him, and the fact that no copy of the "Ode to the Cuckoo" in his handwriting was known to exist during Bruce's lifetime, make it difficult to relieve him of the charge of plagiarism. Prof. John Veitch, in *The Feeling for Nature in Scottish Poetry* (1887, vol. ii. pp. 89-91), points out that the stanza known to be Logan's addition to this ode is out of keeping with the rest of the poem, and is in the manner of Logan's established compositions, in which there is nothing to suggest the direct simplicity of the little poem on the cuckoo.

BIBLIOGRAPHY.—Additions to *Poems on Several Occasions* (1770) were made by Dr M'Kelvie in his 1837 edition. He gives (p. 97) a list of the poems not printed in Logan's selection, and of those that are lost. See the "Lives" of Bruce and of Logan in Anderson's *British Poets* (1795); an admirable paper on Bruce in *The Mirror* (No. 36, 1779), said to be by William Craig, one of the lords of session; *The Poetical Works of Michael Bruce, with Life and Writings* (1895), by William Stephen, who, like Dr A. B. Grosart in his edition (1865) of *The Works of Michael Bruce*, adopts M'Kelvie's view. A restatement of the case for Bruce's authorship, coupled with a rather violent attack on Logan, is to be found in the *Life of Michael Bruce, Poet of Loch Leven, with Vindication of His Authorship of the "Ode to the Cuckoo" and other Poems, also Copies of Letters written by John Logan now first published* (1905), by James Mackenzie.

BRUCH, MAX (1838-), German musical composer, son of a city official and grandson of the famous Evangelical cleric, Dr Christian Bruch, was born at Cologne on the 6th of January 1838. From his mother (*née* Almenröder), a well-known musician of her time, he learnt the elements of music, but under Breidenstein he made his first serious effort at composition at the age of fourteen by the production of a symphony. In 1853 Bruch gained the Mozart Stipendium of 400 gulden per annum for four years at Frankfurt-on-Main, and for the following few years studied under Hiller, Reinecke and Breunung. Subsequently he lived from 1858 to 1861 as pianoforte teacher at Cologne, in which city his first opera (in one act), *Scherr, List und Rache*, was produced in 1858. On his father's death in 1861, Bruch began a tour of study at Berlin, Leipzig, Vienna, Munich, Dresden and Mannheim, where his opera *Lorelei* was brought out in 1863. At Mannheim he lived till 1864, and there he wrote some of his best-known works, including the beautiful *Fritzhof*. After a further period of travel he became musical-director at Coblenz (1865-1867), Hofkapellmeister at Sondershausen (1867-1870), and lived in Berlin (1871-1873), where he wrote his *Odysseus*, his first violin concerto and two symphonies being composed at Sondershausen. After five years at Bonn (1873-1878), during which he made two visits to England, Bruch, in 1878, became conductor of the Stern Choral Union; and in 1880 of the Liverpool Philharmonic. In 1892 he was appointed director of the Berlin Hochschule. In 1893 he was given the honorary degree of Mus. Doc. by Cambridge University. Max Bruch has written in almost every conceivable musical form, invariably with straightforward honest simplicity of design. He has a gift of refined melody beyond the common, his melodies being broad and suave and often exceptionally beautiful.

BRUCHSAL, a town of Germany, in the grand-duchy of Baden, prettily situated on the Saalbach, 14 m. N. from Karlsruhe, and an important junction on the main railway from Mannheim to Constance. Pop. (1900), including a small garrison, 13,555. There are an Evangelical and four Roman Catholic churches, among the latter that of St Peter, the burial-place of the bishops

of Spire, whose princely residence (now used as a prison) lies in the vicinity. Bruchsal has a fine palace, with beautiful grounds attached, a town hall, a classical, a modern and a commercial school, and manufactures of machinery, paper, tobacco, soap and beer, and does a considerable trade in wine. Bruchsal (mentioned in 937 as *Brusolegem*) was originally a royal villa (*Königshof*) belonging to the emperors and German kings. Given in 1002 to Otto, duke of Franconia, it was inherited by the cadet line of Spire, the head of which, the emperor Henry III., gave it to the see of Spire in 1095. From 1105 onward it became the summer residence of the bishops, who in 1190 bought the *Vogtei* (advocateship) from the counts of Calw, and the place rapidly developed into a town. It remained in the possession of the bishops till 1802, when by the treaty of Lunéville it was ceded, with other lands of the bishopric on the right bank of the Rhine, to Baden. The Peasants' War during the Reformation period first broke out in Bruchsal. In 1609 it was captured by the elector palatine, and in 1676 and 1698 it was burnt down by the French. In 1849 it was the scene of an engagement between the Prussians and the Baden revolutionists.

See Römler, *Geschichte der Stadt Bruchsal* (2nd ed., Bruchsal, 1894).
BRUCINE, $C_8H_{12}N_2O_6$, an alkaloid isolated in 1819 by J. Pelletier and J. B. Caventou from "false *Angustura bark*." It crystallizes in prisms with four molecules of water; when anhydrous it melts at 178°. It is very similar to strychnine (*q.v.*), both chemically and physiologically.

BRUCITE, a mineral consisting of magnesium hydroxide, $Mg(OH)_2$, and crystallizing in the rhombohedral system. It was first described in 1814 as "native magnesia" from New Jersey by A. Bruce, an American mineralogist, after whom the species was named by F. S. Beudant in 1824; the same name had, however, been earlier applied to the mineral now known as chondrodite. Brucite is usually found as platy masses, sometimes of considerable size, which have a perfect cleavage parallel to the surface of the plates. It is white, sometimes with a tinge of grey, blue or green, varies from transparent to translucent, and on the cleavage surfaces has a pronounced pearly lustre. In general appearance and softness ($H=2\frac{1}{2}$) it is thus not unlike gypsum or talc, but it may be readily distinguished from these by its optical character, being uniaxial with positive birefringence, whilst gypsum is biaxial and talc has negative birefringence. The specific gravity is 2.38-2.40. In the variety known as nemalite the structure is finely fibrous and the lustre silky; this variety contains 5 to 8% of ferrous oxide replacing magnesia, and has consequently a rather higher specific gravity, viz. 2.45. Another variety, manganbrucite, has the magnesia partly replaced by manganous oxide (14%), and thus forms a passage to the isomorphous mineral pyrochroite, $Mn(OH)_2$.

Brucite is generally associated with other magnesian minerals, such as magnesite and dolomite, and is commonly found in serpentine, or sometimes as small scales in phyllites and crystalline schists; it has also been observed in metamorphosed magnesian limestone, such as the rock known as predazette from Predazzo in Tirol. The best crystals and foliated masses are from Texas in Pennsylvania, U.S.A., and from Swinans in Unst, one of the Shetland Isles. Nematite is from Hoboken, New Jersey, and from Afghanistan. At all these localities the mineral forms veins in serpentine. (L. J. S.)

BRÜCKENAU, a town and fashionable watering-place of Germany, in the kingdom of Bavaria, on the Sinn, 16 m. N.W. of Kissingen. The mineral springs, five in number, situated in the pleasant valley of the Sinn, 2 m. from the town, were a favourite resort of Louis I. of Bavaria. Pop. 1700.

BRUCKER, JOHANN JAKOB (1696-1770), German historian of philosophy, was born at Augsburg. He was destined for the church, and graduated at the university of Jena in 1718. He returned to Augsburg in 1720, but became parish minister of Kauffbeuren in 1723. In 1731 he was elected a member of the Academy of Sciences at Berlin, and was invited to Augsburg as pastor and senior minister of the church of St Ulrich. His chief work, *Historia Critica Philosophiae*, appeared at Leipzig (5 vols., 1742-1744). Its success was such that a new edition

was published in six volumes (1766-1767; English translation by W. Enfield, 1791). It is by this work alone that Brucker is now known. Its merit consists entirely in the ample collection of materials. He also wrote *Tentamen Introductionis in Historiam Doctrinae de Ideis*, afterwards completed and republished under the title of *Historia Philosophicæ Doctrinae de Ideis* (Augsburg, 1723); *Otiium Vindelicum* (1731); *Kurze Fragen aus der philosophischen Historie* (7 vols., Ulm, 1731-1736), a history of philosophy in question and answer, containing many details, especially in the department of literary history, which he omitted in his chief work; *Pinacotheca Scriptorum nostra aetate literis illustrium*, &c. (Augsburg, 1741-1755); *Ehrentempel der deutschen Gelehrsamkeit* (Augsburg, 1747-1749); *Institutiones Historiæ Philosophicæ* (Leipzig, 1747 and 1756; 3rd ed. with a continuation by F. G. B. Born (1743-1807) of Leipzig, in 1790); *Miscellanea Historiæ Philosophicæ Literariæ Criticæ olim sparsim edita* (Augsburg, 1748); *Erste Anfangsgründe der philosophischen Geschichte* (Ulm, 1751). He superintended an edition of Luther's translation of the Old and New Testament, with a commentary extracted from the writings of the English theologians (Leipzig, 1758-1770, completed by W. A. Teller). He died at Augsburg in 1770.

BRÜCKMANN, FRANZ ERNST (1697-1753), German mineralogist, was born on the 27th of September 1697 at Marienthal near Helmstädt. Having qualified as a medical man in 1721, he practised at Brunswick and afterwards at Wolfenbüttel. His leisure time was given up to natural history, and especially to mineralogy and botany. He appears to have been the first to introduce the term *oolithus* to rocks that resemble in structure the roe of a fish; whence the terms oolite and oolitic. He died at Wolfenbüttel on the 21st of March 1753. He published *Magnalia Dei in locis subterraneis* (Brunswick, 1727), *Historia naturalis curiosa lapidum* (1727), and *Thesaurus subterraneus Ducatus Brunsvigii* (1728).

BRÜCKNER, ANTON (1824-1896), Austrian musical composer, was born on the 4th of September 1824 at Ansfelden in upper Austria. He successfully competed for the organistship for Linz Cathedral in 1855. In 1867 he succeeded his former master of counterpoint, Sechter, as organist of the *Hofkapelle* in Vienna, and also became professor in the conservatorium. In 1875 he was appointed to a lectureship in the university. His most striking talent was shown in his extemporizations on the organ. His success in an organ competition at Nancy in 1869 led to his playing in Paris and London (six recitals at the Albert Hall, 1871). His permanent reputation, however, rests on his compositions, especially his nine symphonies. In these gigantic efforts the influence of Wagner is paramount in almost every feature of harmony and orchestration; and if sustained seriousness of purpose and style were all that was necessary to give coherence to works in which these influences are stultified by the rhythmic uniformities of an experienced *improvisatore* and the impressions of classical form as taught in schools, then Bruckner would certainly have been what the extreme Wagnerian party called him, the symphonic successor of Beethoven, or the Wagner of the symphony. But their lack of organization and proportion, to say nothing of humour, will always make their revival a somewhat severe task. No composer has ever been more consistent to lofty ideals, though few who have ever had an ideal have shown less adroitness in their methods of embodying it. The most poetic and admired feature of his style is a slow growth to a gigantic climax, slow enough and gigantic enough for any situation in Wagner's *Nibelungen* tetralogy. The symphonies in which these climaxes occur are in obviously unskilful classical form, with only an outward appearance of freedom; and the Great Pyramid would hardly be more out of place in an Oxford quadrangle than Bruckner's climaxes in his four-movement symphonies with their "second subjects" and recapitulations. Nor is it likely that Bruckner would have been much more successful in handling these gigantic things in their legitimate Wagnerian dramatic environment, for even in his last three symphonies he hardly ever frees himself from the trammels of square rhythm; and, as he accepts the classical sonata-forms

without inquiry into their meaning or relevance, so he accepts the Wagnerian stage orchestra in its minutest details, without inquiry as to its relevance for the purposes and acoustics of the concert-room, and with the same lack of sense of relief that ruins the balance of his rhythmic periods. So unsophisticated a temperament may be not unpoetical, but it is eminently undramatic, as well as unsymphonic. Of Bruckner's choral works, which include three masses and several psalms and motets, the most famous is the *Te Deum* (1887),¹ which shows his characteristic power in massive effect. Bruckner wished this to be appended to the three complete movements of his 9th symphony, which his last illness (ending in his death at Vienna on the 11th of October 1896) prevented him from finishing. This 9th symphony is designed, with characteristic tactlessness and simplicity, to follow Beethoven's 9th symphony in every possible point which could challenge comparison; in key (D minor), opening (mysterious tremolo leading to tremendous unison *tuisti*), contrasts (return in first movement) and choral finale. The three complete movements were first performed in Vienna in 1903, and have done more for Bruckner's fame than anything since the production in 1884 of his 7th symphony (of which the slow movement is an elegy on the death of Wagner). It is probable that the impression produced by this 9th symphony is the deeper as owing little or nothing to the musical politics which had gone far to prevent the 7th symphony from standing on its own unmistakable merits. It does not, however, seem likely that Bruckner's work will have much influence on musical progress; for the modern characteristics in which its strength lies are obviously better realized in other forms which have often been handled successfully by composers greatly Bruckner's inferiors both in invention and sincerity. (D. F. T.)

BRUGES (Flemish *Brugge*, a name signifying the bridge or place of bridges), the capital of West Flanders, Belgium. Pop. (1904) 53,728. The city contains some of the finest monuments of the great period of the Flemish communes, while its mediæval appearance is better preserved, as a whole, than in the case of any other Belgian city. The cathedral of St Sauveur and the church of Notre-Dame, both specimens of early Pointed Gothic, date from the 13th and 14th centuries. Both are full of interest, but the cathedral was much injured by fire in 1839. The interior, however, is finely proportioned and exhibits beautiful modern polychrome decorations, numerous pictures and interesting monumental brasses. The church of Notre-Dame contains a fine *De Crayer* (The Adoration of the Magi), Michelangelo's marble group of the Virgin and Child, and the fine monuments with gilded copper effigies of Charles the Bold and his daughter, Mary of Burgundy. The hospital of St Jean, where the sick have been cared for since the 12th century, contains the chief works of Memling, including the famous reliquary of St Ursula. The market-hall was built in 1561-1566 on the site of an older building, some portions of which were utilized in its successor. The belfry which rises in the centre of the façade dates from the end of the 13th century; it has long been famous for its chime of bells, but the civic fathers have caused modern aims to be substituted for the old hymn. The hôtel de ville, the Chapelle du Saint-Sang and the church of St Jacques are all of interest. The first is Gothic and was begun about 1376. The second is a chapel of two storeys, the lower dating from 1150, while the upper was rebuilt in the 15th century, and there is a rich Flamboyant entrance with a stairway (1533). St Jacques' church is a foundation of the 13th century, but has extensive additions of the close of the 15th and 17th centuries. The Palais de Justice, of the 18th century, on the site of the House of the Franc—the outside burghers of the Franc district admitted to the full privileges of citizenship—contains a fine carved chimney-piece (1530). The house is supposed to have formed part of the residence of the counts of Flanders. There are numerous other buildings of minor antiquarian interest; the fine museum contains a representative gallery of early Flemish paintings; and of the old fortifications three gates remain. The

¹ This date is given in Grove (new ed.), but the style of the work is far earlier than that of the 7th symphony (1884) which quotes it in the slow movement.

manufacture of lace now gives employment to at least 6000 persons in the town, and horticulture is carried on extensively in the suburbs. Commercial activity has been assisted by the new ship-canal to Zeebrugge, and by direct steamship service from Hull to Bruges. The steady growth of the population is evidence of increased prosperity. In 1880 the population was only 44,500, but it had risen in 1900 to 51,657 and in 1904 it was 53,728.

Bruges is said to have been a city in the 7th century, and the name Flanders was originally applied to it and not to the district. Baldwin II., count of Flanders, who married Elstrud, daughter of Alfred the Great, first fortified it, and made it his chief residence. Before the year 1180 Bruges was the recognized capital of Flanders, and the formality of proclaiming the new counts was always performed on the *marché des seigneurs*, where the railway station is to-day. After 1180 the premier position was assumed by Ghent, but until access by sea was stopped by the silting up of the Zwyn, which was complete by the year 1490, Bruges was the equal in wealth and power of its neighbour. Proof of this is supplied by the marriage festivities in 1430, when Philip the Good, duke of Burgundy, wedded Isabel of Portugal, and founded the famous order of the Golden Fleece out of compliment to the staple industry of Bruges. Bruges was at the height of its prosperity in the 14th century, when it was the northern counterpart of Venice and its Bourse regulated the rate of exchange in Europe. (D. C. B.)

BRUGSCH, HEINRICH KARL (1827-1894), German Egyptologist, was the son of a Prussian cavalry officer, and was born in the barracks at Berlin, on the 18th of February 1827. He early manifested a great inclination to Egyptian studies, in which, though encouraged by Humboldt, he was almost entirely self-taught. After completing his university course and visiting foreign museums he was sent to Egypt by the Prussian government in 1853, and contracted an intimate friendship with Mariette. On his return he received an appointment in the Berlin museum. In 1860 he was sent to Persia on a special mission under Baron Minutoli, travelled over the country, and after Minutoli's death discharged the functions of ambassador. In 1864 he was consul at Cairo, in 1868 professor at Göttingen, and in 1870 director of the school of Egyptology, founded at Cairo by the khedive. From this post he was unceremoniously dismissed in 1879 by the European controllers of the public revenues, determined to economize at all hazards; and French influence prevented his succeeding his friend Mariette at the Bulak Museum in 1883. He afterwards resided principally in Germany until his death on the 9th of September 1894, but frequently visited Egypt, took part in another official mission to Persia, and organized an Egyptian exhibit at the Philadelphia Exposition in 1876. He had been made a pasha by the khedive in 1881. He published his autobiography in 1894, concluding with a warm panegyric upon British rule in Egypt. Brugsch's services to Egyptology are most important, particularly in the decipherment of demotic and the making of a vast hieroglyphic-demotic dictionary (1867-1882).

See H. Brugsch, *Mein Leben und mein Wandern*; also art. EGYPT, section *Language and Writing*.

BRÜHL, HEINRICH, COUNT VON (1700-1763), German statesman at the court of Saxony, was born on the 13th of August 1700. He was the son of Johann Moritz von Brühl, a noble who held the office of *Oberhofmarschall* at the small court of Sachsen-Weissenfels. The father was ruined and compelled to part with his family estate, which passed into the hands of the prince. The son was first placed as page with the dowager duchess of Weissenfels, and was then received at her recommendation into the court of the elector of Saxony as *Silberpage* on the 16th of April 1710. He rapidly acquired the favour of the elector Frederick Augustus, surnamed the Strong, who had been elected to the throne of Poland in 1697. Brühl, who began as page and chamberlain, was largely employed in procuring money for his profuse master. He made himself useful in muzzling the Saxon states and was successively chief receiver of taxes and minister for the interior in 1731. He was at Warsaw when his master

died in 1733, and he secured a hold on the confidence of the electoral prince, Frederick Augustus, who was at Dresden, by laying hands on the papers and jewels of the late ruler and bringing them promptly to his successor. During the whole of the thirty years of the reign of Frederick Augustus II. he was the real inspirer of his master and the practical chief of the Saxon court. He had for a time to put up with the presence of old servants of the electoral house, but after 1738 he was in effect sole minister. The title of prime minister was created for him in 1746, but he was not only a prime minister—he filled all the offices. His titles spread over several lines of print, and he drew the combined pay of the places besides securing huge grants of land. Brühl must therefore be held wholly responsible for the ruinous policy which destroyed the position of Saxony in Germany between 1733 and 1763; for the mistaken ambition which led Frederick Augustus II. to become a candidate for the throne of Poland; for the engagements into which he entered in order to secure the support of the emperor Charles VI.; for the shameless and ill-timed tergiversations of Saxony during the wars of the Austrian Succession; for the intrigues which entangled the electorate in the alliance against Frederick the Great, which led to the Seven Years' War; and for the waste and want of foresight which left the country utterly unprepared to resist the attack of the king of Prussia. He was not only without political or military capacity, but was so garrulous that he could not keep a secret. His indiscretion was repeatedly responsible for the king of Prussia's discoveries of the plans laid against him. Nothing could shake the confidence of his master, which survived the ignominious flight into Bohemia, into which he was trapped by Brühl at the time of the battle of Kesseldorf, and all the miseries of the Seven Years' War. The favourite abused the confidence of his master shamelessly. Not content with the 67,000 talers a month which he drew as salary for his innumerable offices, he was found when an inquiry was held in the next reign to have abstracted more than five million talers of public money for his private use. He left the work of the government offices to be done by his lackeys, whom he did not even supervise. His profusion was boundless. Twelve tailors, it is said, were continually employed in making clothes for him, and he wore a new suit every day. His library of 70,000 volumes was one of his forms of ostentation, and so was his gallery of pictures. He died on the 28th of October 1763, having survived his master only for a few weeks. The new elector, Frederick Christian, dismissed him from office and caused an inquiry to be held into his administration. His fortune was found to amount to a million and a half of talers, and was sequestered but afterwards restored to his family. In 1736 he had been made a count of the Empire and had married the countess Franziska von Kolowrat-Kradowska, a favourite of the wife of Frederick Augustus. Four sons and a daughter survived him.

His youngest son, Hans Moritz von Brühl (d. 1811), was before the Revolution of 1789 a colonel in the French service, and afterwards general inspector of roads in Brandenburg and Pomerania. By his wife Margarethe Schleiwerber, the daughter of a French corporal, but renowned for her beauty and intellectual gifts, he was the father of Karl Friedrich Moritz Paul von Brühl (1772-1837), the friend of Goethe, who as intendant-general of the Prussian royal theatres was of some importance in the history of the development of the drama in Germany. In 1830 he was appointed intendant-general of the royal museums.

See J. G. H. von Justi, *Leben und Charakter des Grafen von Brühl* (Göttingen, 1760-1761).

BRÜHL, a town of Germany, in the Prussian Rhine province, 8 m. S.W. from Cologne on the main railway to Coblenz. Pop. (1900) 5000. Its pleasant situation at the foot of one of the spurs of the Eifel range and the beautiful grounds surrounding the royal palace render it a favourite resort of the inhabitants of Cologne. The palace, in Renaissance style, built in 1728 by Clement Augustus, elector of Cologne (1700-1761), was from 1800 until 1813 in the possession of the French marshal Davout, and in 1842 was restored by King Frederick William IV. of Prussia.

BRUMAIRE, the name of the second month in the republican calendar which was established in France by a decree of the National Convention on the 5th of October in the year II. (1793), completed with regard to nomenclature by Fabre d'Églantine, and promulgated in its new form on the 4th of Frimaire in the year II. (the 24th of November 1793). The month of Brumaire began on the day which corresponded, according to the year, to the 22nd or to the 23rd of October of the old calendar, and ended on the 20th or 21st of November. It was divided into "decades" like the other months of the republican calendar. Its name alludes to the fogs and mists frequent at that time of the year. The most important event in French history which took place during that month was the *coup d'état* of the 18th Brumaire in the year VIII. (the 9th of November 1799), by which General Bonaparte overthrew the government of the Directory to replace it by the Consulate.

On the republican calendar, see G. Villain, "Le Calendrier républicain," in *La Révolution française* for 1884-1885.

BRUMATH, or **BRUMPT**, a town of Germany, in the imperial territory of Alsace-Lorraine, on the Zorn and the Strassburg-Avicourt railway. Pop. 5500. It has a Roman Catholic and a Protestant church, and occupies the site of the Roman Brocomagus. Its industries comprise tanning and saw-milling, and it has some trade in wine and tobacco and hops.

BRUMMAGEM (an old local form of "Birmingham"), a name first applied to a counterfeit coin made in the city of Birmingham, England, in the 17th century, and later to the plated and imitation articles made there; hence cheap, showy or tawdry. The name was particularly used of the supporters of the Exclusion Bill in 1680, with the meaning of "sham Protestant." Similarly the Tory opponents of the Bill were nicknamed "Anti-Birminghams" or "Brummagems."

BRUMMELL, GEORGE BRYAN (1778-1840), English man of fashion, known as "BEAU BRUMMELL," was born in London on the 7th of June 1778. His father was private secretary to Lord North from 1770 to 1782, and subsequently high sheriff of Berkshire; his grandfather was a shopkeeper in the parish of St James, who supplemented his income by letting lodgings to the aristocracy. From his early years George Brummell paid great attention to his dress. At Eton, where he was sent to school in 1790, and was extremely popular, he was known as Buck Brummell, and at Oxford, where he spent a brief period as an undergraduate of Oriel College, he preserved this reputation, and added to it that of a wit and good story-teller, while the fact that he was second for the Newdigate prize is evidence of his literary capacity. Before he was sixteen, however, he left Oxford, for London, where the prince of Wales (afterwards George IV.), to whom he had been presented at Eton, and who had been told that Brummell was a highly amusing fellow, gave him a commission in his own regiment (1794). Brummell soon became intimate with his patron—indeed he was so constantly in the prince's company that he is reported not to have known his own regimental troop. In 1798, having then reached the rank of captain, he left the service, and next year succeeded to a fortune of about £30,000. Setting up a bachelor establishment in Mayfair, he became, thanks to the prince of Wales's friendship and his own good taste in dress, the recognized *arbiter elegantiarum*. His social success was instant and complete, his repartees were the talk of the town, and, if not accurately speaking a wit, he had a remarkable talent for presenting the most ordinary circumstances in an amusing light. Though he always dressed well, he was no mere fop—Lord Byron is credited with the remark that there was nothing remarkable about his dress save "a certain exquisite propriety." For a time Brummell's sway was undisputed. But eventually gambling and extravagance exhausted his fortune, while his tongue proved too sharp for his royal patron. They quarrelled, and though for a time Brummell continued to hold his place in society, his popularity began to decline. In 1816 he fled to Calais to avoid his creditors. Here he struggled on for fourteen years, receiving help from time to time from his friends in England, but always hopelessly in debt. In 1830 the interest of these friends secured him the post of

British consul at Caen, to which a moderate salary was attached, but two years later the office was abolished. In 1835 Brummell's French creditors in Calais and Caen lost patience and he was imprisoned, but his friends once more came to the rescue, paid his debts and provided him with a small income. He had now lost all his interest in dress; his personal appearance was slovenly and dirty. In 1837, after two attacks of paralysis, shelter was found for him in the charitable asylum of Bon Sauveur, Caen, where he died on the 30th of March 1840.

See Captain William Jesse, *Life of Brummell* (London, 1844, revised edition 1886); Percy H. Fitzgerald, *Life of George IV.* (London, 1881); R. Boutet de Moavel, *Beau Brummell* (trans. 1906).

BRUNCK, RICHARD FRANÇOIS PHILIPPE (1720-1803), French classical scholar, was born at Strassburg on the 30th of December 1720. He was educated at the Jesuits' College at Paris, and took part in the Seven Years' War as military commissary. At the age of thirty he returned to his native town and resumed his studies, paying special attention to Greek. He spent considerable sums of money in publishing editions of the Greek classics. The first work which he edited was the *Anthologia Græca* or *Analecra veterum Poetarum Græcorum* (1772-1776), in which his innovations on the established mode of criticism startled European scholars; for wherever it seemed to him that an obscure or difficult passage might be made intelligible and easy by a change of text, he did not scruple to make the necessary alterations, whether the new reading were supported by manuscript authority or not. Other works by him are:—Editions of Anacreon (1778), several plays of the Greek tragedians, Apollonius Rhodius (1780), Aristophanes, with an excellent Latin translation (1781-1785), *Gnomici poetæ Græci* (1784), Sophocles (1786), with Latin translation, his best work, for which he received a pension of 2000 francs from the king. He also published editions of Virgil (1785), Plautus (1788) and Terence (1797). At the outbreak of the French Revolution, in which he took an active part, he was imprisoned at Besançon, and lost his pension, being reduced to such extremities that he was obliged to sell a portion of his library. In 1802 his pension was restored to him, but too late to prevent the sale of the remainder of his books. He died on the 12th of June 1803.

BRUNDISIUM (Gr. *Bperriov*, mod. *Brindisi*), an important harbour town of Calabria (in the ancient sense), Italy, on the E.S.E. coast. The name is said to mean "stag's head" in the Messapian dialect, in allusion to the shape of the harbour. Tradition varies as to its founders; but we find it hostile to Tarentum, and in friendly relations with Thurii. With a fertile territory round it, it became the most important city of the Messapians, but it was developed by the Romans, into whose hands it only came after the conquest of the Salentini in 266 B.C. They founded a colony there in 245 B.C., and the Via Appia was perhaps extended through Tarentum as far as Brundisium at this period. Pacuvius was born here about 220 B.C. After the Punic Wars it became the chief point of embarkation for Greece and the East, via Dyrrachium or Corcyra. In the Social War it received Roman citizenship, and was made a free port by Sulla. It suffered, however, from a siege conducted by Caesar in 49 B.C. (*Bell. Civ. l.*) and was again attacked in 41 and 40 B.C. Virgil died here in 19 B.C. on his return from Greece. Trajan constructed the Via Trajana, a more direct route from Beneventum to Brundisium. The remains of ancient buildings are unimportant, though a considerable number of antiquities, especially inscriptions, have been discovered here: one column 62 ft. in height, with an ornate capital, still stands, and near it is the base of another, the column itself having been removed to Lecce. They are said to have marked the termination of the Via Appia.

See Ch. Hülsen in Pauly-Wissowa, *Realencyclopædie*, iii. (1899), 902; *Notizie degli Scavi*, passim. Also BRINDISI. (T. AS.)

BRUNE, GUILLAUME MARIE ANNE (1763-1815), marshal of France, the son of an advocate, was born at Brives-la-Gaillarde (Corrèze), on the 13th of March 1763. Before the Revolution he went to Paris to study law, and here he became a political journalist, a Jacobin and a friend of Danton. He was appointed

in 1793 to a superior command in the army direct from civil life, and as a general of brigade he took part in the fighting of the 13th Vendémiaire. In 1796 he fought under Bonaparte in Italy, and was promoted general of division for good service in the field. In 1798 he commanded the French army which occupied Switzerland, and in the following year he was in command of the French troops in Holland. His defence of Amsterdam against the Anglo-Russian expedition under the duke of York was completely successful; the invaders were defeated, and compelled, after a miserable retreat, to re-embark. He rendered further good service in Vendée and in Italy, and was made a marshal by Napoleon on the assumption by the latter of the imperial title in 1804. In 1807 Brune held a command in North Germany, but he was not afterwards employed during the First Empire. It is said that he was accused of venality, and on that account disgraced, but of this there is no proof. He was recalled to active service during the Hundred Days, and as commander of the army of the Var he defended the south of France against the Austrians. He was murdered by royalists during the White Terror at Avignon on the 2nd of August 1815.

See *Notice historique sur la vie politique et militaire du maréchal Brune* (Paris, 1821), and Verneil de Conchard, *L'Assassinat du maréchal Brune* (Paris, 1887).

BRUNEAU, ALFRED (1857—), French musical composer, was born in Paris. His parents were devoted to music, and he was brought up to play the 'cello, being educated at the Paris Conservatoire. He played in Padeloup's orchestra, and soon began to compose, writing a cantata, *Geneviève de Paris*, at an early age. In 1884 his *Ouverture héroïque* was performed, followed by the choral symphonies, *Léda* (1884), *La Belle au bois dormant* (1886) and *Penitente*. But he is best known as a dramatic composer. In 1887 his first opera, *Kérin*, was produced; and in 1891 his successful opera *Le Rêve*, with a libretto founded on Zola's story. Another subject from Zola resulted in the opera *L'Attaque du moulin* (1893), and libretti by Zola himself were written for his next operas *Messidor* (1897) and *L'Ouvagan* (1901). Among Bruneau's other works may be mentioned his *Requiem* (1896), and his two collections of songs, *Lieds de France* and *Chansons à danser*. He was decorated with the Legion of Honour in 1895. His musical criticisms, published in several volumes, are remarkable for literary quality and vigour.

See Arthur Hervey's volume on Bruneau (1907).

BRUNEI, a state situated in the north-west of Borneo. It has been so diminished in area since the beginning of the 19th century as to have become in comparison with the other states of Borneo territorially insignificant. It formerly included the whole of northern Borneo and southern Palawan, and stretched down the west coast as far as Sambas. What remains of this once powerful sultanate is a triangular-shaped territory, the base of the triangle being represented by 80 m. of coast-line, and the two sides by the frontiers of Sarawak. The area is calculated to be about 1700 sq. m. This great reduction of the extent of the territory has been brought about by the cession on successive occasions of strips of territory to Sarawak and to the British North Borneo Company on condition of annual payments of money. In 1888 the state was placed under British protection. On the 2nd of January 1906 a treaty was made whereby the sultan of Brunei agreed to hand over the general administration of his state to a British resident. The sultan Mahommed Jomal-ul-alam, born in 1889, succeeded his father in May 1906. He receives an allowance of 12,000 dollars a year from state funds, and his two principal ministers receive allowances of 6000 dollars a year each. The interior people have for centuries been subject to petty oppression, and there is too much of the old spirit left among the Malays to avoid acrimonious dispute and rebellion.

The bulk of the inhabitants, who consist of Malays, Kadayans, Orang Bukits and a few Muruts, are to be found in and about the capital—also called Brunei—the population of the city being estimated at about 15,000, and the population of the whole territory being about 25,000. The city is prettily situated on the river, with a background of cleared hills, and in the distance heights clothed with magnificent forest. The dwelling-houses are

built over the river on slender piles obtained from the Nibong palm which resists the action of the water for several years. Though there are practically no exports and imports, there is a certain amount of inland commerce, the Brunei Malay usually earning a living by trading with the interior tribes of Sarawak and British North Borneo. Some of them are skilled workers of brass, and the Brunei women make very beautiful cloth, interwoven and embroidered with gold thread. Sago is worked in the important river-valleys of the Tutong and the Balait, but only a small quantity of rice is cultivated.

The history of this ancient and decaying sultanate is of some interest. Brunei, or, as it is called by the natives Bruni or Darul-Salam (city of peace), possesses a historic tablet of stone upon which, in A.H. 1221 (1804), was engraved in Malay characters the genealogy of the sovereigns who have ruled over the country. The engraving was the work of Datu Imaum Yakub, the high priest at the time, who received the genealogy from the lips of Merhoum Bongsu, otherwise Sultan Muadin, and Sultan Kemal-Udin, who ordered this record of their forefathers to be written. This stone tablet now stands on the tomb of Sultan Mahommed Jemal-ul-Alam at the foot of Panggal hill, in the city of Brunei. The Selesilah, or book of descent, is kept in the palace by the sultan. The other heirlooms, which are also kept in the sultan's palace, and which descend to each sultan in turn, are the "Nobab Nagara" (two royal drums) from Johore and Menang-Kabau, and the "Gunta Alamat" (bells), the gift of Sultan Bahkei of Johore or Malacca. The first sultan of Brunei was Alak-ber-Tata, who was probably of Bisaya stock, and governed the country before the introduction of Islam, in the 15th century. He assumed the name of Mahommed on his conversion to Islam, which was brought about during a visit to the Malay peninsula. Brunei, at this time, was a dependency of Majapahit (Java), and paid a yearly tribute of a jar of areca juice obtained from the young green nuts of the areca palm, and of no monetary value. The Hindu kingdom of Menjapahit was destroyed by the Mahommedans in 1478, and Brunei is mentioned in the history of Java as one of the countries conquered by Adaya Mingrat, the general of Angka Wijaya. Sultan Mahommed's only child was a daughter. His brother Akhmed married the daughter of Ong Chum Ping, a Chinese officer said to have been sent by his emperor to obtain a jewel from Mount Kinabalu in North Borneo, and was the successor of Sultan Mahommed in the sovereignty of Brunei. He was succeeded by Sultan Berkat, an Arab shier of high rank, from the country of Taif in Arabia, who had married Sultan Akhmed's only child. Sultan Berkat built a mosque and enforced Mahommedan law, and with the assistance of the Chinese built the stone wall, which is still in existence between the islands of Kaya Orang and Chermin, by sinking forty junks filled with rock across the mouth of the Brunei river. This work was completed before the arrival of Pigafetta in 1521. In the reign of Sultan Bulkeiah Magellan's squadron anchored off the mouth of Brunei river in August 1521, and Pigafetta makes mention of the splendid court and the imperial magnificence of the Borneo capital. Sultan Bulkeiah was otherwise known as Nakoda Ragam; he was the greatest warrior of Brunei and made military expeditions to Java, Malacca, Luzon and all the coasts of Borneo. His tomb, which is handsomely built of stone, is still to be seen in Brunei, and is constantly visited by Malays, who leave money and various articles on the tomb as offerings to his memory. Others, again, come and take away anything they can find, which they keep as charms and mementoes. The Spaniards captured Brunei in 1580, the reigning sultan and his court retiring to Suai in the Baram district. The invaders were compelled to evacuate the place, however, in consequence of the heavy losses they sustained in the numerous attempts made for its recovery. The golden age of Brunei was nevertheless at an end, and there is little more of importance to record. Disputed successions and civil war, maladministration and the untrustworthiness of the Malay character, caused a steady decline in prosperity. The East India Company started a factory in the town in the 18th century, but commerce had already decayed and the establishment was abandoned. In the early part of the 19th century Brunei was but

a resort for pirates and a market for the slave trade. During the 'forties Admiral (then Captain) Keppel and other officers of the British navy suppressed piracy in the neighbourhood. Sarawak was handed over to Raja Brooke, and, after the capture and temporary occupation of Brunel by Sir Thomas Cochrane, Labuan was ceded to the British empire. From this island it was possible to exercise a certain control over the townspeople, and a consul was stationed there to watch affairs. Nowadays the political consequence of Brunel largely arises from the existence there of valuable seams of coal, leased to the Sarawak government. (C. H.)

BRUNEL, ISAMBARD KINGDOM (1806-1859), English engineer, only son of Sir M. I. Brunel, was born at Portsmouth on the 9th of April 1806. He displayed in childhood singular powers of mental calculation, great skill and rapidity as a draughtsman, and a true feeling for art. At the age of fourteen he was sent to Paris, to study at the Collège Henri Quatre. In 1823 he entered his father's office as assistant-engineer, just at the time when the project of the Thames Tunnel was beginning to take shape; and during the later portion of the time, from 1825, when the work was begun, till 1828, when it was stopped by an irruption of the river, he was both nominal and actual resident engineer. In November 1829 he sent in designs and plans for the projected suspension bridge over the Avon at Clifton, but in consequence of objections raised by Thomas Telford, the referee of the bridge committee, his plans were rejected. But a new design which he sent in on a second competition in 1831 was accepted, and he was appointed engineer. The works were begun in 1836, but owing to lack of funds were not completed until 1864, after Brunel's death; his design, however, was closely adhered to, and the chains employed came from the old Hungerford suspension bridge (London), which he had built in 1841-1845, but which was displaced in 1862 by the Charing Cross railway bridge.

In March 1833 Brunel, at the age of twenty-seven, was appointed engineer of the newly-projected Great Western railway. For several years his energies were taxed to the utmost by the conflict with obstructive landowners and short-sighted critics; but he showed himself equal to the occasion, not only as a professional man, but as a persuasive negotiator. Among the engineering triumphs on that railway are the Hanwell viaduct, the Maidenhead bridge and the Box tunnel, at the time the longest in the world. The famous "battle of the gauges" took its rise from his introduction of the broad (7 ft.) gauge on that line. In 1846 he resigned his office as engineer of the Great Western railway. In 1844 he had recommended the adoption of the atmospheric system on the South Devon railway, but after a year's trial the system was abandoned. The last and greatest of Brunel's railway works was the Royal Albert bridge over the river Tamar at Saltash. This work, sanctioned by parliament in 1845, was constructed between 1853 and 1859.

In addition to the arduous labours of railway engineering Brunel took a leading part in the systematic development of ocean steam navigation. As early as October 1835 he had suggested to the directors of the Great Western railway, that they should "make it longer, and have a steamboat to go from Bristol to New York, and call it the 'Great Western.'" The project was taken up, and the "Great Western" steamship was designed by Brunel, and built at Bristol under his superintendence. It was much longer than any steamer of the day, and was the first steamship built to make regular voyages across the Atlantic. While the vessel was building a controversy was raised about the practicability of Brunel's scheme, Dr D. Lardner asserting dogmatically that the voyage could not be made, and backing his assertion with an array of figures. His view was widely accepted, but the work went on, and the voyage was accomplished in 1838. Brunel at once undertook a still larger design in the "Great Britain," which was the first large iron steamship, the largest ship afloat at that time, and the first large ship in which the screw-propeller was used. She made her first voyage from Liverpool to New York in August and September 1845; but in the following year was carelessly run

upon the rocks in Dundrum Bay on the coast of Ireland. After lying there nearly a year without material damage she was got off and was employed in the Australian trade. Brunel soon after began to meditate a still vaster project, the construction of a vessel large enough to carry all the coal required for a long voyage out, and if coal could not be had at the out port, then to carry enough also for the return voyage. It seemed to him further, that a great increase of size would give many advantages for navigation. During his connexion as engineer with the Australian Mail Company he worked out into a practical shape his conception of a "great ship", and in 1852 his scheme was laid before the directors of the Eastern Steam Navigation Company. It was adopted, the projector being appointed engineer, and after much time occupied about contracts and specifications the work was begun in December 1853. Immense difficulties in the progress of construction caused delays from time to time. The operation of launching was several times attempted in vain; but at length the gigantic vessel, the "Great Eastern," was got afloat on the 31st of January 1858. Much remained to be done to complete the ship; and her engineer, overworked and worn out with worry, broke down and did not see her begin her first voyage on the 7th of September 1859. On the 5th he was brought home from the ship suffering from a paralytic stroke, and on the 15th he died at his house in Westminster.

In addition to the great works already described, Brunel was employed in the construction of many docks and piers, as at Monkwearmouth, Bristol, Plymouth, Briton Ferry, Brentford and Milford Haven. He was a zealous promoter of the Great Exhibition of 1851, and was a member of the committee on the section of machinery and of the building committee. He paid much attention to the improvement of large guns, and designed a floating gun-carriage for the attack on Kronstadt in the Russia War (1854); he also designed and superintended the construction of the hospital buildings at Erenkeni on the Dardanelles (1855). He was elected a fellow of the Royal Society in 1850, and in 1858 declined the presidency of the Institution of Civil Engineers through ill-health. He received the degree of D.C.I. from Oxford in 1857. In his work he was singularly free from professional jealousy, and was always ready to commend and help others, though, himself a man of remarkable industry and energy, he demanded a high standard of faithful service from his subordinates.

See *The Life of I.K. Brunel, C.E.* (1870), by his son, Isambard Brunel. **BRUNEL, SIR MARG ISAMBARD** (1769-1849), British inventor and engineer, was born at Hacqueville in Normandy on the 25th of April 1769. His father, a small landowner and farmer, intended him for the church, but his taste for mathematics and mechanics inclined him to another career, and he obtained a nomination for the navy, in which he served for six years. When his ship was paid off in 1792 and he returned to France, he found the Revolution at its height, and owing to his pronounced royalist opinions he was obliged to leave the country. Reaching New York in September 1793 he began to practise as an architect and civil engineer. His first employment was in land-surveying and canal-engineering. Later he submitted a highly ornamental design for the National Capitol at Washington, which, however, was not accepted, and was engaged to design and superintend the construction of the Bowery theatre, New York, burnt down in 1821. He fitted novel and ingenious machinery in the arsenal and cannon factory which he was commissioned to erect in New York, and he was asked to supply plans for the defences of the Narrows between the upper and lower bays of that port. Early in 1799 he sailed for England in order to submit to the British government his plans for the mechanical production of ships' blocks, in substitution for the manual processes then employed. After the usual difficulties and delays his proposals were adopted, largely through the recommendation of Sir Samuel Bentham, and about 1803 the erection of his machines was begun at Portsmouth dockyard. They were constructed by Henry Maudslay, and formed one of the earliest examples of a complete range of machine tools, each

performing its part in a long series of operations. Not only was the quality of the product much improved but the cost was greatly diminished, and the saving effected in the first year in which the machines were in full work was estimated at £24,000, of which about two-thirds was awarded to Brunel. A little later he was occupied in devising improved machines for sawing and bending timber, and in 1811 and 1812 he was employed by the government in erecting saw-mills at Woolwich and Chatham, carrying out at the latter dockyard a complete reorganization of the system for handling timber. About 1812 he devised machinery for making boots which was adopted for the purposes of the army, but abandoned a few years later when, owing to the cessation of war, the demand became less and the supply of manual labour cheaper. At the same time he interested himself in the establishment of steam navigation on the Thames between London and Ramsgate. In 1814 he succeeded in persuading the admiralty to try steam-tugs for towing warships out to sea. The experiments were made at his own expense, for a few months after undertaking to contribute to the cost the admiralty revoked its promise on the ground that the attempt was "too chimerical to be seriously entertained." Another vain enterprise on which he wasted much time and money was an attempt to use liquefied gases as a source of motive power. His round stocking-frame or *tricoteur* was patented in 1816, and among his other inventions were machines for winding cotton-thread into balls, for copying drawings, for making small wooden boxes such as are used by druggists, and for the manufacture of nails, together with processes of preparing tinfoil for decorative purposes and improvements in stereotype plates for printing.

In 1821, partly as the result of the damage done by fire in 1814 to the saw-mills he owned at Battersea, and partly because his commercial abilities were far from equal to his mechanical genius, he got into financial difficulties and was thrown into prison for debt, only regaining his freedom through a grant of £5000 which his friends obtained for him from the government. Subsequently his attention was mainly devoted to projects of civil engineering, the most noteworthy being the Thames Tunnel. In 1820 he had prepared plans of bridges for erection in Rouen and St Petersburg and in the island of Bourbon. In 1823 he designed swing-bridges, and in 1826 floating landing-stages, for the port of Liverpool. A company, which was supported by the duke of Wellington, was formed in 1824 to carry out his scheme for boring a tunnel under the Thames between Wapping and Rotherhithe. The work was begun at the beginning of 1825, the excavation being accomplished by the aid of a "shield," which he had patented in 1818. Many difficulties were encountered. The river broke through the roof of the tunnel in 1827, and after a second irruption in 1828 work was discontinued for lack of funds. Seven years later it was resumed with the aid of money advanced by the government, and after three more irruptions the tunnel was completed and opened in 1843. Aided by his son, Brunel displayed extraordinary skill and resource in the various emergencies with which he had to deal, but the anxiety broke down his health. He recovered sufficiently from one paralytic stroke to attend the opening ceremony, but he was able to undertake little more professional work. A second stroke followed in 1845, and four years later he died in London on the 12th of December 1849. He received the order of the Legion of Honour in 1850 and was knighted in 1841.

See Richard Beainish, *Memoirs of Sir Marc Isambard Brunel* (1862).

BRUNELLESCHI (or **BRUNELLESKO**), **FILIPPO** (1370-1446), Italian architect, the reviver in Italy of the Roman or Classic style, was born at Florence in 1370. His father, a notary, had destined him for his own profession, but observing the boy's talent for all sorts of mechanism, placed him in the guild of goldsmiths. Filippo quickly became a skilled workman, and perfected himself in the knowledge of sculpture, perspective and geometry. He designed some portions of houses in Florence, and in 1401 he was one of the competitors for the design of the gates of the baptistry of San Giovanni. He was unsuccessful, though his work obtained praise, and he soon afterwards set out

for Rome. He studied hard, and resolved to do what he could to revive the older classical style, which had died out in Italy. Moreover, he was one of the first to apply the scientific laws of perspective to his work. In 1407 he returned to Florence, just at the time when it was resolved to attempt the completion of the cathedral church of Santa Maria del Fiore. Brunelleschi's plan for effecting this by a cupola was approved, but it was not till 1419, and after innumerable disputes, that the work was finally entrusted to him. At first he was hampered by his colleague Ghiberti, of whom he skillfully got rid. He did not live to see the completion of his great work, and the lantern on the summit was put up not altogether in accordance with the instructions and plans left by him: The great cupola, one of the triumphs of architecture, exceeds in some measurements that of St Peter's at Rome, and has a more massive and striking appearance. Besides this masterpiece Brunelleschi executed numerous other works, among the most remarkable of which are the Pitti palace at Florence, on the pattern of which are based the Tuscan palaces of the 15th century, the churches of San Lorenzo and Spirito Santo, and the still more elegant Capella del Pazzi. The beautiful carved crucifix in the church of Santa Maria Novella in Florence is also the work of Brunelleschi. He died in Florence on the 16th of April 1446, and was buried in the cathedral church of his native city.

See Manetti, *Vita di Brunelleschi* (Florence, 1812); Guasti, *La cupola di Santa Maria del Fiore* (Florence, 1857); von Fabriczy, *Filippo Brunelleschi* (Stuttgart, 1892).

BRUNET, JACQUES CHARLES (1780-1867), French bibliographer, was born in Paris on the 2nd of November 1780. He was the son of a bookseller, and in 1802 he printed a supplement to the *Dictionnaire bibliographique de livres rares* (1790) of Duclos and Cailleau. In 1810 there appeared the first edition of his *Manuel du libraire et de l'amateur des livres* (3 vols.). Brunet published successive editions of his great bibliographical dictionary, which rapidly came to be recognized as the first book of its class in European literature. He died on the 14th of November 1867. Among his other works are *Nouvelles Recherches bibliographiques* (1834), *Recherches . . . sur les éditions originales . . . de Rabelais* (1852), and an edition of the French poems of J. G. Alione d'Asti, dating from the beginning of the 16th century (1836).

See also a notice by Le Roux de Lincy, prefixed to the catalogue (1868) of his own valuable library. A supplement to the 5th edition (1860-1865) of the *Manuel du libraire* was published (1878-1880) by P. Deschamps and G. Brunet.

BRUNETIÈRE, FERDINAND (1849-1906), French critic and man of letters, was born at Toulon on the 19th of July 1849. After attending a school at Marseille, he studied in Paris at the Lycée Louis-le-Grand. Desiring to follow the profession of teaching, he entered for examination at the École Normale Supérieure, but failed, and the outbreak of war in 1870 debarred him from a second attempt. He turned to private tuition and to literary criticism. After the publication of successful articles in the *Revue Bleue*, he became connected with the *Revue des Deux Mondes*, first as contributor, then as secretary and sub-editor, and finally, in 1893, as principal editor. In 1886 he was appointed professor of French language and literature at the École Normale, a singular honour for one who had not passed through the academic mill; and later he presided with distinction over various *conférences* at the Sorbonne and elsewhere. He was decorated with the Legion of Honour in 1887, and became a member of the Academy in 1893. The published works of M. Brunetière consist largely of reprinted papers and lectures. They include six series of *Études critiques* (1880-1898) on French history and literature; *Le Roman naturaliste* (1883), *Histoire et Littérature*, three series (1884-1886); *Questions de critique* (1888; second series, 1890). The first volume of *L'Évolution de genres dans l'histoire de la littérature*, lectures in which a formal classification, founded on the Darwinian theory, is applied to the phenomena of literature, appeared in 1890; and his later works include a series of studies (2 vols., 1894) on the evolution of French lyrical poetry during the 19th century, a history of

French classic literature begun in 1904, a monograph on Balzac (1906), and various pamphlets of a polemical nature dealing with questions of education, science and religion. Among these may be mentioned *Discours académiques* (1901), *Discours de combat* (1900, 1903), *L'Action sociale du christianisme* (1904), *Sur les chemins de la croyance* (1905). M. Brunetière was an orthodox Roman Catholic, and his political sympathies were in the main reactionary. He possessed two prime qualifications of a great critic, vast erudition and unflinching courage. He was never afraid to diverge from the established critical view, his mind was closely logical and intensely accurate, and he rarely made a trip in the wide field of study over which it ranged. The most honest, if not the most impartial, of magisterial writers, he had a hatred of the unreal, and a contempt for the trivial; nobody was more merciless towards those who affected effete and decadent literary forms, or maintained a vicious standard of art. On the other hand, his intolerance, his sledge-hammer methods of attack and a certain dry pedantry alienated the sympathies of many who recognized the remarkable qualities of his mind. The application of universal principles to every question of letters is a check to dilettante habits of thought, but it is apt to detain the critic in a somewhat narrow and dusty path. M. Brunetière's influence, however, cannot be disputed, and it was in the main thoroughly sound and wholesome. He died on the 9th of December 1906.

His *Manual of the History of French Literature* was translated into English in 1898 by R. Derechef. Among critics of Brunetière see J. Lemaitre, *Les Contemporains* (1897, &c.), and J. Sargeret, *Les Grands Contemporains* (1906).

BRUNHILD (M.H.Ger. *Brünhild* or *Fränkhilt*, Nor. *Brynhildr*), the name of a mythical heroine of various versions of the legend of the Nibelungs. The name means "the warrior woman in armour" (from O. H. Ger. *brunjo*, *brunja*, M. H. Ger. *brunige*, *brünje*, *brünne*, a cuirass or coat of mail, O. Eng. *byrnie*, and O. H. Ger. *hiltja*, *hilla*, war), and in the Norse versions of the Nibelung myth, which preserves more of the primitive traditions than the *Nibelungenlied*, Brunhild is a valkyrie, the daughter of Odin, by whom, as a punishment for having against his orders helped a warrior to victory, she has been cast under a spell of sleep on Hinderfjell, a lonely rock summit, until the destined hero shall penetrate the wall of fire by which she is surrounded, and wake her. This is a variant of the widespread myth which survives in the popular fairy-story of "the sleeping beauty." The ingenuity of some German scholars has made of Brunhild a personification of the day, held prisoner upon the hill-tops till in the morning the sun-god comes to her rescue, then triumphing with him awhile, only to pass once more under the spell of the powers of mist and darkness. She is thus by some commentators contrasted with "the masked warrior woman" Kriemhild (q.v.), a personification of the power of night and death. But whatever be the dim original of the character of Brunhild—as to which authorities are by no means agreed—even in the northern versions its mythical interest is quite subordinate to its purely human interest. In the *Volsungasaga* she is the heroine of a tragedy of passion and wounded pride, it is she who compasses the death of Sigurd, who has broken his troth pledged to her, and then immolates herself on his funeral pyre in order that in the world of the dead he may be wholly hers. In the *Nibelungenlied*, on the other hand, she plays a comparatively colourless rôle. She still possesses superhuman attributes: like Atalanta, she can only be won by the man who is able to overcome her in trials of speed and strength; but, instead of a valkyrie sleeping on a lonely rock, she is, when Sigfrid goes to woo her on behalf of Gunther, queen of Islant (Isenlant), living in a castle called the Isenstein. In the tragedy of the death of Sigfrid her part is completely overshadowed by that of "the grim Hagen," and from the moment that the murder is decided on she drops almost completely out of the story. The poet of the *Nibelungenlied* evidently knew nothing of the tale of her self-immolation, for, though he has nothing definite to say about her after Sigfrid's death, he keeps her alive in a sort of dignified retirement. In the last 5000 lines or so of the poem Brunhild

is only mentioned four times and takes no active part in the story. (See further under *Nibelungenlied*.) (W. A. P.)

BRUNHILDA (Brunehildis), queen of Austrasia (d. 613), was a daughter of Athanagild, king of the Visigoths. In 579 she was asked in marriage by Siebert, who was reigning at Metz. She now abjured Arianism and was converted to the orthodox faith, and the union was celebrated at Metz, on which occasion Fortunatus, an Italian poet, who was then at the Frankish court, composed the epithalamium. Chilperic, brother of Siebert, and king of the west Frankish kingdom, jealous of the renown which this marriage brought to his elder brother, hastened to ask the hand of Galswintha, sister of Brunhilda; but at the instigation of his mistress Fredegond, he assassinated his wife. Siebert was anxious to avenge his sister-in-law, but on the intervention of Guntram, he accepted the compensation offered by Chilperic, namely the cities of Bordeaux, Cahors and Limoges, with Béarn and Bigorre.

This treaty did not prevent war soon again breaking out between Siebert and Chilperic. So long as her husband lived, Brunhilda played a secondary part, but having been made captive by Chilperic after her husband's assassination (575), she succeeded in escaping from her prison at Rouen, after a series of extraordinary adventures, by means of a marriage with Merovech, the son of her conqueror. From this time on, she took the lead, in Austrasia she engaged in a desperate struggle against the nobles, who wished to govern in the name of her son Childebert II.; but she was worsted in the conflict and for some time had to seek refuge in Burgundy. After the death of Childebert II. (597) she aspired to govern Austrasia and Burgundy in the name of her grandsons Theudebert and Theuderich II. She was expelled from Austrasia, and then stirred up Theuderich II against his brother, whom he defeated at Toul and Tolbiac, and put to death. Theuderich II. died shortly after this victory, and Brunhilda caused one of her great-grandchildren to be proclaimed king Theobald of Austrasia and Burgundy, however, now summoned Clotaire II., son of Fredegond, and king of Neustria, to help them against the queen. Brunhilda was given up to him, and died a terrible death, being dragged at the heels of a wild horse (613).

Brunhilda seems to have had political ideas, and to have wished to attain to the royal power. She was a protectress of the Church, and Pope Gregory I. (590-604) addressed a series of letters to her, in which he showered praises upon her. She took it upon herself, however, to supervise the bishoprics and monasteries, and came into conflict with Columban (Columbanus), abbot of Luxeuil. As Brunhilda was a great queen, tradition ascribes to her the construction of many old castles, and a number of old Roman roads are also known by the name of *Chaussées de Brunehaut*.

AUTHORITIES.—Gregory of Tours, *Historia Francorum*, bks. iv &c. the so-called *Chronicle of Fredegarius*, Aug. Thierry, *Recueil des temps mérovingiens* (2 vols., Paris, 8th ed., 1864), G. Kurth, "La Reine Brunehaut," in the *Revue des questions historiques*, vol. xxx (1897) (C. Pp.)

BRUNI, LEONARDO (1369-1444), Italian scholar, author of the *History of Florence*, was born at Arezzo, and is generally known as Leonardo Aretino. He was secretary to the papal chancery under Innocent VII. and John XXII. From 1427 to his death in 1444 he was chancellor to the republic of Florence. He was buried at the expense of the state in Sta Croce, where his lauded statue is still to be seen. He was the first to free the history of Florence from its fabulous elements, but his book, though not unintelligent, only repays very laborious study. The only Latin edition is *Historiarum Florentinarum libri xiii* . . . *exemplum in lucem edit. stud. et op. Sixti Brunonis* (Argentor. 1610, fol.) A translation into Tuscan was published by Donato Acciajuoli in 1476 at Venice, was republished at Florence in 1492, and again, with Sansovino's continuation, at Venice in 1561.

BRÜNN (Czech *Brno*), the capital of the Austrian margraviate and crownland of Moravia, 89 m. N. of Vienna by rail. Pop. (1900) 108,044, of whom 70% are Germans and 30% are Czechs. Brünn is situated for the most part between two hills at the confluence of the Schwarzwä and the Zvitawa, and consists of

the old town and extensive suburbs. On one of the hills, known as the Spießberg (945 ft.), stands a castle which has long been used as a prison, famous for its connexion with Silvio Pellico, who was confined within its walls from 1822 to 1830. The fortifications of the old town have now been entirely removed, giving place to handsome gardens and well-built streets, which put it in communication with its adjoining suburbs. The old town, although comparatively small, with narrow and crooked but well-paved streets, contains the most important buildings in the city. The Rathaus, which dates from 1511, has a fine Gothic portal, and contains several interesting antiquities. The ecclesiastical buildings comprise the cathedral of St Peter, situated on the lower hill; the fine Gothic church of St Jacob, built in the 15th century, with its iron tower added in 1845, and a remarkable collection of early prints; the church of the Augustinian friars, dating from the 14th century; and that of the Minorites, with its frescoes, its holy stair and its Loretto-house. Amongst the new buildings are the hall of the provincial diet, opened in 1881; a handsome new synagogue; the national museum of Moravia and Silesia and several high educational establishments, including a technical academy and a theological seminary, which are the remnants of the former university of Brünn. It is the seat of a Roman Catholic bishop and of a Protestant consistory. Brünn, which is sometimes styled "the Austrian Manchester," is one of the most industrial towns of Austria and the chief seat of the cloth industry in the whole empire. Other important branches of industry are: the manufacture of various woollen, cotton and silk goods, leather, the machinery required in the textile factories, brewing, distilling and milling, and the production of sugar, oil, gloves and hardware. It is also an important railway junction and carries on a very active trade.

Brünn probably dates from the 9th century. In the 11th century it was bestowed by Duke Wratislav II. on his son Otto. A place of great strength, it held out successfully against sieges—in 1428 by the Hussites, in 1467 by King George of Bohemia, in 1645 by the Swedish general Torstenson, and in 1742 by the Prussians. In 1805 it was the headquarters of Napoleon before the battle of Austerlitz.

See Trautenberger, *Die Chronik der Landeshauptstadt Brünn* (Brünn, 1893-1897, 5 vols.).

BRUNNER, HENRY (1840-), German historian, was born at Wels in Upper Austria on the 22nd of June 1840. After studying at the universities of Vienna, Göttingen and Berlin, he became professor at the university of Lemberg in 1866, and in quick succession held similar positions at Prague, Strassburg and Berlin. From 1872 Brunner devoted himself especially to studying the early laws and institutions of the Franks and kindred peoples of western Europe, and on these subjects his researches have been of supreme value. He also became a leading authority on modern German law. He became a member of the Berlin Academy of Sciences in 1884, and in 1886, after the death of G. Waitz, undertook the supervision of the *Leges* section of the *Monumenta Germaniae historica*. His chief works are: *Die Entstehung der Schwurgerichte* (Berlin, 1872); *Zeugen und Inquisitionsbeweis der karolingischen Zeit* (Vienna, 1866); *Das englonormännische Erbsolgersystem, nebst einem Excurs über die älteren normännischen Coutumes* (Leipzig, 1869); *Zur Rechtsgeschichte der römischen und germanischen Urkunde* (Berlin, 1880); *Deutsche Rechtsgeschichte* (Leipzig, 1887-1892); *Mithio und Sperantia* (Berlin, 1885); *Die Landeskronen der Merowinger und Agilolfinger* (Berlin, 1885); *Das Gerichtsurtheil und die fränkische Königsurkunde* (Berlin, 1873); *Forschungen zur Geschichte des deutschen und französischen Rechts* (Stuttgart, 1894); *Grundzüge der deutschen Rechtsgeschichte* (Leipzig, 1901).

BRÜNNOW, FRANZ FRIEDRICH ERNST (1821-1891), German astronomer, was born in Berlin on the 18th of November 1821. Between the ages of eight and eighteen he attended the Friedrich-Wilhelm gymnasium. In 1839 he entered the university of Berlin, where he studied mathematics, astronomy and physics, as well as chemistry, philosophy and philology. After graduating as Ph.D. in 1843, he took an active part in

astronomical work at the Berlin observatory, under the direction of J. F. Encke, contributing numerous important papers on the orbits of comets and minor planets to the *Astronomische Nachrichten*. In 1847 he was appointed director of the Bilk observatory, near Düsseldorf, and in the following year published the well-known *Mémoire sur la comète elliptique de De Vico*, for which he received the gold medal of the Amsterdam Academy. In 1851 he succeeded J. G. Galle as first assistant at the Berlin observatory, and accepted in 1854 the post of director of the new observatory at Ann Arbor, Michigan, U.S.A. Here he published, 1858-1862, a journal entitled *Astronomical Notices*, while his tables of the minor planets Flora, Victoria and Iris were severally issued in 1857, 1859 and 1869. In 1860 he went, as associate director of the observatory, to Albany, N. Y.; but returned in 1861 to Michigan, and threw himself with vigour into the work of studying the astronomical and physical constants of the observatory and its instruments. In 1863 he resigned its direction and returned to Germany; then, on the death of Sir W. R. Hamilton in 1865, he accepted the post of Andrews professor of astronomy in the university of Dublin and astronomer-royal of Ireland. His first undertaking at the Dublin observatory was the erection of an equatorial telescope to carry the fine object-glass presented to the university by Sir James South; and on its completion he began an important series of researches on stellar parallax. The first, second and third parts of the *Astronomical Observations and Researches made at Dunsink* contain the results of these labours, and include discussions of the distances of the stars α Lyrae, σ Draconis, Groombridge 1830, 85 Pegasi, and Bradley 3077, and of the planetary nebula H. iv. 37. In 1873 the observatory, on Dr Brünnow's recommendation, was provided with a first-class transit-circle, which he proceeded to test as a preliminary to commencing an extended programme of work with it, but in the following year, in consequence of failing health and eyesight, he resigned the post and retired to Basel. In 1880 he removed to Vevey, and in 1889 to Heidelberg, where he died on the 20th of August 1891. The permanence of his reputation was secured by the merits of his *Lehrbuch der sphärischen Astronomie*, which were at once widely appreciated. In 1869 part i. was translated into English by Robert Main, the Radcliffe observer at Oxford; Brünnow himself published an English version in 1865; it reached in the original a 5th edition in 1881, and was also translated into French, Russian, Italian and Spanish.

See *Month. Notices Roy. Astr. Society*, iii. 230; J. C. Poggendorff's *Biog. Lit. Handwörterbuch*, Bd. iii.; *Nature*, xiv. 449.

BRUNO, SAINT, founder of the Carthusians, was born in Cologne about 1030; he was educated there and afterwards at Reims and Tours, where he studied under Berengar. He was ordained at Cologne, and thence, in 1057, he was recalled to Reims to become *scholasticus*, or head of the cathedral school, and overseer of the schools of the diocese. He was made also canon and diocesan chancellor. Having protested against the misdoings of a new archbishop, he was deprived of all his offices and had to fly for safety (1076). On the deposition of the archbishop in 1080, Bruno was presented by the ecclesiastical authorities to the pope for the see, but Philip I. of France successfully opposed the appointment. After this Bruno left Reims and retired, with six companions, to a desert among the mountains near Grenoble, and there founded the Carthusian order (1084). After six years Urban II. called him to Rome and offered him the archbishopric of Reggio; but he refused it, and withdrew to a desert in Calabria, where he established two other monasteries, and died in 1101. He wrote Commentaries on the Psalms and the Pauline Epistles, to be found in Migne, *Patr. Lat.* clii. and cliii.; some works by namesakes have been attributed to him.

His Life will be found in the Bollandists' *Acta Sanctorum* (6th of October). The best study on St Bruno's life and works is Hermann Löbel, *Der Stifter des Karthäuser-Ordens*, 1899 (vol. v. No. 1 of "Kirchengeschichtliche Studien," Münster).

BRUNO, or **BRUN** (925-965), archbishop of Cologne, third son of the German king, Henry I., the Fowler, by his second wife Matilda, was educated for the church at Utrecht, where he

distinguished himself by his studious zeal. In 1540 his brother, King Otto, afterwards the emperor Otto the Great, appointed him chancellor, and some years later arch-chaplain, and under his leadership the chancery was reformed and became a training ground for capable administrators. He rendered valuable assistance to his brother Otto in his efforts to suppress the risings which marked the earlier part of his reign, services which were rewarded in 1553 when Bruno was made archbishop of Cologne, and about the same time duke of Lorraine. Bruno is chiefly renowned as a scholar and a patron of learning. He consorted eagerly with learned foreigners, tried to secure a better education for the clergy, and was mainly instrumental in making his brother's court a centre of intellectual life. He built many churches, and, aided by the tendency of the time, sought to purify monastic life. He died at Reims on the 11th of October 1600, and was buried in the church of St Pantaleon at Cologne.

See Ruotger, "Vita Brunonis archiepiscopi Coloniensis," in the *Monumenta Germaniae Historica, Scriptores*, Band iv. (Hanover and Berlin, 1826-1892); E. Meyer, *De Brunone I. Archiepiscopo Coloniensi* (Berlin, 1867); J. P. Pfeiffer, *Historisch-Kritische Beiträge zur Geschichte Brunos I.* (Cologne, 1870); K. Martin, *Beiträge zur Geschichte Brunos I. von Köln* (Jena, 1878).

BRUNO, GIORDANO (c. 1548-1600), Italian philosopher of the Renaissance, was born near Nola in the village of Cicala. Little is known of his life. He was christened Filippo, and took the name Giordano only on entering a religious order. In his fifteenth year he entered the order of the Dominicans at Naples, and is said to have composed a treatise on the ark of Noah. Why he submitted to a discipline palpably unsuited to his fiery spirit we cannot tell. In consequence of his views on transubstantiation and the immaculate conception he was accused of impiety, and after enduring persecution for some years, he fled from Rome about 1576, and wandered through various cities, reaching Geneva in 1579. The home of Calvinism was no resting-place for him (T. Dufour, *Giordano Bruno à Genève*, Geneva, 1884), and he travelled on through Lyons, Toulouse and Montpellier, arriving at Paris in 1581. Everywhere he bent his energies to the exposition of the new thoughts which were beginning to effect a revolution in the thinking world. He had drunk deeply of the spirit of the Renaissance, the determination to see for himself the noble universe, unclouded by the mists of authoritative philosophy and church tradition. The discoveries of Copernicus were eagerly accepted by him, and he used them as the lever by which to push aside the antiquated system that had come down from Aristotle, for whom, indeed, he had a perfect hatred. Like Bacon and Telesio he preferred the older Greek philosophers, who had looked at nature for themselves, and whose speculations had more of reality in them. He had read widely and deeply, and in his own writings we come across many expressions familiar to us in earlier systems. Yet his philosophy is no eclecticism. He owed something to Lucretius, something to the Stoic nature-panteism, something to Anaxagoras, to Heraclitus, to the Pythagoreans, and to the Neoplatonists, who were partially known to him; above all, he was a profound student of Nicolas of Cusa, who was indeed a speculative Copernicus. But his own system has a distinct unity and originality; it breathes throughout the fiery spirit of Bruno himself.

Bruno had been well received at Toulouse, where he had lectured on astronomy; even better fortune awaited him at Paris, especially at the hands of Henry III. He was offered a chair of philosophy, provided he would receive the Mass. He at once refused, but was permitted to deliver lectures. These seem to have been altogether devoted to expositions of a certain logical system which Bruno had taken up with great eagerness, the *Ars Magna* of Raimon Lull. With the exception of a satiric comedy, *Il Candelaio*, all the works of this period are devoted to this logic—*De Umbris Idearum*, *Ars Memoriae*, *De compendiosa architectura et complemento artis Lullii*, and *Cantus Circaeus*. To many it has seemed a curious freak of Bruno's that he should have so eagerly adopted a view of thought like that of Lull, but in reality it is in strict accordance with the principles of his philosophy. Like the Arabian logicians, and some of the scholastics, who held that ideas existed in a threefold form—*ante res, in rebus*

and *post res*—he laid down the principle that the archetypal ideas existed metaphysically in the ultimate unity or intelligence, physically in the world of things, and logically in signs, symbols or notions. These notions were shadows of the ideas, and the *Ars Magna* furnished him with a general scheme, according to which their relations and correspondences should be exhibited. It supplied not only a *memoria technica*, but an *organon*, or method by which the genesis of all ideas from unity might be represented intelligibly and easily. It provided also a substitute for either the Aristotelian or the Ramist logic, which was an additional element in its favour.

Under the protection of the French ambassador, Michel de Castelneau, sieur de Mauvissière, Bruno passed over in 1583 to England, where he resided for about two years. He was disgusted with the brutality of English manners, which he paints in no flattering colours, and he found pedantry and superstition as rampant in Oxford as in Geneva. Indeed, there still existed on the statute a provision that "Masters and Bachelors who did not follow Aristotle faithfully were liable to a fine of five shillings for every point of divergence, and for every fault committed against the logic of the Organon." But he indulges in extravagant eulogies of Elizabeth. He is generally said to have formed the acquaintance of Sir Philip Sidney, Fulke Greville and other eminent Englishmen, but there has been much controversy as to the facts of his life in London. It seems probable that he lived in the French embassy in some secretarial or tutorial position. He may conceivably have met Bacon, but it is quite incredible that he met Shakespeare in the printing shop of Thomas Vautroller. In Oxford he was allowed to hold a disputation with some learned doctors on the rival merits of the Copernican and so-called Aristotelian systems of the universe, and, according to his own report, had an easy victory. The best of his works were written in the freedom of English social life. The *Cena de la Ceneri*, or Ash Wednesday conversation, devoted to an exposition of the Copernican theory, was printed in 1584. In the same year appeared his two great metaphysical works, *De la Causa, Principio, ed Uno*, and *De l'Infinito, Universo, e Mondi*; in the year following the *Heroici Furori* and *Cabala del Cavallo Pegaseo*. In 1584 also appeared the strange dialogue, *Spaccio della Bestia Trionfante* (*Expulsion of the Triumphant Beast*), an allegory treating chiefly of moral philosophy, but giving the essence of Bruno's philosophy. The gods are represented as resolving to banish from the heavens the constellations, which served to remind them of their evil deeds. In their places are put the moral virtues. The first of the three dialogues contains the substance of the allegory, which, under the disguise of an assault on heathen mythology, is a direct attack on all forms of anthropomorphic religion. But in a philosophical point of view the first part of the second dialogue is the most important. Among the moral virtues which take the place of the beasts are Truth, Prudence, Wisdom, Law and Universal Judgment, and in the explanation of what these mean Bruno unfolds the inner essence of his system. Truth is the unity and substance which underlies all things; Prudence or Providence is the regulating power of truth, and comprehends both liberty and necessity; Wisdom is providence itself in its supersensible aspect—in man it is reason which grasps the truth of things; Law results from wisdom, for no good law is irrational, and its sole end and aim is the good of mankind; Universal Judgment is the principle whereby men are judged according to their deeds, and not according to their belief in this or that catechism. Mingled with his allegorical philosophy are the most vehement attacks upon the established religion. The monks are stigmatized as pedants who would destroy the joy of life on earth, who are avaricious, dissolute and the breeders of eternal dissensions and squabbles. The mysteries of faith are scoffed at. The Jewish records are put on a level with the Greek myths, and miracles are laughed at as magical tricks. Through all this runs the train of thought resulting naturally from Bruno's fundamental principles, and familiar in modern philosophy as Spinozism, the denial of particular providence, the doctrine of the uselessness of prayer, the identification in a sense of liberty and necessity, and the peculiar definition of good and evil.

In 1585-1586 he returned with Castelnau to Paris, where his anti-Aristotelian views were taken up by the college of Cambrai, but was soon driven from his refuge, and we next find him at Marburg and Wittenberg, the headquarters of Lutheranism. There is a tradition that here or in England he embraced the Protestant faith; nothing in his writings would lead one to suppose so. Several works, chiefly logical, appeared during his stay at Wittenberg (*De Lampade combinatoria Lulliana*, 1587, and *De Progressu et Lampade venatoria logicorum*, 1587). In 1588 he went to Prague, then to Helmstadt. In 1591 he was at Frankfurt, and published three important metaphysical works, *De Triplici Mismo et Mensura*; *De Monade, Numero, et Figura*; *De Immenso et Innumerabilibus*. He did not stay long at Prague, and we find him next at Zürich, whence he accepted an invitation to Venice from a young patrician, Giovanni Mocenigo. It was a rash step. The emissaries of the Inquisition were on his track; he was thrown into prison, and in 1593 was brought to Rome. Seven years were spent in confinement. On the 9th of February 1600 he was excommunicated, and on the 17th was burned at the stake.

For more than two centuries Bruno received scarcely the consideration he deserved. On the 9th of June 1880, however, as a result of a strong popular movement, a statue to him was unveiled in Rome in the Campo dei Fiori, the place of his execution.

To Bruno, as to all great thinkers, philosophy is the search for unity. Amid all the varying and contradictory phenomena of the universe there is something which gives coherence and intelligibility to them. Nor can this unity be something apart from the things; it must contain in itself the universe, which develops from it; it must be at once all and one. This unity is God, the universal substance,—the one and only principle, or *causa immanens*,—that which is in things and yet is distinct from them as the universal is distinct from the particular. He is the efficient and final cause of all, the beginning, middle, and end, eternal and infinite. By his action the world is produced, and his action is the law of his nature, his necessity is true freedom. He is living, active intelligence, the principle of motion and creation, realizing himself in the infinitely various forms of activity that constitute individual things. To the infinitely actual there is necessary the possible; that which determines involves somewhat in which its determinations can have existence. This other of God, which is in truth one with him, is matter. The universe, then, is a living cosmos, an infinitely animated system, whose end is the perfect realization of the variously graduated forms. The unity which sunders itself into the multiplicity of things may be called the *monas monadum*, each thing being a *monas* or self-existent, living being, a universe in itself. Of these monads the number is infinite. The soul of man is a thinking monad, and stands mid-way between the divine intelligence and the world of external things. As a portion of the divine life, the soul is immortal. Its highest function is the contemplation of the divine unity, discoverable under the manifold of objects.

Such is a brief summary of the principal positions of Bruno's philosophy. It seems quite clear that in the earlier works, particularly the two Italian dialogues, he approached more nearly to the pantheistic view of things than in his later Latin treatises. The unity expounded at first is simply an *anima mundi*, a living universe, but not intelligent. There is a distinct development traceable towards the later and final form of his doctrine, in which the universe appears as the realization of the divine mind.

Bruno's writings had been much neglected when Jacobi brought them into notice in his *Briefve über die Lehre Spinozas* (2nd ed., 1879). Since then many have held that Descartes, Spinoza and Leibnitz were indebted to him for their main principles. So far as Descartes is concerned, it is highly improbable that he had seen any of Bruno's works. Schelling, however, called one of his works after him, *Bruno*.

BIBLIOGRAPHY.—The chief edition of the Latin works is that published at the public expense by F. Fiorentino, F. Tocco and H. Vitelli (Naples, 1879-1891), which superseded that of A. F. Cröner (Stuttgart, 1834, incomplete). The Italian works were collected by A. Wagner (Leipzig, 1830), and a new edition was published by P. de Lagarde (Göttingen, 1889-1889); also *Opere Italiane*, ed. Croce and G. Gentile (1907 foll.), with notes by the latter. In Germany, *Gesammelte Werke*, trans. L. Kühlenbeck (1904 foll.). English translations.—The *Spaccio*, by Morehead, not as has been supposed by J. Toland (dated 1713, but probably printed earlier and very rare); of the preface to *De L' Infinito* (J. Toland in posthumous works); *Eroici Fuores*, L. Williams (1888). There are also French and German translations.

The chief English work on Giordano Bruno is that of J. Lewis M'Intyre (London, 1903), containing life, commentary and bibliography. See also C. Bartholmess, *J. Bruno* (Paris, 1846-1847); Domenico Berti, *Giordano Bruno da Nola* (2nd ed., 1889); H.

Brunnhofe, *Giordano Brunos Weltanschauung* (Leipzig, 1883); M. Carrière, *Philosophische Weltanschauung der Reformationszeit*, pp. 411-494 (2nd ed., 1887); F. J. Clemens, *Giordano Bruno und Nicolaus von Cusa* (Bonn, 1847); Miss I. Frith, *Life and Works of Giordano Bruno* (London, 1884); Chr. Sigwart, in *Kleine Schriften*, 1st series, pp. 49-124, 293-304; A. Riehl, *G. Bruno* (1880, ed. 1900; Eng. trans. Agnes Fry, 1905); Landsbeck, *Bruno, der Märtyrer der neuen Weltanschauung* (1890); Owen, in *Sceptics of the Italian Renaissance* (London, 1893); C. H. von Stein, *G. Bruno* (1900); R. Adamson, *Development of Modern Philosophy* (Edinburgh and London, 1903); G. Louis, *G. Bruno, seine Weltanschauung und Lebensauffassung* (1900); O. Juliusberger, *G. Bruno und die Gegenwart* (1902); J. Reiner, *G. Bruno und seine Weltanschauung* (1907). The most important critical works are perhaps those of Felice Tocco, *Le Opere Latine di Giordano Bruno* (Florence, 1889); *Le Opere Inedite di Giordano Bruno* (Naples, 1891); *Le Fonti più recenti della fioca del Bruno* (Rome, 1892). See also H. Höfding, *History of Modern Philosophy* (Eng. trans. 1900); J. M. Robertson, *Short History of Freethought* (London, 1906); G. Gentile, *Giordano Bruno nella Storia della cultura* (1907). For other works see G. Graziano, *Bibliografia Bruniana* (1900). (R. Ad.; J. M. M.)

BRUNO (BRUN, BRUNS) OF QUERFURT, SAINT (c. 975-1009), German missionary bishop and martyr, belonged to the family of the lords of Querfurt in Saxony. He was educated at the famous cathedral school at Magdeburg, and at the age of twenty was attached to the clerical household of the emperor Otto III. In 996 he accompanied the emperor to Rome, and there gave up his post and entered the monastery of SS. Alexius and Bonifacius on the Aventine, taking "in religion" the name of Bonifacius. When the news reached Rome of the martyrdom of Adalbert, bishop of Prague (997), Bruno determined to take his place, and in 1004, after being consecrated by the pope as archbishop of the eastern heathen, he set out for Germany to seek aid of the emperor Henry II. The emperor, however, being at war with Boleslaus of Poland, opposed his enterprise, and he went first to the court of St Stephen of Hungary, and, finding but slight encouragement there, to that of the grand prince Vladimir at Kiev. He made no effort to win over Vladimir to the Roman obedience, but devoted himself to the conversion of the pagan Pechenegs who inhabited the country between the Don and the Danube. In this he was so far successful that they made peace with the grand prince and were for a while nominally Christians. In 1008 Bruno went to the court of Boleslaus, and, after a vain effort to persuade the emperor to end the war between Germans and Poles, determined at all hazards to proceed with his mission to the Prussians. With eighteen companions he set out; but on the borders of the Russian (Lithuanian) country he and all his company were massacred by the heathens (February 14, 1009).

During his stay in Hungary (1004) Bruno wrote a life of St Adalbert, the best of the three extant biographies of the saint (in Pertz, *Mon. Germ. Hist. Scriptores*, iv. pp. 577, 596-612), described by A. Potthast (*Bibliotheca hist. med. aev.*) as "in the highest degree attractive both in manner and matter."

A life of St Bruno was written by Dietmar, bishop of Merseburg (976-1019). This, with additions from the life of St Romuald, is published in the Bollandist *Acta Sanctorum* (June 19), vi. 1, pp. 223-225. See further U. Chevalier, *Répertoire des sources historiques, Bio-Bibliographie* (Paris, 1904), s.v. "Brunon de Querfurt."

BRUNSBÜTTEL, a seaport town of Germany, in the Prussian province of Schleswig-Holstein, on the N. bank of the Elbe, 60 m. N.W. from Hamburg. Pop. (1905) 2500. Brunsbüttel is the west terminus of the Kaiser Wilhelm Canal, which is closed there by double locks. Here also are an inner harbour, 1640 ft. long and 656 ft. wide, a coaling station, and a small harbour for the tugs and other vessels belonging to the canal company.

BRUNSWICK, KARL WILHELM FERDINAND, DUKE OF (1735-1806), German general, was born on the 9th of October 1735 at Wolfenbüttel. He received an unusually wide and thorough education, and travelled in his youth in Holland, France and various parts of Germany. His first military experience was in the North German campaign of 1757, under the duke of Cumberland. At the battle of Hastenbeck he won great renown by a gallant charge at the head of an infantry brigade;

and upon the capitulation of Kloster Zeven he was easily persuaded by his uncle Ferdinand of Brunswick, who succeeded Cumberland, to continue in the war as a general officer. The exploits of the hereditary prince, as he was called, soon gained him further reputation, and he became an acknowledged master of irregular warfare. In pitched battles, and in particular at Minden and Warburg, he proved himself an excellent subordinate. After the close of the Seven Years' War, the prince visited England with his bride, the daughter of Frederick, prince of Wales, and in 1766 he went to France, being received both by his allies and his late enemies with every token of respect. In Paris he made the acquaintance of Marmontel; in Switzerland, whither he continued his tour, that of Voltaire; and in Rome, where he remained for a long time, he explored the antiquities of the city under the guidance of Winckelmann. After a visit to Naples he returned to Paris, and thence, with his wife, to Brunswick. His services to the dukedom during the next few years were of the greatest value; with the assistance of the minister Féronce von Rotenkreis he rescued the state from the bankruptcy into which the war had brought it. His popularity was unbounded, and when he succeeded his father, Duke Karl I., in 1780, he soon became known as a model to sovereigns. He was perhaps the best representative of the benevolent despot of the 18th century—wise, economical, prudent and kindly. His habitual caution, if it induced him on some occasions to leave reforms uncompleted, at any rate saved him from the failures which marred the efforts of so many liberal princes of his time. He strove to keep his duchy from all foreign entanglements. At the same time he continued to render important services to the king of Prussia, for whom he had fought in the Seven Years' War; he was a Prussian field marshal, and was at pains to make the regiment of which he was colonel a model one, and he was frequently engaged in diplomatic and other state affairs. He resembled his uncle Frederick the Great in many ways, but he lacked the supreme resolution of the king, and in civil as in military affairs was prone to excessive caution. As an enthusiastic adherent of the Germanic and anti-Austrian policy of Prussia he joined the *Fürstenbund*, in which, as he now had the reputation of being the best soldier of his time, he was the destined commander-in-chief of the federal army.

Between 1763 and 1787 his only military service had been in the brief War of the Bavarian Succession; in the latter year, however, the duke, as a Prussian field marshal, led the army which invaded Holland. His success was rapid, complete and almost bloodless, and in the eyes of contemporaries the campaign appeared as an example of perfect generalship. Five years later Brunswick was appointed to the command of the allied Austrian and German army assembled to invade France and crush the Revolution. In this task he knew that he must encounter more than a formal resistance. He was so far in acknowledged sympathy with French hopes of reform, that when he gave an asylum in his duchy to the "comte de Lille" (Louis XVIII.) the revolutionary government made no protest. Indeed, earlier in this year (1792) he had been offered supreme command of the French army. As the king of Prussia took the field with Brunswick's army, the duke felt bound as a soldier to treat his wishes as actual orders. (For the events of the Valmy campaign see FRENCH REVOLUTIONARY WARS.) The result of Brunswick's cautious advance on Paris was the cannonade of Valmy followed by the retreat of the allies. The following campaign of 1793 showed him perhaps at his best as a careful and exact general; even the fiery Hoche, with the "nation in arms" behind him, failed to make any impression on the veteran leader of the allies. But difficulties and disagreements at headquarters multiplied, and when Brunswick found himself unable to move or direct his army without interference from the king, he laid down his command and returned to govern his duchy. He did not, however, withdraw entirely from Prussian service, and in 1803 he carried out a successful and diplomatic mission to Russia. In 1806, at the personal request of Queen Louise of Prussia, he consented to command the Prussian army, but here again the presence of the king of Prussia

and the conflicting views of numerous advisers of high rank proved fatal. At the battle of Austerlitz the old duke was mortally wounded. Carried for nearly a month in the midst of the routed Prussian army he died at last on the 10th of November 1806 at Ottensen near Hamburg.

His son and successor, FRIEDRICH WILHELM (1771-1815), who was one of the bitterest opponents of Napoleonic domination in Germany, took part in the war of 1800 at the head of a corps of partisans; fled to England after the battle of Wagram, and returned to Brunswick in 1813, where he raised fresh troops. He was killed at the battle of Quatre Bras on the 16th of June 1815.

See Lord Fitzmaurice, *Charles W. F., duke of Brunswick* (London, 1901); memoir in *Allgemeine deutsche Biographie*, vol. ii. (Leipzig, 1882); and, for an interesting sketch of his military character, A. Chuquet, *Les Guerres de la Révolution—La Première Invasion prussienne* (Paris, n.d.).

BRUNSWICK, a city and the county-seat of Glynn county, Georgia, U.S.A., and a port of entry, on St Simon Sound, about 12 m. from the Atlantic Ocean, and about 100 m. S. of Savannah. Pop. (1890) 8450; (1900) 9081, of whom 5184 were of negro descent; (1910 U.S. census) 10,182. It is one of the seaports of Georgia, the Federal government having dredged a channel in the inner harbour 21 ft. deep at mean low water and a channel across the outer bar 19.3 ft. deep at mean low water—there is a rise of 7.2 ft. at high tide. St Simon Island and Jekyll Island (a winter resort of wealthy men), lying between the ocean and the mainland, protect the harbour. The city is served by the Southern, the Atlanta, Birmingham & Atlantic, and the Atlantic Coast Line railways; it is also connected by lines of steamboats with various ports along the coast, including New York and Boston. Brunswick's growth has been retarded by the successful rivalry of other cities, notably Savannah; but it has a considerable export trade, principally in lumber, cross-ties and naval stores—its exports were valued at \$13,387,838 in 1908—and various manufacturing, including planing mills, cooperage works and oyster canneries. It was settled about 1772, and received a city charter in 1856.

BRUNSWICK (Ger. *Braunschweig*), a sovereign duchy of northern Germany, and a constituent state of the German empire, comprising three larger and six smaller portions of territory. The principal or northern part, containing the towns of Brunswick, Wolfenbüttel and Helmstedt, is situated between the Prussian provinces of Hanover and Saxony to the south-east of the former. The western part, containing Holzminde and Gandersheim, extends eastward from the river Weser to Goslar. The Blankenburg, or eastern portion, lies to the south-east of the two former, between Prussia, the duchy of Anhalt and the Prussian province of Hanover. The six small enclaves, lying in the Prussian provinces of Hanover and Saxony, are the districts Thedinghausen, Harzburg and Kalvörde, and the three demesnes of Bodenburg, Olsburg and Ostharingen. A portion of the Harz mountains was, down to 1874, common to Brunswick and Prussia (Hanover) and known as the Communion Harz. In 1874 a partition was effected, but the mines are still worked in common, four-sevenths of the revenues derived from them falling to Prussia and the remaining three-sevenths to Brunswick.

The northern portion of the duchy has its surface diversified by hill and plain, it is mostly arable and has little forest. The other two principal portions are intersected by the Harz mountains, and its spurs and the higher parts are covered with forests of fir, oak and beech. The greatest elevations are the Wurmberg (3230 ft.), and the Achtermannshöhe (3100 ft.), lying south of the Brocken. Brunswick belongs almost entirely to the basin of the river Weser, into which the Oker, the Aller and the Leine, having their sources in the Harz, discharge their waters. The climate is mild in the north, but in the hilly country raw and cold in winter, and in autumn and spring damp. The area of the duchy is 1424 sq. m., and of this total fully one-half is arable land, 10% meadow and pasture, and 33% under forest. The population in 1905 was 485,655. The religion is, in the main, that of the Lutheran Evangelical church; but there is a large Roman Catholic community centred in and round Hildesheim,

the seat of the bishopric of North Germany. The Jews have several synagogues, with a rabbinate in Brunswick. The birth-rate is 35.3, and the death-rate 21.6 per thousand inhabitants. In the rural districts, broad Low German is spoken; but the language of the upper and educated classes is distinguished by its purity of style and pronunciation.

The land devoted to agriculture is excellently farmed, and cereals, beet (for sugar), potatoes and garden produce of all kinds, particularly fruit, obtain the best market prices. The pasture land rears cattle and sheep of first-rate quality, and great attention is paid to the breeding of horses, in which the famous stud farm at Harzburg has of late years been eminently conspicuous. Timber cutting, in the forests of the Harz, employs a large number of hands. But agriculture, which, until recently, formed the chief wealth of the duchy, has now given way to the mining industry, both in point of the numbers of inhabitants employed and in the general prosperity distributed by it. The chief seat of the mining industry is the Harz, and its development annually increases in extent and importance. Coal (bituminous), iron, lead, copper, sulphur, alum, marble, alabaster, lime and salt are produced in large quantities, and the by-products of some of these, particularly chemicals and asphalt, constitute a great source of revenue. The manufactures embrace sugar (from beet), spinning, tobacco, paper, soap machines, glass, china, beer and sausages. The last are famous throughout Germany. The principal articles of export are thread, dyes, cement, chicory, beer, timber, preserves, chemicals and sausages. The railways, formerly belonging to the state, were, in 1870, leased to private companies and in 1884 purchased by Prussia, and have a length of about 330 m. The roads, of which one quarter are in the hands of the state, are excellently kept, and vie with those of any European country.

The constitution is that of a limited monarchy, and dates from a revision of the fundamental law on the 12th of October 1832. The throne is hereditary in the house of Brunswick-Lüneburg, according to the law of primogeniture, and in the male line of succession, but the rightful heir, Ernest, duke of Cumberland, was not allowed to take possession. The parliament of the duchy (*Landes- or Ständesammlung*) is an assembly of estates forming one house of 48 deputies, of whom 30 are elected by municipal and rural communities, while the remainder represent the Evangelical church, the large landed proprietors, manufacturers and the professions. The house, however, has little power in initiating legislation, but it can refuse taxation, impeach ministers and receive petitions. The executive functions of the administration and government reside in the ministry (*Staatsministerium*) consisting of three responsible ministers, assisted by a council of the holders of the other chief offices of state. The public debt amounts to about 3½ millions sterling, and the civil list to about £56,000 a year, mostly derived from the revenues of the state domains. By virtue of a convention with Prussia, of March 1886, the Brunswick contingent to the imperial forces forms a part of the Prussian army and is attached to the X. army corps. The convention can be rescinded only after a two years' notice.

History.—The lands which comprise the modern duchy of Brunswick belonged in the 10th century to the family of the Brunos, whence the name Brunswick is derived, of the counts of Nordheim, and the counts of Supplinburg. Inherited during the 12th century by Henry the Proud, duke of Saxony and Bavaria, and a member of the family of Welf, they subsequently formed part of the extensive Saxon duchy ruled by his son, Henry the Lion.

When Henry was placed under the imperial ban and his duchy dismembered in 1181, he was allowed to retain his hereditary possessions, which consisted of a large part of Brunswick and Lüneburg. The bulk of these lands came subsequently to Henry's grandson, Otto, and in 1235 the emperor Frederick II., anxious to be reconciled with the Welfs, recognized Otto's title and created him duke of Brunswick and Lüneburg. Otto added several counties and the town of Hanover to his possessions, and when he died in 1252 was succeeded by his sons Albert and

John. In 1267 these princes divided the duchy, Albert becoming duke of Brunswick, and John duke of Lüneburg. The dukes of Lüneburg increased the area of their duchy, and when the family died out in 1369 a stubborn contest took place for its possession. Claimed by Magnus II., duke of Brunswick-Wolfenbüttel, this prince was forced by the emperor Charles IV. to abandon his pretensions, but in 1388 his sons succeeded in incorporating Lüneburg with Brunswick-Wolfenbüttel. In 1285 the duchy of Brunswick had been divided between Duke Albert's three sons, whose relations with each other were far from harmonious, and the lines of Wolfenbüttel, Göttingen and Grubenhagen had been established. The Wolfenbüttel branch died out in 1292, but was refounded in 1345 by Magnus I., a younger member of the Göttingen family; the elder Göttingen branch died out in 1463, and the Grubenhagen branch in 1596. Magnus I., duke of Brunswick-Wolfenbüttel from 1345 to 1369, was the ancestor of the later dukes of Brunswick. His grandsons, Frederick, Bernard and Henry, secured Lüneburg in 1388, but in 1428 Bernard, the only survivor of the three, was forced to make a division of the duchy, by which he received Lüneburg, while his nephews, William and Henry, obtained Brunswick, which in 1432 they divided into Calenberg and Wolfenbüttel. In 1473, however, William, who had added Göttingen to his possessions in 1463, united these lands; but they were again divided from 1495 to 1584. In 1584 Brunswick was united by Duke Julius, and in 1596 Grubenhagen was added to it. Duke Frederick Ulrich, however, was obliged to cede this territory to Lüneburg in 1617, and when he died in 1634 his family became extinct, and Brunswick was divided between the two branches of the Lüneburg family.

The duchy of Lüneburg, founded by Bernard in 1428, remained undivided until 1520, when Duke Henry abdicated and his three sons divided the duchy. Two of the branches, founded at this time soon died out; and in 1569, after the death of Ernest I., the representative of the third branch, his two sons agreed upon a partition which is of considerable importance in the history of Brunswick, since it established the lines of Dannenberg and of Lüneburg-Celle, and these two families divided the duchy of Brunswick-Wolfenbüttel in 1635. The dukes of Lüneburg-Celle subsequently took the name of Hanover, and were the ancestors of the later kings of Hanover (*q.v.*). After the acquisition of 1635 the family of Dannenberg took the title of Brunswick-Wolfenbüttel, and ruled in the direct line until 1735. It was then followed by the family of Brunswick-Bevern, which had split off from the parent line in 1666 and ruled until 1884.

Brunswick had not played a very important part in German politics. Many counties were added to its area, but it was weakened by constant divisions of territory, and during the period of the Reformation some of the princes took one side and some the other. The treaty of Westphalia in 1648 made little difference to its prestige, but its subsequent position was greatly affected by the growth of Prussia. During the Seven Years' War Brunswick supported Frederick the Great, and in return was severely ravaged by the French. Duke Charles I., who accumulated a large amount of debt, sought to discharge his liabilities by sending his soldiers as mercenaries to assist England during the American War of Independence. The succeeding duke, Charles William Ferdinand, brought order into the finances, led the Prussian troops against Napoleon, and died in 1806 from wounds received at the battle of Auerstadt. Napoleon then declared the ducal family deposed and included Brunswick in the kingdom of Westphalia. In 1813 it was restored to Duke Frederick William, who was killed in 1815 at the battle of Quatre Bras. His son, Charles II., while a minor, was under the regency of George, afterwards the English king George IV., who ruled the duchy through Ernest, Count Münster-Ledenburg (1766-1830), assisted by Justus von Schmidt-Philseideck (1769-1851). A new constitution was granted in 1820, but after Charles came of age in 1823 a period of disorder ensued. The duke, who was very unpopular with his subjects, quarrelled with his relatives, and in 1830 a revolution drove him from the country. The government was undertaken by his brother William, and in

1831 Charles was declared incapable of ruling, and William was appointed as his successor. The ex-duke, who made a fine collection of diamonds, died childless at Geneva in August 1873. William's long reign witnessed many excellent and necessary reforms. A new constitution was granted in 1832, and in 1844 Brunswick joined the Prussian Zollverein. Trial by jury and freedom of the press were established, many religious disabilities were removed, and measures were taken towards the freedom of trade.

Brunswick took very little part in the war between Prussia and Austria in 1866, but her troops fought for Prussia during the Franco-German War of 1870-71. The duchy joined the German Confederation in 1815, the North German Confederation in 1866, and became a state of the German empire in 1871.

In 1866 the question of the succession to Brunswick became acute. Duke William was unmarried, and according to the existing conventions it would pass to George, king of Hanover, who had just been deprived of his kingdom by the king of Prussia. In 1879, however, the duke and the estates, with the active support of Prussia, concluded an arrangement for a temporary council of regency to take over the government on William's death. Moreover, if in this event the rightful heir was unable to take possession of the duchy, the council was empowered to appoint a regent. William died on the 18th of October 1884, and George's son, Ernest, duke of Cumberland, claimed Brunswick and promised to respect the German constitution. This claim was disregarded by the council of regency, and the Bundesrat declared that the accession of the duke of Cumberland would be inimical to the peace and security of the empire on account of his attitude towards Prussia. In the following year the council chose Albert, prince of Prussia, as regent, a step which brought Brunswick still more under the influence of her powerful neighbour. Albert died in September 1906, and after some futile negotiations with the duke of Cumberland, the Brunswick diet chose Duke John Albert of Mecklenburg-Schwerin (b. 1857) as regent in May 1907.

See O. von Heinemann, *Geschichte Braunschweigs und Hannovers* (Gotha, 1882-1892); W. Havemann, *Geschichte der Lande Braunschweig und Lüneburg* (Göttingen, 1853-1857); H. Sudendorf, *Urkundenbuch zur Geschichte der Herzöge von Braunschweig und Lüneburg und ihrer Lande* (Hanover, 1859-1883); H. Guthe, *Die Lande Braunschweig und Hannover* (Hanover, 1890); J. Beste, *Geschichte der braunschweigischen Landeskirche von der Reformation bis auf unsere Tage* (Wolffenbüttel, 1889); A. Köcher, *Geschichte von Hannover und Braunschweig 1648-1714* (Leipzig, 1884).

BRUNSWICK, a city of Germany, capital of the duchy of that name, situated in a fertile and undulating country, on the Oker, 37 m. S.E. from Hanover and 53 N.W. from Magdeburg, on the main line of railway from Berlin. Pop. (1900) 128,226; (1905) 136,423, of which number about 9000 were Roman Catholics and 1000 Jews. Brunswick is an interesting place and retains much of its medieval character. The fortifications which formerly environed it were dismantled in 1797, and have given place to a regular circle of gardens and promenades, which rank among the finest in Germany. Within them lies the old town, with somewhat narrow and crooked streets, remarkable for its numerous ancient houses, with high gables and quaintly carved exteriors. In picturesqueness it vies with Lübeck and Lüneburg among North German towns. Among its churches, the cathedral, St Blasius, or Burgkirche, a Romanesque structure begun by Henry the Lion about 1173 and finished in 1194, is of interest. The chancel is decorated with 12th-century frescoes by Johannes Gallicus, and contains the tombs of the founder and his consort, with beautiful effigies in relief, and also that of the emperor Otto IV. In the vault beneath rest the remains of the Guelphs of the Brunswick line (since 1681). Remarkable among other churches are the Magnikirche (consecrated in 1031; the present edifice being built between the 13th and 15th centuries and restored in 1877); the Martinikirche, with Romanesque towers, originally a Romanesque basilica (1180-1190), enlarged in the 13th century in early Gothic by the addition of vaulted aisles and a choir (1490-1500), and remarkable further for the splendid late Gothic Annenkappelle (1434) and three magnificent portals; the

Katharinenkirche, with a fine tower, begun by Henry the Lion in 1172, added to in 1252 and finished (choir) in 1500; the Brüderkirche (1361-1451, restored 1869-1870), formerly the church of a Franciscan house, the refectory of which (1486) is now used for military stores; the Andreaskirche (1200, 1360-1420), partly transitional, partly late Gothic, with a tower 318 ft. high; and the Aegidienkirche (1278-1434), now used for exhibitions and concerts.

In secular buildings, both ancient and modern, Brunswick is also rich. The most noticeable of these is the town hall (14th and 15th centuries), a gem of Gothic architecture. In front of it is a beautiful Gothic leaden fountain of the early 15th century. Close by the cathedral is the Dankwarderode, a two-storied Romanesque building, erected in 1884 on the site of the ancient citadel of the same name which was destroyed by fire in 1873; the cloth merchants' hall (Gewandhaus) of the 13th century, with a richly ornamented façade in Renaissance style, now occupied by the chamber of commerce; the restored Huneboorstelsche Haus with its curious and beautiful oak carving of the 16th century. The ducal palace is a fine modern structure, erected since 1865, when most of the previous building, which dated only from 1811, was destroyed by fire. The famous Quadriga of Rietschel, which perished at the same time, has been replaced by a copy by Georg Howaldt (1802-1883). The theatre lies on a spacious square close to the ducal gardens, and immediately outside the promenades; to the south is the handsome railway station. Among other numerous buildings of modern erection may be mentioned the new town hall (1895-1900) and the ministry of finance, both in early Gothic style. The scientific and art collections of Brunswick are numerous. The ducal museum contains a rich collection of antique and medieval curiosities, engravings and pictures. There are also a municipal museum, a museum of natural history, a mineralogical collection, a botanical garden and two libraries. The educational and charitable institutions of Brunswick are many. Of the former may be mentioned the Collegium Carolinum, founded in 1745, the technical high school, two gymnasiums and an academy of forestry. Among the latter are a deaf and dumb institution, a blind asylum, an orphanage and various hospitals and infirmaries. A monument, 60 ft. high, to Duke Frederick William, who was slain at Quatre Bras, gives its name to the Monumentplatz. Another to the south-east of the town perpetuates the memory of Schill Ferdinand (1776-1809) and his companions. There are also statues of Franz Abt, the composer, of Lessing and of the astronomer K. F. Gauss.

The industries of the town are considerable. Especially important are the manufacture of machinery, boilers, gasometers, pianos, preserves, chemicals, beer and sausages. Brunswick is also a leading centre of the book trade. The communications between the inner town and the extensive suburbs are maintained by an excellent service of electric tramways.

Brunswick is said to have been founded about 861 by Bruno, son of Duke Ludolf of Saxony, from whom it was named Brunswick (from the Old High German *Wich*, hamlet). Afterwards fortified and improved by Henry the Lion, it became one of the most important cities of northern Germany. For a long time its constitution was rather peculiar, as it consisted of five separate townlets, each with its own walls and gates, its own council and Rathaus—a condition traces of which are still evident. In the 13th century it ranked among the first cities of the Hanseatic League. After this era, however, it declined in prosperity, in consequence of the divisions of territory among the branches of the reigning house, the jealousy of the neighbouring states, the Thirty Years' War, and more recently the French occupation, under which it was assigned to the kingdom of Westphalia. During the time of the Reformation the sympathies of the citizens were with the new teaching, and the city was a member of the League of Schmalkalden. In 1830 it was the scene of a violent revolution, which led to the removal of the reigning duke. In 1834 it attained municipal self-government.

See F. Knoll, *Braunschweig und Umgebung* (1882); Sack, *Kurzgeschichte der Stadt Braunschweig* (1861); and H. Dürre, *Geschichte der Stadt Braunschweig im Mittelalter* (1873).

BRUNSWICK, a village of Cumberland county, Maine, U.S.A., in the township of Brunswick, on the Androscoggin river, 9 m. W. of Bath, and 27 m. N.N.E. of Portland. Pop. of the township (1900) 6806; (1910) 6621; of the village (1900) 5210 (1704 foreign-born); (1910) 5341. Brunswick is served by the Maine Central railway, and by the Lewiston, Brunswick & Bath, and the Portland & Brunswick electric railways. Opposite Brunswick and connected with it by a bridge is the township of Topsham (pop. in 1910, 2016). The village of Brunswick lies only 63 ft. above sea-level, shut within rather narrow bounds by hills or bluffs, from which good views may be obtained of the island-dotted sea and deeply-indented coast to the south and east and of the White Mountains to the west. The river falls in three successive stages for a total distance of 41 ft., furnishing good water-power for paper and cotton mills and other manufactures; the first cotton-mill in Maine was built here about 1809. The settlement of the site of Brunswick was begun by fishermen in 1628 and the place was called Pejepscot; in 1717 Brunswick was constituted a township under its present name by the Massachusetts general court, and in 1739 the township was regularly incorporated. The village was incorporated in 1836.

Brunswick is best known as the seat of Bowdoin College, a small institution of high educational rank. There are eleven buildings on a campus of about 40 acres, 1 m. from the river-bank at the end of the principal village thoroughfare. The chapel (King Chapel, named in honour of William King, the first governor of Maine), built of undressed granite, is of Romanesque style, and has twin towers and spires rising to a height of 120 ft.; the interior walls are beautifully decorated with frescoes and mural paintings. The Walker Art Building (built as a memorial to Theophilus W. Walker) is of Italian Renaissance style, has mural decorations by John la Farge, Elihu Vedder, Abbott H. Thayer and Kenyon Cox, and contains a good collection of paintings and other works of art. Among the paintings, many of which were given by the younger James Bowdoin, are examples of van Dyck, Titian, Poussin and Rembrandt. The library building is of Gothic style, and in 1908 contained 89,000 volumes (including the private library of the younger James Bowdoin). Among the other buildings are an astronomical observatory, a science building, a memorial hall, a gymnasium and three dormitories. The building of the Medical School of Maine (1820), which is a department of the college, is on the same campus. Bowdoin was incorporated by the general court of Massachusetts in 1794, but was not opened until 1802. It was named in honour of James Bowdoin (1726-1790), whose son was a liberal benefactor. The college has been maintained as a non-sectarian institution largely by Congregationalists, and is governed by a board of trustees and a board of overseers. Among the distinguished alumni have been Nathaniel Hawthorne, Franklin Pierce, Henry W. Longfellow, John P. Hale, William P. Fessenden, Melville W. Fuller, and Thomas B. Reed.

BRUNSWICK-BEVERN, AUGUST WILHELM, DUKE OF (1715-1781), Prussian soldier, son of Ernst Ferdinand, duke of Brunswick-Bevern, was born at Brunswick in 1715, and entered the Prussian army in 1731, becoming colonel of an infantry regiment in 1739. He won great distinction at Hohenfriedeberg as a major-general, and was promoted lieutenant-general in 1750. He was one of the most experienced and exact soldiers in the army of Frederick the Great. He commanded a wing in the battle of Lobositz in 1756, and defeated the Austrians under Marshal Konigsegg in a well-fought battle at Reichenberg on the 21st of April 1757. He took part in the battles of Prague and Kolln and the retreat to Görlitz, and subsequently commanded the Prussians left behind by Frederick in the autumn of 1757 when he marched against the French. Bevern conducted a defensive campaign against overwhelming numbers with great skill, but he soon lost the valuable assistance of General Winterfeld, who was killed in a skirmish at Moys; and he was eventually brought to battle and suffered a heavy defeat at Breslau on the 2nd of November. He fell into the hands of the Austrians on the following morning, and remained prisoner for a year. He was made general of infantry in 1759, and on the 11th of August

1762 inflicted a severe defeat at Reichenbach on an Austrian army endeavouring to relieve Schweidnitz. Bevern retired, after the peace of Hubertusburg, to his government of Stettin, where he died in 1781.

BRUNTON, MARY (1778-1818), Scottish novelist, was born on the 1st of November 1778 in the island of Barra, Orkney. She was the daughter of Captain Thomas Balfour of Elwick. At the age of twenty she married Alexander Brunton, minister of Bolton in Haddingtonshire, and afterwards professor of oriental languages at Edinburgh. Mrs Brunton died on the 19th of December 1818. She was the author of two novels, popular in their day, *Self-control* (1810), and *Discipline* (1814; 1832 edition with memoir); and of a posthumous fragment, *Emmeline* (1819).

BRUSA, or **BROUSSA** (anc. *Prusa*), the capital of the Brusa (Khudavendikiar) vilayet of Asia Minor, which includes parts of ancient Mysia, Bithynia, and Phrygia, and extends in a south-easterly direction from Mudania, on the Sea of Marmora, to Afum-Kara-Hissar on the Smyrna-Konia railway. The vilayet is one of the most important in Asiatic Turkey, has great mineral and agricultural wealth, many mineral springs, large forests, and valuable industries. It exports cereals, silk, cotton, opium, tobacco, olive-oil, meerschaum, boracite, &c. The Ismid-Angora and Eakishehr-Konia railways pass through the province. Population of the province, 1,600,000 (Moslems, 1,280,000; Christians, 317,000; Jews, 3000).

The city stretches along the lower slopes of the Mysian Olympus or Keclieh Dagh, occupying a position above the valley of the Nilufer (*Odrysses*) not unlike that of Great Malvern above the vale of the Severn. It is divided by ravines into three quarters, and in the centre, on a bold terrace of rock, stood the ancient *Prusa*. The modern town has clean streets and good roads made by Ahmed Vefyk Pasha when Vali, and it contains mosques and tombs of great historic and architectural interest; the more important are those of the sultans Murad I., Bayezid (Bajazet) I., Mahommed I., and Murad II., 1403-1451, and the Ulu Jami'. The mosques show traces of Byzantine, Persian and Arab influence in their plan, architecture and decorative details. The circular church of St Elias, in which the first two sultans, Osman and Orkhan, were buried, was destroyed by fire and earthquake, and rebuilt by Ahmed Vefyk Pasha. There are in the town an American mission and school, and a British orphanage. Silk-spinning is an important industry, the export of silk in 1902 being valued at £650,000. There are also manufactories of silk stuffs, towels, burnis, carpets, felt prayer-carpets embroidered in silk and gold. The hot iron and sulphur springs near Brusa, varying in temperature from 112° to 178° F., are still much used. The town is connected with its port, Mudania, by a railway and a road. There is a British vice-consul. Pop. 75,000 (Moslems, 40,000; Christians, 33,000; Jews, 2000).

Prusa, founded, it is said, at the suggestion of Hannibal, was for a long time the seat of the Bithynian kings. It continued to flourish under the Roman and Byzantine emperors till the 10th century, when it was captured and destroyed by Saif-addaula of Aleppo. Restored by the Byzantines, it was again taken in 1327 by the Ottomans after a siege of ten years, and continued to be their capital till Murad I. removed to Adrianople. In 1402 it was pillaged by the Tatars; in 1413 it resisted an attack of the Karamanians; in 1512 it fell into the power of Ala ed-Din; and in 1607 it was burnt by the rebellious Kalenderogli. In 1883 it was occupied by the Egyptians under Ibrahim Pasha, and from 1852-1855 afforded an asylum to Abd-el-Kader.

See L. de Laborde, *Voyage de l'Asie Mineure* (Paris, 1838); C. Texier, *Asie Mineure* (Paris, 1839).

BRUSH, GEORGE DE FOREST (1855-), American painter, was born at Shelbyville, Tennessee, on the 28th of September 1855. He was a pupil of J. L. Gérôme at Paris, and became a member of the National Academy of Design, New York. From 1883 onwards, he attracted much attention by his paintings of North American Indians, his "Moose Hunt," "Aztec King" and "Mourning her Brave" achieving great popularity and showing the strong influence of Gérôme. These

were followed by picture portraits; particularly of mother and child, largely suggestive of the work of the Dutch, Flemish and German masters, carefully arranged as to line and mass, and worked out in great detail with consummate technical skill. Several of his paintings have for subject his own children and his wife; one of these is in the Boston Museum of Fine Arts.

BRUSH (from Fr. *brosse*, which, like the English word, means both the undergrowth of a wood and the instrument; if the word in both these meanings is ultimately the same, then the origin is from a bundle of brushwood used as a brush or broom, but this is historically doubtful, and others connect it with the Ger. *Borste*, bristle), an instrument for removing dust or dirt from surfaces or for applying paint, whitewash, &c., composed of a tuft or tufts of some fibrous or flexible material secured to a solid basis or stock. Brushes made of the twigs of trees like the birch and provided with long handles are often called brooms, and the same term is applied to some brushes used in the household for removing dust (e.g. carpet-broom, whisk-broom) but not to those used for applying paint. Among the numerous materials employed for the manufacture of brushes of various kinds are feathers, pig's bristles, the hair of certain animals, whalebone, rubber, split-cane, broom-corn (a variety of sorghum) and coir.

Brushes are of two kinds, simple and compound. The former consist of but one tuft, as hair pencils and painters' tools. The latter have more than one tuft. Brushes with the tufts placed side by side on flat boards, as plasterers' brushes, are called stock-brushes. The single tuft brushes, or pencils for artists, are made of the hair of the camel, badger, goat and other animals for the smaller kind, and pig's bristles for the larger. The hairs for pencils are carefully arranged so as to form a point in the centre, and, when tied together, are passed into the wide end of the quill or metal tube and drawn out at the other end to the extent required. The small ends of the quills, having been previously moistened, contract as they dry and bind the hair. A similar effect is produced with metal tubes by compression. Compound brushes are—first, set or pan-work; second, drawn-work. Of the former, an example is the common house-broom, into the stock of which holes are drilled of the size wanted. The necessary quantity of bristles, hair, or fibre to fill each hole being collected together, the thick ends are dipped into molten cement chiefly composed of pitch, bound round with thread, dipped again, and then set into a hole of the stock with a peculiar twisting motion. In drawn-brushes, of which those for shoes, teeth, nails and clothes are examples, the holes are more neatly bored, and have smaller ones at the top communicating with the back of the brush, through which a bight or loop of wire passes from the back of the stock. Half the number of hairs of fibres needed for the tufts to fill the holes are passed into the bight of the wire, which is then pulled smartly so as to double the hairs and force them into the loop-hole as far as possible. With all brushes, when the holes have been properly filled, the ends of the fibres outside are cut with shears, either to an even length or such form as may be desired. The backs are then covered with veneer or other material to conceal the wire and other crudities of the work. In trepanned brushes the bristles are inserted in holes that do not pass right through the stock, and are secured by threads or wires running in drawholes which are drilled through the stock at right angles to them. The ends of these drawholes are plugged so as to be as inconspicuous as possible, and the method avoids the necessity of a veneer on the back. The Woodbury machine, one of the earliest mechanical devices for the manufacture of brushes, which was invented in America about 1870, produced brushes of this kind. One of the most important purposes to which brushes have been applied is that of sweeping chimneys, and so far back as 1789 John Elin patented an arrangement of brushes for this purpose. Revolving brushes for sweeping rooms were patented in 1811, and the first patent in which they were applied to hair-dressing appears in 1862. Many inventions for sweeping and cleaning roads by means of revolving brushes and other contrivances have been introduced,

one of the first being that of Edmund Henning in 1699 for "a new engine for sweeping the streets of London, or any city or town."

Brushes with tufts formed of steel wire are used for cleaning tubes and flues of steam boilers, for the purpose of removing the scale formed by the products of combustion. Steel-wire brushes are also used for cleaning scale from the interior surfaces of a boiler, and for removing the sand from the surface of a casting. Occasionally such brushes are revolved in a machine, for more convenient use on the article to be cleaned or polished. Snyder's patent elastic clutch or coupling, used for such purposes as coupling up or disconnecting a steam-engine from a line of shafting or dynamo, consists essentially of two disks, the adjacent faces of which are provided, one with a ring of brushes made of flat steel wire, the other with a number of finely serrated teeth. One of the disks is movable longitudinally on its shaft, and with the brushes clear of the serrations the clutch is free. On bringing the disks together, which may be done with the engine running at speed, the elasticity of the brush permits the motion to be imparted gradually and without shock to the standing part, until both rotate and are locked together. These clutches are very powerful, and are capable of transmitting as much as 3000 horse-power.

In dynamo-electric machinery the device used to conduct current into or out of the rotating armature is termed a "brush." There are usually two brushes to each dynamo or motor, and they are placed diametrically opposite, lightly touching the commutator of the armature. It is important that there should be good metallic contact between the brushes and the commutator, and at the same time the frictional resistance resulting from the contact must be a minimum. To effect this result brushes are variously made. A kind of brush frequently used consists of a number of copper wires laid side by side and soldered together at one end, where the brush is held. Brushes are also made of strips of spongy copper cut like a comb, which give a number of bearing points on the commutator. Very good results are obtained from brushes made of copper gauze wound closely until it takes the exterior form of a rectangular block, which is held radially in a spring holder, and bears at the end on the commutator. In place of the gauze block "brushes" of hard carbon blocks are frequently used (see DYNAMO).

BRUSSELS (Fr. *Bruxelles*, Flem. *Brussel*), the capital of the kingdom of Belgium, and of the province of Brabant, situated in 50° 51' N., 4° 22' E., about 70 m. from the sea at Ostend. It occupies the plain or valley of the Senne, and the sides and crest of the hill lying to the east and south-east of that valley. It is now extending over the hills west of the valley, and to the north is the town or commune of Laeken, which is practically part of the city.

Brussels suffered severely in 1695 from the bombardment of the French under Villeroi, who fired into the town with red-hot shot. Sixteen churches and 4000 houses were burnt down, and the historic buildings on the Grand Place were seriously injured, the houses of the Nine Nations on the eastern side being completely destroyed. In 1731 the famous palace of the Netherlands was destroyed by fire, and the only remains of this edifice are some ruined arches and walls in a remote corner of the grounds of the king's palace. The Porte de Hal is the only one of the eight gates in the old wall left standing. It dates from 1381, and is well worth more careful examination than it receives. In the latter half of the 18th century it served as a kind of bastille for political prisoners, and is now used as a museum in which a rather nondescript collection of articles, some from Mexico has been allowed to accumulate. With regard to the fine boulevards of the Upper Town, it may be mentioned that about 1765 they were planted with the double row of lime trees which still constitute their chief ornament by Prince Charles of Lorraine while governing the Netherlands for his sister-in-law, the empress Maria Theresa. The residence of this prince was the palace of William the Silent, before he declared against Spain, and it is now used partly for the royal library, which contains the famous *librairie de Bourgogne*, and partly for the museum

of modern pictures. The only other "hotel" or palace in Brussels is that of the duke d'Arenberg. In the 16th century this was the residence of Count Egmont, but very little of the building of his day remains. In the same street, the rue des Petits Carmes, was the Hôtel Culembourg in which the famous oath of the beggars was taken. It has long been demolished and the new barracks of the Grenadier regiment have been erected on the site.

The only other buildings of importance dating from medieval times are the three churches of Ste Gudule (often erroneously called the cathedral), Notre-Dame des Victoires or Church of the Sablon, and Notre-Dame de la Chapelle, or simply la Chapelle, and the hôtel de ville and the Maison du Roi on the Grand Place. The church of Ste Gudule, also dedicated to St Michael, is built on the side of the hill originally called St Michael's Mount, and now covered by the fashionable quarters which are included under the comprehensive description of the Upper Town. It was begun about the year 1220, and is considered one of the finest specimens left of pointed Gothic. It is said to have been completed in 1273, with the exception of the two towers which were added in the 14th or 15th century. Some of the stained glass is very rich, dating from the 13th to the 15th century. In many of the windows there are figures of leading members of the houses of Burgundy and Habsburg. The curious oak pulpit representing Adam and Eve expelled from the Garden of Eden came originally from the Jesuit church at Louvain, and is considered the masterpiece of Verbruggen. The church of the Sablon is said to have been founded in 1304 by the gild of Crossbowmen to celebrate the battle of Woeringen. In a side chapel is a fine monument to the princely family of Thurn and Taxis, which had the monopoly of the postal service in the old empire. La Chapelle is still older, dating nominally from 1210, the choir and transept being considered to date from about fifty years later. There are some fine monuments, especially one to the duke de Croy who died in 1624. The two churches last named have undergone much renovation both outside and inside.

The Grand Place is by its associations one of the most interesting public squares in Europe. On its flags were fought out many feuds between rival gilds; Egmont and Horn, and many other gallant men whose names have been forgotten, were executed here under the shadow of its ancient buildings, and in more recent times Dumouriez proclaimed the French Republic where the dukes of Brabant and Burgundy were wont to hold their jousts. Apart from its associations the Grand Place contains two of the finest and most ornate buildings not merely in the capital but in Belgium. Of these the hôtel de ville, which is far the larger of the two, occupies the greater part of the south side of the square. Its façade has the disadvantage of having had one half begun about half a century before the other. The older, which is the richer in design, forms the left side of the building and dates from 1410, while the right, less rich and shorter, was begun in 1443. The fine tower, 360 ft. in height, is crowned by the golden copper figure of St Michael, 16 ft. in height, erected here as early as 1454. This tower lies behind the extremity of the left wing of the building. Opposite the town-hall is the smaller but extremely ornate Maison du Roi. This was never a royal residence as the name would seem to imply, but its description appears to have been derived from the fact that it was usually in this building that the royal address was read to the states-general. As this building was almost destroyed by Villeroi's bombardment it possesses no claim to antiquity, indeed the existing building was only completed in 1877. Egmont and Horn were sentenced in the hôtel de ville, and passed their last night in the Maison du Roi.

Among the principal buildings erected in the city during the 18th century are the king's palace and the house of parliament or Palais de la Nation, which face the south and north sides of the park respectively. The palace occupies part of the site covered by the old palace burnt down in 1731, and it was built in the reign of the empress Maria Theresa. It originally consisted of two detached buildings, but in 1826-1827 King William I.

of the Netherlands caused them to be connected. The palace contains two fine rooms used for court ceremonies, and a considerable number of pictures. In 1804 a bill was passed in the chambers for the enlargement and embellishment of the palace. The adjacent buildings, viz. the department of the civil list, formerly the residence of the marquis d'Assche, and the Hôtel de Bellevue, held under a kind of perpetual lease granted by the empress Maria Theresa, were absorbed in the palace, and a new façade was constructed which occupies the entire length of the Place du Palais. At the same time a piece was cut off the park to prevent the undue contraction of the Place by the necessary bringing forward of the palace, and the pits which played a certain part in the revolution of 1830 when the Dutch defended the park for a few days against the Belgians were filled up. The Palais de la Nation was constructed between 1779 and 1783, also during the Austrian period. It was intended for the states-general and government offices. During the French occupation the law courts sat there, and from 1817 to 1830 it was assigned for the sittings of the states-general. It is now divided between the senate and the chamber of representatives. In 1833 the part assigned to the latter was burnt out, and has since been reconstructed. The buildings flanking the chambers and nearer the park are government offices with residences for the ministers attached.

The improvements effected in Brussels during the 19th century were enormous, and completely transformed the city. The removal of the old wall was followed by the creation of the quartier Léopold, and at a later period of the quartier Louis in the Upper Town. In the lower, under the energetic direction of two burgomasters, De Brouckere and Anspach, not less sweeping changes were effected. The Senne was bricked in, and the fine boulevards du Nord, Anspach, Hainaut and Midi took the place of slums. The Bourse and the post-office are two fine modern buildings in this quarter of the city. The Column of the Congress—i.e. of the Belgian representatives who founded the kingdom of Belgium—surmounted by a statue of King Leopold I., was erected in 1850, and in 1866 the foundation-stone was laid of the Palais de Justice, which was not finished till 1883, at a cost of sixty million francs. This edifice, the design of the architect Poelaert, is in the style of Karnak and Nineveh, but surmounted with a dome, and impresses by its grandiose proportions (see ARCHITECTURE, Plate XI. fig. 121). It is well placed on the brow of the hill at the southern extremity of the rue de la Régence (the prolongation of the rue Royale), and can be seen from great distances. In the rue de la Régence are the new picture gallery, a fine building with an exceedingly good collection of pictures, the palace of the count of Flanders, and the garden of the Petit Sablon, which contains statues of Egmont and Horn, and a large number of statuettes representing the various gilds and handicrafts. Immediately above this garden is the Palais d'Arenberg. Perhaps the memorial that attracts the greatest amount of public interest in Brussels is that to the Belgians who were killed during the fighting with the Dutch in September 1830. This has been erected in a little square called the Place des Martyrs, not far from the Monnaie theatre. Outside Brussels at Evere is the chief cemetery, with fine monuments to the British officers killed at Waterloo (removed from the church in that village), to the French soldiers who died on Belgian soil in 1870-71, and another to the Prussians.

Many as were the changes in Brussels during the 19th century, those in progress at its close and at the beginning of the 20th have effected a marked alteration in the town. These have been rendered possible only by the excellent system of electric tramways which have brought districts formerly classed as pure country within reach of the citizens. The construction of the fine Avenue de Louise (1½ m. long) from the Boulevard de Waterloo to the Bois de la Cambre was the first of these efforts to bring the remote suburbs within easy reach, at the same time furnishing an approach to the "bois" of Brussels that might in some degree be compared with the Champs Élysées in Paris. Another avenue of later construction (6½ m. in length) connects the park of the Cinquanteaire with Tervueren. This route is extremely

picturesque, traverses part of the forest of Soignies, and is lined by many fashionable villas and country houses. Other improvements projected in 1908 on the slope of the hill immediately below the Place Royale included the removal of the old tortuous and steep street called the "Montagne de la Cour" to give place to a Mont Des Arts. A little lower down and not far from the university (which occupies the house of the famous cardinal Granelle of the 16th century) a central railway terminus was designed on a vast scale. These improvements connote the obliteration of the insanitary and overcrowded courts and alleys which were to be found between all the main streets, few in number, connecting the upper and the lower towns. The ridge on the west and north-west of the Senne valley never formed part of the town, and it was from it that Villeroi bombarded the city. The suburbs on this ridge, from south to north, are Anderlecht, Molenbeek and Koelberg, and Laeken with its royal château and park forms the northern part of the Brussels conglomeration. Brussels has been growing at such a rapid rate that the inclusion of this ridge, and more particularly at Koelberg, within the town limits, was contemplated in 1908.

The completion of the harbour works, making Brussels a seaport by giving sea-going vessels access thereto, was taken in hand in 1897. The completed work provides for a waterway for steamers drawing 24 ft. by the Willibroek Canal into the Ruppel and the Scheldt. There are steamers plying direct from Brussels to London, and 372 vessels of a total tonnage of 76,000 entered and left the port in 1905. The Willibroek Canal was made in the 16th century, and William I. of the Netherlands is entitled to the credit of having first thought of converting it into a ship canal from Brussels to the Scheldt. Nothing was done, however, in his time to carry out the scheme. The distance from Brussels to the Ruppel is only 20 m., and thus Brussels is only about 33 m. farther from the sea than Antwerp.

In addition to the advantages it enjoys from being the seat of the court and the government, Brussels is the centre of many prosperous industries. The manufactures of lace, carpets and curtains, furniture and carriages may be particularly mentioned, but it is chiefly as a place of residence for the well-to-do that the city has increased in size and population. Schools of all kinds are abundant. At the Ecole Militaire youths are trained nominally for the army, but many go there who intend to enter one of the professions or the public service. This school used to occupy part of the old abbey of the Cambre, situated in a hollow near the bois and the avenue Louise, but owing to its insanitary position it has been removed to a new building near the Cinquantenaire. There is a university, to which admission is easy and where the fees are moderate, and the Conservatoire provides as good musical teaching as can be found in Europe. Music can be enjoyed every day in the year either out of doors or under cover. During the winter and spring the opera continues without a break at the Théâtre de la Monnaie, which may be called the national theatre. Concerts are held frequently, as the Belgians are a musical people. Of late years sport has taken a prominent part in Belgian life. There are athletic institutions, and football is quite a popular game. Horse-racing has also come into vogue, and Boisfort, in the bois, and Groenendael, farther off in the Forêt de Soignies, are fashionable places of reunion for society.

The town of Brussels has a separate administration, which is directed by a burgomaster and sheriffs at the head of a town council, whose headquarters are in the hôtel de ville. In the Brussels agglomeration are nine suburbs or communes, each self-governing with burgomaster and sheriffs located in a Maison Communale. These suburbs (beginning on the north and following the circumference eastward) are Schaerbeek, St Josse-ten-Noode, Etterbeek, Ixelles, St Gilles, Cureghem, Anderlecht, Molenbeek and Koelberg. Laeken, which is really a tenth suburb, is classified as a town. In 1856 the population of Brussels alone was 152,828, and by 1880 it had only increased to 162,498. In 1890 the figures were 176,138; in 1900, 183,686; and in December 1904, 194,106. The great increase has been in the suburbs amounting to nearly 80% in twenty-five years. In 1880 the population of the ten suburbs including Laeken

was 248,079. In 1904 the total was 436,453, thus giving for the whole of Brussels a grand total of 630,649.

History.—The name Brussel seems to have been derived from Broeksele, the village on the marsh or brook, and probably it was the most used point for crossing the Senne on the main Roman and Frank road between Tournai and Cologne. The Senne, a small tributary of the Scheldt, flows through the lower town, but since 1868 it has been covered in, and some of the finest boulevards in the lower town have been constructed over the course of the little river. The name Broeksele is mentioned by the chroniclers in the 8th century, and in the 10th the church of Ste Gudule is said to have been endowed by the emperor Otto I. In the next two centuries Brussels grew in size and importance, and its trade gilds were formed on lines similar to those of Ghent. In 1312 Duke John II. of Brabant granted the citizens their charter, distinguished from others as that of Cortenberg. In 1356 Duke Wenceslas confirmed this charter and also the Golden Bull of the emperor Charles IV. of 1349 by his famous "Joyous Entry" into Louvain, the capital of the duchy. These three deeds or enactments constituted the early constitution of the South Netherlands, which, with one important modification in the time of Charles V., remained intact till the Brabant revolution in the reign of Joseph II. In 1357 Wenceslas ordered a new wall embracing a greater area than the earlier one to be constructed round Brussels, and this was practically intact until after the Belgian revolution in 1830-1831. It took twelve, or, according to others, twenty-two years to build. In 1383 the dukes of Brabant transferred their capital from Louvain to Brussels, although for some time they did not trust themselves out of the strong castle which they had erected at Vilvorde, half-way between the two turbulent cities. During this period the population of Brussels is supposed to have been 50,000, or one-fifth of that of Ghent. In 1420 the gilds of Brussels obtained a further charter recognizing their status as the Nine Nations, a division still existing. Having fixed their seat of government at Brussels the dukes of Brabant proceeded to build a castle and place of residence on the Caudenberg hill, which is practically the site of the Place Royale and the king's palace to-day. This ducal residence, enlarged and embellished by its subsequent occupants, became eventually the famous palace of the Netherlands which witnessed the abdication of Charles V. in 1555, and was destroyed by fire in 1731. In 1430 died Philip, last duke of Brabant as a separate ruler, and the duchy was merged in the possessions of the duke of Burgundy.

In the 17th century Brussels was described (Comte de Ségur, quoting the memoirs of M. de la Serre) as "one of the finest, largest and best-situated cities not only of Brabant but of the whole of Europe. The old quarters which preserve in our time an aspect so singularly picturesque with their sloping and tortuous streets, the fine hotels of darkened stone sculptured in the Spanish fashion, and the magnificence of the Place of the hôtel de ville were buried behind an encinte of walls pierced by eight lofty gates flanked with one hundred and twenty-seven round towers at almost equal distance from each other like the balls of a crown. At a distance of less than a mile was the forest of Soignies with great numbers of stags, red and roe deer, that were hunted on horseback even under the ramparts of the town. On the promenade of the court there circulated in a long file ceaselessly during fashionable hours five or six hundred carriages, the servants in showy liveries. In the numerous churches the music was renowned, the archduke Leopold being passionately given to the art, maintaining at his own cost forty or fifty musicians, the best of Italy and Germany. Under the windows of the palace stretched the same park that we admire to-day, open all the year to privileged persons and twice a year to the public, a park filled with trees of rare essences and the most delicious flowers so artistically disposed, and so refreshing to the eyes, that M. de la Serre declared that if he had seen there an apple tree he would assuredly have taken it for an earthly Paradise." (D. C. B.)

BRUT, BRUTE, or BRUTUS THE TROJAN, a legendary British character, who, according to Geoffrey of Monmouth and others,

was the eponymous hero of Britain. He was reputed to be grandson of Aeneas, and the legend was that he was banished from Italy and made his way to Britain, where he founded New Troy (London). The name is an obvious confusion between Bryt (a Briton) and the classical name Brutus.

For the romance literature of the subject see WACE; and BARBOUR.

BRUTÉ, SIMON WILLIAM GABRIEL (1779-1830), American prelate, first Roman Catholic bishop of the diocese of Vincennes, Indiana, U.S.A., was born at Rennes, France, on the 20th of March 1779, his father, Simon Gabriel Guillaume Bruté de Remur (1729-1786), being superintendent of the crown lands in Brittany. He was educated for the medical profession, but entered the Sulpician Seminary of Paris in November 1803, was ordained priest in 1808, refused the post of chaplain to Napoleon, was professor of theology in the Diocesan Seminary at Rennes in 1808-1810, and in August 1810 settled in Baltimore, Maryland, whither his long general interest in missions, and particularly his acquaintance with Bishop Flaget of Kentucky, had drawn him. After teaching for two years (1810-1812) in Baltimore, he was sent to Mount St Mary's College, Emmitsburg, Maryland, where he remained until 1815, acting both as teacher and as pastor. He next visited France in the interest of American missions, and on his return in November 1815, became president of St Mary's College, Baltimore. In 1818 he resumed his labours at Emmitsburg, and from this time until 1834 he held an almost unparalleled place in the American church, being constantly consulted by clergy throughout the country, besides lecturing, teaching, preaching and caring for his parish. The see of Vincennes was created in 1834; and Bruté, nominated its first bishop and consecrated in the same year, went to France for financial aid, with which he built his cathedral and several useful institutions. Here, too, he was professor of theology in his seminary, teacher in one of his academies, as well as pastor and bishop. Interesting stories are told of the high respect in which he was held by the neighbouring Indians, who called him "chief of the Black robes" and "man of the true prayer." He died in Vincennes, Indiana, on the 26th of June 1830. His great influence on the entire church, his wonderful success in planning, financing, and carrying out necessary ecclesiastical reforms, and the constructive and executive ability he displayed in his diocese, make him one of the foremost Catholic emigrants to the United States. He wrote *Brief Notes* on his experiences in France in 1793, in which he describes state persecution of Catholic priests.

See James Roosevelt Bayley, *The Memoirs of the Rt. Rev. Simon William Gabriel Bruté, First Bishop of Vincennes* (New York, 1861), containing much autobiographical matter.

BRUTII, an ancient tribe of lower Italy. This tribe, called Brutii and Britii in Latin inscriptions, and Βρῦττιοι on Greek coins and by Greek authors, occupied the south-western peninsula of Italy in historical times, the *ager Brutius* (wrongly called *Bruttium*) corresponding almost exactly to the modern Calabria. It was separated from Lucania on the north by a line drawn from the mouth of the river Laus on the west to a point a little south of the river Crathis on the east. To part or the whole of this peninsula the name *Italia* was first applied. In alliance with the Lucanians the Brutii made war on the Greek colonies of the coast and seized on Vibo in 356 B.C., and, though for a time overcome by the Greeks who were aided by Alexander of Epirus and Agathocles of Syracuse, they reasserted their mastery of the town from about the beginning of the 3rd century B.C., and held it until it became a Latin colony at the end of the same century (see *Corp. Inscr. Lat.* x. p. 7, and the references there given). At this time they were speaking Oscan as well as Greek, and two of three Oscan inscriptions in Greek alphabet still testify to the language spoken in the town in the 3rd century B.C. We know, however, that the Bruttians, though at this date speaking the same language (Oscan) as the Samnite tribe of the Lucani, were not actually akin to them. The name *Bruttii* was used by the Lucanians to mean "runaway slaves," but it is considerably more likely that this signification was attached to the tribal name of the Brutii from the historical fact that they had been conquered and expelled by the Samnite invaders (cf. the use of

Zalβου to mean "policemen" at Athens, and still more closely the German, French and English word "slave" derived from "Slav"), than that the tribe when living in territory it could call its own should have adopted an opprobrious name taken from the language of hostile neighbours (see Strabo vi. 1, 4; Diod. Sic. xvi. 15). Mommsen pointed out (*Unterital. Dialekte*, p. 97) the evidence of tradition (especially Aristotle, *Pol.* 4 [7] 10) showing that the customs of the Brutii had a certain affinity with those of the pre-Hellenic inhabitants of Greece, and it has been argued (Ridgeway *apud* Conway, *Ital. Dialects*, p. 16) that a tradition (preserved in Stephanus of Byzantium, s.v. *Xία*) made it probable that they were called *Πάλαροι*. This evidence points to the conjecture that they were part of what is now generally called the Mediterranean race (see, e.g. G. Sergi, *The Mediterranean Race*, Eng. trans., 1901; W. Z. Ripley, *Races of Europe*, p. 128). Many Indo-European elements appear in their place-names (e.g. *Sila* = Latin *silva*, Greek *βλα*; *Temesa*, cf. Gr. *τίμενος* or Sanskrit *tamas*, darkness, shadow), and none that suggest a non-Indo-European origin. *A priori* considerations suggest that they may have been akin to the Siceli, but of this at present no positive evidence can be given.

As we have seen, the Bruttii were at the height of their power during the 3rd century B.C. Their chief towns were Consentia (Cosenza), Petelia (near Strongoli), and Clampetia (Amantea). To this period (about the time of the Roman War against Pyrrhus) is to be assigned the series of their coins, and they appear to have retained the right of coinage even after their final subjugation by the Romans (see B. V. Head, *Historia Numorum*, p. 77). The influence of Hellenism over them is shown by finds in the tombs and the fact that they spoke the Greek language as well as their own (*bilingues* in Ennius). The mountainous country, ill-suited for agricultural purposes, was well adapted for these hardy warriors, whose training was Spartan in its simplicity and severity.

The Bruttii first came into collision with the Romans during the war with Pyrrhus, to whom they sent auxiliaries; after his defeat, they submitted, and were deprived of half their territory in the Sila forest, which was declared state property. In the war with Hannibal, they were among the first to declare in his favour after the battle of Cannae, and it was in their country that Hannibal held his ground during the last stage of the war (at Castrum Hannibalis on the gulf of Scylacium). (R. S. C.)

The Bruttii entirely lost their freedom at the end of the Hannibalic war; in 194 colonies of Roman citizens were founded at Tempsa and Croton, and a colony with Latin rights at Hipponium called henceforward Vibo Valentia. In 132 the consul P. Popillius built the great inland road from Capua through Vibo and Consentia to Rhegium, while the date of the construction of the east and west coast roads is uncertain. Neither in the Social War, nor in the rising of Spartacus, who held out a long time in the Sila (71 B.C.), do the Bruttii play a part as a people. Vibo was the naval base of Octavian in the conflict with Sextus Pompeius (42-36 B.C.).

The most important product of the district was the wood from the forests of the Sila, and the pitch produced from it. The Sila also contained minerals, which were worked out in very early times. The coast plains were in parts very fertile, especially the (now malarious) lower valley of the Crathis. Under the empire, however, the whole district remained backward and was remarkable for the absence of important towns, as the scarcity of ancient inscriptions, both Greek and Latin, shows: the Sila was state domain, and most of the rest in the hands of large proprietors. Augustus joined it with Lucania (from which it was divided by the rivers Laus and Crathis) to form the third region of Italy. In the 2nd and 3rd centuries, for administrative and juridical purposes, it was sometimes (with Lucania) joined to Apulia and Calabria. Diocletian placed Lucania and Britii (as the name was then spelt) under a *corrector*, whose residence was at Rhegium. The boundaries of the original third Augustan region had by that time become somewhat altered, Metapontum belonging to Calabria, and Salernum and the territory of the Picentini to the third region instead of the first (Campania). From the 6th century, after the fall of

the Ostrogothic power, and the establishment of that of Byzantium in its place in south Italy, the name Calabria was applied to the whole of the south Italian possessions of the Eastern empire, and the name of the Britii entirely disappeared; and after the eastern peninsula (the ancient Calabria) had been taken by the Lombards about A.D. 668, the western retained the name, and has kept it till the present day. (T. As.)

See Strabo vi. p. 253-265; Dion. Halic. ix. 1, 4, 15; Pliny, *Nat. Hist.* iii. 71-74; Justin xii. 2, xxiii. 1; F. Lenormant, *La Grande-Grece*, i. (1881-1884); H. Nissen, *Italische Landeskunde* (1883-1902); C. Hülsen in Pauly-Wissowa's *Realencyclopädie*, iii. pt. i. (1897); E. H. Bunbury in Smith's *Dictionary of Greek and Roman Geography*; R. S. Conway, *The Italic Dialects* (1897), for Bruttian inscriptions and local and personal names; P. Orsi in *Atti del congresso storico* (Rome, 1904), v. 193 seq.; M. Schipa, *La Migrazione del nome Calabria* (1895), whose conclusions are summarized in J. B. Bury's edition of Gibbon's *Decline and Fall*, v. p. 24, note; other authorities in J. Jung, "Geographie von Italien" (1897) in I. Müller's *Handbuch der klassischen Altertumswissenschaft*, iii. Abteilung 3.

BRUTUS (originally an adjective meaning "heavy," "stupid," kindred with Gr. *βραψ*, cf. Eng. "brute," "brutal"), the surname of several distinguished Romans belonging to the Junian gens.

I. **LUCIUS JUNIUS BRUTUS**, one of the first two consuls, 509 B.C. According to the legends, his mother was the sister of Tarquinius Superbus, the last of the Roman kings, and his father and his elder brother had been put to death by the reigning family in order to get possession of his wealth. Junius, the younger, owed his safety to his reputed dullness of intellect (whence his surname), which character, however, he had only assumed for prudential reasons (Dion. Halic. iv. 67, 77). The story is probably an invention to account for his name; in any case his dullness did not prevent his appointment as master of the horse. When Lucretia, wife of Collatinus, was outraged by Sextus Tarquinius (the incident which inspired Shakespeare's *Rape of Lucrece*), Brutus, together with her husband and father, took a leading part in expelling the Tarquini from Rome. He and Collatinus were therefore elected consuls—or rather praetors, which was the original title (Livy i. 59). In a conspiracy formed for the restoration of the dynasty, the two sons of Brutus were deeply implicated, and were executed by sentence of their father, and in his sight (Livy ii. 3). The Etruscans of Veii and Tarquinii making an attempt to restore Tarquinius, a battle took place between them and the Romans, in which Junius Brutus engaged Aruns, son of the deposed king, in single combat on horseback, and each fell by the other's hand (Livy ii. 6; Dion. Halic. v. 14). The Roman matrons mourned a year for him, as "the avenger of woman's honour," and a statue was erected to him on the Capitol. The conspiracy of his sons is the subject of a tragedy by Voltaire.

The patrician branch of the family appears to have become extinct with L. Junius Brutus; the chief representatives of the plebeian branch in later times are dealt with below.

II. **DECIMUS JUNIUS BRUTUS**, consul 138, surnamed Gallaeus from his victory over the Gallaei (136) in the north-west of Spain (Plutarch, *Tib. Gracchus*, 21). He was a highly educated man, a patron of literature, and a friend of the poet Accius (Livy, *Epit.* 55; Appian, *Hisp.* 71-73; Vell. Pat. ii. 5; Cicero, *Brutus*, 28).

III. **MARCUS JUNIUS BRUTUS**, a jurist of high authority, was considered as one of the founders of Roman civil law (Cicero, *De Oratore*, ii. 33, 55).

IV. His son, of the same name, made a great reputation at the bar, and from the vehemence and bitterness of his speeches became known as "the Accuser" (Cicero, *De Officiis*, ii. 15).

V. **DECIMUS JUNIUS BRUTUS** (Albinus), born about 84 B.C., first served under Caesar in Gaul, and afterwards commanded his fleet. Caesar, who esteemed him very highly, made him his master of the horse and governor of Gaul, and, in case of Octavian's death, nominated him as one of his heirs. Nevertheless he joined in the conspiracy against his patron, and, like his relative Marcus Junius Brutus (see below), was one of his assassins. He afterwards resisted the attempt of Antony to obtain

absolute power; and after heading the republican armies against him for some time with success, was deserted by his soldiers in Gaul, betrayed by one of the native chiefs, and put to death by order of Antony (43), while attempting to escape to Brutus and Cassius in Macedonia. He figures in Cicero's correspondence. (See Appian, *B.C.* iii. 97; Cicero *de Cassius* xlvi. 53; Caesar, *B.G.* iii. 11, *B.C.* i. 36, 45.)

VI. **MARCUS JUNIUS BRUTUS** (85, according to some, 79 or 78-42 B.C.), son of a father of the same name and of Servilia, half-sister of Cato of Utica, is the most famous of the name, and is the real hero of Shakespeare's *Julius Caesar*. His father had been treacherously put to death by order of Pompey during the civil wars. At that time young Marcus was only eight years old, and was educated with great care by his mother and uncles. He at first practised as an advocate. In spite of his father's fate, he supported the cause of Pompey against Caesar, but was pardoned by the latter after the victory of Pharsalus, and subsequently appointed by him to the government of Cisalpine Gaul (46). His justice and moderation won him great honour from the provincials under his rule. In 44 he was city praetor, and Caesar promised him the governorship of Macedonia at the expiration of his term of office. Influenced probably by his friend Gaius Cassius, he afterwards joined in the conspiracy against the great dictator, and was one of the foremost in his assassination. He maintained the cause of the republic by seizing and holding against Antony's forces the province of Macedonia, where he was joined by Cassius. But at Philippi (42) they were defeated by Antony and Octavian, and, rather than be taken prisoner, he fell on his sword. His wife Porcia, daughter of Cato of Utica, afterwards committed suicide, it is said, by swallowing red-hot coals (Dio Cassius xlvii. 20-49; Plutarch, *Brutus*; Appian, *B.C.* iv.; Vell. Paternulus ii. 72).

Brutus was an earnest student through all his active life, and is said to have been working on an abridgment of Pausanias the night before Pharsalus. He was generally friendly with Cicero, who dedicated several of his works to him (amongst them his *Orator*), and gave the name of *Brutus* to his dialogue on famous orators; but there were frequent disagreements between them, and Cicero frequently speaks of his coldness and lack of enthusiasm. It is difficult to understand his great influence over the Romans (he was only forty-three when he died); probably they admired him for his respectability, the old-fashioned *gravitas*. He was slow in decision, amazingly obstinate, lacking in sympathy save towards his womenkind—who unduly influenced him—and in his financial dealings with the provincials both extortionate and cruel (Cic. *ad Att.* vi. 17). Shakespeare's portrait of him is far too flattering. It has been held that he was really an illegitimate son of Julius Caesar. If so we may find an explanation of his joining the conspirators by the fact that in 45 Caesar had appointed Octavian as his heir. He wrote several philosophical treatises (*de Virtute, de Officiis, de Patience*) and some poetry, but nothing has survived. On the other hand, we possess part of his correspondence with Cicero (two books out of an original nine), the authenticity of which, though formerly disputed, is now regarded as firmly established, with the possible exception of two of the letters. The letters of Brutus written in Greek are probably the composition of some rhetorician.

See E. T. Bynum, *Das Leben des M. J. Brutus* (Halle a/S, 1898); Tyrrell and Purser's edition of Cicero's *Letters* (refs. in index vol. 12, "Junius Brutus," especially introductions to vols. iii. and v.); G. Boissier, *Cicero and his Friends* (Eng. trans. 1897); J. L. Strachan-Davidson, *Cicero* (1894); other authorities under **CAESAR**; **CICERO**.

BRÜX, a town of Bohemia, Austria, 93 m. N.N.W. of Prague by rail. Pop. (1900) 21,525. It is dominated by the Schlossberg (1307 ft.), on which is situated the ruins of an old castle, demolished in 1651, and possesses a very interesting church, in late-Gothic style, built in 1517. Brüt is situated in the centre of a region very rich in lignite deposits and has, besides, important sugar, iron and hardware, distilling, brewing and milling industries. To the south of Brüt are the villages of Püllna, Seidnitz and Seidschutz with well-known saline springs. Brüt is mentioned in documents of the early 11th century. It fell to the crown under Přemysl I. or Wenceslaus II.

and was made a royal city by Ottakar II. in the 13th century. In 1421 the Hussites were defeated here by King Sigismund and the Saxons, and in 1426 besieged the town in vain. In 1456 George of Poděbrad captured the town and castle, which had for some time been occupied by the Saxon princes.

BRY, THEODORUS [DIX] DE (1528-1598), German engraver and publisher, was born at Liège in 1528. In the earlier years of his career he worked at Strassburg. Later he established an engraving and publishing business at Frankfurt-on-Main, and also visited London in or before 1587. Here he became acquainted with the geographer Richard Hakluyt, with whose assistance he collected materials for a finely illustrated collection of voyages and travels, *Collections Peregrinationum in Indiam Orientalem et Indiam Occidentalem* (25 parts, 1590-1634). Among other works he engraved a set of 12 plates illustrating the Procession of the Knights of the Garter in 1576, and a set of 34 plates illustrating the Procession at the Obsequies of Sir Philip Sidney; plates for T. Hariot's *Briefe and True Report of the new found Land of Virginia* (Frankfort, 1595); the plates for the first four volumes of J. J. Boissard's *Romanæ Urbis Topographia et Antiquitates* (1597-1598), and a series of portraits entitled *Icones Virorum Illustrium* (1597-1599). De Bry died at Frankfurt on the 27th of March 1598. He had been assisted by his eldest son Johannes Theodorus de Bry (1561-1623), who after his father's death carried on the *Collections* and the illustration of Boissard's work, and also added to the *Icones*. His brother Johannes Israel de Bry (d. 1611) collaborated with him.

BRYAN, WILLIAM JENNINGS (1860-), American political leader, son of Silas Lillard Bryan, a native of Culpeper county, Virginia, who was a lawyer and from 1860 to 1897 a state circuit judge, was born at Salem, Marion county, Illinois, on the 10th of March 1860. He graduated from Illinois College as valedictorian in 1881, and from the Union College of Law, Chicago, in 1883; during his course he studied in the law office of Lymarr Trumbull. He practised law at Jacksonville from 1883 to 1887, when he removed to Lincoln, Nebraska. There he soon became conspicuous both as a lawyer and as a politician, attracting particular attention by his speeches during the presidential campaign of 1888 on behalf of the candidates of the Democratic party. From 1891 to 1895 he represented the First Congressional District of Nebraska, normally Republican, in the national House of Representatives, and received the unusual honour of being placed on the important Committee on Ways and Means during his first term. He was a hard and conscientious worker and became widely known for his ability in debate. Two of his speeches in particular attracted attention, one against the policy of protection (16th of March 1892), and the other against the repeal of the silver purchase clause of the Sherman Act (16th of August 1893). In the latter he advocated the unlimited coinage of silver, irrespective of international agreement, at a ratio of 16 to 1, a policy with which his name was afterwards most prominently associated. In a campaign largely restricted to the question of free-silver coinage he was defeated for re-election in 1894, and subsequently was also defeated as the Democratic candidate for the United States Senate. As editor of the *Omaha World-Herald* he then championed the cause of bimetalism in the press as vigorously as he had in Congress and on the platform, his articles being widely quoted and discussed.

The Democratic party was even more radically divided on the question of monetary policy than the Republican; and President Cleveland, by securing the repeal of the silver purchase clause in the Sherman Act by Republican votes, had alienated a great majority of his party. In the Democratic national convention at Chicago in 1896, during a long and heated debate with regard to the party platform, Bryan, in advocating the "plank" declaring for the free coinage of silver, of which he was the author, delivered a celebrated speech containing the passage, "You shall not press down upon the brow of labour this crown of thorns; you shall not crucify mankind upon a cross of gold." This speech made him the idol of the "silver" majority of the

convention and brought him the Democratic nomination for the presidency on the following day. Subsequently he received the nominations of the People's and National Silver parties. In the ensuing presidential campaign he travelled over 18,000 m. and made altogether 600 speeches in 27 different states—an unprecedented number. In the election, however, he was defeated by William McKinley, the Republican candidate, receiving 176 electoral votes to 271. But though defeated, he remained the leader of his party. Between 1896 and 1900, except during the Spanish-American War when he was colonel of the 3rd Nebraska Volunteers, though he saw no active service, he devoted his time to the interest of his party. His ability, sincerity of character, and wide information, and his attitude towards the new issues arising from the war, in which he took the side opposed to "imperialism," increased his following. Although he had advised the ratification of the Peace Treaty, he opposed the permanent acquisition of the Philippine Islands. In 1900 he was nominated for the presidency by the Democratic, Silver Republican, and Populist party conventions; but although "imperialism" was declared to be the paramount issue, he had insisted that the "platforms" should contain explicit advocacy of free-coinage, and this declaration, combined with the popularity of President McKinley, the Republican candidate for re-election, again turned the scales against him. In the November election after a canvass that almost equalled in activity that of 1896 he was again defeated, receiving only 155 electoral votes to 292.

After the 1900 election he established and edited at Lincoln a weekly political journal, *The Commoner*, which attained a wide circulation. In 1904 although not actively a candidate for the Democratic nomination (which eventually went to Judge Parker), he was to the very last considered a possible nominee; and he strenuously opposed in the convention the repudiation by the conservative element of the stand taken in the two previous campaigns. The decisive defeat of Parker by President Roosevelt did much to bring back the Democrats to Mr Bryan's banner. In 1905-1906 he made a trip round the world, and in London was cordially received as a great American orator. He was again nominated for the presidency by the Democratic party in 1908. The free-silver theory was now dead, and while the main question was that of the attitude to be taken towards the Trusts it was much confused by personal issues, Mr Roosevelt himself intervening strongly in favour of the Republican nominee, Mr Taft. After a heated contest Mr Bryan again suffered a decisive defeat, President Taft securing 321 electoral votes to Mr Bryan's 162.

BRYANSK, a town of Russia, in the government of Orel, 83 m. by rail W.N.W. of the city of that name, in 53° 15' N. and 34° 10' E. on the river Desna. It is mentioned in 1146, being then also known as Debryansk. It afterwards formed a separate principality, which came to an end in 1356 with the death of the prince. After the Mongol invasion of 1241, Bryansk fell into the power of the Lithuanians; and finally became incorporated with the Russian empire in the beginning of the 17th century. Bryansk was taken by the followers of the first false Demetrius, but it successfully resisted the attacks of the second impostor of that name. Under the empress Anne a dock was constructed for the building of ships, but it was closed in 1739. In 1783 an arsenal was established for the founding of cannon. The cathedral was built in 1526, and restored in the end of the 17th century. There are two high schools; and the industrial establishments include iron, rope, brick and tallow-boiling works, saw-mills and flour-mills, tobacco-factories and a brewery. Some distance north of the town are the Maltsov iron-works, with glass factories and rope-walks, employing 20,000 men. A considerable trade is carried on, especially in wood, tar, hemp, pitch, hemp-seed-oil and cattle. In 1867 the population numbered 13,881, and in 1897 23,520.

BRYANT, JACOB (1715-1804), English antiquarian and writer on mythological subjects, was born at Plymouth. His father had a place in the customs there, but was afterwards stationed at Chatham. The son was first sent to a school near

Rochester, whence he was removed to Eton. In 1736 he was elected to a scholarship at King's College, Cambridge, where he took his degrees of B.A. (1740) and M.A. (1744), subsequently being elected a fellow. He returned to Eton as private tutor to the duke of Marlborough, then marquess of Blandford; and in 1756 he accompanied the duke, then master-general of ordnance and commander-in-chief of the forces in Germany, to the continent as private secretary. He was rewarded by a lucrative appointment in the ordnance department, which allowed him ample leisure to indulge his literary tastes. He twice refused the mastership of the Charterhouse. Bryant died on the 14th of November 1804 at Cippenham near Windsor. He left his library to King's College, having, however, previously made some valuable presents from it to the king and the duke of Marlborough. He bequeathed £2000 to the Society for the Propagation of the Gospel, and £1000 for the use of the superannuated collegers of Eton.

His principal works are: *Observations and Inquiries relating to various Parts of Ancient History* (1767); *A New System, or an Analysis, of Ancient Mythology, wherein an attempt is made to divest Tradition of Fable, and to reduce Truth to its original Purity* (1774-1776), which is fantastic and now wholly valueless; *Vindication of the Apamean Medal* (1775), which obtained the support of the great numismatist Eckhel; *An Address to Dr Priestley upon his Doctrine of Philosophical Necessity* (1780); *Vindiciæ Flavianæ, a Vindication of the Testimony of Josephus concerning Jesus Christ* (1780); *Observations on the Poems of Thomas Rowley, in which the Authenticity of those Poems is ascertained* (1781); *Treatise upon the Authenticity of the Scriptures, and the Truth of the Christian Religion* (1792); *Observations on the Plagues inflicted upon the Egyptians* (1794); *Observations on a Treatise, entitled Description of the Plain of Troy, by Mr de Chevalier* (1795); *A Dissertation concerning the War of Troy, and the Expedition of the Grecians, as described by Homer, with the view of showing that no such expedition was ever undertaken, and that no such city as Phrygia existed* (1796); *The Sentiments of Philo Judæus concerning the Advoy or Word of God* (1797).

BRYANT, WILLIAM CULLEN (1794-1878), American poet and journalist, was born at Cummington, a farming village in the Hampshire hills of western Massachusetts, on the 3rd of November 1794. He was the second son of Peter Bryant, a physician and surgeon of no mean scholarship, refined in all his tastes, and a public-spirited citizen. Peter Bryant was the great-grandson of Stephen Bryant, an English Puritan emigrant to Massachusetts Bay about the year 1632. The poet's mother, Sarah Snell, was a descendant of "Mayflower" pilgrims. He was born in the log farmhouse built by his father two years before, at the edge of the pioneer settlement among those boundless forests, the deep stamp of whose beauty and majesty he carried on his own mind and reprinted upon the emotions of others throughout a long life spent mainly amid the activities of his country's growing metropolis. By parentage, by religious and political faith, and by hardness of fortune, the earliest of important American poets was appointed to a life typical of the first century of American national existence, and of the strongest single racial element by which that nation's social order has been moulded and promoted. Rated by the amount of time given to school books and college classes, Bryant's early education was limited. After the village school he received a year of exceptionally good training in Latin under his mother's brother, the Rev. Dr Thomas Snell, of Brookfield, followed by a year of Greek under the Rev. Moses Hallock, of Plainfield, and at sixteen entered the sophomore class of Williams College. Here he was an apt and diligent student through two sessions, and then, owing to the straitness of his father's means, he withdrew without graduating, and studied classics and mathematics for a year, in the vain hope that his father might yet be able to send him to Yale College. But the length of his school and college days would be a very misleading measure of his training. He was endowed by nature with many of those traits which it is often only the final triumph of books and institutional regimen to establish in character, and a double impulse toward scholarship and citizenship showed its ruling influence with a precocity and an ardour which gave every day of systematic schooling many times its ordinary value. It is his own word that, two months after beginning with the Greek alphabet, he had read the New Testament through. On

abandoning his hope to enter Yale, the poet turned to and pursued, under private guidance at Worthington and at Bridgewater, the study of law. At twenty-one he was admitted to the bar, opened an office in Plainfield, presently withdrew from there, and at Great Barrington settled for nine years in the attorney's calling, with an aversion for it which he never lost. His first book of verse, *The Embargo, or Sketches of the Times; A Satire by a Youth of thirteen*, had been printed at Boston in 1808.

At the age of twenty-six Bryant married, at Great Barrington, Miss Frances Fairchild, with whom he enjoyed a happy union until her death nearly half a century later. In the year of his marriage he suffered the bereavement of his father's death. In 1825 he ventured to lay aside the practice of law, and removed to New York City to assume a literary editorship. Here for some months his fortunes were precarious, until in the next year he became one of the editors of the *Evening Post*. In the third year following, 1829, he came into undivided editorial control, and became also chief owner. He enjoyed his occupation, fulfilling its duties with an unflinching devotion to every worthy public interest till he died in 1878, in the month of his choice, as indicated in his beautiful poem entitled "June."

Though Bryant's retiring and contemplative nature could not overpower his warm human sympathies, it yet dominated them to an extent that made him always, even in his journalistic capacity and in the strenuous prose of daily debate, a councillor rather than a leader. It was after the manner of the poet, the seer, that he was a patriot, standing for principles much more than for measures, and with an exquisite correctness which belonged to every phase of his being, never prevailing by the accommodation of himself to inferiors in foresight, insight or rectitude. His vigorous and stately mind found voice in one of the most admirable models of journalistic style known in America. He was founder of a distinct school of American journalism, characterized by an equal fidelity and temperance, energy and dignity. Though it is as a poet that he most emphatically belongs to history, his verse was the expression of only the gentler motions of his mind; and it gathers influence, if not lustre, when behind it is seen a life intrepid, upright, glad, and ever potent for the nobler choice in all the largest affairs of his time. His renown as a poet antedated the appearance of his first volume by some four or five years. "American poetry," says Richard Henry Stoddard, "may be said to have commenced in 1817 with . . . (Bryant's) 'Thanatopsis' and 'Inscription for the entrance of a wood.'" "Thanatopsis," which revealed a voice at once as new and as old as the wilderness out of which it reverberated, had been written at Cummington in the poet's eighteenth year, and was printed in 1817 in the *North American Review*; the "Inscription" was written in his nineteenth, and in his twenty-first, while a student of law at Bridgewater, he had composed his lines "To a Water-fowl," whose exquisite beauty and exalted faith his own pen rarely, if ever, surpassed. The poet's gift for language made him a frequent translator, and among his works of this sort his rendering of Homer is the most noted and most valuable. But the muse of Bryant, at her very best, is always brief-spoken and an interpreter initially of his own spirit. Much of the charm of his poems lies in the equal purity of their artistic and their moral beauty. On the ethical side they are more than pure, they are—it may be said without derogation—Punian. He never commences with unloveliness for any loveliness that may be plucked out of it, and rarely or never discovers moral beauty under any sort of mask. As free from efficiency as from indelicacy, his highest and his deepest emotions are so dominated by a perfect self-restraint that they never rise (or stoop) to transports. There is scarcely a distempered utterance in the whole body of his poetical works, scarcely one passionate exaggeration. He faces life with an invincible courage, an inextinguishable hope and heavenward trust, and the dignity of a benevolent will which no compulsion can break or bend. The billows of his soul are not waves, but hills which tempest ruffle but can never heave. Even when he essays to speak for spirits unlike his own—characters of history or conceptions of his own imagination—he never with signal success portrays

them in the bonds, however transient, of any overmastering passion. For merriment he has a generous smile, for sorrow a royal one; but the nearest he ever comes to mirth is in his dainty rhyme, "Robert of Lincoln," and the nearest to a wail in those exquisite notes of grief for the loss of his young sister, "The Death of the Flowers," which only draw the tear to fill it with the light of a perfect resignation. As a seer of large and noble contemplation, in whose pictures of earth and sky the presence and care of the Divine mind, and every tender and beautiful relation of man to his Creator and to his fellow, are melodiously celebrated, his rank is among the master poets of America, of whom he is historically the first.

Bryant published volumes of *Poems* in 1821 (Cambridge) and 1832 (New York), and many other collections were issued under his supervision, the last being the *Poetical Works* (New York, 1876). Among his volumes of verse were "The Fountain" and other poems (New York, 1842); *The White-Footed Deer and Other Poems* (New York, 1844); *Thirty Poems* (New York, 1864); and blank-verse translations of *The Iliad of Homer* (Boston, 1870) and of *The Odyssey of Homer* (Boston, 1871). His *Poetical Works* and his *Complete Prose Writings* (New York, 1883 and 1884) were edited by Parke Godwin, who also wrote *A Biography of William Cullen Bryant, with Extracts from his private Correspondence* (New York, 1883). See also J. Grant Wilson, *Bryant and his Friends* (New York, 1886); John Bigelow, *William Cullen Bryant* (Boston, 1890), in the "American Men of Letters" series; W. A. Bradley, *Bryant*, in the "English Men of Letters" series (1905); E. C. Stedman, *Poets of America* (1885); and biographical and bibliographical introductions by Henry C. Sturges and Richard Henry Stoddard to the "Roslyn edition" of his *Poetical Works* (New York, 1903). (G. W. C.A.)

BRYAXIS, one of the four great sculptors who worked on the mausoleum at Halicarnassus, about 350 B.C. His work on that monument cannot be separated from that of his companions, but a basis has been discovered at Athens bearing his signature, and adorned with figures of horsemen in relief. He is said to have made a great statue of Serapis for Sinope, but as to this there are grave historic difficulties. He also made a great statue of Apollo, set up at Daphne near Antioch (see E. A. Gardner, *Handbook of Greek Sculpture*, ii, 374).

BRYCE, JAMES (1838-), British jurist, historian and politician, son of James Bryce (LL.D. of Glasgow, who had a school in Belfast for many years), was born at Belfast, Ireland, on the 10th of May 1838. After going through the high school and university courses at Glasgow, he went to Trinity College, Oxford, and in 1862 was elected a fellow of Oriel. He went to the bar and practised in London for a few years, but he was soon called back to Oxford as regius professor of civil law (1870-1893). His reputation as a historian had been made as early as 1864 by his *Holy Roman Empire*. He was an ardent Liberal in politics, and in 1880 he was elected to parliament for the Tower Hamlets division of London; in 1885 he was returned for South Aberdeen, where he was re-elected on succeeding occasions. His intellectual distinction and political industry made him a valuable member of the Liberal party. In 1886 he was made under secretary for foreign affairs; in 1892 he joined the cabinet as chancellor of the duchy of Lancaster; in 1894 he was president of the Board of Trade, and acted as chairman of the royal commission on secondary education; and in Sir Henry Campbell-Bannerman's cabinet (1905) he was made chief secretary for Ireland; but in February 1907 he was appointed British ambassador at Washington, and took leave of party politics, his last political act being a speech outlining what was then the government scheme for university reform in Dublin—a scheme which was promptly discarded by his successor Mr Birrell. As a man of letters Mr Bryce was already well known in America. His great work *The American Commonwealth* (1888; revised edition, 1910) was the first in which the institutions of the United States had been thoroughly discussed from the point of view of a historian and a constitutional lawyer, and it at once became a classic. His *Studies in History and Jurisprudence* (1901) and *Studies in Contemporary Biography* (1903) were republications of essays, and in 1897, after a visit to South Africa, he published a volume of *Impressions of that country*, which had considerable weight in Liberal circles when the Boer War was being discussed.

Meanwhile his academic honours from home and foreign universities multiplied, and he became a fellow of the Royal Society in 1894. In earlier life he was a notable mountain-climber, ascending Mount Ararat in 1876, and publishing a volume on *Transcaucasia and Ararat* in 1877; in 1899-1901 he was president of the Alpine Club.

BRYDGES, SIR SAMUEL EGERTON (1762-1837), English genealogist and miscellaneous writer, was born on the 30th of November 1762. He studied at Queens' College, Cambridge, and was entered at the Middle Temple in 1782, being called to the bar in 1787. In 1789 he persuaded his elder brother that their family were the heirs to the barony of Chandos, being descended from a younger branch of the Brydges who first held the title. The case was tried and lost, but Brydges never gave up his claim, and used to sign himself *Per legem terrae* B. C. of S. (i.e. Baron Chandos of Sudeley). He re-edited Collins's *Peerage*, inserting a statement about his supposed right. In 1814 he was made a baronet, and in 1818 he left England. He died at Geneva on the 8th of September 1837. Sir Egerton was a most prolific author; he is said to have written 2000 sonnets in one year. His numerous works include *Poems* (1785); *Censura Literaria* (1805-1809); *The British Bibliographer* (4 vols., 1810-1814), with J. Haslewood; *Restituta* (4 vols., 1814-1816), containing accounts of old books; and *Autobiography, Times, Opinions and Contemporaries of Sir S. E. Brydges* (1834). In 1813 Brydges began to supply material to a private printing press established at Lee Priory, Kent, by a compositor and a pressman, who were to receive any profits which might arise from the sale of the works published. In this way Brydges published various Elizabethan texts, at considerable expense to himself, which increased the services he had already rendered to the study of Elizabethan literature by his bibliographical works.

For a full list of his works see W. T. Lowndes, *Bibliographer's Manual* (ed. H. G. Bohn, 1857-1864).

BRYENNIUS, NICEPHORUS (1062-1137), Byzantine soldier, statesman and historian, was born at Orestias (Adrianople). His father, of the same name, had revolted against the feeble Michael VII., but had been defeated and deprived of his eyesight. The son, who was distinguished for his learning, personal beauty and engaging qualities, gained the favour of Alexius I. (Comnenus) and the hand of his daughter Anna, with the titles of Caesar (then ranking third) and Panhypersebastos (one of the new dignities introduced by Alexius). Bryennius successfully defended the walls of Constantinople against the attacks of Godfrey of Bouillon (1097); conducted the peace negotiations between Alexius and Bohemund, prince of Antioch (1108); and played an important part in the defeat of Malik-Shah, the Seljuk sultan of Iconium (1116). After the death of Alexius, he refused to enter into the conspiracy set on foot by his mother-in-law and wife to depose John, the son of Alexius, and raise himself to the throne. His wife attributed his refusal to cowardice, but it seems from certain passages in his own work that he really regarded it as a crime to revolt against the rightful heir; the only reproach that can be brought against him is that he did not nip the conspiracy in the bud. He was on very friendly terms with the new emperor John, whom he accompanied on his Syrian campaign (1137), but was forced by illness to return to Byzantium, where he died in the same year. At the suggestion of his mother-in-law he wrote a history (called by him *Τὰ Ἱστορικά*, materials for a history) of the period from 1057 to 1081, from the victory of Isaac I. (Comnenus) over Michael VI. to the dethronement of Nicephorus Botaneiates by Alexius. The work has been described as rather a family chronicle than a history, the object of which was the glorification of the house of Comnenus. Part of the introduction is probably a later addition. In addition to information derived from older contemporaries (such as his father and father-in-law) Bryennius made use of the works of Michael Psellus, John Scylitza and Michael Attaliota. As might be expected, his views are biased by personal considerations and his intimacy with the royal family, which at the same time, however, afforded him unusual facilities for obtaining material. His model was Xenophon, whom he has imitated with

a tolerable measure of success; he abstains from an excessive use of simile and metaphor, and his style is concise and simple.

Editio princeps, P. Possinus, 1661; in *Bonn Corpus Scriptorum Hist. Bys.*, by E. Meineke (1836), with du Cange's valuable commentary; Migne, *Patrologia Graeca*, cxvii.; see also J. Seger, *Byzantinische Historiker des 10. und 11. Jahrhunderts* (1888), and C. Krumbacher, *Geschichte der byzantinischen Litteratur* (1897). The estimate of his work in R. Nicolai, *Griechische Literaturgeschichte*, iii. p. 76 (1878), is too unfavourable.

BRYNMAWR, a market town of Brecknockshire, Wales, 14½ m. S.E. of Brecknock and 156 m. from London by rail. Pop. of urban district (1901) 6833. It is on the London & North-Western and Rhymney joint railway connecting Rhymney and Abergavenny, being also a junction for a branch line to Pontypool via Blaenavon, and the terminus of the Great Western line from Newport via Nantyglo. The town owes its origin to the development during the first half of the 19th century of iron-works at the upper ends of the valleys that converge in its neighbourhood, its site being previously known as Waun Helygen (Willow-tree Common). The Nantyglo ironworks afford occupation to large numbers of the inhabitants of Brynmawr. Both coal and iron ore were formerly worked, but the coal is exhausted and the ore unsuitable for modern processes. Brynmawr was formed into an ecclesiastical parish in 1875 out of portions of the civil parishes of Llanely and Llangatock. In 1894 this was formed into an urban district, which was enlarged in 1900 by the addition of a portion of the parish of Aberystwith in Monmouthshire, the whole being at the same time consolidated into a civil parish.

BRYN MAWR COLLEGE, an institution of advanced learning for women, at Bryn Mawr, Pennsylvania, U.S.A., 5 m. W. of Philadelphia. The site occupies 52 acres and overlooks a broad expanse of rolling country. The buildings are of grey stone in the Jacobean Gothic style, and consist of an administration and lecture hall, a science hall, a library containing in 1908 about 55,000 volumes mostly for special study, a gymnasium, a hospital and six halls of residence. The requirements for matriculation are high; students are required to choose their studies according to the "group system," which permits them to specialize in two or more subjects; and instruction is given largely by means of lectures. The college is open to "hearers" who are not required to matriculate, to undergraduate matriculated students who are not studying for a degree, to undergraduate matriculated students who are candidates for the degree of B.A., and to graduate students who are candidates for the degree of M.A. or Ph.D. The government rests in a board of thirteen trustees and sixteen directors, all the trustees being members of the board of directors. The president of the college is a trustee and director. The institution was founded by Dr Joseph W. Taylor (1810-1880), a member of the Society of Orthodox Friends, and he provided that the trustees also should be members, but otherwise Bryn Mawr College is non-sectarian. It was incorporated in 1880, and was opened for instruction in 1885. In 1908 it had 419 students.

BRYOPHYTA, the botanical name of the second great subdivision of the vegetable kingdom, which includes the mosses and liverworts. They are all plants of small, often minute, size, and, as the absence of popular names indicates, the different kinds are not commonly recognized. Even the distinction between liverworts and mosses is not clearly made, not only the former but other small plants of higher groups being popularly called mosses. A little careful observation soon shows, however, that the Bryophytes form a well-defined class, including several subordinate groups. Though their study necessarily involves minute observation they possess many features of interest. The adaptations they show to their conditions of life are often very perfect and present interesting analogies with the adaptive characters of the higher plants. They are of great scientific interest not only as representing a special type of life-history and organization, but because in several of the subordinate groups series of forms can be traced, which enable the general course of their evolution to be inferred even in the practical absence of fossil remains of any antiquity.

Bryophytes are very generally distributed over the earth, and those of a single country, such as Britain, afford examples of all the chief natural groups. Sometimes, as is the case with the bog-mosses and some arctic mosses, they may cover considerable tracts. As a rule, however, they occupy a subordinate place in the vegetation, and the different kinds require to be carefully looked for. Covering, as they often do, what would otherwise be bare ground, they are of value in assisting to retain moisture in the soil and in preparing the way for its colonization by higher plants. Although many forms are capable of withstanding periods of drought they succeed best in relatively moist climates and localities. This is shown both by their unequal abundance in different localities of one country and in their scarcity in certain geographical regions as compared with their luxuriance in others.

The external appearance and general organization show great variety. In all mosses and many liverworts (figs. 8, 11) the plant consists of a stem bearing small leaves. In a number of liverworts (figs. 2, 7), on the other hand, it presents no distinction of stem and leaf, but is a flat, dorsoventral body usually closely applied to the substratum on which it grows. This, in contradistinction to the leafy shoot, is termed a *thallus*. True roots are never present, the plants being attached to the soil by *rhizoids*, which resemble the root-hairs of higher plants.

The reproductive organs borne by the thallus or plant are called antheridia and archegonia, and serve for sexual reproduction. The *antheridium* (fig. 5, 15) has a longer or shorter stalk and consists of a wall formed of a single layer of flat cells enclosing a mass of minute cells from which the spermatozooids are developed. In the cases which have been most carefully investigated two spermatozooids have been found to arise from each of the small cubical cells of the central tissue. When mature the antheridium opens on being moistened and the spermatozooids become free in the water by the dissolution of the mucilaginous cell-walls enclosing them. Each has the form (fig. 5, D) of a more or less spirally twisted, club-shaped body, bearing at the pointed anterior end two long cilia by means of which it moves through the water. The *archegonium* (fig. 1) has

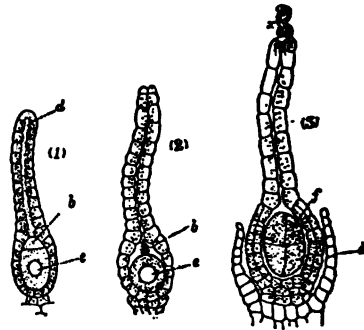

FIG. 1.—Archegonia of *Marchantia polymorpha*. (After Sachs.)

1. Mature but unopened archegonium. *a*, Ovum; *b*, ventral canal cell; *c*, lid-cells of neck.
2. Archegonium ready for fertilization; a passage leads down to the rounded ovum *e*.
3. Archegonium after fertilization; the fertilized ovum is developing into a sporogonium *f*; *d*, perianth.

the form of a narrow flask with a long neck. It usually has a short stalk and consists of a central row of cells enclosed by a layer of cells forming the wall. The egg-cell or ovum lies within the wider basal region or venter, and above it come the ventral canal-cell and canal-cells within the neck of the archegonium. When the archegonium opens by the separation of the cells at the tip, the disorganized canal-cells escape, leaving a narrow tubular passage leading down to the ovum. Each antheridium or archegonium arises from a single cell, and while the mature structure is similar in the two groups, the development presents differences in liverworts and mosses. Without entering into details it may be mentioned that in the mosses it proceeds both in the archegonium and antheridium by the segmentation of an apical cell, while this is not the case in the liverworts. Fertilization is effected by the passage of a spermatozoid, attracted probably by means of a chemical stimulus, down the passage of the archegonial neck and its fusion with the ovum. It thus, as in other cases of sexual reproduction, involves the union of

two cells, and the vegetative plant, since it bears the sexual organs, is called the sexual generation or *gametophyte*.

From the fertilized ovum another and very different stage arises, which remains attached to the sexual plant and has thus the appearance of a fruit borne on it. It consists of a capsule usually borne on a longer or shorter stalk or seta, the base of which is inserted into the tissues of the gametophyte. This basal region, which serves to absorb nourishment, is called the foot. Within the capsule numerous reproductive cells, the spores, are developed. In contrast to the sexual generation this stage is called the spore-bearing generation (*sporogonium*; *sporophyte*). The examination of any moss "in fruit" (fig. 11, B) will show the readily detachable sporogonium borne on the leafy sexual plant, and the relation existing between the two generations will be evident from figs. 2, 3, 9, and 16. In liverworts (with one or two exceptions) the mature capsule is filled with spores mingled with sterile cells or elaters and opens by splitting into valves. In mosses (fig. 11, C) the sporogonium is more highly organized; a central column of sterile tissue (the columella) is found in the capsule, which opens by the removal of a lid or operculum, and there are no elaters among the spores. By the opening of the capsule the spores are set free, and under suitable conditions germinate and give rise to the sexual generation. In mosses (fig. 12) a filamentous growth, the protonema, is first formed, and the leafy plants arise upon this. In liverworts this preliminary phase of the sexual generation is as a rule ill-marked or absent, and the plant may be said to develop directly from the spore.

It will be evident that the two generations exhibit a regular succession or alternation in the life-history of all Bryophytes. The gametophyte is developed from the spore and bears the sexual organs; the sporogonium is developed from the fertilized egg and produces spores. An important cytological difference between the two generations can only be mentioned here. By the union of the nuclei of the spermatoid and ovum in fertilization the number of chromosomes in the resulting nucleus is doubled, and this double number is maintained throughout all the cell-divisions of the sporogonium. On the development of the spores, which takes place by the division of each spore-mother-cell into four, the number of chromosomes becomes one half of what it has been in all the nuclei of the sporogonium. This reduced number is maintained throughout the development of the sexual generation. Thus in *Pellia* the nuclei of the gametophyte have eight chromosomes and those of the sporophyte sixteen. The relation in which the two generations stand to one another is the most important common characteristic of the Bryophyta. The gametophyte is always the independently living individual upon which the spore-bearing generation is throughout its life dependent. In all plants higher than the Bryophyta the sporophyte becomes an independently rooted plant and is the conspicuous stage in the life-history. Thus in the fern the sexual generation is the small prothallus developed from the spore; while the familiar fern-plant is the spore-bearing generation (see *PTERIDOPHYTES*). On the other hand a corresponding alternation of generations is only indicated in the lower plants (Thallophytes).

The Bryophyta are divided into the Hepaticae (liverworts) and Musci (mosses). In the Hepaticae we can recognize three subordinate groups—the Marchantiales, Jungermanniales and Anthocerotales; and in the Musci also three groups—the Sphagnales, Andreaeales and Bryales. Since these series of forms differ considerably among themselves, it is difficult to express in a definition the distinction between a liverwort and a moss which is readily made in practice. We may therefore leave it to the description of the several groups of Hepaticae and Musci to supplement the differences mentioned above and to bring out the exceptions which exist.

Hepaticae (Liverworts).

The range of form and structure of both generations in the liverworts is so great that no one form can be taken as a satisfactory type. It will, however, be of use to preface the more general description by a brief account of a particular example, and we may take for this purpose a very common and easily recognized thalloid liverwort belonging to the Jungermanniales.

Pellia epiphylla (fig. 2) can be found at any season growing in large patches on the damp soil of woods, banks, &c. The broad flat thallus is green and may be a couple of inches long. It is sparingly branched, the branching being apparently dichotomous; the growing point is situated in a depression at the anterior end of each branch. The wing-like lateral portions of the thallus gradually thin out from the midrib; from the projecting lower surface of this numerous rhizoids spring. These are elongated superficial cells, and serve to fix the thallus to the soil and obtain water and salts from it. No leaf-like

appendages are borne on the thallus, but short glandular hairs occur behind the apex. The plant is composed throughout of very similar living cells, the more superficial ones containing numerous chlorophyll grains, while starch is stored in the internal cells of the midrib. The cells contain a number of oil-bodies the function of which is imperfectly understood. The growth of the thallus proceeds by the regular segmentation of a single apical cell.

The sexual organs are borne on the upper surface, and both antheridia and archegonia occur on the same branch (fig. 3, A). The antheridia (*an*) are scattered over the middle region of the thallus, and each is surrounded by a tubular upgrowth from the surface. The archegonia (*ar*) are developed in a group behind the apex, and the latter continues to grow for a time after their formation, so that they come to be seated in a depression of the upper surface. They are further protected by the growth of the hinder margin of the depression to form a scale-like involucre (*in*). Fertilization takes place about June, and the sporogonium is fully developed by the winter. The embryo developed from the fertilized ovum consists at first of a number of tiers of cells. Its terminal tier gives rise to the capsule, the first divisions in the four cells of the tier marking off the wall of the capsule from the cells destined to produce the spores. In fig. 4, C, which represents a longitudinal section of a young embryo of *Pellia*, these archesporial cells are shaded. The tiers below give rise to the seta and foot. The mature sporogonium (fig. 3, B) consists of the foot embedded in the tissue of the thallus, the seta, which remains short until just before the shedding of the spores, and the spherical capsule. It remains for long enclosed within the calyptra formed by the further development of the archegonial wall and surmounted by the neck of the archegonium. The calyptra is ultimately burst through, and in early spring the seta elongates rapidly, raising the dark-coloured capsule (fig. 2). In the young condition the wall of the capsule, which consists of two layers of cells, encloses a mass of similar cells developed from the archesporium. Some of these become spore-mother-cells and give rise by cell division to four spores, while others remain undivided and become the elaters. The latter are elongated spindle-shaped

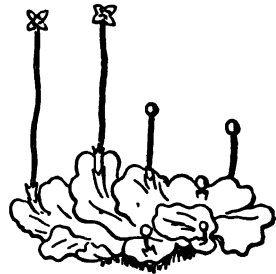

From Cooke, *Handbook of British Hepaticae*.
FIG. 2.—*Pellia epiphylla*. Group of plants bearing mature sporogonia. (Nat. size.)

cells with thick brown spiral bands on the inside of their thin walls. They radiate out from a small plug of sterile cells projecting into the base of the capsule, and some are attached to this, while others lie free among the spores. The latter are large, and at first are unicellular; but in *Pellia*, in which this respect is exceptional, they commence their further development within the capsule, and thus consist of several cells when shed.

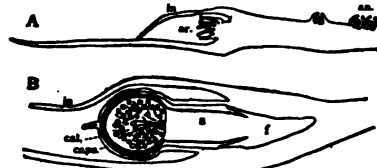

FIG. 3.—*Pellia epiphylla*.

- A, Longitudinal section of thallus at the time of fertilization. *an*, Antheridia; *ar*, archegonia; *in*, involucre. *f*, foot; *s*, seta; *cap*, capsule (semi-diagrammatic).
B, Longitudinal section of almost mature sporogonium attached to the thallus. *in*, Involucre; *cal*, calyptra; *f*, foot; *s*, seta; *cap*, capsule (semi-diagrammatic).

cells with thick brown spiral bands on the inside of their thin walls. They radiate out from a small plug of sterile cells projecting into the base of the capsule, and some are attached to this, while others lie free among the spores. The latter are large, and at first are unicellular; but in *Pellia*, in which this respect is exceptional, they commence their further development within the capsule, and thus consist of several cells when shed.

The cells of the capsule wall have incomplete, brown, thickened rings on their walls, and the capsule opens by splitting into four valves, which bend away from one another, allowing the loose spores to be readily dispersed by the wind, assisted by the hygroscopic movements of the elaters. On falling upon damp soil the spores germinate, growing into a thallus, which gradually attains its full size and bears sexual organs.

While the general course of the life-history of all liverworts resembles that of *Pellia*, the three great groups into which they are divided differ from one another in the characters of both generations. Each group exhibits a series leading from more simple to more highly organized forms, and the differentiation has proceeded on distinct and to some extent divergent lines in the three groups. The Marchantiales are a series of thalloid forms, in which the structure of the thallus is specialized to enable them to live in more exposed situations. The lowest members of the series (*Riccia*) possess the simplest sporogonia known, consisting of a wall of one layer of cells enclosing the spores. In the higher forms a sterile foot and seta is present, and sterile cells or elaters occur with the spores. The lower members of the Jungermanniales are also thalloid, but the thallus never has the complicated structure characteristic of the Marchantiales, and progress is in the direction of the differentiation of the plant into stem and leaf. Indications

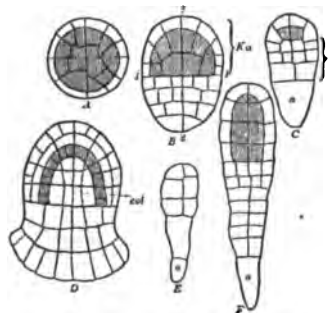

FIG. 4. — Semi-diagrammatic figures of young embryos of Liverworts in longitudinal section. The cells which will produce the sporogenous tissue are shaded. (After Kienitz-Gerloff and Leitgeb.)

- A. *Riccia*. D. *Anthoceros laevis*.
 B. *Marchantia polymorpha*. E. *Cephalosia bicuspida*.
 C. *Pellia epiphylla*. F. *Radula complanata*.

of how this may have come about are afforded by the lower group of the Anacrogynous Jungermanniaceae, and throughout the Acrogynous Jungermanniaceae the plant has well-marked stem and leaves. The sporogonium even in the simplest forms has a sterile foot, but in this series also the origin of elaters from sterile cells can be traced. The Anthocerotales are a small and very distinct group, in which the gametophyte is a thallus, while the sporogonium possesses a sterile columella and is capable of long-continued growth and spore production. The mode of development of the sporogonium presents important differences in the three series that may be briefly referred to here. In fig. 4 young sporogonia of a number of liverworts are shown in longitudinal section, and the archesporial cells from which the spores and elaters will arise are shaded. In *Riccia* (fig. 4, A) the whole mass of cells derived from the ovum forms a spherical capsule, the only sterile tissue being the single layer of peripheral cells forming the wall. In other Marchantiales (fig. 4, B) the lower half of the embryo separated by the first transverse wall (x, 1) forms the sterile foot and seta, while in the upper half (ka) the peripheral layer forms the wall of the capsule, enclosing the archesporial cells from which spores and elaters arise. In the Jungermanniales (fig. 4, C, E, F) the embryo is formed of a number of tiers of cells, and the archesporium is defined by the first divisions parallel to the surface in the cells of one or more of the upper tiers; a number of tiers go to form the seta and foot, while the lowest segment (a) usually forms a small appendage of the latter. In the Anthocerotales (fig. 4, D) the lowest tiers form the foot, and the terminal tier the capsule. The first periclinal divisions in the cells of the terminal tier separate a central group of cells which form the sterile columella (col). The archesporium arises by the next divisions in the outer layer of

cells, and thus extends over the summit of the columella. In none of the liverworts does the sporogonium develop by means of an apical cell, as is the rule in mosses.

Leaving details of form and structure to be considered under the several groups, some general features of the Hepaticae may be looked at here in relation to the conditions under which the plants live. The organization of the gametophyte stands in the closest relation to the factors of light and moisture in the environment. With hardly an exception the liverworts are dorsiventral, and usually one side is turned to the substratum and the other exposed to the light. In thalloid forms a thinner marginal expansion or a definite wing increasing the surface exposed to the light can be distinguished from a thicker midrib serving for storage and conduction. The leaves and stem of the foliose forms effect the same division of labour in another way. The relation of the plant to its water supply varies within the group. In the Marchantiales the chief supply is obtained from the soil by the rhizoids, and its loss in transpiration is regulated and controlled. In most liverworts, on the other hand, water is absorbed directly by the whole general surface, and the rhizoids are of subordinate importance. Many forms only succeed in a constantly humid atmosphere, while others sustain drying for a period, though their powers of assimilation and growth are suspended in the dry state. The cell-walls are capable of imbibing water rapidly, and their thickness stands in relation to this rather than to the prevention of loss of water from the plant. The large surface presented by the leafy forms facilitates the retention and absorption of water. The importance of prolonging the moistened condition as long as possible is further shown by special adaptations to retain water either between the appressed lobes of the leaves or in special pitcher-like sacs. In thalloid forms fimbriate or lobed margins or outgrowths from the surface lead to the same result. Sometimes adaptations to protect the plant during seasons of drought, such as the rolling up of the thallus in many xerophytic Marchantiales, can be recognized, but more often a prolonged dry season is survived in some resting state. The formation of subterranean tubers, which persist when the rest of the plant is killed by drought, is an interesting adaptation to this end, and is found in all three groups (e.g. in species of *Riccia*, *Fasciobranchia* and *Anthoceros*). No examples of total saprophytism or of parasitism are known, but two interesting cases of a symbiosis with other organisms which is probably a mutually beneficial one, though the nature of the physiological relation between the organisms is not clearly established, may be mentioned. Fungal hyphae occur in the rhizoids and in the cells of the lower region of the thallus of many liverworts, as in the endotrophic mycorrhiza of higher plants. Colonies of *Nostoc* are constantly found in the Anthocerotaceae and in *Blasia*. In the latter they are protected by special concave scales, while in the Anthocerotaceae they occupy some of the mucilage slits between the cells of the lower surface of the thallus.

Other adaptations concern the protection of the sexual organs and sporogonia, and the retention of water in the neighbourhood of the archegonia to enable the spermatozoid to reach the ovum. In thalloid forms the sexual organs are often sunk in depressions, while in the foliose forms protection is afforded by the surrounding leaves. In addition special involucrets around the archegonia have arisen independently in several series. The characters of the sporogonium have as their object the nutrition and effective distribution of the spores, and only exceptionally, as in the Anthocerotaceae, are concerned with independent assimilation. In most forms the capsule is raised above the general surface at the time of opening, usually by the rapid growth of the seta, but in the Marchantiaceae by the sporogonia being raised on a special archegoniophore. The elaters serve as lines of conduction of plastic material to the developing spores, and later usually assist in their dispersal. The spores, with few exceptions, are unicellular when shed, and may develop at once or after a resting period. In their germination a short filament of a few cells is usually developed, and the apical cell of the plant is established in the terminal cell. In other cases a small plate or mass of cells is formed. With one or two exceptions, however, this preliminary

phase, which may be compared with the protonema of mosses, is of short duration.

The power of vegetative propagation is widely spread. When artificially divided small fragments of the gametophyte are found to be capable of growing into new individuals. Apart from the separation of branches by the decay of older portions, special gemmae are found in many species. In *Aesura* the contents of superficial cells, after becoming surrounded by a new wall and dividing, escape as bi-cellular gemmae. Usually the gemmae arise by the outgrowth of superficial cells, and become free by breaking away from their stalk. When separated they may be single cells or consist of two or numerous cells. In *Blasia* and *Marchantia* the gemmae are formed within tubular or cup-shaped receptacles, out of which they are forced by the swelling of mucilage secreted by special hairs.

Marchantiales.—The plants of this group are most abundant in warm sunny localities, and grow for the most part on soil or rocks often in exposed situations. Nine genera are represented in Britain. *Targionia* is found on exposed rocks, but the other forms are less strikingly xerophytic; *Marchantia*, *polymorpha* and *Lessularia* spread largely by the gemmae formed in the special gemma-cups on the thallus, and occur commonly in greenhouses. The large thallus of *Conocephalus* covers stones by the waterside, while *Dumortiera* is a hygrophite confined to damp and shady situations. Among the Ricciaceae, most of which grow on soil, *Ricciocarpon* and *Riccia salina* occur floating on still water. The dorsiventral thallus is constructed on the same plan throughout the group, and shows a lower region composed of cells containing little chlorophyll and an upper stratum specialized for assimilation and transpiration. The lower region usually forms a more or less clearly marked midrib, and consists of parenchymatous cells, some of which may contain oil-bodies or be differentiated as mucilage cells or sclerenchyma fibres. Behind the apex, which has a number of initial cells, a series of amphigastria or ventral scales is formed. These consist of a single layer of cells, and their terminal appendages often fold over the apex and protect it. Usually they stand in two rows, but sometimes accessory rows occur, and in *Riccia* only a single median row is present. The thallus bears two sorts of rhizoids, wider ones with smooth walls which grow directly down into the soil, and longer, narrower ones, with peg-like thickenings of the wall projecting into the cell-cavity. The peg-rhizoids, which are peculiar to the group, cover under shelter of the amphigastria to the midrib, beneath which they form a wick-like strand. Through this water is conducted by capillarity as well as in the cell cavities. The upper stratum of the thallus is constructed to regulate the giving off of the water thus absorbed. It consists of a series of air-chambers (fig. 6, B) formed by certain lines of the superficial cells growing up from the surface, and as the thallus increases in area continuing to divide so as to root in the chamber. The layer forming the roof is called the "epidermis," and the small opening leading into the chamber is bounded by a special ring of cells and forms the "stoma," or air-pore. In most species of *Riccia* the air-chambers are only narrow passages, but in the other Marchantiales they are more extended. In the

forms, may become barrel-shaped structures by the division of the ring of cells bounding the pore. In some cases the lowermost circle of cells can be approximated so as to close the pore. In *Dumortiera* the air-chambers are absent, their formation being only indicated at the apex.

The sexual organs are always situated on the morphologically upper surface of the thallus. In *Riccia* they are scattered singly and protected by the air-chamber layer. The scattered position of the antheridia is also found in some of the higher forms, but usually

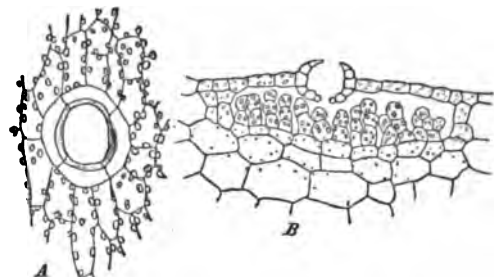

From Strasburger's *Text-book of Botany*.

FIG. 6.—*Marchantia polymorpha*. A, Stoma in surface view; B, Air-chamber with the filaments of assimilating cells and stoma in vertical section.

they are grouped on special antheridiophores which in *Marchantia* are stalked, disk-shaped branch-systems (fig. 5). The individual antheridia are sunk in depressions from which the spermatozooids are in some cases forcibly ejected. The archegonium groups in *Corsinia* are sunk in a depression of the upper surface, while in *Targionia* they are displaced to the lower side of the anterior end of a branch. In all the other forms they are borne on special archegoniophores which have the form of a disk-shaped head borne on a stalk. The archegoniophore may be an upgrowth from the dorsal surface of the thallus (e.g. *Plagiochasma*), or the apex of the branch may take part in its formation. When the disk, around which archegonia are developed at intervals, is simply raised on a stalk-like continuation of the branch, a single groove protecting a strand of peg-rhizoids is found on the ventral face of the stalk (*Reboulia*). In the highest forms (e.g. *Marchantia*) the archegoniophore corresponds to the repeatedly branched continuation of the thallus, and the archegonia arise in relation to the growing points which are displaced to the lower surface of the disk. In this case two grooves are found in the stalk. The archegonia are protected by being sunk in depressions of the disk or by a special two-lipped involucre. In *Marchantia* and *Fimbriaria* an additional investment termed in descriptive works the perianth, grows up around each fertilized archegonium (fig. 1, 3, d). The simple sporogonium found in the Ricciaceae (fig. 4, A) has been described above; as the spores develop, the wall of the spherical capsule is absorbed and the spores lie free in the calyptra, by the decay of which they are set free. In *Corsinia* the capsule has a well-developed foot, but the sterile cells found among the spore-mother-cells do not become elaters, but remain thin-walled and simply contribute to the nutrition of the spores. In all other forms elaters with spirally thickened walls are found. The seta is short, the capsule being usually raised upon the archegoniophore. Dehiscence takes place either by the upper portion of the capsule splitting into short teeth or falling away as a whole or in fragments as a sort of operculum. The spores on germination form a short germ-tube, in the terminal cell of which the apical cell is established, but the direction of growth of the young thallus is usually not in the same straight line as the germ-tube. The Marchantiales are divided into a number of groups which represent distinct lines of advance from forms like the Ricciaceae, but the details of their classification cannot be entered upon here. The general nature of the progression exhibited by the group as a whole will, however, be evident from the above account.

Jungermanniales.—This large series of liverworts, which presents great variety in the organization of the sexual generation, is divided into two main groups according to whether the formation of archegonia terminates the growth of the branch or does not utilize the apex. The latter condition is characteristic of the more primitive group of the Anacrogynous Jungermanniaceae, in which the branch continues its growth after the formation of archegonia so that they (and later the sporogonia) stand on the dorsal surface of the thallus or leafy plant. In the Acrogynous Jungermanniaceae the plant is throughout foliose, and the archegonia occupy the ends of the main shoot or of its branches. The antheridia are usually globular and long-stalked. The capsule opens by splitting into four halves.

Jungermanniaceae Anacrogynae.—The great range of form in the sexual plant is well illustrated by the nine genera of this group

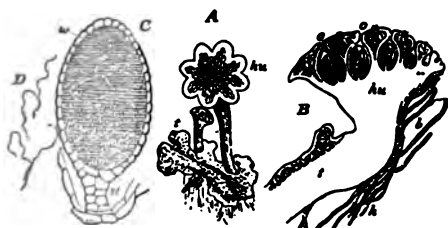
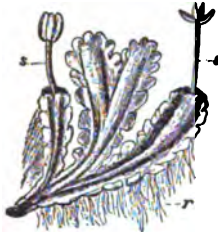

FIG. 5.—*Marchantia polymorpha*. (After Sacha.)

- A. Portion of thallus (*t*) bearing two stalked antheridiophores (*Au*).
 B. Longitudinal section through a young antheridiophore. The antheridia (*a*) are seated in depressions of the upper surface (*o*); *b*, scales; *h*, rhizoids.
 C. Longitudinal section of antheridium; *st*, stalk; *w*, wall.
 D. Two spermatozooids.

simplest cases the sides and base of the chambers perform the work of assimilation (e.g. *Corsinia*). Usually the surface is extended by the development of partitions in the chambers (*Reboulia*), or by the growth from the floor of the chamber of short filaments of chlorophyllous cells (*Targionia*, *Marchantia*, fig. 6). The stomata may be simply surrounded by one or more series of narrower cells, or, as in the thallus of *Marchantia* and on the archegoniophores of other

which occur in Britain. One thalloid form has already been described in *Pellia* (fig. 2). *Sphaerocarpus*, which occurs rarely in stubble fields, is in many respects one of the simplest of the liverworts. The small thallus bears the antheridia and archegonia, each of which is surrounded by a tubular involucre, on the upper surface of distinct individuals. The sporogonium has a small foot, but the sterile cells among the spores do not develop into elaters. The same is true of the capsule of *Riella*. The plants of this genus, none of the species of which are British, grow in shallow water rooted in the mud, and are unlike all other liverworts in appearance. The usually erect thallus has a broad wing-like outgrowth from the dorsal surface and two rows of rather large scales below. No provision for the opening of the capsule exists in either of these genera. In *Aneura* the form of the plant may be complicated by a division of labour between root-like, stem-like and assimilating branches of the thallus. The sexual organs are borne on short lateral branches, while in the related genus *Metzgeria*, which occurs on rocks and tree trunks, the small sexual branches spring from the lower surface of the midrib of the narrow thallus. In these two genera the elaters are attached to a sterile group of cells projecting into the upper end of the capsule, and on dehiscence remain connected with the tips of the valves. *Palaemonia* and some related genera have a definite midrib and broad wings formed of one layer of cells, and are of interest owing to the presence of a special water-conducting strand in the midrib. This consists of elongated lignified cells with pitted walls. *Blasia pusilla*, which occurs commonly by ditches and streams, affords a transition to the foliose types. Its thallus (fig. 7) has thin marginal lobes of limited growth, which are comparable to the more definite leaves of other anacrogynous forms. The ventral surface bears flat scales in addition to the concave scales which, as mentioned above, are inhabited by *Nostoc*. This interesting liverwort produces two kinds of gemmae, and in the localities in which it grows is largely reproduced by their means. In *Fossombronia*, of which there are a number of British species, the plant consists of a flattened stem creeping on muddy soil and bearing two rows of large obliquely-placed leaves.



From Strasburger's *Text-book of Botany*.

FIG. 7.—*Blasia pusilla*. The margin of the thallus bears leaf-like lobes. *r*, Rhizoids; *s*, sporogonium.

The erect branches bear three rows of leaves, and spring from a creeping axis from which root-like branches destitute of rhizoids extend into the substratum.

Jungermanniaceae Acrogynae.—The plant consists of leafy shoots, the origin of which can be understood in the light of the foliose forms described above. The great majority of existing liverworts belong to this group, the general plan of construction of which is throughout very similar. In Britain thirty-nine genera with numerous species are found. With few exceptions the stem grows by means of a pyramidal apical cell cutting off three rows of segments. Each segment gives rise to a leaf, but usually the leaves of the ventral row (amphigastria) are smaller and differently shaped from those of the two lateral rows; in a number of genera they are wanting altogether. Sometimes the leaves retain their transverse insertion on the stem, and the two lobes of which they consist are developed equally. More often they come to be obliquely inserted, the anterior edge of each leaf lying under or over the edge of the leaf in front. The two lobes are often unequally developed. In *Scapania* the upper lobe is the smaller, while in *Radula*, *Porella* and the *Lejuneae* this is the case with the lower lobe. The folding of one lobe against another assists in the retention of water. Pitcher-like structures have arisen in different ways in a number of genera, and are especially common in epiphytic forms (*Frullania*, *Lepidolaena*, *Pleurozia*). In some forms the leaves are finely divided, and along with the hair-like paraphyllia form a loose felt around the stem (*Trichocolea*). The rhizoids spring from the lower surface of the stem, and sometimes from the bases of the leaves. The branches arise below and by the side of the leaves.

The sexual organs may occur on the same or on distinct individuals. The antheridia are protected by leaves which are often modified in shape. The archegonia are borne at the apex of the main stem or of a lateral branch. A single archegonium may arise from the apical cell (*Lejunea*); more commonly a number of others are formed from the surrounding segments. The leaves below the archegonial group are frequently modified in size and shape, but the chief pro-

tection is afforded by a tubular perianth, which corresponds to a coherent whorl of leaves and grows up independently of fertilization. The perianth serves also to enclose and protect the sporogonium during its development. In a number of forms belonging to different groups the end of the stem on which the sporogonium is borne grows

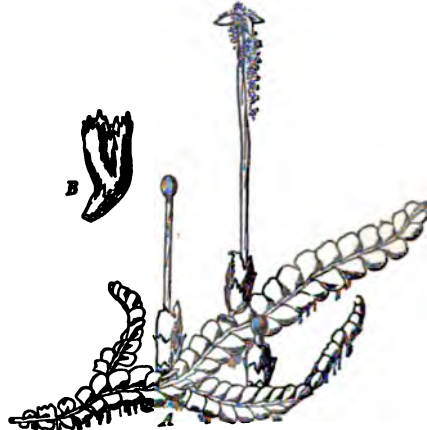

FIG. 8.—*Chiloscypus polyanthos*. The plant bears three mature sporogonia which show the elongation of the seta. One of the sporogonia has opened. B, The "perianth" with the small perichaetal leaves below it. (After Goebel.)

downwards so as to form a hollow tubular sac enclosing the sporogonium; in other cases this marasupial sac is formed by the base of the sporogonium boring into the thickened end of the stem. The sac usually penetrates into the soil and bears rhizoids on its outer surface. *Kastia*, *Calyptogia* and *Saccogyna* are British forms, which have their sporogonia protected in this way. The sporogonium is very similar throughout the group (figs. 8, 9). At maturity the seta elongates rapidly, and the wall of the capsule splits more or less completely into four valves, allowing the elaters and spores to escape. In the *Jubuloidae*, which in other respects form a well-marked group, the seta is short and the elaters extend from the upper part of the capsule to the base; at dehiscence they remain fixed to the valves into which the capsule splits. The germinating spore usually

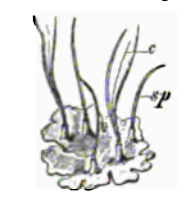

FIG. 9.—*Cephalonia bicuspata*. Longitudinal section of the summit of a shoot bearing a nearly mature sporogonium, *sp*, still enclosed in the calshoot (*Pteropsiella*, *Zoopis*). *yp*, *ar*, archegonium which have never been unfertilized; *st*, stem; *k*, leaf. The Acrogynous Jungermanniaceae fall into a *p*, perianth. (After Hofmeister.)

number of natural groups, which cannot, however, be followed out here. They occur in very various situations, on the ground, on rocks and stones, on tree trunks, and, in the damp tropics, on leaves. Usually they form larger or smaller tufts of a green colour, but some forms have a reddish tint.

Anthocerotales.—This small and very natural group includes the three genera *Anthoceros*, *Dendroceros* and *Notholobos*, and stands in

many respects in an isolated position among the Bryophyta. Three species of *Anthoceros* occur in Britain, growing on the damp soil of fields, ditches, &c. The dark green thallus has an ill-defined midrib, and is composed of parenchymatous cells. In each assimilating cell there is usually a single large chloroplast. The apical region, which has a single initial cell, is protected by mucilage secreted by the mucilage slits, which are small pit-like depressions between superficial cells of the lower surface. Mucilage is also often formed in intercellular spaces within the thallus. Colonies of *Nostoc* are constantly found living in some of the mucilage slits which then become enlarged. The sexual organs are scattered over the upper surface. The stalked globular antheridia are exceptional in being formed endogenously, and are situated in groups in special intercellular spaces.



From Strasburger's Text-book of Botany.

FIG. 10.—*Anthoceros laevis*. *sp.*, Sporogonium; *c.*, columella. (Nat. size.)
 The superficial layer of cells bounding the cavity does not break down until the antheridia are nearly mature. Occasionally antheridia develop on the surface of shaded portions of the thallus. The necks of the archegonia hardly project above the general surface of the thallus. In structure and development they agree with other Hepaticae, though differences of detail exist. The young sporogonium is protected by a thick calyptra derived from the tissue of the thallus around the archegonium. The sporogonium consists of a large bulbous foot, the superficial cells of which grow out into processes, and a long capsule, which continues to grow for months by the activity of a zone of cells between it and the foot, and may attain the length of an inch and a half. The wall of the capsule is several layers of cells thick, and since the epidermis contains functional stomata and the underlying cells possess chlorophyll it is capable of assimilation. In the centre of the capsule is a strand of narrow elongated cells forming the columella, and between this and the wall spores mixed with elaters are formed from the dome-shaped archesporium, the origin of which has already been described (fig. 4, D). The capsule opens by splitting into two valves from the apex downwards, and the mature spores escape while others are developing in succession below. In *Dendroceros*, which grows as an epiphyte in the tropics, the thallus has a well-defined midrib and broad wings composed of a single layer of cells. The capsule is similar to that of *Anthoceros*, but has no stomata, and the elaters have spirally thickened walls. Some species of *Anthoceros* agree with it in these respects. *Notolythys* resembles *Anthoceros* in its thallus, but the sporogonium is much smaller. In some species, although the columella and archesporium arise in the usual way, both give rise to mingled spores and elaters, and no sterile columella is developed.

Mosci (Mosses).

Though the number of species of mosses is far greater than of liverworts, the group offers much less diversity of form. The sexual generation is always a leafy plant, which is not developed directly from the spore but is borne on a well-marked and usually filamentous protonema. The general course of the life-history and the main features of form and structure will be best understood by a brief account of a particular example.

Funaria hygrometrica is a moss of very common occurrence even in towns on the soil of paths, at the foot of walls and in similar places. The small plants grow closely crowded in tufts, and consist of short leafy shoots attached to the soil by numerous fine rhizoids. The latter, in contrast to the rhizoids of liverworts, are composed of rows of elongated cells and are branched. The leaves are simple, and except for the midrib are only one layer of cells thick. The structure of the stem though simple is more complicated than in any liverwort. The superficial cells are thick-walled, and there is a central strand of narrow cells forming a water-conducting tissue. The small strand of elongated cells in the midrib of the leaf runs down into the stem, but is not usually connected with the central strand. The sexual organs are developed in groups at the apices, the antheridial group usually terminating the main axis while the archegonia are borne on a lateral branch. The brown tint of the hair-like paraphyses mixed with antheridia (fig. 15) makes the male branch conspicuous, while the archegonia have to be carefully looked for enclosed by the surrounding leaves (fig. 16, B). The sporogonium developed from the fertilized ovum grows by means of a two-sided apical cell (fig. 16 A), and is at first of uniform thickness. After a time the upper region increases in diameter and forms

the capsule, while the lower portion forms the long seta and the foot which is embedded in the end of the stem. With the growth of the sporogonium the archegonial wall, which for a time kept

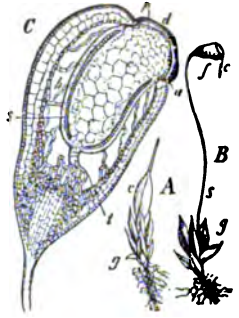

(From Guebel's Pflanzenmorphologie, by permission of W. Engelmann.)

FIG. 11.—*Funaria hygrometrica*.
A. Leafy shoot (*g*) bearing a young sporogonium enclosed in the calyptra (*c*).
B. Similar plant with an almost mature sporogonium; *s*, seta; *f*, capsule; *c*, calyptra.
C. Median longitudinal section of a capsule, with the seta gradually widening into the apophysis at its base; *d*, operculum; *p*, peristome; *a*, annulus; *c*, columella; *s*, archesporium; *h*, air-space between the spore-sac and the wall of the capsule.
 The central region extending between the apophysis and the operculum is composed of sterile tissue and forms the columella (*c*). Immediately around this is the layer of cells from which the spores will be developed (*s*), and the layers of cells on either side of this form the walls of the spore-sac, which will contain the spores. Between the wall of the capsule, which is composed of several layers of cells, and the spore-sac is a wide intercellular space (*h*) bridged across by trabeculae consisting of rows of chlorophyll-containing cells. At the junction of the operculum (*d*) with the rest of the capsule is a circle of cells forming the

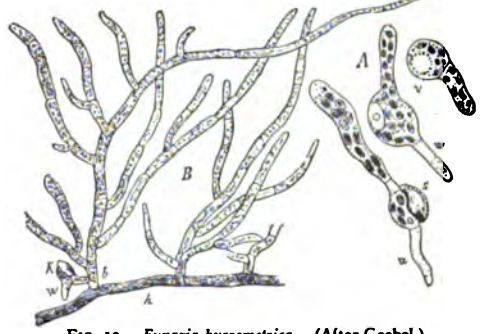

FIG. 12.—*Funaria hygrometrica*. (After Goebel.)

A. Germinating spores. *s*, Wall of spore; *v*, vacuole; *w*, rhizoid.
B. Part of a developed protonema. *h*, Creeping filament annulus (*a*), by help of which the operculum is detached at maturity as a small lid. Its removal does not, however, leave the mouth of the capsule wide open, for around the margin are two circles of pointed teeth forming the peristome. These are the thickened cell-walls of a definite layer of cells (*p*), and appear

as separate teeth owing to the breaking down of the unthickened cell-walls. The numerous spores which have been developed in the spore sac can thus only escape from the pendulous capsule through narrow slits between the teeth, and these are closed in damp air. The unicellular spores when supplied with moisture germinate (fig. 12) and give rise to the sexual generation. A filamentous protonema is first developed, some of the branches of which are exposed to the light and contain abundant chlorophyll, while others penetrate the substratum as brown or colourless rhizoids. The moss-plants arise from single projecting cells, and numerous plants may spring from the protonema developed from a single spore.

The majority of the mosses belong to the same great group as *Funaria*, the Bryales. The other two subdivisions of the Musci are each represented by a single genus. In the Andreaeales the columella does not extend to the upper end of the capsule, and the latter opens by a number of lateral slits. The Sphagnales also have a dome-shaped spore-sac continued over the columella, and, though their capsule opens by an operculum, they differ widely from other mosses in the development of the sporogonium as well as in the characters of the sexual generation. The three groups are described separately below, but some more general features of the mosses may be considered here.

On the whole mosses grow in drier situations than the liverworts, and the arrangements they present for the conduction of water in the plant are also more complete and suggest in some cases comparisons with the higher plants. In spite of this, however, they are in great part dependent on the absorption of water through the general surface of the shoot, and the power of rapid imbibition possessed by their cell-walls, the crowded position of the small leaves on the stem, and special adaptations for the retention of water on the surface, have the same significance as in the foliose liverworts. The different appearance of exposed mosses in dry weather and after a shower illustrates this relation to the water supply. The protonema is always a well-marked stage in the life-history. Not only does a moss-plant never arise directly from the spore, but in all cases of vegetative reproduction, apart from the separation of branches by decay of older regions of the plant, a protonema is found. Usually the protonema is filamentous and ceases to be evident after the plants have developed. But in some small mosses (e.g. *Ephemerum*) it plays the chief part in assimilation and lives on from year to year. In *Sphagnum*, *Andreaea* and some genera of the Bryales the protonema or some of its branches have the form of flat plates or masses of cells. The formation of the moss-plant on the protonema is always from a single cell and is similar in all mosses. The first three walls in this cell intersect one another, and define the three-sided pyramidal apical cell by means of which the shoot continues to grow. In *Fissidens* and a few other mosses the apical cell is two-sided. The leaves formed by the successive segments gradually attain their normal size and structure. Each segment of the initial cell gives rise to a leaf and a portion of the stem; the branches arise from the lower portion of a segment and stand immediately below a leaf. The leaves may form three vertical rows, but usually their arrangement, owing to the direction of the segment walls at the apex, becomes more complicated. Their growth proceeds by means of a two-sided apical cell, and the midrib does not become more than one cell thick until later. In addition to the leaves the stem often bears hair-like structures of different kinds, some of which correspond to modified branches of protonema. The branched filamentous rhizoids which spring from the lower region of the stem also correspond to protonemal branches. The structure of both stem and leaf reaches a high grade of organization in some mosses. Not only are thick-walled sclerenchymatous cells developed to give rigidity to the periphery of the stem and the midrib of the leaf, but in many cases a special water-conducting tissue, consisting of elongated cells, the end walls of which are thin and oblique, forms a definite central strand in the stem. In the forms in which it is most highly developed (Polytrichaceae) this tissue, which is comparable with the xylem of higher plants, is surrounded by a zone of

tissue physiologically comparable to phloem, and in the rhizome may be limited by an endodermis. The conducting strands in the leaves show the same tissues as in the central strand of the stem, and in the Polytrichaceae and some other mosses are in continuity with it. The independent origin of this conducting system is of great interest for comparison with the vascular system of the sporophyte of the higher plants.

The sexual organs, with the exception of the antheridia of *Sphagnum*, are borne at the apices of the main shoot or of branches. Their general similarity to the mature antheridia and archegonia of liverworts and the main difference in their development have been referred to. The antheridia open by means of a cap cell or groups of cells with mucilaginous contents. The details of construction of the sporogonium are referred to below. In all cases (except *Archidium*) a columella is present, and all the cells derived from the archesporium produce spores, no claters being formed. In a few cases the germination of the spore commences within the capsule. The development of the sporogonium proceeds in all cases (except in *Sphagnum*) by means of an apical cell cutting off two rows of segments. The first periclinal division in the region forming the capsule separates an inner group of cells (the endothecium) from the peripheral layer (amphithecium). In *Sphagnum*, as in *Anthoceros*, the archesporium is derived from the amphithecium; in all other mosses it is the outermost layer of the endothecium.

Vegetative propagation is widely spread in the mosses, and, as mentioned above, a protonema is always formed in the development of the new plant. The social growth of the plants characteristic of many mosses is a result of the formation of numerous plants on the original protonema and on developments from the rhizoids. Besides this, gemmae may be formed on the protonema, on the leaves or at the apex, and some mosses have specialized shoots for their better protection or distribution. Thus in *Georgia* the stalked, multicellular gemmae are borne at the ends of shoots surrounded by a rosette of larger leaves, and in *Aulacomnium androgynum* they are raised on an elongated leafless region of the shoot. In other cases detached leaves or shoots may give rise to new plants, and when a moss is artificially divided almost any fragment may serve for reproduction.

Even in those rare cases in which the sexual generation can be developed without the intervention of spore production from the tissues of the sporogonium, a protonema is formed from cut pieces of the seta or in some cases from intact sporogonia still attached to the plant. This phenomenon of *apospory* was first discovered in mosses, but is now also known in a number of ferns (see PTERIDOPHYTES).

Sphagnales.—The single genus *Sphagnum* occupies a very distinct and isolated position among mosses. The numerous species, which are familiar as the bog-mosses, are so similar that minute structural characters have to be relied on in their identification. The plants occur in large patches of a pale green or reddish colour on moor, and when filling up small lakes or pools, may attain a length of some feet. Their growth has always a large part in the formation of peat. The species are distributed in temperate and arctic climates, but in the tropics only occur at high levels. The protonema forms a flat, lobed, thalloid structure attached to the soil by rhizoids, and the plants arise from marginal cells. The main shoot bears numerous branches which appear to stand in whorls; some of them bend down and become applied to the surface of the main axis. The structure of the stem and leaves is peculiar. The former shows on cross-section a thin-walled central tissue surrounded by a zone of thick-walled cells. Outside this come one to five layers of large clear cells, which when mature are dead and empty; their walls are strengthened with a spiral thickening and perforated with round pores. They serve to absorb and conduct water by capillarity. The leaves have no midrib and similar empty cells occur regularly among the narrow chlorophyll-containing cells, which thus appear as a green network. The antheridia are globular and have long stalks. They stand by the side of leaves of special club-shaped branches. The archegonia occupy the apices of short branches (fig. 13, A.). The mature sporogonium consists of a wide foot separated by a constriction from the globular capsule (B). There is no distinct seta, but the capsule is raised on a leafless outgrowth of the end of the branch called a pseudopodium (C, *gr.*). The capsule, the wall of which bears rudimentary stomata, has a small operculum but no peristome. There is a short, wide columella, over which the dome-shaped spore-sac extends, and no air-space is present between the spore-sac and the wall. In the embryo a number of tiers of cells are first formed. The lower tiers

form the foot, while in the upper part the first divisions mark off the columella, around which the archesporium, derived from the amphithecium, extends. The sporogonium when nearly mature bursts the calyptra irregularly. The capsule opens explosively in dry weather, the operculum and spores being thrown to a distance. The spore on germination forms a short filament which soon broadens out into the thalloid protonema. Some twelve species of *Sphagnum* are found in Britain.

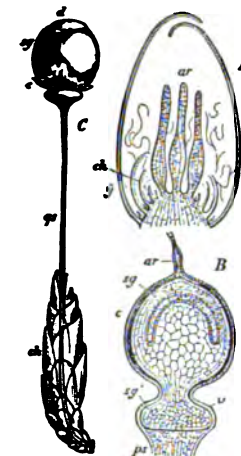

From Goebel's *Phaenogamie pteridic.*
FIG. 13.—*Sphagnum acutifolium*.
(After Schimper.)

- A. Longitudinal section of apex of a bud bearing archegonium (ar), enclosed by the large leaves (y); ch, small perichaetal leaves.
- B. Longitudinal section of the sporogonium borne on the pseudopodium (ps); c, calyptra; ar, neck of archegonium; sg, foot; sg, capsule.
- C. *S. squarrosum*. Ripe sporogonium raised on the pseudopodium (ps) above the enclosing leaves (ch); c, the ruptured calyptra; sg, capsule; d, operculum.

between five and six hundred species belonging to more than one hundred genera are found. They occur in the most varied situations, on soil, on rocks and trees, and, in a few instances (*Fossilsia*), in water. Although exhibiting a wide range in size and in the structural complexity of both generations, they all conform to a general type, so that *Funaria*, described above, will serve as a fair example of the group. The protonema is usually filamentous, and in some of the simplest forms is long-lived, while the small plants borne on it serve mainly to protect the sexual organs and sporogonium. This is the case in *Ephemerus*, which grows on the damp soil of clayey fields, and the plants are even more simply constructed in *Buxbaumia*, which occurs on soil rich in humus and is possibly partially saprophytic. In this moss the filamentous protonema is capable of assimilation, but the leaves of the small plants are destitute of chlorophyll, so that they are dependent on the protonema. The male plant has no definite stem, and consists of a single concave leaf protecting the antheridium. The female plant is rather more highly organized, consisting of a short stem bearing a few leaves around the group of archegonia. The sporogonium is of large size and highly organized, though it presents peculiar features in the peristome. *Buxbaumia* has been regarded by Goebel as representing a stage which other mosses have passed, and has been described by him as the simplest type of moss. In *Ephemerus* also we may probably regard the relation of the small plants to the protonema as a primitive one. On the other hand, in the case of *Ephemeropsis*, which grows on the leaves of living plants in Java, the high organization of the sporogonium makes it probable that the persistent protonema is an adaptation to the peculiar conditions of life. A highly developed protonema provided with leaf-like assimilating organs is found in *Georgia*, *Diphyscium* and *Oedipodium*, all of which show peculiarities in the sporogonium as well. The cells of the

protonema of *Schistostega*, which lives in the shade of caves, are so constructed as to concentrate the feeble available light on the chloroplasts.

We may perhaps regard the persistent protonema bearing small leafy plants as a primitive condition, and look upon those larger plants which remain unbranched and bear the sexual organs at the apex (e.g. *Schistostega*) as representing the next stage. From this condition different lines of specialization in the form and structure of the plant can be recognized. A large number of mosses stand at about the same grade as *Funaria*, in that the plants are small, sparingly branched, usually radial, and do not show a very highly differentiated internal structure. In others the form of the plant becomes more complex by copious branching and the differentiation of shoots of different orders. In these cases the shoot system is often more or less dorsiventral, and the sexual organs are borne on short lateral branches (e.g. *Thuidium tamariscinum*). The Polytrichaceae, on the other hand, show a specialization in structure rather than in form. The high organization of their conducting system has been referred to above, but though many species are able to exist in relatively dry situations, the plants are still dependent on the absorption of water by the general surface. The parallel lamellae of assimilating cells which grow from the upper surface of the leaf in case of some other mosses, probably serve to retain water in the neighbourhood of the assimilating cells and so prolong their activity. As common adaptive features in the leaves the occurrence of papillae or outgrowths of the cell-walls to retain water, and the white hair-like leaf tips, which assist in protecting the young parts at the apex of many xerophytic mosses, may be mentioned. The leaves of *Leucobryum*, which occurs in pale green tufts in shaded woods, show a parallel adaptation to that found in *Sphagnum*. They are several cells thick, and the small assimilating cells lie between two layers of empty water-storage cells, the walls of which are perforated by pores.

With the possible exception of *Archidium*, the sporogonium is throughout the Bryales constructed on one plan. *Archidium* is a small moss occurring occasionally on the soil of wet fields. The protonema is not persistent, and the plants are well developed, resembling those of *Pleuridium*. The sporogonium has a small foot and practically no seta, and differs in the development and structure of its capsule from all other mosses. The spores are derived from the endothecium, but no distinction of a sterile columella and an archesporium is established in this, a variable number of its cells becoming spore-mother-cells while the rest serve to nourish the spores.

The layer of cells immediately around the endothecium becomes the spore-sac, and an air-space forms between this and the wall of the capsule. The very large, thin-walled spores escape on the decay of the capsule, which ruptures the archegonium wall irregularly. On account of the absence of a columella *Archidium* is sometimes placed in a distinct group, but since its peculiarities have possibly arisen by reduction it seems at present best retained among the Bryales. In all other Bryales there is a definite columella extending from the base to the apex of the capsule, the archesporium is derived from the outermost layer of cells of the endothecium, and an air space is formed between the spore-sac and the wall. In the Polytrichaceae another air space separates the spore-sac from the columella. There is great variety in the length of the seta, which is sometimes practically absent. The apophysis, which may be a more or less distinct region, usually bears stomata and is the main organ of assimilation. In the Splachnaceae it is expanded for this purpose, while in *Oedipodium* it constitutes most of the long pale stalk which supports the capsule. A distinct operculum is usually detached by the help of the annulus, and its removal may leave the mouth of the capsule widely open. More usually there is a peristome, consisting of one or two series of teeth, which serves to narrow the opening and in various ways to ensure the gradual shedding of the spores in dry weather. In most mosses the teeth are portions of thickened cell-walls, but in the Polytrichaceae they are formed of a number of sclerenchymatous cells. In *Polytrichum* a membranous epiphragm stretches across the wide mouth of the capsule between the tips of the short peristome teeth, and closes the opening except for the interspaces of the peristome.

In a number of forms, which were formerly grouped together, the capsule does not open to liberate the spores. These cleistocarpous forms are now recognized as related to various natural groups, in which the majority of the species possess an operculum. In such forms as *Phascum* the columella persists, and the only peculiarity is in the absence of arrangements for dehiscence. In *Ephemerus*



From Strasburger's *Text-book of Botany*.

FIG. 14.—*Andreaea petrophila*.
Plant bearing opened capsule.
(k) ps, Pseudopodium.
c, Calyptra.
sg, Foot of sporogonium.

In a number of forms, which were formerly grouped together, the capsule does not open to liberate the spores. These cleistocarpous forms are now recognized as related to various natural groups, in which the majority of the species possess an operculum. In such forms as *Phascum* the columella persists, and the only peculiarity is in the absence of arrangements for dehiscence. In *Ephemerus*

(and the closely related *Nanomitrium* which has a small operculum) the columella becomes absorbed during the development of the spores. Stomata are present on the wall of the small capsule. Such facts as these suggest that in many cases the cleistocarpous condition is the result of reduction rather than primitive, and that possibly the same holds for *Archidium*.

The former subdivision of the Bryales into Musci Cleistocarpici and Musci Stogocarpici according to the absence or presence of an operculum is thus clearly artificial. The same holds even more obviously for the grouping of the stegocarpous forms into those in which the archegonial group terminates a main axis (acrocarpi) and those in which it is borne on a more or less developed lateral branch (pleurocarpi). Modern classifications of the Bryales depend mainly on the construction of the peristome.

It remains to be considered to what extent the several natural groups of plants classed together in the Bryophyta can be placed in a phylogenetic relation to one another. Practically no help is afforded by palaeobotany, and only the comparison of existing forms can be depended on. The indications of probable lines of evolution are clearest in the Hepaticae. The Marchantiales

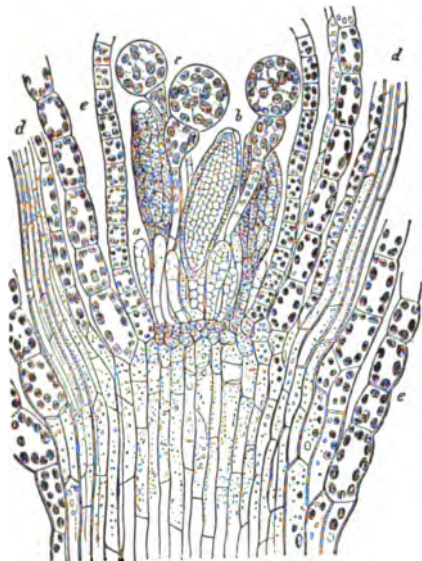

FIG. 15.—*Funaria hygrometrica*. Longitudinal section through the summit of a male branch. (After Sachs.)
a, Leaves. [ribs. c, Paraphyses. b, Antheridia.
d, Leaves cut through the mid-

form an obviously natural evolutionary group, and the same is probably true of the Jungermanniales, although in neither case can the partial lines of progression within the main groups be said to be quite clear. Such a form as *Sphaerocarpos*, which has features in common with the lower Marchantiales, enables us to form an idea of the divergence of the two groups from a common ancestry. The Anthocerotales, on the other hand, stand in an isolated position, and recent researches have served to emphasize this rather than to confirm the relationship with the Jungermanniales suggested by Leitgeb. The indications of a serial progression are not so clear in the mosses, but the majority of the forms may be regarded as forming a great phylogenetic group in the evolution of which the elaboration of the moss-plant has proceeded until the protonema appears as a mere preliminary stage to the formation of the plants. Parallel with the evolution of the gametophyte in form and structure, a progression can be traced in the sporogonium, although the simplest sporogonia available for study may owe much of their simplicity to reduction. The Andreaeales may perhaps be looked on as a divergent primitive branch of the same stock. On the other

hand, the Sphagnales show such considerable and important differences from the rest of the mosses, that like the Anthocerotales among the liverworts, they may be regarded as a group, the relationship of which to the main stem is at least problematical. Between the Hepaticae, Anthocerotales, Sphagnales and Musci, there are no connecting forms known, and it must be left as an open question whether the Bryophyta are a monophyletic or polyphyletic group.

The question of the relationship of the Bryophyta on the one hand to the Thallophyta and on the other to the Pteridophyta lies even more in the region of speculation, on slender grounds without much hope of decisive evidence. In a general sense we may regard the Bryophyta as derived from an algal ancestry, without being able to suggest the nature of the ancestral forms or the geological period at which they arose. Recent researches on those Algae such as *Colocleachae* which appeared to afford a close comparison in their alternation of generations with *Riccia*, have shown that the body resulting from the segmentation of the fertilized ovum is not so strictly comparable in the two cases as had been supposed. The series of increasingly complex sporogonia among Bryophytes appears to be most naturally explained on an hypothesis of progressive sterilization of sporogenous tissue, such as has been advanced by Bower. On the other hand there are not wanting indications of reduction in the Bryophyte sporogonium which make an alternative view of its origin at least possible. With regard to the relationship of the Bryophyta and Pteridophyta the article on the latter group should be consulted. It will be sufficient to say in conclusion that while the alternating generations in the two groups are strictly comparable, no evidence of actual relationship is yet forthcoming.

For further information consult: Campbell, *Mosses and Peas* (London, 1906); Engler and Prantl, *Die natürlichen Pflanzenfamilien*, Teil i. Abt. 3 (Leipzig, 1893-1907); Goebel, *Organography of Plants* (Oxford, 1905). Full references to the literature of the subject will be found in these works. For the identification of the British species of liverworts and mosses the following recent works will be of use: Pearson, *The Hepaticae of the British Isles* (London, 1902); Dixon and Jameson, *The Student's Handbook of British Mosses* (London, 1896); Braithwaite, *British Moss Flora* (London, 1887-1905). (W. H. L.)

BRZOWSKI, THADDEUS (d. 1820), nineteenth general of the Jesuits, was appointed in succession to Gabriel Gruber on the 2nd of September 1805. In 1801 Pius VII. had given the Jesuits liberty to reconstitute themselves in north Russia (see *Jesuits: History*), and in 1812 Brzowski secured the recognition of the Jesuit college of Polotak as a university, though he could not obtain permission to go to Spain to agitate for the recognition

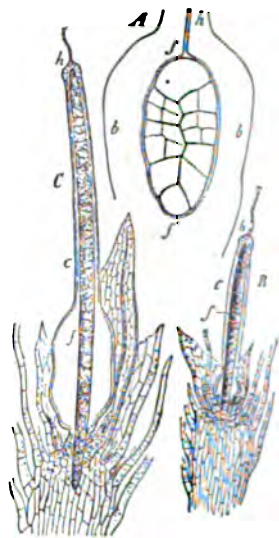

FIG. 16.—*Funaria hygrometrica*. (After Goebel.)

A. Longitudinal section of the very young sporogonium (f, f') enclosed in the archegonial wall (b, b').
B. C. Further stages of the development of the sporogonium (f) enclosed in the calyptra formed from the archegonial wall (c) and still bearing the neck (h). The foot of the sporogonium has penetrated into the underlying tissue of the stem of the moss-plant.

of the Spanish Jesuits. In 1814 Pius VII., in accordance with the bull *Sollicitudo omnium ecclesiarum*, gave to Brzozowski among others full authority to receive those who desired to enter the society. The Russian government, however, soon began to be alarmed at the growth of the Jesuits, and on the 20th of December 1815 published an edict expelling them from St Petersburg. Brzozowski, having vainly requested to be allowed to retire to Rome, died on the 5th of February 1820. He is interesting mainly from the fact that he was general of the Society at the time of its restoration throughout Europe.

BUBASTIS, the Graecized name of the Egyptian goddess Ubasti, meaning "she of [the city] Bast" (*B'is-t*), a city better known by its later name, P-ubasti, "place of Ubasti"; thus the goddess derived her name Ubasti from her city (Bast), and in turn the city derived its name P-ubasti from that of the goddess; the Greeks, confusing the name of the city with that of the goddess, called the latter Bubastis, and the former also Bubastis (later Bubastos). Bubastis, capital of the 19th nome of Lower Egypt, is now represented by a great mound of ruins called Tell Basta, near Zagazig, including the site of a large temple (described by Herodotus) strewn with blocks of granite. The monuments discovered there, although only those in hard stone have survived, are more important than at any other site in the Delta except Tanis and cover a wider range, commencing with Khufu (Cheops) and continuing to the thirtieth dynasty.

Ubasti was one of many feline goddesses, figured with the head of a lioness. In the great development of reverence for sacred animals which took place after the New Kingdom, the domestic cat was especially the animal of Bubastis, although it had also to serve for all the other feline goddesses, owing no doubt to the scarcity and intractability of its congeners. Her hieratic and most general form was still lioness-headed, but a popular form, especially in bronze, was a cat-headed woman, often holding in her right hand a lion agis, *i.e.* a broad semicircular pectoral surmounted by the head of a lioness, and on the left arm a basket. The cat cemetery on the west side of the town consisted of numbers of large brick chambers, crammed with burnt and decayed mummies, many of which had been enclosed in cat-shaped cases of wood and bronze. Herodotus describes the festival of Bubastis, which was attended by thousands from all parts of Egypt and was a very riotous affair; it has its modern equivalent in the Moslem festival of the sheikh Said el Badawi at Tanta. The tablet of Canopus shows that there were two festivals of Bubastis, the great and the lesser: perhaps the lesser festival was held at Memphis, where the quarter called Ankhto contained a temple to this goddess. Her name is found on monuments from the third dynasty onwards, but a great stimulus was given to her worship by the twenty-second (Bubastite) dynasty and generally by the increased importance of Lower Egypt in later times. Her character seems to have been essentially mild and playful, in contrast to Sokhmi and other feline goddesses. The Greeks equated Ubasti with their Artemis, confusing her with the leonine Tafne, sister of Shbou (Apollo). The Egyptians themselves delighted in identifying together goddesses of the most diverse forms and attributes; but Ubasti was almost indistinguishable in form from Tafne. The name of her son Iphithimis (Nfr-tm), pronounced Eftém, may mean "All-good," and, in the absence of other information about him, suggests a reason why he was identified with Prometheus.

See K. Sethe in Pauly-Wisnowa's *Realencyclopädie*; E. Naville, *Bubastis, and Festival Hall of Osorhon II.*; Herodotus ii. 67; 137-150; Greenell and Hunt, *Hibeh Papyri*, i. (F. L. G.)

BUCARAMANGA, a city of Colombia, capital of the department of Santander, about 185 m. N.N.E. of Bogotá. Pop. (estimate, 1902) 25,000. It is situated on the Lebrija river, 3248 ft. above sea-level, in a mountainous country rich in gold, silver and iron mines, and having superior coffee-producing lands in the valleys and on the lower slopes. The city is laid out with wide, straight streets, is well built, and has many public buildings of a substantial character.

BUCCANEERS, the name given to piratical adventurers of different nationalities united in their opposition to Spain, who

maintained themselves chiefly in the Caribbean Sea during the 17th century.

The island of Santo Domingo was one of several in the West Indies which had early in the 16th century been almost depopulated by the oppressive colonial policy of Spain. Along its coast there were several isolated establishments presided over by Spaniards, who were deprived of a convenient market for the produce of the soil by the monopolies imposed by the mother country. Accordingly English, Dutch and French vessels were welcomed and their cargoes readily bought. The island, thinned of its former inhabitants, had become the home of immense herds of wild cattle; and it became the habit of smugglers to provision at Santo Domingo. The natives still left were skilled in preserving flesh at their little establishments called *boucons*. The adventurers learned "boucanning" from the natives; and gradually Hispaniola became the scene of an extensive and illicit butcher trade. Spanish monopolies filled the seamen who sailed the Caribbean with a natural hate of everything Spanish. The pleasures of a roving life, enlivened by occasional skirmishes with forces organized and led by Spanish officials, gained upon them. Out of such conditions arose the buccaneer, alternately sailor and hunter, even occasionally a planter—roving, bold, unscrupulous, often savage, with an intense detestation of Spain. As the Spaniards would not recognize the right of other races to make settlements, or even to trade in the West Indies, the governments of France, England and Holland would do nothing to control their subjects who invaded the islands. They left them free to make settlements at their own risk. Each nation contributed a band of colonists, who selected the island of St Kitts or St Christopher, in the West Indies, where the settlers of both nations were simultaneously planted. The English and French were, however, not very friendly; and in 1629, after the retirement of several of the former to an adjoining island, the remaining colonists were surprised and partly dispersed by the arrival of a Spanish fleet of thirty-nine sail. But on the departure of the fleet the scattered bands returned, and encouragement was given to their countrymen in Santo Domingo. For buccaneering had now become a most profitable employment, operations were extended, and a storehouse secure from the attacks of the Spaniards was required. The small island of Tortuga (north-west of Hispaniola) was seized for this purpose in 1630, converted into a magazine for the goods of the rivals, and made their headquarters. Santo Domingo itself still continuing their hunting ground. A purely English settlement directed by a company in London was made at Old Providence, an island in the Caribbean Sea, now belonging to Colombia. It began a little before 1630, and was suppressed by the Spaniards in 1641.

Spain was unable to take immediate action. Eight years later, however, watching their opportunity when many buccaneers were absent in the larger island, the Spaniards attacked Tortuga, and massacred every settler they could seize. But the others returned; and the buccaneers, now in open hostility to the Spanish arms, began to receive recruits from every European trading nation, and for three-quarters of a century became the scourge of the Spanish-American trade and dominions.

France, throughout all this, had not been idle. She had named the governor of St Kitts "Governor-General for the French West India Islands," and in 1641 he took possession of Tortuga, expelled all English from the island, and attempted the same with less success in Santo Domingo. England was absorbed in the Civil War, and the buccaneers had to maintain themselves as best they could,—now mainly on the sea.

In 1654 the Spaniards regained Tortuga from the French, into whose hands it again, however, fell after six years. But this state of affairs was too insecure even for these rovers, and they would speedily have succumbed had not a refuge been found for them by the fortunate conquest of Jamaica in 1655 by the navy of the English Commonwealth. These conquests were not made without the aid of the buccaneers themselves. The taking and re-taking of Tortuga by the French was always with the assistance of the roving community; and at the conquest of Jamaica the English navy had the same influence in its favour. The

buccaneers, in fact, constituted a mercenary navy, ready for employment against the power of Spain by any other nation, on condition of sharing the plunder; and they were noted for their daring, their cruelty and their extraordinary skill in seamanship.

Their history now divides itself into three epochs. The first of these extends from the period of their rise to the capture of Panama by Morgan in 1671, during which time they were hampered neither by government aid nor, till near its close, by government restriction. The second, from 1671 to the time of their greatest power, 1685, when the scene of their operations was no longer merely the Caribbean, but principally the whole range of the Pacific from California to Chile. The third and last period extends from that year onwards; it was a time of disunion and disintegration, when the independence and rude honour of the previous periods had degenerated into unmitigated vice and brutality.

It is chiefly during the first period that those leaders flourished whose names and doings have been associated with all that was really influential in the exploits of the buccaneers—the most prominent being Mansfield and Morgan. The floating commerce of Spain had by the middle of the 17th century become utterly insignificant. But Spanish settlements remained; and in 1654 the first great expedition on land made by the buccaneers, though attended by considerable difficulties, was completed by the capture and sack of New Segovia, on the mainland of America. The Gulf of Venezuela, with its towns of Maracaibo and Gibraltar, were attacked and plundered under the command of a Frenchman named L'Olonnois, who performed, it is said, the office of executioner upon the whole crew of a Spanish vessel manned with ninety seamen. Such successes removed the buccaneers further and further from the pale of civilized society, fed their revenge, and inspired them with an avarice almost equal to that of the original settlers from Spain. Mansfield indeed, in 1664, conceived the idea of a permanent settlement upon a small island of the Bahamas, named New Providence, and Henry Morgan, a Welshman, intrepid and unscrupulous, joined him. But the untimely death of Mansfield nipped in the bud the only rational scheme of settlement which seems at any time to have animated this wild community; and Morgan, now elected commander, swept the whole Caribbean, and from his headquarters in Jamaica led triumphant expeditions to Cuba and the mainland. He was leader of the expedition wherein Porto Bello, one of the best-fortified ports in the West Indies, was surprised and plundered.

This was too much for even the adverse European powers; and in 1670 a treaty was concluded between England and Spain, proclaiming peace and friendship among the subjects of the two sovereigns in the New World, formally renouncing hostilities of every kind. Great Britain was to hold all her possessions in the New World as her own property (a remarkable concession on the part of Spain), and consented, on behalf of her subjects, to forbear trading with any Spanish port without licence obtained.

The treaty was very ill observed in Jamaica, where the governor, Thomas Modyford (1620-1679), was in close alliance with the "privateers," which was the official title of the buccaneers. He had already granted commissions to Morgan and others for a great attack on the Isthmus of Panama, the route by which the bullion of the South American mines was carried to Porto Bello, to be shipped to Spain. The buccaneers to the number of 2000 began by seizing Chagres, and then marched to Panama in 1671. After a difficult journey on foot and in canoes, they found themselves nearing the shores of the South Sea and in view of the city. On the morning of the tenth day they commenced an engagement which ended in the rout of the defenders of the town. It was taken, and, accidentally or not, it was burnt. The sack of Panama was accompanied by great barbarities. The Spaniards had, however, removed the treasure before the city was taken. When the booty was divided, Morgan is accused of having defrauded his followers. It is certain that the share per man was small, and that many of the buccaneers died of starvation while trying to return to Jamaica. Modyford was recalled, and in 1672 Morgan was called home and imprisoned in the Tower. In 1674 he was allowed to come back to the island as lieutenant-

governor with Lord Vaughan. He had become so unpopular after the expedition of 1671 that he was followed in the streets and threatened by the relations of those who had perished. During his later years he was active in suppressing the buccaneers who had now inconvenient claims on him.

From 1671 to 1685 is the time of the greatest daring, prosperity and power of the buccaneers. The expedition against Panama had not been without its influence. Notwithstanding their many successes in the Caribbean and on land, including a second plunder of Porto Bello, their thoughts ran frequently on the great expedition across the Isthmus, and they pictured the South Sea as a far wider and more lucrative field for the display of their united power.

In 1680 a body of marauders over 300 strong, well armed and provisioned, landed on the shore of Darien and struck across the country; and the cruelty and mismanagement displayed in the policy of the Spaniards towards the Indians were now revenged by the assistance which the natives eagerly rendered to the adventurers. They acted as guides during a difficult journey of nine days, kept the invaders well supplied with food, provided them with canoes, and only left them after the taking of the fort of Santa Maria, when the buccaneers were fairly embarked on a broad and safe river which emptied itself into the South Sea. With John Coxon as commander they entered the Bay of Panama, where rumour had been before them, and where the Spaniards had hastily prepared a small fleet to meet them. But the valour of the buccaneers won for them another victory; within a week they took possession of four Spanish ships, and now successes flowed upon them. The Pacific, hitherto free from their intrusion, showed many sail of merchant vessels, while on land opposition south of the Bay of Panama was of little avail, since few were acquainted with the use of fire-arms. Coxon and seventy men returned as they had gone, but the others, under Sawkins, Sharp and Watling, roamed north and south on islands and mainland, and remained for long ravaging the coast of Peru. Never short of silver and gold, but often in want of the necessaries of life, they continued their practices for a little longer; then, evading the risk of recrossing the Isthmus, they boldly cleared Cape Horn, and arrived in the Indies. Again, in 1683, numbers of them under John Cook departed for the South Sea by way of Cape Horn. On Cook's death his successor, Edward Davis, undoubtedly the greatest and most prudent commander who ever led the forces of the buccaneers at sea, met with a certain Captain Swan from England, and the two captains began a cruise which was disastrous to the Spanish trade in the Pacific.

In 1685 they were joined in the Bay of Panama by large numbers of buccaneers who had crossed the Isthmus under Townley and others. This increased body of men required an enlarged measure of adventure, and this in a few months was supplied by the viceroys of Peru. That officer, seeing the trade of the colony cut off, supplies stopped, towns burned and raided, and property harassed by continual raids, resolved by vigorous means to put an end to it. But his aim was not easily accomplished. In this same year a Spanish fleet of fourteen sail met, but did not engage, ten buccaneer vessels which were found in the Bay of Panama.

At this period the power of the buccaneers was at its height. But the combination was too extensive for its work, and the different nationality of those who composed it was a source of growing discord. Nor was the dream of equality ever realized for any length of time. The immense spoil obtained on the capture of wealthy cities was indeed divided equally. But in the gambling and debauchery which followed, nothing was more common than that one-half of the conquerors should find themselves on the morrow in most pressing want; and while those who had retained or increased their share would willingly have gone home, the others clamoured for renewed attacks. The separation of the English and French buccaneers, who together presented a united front to the Spanish fleet in 1685, marks the beginning of the third and last epoch in their history.

The brilliant exploits begun by the sack of Leon and Realajo

by the English under Davis have, even in their variety and daring, a sameness which deprives them of interest, and the wonderful confederacy is now seen to be falling gradually to pieces. The skill of Davis at sea was on one occasion displayed in a seven days' engagement with two large Spanish vessels, and the interest undoubtedly centres in him. Townley and Swan had, however, by this time left him, and after cruising together for some time, they, too, parted. In 1688 Davis cleared Cape Horn and arrived in the West Indies, while Swan's ship, the "Cygnets," was abandoned as unseaworthy, after sailing as far as Madagascar. Townley had hardly joined the French buccaneers remaining in the South Sea ere he died, and the Frenchmen with their companions crossed New Spain to the West Indies. And thus the Pacific, ravaged so long by this powerful and mysterious band of corsairs, was at length at peace.

The West Indies had by this time become hot enough even for the banded pirates. They hung doggedly along the coasts of Jamaica and Santo Domingo, but their day was nearly over. Only once again—at the siege of Carthagena—did they appear great; but even then the expedition was not of their making, and they were mere auxiliaries of the French regular forces. After the treachery of the French commander of this expedition a spirit of unity and despairing energy seemed reawakened in them; but this could not avert and scarcely delayed the rapidly approaching extinction of the community.

The French and English buccaneers could not but take sides in the war which had arisen between their respective countries in 1689. Thus was broken the bond of unity which had for three-quarters of a century kept the subjects of the two nations together in schemes of aggression upon a common foe. In the short peace of 1697-1700 England and France were using all their influence, both in the Old World and in the New, to ingratiate themselves into the favour of the king of Spain. With the resumption of hostilities in 1700 and the rise of Spain consequent upon the accession of the French claimant to the throne the career of the buccaneers was effectually closed.

But the fall of the buccaneers is no more accounted for fully by these circumstances than is their rise by the massacre of the islanders of Santo Domingo. There was that in the very nature of the community which, from its birth, marked it as liable to speedy decline.

The principles which bound the buccaneers together were, first the desire for adventure and gain, and, in the second place, hatred of the Spaniard. The first was hardly a sufficient bond of union, among men of different nationalities, when booty could be had nearly always by private venture under the colours of the separate European powers. Of greater validity was their second and great principle of union, namely, that they warred not with one another, nor with every one, but with a single and a common foe. For while the buccaneer forces included English, French and Dutch sailors, and were complemented occasionally by bands of native Indians, there are few instances during the time of their prosperity and growth of their falling upon one another, and treating their fellows with the savagery which they exulted in displaying against the subjects of Spain. The exigencies, moreover, of their perilous career readily wasted their suddenly acquired gains.

Settled labour, the warrant of real wealth, was unacceptable to those who lived by promoting its insecurity. Regular trade—though rendered attractive by smuggling—and pearl gathering and similar operations which were spiced with risk, were open in vain to them, and in the absence of any domestic life, a hand-to-mouth system of supply and demand rooted out gradually the prudence which accompanies any mode of settled existence. In everything the policy of the buccaneers, from the beginning to the end of their career, was one of pure destruction, and was, therefore, ultimately suicidal.

Their great importance in history lies in the fact that they opened the eyes of the world, and specially of the nations from whom these buccaneers had sprung, to the whole system of Spanish-American government and commerce—the former in its rottenness, and the latter in its possibilities in other hands.

From this, then, along with other causes, dating primarily from the helplessness and presumption of Spain, there arose the West Indian possessions of Holland, England and France.

A work published at Amsterdam in 1678, entitled *De Americainsche Zee Roovers*, from the pen of a buccaneer named Esquemelin, was translated into several European languages, receiving additions at the hands of the different translators. The French translation by Frontignières is named *Histoire des aventuriers qui se sont signalez dans les Indes*; the English edition is entitled *The Buccaneers of America*. Other works are Raynal's *History of the Settlements and Trade of the Europeans in the East and West Indies*, book x., English translation 1782; Dampier's *Voyages*; Geo. W. Thornbury's *Monarchs of the Main, &c.* (1855); Lionel Wafer's *Voyage and Description of the Isthmus of America* (1699); and the *Histoire de l'isle Espagnole, &c.*, and *Histoire et description générale de la Nouvelle France* of Père Charlevoix. The statements in these works are to be received with caution. A really authentic narrative, however, is Captain James Burney's *History of the Buccaneers of America* (London, 1816). The *Calendar of State Papers*, Colonial Series (London, 1860 et seq.), contains much evidence for the history of the buccaneers in the West Indies. (D. H.)

BUCCARI (Serbo-Croatian *Bakar*), a royal free town of Croatia-Slavonia, Hungary; situated in the county of Modruš-Fiume, 7 m. S.E. of Fiume, on a small bay of the Adriatic Sea. Pop. (1900) 1870. The Hungarian state railway from Zákány and Agram terminates 2½ m. from Buccari. The harbour, though sometimes dangerous to approach, affords good anchorage to small vessels. Owing to competition from Fiume, Buccari lost the greater part of its trade during the 19th century. The staple industry is boatbuilding, and there is an active coasting trade in fish, wine, wood and coal. The tunny-fishery is of some importance. In the neighbourhood of the town is the old castle of Buccarica, and farther south the flourishing little port of Porto Ré or Kraljevica.

BUCCINA (more correctly *Buccina*, Gr. *βυκίνη*, connected with *bucca*, cheek, and Gr. *βύξω*), a brass wind instrument extensively used in the ancient Roman army. The Roman instrument consisted of a brass tube measuring some 11 to 12 ft. in length, of narrow cylindrical bore, and played by means of a cup-shaped mouthpiece. The tube is bent round upon itself

from the mouthpiece to the bell in the shape of a broad C and is strengthened by means of a bar across the curve, which the performer grasps while playing, in order to steady the instrument; the bell curves over his head or shoulder as in the modern helicon. Three Roman buccinas were found among the ruins of Pompeii and are now deposited in the museum at Naples. V. C. Mahillon, of Brussels¹ has made a facsimile of one of these instruments; it is in G and has almost

the same harmonic series as the French horn and the trumpet. The buccina, the cornu (see HORN), and the tuba were used as signal instruments in the Roman army and camp to sound the four night watches (hence known as *buccina prima, secunda, &c.*), to summon them by means of the special signal known as *classicum*, and to give orders.² Frontinus relates³ that a Roman general, who had been surrounded by the enemy, escaped during the night by means of the stratagem of leaving behind him a *buccinator* (trumpeter), who sounded

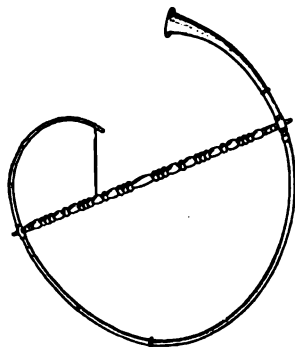

From a photo by Brogi.

FIG. 1.—Buccina in the National Museum, Naples.

¹ See *Catalogue descriptif* (Ghent, 1880), p. 330, and illustration, vol. ii. (1896), p. 30.

² Livy vii. 35. xxvi. 15; Prop. v. 4. 63; Tac. Ann. xv. 30; Vegetius, *De re militari*, ii. 22, iii. 5; Polyb. vi. 365, xiv. 3. 7.

³ *Stratagematicon*, i. 5, § 17.

the watches throughout the night.¹ Vegetius gives brief descriptions of the three instruments, which suffice to establish their identity; the tuba, he says, is straight; the buccina is of bronze bent in the form of a circle.²

The buccina, in respect of its technical construction and acoustic properties, was the ancestor of both trumpet and trombone; the connexion is further established by the derivation of the words Sackbut and *Posaune* (the German for trombone) from buccina. The relation was fully recognized in Germany



FIG. 2.—Busine, 14th century.
(From MS. R. 10 E. IV. Brit. Mus.)

during the 15th and 16th centuries, as two translations of Vegetius, published at Ulm in 1470, and at Augsburg in 1534, clearly demonstrate: "Bucina das ist die trompet oder pusan"³ ("the buccina is the trumpet or trombone"), and "Bucina ist die trompet die wirt aus und eingezogen"⁴ ("the buccina is the trumpet which is drawn out and in"). A French translation by Jean de Meung (Paris, 1488),⁵ renders the passage (chap. iii. 5) thus: "Trompe est longue et droite; buisine est courte et reflechist en li meisme si comme partie de cercle." On Trajan's column⁶ the tuba, the cornu and the buccina are distinguishable. Other illustrations of the buccina may be seen in François Mazois' *Les Ruines de Pompéi* (Paris, 1824-1838), pt. iv, pl. xviii. fig. 1, and in J. N. von Wilimowsky's *Eine römische Villa zu Nennig* (Bonn, 1865), pl. xii. (mosaic), where the buccinator is accompanied on the hydraulus. The military buccina described is a much more advanced instrument than its prototype the *buccina marina*, a primitive trumpet in the shape of a conical shell, often having a spiral twist, which in poetry is often called *concha*. The *buccina marina* is frequently depicted in the hands of Tritons (Macrobius i. 8), or of sailors, as for instance on terra-cotta lamp shown by G. P. Bellori (*Lucernae veterum sepulcrales iconicae*, 1702, iii. 12). The highly imaginative writer of the apocryphal letter of St Jerome to Dardanus also has a word to say concerning the buccina among the Semitic races: "Bucca vocatur tuba apud Hebraeos: deinde per diminutionem buccina dicitur." After the fall of the Roman empire the art of bending metal tubes was gradually lost, and although the buccina survived in Europe both in name and in principle of construction during the



FIG. 3.—Busine, 14th century.
(From MS. R. 10 E. IV. Brit. Mus.)

middle ages, it lost for ever the characteristic curve like a "C" which it possessed in common with the cornu, an instrument having a conical bore of wider calibre. Although we regard the buccina as essentially Roman, an instrument

of the same type, but probably straight and of kindred name, was widely known and used in the East, in Persia, Arabia and among the Semitic races. After a lapse of years during which records are almost wanting, the buccina reappeared all over Europe as the busine, buisine, pusin, busaun, pusun, posaan, busna (Slav), &c.; whether it was a Roman survival or a re-introduction through the Moors of Spain in the West and the Byzantine empire in the East, we have no records to show. A 11th-century mural painting representing the Last Judgment in the cathedral of S. Angelo in Formis (near Capua), shows the angels blowing the last trump on busines.⁷

There are two distinct forms of the busine which may be traced during the middle ages:—(1) a long straight tube (fig. 2) consisting of 3 to 5 joints of narrow cylindrical bore, the last joint alone being conical and ending in a pommel-shaped bell, precisely as in the curved buccina (fig. 1); (2) a long straight cylindrical tube of somewhat wider bore than the busine, ending in a wide bell curving out abruptly from the cylindrical tube (fig. 3).

The history of the development of the trumpet, the sackbut and the trombone from the buccina will be found more fully treated under those headings; for the part played by the buccina in the evolution of the French horn see HORN. (K. S.)

BUCCLEUCH, DUKES OF. The substantial origin of the ducal house of the Scotts of Buccleuch dates back to the large grants of lands in Scotland to Sir Walter Scott of Kirkcud and Buccleuch, a border chief, by James II., in consequence of the fall of the 8th earl of Douglas (1452); but the family traced their descent back to a Sir Richard le Scott (1240-1289). The estate of Buccleuch is in Selkirkshire. Sir Walter Scott of Branxholm and Buccleuch (d. 1552) distinguished himself at the battle of Pinkie (1547), and furnished material for his later namesake's famous poem, *The Lay of the Last Minstrel*; and his great-grandson Sir Walter (1565-1611) was created Lord Scott of Buccleuch in 1606. An earldom followed in 1610. The second earl's daughter Anne (1651-1732), who succeeded him as a countess in her own right, married in 1663 the famous duke of Monmouth (*q.v.*), who was then created 1st duke of Buccleuch, and her grandson Francis became 2nd duke. The latter's son Henry (1746-1812) became 3rd duke, and in 1810 succeeded also, on the death of William Douglas, 4th duke of Queensberry, to that dukedom as well as its estates and other honours, according to the entail executed by his own great-grandfather, the 2nd duke of Queensberry, in 1706; he married the duke of Montagu's daughter, and was famous for his generosity and benefactions. His son Charles William Henry (d. 1819), grandson Walter Francis Scott (1806-1884), and great-grandson William Henry Walter Montagu Douglas Scott (b. 1831), succeeded in turn as 4th, 5th and 6th dukes of Buccleuch and 6th, 7th, and 8th dukes of Queensberry. The 5th duke was lord privy seal 1821-1846, and president of the council 1846. It was he who at a cost of over £500,000 made the harbour at Granton, near Edinburgh. He was president of the Highland and Agricultural Society, the Society of Antiquaries and of the British Association. The 6th duke sat in the House of Commons as Conservative M.P. for Midlothian, 1853-1868 and 1874-1880; his wife, a daughter of the 1st duke of Abercorn, held the office of mistress of the robes.

See Sir W. Fraser, *The Scotts of Buccleuch* (1878).

BUCENTAUR (Ital. *bucintoro*), the state gallery of the dogs of Venice, on which, every year on Ascension day up to 1780, they put into the Adriatic in order to perform the ceremony of "wedding the sea." The name *bucintoro* is derived from the Ital. *buzino d'oro*, "golden bark," latinized in the middle ages as *bucentaurus* on the analogy of a supposed Gr. *βουκένταυρος*, ox-centaur (from *βούς* and *κένταυρος*). This led to the explanation of the name as derived from the head of an ox having served as the galley's figurehead. This derivation is, however, fanciful; the name *bucentaurus* is unknown in ancient mythology, and the figurehead of the bucentaurs, of which representations have come down to us, is the lion of St Mark.

⁷ See F. X. Kraus, "Die Wandgemälde von San Angelo in Formis" in *Jahrbuch der kgl. preuss. Kunstsamm.* (1893), pl. 1.

¹ For another instance see Caesar, *Comm. Bell. Civ.* ii. 35

² Vegetius, *op. cit.* iii. 5.

³ *Idem*, ii. 7.

⁴ *Idem*, iii. 5.

⁵ A reprint edited by Ulysse Robert has been published by the Soc. des Anciens Textes Français (Paris, 1897).

⁶ See Conrad Cichorius, *Die Reliefs der Traianssäule*, 3 vols. of text and 2 portfolios of heliogravures (Berlin, 1896, &c.), Bd. i. pl. x. buccina and tubae; pl. viii. buccina; pl. lxxvi. buccina and two cornua; pl. xx. cornu, &c.; or W. Froehner, *La Colonne de Trajan* (Paris, 1872), vol. i. pl. xxxii., xxxvi., li., tome ii. pl. lxxvi., tome iii. pl. cxxxiv., &c.

The name bucentaur seems, indeed, to have been given to any great and sumptuous Venetian galley. Du Cange (*Gloss., s.v.* "Bucenaurus") quotes from the chronicle of the doge Andrea Dandolo (d. 1354): *cum uno artificioso et solemniter Bucenaurus, super quo venit usque ad S. Clementem, quo jam pervenerat principior et solemnior Bucenaurus cum consiliariis, &c.* The last and most magnificent of the bucentaurs, built in 1729, was destroyed by the French in 1798 for the sake of its golden decorations. Remains of it are preserved at Venice in the Museo Civico Correr and in the Arsenal; in the latter there is also a fine model of it.

The "Marriage of the Adriatic," or more correctly "of the sea" (*Sposalizio del Mar*) was a ceremony symbolizing the maritime dominion of Venice. The ceremony, established about A.D. 1000 to commemorate the doge Orseolo II.'s conquest of Dalmatia, was originally one of supplication and placation, Ascension day being chosen as that on which the doge had set out on his expedition. The form it took was a solemn procession of boats, headed by the doge's *maesta nave*, afterwards the Bucenaur (from 1311) out to sea by the Lido port. A prayer was offered that "for us and all who sail thereon the sea may be calm and quiet," whereupon the doge and the others were solemnly aspersed with holy water, the rest of which was thrown into the sea while the priests chanted "Purge me with hyssop and I shall be clean." To this ancient ceremony a sacramental character was given by Pope Alexander III. in 1177, in return for the services rendered by Venice in the struggle against the emperor Frederick I. The pope drew a ring from his finger and, giving it to the doge, bade him cast such a one into the sea each year on Ascension day, and so wed the sea. Henceforth the ceremonial, instead of placatory and expiatory, became nuptial. Every year the doge dropped a consecrated ring into the sea, and with the words *Desponsamus te, mare* (We wed thee, sea) declared Venice and the sea to be indissolubly one (see H. F. Brown, *Venice*, London, 1893, pp. 60, 110).

BUCEPHALUS (Gr. *Βουκεφάλος*), the favourite Thracian horse of Alexander the Great, which died in 326 B.C., either of wounds received in the battle on the Hydaspes, or of old age. In commemoration Alexander built the city of Bucephala (Boukephala), the site of which is almost certainly to be identified with a mound on the bank of the river opposite the modern Jhelum.

See especially Arrian v. 20; other stories in Plutarch, *Alex.* 6; Curtius vi. 8. For the identification of Bucephala, Vincent A. Smith, *Early Hist. of India* (2nd ed., 1908), pp. 65, 66 note.

BUCHER (or **BUTZER**), **MARTIN** (1491-1551), German Protestant reformer, was born in 1491 at Schlettstadt in Alsace. In 1506 he entered the Dominican order, and was sent to study at Heidelberg. There he became acquainted with the works of Erasmus and Luther, and was present at a disputation of the latter with some of the Romanist doctors. He became a convert to the reformed opinions, abandoned his order by papal dispensation in 1521, and soon afterwards married a nun. In 1522 he was pastor at Landstuhl in the palatinate, and travelled hither and thither propagating the reformed doctrine. After his excommunication in 1523 he made his headquarters at Strassburg, where he succeeded Matthew Zell. Henry VIII. of England asked his advice in connexion with the divorce from Catherine of Aragon. On the question of the sacrament of the Lord's Supper, Bucer's opinions were decidedly Zwinglian, but he was anxious to maintain church unity with the Lutheran party, and constantly endeavoured, especially after Zwingli's death, to formulate a statement of belief that would unite Lutheran, south German and Swiss reformers. Hence the charge of ambiguity and obscurity which has been laid against him. In 1548 he was sent for to Augsburg to sign the agreement, called the *Interim*, between the Catholics and Protestants. His stout opposition to this project exposed him to many difficulties, and he was glad to accept Craemer's invitation to make his home in England. On his arrival in 1549 he was appointed regius professor of divinity at Cambridge. Edward VI. and the protector Somerset showed him much favour and he was con-

sulted as to the revision of the Book of Common Prayer. But on the 27th of February 1551 he died, and was buried in the university church, with great state. In 1557, by Mary's commissioners, his body was dug up and burnt, and his tomb demolished; it was subsequently reconstructed by order of Elizabeth. Bucer is said to have written ninety-six treatises, among them a translation and exposition of the Psalms and a work *De regno Christi*. His name is familiar in English literature from the use made of his doctrines by Milton in his divorce treatise.

A collected edition of his writings has never been published. A volume known as the *Tomus Anglicanus* (Basel, 1577) contains those written in England. See J. W. Baum, *Capito and Buiser* (Strassburg, 1860); A. Erichson, *Martin Buiser* (1891); and the articles in the *Dict. Nat. Biog.* (by A. W. Ward), and in Herzog-Hauck's *Real-encyclopædia* (by Paul Grünberg).

BUCH, CHRISTIAN LEOPOLD VON, BARON (1774-1853), German geologist and geographer, a member of an ancient and noble Prussian family, was born at Stolpe in Pomerania on the 26th of April 1774. In 1790-1793 he studied at the mining school of Freiberg under Werner, one of his fellow-students there being Alexander von Humboldt. He afterwards completed his education at the universities of Halle and Göttingen. His *Versuch einer mineralogischen Beschreibung von Landeck* (Breslau, 1797) was translated into French (Paris, 1805), and into English as *Attempt of a Mineralogical Description of Landeck* (Edinburgh, 1810); he also published in 1802 *Entwurf einer geognostischen Beschreibung von Schlesien* (*Geognostische Beobachtungen auf Reisen durch Deutschland und Italien*, Band I.). He was at this time a zealous upholder of the Neptunian theory of his illustrious master. In 1797 he met Humboldt at Salzburg, and with him explored the geological formations of Styria, and the adjoining Alps. In the spring of the following year, von Buch extended his excursions into Italy, where his faith in the Neptunian theory was shaken. In his previous works he had advocated the aqueous origin of basaltic and other formations. In 1799 he paid his first visit to Vesuvius, and again in 1805 he returned to study the volcano, accompanied by Humboldt and Gay Lussac. They had the good fortune to witness a remarkable eruption, which supplied von Buch with data for refuting many erroneous ideas then entertained regarding volcanoes. In 1802 he had explored the extinct volcanoes of Auvergne. The aspect of the Puy de Dôme, with its cone of trachyte and its strata of basaltic lava, induced him to abandon as untenable the doctrines of Werner on the formation of these rocks. The scientific results of his investigations he embodied in his *Geognostische Beobachtungen auf Reisen durch Deutschland und Italien* (Berlin, 1802-1809). From the south of Europe von Buch repaired to the north, and spent two years among the Scandinavian islands, making many important observations on the geography of plants, on climatology and on geology. He showed that many of the erratic blocks on the North German plains must have come from Scandinavia. He also established the fact that the whole of Sweden is slowly but continuously rising above the level of the sea from Frederikshald to Abo. The details of these discoveries are given in his *Reise durch Norwegen und Lappland* (Berlin, 1810). In 1815 he visited the Canary Islands in company with Christian Smith, the Norwegian botanist. His observations here convinced him that these and other islands of the Atlantic owed their existence to volcanic action of the most intense kind, and that the groups of islands in the South Sea are the remains of a pre-existing continent. The physical description of the Canary Islands was published at Berlin in 1825, and this work alone is regarded as an enduring monument of his labours. After leaving the Canaries von Buch proceeded to the Hebrides and the coasts of Scotland and Ireland. Palaeontology also claimed his attention, and he described in 1831 and later years a number of Cephalopods, Brachiopods and Cystides, and pointed out their stratigraphical importance. In addition to the works already mentioned von Buch published in 1833 the magnificent *Geological Map of Germany* (42 sheets, Berlin). His geological excursions were continued without interruption till his 78th year. Eight months before his death he visited

the mountains of Auvergne; and on returning home he read a paper on the Jurassic formation before the Academy of Berlin. He died at Berlin on the 4th of March 1853. Von Buch had inherited from his father a fortune more than sufficient for his wants. He was never married, and was unembarrassed by family ties. His excursions were always taken on foot, with a staff in his hand, and the large pockets of his overcoat filled with papers and geological instruments. Under this guise, the passer-by would not easily have recognised the man whom Humboldt pronounced the greatest geologist of his time.

A complete edition of his works was published at Berlin (1867-1885).

BUCHAN, EARLS OF. The earldom of Mar and Buchan was one of the seven original Scottish earldoms; later, Buchan was separated from Mar, and among the early earls of Buchan were Alexander Comyn (d. 1289), John Comyn (d. c. 1313), both constables of Scotland, and Henry Beaumont (d. 1340), who had married a Comyn. John Comyn's wife, Isabel, was the countess of Buchan who crowned Robert the Bruce king at Scone in 1306, and was afterwards imprisoned at Berwick; not, however, in a cage hung on the wall of the castle. About 1382 Sir Alexander Stewart (d. c. 1404), the "wolf of Badenoch," a son of King Robert II., became earl of Buchan, and the Stewarts appear to have held the earldom for about a century and a half, although not in a direct line from Sir Alexander.¹ Among the most celebrated of the Stewart earls were the Scottish regent, Robert, duke of Albany, and his son John, who was made constable of France and was killed at the battle of Verneuil in 1424. In 1617 the earldom came to James Erskine (d. 1640), a son of John Erskine, 2nd (or 7th) earl of Mar, whose wife Mary had inherited it from her father, James Douglas (d. 1601), and from that time it has been retained by the Erskines.

Perhaps the most celebrated of the later earls of Buchan was the eccentric David Stewart Erskine, 11th earl (1742-1829), a son of Henry David, 10th earl (d. 1767), and brother of Henry Erskine (q.v.), and of Thomas, Lord Erskine (q.v.). His pertinacity was instrumental in effecting a change in the method of electing Scottish representative peers, and in 1780 he succeeded in founding the Scottish Society of Antiquaries. Among his correspondents was Horace Walpole, and he wrote an *Essay on the Lives of Fletcher of Saltoun and the Poet Thomson* (1792), and other writings. He died at his residence at Dryburgh in April 1829, leaving no legitimate children, and was followed as 12th earl by his nephew Henry David (1785-1857), the ancestor of the present peer. The 11th earl's natural son, Sir David Erskine (1772-1837), who inherited his father's unentailed estates, was an antiquary and a dramatist.

BUCHAN, ELSPETH (1738-1791), founder of a Scottish religious sect known as the Buchanites, was the daughter of John Simpson, proprietor of an inn near Banff. Having quarrelled with her husband, Robert Buchan, a potter of Greenock, she settled with her children in Glasgow, where she was deeply impressed by a sermon preached by Hugh White, minister of the Relief church at Irvine. She persuaded White and others that she was a saint with a special mission, that in fact she was the woman, and White the man-child, described in Revelation xii. White was condemned by the presbytery, and the sect, which ultimately numbered forty-six adherents, was expelled by the magistrates in 1784 and settled in a farm, consisting of one room and a loft, known as New Cample in Dumfriesshire. Mrs Buchan claimed prophetic inspiration and pretended to confer the Holy Ghost upon her followers by breathing upon them; they believed that the millennium was near, and that they would not die, but be translated. It appears that they had community of wives and lived on funds provided by the richer members. Robert Burns, the poet, in a letter dated August 1784, describes the sect as idle and immoral. In 1785 White and Mrs Buchan published a *Divine Dictionary*, but the sect broke up on the death of its founder in spite of White's attempts

¹ In August 1908, during some excavations at Dunkeld, remains were found which are supposed to be those of Alexander Stewart, the "wolf of Badenoch."

to prove that she was only in a trance. Even White was eventually undeceived. Andrew Innes, the last survivor, died in 1848. See J. Train, *The Buchanites from First to Last* (Edinburgh, 1846).

BUCHAN, PETER (1790-1854), Scottish editor, was born at Peterhead, Aberdeenshire, in 1790. In 1816 he started in business as a printer at Peterhead, and was successful enough to be able eventually to retire and devote himself to the collection and editing of Scottish ballads. His *Ancient Ballads and Songs of the North of Scotland* (1828) contained a large number of hitherto unpublished ballads, and newly discovered versions of existing ones. Another collection made by him was published by the Percy Society, under the title *Scottish Traditional Versions of Ancient Ballads* (1845). Two unpublished volumes of Buchan's ballad collections are in the British Museum. He died on the 19th of September 1854.

BUCHANAN, CLAUDIUS (1766-1815), English divine, was born at Cambuslang, near Glasgow; and educated at the universities of Glasgow and Cambridge. He was ordained in 1795, and after holding a chaplaincy in India at Barrackpur (1797-1799) was appointed Calcutta chaplain and vice-principal of the college of Fort William. In this capacity he did much to advance Christianity and native education in India, especially by organizing systematic translations of the Scriptures. As account of his travels in the south and west of India, which added considerably to our knowledge of nature life, is given in his *Christian Researches in Asia* (Cambridge, 1811). After his return to England in 1808, he still took an active part in matters connected with India, and by his book entitled *Colonial Ecclesiastical Establishment* (London, 1813), he assisted in settling the controversy of 1813, which ended in the establishment of the Indian episcopate.

BUCHANAN, GEORGE (1506-1582), Scottish humanist, was born in February 1506. His father, a younger son of an old family, was the possessor of the farm of Moss, in the parish of Killearn, Stirlingshire, but he died at an early age, leaving his widow and children in poverty. His mother, Agnes Heriot, was of the family of the Heriots of Trabroun, Haddingtonshire, of which George Heriot, founder of Heriot's hospital, was also a member. Buchanan is said to have attended Killearn school, but not much is known of his early education. In 1520 he was sent by his uncle, James Heriot, to the university of Paris, where, as he tells us in an autobiographical sketch, he devoted himself to the writing of verses "partly by liking, partly by compulsion (that being then the one task prescribed to youth)." In 1531 his uncle died, and Buchanan being thus unable to continue longer in Paris, returned to Scotland. After recovering from a severe illness, he joined the French auxiliaries who had been brought over by John Stewart, duke of Albany, and took part in an unsuccessful inroad into England (see the account in his *Hist. of Scotland*). In the following year he entered the university of St Andrews, where he graduated B.A. in 1525. He had gone there chiefly for the purpose of attending the celebrated John Major's lectures on logic; and when that teacher removed to Paris, Buchanan followed him in 1526. In 1527 he graduated B.A., and in 1528 M.A. at Paris. Next year he was appointed regent, or professor, in the college of Sainte-Barbe, and taught there for upwards of three years. In 1529 he was elected Procurator of the "German Nation" in the university of Paris, and was re-elected four times in four successive months. He resigned his regentship in 1531, and in 1532 became tutor to Gilbert Kennedy, 3rd earl of Cassilis, with whom he returned to Scotland about the beginning of 1537.

At this period Buchanan was content to assume the same attitude towards the Church of Rome that Erasmus maintained. He did not repudiate its doctrines, but considered himself free to criticize its practice. Though he listened with interest to the arguments of the Reformers, he did not join their ranks before 1553. His first production in Scotland, when he was in Lord Cassilis's household in the west country, was the poem *Somnium*, a satirical attack upon the Franciscan friars and monastic life generally. This assault on the monks was not displeasing to James V., who engaged Buchanan as tutor to one of his natural

sons, Lord James Stewart (not the son who was afterwards the regent Murray), and encouraged him to a still more daring effort. In these circumstances the poems *Palaedia* and *Franciscanus & Fratres* were written, and, although they remained unpublished for many years, it is not surprising that the author became an object of bitter hatred to the order and their friends. Nor was it yet a safe matter to assail the church. In 1539 there was a bitter persecution of the Lutherans, and Buchanan among others was arrested. He managed to effect his escape and with considerable difficulty made his way to London and thence to Paris. In Paris, however, he found his enemy, Cardinal David Beaton, who was there as an ambassador, and on the invitation of André de Gouvés, proceeded to Bordeaux. Gouvés was then principal of the newly founded college of Guienne at Bordeaux, and by his exertions Buchanan was appointed professor of Latin. During his residence here several of his best works, the translations of *Mædea* and *Alcestis*, and the two dramas, *Jephthes* (sive *Votum*) and *Baptistes* (sive *Calumnias*), were completed. Montaigne was Buchanan's pupil at Bordeaux and acted in his tragedies. In the essay *Of Presumption* he classes Buchanan with Aurat, Béza, de L'Hôpital, Montdore and Turnebus, as one of the foremost Latin poets of his time. Here also Buchanan formed a lasting friendship with Julius Caesar Scaliger; in later life he won the admiration of Joseph Scaliger, who wrote an epigram on Buchanan which contains the couplet, famous in its day:—

"Imperii fuerat Romani Scotia limes;
Romani eloquii Scotia limes erit?"

In 1543 or 1543 he returned to Paris, and in 1544 was appointed regent in the college of Cardinal le Moine. Among his colleagues were the renowned Muretus and Turnebus.

In 1547 Buchanan joined the band of French and Portuguese humanists who had been invited by André de Gouvés to lecture in the Portuguese university of Coimbra. The French mathematician Elie Vinet, and the Portuguese historian, Jeronimo de Osorio, were among his colleagues; Gouvés, called by Montaigne *le plus grand principal de France*, was rector of the university, which had reached the summit of its prosperity under the patronage of King John III. But the rectorship had been coveted by Diogo de Gouvés, uncle of André and formerly head of Sainte-Barbe. It is probable that before André's death at the end of 1547 Diogo had urged the Inquisition to attack him and his staff; up to 1506, when the records of the trial were first published in full, Buchanan's biographers generally attributed the attack to the influence of Cardinal Beaton, the Franciscans, or the Jesuits, and the whole history of Buchanan's residence in Portugal was extremely obscure.

A commission of inquiry was appointed in October 1540 and reported in June 1550. Buchanan and two Portuguese, Diogo de Teive and João da Costa (who had succeeded to the rectorship), were committed for trial. Teive and Costa were found guilty of various offences against public order, and the evidence shows that there was ample reason for a judicial inquiry. Buchanan was accused of Lutheran and Judaistic practices. He defended himself with conspicuous ability, courage and frankness, admitting that some of the charges were true. About June 1551 he was sentenced to abjure his errors, and to be imprisoned in the monastery of São Bento in Lisbon. Here he was compelled to listen to edifying discourses from the monks, whom he found "not unkind but ignorant." In his leisure he began to translate the Psalms into Latin verse. After seven months he was released, on condition that he remained in Lisbon; and on the 28th of February 1552 this restriction was annulled. Buchanan at once sailed for England, but soon made his way to Paris, where in 1553 he was appointed regent in the college of Boncourt. He remained in that post for two years, and then accepted the office of tutor to the son of the Maréchal de Brissac. It was almost certainly during this last stay in France, where Protestantism was being repressed with great severity by Francis I., that Buchanan ranged himself on the side of the Calvinists.

In 1560 or 1561 he returned to Scotland, and in April 1562

we find him installed as tutor to the young queen Mary, who was accustomed to read Livy with him daily. Buchanan now openly joined the Protestant, or Reformed Church, and in 1566 was appointed by the earl of Murray principal of St Leonard's College, St Andrews. Two years before he had received from the queen the valuable gift of the revenues of Crossraguel Abbey. He was thus in good circumstances, and his fame was steadily increasing. So great, indeed, was his reputation for learning and administrative capacity that, though a layman, he was made moderator of the general assembly in 1567. He had sat in the assemblies from 1563.

Buchanan accompanied the regent Murray into England, and his *Delectio* (published in 1572) was produced to the commissioners at Westminster. In 1570, after the assassination of Murray, he was appointed one of the preceptors of the young king, and it was through his tuition that James VI. acquired his scholarship. While discharging the functions of royal tutor he also held other important offices. He was for a short time director of chancery, and then became lord privy seal, a post which entitled him to a seat in the parliament. He appears to have continued in this office for some years, at least till 1579. He died on the 28th of September 1582.

His last years had been occupied with two of his most important works. The first was the treatise *De Jure Regni apud Scotos*, published in 1579. In this famous work, composed in the form of a dialogue, and evidently intended to instil sound political principles into the mind of his pupil, Buchanan lays down the doctrine that the source of all political power is the people, that the king is bound by those conditions under which the supreme power was first committed to his hands, and that it is lawful to resist, even to punish, tyrants. The importance of the work is proved by the persistent efforts of the legislature to suppress it during the century following its publication. It was condemned by act of parliament in 1584, and again in 1664; and in 1683 it was burned by the university of Oxford. The second of his larger works is the history of Scotland, *Rerum Scotticarum Historia*, completed shortly before his death (1579), and published in 1582. It is of great value for the period personally known to the author, which occupies the greater portion of the book. The earlier part is based, to a considerable extent, on the legendary history of Boece. Buchanan's purpose was to "purge" the national history "of sum Inglis lysis and Scottis vanite" (*Letter to Randolph*), but he exaggerated his freedom from partisanship and unconsciously criticized his work when he said that it would "content few and displease many."

Buchanan is one of Scotland's greatest scholars. For mastery over the Latin language he has seldom been surpassed by any modern writer. His style is not rigidly modelled upon that of any classical author, but has a certain freshness and elasticity of its own. He wrote Latin as if it had been his mother tongue. But in addition to this perfect command over the language, Buchanan had a rich vein of poetical feeling, and much originality of thought. His translations of the Psalms and of the Greek plays are more than mere versions; the smaller satirical poems abound in wit and in happy phrase; his two tragedies, *Baptistes* and *Jephthes*, have enjoyed from the first an undiminished European reputation for academic excellence. In addition to the works already named, Buchanan wrote in prose *Chamaeleon*, a satire in the vernacular against Maitland of Lethington, first printed in 1711; a Latin translation of Linacre's Grammar (Paris, 1533); *Libellus de Proxodia* (Edinburgh, 1640); and *Vita ab ipso scripta biennio ante mortem* (1608), edited by R. Sibbald (1702). His other poems are *Fratres Fraterrimi*, *Elegiae*, *Silvae*, two sets of verses entitled *Hendecasyllabon Liber* and *Iambon Liber*; three books of *Epigrammata*; a book of miscellaneous verse; *De Sphaera* (in five books), suggested by the poem of Joannes de Sacrobosco, and intended as a defence of the Ptolemaic theory against the new Copernican view.

There are two editions of Buchanan's works:—(a) *Georgii Buchanani Scoti, Poetarum sui seculi facile principis, Opera Omnia*, in two vols. fol., edited by Ruddiman (Edinburgh, Freebairn, 1715); (b) edited by Burman, 4to, 1725. The *Vernacular Writings*,

consisting of the *Chamaeleon* (u.s.), a tract on the Reformation of St Andrews University, *An Admonition to the Trew Lords*, and two letters, were edited for the Scottish Text Society by P. Hume Brown. The principal biographies are:—David Irving, *Memoirs of the Life and Writings of George Buchanan* (Edinburgh, 1807 and 1817); P. Hume Brown, *George Buchanan, Humanist and Reformer* (Edinburgh, 1890), *George Buchanan and his Times* (Edinburgh, 1906); Rev. D. Macmillan, *George Buchanan, a Biography* (Edinburgh, 1906). Buchanan's quatercentenary was celebrated at different centres in Scotland in 1906, and was the occasion of several encomia and studies. The most important of these are: *George Buchanan: Glasgow Quatercentenary Studies* (Glasgow, 1906), and *George Buchanan, a Memoir*, edited by D. A. Millar (St Andrews, 1907). A verse translation of the *Baptistes*, entitled *Tyrannical-Government Anatomised* (1642), has been attributed to Milton; its authorship is discussed in the *Glasgow Quatercentenary Studies*. The records of Buchanan's trial, discovered by the Portuguese historian, G. J. C. Henriques, were published by him under the title *George Buchanan in the Lisbon Inquisition. The Records of his Trial, with a Translation thereof into English, Facsimiles of some of the Papers, and an Introduction* (Lisbon, 1906).

BUCHANAN, JAMES (1791-1868), fifteenth president of the United States, was born near Foltz, Franklin county, Pennsylvania, on the 23rd of April 1791. Both parents were of Scottish-Irish Presbyterian descent. He graduated at Dickinson College, Carlisle, Pennsylvania, in 1809, studied law at Lancaster in 1809-1812, and was admitted to the bar in 1812. He served in the lower house of the state legislature in 1814-1816, and as a representative in Congress from 1821 to 1831. As chairman of the judiciary committee he conducted the impeachment trial (1830) of Judge James H. Peck, led an unsuccessful movement to increase the number of Supreme Court judges and to relieve them of their circuit duties, and succeeded in defeating an attempt to repeal the twenty-fifth section of the Judiciary Act of 1789, which gave the Supreme Court appellate jurisdiction by writ of error to the state courts in cases where federal laws and treaties are in question. After the dissolution of the Federalist party, of which he had been a member, he supported the Jackson-Van Buren faction, and soon came to be definitely associated with the Democrats. He represented the United States at the court of St Petersburg in 1832-1833, and there negotiated an important commercial treaty. He was a Democratic member of the United States Senate from December 1834 until March 1845, ardently supporting President Jackson, and was secretary of state in the cabinet of President Polk from 1845 to 1849—a period marked by the annexation of Texas, the Mexican War, and negotiations with Great Britain relative to the Oregon question. After four years of retirement spent in the practice of his profession, he was appointed by President Pierce minister to Great Britain in 1853.

Up to this time Buchanan's attitude on the slavery question had been that held by the conservative element among Northern Democrats. He felt that the institution was morally wrong, but held that Congress could not interfere with it in the states in which it existed, and ought not to hinder the natural tendency toward territorial expansion through a fear that the evil would spread. He voted for the bill to exclude anti-slavery literature from the mails, approved of the annexation of Texas, the war with Mexico, and the Compromise of 1850, and disapproved of the Wilmot Proviso. Fortunately for his career he was abroad during the Kansas-Nebraska debates, and hence did not share in the unpopularity which attached to Stephen A. Douglas as the author of the bill, and to President Pierce as the executive who was called upon to enforce it. At the same time, by joining with J. Y. Mason and Pierre Soulé in issuing the Ostend Manifesto in 1854, he retained the good-will of the South.¹ Accord-

¹ This "manifesto" which was bitterly attacked in the North, was agreed upon (October 18, 1854) by the three ministers after several meetings at Ostend and at Aix-la-Chapelle arranged in pursuance of instructions to them from President Pierce to "compare opinions, and to adopt measures for perfect concert of action in aid of the negotiations at Madrid" on the subject of reparations demanded from Spain by the United States for alleged injuries to American commerce with Cuba. In the manifesto the three ministers asserted that "from the peculiarity of its geographical position, and the considerations attendant upon it, Cuba is as necessary to the North American republic as any of its present members"; spoke of the danger to the United States of an insurrection in Cuba; asserted that "we should be recreant to our duty, be unworthy

ingly on his return from England in 1856 he was nominated by the Democrats as a compromise candidate for president, and was elected, receiving 174 electoral votes to 114 for John C. Frémont, Republican, and 8 for Millard Fillmore, American or "Know-Nothing."

His high moral character, the breadth of his legal knowledge, and his experience as congressman, cabinet member and diplomat, would have made Buchanan an excellent president in ordinary times; but he lacked the soundness of judgment, the self-reliance and the moral courage needed to face a crisis. At the beginning of his administration he appointed Robert J. Walker of Mississippi, territorial governor of Kansas, and Frederick P. Stanton of Tennessee, secretary, and assured them of his determination to adhere to the popular sovereignty principle. He soon began to use his influence, however, to force the admission of Kansas into the Union under the pro-slavery Lecompton Constitution, contrary to the wishes of the majority of the settlers. Stanton was removed from office for opposing the scheme, and Walker resigned in disgust. This change of policy was doubtless the result of timidity rather than of a desire to secure re-election by gaining the favour of the Southern Democracy. Under the influence of Howell Cobb of Georgia, secretary of the treasury, and Jacob Thompson of Mississippi, secretary of the interior, the president was convinced that it was the only way to avoid civil war. Federal patronage was freely used to advance the Lecompton measure and the compromise English Bill, and to prevent Douglas's election to the Senate in 1858. Some of these facts were brought out in the famous Covode Investigation conducted by a committee of the House of Representatives in 1860. The investigations, however, were very partisan in character, and there is reason to doubt the constitutional power of the House to make it, except as the basis for an impeachment trial.

The call issued by the South Carolina legislature just after the election of Lincoln for a state convention to decide upon the advisability of secession brought forward the most serious question of Buchanan's administration. The part of his annual message of the 4th of December 1860 dealing with it is based upon a report prepared by Attorney-General Jeremiah S. Black of Pennsylvania. He argued that a state had no legal right to secede, but denied that the federal government had any power forcibly to prevent it. At the same time it was the duty of the president to call out the army and navy of the United States to protect federal property or to enforce federal laws. Soon after the secession movement began the Southern members of the cabinet resigned, and the president gradually came under the influence of Black, Stanton, Dix, and other Northern leaders. He continued, however, to work for a peaceful settlement, supporting the Crittenden Compromise and the work of the Peace Congress. He disapproved of Major Anderson's removal of his troops from Fort Moultrie to Fort Sumter in December 1860; but there is probably no basis for the charge made by Southern writers that the removal itself was in violation of a pledge given by the president to preserve the *status quo* in Charleston harbour until the arrival of the South Carolina commissioners in Washington. Equally unfounded is the assertion first made by Thurlow Weed in the *London Observer* (9th of February 1862) that the president was prevented from ordering Anderson back to Fort Moultrie only by the threat of four members of the cabinet to resign.

of our gallant forefathers, and commit base treason against our posterity, should we permit Cuba to be Africanised and become a second Santo Domingo, with all its attendant horrors to the white race, and suffer the flames to extend to our own neighboring shores, seriously to endanger or actually destroy the fair fabric of our Union" and recommended that "the United States ought, if practicable, to purchase Cuba as soon as possible." To Spain, they argued, the sale of the island would be a great advantage. The most startling declaration of the manifesto was that if Spain should refuse to sell "after we have offered a price for Cuba far beyond its present value," and if Cuba, in the possession of Spain, should seriously endanger "our internal peace and the existence of our cherished Union," then "by every law, human and divine, we shall be justified in wresting it from Spain if we have the power."

On the expiration of his term of office (March 4, 1861) Buchanan retired to his home at Wheatland, near Lancaster, Pennsylvania, where he died on the 1st of June 1868. His mistakes as president have been so emphasized as to obscure the fact that he was a man of unimpeachable honesty, of the highest patriotism, and of considerable ability. He never married.

See George Ticknor Curtis, *The Life of James Buchanan* (2 vols., New York, 1883), the standard biography; Curtis, however, was a close personal and political friend, and his work is too eulogistic. More trustworthy, but at times unduly severe, is the account given by James Ford Rhodes in the first two volumes of his *History of the United States since the Compromise of 1850* (New York, new edition, 1902-1907). John Bassett Moore has edited *The Works of James Buchanan, comprising his Speeches, State Papers, and Private Correspondence* (Philadelphia, 1908-1910).

BUCHANAN, ROBERT WILLIAMS (1841-1901), British poet, novelist and dramatist, son of Robert Buchanan (1813-1866), Owenite lecturer and journalist, was born at Caverswall, Staffordshire, on the 18th of August 1841. His father, a native of Ayr, after living for some years in Manchester, removed to Glasgow, where Buchanan was educated, at the high school and the university, one of his fellow-students being the poet David Gray. His essay on Gray, originally contributed to the *Cornhill Magazine*, tells the story of their close friendship, and of their journey to London in 1860 in search of fame. After a period of struggle and disappointment Buchanan published *Undertones* in 1863. This "tentative" volume was followed by *Idyls and Legends of Inverburn* (1865), *London Poems* (1866), and *North Coast and other Poems* (1868), wherein he displayed a faculty for poetic narrative, and a sympathetic insight into the humbler conditions of life. On the whole, Buchanan is at his best in these narrative poems, though he essayed a more ambitious flight in *The Book of Orm: A Prelude to the Epic*, a study in mysticism, which appeared in 1870. He was a frequent contributor to periodical literature, and obtained notoriety by an article which, under the nom de plume of Thomas Maitland, he contributed to the *Contemporary Review* for October 1871, entitled "The Fleishy School of Poetry." This article was expanded into a pamphlet (1872), but he subsequently withdrew from the criticisms it contained, and it is chiefly remembered by the replies it evoked from D. G. Rossetti in a letter to the *Athenaeum* (16th December 1871), entitled "The Stealthy School of Criticism," and from Mr Swinburne in *Under the Microscope* (1872). Buchanan himself afterwards regretted the violence of his attack, and the "old enemy" to whom *God and the Man* is dedicated was Rossetti. In 1876 appeared *The Shadow of the Sword*, the first and one of the best of a long series of novels. Buchanan was also the author of many successful plays, among which may be mentioned *Lady Clare*, produced in 1883; *Sophia* (1886), an adaptation of *Tom Jones*; *A Man's Shadow* (1890); and *The Charlatan* (1894). He also wrote, in collaboration with Harriett Jay, the melodrama *Alone in London*. In 1896 he became, so far as some of his work was concerned, his own publisher. In the autumn of 1900 he had a paralytic seizure, from which he never recovered. He died at Streatham on the 10th of June 1901.

Buchanan's poems were collected into three volumes (1874, into one volume in 1884; and as *Complete Poetical Works* (2 vols., 1901). Among his poems should also be mentioned: "The Drama of Kings" (1871); "St Abe and his Seven Wives," a lively tale of Salt Lake City, published anonymously in 1872; and "Baldur the Beautiful" (1877); "The City of Dream" (1888); "The Outcast: a Rhyme for the Time" (1891); and "The Wandering Jew" (1893). His earlier novels, *The Shadow of the Sword*, and *God and the Man* (1881), a striking tale of a family feud, are distinguished by a certain breadth and simplicity of treatment which is not so noticeable in their successors, among which may be mentioned *The Martyrdom of Madeline* (1882); *Fazlone Manor* (1885); *Effie Hetherington* (1896); and *Father Anthony* (1898). *David Gray and other Essays, chiefly on Poetry* (1868); *Master Spirits* (1873); *A Poet's Sketch Book* (1883), in which the interesting essay on Gray is reprinted; and *A Look round Literature* (1887), contain Buchanan's chief contributions to periodical literature. More

valuable is *The Land of Lorne* (2 vols., 1871), a vivid record of yachting experiences on the west coast of Scotland.

See also Harriett Jay, *Robert Buchanan; some Account of his Life* (1903).

BUCHAREST (*Bucwesci*), also written Bucarest, Bukarest, Bukharest, Bukoreast and Bukhoreast, the capital of Rumania, and chief town of the department of Ilfov. Although *Bucharest* is the conventional English spelling, the forms *Bucarest* and *Bukarest* more nearly represent the correct pronunciation. The population in 1900 was 282,071, including 43,274 Jews, and 53,056 aliens, mostly Austro-Hungarian subjects. With its outlying parts, Bucharest covers more than 20 sq. m. It lies in a hollow, traversed from north-west to south-east by the river Dimbovitza (*Dâmbovitza* or *Dimbovitza*), and is built mainly on the left bank. A range of low hills affords shelter on the west and south-west; but on every other side there are drained, though still unhealthy, marshes, stretching away to meet the central Walachian plains. From a distance, the multitude of its gardens, and the turrets and metal-plated or gilded cupolas of its many churches give Bucharest a certain picturesqueness. In a few of the older districts, too, where land is least valuable, there are antique one-storeyed houses, surrounded by poplars and acacias; while the gipsies and Rumanians, wearing their brightly coloured native costumes, the Russian coachmen, or sleigh-drivers, of the banished Lipovan sect, and the pedlars, with their doleful street cries, render Bucharest unlike any western capital. Nevertheless, the city is modern. Until about 1860, indeed, the dimly lit lanes were paved with rough stone blocks, imbedded in the clay soil, which often subsided, so as to leave the surface undulating like a sea. Drains were rare, epidemics common. Owing to the frequency of earthquakes, many houses were built of wood, and in 1847 fully a quarter of the city was laid waste by fire. The plague visited Bucharest in 1718, 1738, 1793, when an earthquake destroyed a number of old buildings, and in 1813, when 70,000 of the inhabitants died in six weeks. From the accession of Prince Charles, in 1866, a gradual reform began. The river was enclosed between stone embankments; sewerage and pure water were supplied, gas and electric light installed; and horse or electric tramways laid down in the principal thoroughfares, which were paved with granite or wood. The older houses are of brick, overlaid with white or tinted plaster, and ornamented with figures or foliage in terra-cotta; but owing to the great changes of temperature in Rumania, the plaster soon cracks and peels off, giving a dilapidated appearance to many streets. The chief modern buildings, such as the Athenaeum, with its Ionic façade and Byzantine dome, are principally on the quays and boulevards, and are constructed of stone.

Bucharest is often called "The Paris of the East," partly from a supposed social resemblance, partly from the number of its boulevards and avenues. Three main thoroughfares, the Plevna, Lipsani, and Vacaresci, skirt the left bank of the river; the Elizabeth Boulevard, and the Calea Victoriei, or "Avenue of Victory," which commemorates the Rumanian success at Plevna, in 1877, radiate east and north, respectively, from the Lipsani, and meet a broad road which surrounds all sides of Bucharest, except the north-west. The Lipsani was originally the street of merchants who obtained their wares from the annual fair at Leipzig; for almost all crafts or guilds, other than the bakers and tavern-keepers, were long confined to separate quarters; and the old names have survived, as in the musicians', furriers', and money-changers' quarters. Continuous with the Calea Victoriei, on the north, is the Kisilev Park, traversed by the *Chausée*, a favourite drive, leading to the pretty Băneasa race-course, where spring and autumn meetings are held. The Cismegiu or Cismigiu Park, which has a circumference of about 1 m., is laid out between the Plevna road and the Calea Victoriei; and there are botanical and zoological gardens.

The Orthodox Greek churches are generally small, with very narrow windows, and are built of brick in a modified Byzantine style. They are usually surmounted by two or three towers, but the bells are hung in a kind of wooden porch, resembling a

lych-gate, and standing about twenty paces from the church. The cathedral, or metropolitan church, where the metropolitan primate of Rumania officiates, was built between 1656 and 1665. It has the shape of a Greek cross, surrounded by a broad cloister, with four main entrances, each surmounted by a turret. The whole culminates in three brick towers. Standing on high ground, the cathedral overlooks all Bucharest, and commands a view of the Carpathians. Other interesting churches are St Spiridion the New (1768), the loftiest and most beautiful of all; the Doamna Balasa (1751), noteworthy for its rich carved work without, and frescoes within; and the ancient Biserica Bucur, said, in local traditions, to derive its name from Bucur, a shepherd whom legend makes the founder of Bucharest. The real founder and date of this church, and of many others, are unknown, thanks to the frequent obliteration of Slavonic inscriptions by the Greek clergy. The Protestants, Armenians and Lipovans worship in their own churches, and the Jews have several synagogues. Bucharest is also the seat of a Roman Catholic archbishop; but the Roman Catholics, though numbering nearly 37,000 in 1899, possess only three churches, including the cathedral of St Joseph.

Bucharest is a great educational centre. Besides the ordinary ecclesiastical seminaries, lycœums, gymnasias and elementary schools, it possesses schools of commerce, science and art institutes, and training colleges, for engineers and veterinary surgeons; while the university, founded in 1864, has faculties of theology, philosophy, literature, law, science, medicine and pharmacy. Students pay no fees except for board. The national library, containing many precious Oriental documents, and the meeting-hall of the Rumanian senate, are both included in the university buildings, which, with the Athenæum (used for literary conferences and for music), and the central girls' school, are regarded as the best example of modern Rumanian architecture. Other libraries are those of the Nifon seminary, of the Charles University Foundation (*Fundatiunea universitara Carol*), which endows research, and rewards literary or scientific merit; the central library, and the library of the Academy, which also contains a museum of natural history and antiquities. Among philanthropic institutions may be mentioned the Coltei, Brancovan, Maternitate, Philantropia and Pantelimon hospitals; the Marcutza lunatic asylum; and the Princess Elena refuge (*Asilul Elena Doamna*), founded by Princess Elena Couza in 1862, to provide for 230 orphan girls. The summer home of these girls is a convent in the Transylvanian Alps. Hotels and restaurants are numerous. There are two theatres, the National and the Lyric, which is mainly patronized by foreign players; but minor places of amusement abound; as also do clubs—political, social and sporting. Socially, indeed, the progress of Bucharest is remarkable, its political, literary and scientific circles being on a level with those of most European capitals.

Bucharest is the winter residence of the royal family, the meeting-place of parliament, and the seat of an appeal court (*Curtea de Apel*), of the supreme court (*Curtea de Casatie*), of the ministries, the national bank, the bank of Rumania, many lesser credit establishments, and a chamber of commerce. The railway lines which meet on the western limit of the city give access to all parts, and the telephone system, besides being internally complete, communicates with Braila, Galatz, Jassy and Sinaia. Bucharest has a very large transit trade in petroleum, timber and agricultural produce; above all, in wheat and maize. Its industries include petroleum-refining, extraction of vegetable oils, cabinet-making, brandy-distilling, tanning, and the manufacture of machinery, wire, nails, metal-ware, cement, soap, candles, paste, starch, paper, cardboard, pearl buttons, textiles, leather goods, ropes, glucose, army supplies, preserved meat and vegetables, and confectionery. An important fair is held for seven days in each year. The mercantile community is largely composed of Austrians, Frenchmen, Germans, Greeks and Swiss, who form exclusive colonies. Bucharest is the headquarters of the II. army corps, and a fortress of the first rank. The fortifications were constructed in 1885-1896 on a project drafted by the Belgian engineer, General Brialmont, in 1883. The mean

distance of the forts from the city is 4 m., and the perimeter of the defences (which are technically of special importance as embodying the system of Brialmont) is about 48 m., this perimeter being defended by 36 armoured forts and batteries. There are barracks for over 30,000 cavalry and infantry, an arsenal, a military hospital and three military academies.

The legend of Bucur is plainly unhistorical, and the meaning of *Bucharest* has been much disputed. One account derives it from an Albanian word *Bukur*, meaning joy, in memory of a victory won by Prince Mircea of Walachia (c. 1383-1419) over the Turks. For this reason Bucharest is often called "The City of Joy." Like most ancient cities of Rumania, its foundation has also been ascribed to the first Walachian prince, the half-mythical Radu Negru (c. 1290-1314). More modern historians declare that it was originally a fortress, erected on the site of the Daco-Roman Thyanus, to command the approaches to Tirgovistea, formerly the capital of Walachia. It soon became the summer residence of the court. In 1595 it was burned by the Turks; but, after its restoration, continued to grow in size and prosperity, until, in 1698, Prince Constantine Brancovan chose it for his capital. During the 18th century the possession of Bucharest was frequently disputed by the Turks, Austrians and Russians. In 1812 it gave its name to the treaty by which Bessarabia and a third of Moldavia were ceded to Russia. In the war of 1818 it was occupied by the Russians, who made it over to the prince of Walachia in the following year. A rebellion against Prince Bibescu in 1848 brought both Turkish and Russian interference, and the city was again held by Russian troops in 1853-1854. On their departure an Austrian garrison took possession and remained till March 1857. In 1858 the international congress for the organization of the Danubian principalities was held in the city; and when, in 1861, the union of Walachia and Moldavia was proclaimed, Bucharest became the Rumanian capital. Prince Cuza, the first ruler of the united provinces, was driven from his throne by an insurrection in Bucharest in 1866. For the subsequent history of the city see RUMANIA: *History*.

BÜCHLER, FRANZ (1837-1908), German classical scholar, was born in Rheinberg on the 3rd of June 1837, and educated at Bonn. He held professorships successively at Freiburg (1858), Greifswald (1866), and Bonn (1870), and in 1878 became joint-editor of the *Rheinisches Museum für Philologie*. Both as a teacher and as a commentator he was extremely successful. Among his editions are: *Frontini de aquis urbis Romae* (Leipzig, 1858); *Pergipilum Veneris* (Leipzig, 1859); *Petronei satirarum reliquiae* (Berlin, 1862; 3rd ed., 1882); *Hymnus Caris Homericus* (Leipzig, 1869); *Q. Ciceronis reliquiae* (1869); *Herondae mimambi* (Bonn, 1892). He wrote also *Grandis de lateinischen Declination* (1866); *Das Recht von Gortyn* (Frankfurt, 1885, with Zitelmann); and supervised the third edition (1893) of O. Jahn's *Persii, Juvenalis, Sulpiciae satirae*.

BUCHER, LOTHAR (1817-1892), German publicist, was born on the 25th of October 1817 at Neu Stettin, in Pomerania, his father being master at a gymnasium. After studying at the university of Berlin he adopted the legal profession. Elected a member of the National Assembly in Berlin in 1848, he was an active leader of the extreme democratic party. With others of his colleagues he was in 1850 brought to trial for having taken part in organizing a movement for refusal to pay taxes; he was condemned to fifteen months' imprisonment in a fortress, but left the country before the sentence was executed. For ten years he lived in exile, chiefly in London; he acted as special correspondent of the *National Zeitung*, and gained a great knowledge of English life; and he published a work, *Der Parlamentarismus wie er ist*, a criticism of parliamentary government, which shows a marked change in his political opinions. In 1860 he returned to Germany, and became intimate with Lassalle, who made him his literary executor. In 1864, he was offered by Bismarck, and accepted, a high position in the Prussian foreign office. The reasons that led him to a step which involved so complete a break with his earlier friends and associations are not clearly known. From this time till his death he acted as Bismarck's secretary, and was the man who probably enjoyed the greatest

amount of his confidence. It was he who drew up the text of the constitution of the North German Confederation; in 1870 he was sent on a very confidential mission to Spain in connexion with the Hohenzollern candidature for the Spanish crown; he assisted Bismarck at the final negotiations for the treaty of Frankfurt, and was one of the secretaries to the congress of Berlin; he also assisted Bismarck in the composition of his memoirs. Bucher, who was a man of great ability, had considerable influence, which was especially directed against the economic doctrines of the Liberals; in 1881 he published a pamphlet criticizing the influence and principles of the Cobden Club. He identified himself completely with Bismarck's later commercial and colonial policy, and probably had much to do with introducing it, and he did much to encourage anti-British feeling in Germany. He died at Gilon, in Switzerland, on the 12th of October 1892.

See Heinrich v. Poehring, *Ein Jahr: Lothar Buchers Leben und Werke* (3 vols., Berlin, 1890); Busch, *Bismarck: some Secret Pages of his History* (London, 1898). (J. W. H.E.)

BUCHEZ, PHILIPPE JOSEPH BENJAMIN (1796-1865), French author and politician, was born on the 31st of March 1796 at Matagne-la-Petite, now in Belgium, then in the French department of the Ardennes. He finished his general education in Paris, and afterwards applied himself to the study of natural science and medicine. In 1821 he co-operated with Saint-Amand Bazard and others in founding a secret association, modelled on that of the Italian Carbonari, with the object of organizing a general armed rising against the government. The organization spread rapidly and widely, and displayed itself in repeated attempts at revolution. In one of these attempts, the affair at Belfort, Buchez was gravely compromised, although the jury which tried him did not find the evidence sufficient to warrant his condemnation. In 1825 he graduated in medicine, and soon after he published with Ulisse Trélat a *Précis élémentaire d'hygiène*. About the same time he became a member of the Saint-Simonian Society, presided over by Bazard, Barthélemy Prosper Enfantin, and Olinde Rodrigues, and contributed to its organ, the *Producteur*. He left it in consequence of aversion to the strange religious ideas developed by its "Supreme Father," Enfantin, and began to elaborate what he regarded as a Christian socialism. For the exposition and advocacy of his principles he founded a periodical called *L'Européen*. In 1833 he published an *Introduction à la science de l'histoire*, which was received with considerable favour (2nd ed., improved and enlarged, 2 vols., 1842). Notwithstanding its prolixity, this is an interesting work. The part which treats of the aim, foundation and methods of the science of history is valuable; but what is most distinctive in Buchez's theory—the division of historical development into four great epochs originated by four universal revelations, of each epoch into three periods corresponding to desire, reasoning and performance, and of each of these periods into a theoretical and practical age—is merely ingenious (see Flint's *Philosophy of History in Europe*, i. 242-252). Buchez next edited, along with M. Roux-Lavergne (1802-1874), the *Histoire parlementaire de la Révolution française* (1833-1838; 40 vols.). This vast and conscientious publication is a valuable store of material for the early periods of the first French Revolution. There is a review of it by Carlyle (*Miscellanies*), the first two parts of whose own history of the French Revolution are mainly drawn from it. The editors worked under the inspiration of a strong admiration of the principles of Robespierre and the Jacobins, and in the belief that the French Revolution was an attempt to realize Christianity. In the *Essai d'un traité complet de philosophie au point de vue du Catholicisme et du progrès* (1839-1840) Buchez endeavoured to co-ordinate in a single system the political, moral, religious and natural phenomena of existence. Denying the possibility of innate ideas, he asserted that morality comes by revelation, and is therefore not only certain, but the only real certainty.

It was partly owing to the reputation which he had acquired by these publications, but still more owing to his connexion with the *National* newspaper, and with the secret societies hostile to the government of Louis Philippe, that he was raised, by the Revolution of 1848, to the presidency of the Constituent

Assembly. He speedily showed that he was not possessed of the qualities needed in a situation so difficult and in days so tempestuous. He retained the position only for a very short time. After the dissolution of the assembly he was not re-elected. Thrown back into private life, he resumed his studies, and added several works to those which have been already mentioned. A *Traité de politique* (published 1866), which may be considered as the completion of his *Traité de philosophie*, was the most important of the productions of the last period of his life. His brochures are very numerous and on a great variety of subjects, medical, historical, political, philosophical, &c. He died on the 12th of August 1865. He found a disciple of considerable ability in M. A. Ott, who advocated and applied his principles in various writings.

See also A. Ott, "P. B. J. Buchez," in *Journal des économistes* for 1865.

BUCHHOLZ, a town of Germany, in the kingdom of Saxony, 1700 ft. above the sea, on the Selma, 18 m. S. by E. of Chemnitz by rail. Pop. (1905) 9307. It has a Gothic Evangelical church and monuments of Frederick the Wise of Saxony, and Bismarck. There is a school for instruction in lace-making, an industry dating from 1589, which still forms the chief employment of the inhabitants.

BÜCHNER, FRIEDRICH KARL CHRISTIAN LUDWIG (1824-1899), German philosopher and physician, was born at Darmstadt. He studied at Giessen, Strassburg, Würzburg and Vienna. In 1853 he became lecturer in medicine at the university of Tübingen, where he published his great work *Kraft und Stoff* (1855). In this work, the product, according to Lange, of a fanatical enthusiasm for humanity, he sought to demonstrate the indestructibility of matter and force, and the finality of physical force. The extreme materialism of this work excited so much opposition that he was compelled to give up his post at Tübingen. He retired to Darmstadt, where he practised as a physician and contributed regularly to pathological and physiological magazines. He continued his philosophical work in defence of materialism, and published *Natur und Geist* (1857), *Aus Natur und Wissenschaft* (vol. i., 1862; vol. ii., 1884), *Fremdes und Eigenes aus dem geistigen Leben der Gegenwart* (1890), *Darwinismus und Socialismus* (1894), *Im Dienste der Wahrheit* (1899). He died at Darmstadt on the 1st of May 1899. In estimating Büchner's philosophy it must be remembered that he was primarily a physiologist, not a metaphysician. Matter and force (or energy) are infinite; the conservation of force follows from the imperishability of matter, the ultimate basis of all science. Büchner is not always clear in his theory of the relation between matter and force. At one time he refuses to explain it, but generally he assumes that all natural and spiritual forces are indwelling in matter. "Just as a steam-engine," he says in *Kraft und Stoff* (7th ed., p. 130), "produces motion, so the intricate organic complex of force-bearing substance in an animal organism produces a total sum of certain effects, which, when bound together in a unity, are called by us mind, soul, thought." Here he postulates force and mind as emanating from original matter—a materialistic monism. But in other parts of his works he suggests that mind and matter are two different aspects of that which is the basis of all things—a monism which is not necessarily materialistic, and which, in the absence of further explanation, constitutes a confession of failure. Büchner was much less concerned to establish a scientific metaphysic than to protest against the romantic idealism of his predecessors and the theological interpretations of the universe. Nature according to him is purely physical; it has no purpose, no will, no laws imposed by extraneous authority, no supernatural ethical sanction.

See Frauenstädt, *Der Materialismus* (Leipzig, 1856); Janet, *The Materialism of the Present Day: A Criticism of Dr Büchner's System*, trans. Masson (London, 1867).

BUCHON, JEAN ALEXANDRE (1791-1849), French scholar, was born on the 21st of May 1791 at Menetou-Salon (Cher), and died on the 29th of August 1849. An ardent Liberal, he took an active part in party struggles under the Restoration, while

throwing himself with equal vigour into the great work of historical regeneration which was going on at that period. During 1822 and the succeeding years he travelled about Europe on the search for materials for his *Collection des chroniques nationales françaises écrites en langue vulgaire du XIII^e au XVI^e siècle* (47 vols., 1824-1829). After the revolution of 1830 he founded the *Pantheon littéraire*, in which he published a *Choix d'ouvrages mystiques* (1843), a *Choix de monuments primitifs de l'église chrétienne* (1837), a *Choix des historiens grecs* (1837), a collection of *Chroniques étrangères relatives aux expéditions françaises pendant le XIII^e siècle* (1840), and, most important of all, a *Choix de chroniques et mémoires sur l'histoire de France* (1836-1841). His travels in southern Italy and in the East had put him upon the track of the medieval French settlements in those regions, and to this subject he devoted several important works: *Recherches et matériaux pour servir à une histoire de la domination française dans les provinces démembrées de l'empire grec* (1840); *Nouvelles recherches historiques sur la principauté française de Morée et ses hautes baronnies* (2 vols., 1843-1844); *Histoire des conquêtes et de l'établissement des Français dans les États de l'ancienne Grèce sous le Vilehardouin* (1846, unfinished). None of the numerous publications which we owe to Buchon can be described as thoroughly scholarly; but they have been of great service to history, and those concerning the East have in especial the value of original research.

BUCHU, or **BUKA LEAVES**, the produce of several shrubby plants belonging to the genus *Barosma* (nat. order Rutaceae), natives of the Cape of Good Hope. The principal species, *B. crenulata*, has leaves of a smooth leathery texture, oblong-ovate in shape, from an inch to an inch and a half in length, with serrulate or crenulate margins, on which as well as on the under side are conspicuous oil-glands. The other species which yield buchu are *B. serratifolia*, having linear-lanceolate sharply serrulate leaves, and *B. betulina*, the leaves of which are cuneate-ovate, with denticulate margins. They are all, as found in commerce, of a pale yellow-green colour; they emit a peculiar aromatic odour, and have a slightly astringent bitter taste. Buchu leaves contain a volatile oil, which is of a dark yellow colour, and deposits a form of camphor on exposure to air, a liquid hydro-carbon being the solvent of the camphor within the oil-glands. There is also present a minute quantity of a bitter principle. The leaves of a closely allied plant, *Empleurum serratum*, are employed as a substitute or adulterant for buchu. As these possess no glands they are a worthless substitute. The British Pharmacopoeia contains an infusion and tincture of buchu. The former may be given in doses of an ounce and the latter in doses of a drachm. The drug has the properties common to all substances that contain a volatile oil. The infusion contains very little of the oil and is of very slight value. Until the advent of the modern synthetic products buchu was valued in diseases of the urinary tract, but its use is now practically obsolete.

BUCK, CARL DARLING (1866-), American philologist, was born on the 2nd of October 1866, at Bucksport, Maine. He graduated at Yale in 1886, was a graduate student there for three years, and studied at the American School of Classical Studies in Athens (1887-1889) and in Leipzig (1889-1892). In 1892 he became professor of Sanskrit and Indo-European comparative philology in the University of Chicago; but it is in the narrower field of the Italic dialects that his important work lies, including *Der Vocalismus der oskischen Sprache* (1892), *The Oscan-Umbrian Verb-System* (1895), and *Grammar of Oscan and Umbrian* (1904), as well as an excellent précis of the Italic languages in *Johnson's Universal Cyclopaedia*. He collaborated with W. G. Hale (q.v.) in the preparation of *A Latin Grammar* (1903). Of his contributions to reviews on phonological topics, perhaps the most important is his discussion of "Brugmann's Law."

BUCK, DUDLEY (1839-1909), American musical composer, was born in Hartford, Connecticut, on the 10th of March 1839, the son of a merchant who gave him every opportunity for cultivating his musical talents; and for four years (1858-1862) he

studied at Leipzig, Dresden and Paris. On returning to America he held the position of organist at Hartford, Chicago (1869), and Boston (1871). In 1875 he went to New York to assist Theodore Thomas as conductor of the orchestral concerts, and from 1877 to 1903 was organist at Holy Trinity church. Meanwhile he had become well known as a composer of church music, a number of cantatas (*Columbus*, 1876; *Golden Legend*, 1880; *Light of Asia*, 1885, &c.), a grand opera, *Serapis*, a comic opera, *Deseret* (1880), a symphonic overture, *Marmion*, a symphony in E flat, and other orchestral and vocal works. He died on the 6th of October 1909.

BUCK. (1) (From the O. Eng. *buc*, a he-goat, and *bucca*, a male deer), the male of several animals, of goats, hares and rabbits, and particularly of the fallow-deer. During the 18th century the word was used of a spirited, reckless young man of fashion, and later, with particular reference to extravagance in dress, of a dandy. (2) (From a root common to Teutonic and Romance languages, cf. the Ger. *Buck*, Fr. *bute*, and Ital. *bucato*), the bleaching of clothes in lye, also the lye itself, and the clothes to be bleached, so a "buck-basket" means a basket of clothes ready for the wash. (3) Either from an obsolete word meaning "body," or from the sense of bouncing or jumping, derived from (1), a word now only found in compound words, as "buck-board," a light four-wheeled vehicle, the primitive form of which has one or more seats on a springy board, joining the front and rear axles and serving both as springs and body; a "buck-wagon" (Dutch, *bok-wagens*) is a South African cart with a frame projecting over the wheels, used for the transport of heavy loads. (4) (Either from "buck" a he-goat, or from a common Teutonic root, to bend, as seen in the Ger. *bücken*, and Eng. "bow"), a verb meaning "to leap"; seen especially in the compound "buck-jumper," a horse which leaps clear off the ground, with feet tucked together and arched back, descending with fore-feet rigid and head down and drawn inwards.

BUCK-BEAN, or **BOG-BEAN** (*Menyanthes trifoliata*, a member of the Gentian family), a bog-plant with a creeping stem, alternately arranged large leaves each with three leaflets, and spikes of white or pink flowers. The stout stem is bitter and has tonic and febrifuge properties. The plant is widely distributed through the north temperate zone.

BUCKEBURG, a town of Germany, capital of the principality of Schaumburg-Lippe, pleasantly situated at the foot of the Harleberg on the river Aue, 6 m. from Minden, on the main railway from Cologne to Berlin. Pop. 6000. It has a palace standing in extensive grounds, a gymnasium, a normal seminary, a library, a synagogue, and three churches, one of which has the appropriate inscription, *Religionis non structure exemplum*. The first houses of Bückeburg began to gather round the castle about 1365; and it was not till the 17th century that the town was surrounded with walls, which have given place to a ring of pretty promenades. The poet J. G. von Herder was court preacher here from 1771 to 1776.

BUCKERIDGE, JOHN (c. 1562-1631), English divine, was a son of William Buckeridge, and was educated at the Merchant Taylors school and at St John's College, Oxford. He became a fellow of his college, and acted as tutor to William Laud, whose opinions were perhaps shaped by him. Leaving Oxford, Buckeridge held several livings, and was highly esteemed by King James I., whose chaplain he became. In 1605 he was elected president of St John's College, a position which he vacated on being made bishop of Rochester in 1611. He was transferred to the bishopric of Ely in 1628, and died on the 23rd of May 1631. The bishop won some fame as a theologian and a controversialist. Among his intimate friends was Bishop Lancelot Andrewes, whose "Ninety-one Sermons" were published by Laud and Buckeridge in 1629.

BUCKETSHOP, a slang financial term for the office or business of an inferior class of stockbroker, who is not a member of an official exchange and conducts speculative operations for his clients, who deposit a margin or cover. The operations consist, as a rule, of a simple bet or wager between the broker and client, no pretence of an actual purchase or sale being attempted. The term is sometimes, though loosely and wrongfully, applied to

all stockbrokers who are not members of the recognized local exchange. The origin of the word is American. According to the *New English Dictionary* it is supposed to have arisen in Chicago. The Board of Trade there forbade dealings in "options" in grain of less than 5000 bushels. An "Open Board of Trade" or unauthorized exchange was opened, for the purpose of small gamblers, in a neighbouring street below the rooms of the Board of Trade. The lift used by members of the Board of Trade would be sent down to bring up from the open Board what was known as a "bucketful" of the smaller speculators, when business was slack.

BUCKHOLDT [properly **BEUKELSZ, or BOCKELSZOON**], **JOHANN** (c. 1508-1535), Dutch Anabaptist fanatic, better known as **JORN OF LEIDEN**, from his place of birth, was the illegitimate son of Bockel, burgomaster of Soevenhagen, who afterwards married his mother. He was born about 1508, apprenticed to a tailor, became infected with the opinions of Thomas Münzer, travelled in pursuit of his trade (being four years in London), married a widow, became bankrupt, and in September 1533 joined the Anabaptist movement under Johann Matthysz (Matthyszoen), baker of Haarlem. He had little education, but some literary faculty, and had written plays. On the 13th of January 1534 he appeared in Münster as an apostle of Matthysz. Good-looking and fluent, he fascinated women, and won the confidence of Bernard Knipperdollinck, a revolutionary cloth merchant, who gave him his daughter in marriage. The Münster Anabaptists took up arms on the 9th of February 1534 (see ANABAPTISTS). On the death of Matthysz (1534), BUCKHOLDT succeeded him as prophet, added his widow to the number of his wives, and organized a new constitution for Münster, with twelve elders (suggested by the tribes of Israel) and other officers of a theocracy, but soon superseded these, making himself king of the new Zion. His arbitrary rule was marked by pomp and severity. Münster was retaken (June 25, 1535) by its prince-bishop, Franz von Waldeck. BUCKHOLDT, after many indignities, was cruelly executed on the 22nd of January 1536; his body, and those of his companions, were hung in cages to the tower of the Lamberti church. His portrait is in *Groenwelen der Hoofbekkeren* (Leiden, 1607; an English edition is appended to Alexander Ross's *Pansebric*, 2nd ed., 1655); a better example of the same is given by Arend.

See Arend, *Allgemeine Geschichte des Vaterlands* (1846), II. iii. 620; Van der Aa, *Biographisch Woordenboek der Nederlanden* (1853); E. Belfort Cox, *Rise and Fall of the Anabaptists* (1903). (A. Co.)

BUCKIE, a fishing town and police burgh of Banffshire, Scotland, on the Moray Firth, at the mouth of Buckie burn, about 17 m. W. of Banff, with a station on the Great North of Scotland railway. Pop. (1801) 5849; (1901) 6549. Its public buildings include a hall and literary institute with library and recreation rooms. It attracts one of the largest Scottish fleets in the herring season, and is also the chief seat of line fishing in Scotland. The harbour, with an outer and an inner basin, covers an area of 9 acres and has half a mile of quays. Besides the fisheries, there are engineering works, distilleries, and works for the making of ropes, sails and oil. The burn, which divides the town into Nether Buckie and Eastern Buckie, rises near the Hill of Clashmaddin, about 5 m. to the south-west. Portgordon, 1½ m. west of Buckie, is a thriving fishing village, and Rathven, some 2 m. east, lies in a fertile district, where there are several interesting Danish cairns and other relics of the remote past.

BUCKINGHAM, EARLS, MARQUESSES AND DUKES OF. The origin of the earldom of Buckingham (to be distinguished from that of Buckinghamshire, q.v.) is obscure. According to Mr J. H. Round (in G. E. C.'s *Peerage*, s.v.) there is some charter evidence for its existence under William Rufus; but the main evidence for reckoning Walter Giffard, lord of Longueville in Normandy, who held forty-eight lordships in the county, as the first earl, is that of Odericus Vitalis, who twice describes Walter as "Comes Buchingehamensis," once in 1097, and again at his death in 1102. After the death of Walter Giffard,

2nd earl in 1164, the title was assumed by Richard de Clare, earl of Pembroke ("Strongbow"), in right of his wife, Rohais, sister of Walter Giffard I.; and it died with him in 1176. In 1377 Thomas of "Woodstock" (duke of Gloucester) was created earl of Buckingham at the coronation of Richard II. (15th of July), and the title of Gloucester having after his death been given to Thomas le Despenser, his son Humphrey bore that of earl of Buckingham only. On Humphrey's death, his sister Anne became countess of Buckingham in her own right. She married Edmund Stafford, earl of Stafford, and on her death (1438) the title of Buckingham passed to her son Humphrey Stafford, earl of Stafford, who in 1444 was created duke of Buckingham. This title remained in the Stafford family until the attainder and execution of Edward, 3rd duke, in 1521 (see BUCKINGHAM, HENRY STAFFORD, 2nd duke of).

In 1617 King James I. created George Villiers earl, in 1618 marquess, and in 1623 duke of Buckingham (see BUCKINGHAM, GEORGE VILLIERS, 1st duke of). The marquessate and dukedom became extinct with the death of the 2nd (Villiers) duke (q.v.) in 1687; but the earldom was claimed, under the special remainder in the patent of 1617, by a collateral line of doubtful legitimacy claiming descent from John Villiers, 1st Viscount Purbeck. The title was not actually borne after the death of John Villiers, styling himself earl of Buckingham, in 1723. The claim was extinguished by the death of George Villiers, a clergyman, in 1774.

In 1703 John Sheffield, marquess of Normanby, was created "duke of the county of Buckingham and of Normanby" (see below). He was succeeded by his son Edmund, who died in October 1735 when the titles became extinct.

The title of marquess and duke of Buckingham in the Grenville family (to the holders of which the remainder of this article applies) was derived, not from the county, but from the town of Buckingham. It originated in 1784, when the 2nd Earl Temple was created marquess of Buckingham "in the county of Buckingham," this title being elevated into the dukedom of Buckingham and Chandos for his son in 1822.

GEORGE NUGENT TEMPLE GRENVILLE, 1st marquess of Buckingham (1753-1813), was the second son of George Grenville, and was born on the 17th of June 1753. Educated at Eton and Christ Church, Oxford, he was appointed a teller of the exchequer in 1764, and ten years later was returned to parliament as one of the members for Buckinghamshire. In the House of Commons he was a sharp critic of the American policy of Lord North. In September 1779 he succeeded his uncle as 2nd Earl Temple; in 1782 was appointed lord-lieutenant of Buckinghamshire; and in July of the same year became a member of the privy council and lord-lieutenant of Ireland in the ministry of the earl of Shelburne. On his advice the Renunciation Act of 1783 was passed, which supplemented the legislative independence granted to Ireland in 1782. By royal warrant he created the order of St Patrick in February 1783, with himself as the first grand master. Temple left Ireland in 1783, and again turned his attention to English politics. He enjoyed the confidence of George III., and having opposed Fox's East India Bill, he was authorized by the king to say that "whoever voted for the India Bill was not only not his friend, but would be considered by him as an enemy," a message which ensured the defeat of the bill. He was appointed a secretary of state when the younger Pitt formed his ministry in December 1783, but resigned two days later. In December 1784 he was created marquess of Buckingham "in the county of Buckingham." In November 1787 he was appointed lord-lieutenant of Ireland under Pitt, but his second tenure of this office was hardly as successful as the first. He was denounced by Grattan for extravagance; was censured by the Irish Houses of parliament for refusing to transmit to England in address calling upon the prince of Wales to assume the regency; and he could only maintain his position by resorting to bribery on a large scale. Having become very unpopular he resigned his office in September 1789, and subsequently took very little part in politics, although he spoke in favour of the union with Ireland. He died at his residence, Stowe House,

Buckingham, on the 11th of February 1813, and was buried at Wotton. In 1775 he had married Mary Elizabeth (d. 1812), daughter of Robert, Earl Nugent.

His elder son, RICHARD GRENVILLE, 1st duke of Buckingham and Chandos (1776-1839), was one of the members of parliament for Buckinghamshire from 1797 to 1813, and, as Earl Temple, took an active part in politics. In February 1813 he succeeded his father as marquess of Buckingham; and having married the only child of the 3rd duke of Chandos, he was created duke of Buckingham and Chandos in 1822. He died in 1839. Owing to financial embarrassments, the duke lived out of England for some time, and in 1862 an account of his travels was published, as *The Private Diary of Richard, Duke of Buckingham and Chandos*.

He was succeeded by his only child, RICHARD GRENVILLE, 2nd duke of Buckingham and Chandos (1797-1861). Educated at Eton and Oriel College, Oxford, he was known as Earl Temple and subsequently as marquess of Chandos. He was member of parliament for Buckinghamshire from 1818 to 1839, and was responsible for the "Chandos clause" in the Reform Bill of 1832. He was lord privy seal from September 1841 to January 1842, and partly owing to his opposition to the repeal of the corn laws was known as the "Farmers' Friend." He found the estates heavily encumbered when he succeeded to the dukedom in 1839, and his own generous and luxurious tastes brought matters to a climax. In 1847 his residences were seized by his creditors, and the duke left England. His personal property and many of his landed estates were sold, and returning to England he devoted himself to literature. He died in London, on the 29th of July 1861. His wife, whom he married in 1819, was Mary (d. 1862), daughter of John, 1st marquess of Breadalbane, and she obtained a divorce from him in 1850. Buckingham's chief publications are, *Memoirs of the Court and Cabinets of George III.* (London, 1853-1855); *Memoirs of the Court of England, 1811-1820* (London, 1856); *Memoirs of the Court of George IV.* (London, 1859); and *Memoirs of the Court and Cabinets of William IV. and Victoria* (London, 1861).

RICHARD GRENVILLE, 3rd duke of Buckingham and Chandos (1823-1889), the only son of the 2nd duke, was educated at Eton and Christ Church, Oxford, and, as marquess of Chandos, represented the borough of Buckingham in parliament from 1846 to 1857. He was chairman of the London & North-Western railway from 1853 to 1861. After succeeding to the dukedom he became lord president of the council, and subsequently secretary for the colonies in the Conservative government of 1866-1868. From 1875 to 1880 he was governor of Madras, and in 1886 was chosen chairman of committees in the House of Lords. He was twice married and left three daughters. As he left no son the dukedom became extinct on his death; but the Scottish barony of Kinloss (to which he established his title in 1868) passed to his eldest daughter, Mary, the wife of Captain L. F. H. C. Morgan; the earldom of Temple to his nephew, William Stephen Gore-Langton; and the viscounty of Cobham to his kinsman, Charles George, 5th Baron Lyttelton. His widow married the 1st Earl Egerton of Tatton in 1894.

BUCKINGHAM, GEORGE VILLIERS, 1ST DUKE OF¹ (1592-1628), English statesman, born in August 1592,² was a younger son of Sir George Villiers of Brooksbey. His mother, Mary, daughter of Anthony Beaumont of Glenfield, Leicestershire, who was left a widow early, educated him for a courtier's life, sending him to France with Sir John Eliot; and the lad, being "by nature contemplative," took kindly to the training. He could dance well, fence well, and talk a little French, when in August 1614 he was brought before the king's notice, in the hope that he would take a fancy to him.

The moment was favourable. Since Salisbury's death James had taken the business of government upon himself. But he

¹ i.e. in the Villiers line; see above.

² The *Life*, by Sir Henry Wotton, gives August 28th as the date of his birth, but, when relating his death on August 23rd, adds, "thus died the great peer in the 36th year of his age compleat and three days over." August 28th was therefore probably a misprint for August 20th.

wanted some one who would chat with him, and amuse him, and would also fill the office of private secretary, and save him from the trouble of saying no to importunate suitors. It would be an additional satisfaction if he could train the youth whom he might select in those arts of statesmanship of which he believed himself to be a perfect master. His first choice had not proved a happy one. Robert Carr, who had lately become earl of Somerset, had had his head turned by his elevation. He had grown peevish toward his master, and had placed himself at the head of the party which was working for a close alliance with Spain.

The appearance of Villiers, beaming with animal spirits and good humour, was therefore welcomed by all who had an interest in opposing the designs of Spain, and he was appointed cup-bearer the same year. For some little time still Somerset's pre-eminence was maintained. But on the 23rd of April 1615, Villiers, in spite of Somerset, was promoted to be gentleman of the bedchamber, and was knighted on the 24th; the charge of murdering Overbury, brought against Somerset in September, completed his downfall, and Villiers at once stepped into the place which he had vacated. On the 3rd of January 1616 he became master of the horse, on the 24th of April he received the order of the Garter, and on the 27th of August 1616 was created Viscount Villiers and Baron Waddon, receiving a grant of land valued at £30,000, while on the 5th of January 1617 he was made earl, and on the 1st of January 1618 marquess of Buckingham. With the exception of the earl of Pembroke he was the richest nobleman in England.

Those who expected him to give his support to the anti-Spanish party were at first doomed to disappointment. As yet he was no politician, and he contented himself with carrying out his master's orders, whatever they were. In his personal relations he was kindly and jovial towards all who did not thwart his wishes. But James had taught him to consider that the patronage of England was in his hands, and he took good care that no man should receive promotion of any kind who did not in one way or another pay court to him. As far as can be ascertained, he cared less for money than for the gratification of his vanity. But he had not merely himself to consider. His numerous kinsfolk were to be enriched by marriage, if in no other way, and Bacon, the great philosopher and statesman, was all but thrust from office because he had opposed a marriage suggested for one of Buckingham's brothers, while Cranford, the first financier of the day, was kept from the treasury till he would forsake the woman whom he loved, to marry a penniless cousin of the favourite. On the 10th of January 1619 James made him lord high admiral of England, hoping that the ardent, energetic youth would impart something of his own fire to those who were entrusted with the oversight of that fleet which had been almost ruined by the speculation and carelessness of the officials. Something of this, no doubt, was realized under Buckingham's eye. But he himself never pretended to the virtues of an administrator, and he was too ready to fill up appointments with men who flattered him, and too reluctant to dismiss them, if they served their country ill, to effect any permanent change for the better.

It was about this time that he first took an independent part in politics. All England was talking of the revolution in Bohemia in the year before, and men's sympathy with the continental Protestants was increased when it was known that James's son-in-law had accepted the crown of Bohemia, and that in the summer of 1620 a Spanish force was preparing to invade the Palatinate. Buckingham at first had thrown himself into the popular movement. Before the summer of 1620 was at end incensed by injuries inflicted on English sailors by the Dutch in the East Indies, he had swung round, and was in close agreement with Gondomar, the Spanish ambassador. He had now married Lady Katherine Manners, the daughter of the earl of Rutland, who was at heart a Roman Catholic, though she outwardly conformed to the English Church, and this alliance may have had something to do with the change.

Buckingham's mistakes were owing mainly to his levity. He had passed briskly from one camp to the other, an impartial

observer might usually detect some personal motive at the bottom. But it is hardly probable that he was himself conscious of anything of the sort. When he was in reality acting under the influence of vanity or passion it was easy for him to persuade himself that he was doing his duty to his country.

The parliament which met in 1621, angry at discovering that no help was to be sent to the Palatinate, broke out into a loud outcry against the system of monopolies, from which Buckingham's brothers and dependants had drawn a profit, which was believed to be greater than it really was. At first he pleaded for a dissolution. But he was persuaded by Bishop Williams that it would be a wiser course to put himself at the head of the movement, and at a conference of the Commons with the Lords acknowledged that his two brothers had been implicated, but declared that his father had begotten a third who would aid in punishing them. In the impeachment of Bacon which soon followed, Buckingham, who owed much to his wise counsels, gave him that assistance which was possible without imperilling his own position and influence. He at first demanded the immediate dissolution of parliament, but afterwards, when the cry rose louder against the chancellor, joined in the attack, making however some attempt to mitigate the severity of the charges against him during the hearing of his case before the House of Lords. Notwithstanding, he took advantage of Bacon's need of assistance to wring from him the possession of York House.

In the winter of 1621, and the succeeding year, Buckingham was entirely in Gondomar's hands; and it was only with some difficulty that in May 1622 Laud argued him out of a resolution to declare himself a Roman Catholic. In December 1621 he actively supported the dissolution of parliament, and there can be little doubt that when the Spanish ambassador left England the following May, he had come to an understanding with Buckingham that the prince of Wales should visit Madrid the next year, on which occasion the Spanish court hoped to effect his conversion to the Roman Catholic Church before giving him the hand of the infanta Maria. They set out on their adventurous expedition on the 17th of February 1623, arriving at Madrid, after passing through Paris on the 7th of March. Each party had been the dupe of the other. Charles and Buckingham were sanguine in hoping for the restitution of the Palatinate to James's son-in-law, as a marriage gift to Charles; while the Spaniards counted on the conversion of Charles to Roman Catholicism and other extreme concessions (see CHARLES I.). The political differences were soon accentuated by personal disputes between Buckingham and Olivares and the grandees, and when the two young men sailed together from Santander in September, it was with the final resolution to break entirely with Spain.

James had gratified his favourite in his absence by raising him to a dukedom. But the splendour which now gathered round Buckingham was owing to another source than James's favour. He had put himself at the head of the popular movement against Spain, and when James, acknowledging sorely against his will that the Palatinate could only be recovered by force, summoned the parliament which met in February 1624, Buckingham, with the help of the heir apparent, took up an independent political position. James was half driven, half persuaded to declare all negotiations with Spain at an end. For the moment Buckingham was the most popular man in England.

It was easier to overthrow one policy than to construct another. The Commons would have been content with sending some assistance to the Dutch, and with entering upon a privateering war with Spain. James, whose object was to regain the Palatinate, believed this could only be accomplished by a continental alliance, in which France took part. As soon as parliament was prorogued, negotiations were opened for a marriage between Charles and the sister of Louis XIII., Henrietta Maria. But a difficulty arose. James and Charles had engaged to the Commons that there should be no concessions to the English Roman Catholics, and Louis would not hear of the marriage unless very large concessions were made. Buckingham, impatient to begin the war as soon as possible, persuaded Charles, and the two together persuaded James to throw over the promises to the Commons,

and to accept the French terms. It was no longer possible to summon parliament to vote supplies for the war till the marriage had been completed, when remonstrances to its conditions would be useless.

Buckingham, for Buckingham was now virtually the ruler of England, had thus to commence war without money. He prepared to throw 12,000 Englishmen, under a German adventurer, Count Mansfeld, through France into the Palatinate. The French insisted that he should march through Holland. It mattered little which way he took. Without provisions, and without money to buy them, the wretched troops sickened and died in the winter frosts. Buckingham's first military enterprise ended in disastrous failure.

Buckingham had many other schemes in his teeming brain. He had offered to send aid to Christian IV., king of Denmark, who was proposing to make war in Germany, and had also a plan for sending an English fleet to attack Genoa, the ally of Spain, and a plan for sending an English fleet to attack Spain itself.

Before these schemes could be carried into operation James died on the 27th of March 1625. The new king and Buckingham were at one in their aims and objects. Both were anxious to distinguish themselves by the chastisement of Spain, and the recovery of the Palatinate. Both were young and inexperienced. But Charles, obstinate when his mind was made up, was sluggish in action and without fertility in ideas, and he had long submitted his mind to the versatile and brilliant favourite, who was never at a loss what to do next, and who unrolled before his eyes visions of endless possibilities in the future. Buckingham was sent over to Paris to urge upon the French court the importance of converting its alliance into active co-operation.

There was a difficulty in the way. The Huguenots of La Rochelle were in rebellion, and James had promised the aid of English ships to suppress that rebellion. Buckingham, who seems at first to have consented to the scheme, was anxious to mediate peace between the king of France and his subjects, and to save Charles from compromising himself with his parliament by the appearance of English ships in an attack upon Protestants. When he returned his main demands were refused, but hopes were given him that peace would be made with the Huguenots. On his way through France he had the insolence to make love to the queen of France.

Soon after his return parliament was opened. It would have been hard for Charles to pass through the session with credit. Under Buckingham's guidance he had entered into engagements involving an enormous expenditure, and these engagements involved a war on the continent, which had never been popular in the House of Commons. The Commons, too, suspected the marriage treaty contained engagements of which they disapproved. They asked for the full execution of the laws against the Roman Catholics, and voted but little money in return. Before they reassembled at Oxford on the 1st of August, the English ships had found their way into the hands of the French, to be used against La Rochelle. The Commons met in an ill-humour. They had no confidence in Buckingham, and they asked that persons whom they could trust should be admitted to the king's council before they would vote a penny. Charles stood by his minister, and on the 12th of August he dissolved his first parliament.

Buckingham and his master set themselves to work to conquer public opinion. On the one hand, they threw over their engagements to France on behalf of the English Roman Catholics. On the other hand they sent out a large fleet to attack Cadix, and to seize the Spanish treasure-ships. Buckingham went to the Hague to raise an immediate supply by pawning the crown jewels, to place England at the head of a great Protestant alliance, and to enter into fresh obligations to furnish money to the king of Denmark. It all ended in failure. The fleet returned from Cadix, having effected nothing. The crown jewels produced but a small sum, and the money for the king of Denmark could only be raised by an appeal to parliament. In the meanwhile the king of France was deeply offended by the treatment of

the Roman Catholics, and by the seizure of French vessels on the ground that they were engaged in carrying goods for Spain.

When Charles's second parliament met on the 6th of February 1626, it was not long before, under Eliot's guidance, it asked for Buckingham's punishment. He was impeached before the House of Lords on a long string of charges. Many of these charges were exaggerated, and some were untrue. His real crime was his complete failure as the leader of the administration. But as long as Charles refused to listen to the complaints of his minister's incompetency, the only way in which the Commons could reach him was by bringing criminal charges against him. Charles dissolved his second parliament as he had dissolved his first. Subsequently the Star Chamber declared the duke innocent of the charges, and on the 1st of June Buckingham was elected chancellor of Cambridge University.

To find money was the great difficulty. Recourse was had to a forced loan, and men were thrown into prison for refusing to pay it. Disasters had occurred to Charles's allies in Germany. The fleet sent out under Lord Willoughby (earl of Lindsey) against the Spaniards returned home shattered by a storm, and a French war was impending in addition to the Spanish one. The French were roused to reprisals by Charles's persistence in seizing French vessels. Unwilling to leave La Rochelle open to the entrance of an English fleet, Richelieu laid siege to that stronghold of the French Huguenots. On the 27th of June 1627 Buckingham sailed from Portsmouth at the head of a numerous fleet, and a considerable land force, to relieve the besieged city.

His first enterprise was the siege of the fort of St Martin's, on the Isle of Ré. The ground was hard, and the siege operations were converted into a blockade. On the 27th of September the defenders of the fort announced their readiness to surrender the next morning. In the night a fresh gale brought over a flotilla of French provision boats, which dashed through the English blockading squadron. The fort was provisioned for two months more. Buckingham resolved to struggle on, and sent for reinforcements from England. Charles would gladly have answered to his call. But England had long since ceased to care for the war. There was no money in the exchequer, no enthusiasm in the nation to supply the want. Before the reinforcements could arrive the French had thrown a superior force upon the island, and Buckingham was driven to retreat on the 29th of October with heavy loss, only 2989 troops out of nearly 7000 returning to England.

His spirits were as buoyant as ever. Ill luck, or the misconduct of others, was the cause of his failure. He had new plans for carrying on the war. But the parliament which met on the 17th of March 1628 was resolved to exact from the king an obligation to refrain from encroaching for the future on the liberties of his subjects.

In the parliamentary battle, which ended in the concession of the Petition of Right, Buckingham took an active share as a member of the House of Lords. He resisted as long as it was possible to resist the demand of the Commons, that the king should abandon his claim to imprison without showing cause. When the first unsatisfactory answer to the petition was made by the king on the 2nd of June, the Commons suspected, probably with truth, that it had been dictated by Buckingham. They prepared a remonstrance on the state of the nation, and Coke at last named the duke as the cause of all the misfortunes that had occurred. "The duke of Bucks is the cause of all our miseries . . . that man is the grievance of grievances." Though on the 7th of June the king granted a satisfactory answer to the petition, the Commons proceeded with their remonstrance, and on the 11th demanded that he might no longer continue in office.

Once more Charles refused to surrender Buckingham, and a few days later he prorogued parliament in anger. The popular feeling was greatly excited. Lampons circulated freely from hand to hand, and Dr Lambe, a quack doctor, who dabbled in astrology, and was believed to exercise influence over Buckingham, was murdered in the streets of London. Rude doggerel

lines announced that the duke should share the doctor's fate.

With the clouds gathering round him, Buckingham went down to Portsmouth to take the command of one final expedition for the relief of La Rochelle. For the first time even he was beginning to acknowledge that he had undertaken a task beyond his powers. There was a force of inertia in the officials which resisted his efforts to spur them on to an enterprise which they believed to be doomed to failure. He entered gladly into a scheme of pacification proposed by the Venetian ambassador. But before he could know whether there was to be peace or war, the knife of an assassin put an end to his career. John Felton, who had served at Ré, had been disappointed of promotion, and had not been paid that which was due to him for his services, read the declaration of the Commons that Buckingham was a public enemy, and eagerly caught at the excuse for revenging his private wrongs under cover of those of his country. Waiting on the morning of the 23rd of August, beside the door of the room in which Buckingham was breakfasting, he stabbed him to the heart as he came out.

Buckingham married Lady Katherine Manners, daughter of Francis, 6th earl of Rutland, by whom he left three sons and one daughter, of whom George, the second son (1628-1687), succeeded to the dukedom.

BIBLIOGRAPHY.—Article in the *Dict. of Nat. Biography*, by S. R. Gardiner; *Life of Buckingham*, by Sir Henry Wotton (1642), reprinted in *Harleian Miscellany*, viii, 613; *A Parallel between Robert Earl of Essex and George late Duke of Buckingham*, by the same writer (1641), in the *Thomson Tracts*, 164 (20); *Character of the same by Edward, Earl of Clarendon (1706)*; *Life of George Villiers, Duke of Buckingham*, &c. (London, 1740); *Historical and Biographical Memoirs of George Villiers, Duke of Buckingham* (London, 1819); *Letters of the Duke and Duchess of Buckingham* (Edinburgh, 1834); *Historia Villæ . . . Ricardi II., &c.*, by Thos. Hearne (1729); *Documents illustrating the Impeachment of Buckingham*, published by the Camden Society and edited by S. R. Gardiner (1889); *Epistolæ Heortianæ* (James Howell), 187, 189, 203; *Poems and Songs relating to George Villiers, Duke of Buckingham*, ed. by R. W. Fairholt for the Percy Society (1850); *Rous's Diary* (Camden Soc., 1856), p. 27; *Gent. Mag.* (1845), ii, 137-144 (portrait of Buckingham dead); *Cal. of State Papers*, and MSS. in the British Museum (various collections). Hist. MSS. Comm. Series. See also P. Gibbs, *The Romance of George Villiers, 1st Duke of Buckingham* (1908). (S. R. G.; P. C. Y.)

BUCKINGHAM, GEORGE VILLIERS, 2ND DUKE OF (1628-1687), English statesman, son of the 1st duke, was born on the 30th of January 1628. He was brought up, together with his younger brother Francis, by King Charles I. with his own children, and was educated at Trinity College, Cambridge, where he obtained the degree of M.A. in 1642. He fought for the king in the Civil War, and took part in the attack on Lichfield Close in April 1643. Subsequently, under the care of the earl of Northumberland, the two brothers travelled abroad and lived at Florence and Rome. When the Second Civil War broke out they joined the earl of Holland in Surrey, in July 1648. Lord Francis was killed near Kingston, and Buckingham and Holland were surprised at St Neots on the 10th, the duke succeeding in escaping to Holland. In consequence of his participation in the rebellion, his lands, which had been restored to him in 1647 on account of his youth, were now again confiscated, a considerable portion passing into the possession of Fairfax; and he refused to compound. Charles II. conferred on him the Garter on the 19th of September 1649, and admitted him to the privy council on the 6th of April 1650. In opposition to Hyde he supported the alliance with the Scottish presbyterians, accompanied Charles to Scotland in June, and allied himself with Argyll, dissuading Charles from joining the royalist plot of October 1650, and being suspected of betraying the plan to the convenanting leaders. In May he had been appointed general of the eastern association in England, and was commissioned to raise forces abroad; and in the following year he was chosen to lead the projected movement in Lancashire and to command the Scottish royalists. He was present with Charles at the battle of Worcester on the 3rd of September 1651, and escaped safely

¹ i.e. in the Villiers line; see above.

alone to Rotterdam in October. His subsequent negotiations with Cromwell's government, and his readiness to sacrifice the interests of the church, separated him from the rest of Charles's advisers and diminished his influence; while his estrangement from the royal family was completed by his audacious courtship of the king's sister, the widowed princess of Orange, and by a money dispute with Charles. In 1657 he returned to England, and on the 15th of September married Mary, daughter of Lord Fairfax, who had fallen in love with him although the bans of her intended marriage with the earl of Chesterfield had been twice called in church. Buckingham was soon suspected of organizing a presbyterian plot against the government, and in spite of Fairfax's interest with Cromwell an order was issued for his arrest on the 9th of October. He was confined at York House about April 1658, and having broken bounds was rearrested on the 18th of August and imprisoned in the Tower, where he remained till the 23rd of February 1659, being then liberated on his promise not to abet the enemies of the government, and on Fairfax's security of £20,000. He joined the latter in his march against Lambert in January 1660, and afterwards claimed to have gained Fairfax to the cause of the Restoration.

On the king's return Buckingham, who met him at his landing at Dover, was at first received coldly; but he was soon again in favour, was appointed a gentleman of the bedchamber, carried the orb at the coronation on the 23rd of April 1661, and was made lord-lieutenant of the West Riding of Yorkshire on the 21st of September. The same year he accompanied the princess Henrietta to Paris on her marriage with the duke of Orleans, but made love to her himself with such imprudence that he was recalled. On the 28th of April 1662 he was admitted to the privy council. His confiscated estates amounting to £26,000 a year were restored to him, and he was reputed the king's richest subject. He took part in the suppression of the projected insurrection in Yorkshire in 1663, went to sea in the first Dutch war in 1665, and was employed in taking measures to resist the Dutch or French invasion in June 1666.

He was, however, debarred from high office by Clarendon's influence. Accordingly Buckingham's intrigues were now directed to effect the chancellor's ruin. He organized parties in both houses of parliament in support of the bill of 1666 prohibiting the import of Irish cattle, partly to oppose Clarendon and partly to thwart the duke of Ormonde. Having asserted during the debates that "whoever was against the bill had either an Irish interest or an Irish understanding," he was challenged by Lord Ossory. Buckingham avoided the encounter, and Ossory was sent to the Tower. A short time afterwards, during a conference between the two houses on the 19th of December, he came to blows with the marquess of Dorchester, pulling off the latter's periwig, while Dorchester at the close of the scuffle "had much of the duke's hair in his hand."¹ According to Clarendon no misdemeanour so flagrant had ever before offended the dignity of the House of Lords. The offending peers were both sent to the Tower, but were released after apologizing; and Buckingham vented his spite by raising a claim to the title of Lord Roos held by Dorchester's son-in-law. His opposition to the government had forfeited the king's favour, and he was now accused of treasonable intrigues, and of having cast the king's horoscope. His arrest was ordered on the 25th of February 1667, and he was dismissed from all his offices. He avoided capture till the 27th of June, when he gave himself up and was imprisoned in the Tower. He was released, however, by July 17th, was restored to favour and to his appointments on the 15th of September, and took an active part in the prosecution of Clarendon. On the latter's fall he became the chief minister, though holding no high office except that of master of the horse, bought from the duke of Albermarle in 1668. In 1671 he was elected chancellor of Cambridge, and in 1672 high steward of Oxford university. He favoured religious toleration, and earned the praise of Richard Baxter; he supported a scheme of comprehension in 1668, and advised the declaration of indulgence in 1672. He upheld the original jurisdiction of the

¹ Clarendon, *Life and Continuation*, 379.

Lords in Skinner's case. With these exceptions Buckingham's tenure of office was chiefly marked by scandals and intrigues. His illicit connexion with the countess of Shrewsbury led to a duel with her husband at Barn Elms on the 16th of January 1668, in which Shrewsbury was fatally wounded. The tale that the countess, disguised as a page, witnessed the encounter, appears to have no foundation; but Buckingham, by installing the "widow of his own creation" in his own and his wife's house, outraged even the lax opinion of that day. He was thought to have originated the project of obtaining the divorce of the childless queen. He intrigued against James, against Sir William Coventry—one of the ablest statesmen of the time, whose fall he procured by provoking him to send him a challenge—and against the great duke of Ormonde, who was dismissed in 1669. He was even suspected of having instigated Thomas Blood's attempt to kidnap and murder Ormonde, and was charged with the crime in the king's presence by Ormonde's son, Lord Ossory, who threatened to shoot him dead in the event of his father's meeting with a violent end. Arlington, next to Buckingham himself the most powerful member of the cabal and a favourite of the king, was a rival less easy to overcome; and he derived considerable influence from the control of foreign affairs entrusted to him. Buckingham had from the first been an adherent of the French alliance, while Arlington concluded through Sir William Temple in 1668 the Triple Alliance. But on the complete *volte-face* and surrender made by Charles to France in 1670, Arlington as a Roman Catholic was entrusted with the first treaty of Dover of the 20th of May—which besides providing for the united attack on Holland, included Charles's undertaking to proclaim himself a Romanist and to reintroduce the Roman Catholic faith into England.—While Buckingham was sent to France to carry on the sham negotiations which led to the public treaties of the 31st of December 1670 and the 2nd of February 1672. He was much pleased with his reception by Louis XIV., declared that he had "more honours done him than ever were given to any subject," and was presented with a pension of 20,000 livres a year for Lady Shrewsbury. In June 1672 he accompanied Arlington to the Hague to impose terms on the prince of Orange, and with Arlington arranged the new treaty with Louis. After all this activity he suffered a keen disappointment in being passed over for the command of the English forces in favour of Schomberg. He now knew of the secret treaty of Dover, and towards the end of 1673 his jealousy of Arlington became open hostility. He threatened to impeach him, and endeavoured with the help of Louis to stir up a faction against him in parliament. This, however, was unsuccessful, and in January 1674 an attack was made upon Buckingham himself simultaneously in both houses. In the Lords the trustees of the young earl of Shrewsbury complained that Buckingham continued publicly his intimacy with the countess, and that a son of theirs had been buried in Westminster Abbey with the title of earl of Coventry; and Buckingham, after presenting an apology, was required, as was the countess, to give security for £10,000 not to cohabit together again. In the Commons he was attacked as the promoter of the French alliance, of "popery" and arbitrary government. He defended himself chiefly by endeavouring to throw the blame upon Arlington; but an address was voted petitioning the king to remove him from his councils, presence and from employment for ever. Charles, who had only been waiting for a favourable opportunity, and who was enraged at Buckingham's disclosures, consented with alacrity. Buckingham retired into private life, reformed his ways, attended church with his wife, began to pay his debts, became a "patriot," and was claimed by the country or opposition party as one of their leaders. In the spring of 1675 he was conspicuous for his opposition to the Test oath and for his abuse of the bishops, and on the 16th of November he introduced a bill for the relief of the nonconformists. On the 15th of February 1677 he was one of the four lords who endeavoured to embarrass the government by raising the question whether the parliament, not having assembled according to the act of Edward III. once in the year, had not been dissolved by

the recent prorogation. The motion was rejected and the four lords were ordered to apologize. On their refusing, they were sent to the Tower, Buckingham in particular exasperating the House by ridiculing its censure. He was released in July, and immediately entered into intrigues with Barillon, the French ambassador, with the object of hindering the grant of supplies to the king; and in 1678 he visited Paris to get the assistance of Louis XIV. for the cause of the opposition. He took an active part in the prosecution of those implicated in the supposed Popish Plot, and accused the lord chief justice (Sir William Scroggs) in his own court while on circuit of favouring the Roman Catholics. In consequence of his conduct a writ was issued for his apprehension, but it was never served. He promoted the return of Whig candidates to parliament, constituted himself the champion of the dissenters, and was admitted a freeman of the city of London. He, however, separated himself from the Whigs on the exclusion question, probably on account of his dislike of Monmouth and Shaftesbury, was absent from the great debate in the Lords on the 15th of November 1680, and was restored to the king's favour in 1684.

He took no part in public life after James's accession, but returned to his manor of Helmsley in Yorkshire, the cause of his withdrawal being probably exhausted health and exhausted finances. In 1685 he published a pamphlet, entitled *A short Discourse on the Reasonableness of Man's having a Religion* (reprinted in *Somers Tracts* 1813, ix. 13), in which after discussing the main subject he returned to his favourite topic, religious toleration. The tract provoked some rejoinders and was defended, amongst others, by William Penn, and by the author himself in *The Duke of Buckingham's Letter to the unknown author of a short answer to the Duke of Buckingham's Paper* (1685). In hopes of converting him to Roman Catholicism James sent him a priest, but Buckingham turned his arguments into ridicule. He died on the 16th of April 1687, from a chill caught while hunting, in the house of a tenant at Kirkby Moorside in Yorkshire, expressing great repentance and feeling himself "despised by my country and I fear forsaken by my God."¹ The miserable picture of his end drawn by Pope, however, is greatly exaggerated. He was buried on the 7th of June 1687 in Henry VII.'s chapel in Westminster Abbey, in greater state, it was said, than the late king, and with greater splendour. With his death the family founded by the extraordinary rise to power and influence of the first duke ended. As he left no legitimate children the title became extinct, and his great estate had been completely dissipated; of the enormous mansion constructed by him at Cliveden in Buckinghamshire not a stone remains.

The ostentatious licence and the unscrupulous conduct of the Alcibiades of the 17th century have been deservedly censured. But even his critics agree that he was good-humoured, good-natured, generous, an unsurpassed mimic and the leader of fashion; and with his good looks, in spite of his moral faults and even crimes, he was irresistible to his contemporaries. Many examples of his amusing wit have survived. His portrait has been drawn by Burnet, Count Hamilton in the *Mémoires de Grammont*, Dryden, Pope in the *Epistle to Lord Bathurst*, and Sir Walter Scott in *Peveril of the Peak*. He is described by Reresby as "the first gentleman of person and wit I think I ever saw," and Burnet bears the same testimony. Dean Lockier, after alluding to his unrivalled skill in riding, dancing and fencing, adds, "When he came into the presence-chamber it was impossible for you not to follow him with your eye as he went along, he moved so gracefully." Racing and hunting were his favourite sports, and his name long survived in the hunting songs of Yorkshire. He was the patron of Cowley, Sprat, Matthew Clifford and Wycherley. He dabbled in chemistry, and for some years, according to Burnet, "he thought he was very near the finding of the philosopher's stone." He set up glass works at Lambeth the productions of which were praised by Evelyn; and he spent much money, according to his biographer Brian Fairfax, in building *insanae substructiones*. Dryden described him under the character of Zimri in the

¹ *Quarterly Review*, January 1898, p. 110.

celebrated lines in *Absalom and Achitophel* (to which Buckingham replied in *Poetical Reflections on a late Poem . . . by a Person of Honour*, 1682):—

"A man so various, that he seemed to be
Not one, but all mankind's epitome;
Stiff in opinions, always in the wrong,
Was everything by starts and nothing long;
But in the course of one revolving moon,
Was chymist, fiddler, statesman and buffoon.
Beggard' by fools, whom still he found too late,
He had his jest, but they had his estate."

Buckingham, however, cannot with any truth be called the "epitome of mankind." On the contrary, the distinguishing features of his life are its incompleteness, aimlessness, imperfection, insignificance, neglect of talents and waste of opportunities. "He saw and approved the best," says Brian Fairfax, "but did too often *deteriora sequi*." He is more severely but more justly judged by himself. In gay moments indeed he had written—

"Methinks, I see the wanton hours flee,
And as they passe, turne back and laugh at me,"—

but his last recorded words on the approach of death, "O! what a prodigal have I been of that most valuable of all possessions—Time!" express with exact truth the fundamental flaw of his character and career, of which he had at last become conscious.

Buckingham wrote occasional verses and satires showing undoubtedly but undeveloped poetical gifts, a collection of which, containing however many pieces not from his pen, was first published by Tom Brown in 1704; while a few extracts from a commonplace book of Buckingham of some interest are given in an article in the *Quarterly Review* of January 1898. He was the author of *The Rehearsal*, an amusing and clever satire on the heroic drama and especially on Dryden (first performed on the 7th of December 1671, at the Theatre Royal, and first published in 1672), a deservedly popular play which was imitated by Fielding in *Tom Thumb the Great*, and by Sheridan in the *Critic*. Buckingham also published two adapted plays, *The Chances*, altered from Fletcher's play of the same name (1682) and *The Restoration or Right will take place*, from Beaumont and Fletcher's *Philaster* (publ. 1714); and also *The Battle of Selmoor* and *The Militant Couple* (publ. 1704). The latest edition of his works is that by T. Evans (2 vols. 8vo, 1775). Another work is named by Wood *A Demonstration of the Deity*, of which there is now no trace.

BIBLIOGRAPHY.—The life of Buckingham has been well and accurately traced and the chief authorities collected in the article in the *Dict. of Nat. Biography* (1896) by C. H. Firth, and in *George Vailes, 2nd Duke of Buckingham*, by Lady Burghclere (1903). Other biographies are in Wood's *Athenae Oxon.* (Bliss), iv. 207; in *Biographia Britannica*; by Brian Fairfax, printed in H. Walpole's *Catalogue of Pictures of George Duke of Buckingham* (1758); in Arber's edition of the *Rehearsal* (1868); and by the author of *Hudibras in The Genuine Remains of Mr Samuel Butler*, by R. Thyer (1759), ii. 72. The following may also be mentioned:—*Quarterly Review*, Jan. 1898 (commonplace book); *A Conference on the Doctrine of Transubstantiation between . . . the Duke of Buckingham and Father FitzGerald* (1714); *A Narrative of the Cause and Manner of the Imprisonment of the Lords* (1671); *The Declaration of . . . Duke of Buckingham and the Earls of Holland and Peterborough . . . associated for the King* (1648); S. R. Gardiner's *Hist. of the Commonwealth* (1894-1901); *Hist. of Eng. Poetry*, by W. J. Courthope (1903), iii. 460; Horace Walpole's *Royal and Noble Authors*, iii. 304; *Miscellanea Antica*, by T. Brown (1702); and the *Fairfax Correspondence* (1848-1849). For the correspondence see *Charles II. and Scotland in 1650* (Scottish History Soc., vol. xvii, 1894); *Calendars of St. Pap. Dom.*; *Hist. MSS. Comm. Series MSS. of Duke of Buccleuch at Montagu House, of Mrs. Frankland-Russell-Astley, of Marq. of Ormonde, and Various Collections*; and *Eng. Hist. Rev.* (April 1905), xc. 373. (P. C. Y.)

BUCKINGHAM, HENRY STAFFORD, 2ND DUKE OF (1454-1483), was the son of Humphrey Stafford, killed at the first battle of St Albans in 1455, and grandson of Humphrey the 1st duke (cr. 1444), killed at Northampton in 1460, both fighting for Lancaster. The 2nd duke, who bore the title of earl of Buckingham in right of his mother, was the son of Edmund, 5th earl of Stafford, and of Anne, daughter of Thomas, duke

¹ From his Common place Book (*Quarterly Rev.* vol. 187, p. 87).

² i.e. in the Stafford line; see above.

of Gloucester, youngest son of Edward III.; Henry's mother was Margaret, daughter of Edmund Beaufort, 2nd duke of Somerset, grandson of John of Gaunt. Thus he came on both sides of the blood royal, and this, coupled with the vastness of his inheritance, made the young duke's future of importance to Edward IV. He was recognized as duke in 1465, and next year was married to Catherine Woodville, the queen's sister. On reaching manhood he was made a knight of the Garter in 1474, and in 1478 was high steward at the trial of George, duke of Clarence. He had not otherwise filled any position of importance, but his fidelity might seem to have been secured by his marriage. However, after Edward's death, Buckingham was one of the first persons worked upon by Richard, duke of Gloucester. It was through his help that Richard obtained possession of the young king, and he was at once rewarded with the offices of justiciar and chamberlain of North and South Wales, and constable of all the royal castles in the principality and Welsh Marches. In the proceedings which led to the deposition of Edward V. he took a prominent part, and on the 24th of June 1483 he urged the citizens at the Guildhall to take Richard as king, in a speech of much eloquence, "for he was neither unlearned and of nature marvelously well spoken" (More). At Richard's coronation he served as chamberlain, and immediately afterwards was made constable of England and confirmed in his powers in Wales. Richard might well have believed that the duke's support was secured. But early in August Buckingham withdrew from the court to Brecon. He may have thought that he deserved an even greater reward, or possibly had dreams of establishing his own claims to the crown. At all events, at Brecon he fell somewhat easily under the influence of his prisoner, John Morton (*q.v.*), who induced him to give his support to his cousin Henry Tudor, earl of Richmond. A widespread plot was soon formed, but Richard had early warning, and on the 15th of October, issued a proclamation against Buckingham. Buckingham, as arranged, prepared to enter England with a large force of Welshmen. His advance was stopped by an extraordinary flood on the Severn, his army melted away without striking a blow, and he himself took refuge with a follower, Ralph Bannister, at Lacon Hall, near Wem. The man betrayed him for a large reward, and on the 1st of November, Buckingham was brought to the king at Salisbury. Richard refused to see him, and after a summary trial had him executed next day (2nd of November 1483), though it was a Sunday.

Buckingham's eldest son, Edward (1478-1521), eventually succeeded him as 3rd duke, the attainder being removed in 1485; the second son, Henry, was afterwards earl of Wiltshire. The 3rd duke played an important part as lord high constable at the opening of the reign of Henry VIII., and is introduced into Shakespeare's play of that king, but he fell through his opposition to Wolsey, and in 1521 was condemned for treason and executed (17th of May); the title was then forfeited with his attainder, his only son Henry (1501-1563), who in his father's lifetime was styled earl of Stafford, being, however, given back his estates in 1522, and in 1547 restored in blood by parliament with the title of Baron Stafford, which became extinct in this line with Roger, 5th Baron in 1640. In that year the barony of Stafford was granted to William Howard (1614-1680), who after two months was created Viscount Stafford; he was beheaded in 1680, and his son was created earl of Stafford in 1688, a title which became extinct in 1762; but in 1825 the descent to the barony of 1640 was established, to the satisfaction of the House of Lords, in the person of Sir G. W. Jerningham, in whose family it then continued.

The chief original authorities for the life of the 2nd duke of Buckingham are the *Continuation of the Croyland Chronicle*; Sir Thomas More's *Richard III.*; and Fabyan's *Chronicle*. Amongst modern authorities consult J. Gairdner's *Richard III.*; and Sir J. Ramsay's *Lancaster and York*. (C. L. K.)

BUCKINGHAM, JAMES SILK (1786-1855), English author and traveller, was born near Falmouth on the 25th of August 1786, the son of a farmer. His youth was spent at sea. After years of wandering he established in 1818 the *Calcutta Journal*. This venture at first proved highly successful, but in 1823 the

paper's outspoken criticisms of the East India Company led to the expulsion of Buckingham from India and to the suppression of the paper by John Adam, the acting governor-general. His case was brought before parliament, and a pension of £200 a year was subsequently awarded him by the East India Company as compensation. Buckingham continued his journalistic ventures on his return to England, and started the *Oriental Herald* (1824) and the *Athenaeum* (1828) which was not a success in his hands. In parliament, where he sat as member for Sheffield from 1832-1837, he was a strong advocate of social reform. He was a most voluminous writer. He had travelled much in Europe, America and the East, and wrote a great number of useful books of travel. In 1851 the value of these and of his other literary work was recognized by the grant of a civil list pension of £200 a year. At the time of his death in London, on the 30th of June 1855, Buckingham was at work on his autobiography, two volumes of the intended four being completed and published (1855).

His youngest son, Leicester Silk Buckingham (1825-1867), achieved no little popularity as a playwright, several of his free adaptations of French comedies being produced in London between 1860 and 1867.

BUCKINGHAM, a market town and municipal borough and the county town of Buckinghamshire, England, in the Buckingham parliamentary division, 61 m. N.W. of London by a branch of the London & North-Western railway. Pop. (1901) 3152. It lies in an open valley on the upper part of the river Ouse, which encircles the main portion of the town on three sides. The church of St Peter and St Paul, which was extensively restored by Sir Gilbert Scott, a native of this neighbourhood, is of the 18th century, and stands on the site of the old castle; the town hall dates from the close of the previous century; and the grammar school was founded by Edward VI., in part occupying buildings of earlier date, which retain Perpendicular and Decorated windows, and a Norman door. A chantry, founded in 1268 by Matthew Stratton, archdeacon of Buckingham, previously occupied the site; the Norman work may be a remnant of the chapel of a guild of the Holy Trinity. The manor house is of the early part of the 17th century, and other old houses remain. The adjacent mansion of Stowe, approached from the town by a magnificent avenue of elms, and surrounded by gardens very beautifully laid out, was the seat of the dukes of Buckingham until the extinction of the title in 1889. Buckingham is served by a branch of the Grand Junction Canal, and has agricultural trade, manufactures of condensed milk and artificial manure, maltings and flour-mills; while an old industry survives to a modified extent in the manufacture of pillow-lace. The borough is under a mayor, 4 aldermen and 12 councillors. Area, 5006 acres.

Buckingham (Bochingham, Bukyngham) was an important stronghold in pre-Conquest times, and in 918 Edward the Elder encamped there with his army for four weeks, and threw up two forts on either side of the water. At the time of the Domesday survey there were twenty-six burgesses in Buckingham, which, together with the hamlet of Bourton, was assessed at one hide. Although it appears as a borough thus early, the town received no charter until 1554, when Queen Mary created it a free borough corporate with a bailiff, twelve principal burgesses and a steward, and defined the boundaries as extending in width from Dudley bridge to Thornborow bridge and in length from Chackmore bridge to Padbury Mill bridge. A charter from Charles II. in 1684 was very shortly abandoned in favour of the original grant, which held force until the Municipal Corporations Act of 1835. In 1529 and from 1545 onwards Buckingham returned two members to parliament, until deprived by the Representation of the People Act of 1867 of one member, and by the Redistribution of Seats Act of 1885 of the other. Early mentions occur of markets and fairs, and from 1522, when Henry VIII. granted to Sir Henry Marney the borough of Buckingham with a Saturday market and two annual fairs, grants of fairs by various sovereigns were numerous. Buckingham was formerly an important agricultural centre, and Edward III. fixed here one of the staples for wool, but after the removal of these to Calais the trade suffered such decay that in an act of 32 Henry VIII. Buckingham is mentioned among thirty-six impoverished towns.

BUCKINGHAM AND NORMANBY, JOHN SHEFFIELD, 1st DUKE OF (1648-1721), English statesman and poet, was born on

728 BUCKINGHAMSHIRE, EARLS OF—BUCKINGHAMSHIRE

the 7th of April 1648. He was the son of Edmund, 2nd earl of Mulgrave, and succeeded to that title on his father's death in 1658. At the age of eighteen he joined the fleet, to serve in the first Dutch war; on the renewal of hostilities in 1672 he was present at the battle of Southwold Bay, and in the next year received the command of a ship. He was also made a colonel of infantry, and served for some time under Turenne. In 1680 he was put in charge of an expedition sent to relieve the town of Tangier. It was said that he was provided with a rotten ship in the hope that he would not return, but the reason of this abortive plot, if plot there was, is not exactly ascertained. At court he took the side of the duke of York, and helped to bring about Monmouth's disgrace. In 1682 he was dismissed from the court, apparently for putting himself forward as a suitor for the princess Anne, but on the accession of King James he received a seat in the privy council, and was made lord chamberlain. He supported James in his most unpopular measures, and stayed with him in London during the time of his flight. He also protected the Spanish ambassador from the dangerous anger of the mob. He acquiesced, however, in the Revolution, and in 1694 was made marquess of Normanby. In 1696 he refused in company with other Tory peers to sign an agreement to support William as their "rightful and lawful king" against Jacobite attempts, and was consequently dismissed from the privy council. On the accession of Anne, with whom he was a personal favourite, he became lord privy seal and lord-lieutenant of the North Riding of Yorkshire, and in 1703 duke of Buckingham and Normanby. During the predominance of the Whigs between 1705 and 1710, Buckingham was deprived of his office as lord privy seal, but in 1710 he was made lord steward, and in 1711 lord president of the council. After the death of Anne he held no state appointment. He died on the 24th of February 1721 at his house in St James's Park, which stood on the site of the present Buckingham Palace. Buckingham was succeeded by his son, Edmund (1716-1735) on whose death the titles became extinct.

Buckingham, who is better known by his inherited titles as Lord Mulgrave, was the author of "An Account of the Revolution" and some other essays, and of numerous poems, among them the *Essay on Poetry* and the *Essay on Satire*. It is probable that the *Essay on Satire*, which attacked many notable persons, "sauntering Charles" amongst others, was circulated in MS. It was often attributed at the time to Dryden, who accordingly suffered a thrashing at the hands of Rochester's bravo for the reflections it contained upon the earl. Mulgrave was a patron of Dryden, who may possibly have revised it, but was certainly not responsible, although it is commonly printed with his works. Mulgrave adapted Shakespeare's *Julius Caesar*, breaking it up into two plays, *Julius Caesar* and *Marcus Brutus*. He introduced choruses between the acts, two of these being written by Pope, and an incongruous love scene between Brutus and Portia. He was a constant friend and patron of Pope, who expressed a flattering opinion of his *Essay on Poetry*. This, although smoothly enough written, deals chiefly with commonplaces.

In 1721 Edmund Curll published a pirated edition of his works, and was brought before the bar of the House of Lords for breach of privilege accordingly. An authorized edition under the superintendence of Pope appeared in 1723, but the authorities cut out the "Account of the Revolution" and "The Feast of the Gods" on account of their alleged Jacobite tendencies. These were printed at the Hague in 1727. Pope disingenuously repudiated any knowledge of the contents. Other editions reappeared in 1723, 1726, 1729, 1740 and 1753. His *Poems* were included in Johnson's and other editions of the British poets.

BUCKINGHAMSHIRE, EARLS OF. The first earl of Buckinghamshire (to be distinguished from the earls of Buckingham, *q.v.*) was John Hobart (*c.* 1694-1756), a descendant of Sir Henry Hobart (d. 1625), attorney-general and chief justice of the common pleas under James I., who was made a baronet in 1611, and who was the great-grandson of Sir James Hobart (d. 1507), attorney-general to Henry VII. The Hobarts had been settled in Norfolk and Suffolk for many years, when in 1728 John Hobart, who was a son of Sir Henry Hobart, the 4th baronet (d. 1698), was created Baron Hobart of Blickling. In 1740 Hobart became lord-lieutenant of Norfolk and in 1746 earl of Buckinghamshire, his

sister, Henrietta Howard, countess of Suffolk, being the mistress of George II. He died on the 22nd of September 1756, and was succeeded as 2nd earl¹ by his eldest son John (1723-1793), who was member of parliament for Norwich and comptroller of the royal household before his accession to the title. From 1762 to 1766 he was ambassador to Russia, and from 1776 to 1780 lord-lieutenant of Ireland, but he was hardly equal to the exceptional difficulties with which he had to deal in the latter position. He died without sons at Blickling Hall, Norfolk, on the 3rd of August 1793, when his half-brother George (*c.* 1730-1804), became 3rd earl. Blickling Hall and his Norfolk estates, however, passed to his daughter, Henrietta (1762-1805), the wife of William Kerr, afterwards 6th marquess of Lothian.

Robert Hobart, 4th earl of Buckinghamshire (1760-1816), the eldest son of the 3rd earl, was born on the 6th of May 1760. He was a soldier, and then a member of both the English and the Irish Houses of Commons; from 1789 to 1793 he was chief secretary to the lord-lieutenant of Ireland, exerting his influence in this country to prevent any concessions to the Roman Catholics. In 1793, being known by the courtesy title of Lord Hobart, he was sent to Madras as governor, but in 1798, after serious differences between himself and the governor-general of India, Sir John Shore, afterwards Lord Teignmouth, he was recalled. Returning to British politics, Hobart was called up to the House of Lords in 1798 (succeeding to the earldom of Buckinghamshire in 1804); he favoured the union between England and Ireland; from March 1801 to May 1804 he was secretary for war and the colonies (his family name being taken for Hobart Town in Tasmania), and in 1805 he became chancellor of the duchy of Lancaster under Pitt. For a short time he was joint postmaster-general, and from 1812 until his death on the 4th of February 1816 he was president of the Board of Control, a post for which his Indian experience had fitted him.

The 4th earl left no sons, and his titles passed to his nephew, George Robert Hobart (1789-1849), a son of George Vere Hobart (1761-1802), lieutenant-governor of Grenada. In 1822 the 5th earl inherited the Buckinghamshire estates of the Hampden family and took the name of Hampden, his ancestor, Sir John Hobart, 3rd baronet, having married Mary Hampden about 1655. On his death in February 1849 his brother, Augustus Edward Hobart (1793-1884), who took the name of Hobart-Hampden in 1878, became 6th earl. His two sons, Vere Henry, Lord Hobart (1818-1875), governor of Madras from 1872, and Frederick John Hobart (1821-1875), predeceased him, and when the 6th earl died he was succeeded by his grandson, Sidney Carr Hobart-Hampden (b. 1860), who became 7th earl of Buckinghamshire, and who added to his name that of Mercer-Henderson. Another of the 6th earl's sons was Augustus Charles Hobart-Hampden, generally known as Hobart Pasha (*q.v.*).

See Lord Hobart's *Essays and Miscellaneous Writings*, edited with biography by Lady Hobart (1885).

BUCKINGHAMSHIRE (abbreviated *Bucks*) a south midland county of England, bounded N. by Northamptonshire, E. by Bedfordshire, Hertfordshire and Middlesex, S. for a short distance by Surrey, and by Berkshire, and W. by Oxfordshire. Its area is 743.2 sq. m. The county is divided between the basins of the rivers Ouse and Thames. The first in its uppermost course forms part of the north-western boundary, passes the towns of Buckingham, Stony Stratford, Wolverton, Newport Pagnell and Olney, and before quitting the county forms a short stretch of the north-eastern boundary. The principal tributary it receives within the county is the Ouzel. The Thames forms the entire southern boundary; and of its tributaries Buckinghamshire includes the upper part of the Thames. To the north-west of Buckingham, and both east and west of the Ouzel, the land rises in gentle undulations to a height of nearly 500 ft., and north of the Thames valley a few nearly isolated hills stand boldly, such as Brill Hill and Muswell Hill, each over 600 ft., but the highest

¹ Until 1784, when George Grenville, Earl Temple, was created marquess of Buckingham, the 2nd earl of Buckinghamshire also signed himself "Buckingham"; his contemporaries knew him by this name, and hence a certain amount of confusion has arisen.

part of the county is the south, which is occupied by part of the Chiltern system, the general direction of which is from south-west to north-east. The crest-line of these hills crosses the county at its narrowest point, along a line, above the towns of Prince's Risborough and Wendover, not exceeding 11 m. in length. This line divides the county into two parts of quite different physical character; for to the south almost the whole land is hilly (the longer slope of the Chiltern system lying in this direction), well wooded, and pleasantly diversified with narrow vales. The chief of these are watered by the Wye, Misbourne and Chess streams. The beech tree is predominant in the woods, in so much that William Camden, writing *c.* 1585, supposed the county to take name from this feature (*A.S. boc*, beech). In the south a remnant of ancient forest is preserved as public ground under the name of Burnham Beeches. The Chilterns reach a height of nearly 900 ft. within the county.

Geology.—The northern half of the county is occupied by Jurassic strata, in the southern half Cretaceous rocks predominate except in the south-eastern corner, where they are covered by Tertiary beds. Thus the oldest rocks are in the north, succeeded continuously by younger strata to the south; the general dip of all the rocks is south-easterly. A few patches of Upper Liass Clay appear near the northern boundary near Grafton Regis and Castle Thorpe, and again in the valley of the Ouse near Stoke Goldington and Weston Underwood. The Oolitic series is represented by the Great Oolite, with limestones in the upper part, much quarried for building stones at Westbury, Thornborough, Brock, Whittlewood Forest, &c.; the lower portions are more argillaceous. The Forest Marble is seen about Thornton as a thin bed of clay with an oyster-bearing limestone at the base. Next above is the Cornbrash, a series of rubbly and occasionally hard limestones and thin clays. The outcrop runs by Tingwyck, Buckingham, Berehampton and Newport Pagnell, it is quarried at Wolverton and elsewhere for road metal. Inliers of these rocks occur at Marsh Gibbon and Stan Hill. The Oxford Clay and Kimmeridge Clay, with the Gault, lie in the vale of Aylesbury. The clay is covered by numerous outliers of Portland, Purbeck and Lower Greensand beds. The Portland beds are sandy below, calcareous above; the outcrop follows the normal direction in the county, from south-west to north-east, from Thame through Aylesbury; they are quarried at several places for building stone and fossils are abundant. The Hartwell Clay is in the Lower Portland. Freshwater Purbeck beds lie below the Portland and Lower Greensand beds; they cap the ridge between Oving and Whitchurch. Glass-making sands have been worked from the Lower Greensand at Hartwell, and phosphatic nodules from the same beds at Erickhill as well as from the Gault at Towersey. A broad band of Gault, a bluish clay, extends from Towersey across the county in a north-easterly direction. Resting upon the Gault is the Upper Greensand; at the junction of the two formations numerous springs arise, a circumstance which has no doubt determined the site of several villages. The Chalk rises abruptly from the low lying argillaceous plain to form the Chiltern Hills. The form of the whole of the hilly district round Chesham, High Wycombe and the Chalfonts is determined by the Chalk. Reading beds, mottled clays and sands, repose upon the Chalk at Woburn, Barnham, Fulmer and Denham, and these are in turn covered by the London Clay, which is exposed on the slopes about Stoke Common and Iver. Between the Tertiary-capped Chalk plateau and the Thames, a gentler slope, covered with alluvial gravel and brick earth, reaches down to the river. Thick deposits of plateau gravel cover most of the high ground in the southern corner of the county, while much of the northern part is obscured by glacial clays and gravels.

Industries.—The agricultural capacities of the soil vary greatly in different localities. On the lower lands, especially in the Vale of Aylesbury, about the headwaters of the Thame, it is extremely fertile; while on the hills it is usually poor and thin. The proportion of cultivated land is high, being about 83% of the whole. Of this a large and growing portion is in permanent pasture; cattle and sheep being reared in great numbers for the London markets, to which also are sent quantities of ducks, for which the district round Aylesbury is famous. Wheat and oats are the principal grain crops, though both decrease in importance. Turnips and swedes for the cattle are the chief green crops; and dairy-farming is largely practised. There is no general manufacturing industry, but a considerable amount of lace-making and straw-plaiting is carried on locally; and at High Wycombe and in its neighbourhood there is a thriving trade in various articles of turnery, such as chairs and bowls, from beech and other hard woods. The introduction of lace-making in this and neighbouring counties is attributed to Flemish, and later to

French immigrants, but also to Catharine of Aragon during her residence (*c.* 1532) at Amphill. Down to the later part of the 19th century a general holiday celebrated by lace-makers on the 25th of November was known as "Cattam's Day."

Communications.—The main line of the London & North-Western railway crosses the north-east part of the county. Bletchley is an important junction on this system, branches diverging east to Fenny Stratford, Bedford and Cambridge, and west to Oxford and Banbury, Buckingham being served by the western branch. There is also a branch from Cheddington to Aylesbury. The Metropolitan-Great Central joint line serves Amersham, Chesham (by a branch), and Aylesbury, joining the North-Western Oxford branch at Verney Junction; this line is used by the Great Central railway, the main line of which continues north-westward from Quainton Road. A light railway connects this station with the large village of Brill to the south-west. The Great Central and the Great Western companies jointly own a line passing through Beaconsfield, High Wycombe, and Prince's Risborough, which is connected northward with the Great Central system. Before the opening of this line in 1906 the Great Western branch from Maidenhead to Oxford was the only line serving High Wycombe and Prince's Risborough, from which there are branches to Watlington and Aylesbury. The main line of this company crosses the extreme south of the county by Slough and Taplow. The Grand Junction Canal, reaching the valley of the Ouse by way of the Ouzel valley from the south, has branches to Aylesbury and to Buckingham. Except the Thames none of the rivers in the county is continuously navigable.

Population and Administration.—The area of the ancient county is 475,682 acres, with a population in 1891 of 185,284, and in 1901 of 195,764. The area of the administrative county is 479,358 acres. The county contains eight hundreds, of which three, namely Stoke, Burnham and Desborough, form the "Chiltern Hundreds" (*q.v.*). The hundred of Aylesbury retains its ancient designation of the "three hundreds of Aylesbury." The municipal boroughs are Buckingham, the county town (pop. 3152), and Wycombe, officially Chepping Wycombe, also Chipping or High Wycombe (15,542). The other urban districts are Aylesbury (9243), Beaconsfield (1570), Chesham (7245), Eton (3301), Fenny Stratford (4799), Linslade, on the Ouzel opposite to Leighton Buzzard in Bedfordshire (2157), Marlow (4526), Newport Pagnell (4028), Slough (11,453). Among the lesser market towns may be mentioned Amersham (2574), Ivinghoe (808), Olney (2684), Prince's Risborough (2189), Stony Stratford (2353), Wendover (2009) and Winslow (1703). At Wolverton (5323) are the carriage works of the London & North-Western railway. Several of the villages on and near the banks of the Thames have become centres of residence, such as Taplow, Cookham and Bourne End, Burnham and Wooburn. Buckinghamshire is in the midland circuit, and assizes are held at Aylesbury. It has one court of quarter sessions, and is divided into thirteen petty sessional divisions. The boroughs of Buckingham and Wycombe have separate commissions of the peace. The administrative county contains 230 civil parishes. Buckinghamshire is almost entirely within the diocese of Oxford, and 215 ecclesiastical parishes are situated wholly or in part within it. There are three parliamentary divisions, Northern or Buckingham, Mid or Aylesbury, and Southern or Wycombe, each returning one member; and the county contains a small part of the parliamentary borough of Windsor (chiefly in Berkshire). The most notable institution within the county is Eton College, the famous public school founded by Henry VI.

History.—The district which was to become Buckinghamshire was reached by the West Saxons in 571, as by a series of victories they pushed their way north along the Thames valley. With the grouping of the settlements into kingdoms and the consolidation of Mercia under Offa, Buckinghamshire was included in Mercia until, with the submission of that kingdom to the Northmen, it became part of the Danelaw. In the 10th century Buckinghamshire suffered frequently from the ravages of the Danes, and numerous barrows and earthworks mark the scenes

of struggles against the invaders. These relics are especially abundant in the vale of Aylesbury, probably at this time one of the richest and best protected of the Saxon settlements. The Chiltern district, on the other hand, is said to have been an impassable forest infested by hordes of robbers and wild beasts. In the reign of Edward the Confessor, Leofstan, 12th abbot of St Albans, cut down large tracts of wood in this district and granted the manor of Hamstead (Herts) to a valiant knight and two fellow-soldiers on condition that they should check the depredations of the robbers. The same reason led at an early period to the appointment of a steward of the Chiltern Hundreds, and this office being continued long after the necessity for it had ceased to exist, gradually became the sinecure it is to-day. The district was not finally deforested until the reign of James I.

At the time of the Norman invasion Buckinghamshire was probably included in the earldom of Leofwine, son of Godwin, and the support which it lent him at the battle of Hastings was punished by sweeping confiscations after the Conquest. The proximity of Buckinghamshire to London caused it to be involved in most of the great national events of the ensuing centuries. During the war between King John and his barons William Mauduit held Hanslope Castle against the king, until in 1216 it was captured and demolished by Falkes de Bréauté. The county was visited severely by the Black Death, and Winslow was one of many districts which were almost entirely depopulated. In the civil war Buckinghamshire was one of the first counties to join in an association for mutual defence on the side of the parliament, which had important garrisons at Aylesbury, Brill and elsewhere. Newport Pagnell was for a short time garrisoned by the royalist troops, and in 1644 the king fixed his headquarters at Buckingham.

The shire of Buckingham originated with the division of Mercia in the reign of Edward the Elder, and was probably formed by the aggregation of pre-existing hundreds round the county town, a fact which explains the curious irregularities of the boundary line. The eighteen hundreds of the Domesday survey have now been reduced to eight, of which the three Chiltern hundreds, Desborough, Burnham and Stoke, are unaltered in extent as well as in name. The remainder have been formed each by the union of three of the ancient hundreds, and Aylesbury is still designated "the three hundreds of Aylesbury." All, except Newport and Buckingham, retain the names of Domesday hundreds, and the shire has altered little on its outer lines since the survey. Until the time of Queen Elizabeth Buckinghamshire and Bedfordshire had a common sheriff. The shire court of the former county was held at Aylesbury.

The ecclesiastical history of Buckinghamshire is not easy to trace, as there is no local chronicler, but the earliest churches were probably subject to the West Saxon see of Dorchester, and when after the Conquest the bishop's stool was transferred to Lincoln no change of jurisdiction ensued. After the dissolution of the monasteries it was proposed to form a new diocese to include Bedfordshire and Buckinghamshire, but the project was abandoned, and both remained in the Lincoln diocese until 1837, when the latter was transferred to Oxford. The archdeaconry was probably founded towards the close of the 11th century by Bishop Rémy, and the subdivision into rural deaneries followed shortly after. A dean of Thornborough is mentioned in the 12th century, and in the taxation of Nicholas IV. eight deaneries are given, comprising 186 parishes. In 1855 the deaneries were reconstructed and made eighteen in number.

On the redistribution of estates after the Conquest only two Englishmen continued to retain estates of any importance, and the chief landowners at this date were Walter Giffard, first earl of Buckingham, and Odo, bishop of Bayeux. Few of the great Buckinghamshire estates, however, remained with the same proprietors for any length of time. Many became annexed by religious establishments, while others reverted to the crown and were disposed of by various grants. The family of Hampden alone claim to have held the estate from which the name is derived in an unbroken line from Saxon times.

Buckinghamshire has always ranked as an agricultural rather than a manufacturing county, and has long been famed for its corn and cattle. Fuller mentions the vale of Aylesbury as producing the biggest bodied sheep in England, and "Buckinghamshire bread and beef" is an old proverb. Lace-making, first introduced into this county by the Fleming refugees from the Alva persecution, became a very profitable industry. The monopolies of James I. considerably injured this trade, and in 1623 a petition was addressed to the high sheriff of Buckinghamshire representing the distress of the people owing to the decay of bone lace-making. Newport Pagnell and Olney were especially famous for their lace, and the parish of Hanslope is said to have made an annual profit of £8000 to £9000 from lace manufacture. The straw-plait industry was introduced in the reign of George I., and formerly gave employment to a large number of the population.

The county was first represented in parliament by two members in 1290. The representation increased as the towns acquired representative rights, until in 1603 the county with its boroughs made a total return of fourteen members. By the Reform Act of 1832 this was reduced to eleven, and by the Redistribution of Seats Act of 1885 the boroughs were deprived of representation and the county returned three members for three divisions.

Antiquities.—Buckinghamshire contains no ecclesiastical buildings of the first rank. Monastic remains are scanty, but two former abbeys may be noted. At Medmenham, on the Thames above Marlow, there are fragments, incorporated into a residence, of a Cistercian abbey founded in 1201; which became notorious in the middle of the 18th century as the meeting-place of a convivial club called the "Franciscans" after its founder, Sir Francis Dashwood, afterwards Lord is Despencer (1708-1781), and also known as the "Hell-Fire Club," of which John Wilkes, Bubb Dodginton and other political notoriety were members. The motto of the club, *sey ce que vousdas* (do what you will), inscribed on a doorway at the abbey, was borrowed from Rabelais' description of the abbey of Thebaix in *Gargantua*. The remains of the Augustinian Nottley Abbey (1162), incorporated with a farm-house, deserve mention rather for their picturesque situation by the river Thame than for their architectural value. Turning to churches, there is workmanship considered to be of pre-Norman date in Wing church, in the neighbourhood of Leighton Buzzard, including a polygonal apse and chrype. Stewley church, in the same locality, shows the finest Norman work in the county; the building is almost wholly of the later part of this period, and the ornamentation is very rich. The Early English work of Chetwode and Haddenham churches, both in the west of the county, is noteworthy; especially in the first, which, as it stands, is the eastern part of a priory church of Augustinians (1244). Good specimens of the Decorated style are not wanting, though none is of special note; but the county contains three fine examples of Perpendicular architecture in Eton College chapel and the churches of Maids Moreton to the north, and Hillesden to the south, of Buckingham. Ancient domestic architecture is chiefly confined to a few country houses, of which Chiequers Court, dating from the close of the 16th century, is of interest not only from the architectural standpoint but from its beautiful situation high among the Chiltern Hills between Prince's Risborough and Wendover, and from a remarkable collection of relics of Oliver Cromwell, preserved here as a consequence of the marriage, in 1664, of John Russell, a grandson of the Protector, into the family to which the house then belonged. The manor-house of Hampden, among the hills east of Prince's Risborough, was for many generations the abode of the family of that name, and is still in the possession of descendants of John Hampden, who fell at the battle of Chalgrove in 1643, and is buried in Hampden church. Fine county seats are numerous—there may be mentioned Stowe (Buckingham), formerly the seat of the dukes of Buckingham; Cliveden and Hedsor, two among the many beautifully situated mansions by the bank of the Thames; and Claydon House in the west of the county. Among the Chiltern Hills, also, there are several

splendid domains. Associations with eminent men have given a high fame to several towns or villages of Buckinghamshire. Such are the connexion of Beaconsfield with Edmund Waller and Edmund Burke, that of Hughenden near Wycombe with Benjamin Disraeli, Lord Beaconsfield, whose father's residence was at Bradenham; of Olney and Stoke Pogis with the poets Cowper and Gray respectively. At Chalfont St Giles a cottage still stands in which Milton completed *Paradise Lost* and began *Paradise Regained*. In earlier life he had lived and worked at Horton, near the Thames below Windsor.

AUTHORITIES.—The original standard history is the laborious work of G. Lipcomb, *History and Antiquities of the County of Buckingham* (London, 1831-1847). Other works are: Browne Willis, *History and Antiquities of the Town, Hundred, and Deanery of Buckingham* (London, 1755); D. and S. Lyons, *Magna Britannia*, vol. i.; R. Gibbs, *Buckingham* (Aylesbury, 1878-1882); *Worthies of Buckingham* (Aylesbury, 1886); and *Buckingham Miscellany* (Aylesbury, 1891); C. S. Roscoe, *Buckingham Sketches* (London, 1891); P. H. Ditchfield, *Memorials of Old Buckinghamshire* (London, 1901); *Victoria County History*, "Buckinghamshire."

BUCKLAND, FRANCIS TREVELYAN (1826-1880), English zoologist, son of Dean William Buckland the geologist, was born at Oxford on the 17th of December 1826. He was educated at Winchester and Christ Church, taking his degree in 1848, and then adopted the medical profession, studying at St George's hospital, London, where he became house-surgeon in 1852. The pursuit of anatomy led him to a good deal of out-of-the-way research in zoology, and in 1856 he became a regular writer on natural history for the newly established *Field*, particularly on the subject of fish. In 1866 he started *Land and Water* on similar lines. In 1867 he was appointed government inspector of fisheries, and in the course of his work travelled constantly about the country, being largely responsible for the increased attention paid to the scientific side of pisciculture. Among his publications, besides articles and official reports, were *Fish Hatching* (1863), *Curiousities of Natural History* (4 vols., 1857-1872), *Logbook of a Fisherman* (1875), *Natural History of British Fishes* (1881). He died on the 19th of December 1880.

See *Life* by G. C. Bompas (1885).

BUCKLAND, WILLIAM (1784-1856), English divine and geologist, eldest son of the Rev. Charles Buckland, rector of Templeton and Trusham, in Devon, was born at Arminster on the 12th of March 1784. He was educated at the grammar school of Tiverton, and at Winchester, and in 1801 was elected a scholar of Corpus Christi College, Oxford, becoming B. A. in 1804. In 1809 he was elected a fellow of his college, and was admitted into holy orders. From early boyhood he had exhibited a strong taste for natural science, which was subsequently stimulated by the lectures of Dr John Kidd on mineralogy and chemistry; and his attention was especially drawn to the then infant science of geology. He also attended the lectures of Sir Christopher Pegge (1765-1822) on anatomy. He now devoted himself systematically to an examination of the geological structure of Great Britain, making excursions, and investigating the order of superposition of the strata and the characters of the organic remains which they contained. In 1813, on the resignation of Dr Kidd, he was appointed reader in mineralogy in Oxford; and the interest excited by his lectures was so great that in 1819 a readership in geology was founded and especially endowed by the treasury, Dr Buckland being the first holder of the new appointment. In 1818 Dr Buckland was elected a fellow of the Royal Society, and in 1824 and again in 1840 he was chosen president of the Geological Society of London. In 1825 he was presented by his college to the living of Stoke Charity, near Whitechurch, Hants, and in the same year he was appointed by Lord Liverpool to a canonry of the cathedral of Christ Church, Oxford, when the degree of D.D. was conferred upon him. In 1825, also, he married Mary, the eldest daughter of Mr Benjamin Morland of Sheepstead House, near Abingdon, Berks, by whose abilities and excellent judgment he was materially assisted in his literary labours. In 1832 he presided over the second meeting of the British Association, which was then held at Oxford. In 1845 he was appointed by Sir Robert Peel to the vacant deanery

of Westminster, and was soon after inducted to the living of Islip, near Oxford, a preferment attached to the deanery. In 1847 he was appointed a trustee in the British Museum; and in 1848 he was awarded the Wollaston medal by the Geological Society of London. In 1849 his health began to give way under the increasing pressure of his multifarious duties; and the later years of his life were overshadowed by a serious illness, which compelled him to live in retirement. He died on the 24th of August 1856, and was buried in a spot which he had himself chosen in Islip churchyard.

Buckland was a man many-sided in his abilities, and of a singularly wide range of attainments. Apart from his published works and memoirs in connexion with the special department of geology, and in addition to the work entailed upon him by the positions which he at different times held in the Church of England, he entered with great enthusiasm into many practical questions connected with agricultural and sanitary science, and various social and even medical problems. As a teacher he possessed powers of the highest order; and the university of Oxford is enriched by the large and valuable private collections, illustrative of geology and mineralogy, which he amassed in the course of his active life. It is, however, upon his published scientific works that Dr Buckland's great reputation is mainly based. His first great work was the well-known *Reliquiæ Diuvianæ, or Observations on the Organic Remains contained in caves, fissures, and diluvial gravel attesting the Action of a Universal Deluge*, published in 1823 (2nd ed. 1824), in which he supplemented his former observations on the remains of extinct animals discovered in the cavern of Kirkdale in Yorkshire, and expounded his views as to the bearing of these and similar cases on the Biblical account of the Deluge. Thirteen years after the publication of the *Reliquiæ*, Dr Buckland was called upon, in accordance with the will of the earl of Bridgewater, to write one of the series of works known as the *Bridgewater Treatises*. The design of these treatises was to exhibit the "power, wisdom, and goodness of God, as manifested in the Creation," and none of them was of greater value, as evinced by its vitality, than that on "Geology and Mineralogy." Originally published in 1836, it has gone through three editions, and though not a "manual" of geological science, it still possesses high value as a storehouse of geological and palaeontological facts bearing upon the particular argument which it was designed to illustrate. The third edition, issued in 1858, was edited by his son Francis T. Buckland, and is accompanied by a memoir of the author and a list of his publications.

Of Dr Buckland's numerous original contributions to the sciences of Geology and Palaeontology, the following may be mentioned:—(1) "On the Structure of the Alps and adjoining parts of the Continent, and their relation to the Secondary and Transition Rocks of England" (*Annals of Phil.*, 1821); (2) "Account of an Assemblage of Fossil Teeth and Bones of Elephant, Rhinoceros, Hippopotamus, &c., discovered in a cave at Kirkdale in Yorkshire in the year 1821" (*Phil. Trans.*); (3) "On the Quartz Rock of the Lickey Hill in Worcestershire" (*Trans. Geol. Soc.*); (4) "On the Megalosaurus or Great Fossil Lizard of Stonesfield" (*Ibid.*); (5) "On the Cycadeoideæ, a Family of Plants found in the Oolite Quarries of the Isle of Portland" (*Ibid.*); (6) "On the Discovery of a New Species of Pterodactyle in the Lias of Lyme Regis" (*Ibid.*); (7) "On the Discovery of Coprolites or Fossil Faeces in the Lias of Lyme Regis, and in other Formations" (*Ibid.*); (8) "On the Evidences of Glaciers in Scotland and the North of England" (*Proc. Geol. Soc. Lond.*); (9) "On the South-Western Coal District of England" (joint paper with the Rev. W. D. Conybeare, *Trans. Geol. Soc. Lond.*); (10) "On the Geology of the neighbourhood of Weymouth, and the adjacent parts of the Coast of Dorset" (joint paper with Sir H. De la Beche, *Trans. Geol. Soc. Lond.*).

With regard to the Glacial theory propounded by Agassiz, no one welcomed it with greater ardour than Buckland, and he zealously sought to trace out evidences of former glaciation in Britain. A record of the interesting discussion which took place at the Geological Society's meeting in London in November 1840,

after the reading of a paper by Buckland, was printed in the *Midland Naturalist*, October 1883.

BUCKLE, HENRY THOMAS (1812-1862), English historian, author of the *History of Civilization*, the son of Thomas Henry Buckle, a wealthy London merchant, was born at Lee, in Kent, on the 24th of November 1812. Owing to his delicate health he was only a very short time at school, and never at college, but the love of reading having been early awakened in him, he was allowed ample means of gratifying it. He gained his first distinctions not in literature but in chess, being reputed, before he was twenty, one of the first players in the world. After his father's death in January 1840 he spent some time with his mother on the continent (1840-1844). He had by that time formed the resolution to direct all his reading and to devote all his energies to the preparation of some great historical work, and during the next seventeen years he bestowed ten hours each day in working out his purpose. At first he contemplated a history of the middle ages, but by 1851 he had decided in favour of a history of civilization. The six years which followed were occupied in writing and rewriting, altering and revising the first volume, which appeared in June 1857. It at once made its author a literary and even social celebrity,—the lion of a London season. On the 19th of March 1858 he delivered at the Royal Institution a public lecture (the only one he ever gave) on the *Influence of Women on the Progress of Knowledge*, which was published in *Fraser's Magazine* for April 1858, and reprinted in the first volume of the *Miscellaneous and Posthumous Works*. On the 1st of April 1859 a crushing and desolating affliction fell upon him in the death of his mother. It was under the immediate impression of his loss that he concluded a review he was writing of J. S. Mill's *Essay on Liberty* with an argument for immortality, based on the yearning of the affections to regain communion with the beloved dead,—on the impossibility of standing up and living, if we believed the separation were final. The argument is a strange one to have been used by a man who had maintained so strongly that "we have the testimony of all history to prove the extreme fallibility of consciousness." The review appeared in *Fraser's Magazine*, May 1859, and is to be found also in the *Miscellaneous and Posthumous Works* (1872). The second volume of his history was published in May 1861. Soon after he left England for the East, in order to recruit his spirits and restore his health. From the end of October 1861 to the beginning of March 1862 was spent by him in Egypt, from which he went over the desert of Sinai and of Edom to Syria, reaching Jerusalem on the 19th of April 1862. After staying there eleven days, he set out for Europe by Beyrout, but at Nazareth he was attacked by fever; and he died at Damascus on the 29th of May 1862.

Buckle's fame, which must rest wholly on his *History of Civilization in England*, is no longer what it was in the decade following his death. His *History* is a gigantic unfinished introduction, of which the plan was, first to state the general principles of the author's method and the general laws which govern the course of human progress; and secondly, to exemplify these principles and laws through the histories of certain nations characterized by prominent and peculiar features,—Spain and Scotland, the United States and Germany. Its chief ideas are—(1) That, owing partly to the want of ability in historians, and partly to the complexity of social phenomena, extremely little had as yet been done towards discovering the principles which govern the character and destiny of nations, or, in other words, towards establishing a science of history; (2) That, while the theological dogma of predestination is a barren hypothesis beyond the province of knowledge, and the metaphysical dogma of free will rests on an erroneous belief in the infallibility of consciousness, it is proved by science, and especially by statistics, that human actions are governed by laws as fixed and regular as those which rule in the physical world; (3) That climate, soil, food, and the aspects of nature are the primary causes of intellectual progress,—the first three indirectly, through determining the accumulation and distribution of wealth, and the last by directly influencing the accumulation and distribution of thought,

the imagination being stimulated and the understanding subdued when the phenomena of the external world are sublime and terrible, the understanding being emboldened and the imagination curbed when they are small and feeble; (4) That the great division between European and non-European civilization turns on the fact that in Europe man is stronger than nature, and that elsewhere nature is stronger than man, the consequence of which is that in Europe alone has man subdued nature to his service; (5) That the advance of European civilization is characterized by a continually diminishing influence of physical laws, and a continually increasing influence of mental laws; (6) That the mental laws which regulate the progress of society cannot be discovered by the metaphysical method, that is, by the introspective study of the individual mind, but only by such a comprehensive survey of facts as will enable us to eliminate disturbances, that is, by the method of averages; (7) That human progress has been due, not to moral agencies, which are stationary, and which balance one another in such a manner that their influence is unfelt over any long period, but to intellectual activity, which has been constantly varying and advancing;—"The actions of individuals are greatly affected by their moral feelings and passions; but these being antagonistic to the passions and feelings of other individuals, are balanced by them, so that their effect is, in the great average of human affairs, nowhere to be seen, and the total actions of mankind, considered as a whole, are left to be regulated by the total knowledge of which mankind is possessed"; (8) That individual efforts are insignificant in the great mass of human affairs, and that great men, although they exist, and must "at present" be looked upon as disturbing forces, are merely the creatures of the age to which they belong; (9) That religion, literature and government are, at the best, the products and not the causes of civilization; (10) That the progress of civilization varies directly as "scepticism," the disposition to doubt and to investigate, and inversely as "credulity" or "the protective spirit," a disposition to maintain, without examination, established beliefs and practices.

Unfortunately Buckle either could not define, or cared not to define, the general conceptions with which he worked, such as those denoted by the terms "civilization," "history," "science," "law," "scepticism," and "protective spirit"; the consequence is that his arguments are often fallacies. Moreover, the looseness of his statements and the rashness of his inferences regarding statistical averages make him, as a great authority has remarked, the *enfant terrible* of moral statisticians. He brought a vast amount of information from the most varied and distant sources to confirm his opinions, and the abundance of his materials never perplexed or burdened him in his argumentation, but examples of well-conducted historical argument are rare in his pages. He sometimes altered and contorted the facts; he very often unduly simplified his problems; he was very apt when he had proved a favourite opinion true to infer it to be the whole truth. On the other hand, many of his ideas have passed into the common literary stock, and have been more precisely elaborated by later writers on sociology and history; and though his own work is now somewhat neglected, its influence was immensely valuable in provoking further research and speculation.

See his *Life* by A. W. Huth (1880).

BUCKNER, SIMON BOLIVAR (1823-), American soldier and political leader, was born in Hart county, Kentucky, on the 1st of April 1823. He graduated at West Point in 1844, and was assistant professor of geography, history and ethics there in 1845-1846. He fought in several battles of the Mexican War, received the brevet of first lieutenant for gallantry at Churubusco, where he was wounded, and later, after the storming of Chapultepec, received the brevet of captain. In 1848-1850 he was assistant instructor of infantry tactics at West Point. During the succeeding five years he was in the recruiting service, on frontier duty, and finally in the subsistence department. He resigned from the army in March 1855. During the futile attempt of Governor Beriah Magoffin to maintain Kentucky in a position of neutrality, he was commander of the state

guard; but in September 1861, after the entry of Union forces into the state, he openly espoused the Confederate cause and was commissioned brigadier-general, later becoming lieutenant-general. He was third in command of Fort Donelson at the time of General Grant's attack (February 1862), and it fell to him, after the escape of Generals Floyd and Pillow, to surrender the post with its large garrison and valuable supplies. General Buckner was exchanged in August of the same year, and subsequently served under General Bragg in the invasion of Kentucky and the campaign of Chickamauga. He was governor of Kentucky in 1887-1891, was a member of the Kentucky constitutional convention of 1890, and in 1896 was the candidate of the National or "Gold" Democrats for vice-president of the United States.

BUCKRAM (a word common, in various early forms, to many European languages, as in the Fr. *bouqueran* or Ital. *buckrame*, the derivation of which is unknown), in early usage the name of a fine linen or cotton cloth, but now only of a coarse fabric of linen or cotton stiffened with glue or other substances, used for linings of clothes and in bookbinding. Falstaff's "men in buckram" (Shakespeare, *Henry IV.*, pt. I. II. 4) has become a proverbial phrase for any imaginary persons.

BUCKSTONE, JOHN BALDWIN (1802-1870), English actor and dramatic writer, was born at Hoxton on the 14th of September 1802. He was articled to a solicitor, but soon exchanged the law for the stage. After some years as a provincial actor he made his first London appearance, on the 30th of January 1823, at the Surrey theatre, as Ramsay in the *Fortunes of Nigel*. His success led to his engagement in 1827 at the Adelphi, where he remained as leading low comedian until 1833. At the Haymarket, which he joined for summer seasons in 1833, and of which he was lessee from 1853 to 1878, he appeared as Bobby Trot in his own *Luke the Labourer*; and here were produced a number of his plays and farces, *Ellen Wareham*, *Uncle Tom* and others. After his return from a visit to the United States in 1840 he played at several London theatres, among them the Lyceum, where he was Box at the first representation of *Box and Cox*. As manager of the Haymarket he surrounded himself with an admirable company, including Sothorn and the Kendals. He produced the plays of Gilbert, Planché, Tom Taylor and Robertson, as well as his own, and in most of these he acted. He died on the 31st of October 1870. He was the author of 150 plays, some of which have been very popular. His daughter, Lucy Isabella Buckstone (1858-1893), was an actress, who made her first London appearance at the Haymarket theatre as Ada Ingot in *David Garrick* in 1875.

BUCKTHORN, known botanically as *Rhamnus cathartica* (natural order Rhamnaceae), a much-branched shrub reaching 10 ft. in height, with a blackish bark, spinous branchlets, and ovate, sharply-serrated leaves, 1 to 2 in. long, arranged several together at the ends of the shoots. The small green flowers are regular and have the parts in fours; male and female flowers are borne on different plants. The fruit is succulent, black and globose, and contains four stones. The plant is a native of England, occurring in woods and thickets chiefly on the chalk; it is rare in Ireland and not wild in Scotland. It is native in Europe, north Africa and north Asia, and naturalized in some parts of eastern North America. The fruit has strong purgative properties, and the bark yields a yellow dye.

An allied species, *Rhamnus Frangula*, is also common in England, and is known as berry-bearing or black alder. It is distinguished from buckthorn by the absence of spiny branchlets, its non-serrated leaves, and bisexual flowers with parts in fives. The fruits are purgative and yield a green dye when unripe. The soft porous wood, called black dogwood, is used for gunpowder. Dyes are obtained from fruits and bark of other species of *Rhamnus*, such as *R. infectoria*, *R. tinctoria* and *R. donnicca*—the two latter yielding the China green of commerce. Several varieties of *R. Alaternus*, a Mediterranean species, are grown in shrubberies.

Sea-buckthorn is *Hippophae rhamnoides*, a willow-like shrub, 1 to 8 ft. in height, with narrow leaves silvery on the under-

side, and globose orange-yellow fruits one-third of an inch in diameter. It occurs on sandy seashores from York to Kent and Sussex, but is not common.

American buckthorns are: *Rhamnus purshiana* or *Cascara sagrada*, of the Pacific coast, producing cascara bark, and *R. Caroliniana*, the alder-buckthorn. *Bumelia lycioides* (or *lanuginosa*) is popularly called "southern buckthorn."

BUCKWHEAT, the fruit (so-called seeds) of *Fagopyrum esculentum* (natural order Polygonaceae), a herbaceous plant, native of central Asia, but cultivated in Europe and North America; also extensively cultivated in the Himalaya, as well as an allied species *F. tataricum*. The fruit has a dark brown tough rind enclosing the kernel or seed, and is three-sided in form, with sharp angles, similar in shape to beech-mast, whence the name from the Ger. *Buckweizen*, beechwheat. Buckwheat is grown in Great Britain only to supply food for pheasants and to feed poultry, which devour the seeds with avidity. In the northern countries of Europe, however, the seeds are employed as human food, chiefly in the form of cakes, which when baked thin have an agreeable taste, with a darkish somewhat violet colour. The meal of buckwheat is also baked into crumpets, as a favourite dainty among Dutch children, and in the Russian army buckwheat groats are served out as part of the soldiers' rations, which they cook with butter, tallow or hemp-seed oil. Buckwheat is also used as food in the United States, where "buckwheat cakes" are a national dish; and by the Hindus it is eaten on "bart" or fast days, being one of the phalahas or lawful foods for such occasions. When it is used as food for cattle the hard sharp angular rind must first be removed. As compared with the principal cereal grains, buckwheat is poor in nitrogenous substances and fat; but the rapidity and ease with which it can be grown render it a fit crop for very poor, badly tilled land. An immense quantity of buckwheat honey is collected in Russia, bees showing a marked preference for the flowers of the plant. The plant is also used as a green fodder.

In the United States buckwheat is sown at the end of June or beginning of July, the amount of seed varying from 3 to 5 pecks to the acre. The crop matures rapidly and continues blooming till frosts set in, so that at harvest, which is usually set to occur just before this period, the grain is in various stages of ripeness. It is cut by hand or with the self-delivery reaper, and allowed to lie in the swath for a few days and then set up in shocks. The stalks are not tied into bundles as in the case of other grain crops, the tops of the shocks being bound round and held together by twisting stems round them. The threshing is done on the field in most cases.

BUCOLICS (from the Gr. *βουκολικός*, "pertaining to a herdsman"), a term occasionally used for rural or pastoral poetry. The expression has been traced back in English to the beginning of the 14th century, being used to describe the "Eclogues" of Virgil. The most celebrated collection of bucolics in antiquity is that of Theocritus, of which about thirty, in the Doric dialect, and mainly written in hexameter verse, have been preserved. This was the name, as is believed, originally given by Virgil to his pastoral poems, with the direct object of challenging comparison with the writings of Theocritus. In modern times the term "bucolics" has not often been specifically given by the poets to their pastorals; the main exception being that of Ronsard, who collected his eclogues under the title of "Les Bucoliques." In general practice the word is almost a synonym for pastoral poetry, but has come to bear a slightly more agricultural than shepherd signification, so that the "Georgics" of Virgil has grown to seem almost more "bucolic" than his "Eclogues." (See also PASTORAL.) (E. G.)

BUCYRUS, a city and the county-seat of Crawford county, Ohio, U.S.A., on the Sandusky river, 62 m. N. of Columbus. Pop. (1890) 5974; (1900) 6560 (756 foreign-born); (1910) 8122. It is served by the Pennsylvania, the Toledo, Wallowing Valley & Ohio (Pennsylvania system), and the Ohio Central railways, and by interurban electric lines. The Ohio Central, of which Bucyrus is a division terminal, has shops here. The city lies at an elevation of about 1000 ft. above sea-level, and is surrounded

by a country well adapted to agriculture and stock-raising. Among its manufactures are machinery, structural steel, ventilating and heating apparatus, furniture, interior woodwork, ploughs, wagons, carriages, copper products and clay-working machines. Bucyrus was first settled in 1817; it was laid out as a town in 1822, was incorporated as a village in 1830, and became a city in 1885. The county-seat was permanently established here in 1830.

BUDAPEST, the capital and largest town of the kingdom of Hungary, and the second town of the Austro-Hungarian monarchy, 163 m. S.E. of Vienna by rail. Budapest is situated on both banks of the Danube, and is formed of the former towns of Buda (Ger. *Ofen*) together with O-Buda (Ger. *All-Ofen*) on the right bank, and of Pest together with Kőbánya (Ger. *Steinbruch*) on the left bank, which were all incorporated into one municipality in 1872. It lies at a point where the Danube has definitely taken its southward course, and just where the outlying spurs of the outer ramifications of the Alps, namely, the Bakony Mountains, meet the Carpathians. Budapest is situated nearly in the centre of Hungary, and dominates by its strategical position the approach from the west to the great Hungarian plain. The imposing size of the Danube, 300 to 650 yds. broad, and the sharp contrast of the two banks, place Budapest among the most finely situated of the larger towns of Europe. On the one side is a flat sandy plain, in which lies Pest, modern of aspect, regularly laid out, and presenting a long frontage of handsome buildings to the river. On the other the ancient town of Buda straggles capriciously over a series of small and steep hills, commanded by the fortress and the Blocksberg (770 ft. high, 390 ft. above the Danube), and backed beyond by spurs of mountains, which rise in the form of terraces one above the other. The hills are generally devoid of forests, while those near the town were formerly covered with vineyards, which produced a good red wine: The vineyards have been almost completely destroyed by the phylloxera.

Budapest covers an area of 78 sq. m., and is divided into ten municipal districts, namely Vár (Festung), Viziváros (Wasserstadt), Ó-Buda (Alt-Ofen), all on the right bank, belonging to Buda, and Belváros (Inner City), Lipótváros (Leopoldstadt), Terézváros (Theresienstadt), Erzsébetváros (Elisabethstadt), Józsefváros (Josephstadt), Ferencváros (Franzstadt), and Kőbánya (Steinbruch), all on the left bank, belonging to Pest. Buda, with its royal palace, the various ministries, and other government offices, is the official centre, while Pest is the commercial and industrial part, as well as the centre of the nationalistic and intellectual life of the town. The two banks of the Danube are united by six bridges, including two fine suspension bridges; the first of them, generally known as the Ketten-Brücke, constructed by the brothers Tiernay and Adam Clark in 1842-1849, is one of the largest in Europe. It is 410 yds. long, 39 ft. broad, 36 ft. high above the mean level of the water, and its chains rest on two pillars 160 ft. high; its ends are ornamented with four colossal stone lions. At one end is a tunnel, 383 yds. long, constructed by Adam Clark in 1854, which pierces the castle hill and connects the quarter known as the Christinenstadt with the Danube. The other suspension bridge is the Schwurplatz bridge, completed in 1903, 56 ft. broad, with a span of 317 yds. The other bridges are the Margaret bridge, with a junction bridge towards the Margaret island, the Franz Joseph bridge, and two railway bridges.

Perhaps the most attractive part of Budapest is the line of broad quays on the left bank of the Danube, which extend for a distance of 2½ m. from the Margaret bridge to the custom-house, and are lined with imposing buildings. The most important of these is the Franz Joseph Quay, 1 m. long, which contains the most fashionable cafés and hotels, and is the favourite promenade. The inner town is surrounded by the Innere Ring-Strasse, a circle of wide boulevards on the site of the old wall. Wide tree-shaded streets, like the Király Utca, the Kerrepsi Ut, and the Üllői Ut, also form the lines of demarcation between the different districts. The inner ring is connected by the Váci Körtut (Waltzer-Ring) with the Grosse Ring-Strasse, a succession

of boulevards, describing a semicircle beginning at the Margaret bridge and ending at the Boráros Platz, near the custom-house quay, through about the middle of the town. One of the most beautiful streets in the town is the Andrássy Ut, 1½ m. long, connecting Váci Körtut with Városliget (*Stadtparkchen*), the favourite public park of Budapest. It is a busy thoroughfare, lined in its first half with magnificent new buildings, and in its second half, where it attains a width of 150 ft., with handsome villas standing in their own gardens, which give the impression rather of a fashionable summer resort than the centre of a great city. Budapest possesses numerous squares, generally ornamented with monuments of prominent Hungarians, usually the work of Hungarian artists.

Buildings.—Though of ancient origin, neither Buda nor Pest has much to show in the way of venerable buildings. The oldest church is the Matthias church in Buda, begun by King Bela IV. in the 13th century, completed in the 15th century, and restored in 1890-1896. It was used as a mosque during the Turkish occupation, and here took place the coronation of Franz Joseph as king of Hungary in 1867. The garrison church, a Gothic building of the 13th century, and the Reformed church, finished in 1898, are the other ecclesiastical buildings in Buda worth mentioning. The oldest church in Pest is the parish church situated in the Eskü-Ter (Schwur-Platz) in the inner town; it was built in 1500, in the Gothic style, and restored in 1890. The most magnificent church in Pest is the Leopoldstadt Basilica, a Romanesque building with a dome 315 ft. in height, begun in 1851; next comes the Franzstadt church, also a Romanesque building, erected in 1874. Besides several modern churches, Budapest possesses a beautiful synagogue, in the Moorish style, erected in 1861, and another, in the Moorish-Byzantine style, built in 1872, while in 1901 the construction of a much larger synagogue was begun. In Buda, near the Kaiserbad, and not far from the Margaret bridge, is a small octagonal Turkish mosque, with a dome 25 ft. high, beneath which is the grave of a Turkish monk. By a special article in the treaty of Karlowitz of 1699 the emperor of Austria undertook to preserve this monument.

Among the secular buildings the first place is taken by the royal palace in Buda, which, together with the old fortress, crowns the summit of a hill, and forms the nucleus of the town. The palace erected by Maria Theresa in 1748-1771 was partly burned in 1849, but has been restored and largely extended since 1894. In the court chapel are preserved the regalia of Hungary, namely, the crown of St Stephen, the sceptre, orb, sword and the coronation robes. It is surrounded by a magnificent garden, which descends in steep terraces to the Danube, and which offers a splendid view of the town lying on the opposite bank. New and palatial buildings of the various ministries, several high and middle schools, a few big hospitals, and the residences of several Hungarian magnates, are among the principal edifices in this part of the town.

The long range of substantial buildings fronting the left bank of the Danube includes the Houses of Parliament (see ARCHITECTURE, Plate IX. fig. 115), a huge limestone edifice in the late Gothic style, covering an area of 3½ acres, erected in 1883-1902; the Academy, in Renaissance style, erected in 1862-1864, containing a lofty reception room, a library, a historic picture gallery, and a botanic collection; the Redoute buildings, a large structure in a mixed Romanesque and Moorish style, erected for balls and other social purposes; the extensive custom-house at the lower end of the quays, and several fine hotels and insurance offices. In the beautiful Andrássy Ut are the opera-house (1875-1884), in the Italian Renaissance style; the academy of music; the old and new exhibition building; the national drawing school; and the museum of fine arts (1900-1905), in which was installed in 1905 the national gallery, formed by Prince Esterházy, bought by the government in 1865 for £130,000, and formerly housed in the academy, and the collection of modern pictures from the national museum. At the end of the street is one of the numerous monuments erected in various parts of the country to commemorate the thousandth anniversary of the foundation of the kingdom of Hungary. Other buildings remarkable for their

size and interest are: the national museum (1836-1844); the town-hall (1869-1875), in the early Renaissance style; the university, with a baroque façade (rebuilt 1900), and the university library (opened in 1875), a handsome Renaissance building; the palace of justice (1896), a magnificent edifice situated not far from the Houses of Parliament. In its neighbourhood also are the palatial buildings of the ministries of justice and of agriculture. There are also the exchange (1905); the Austro-Hungarian bank (1904); the central post and telegraph office; the art-industrial museum (1893-1897), in oriental style, with some characteristically Hungarian ornamentations; several handsome theatres; large barracks; technical and secondary schools; two great railway termini and a central market (1897) to be mentioned. To the south-east of the town lies the vast slaughter-house (1870-1872), which, with the adjacent cattle-market, covers nearly 30 acres of ground. The building activity of Budapest since 1867 has been extraordinary, and the town has undergone a thorough transformation. The removal of slums and the regulation of the older parts of the town, in connexion with the construction of the two new bridges across the Danube and of the railway termini, went hand-in-hand with the extension of the town, new quarters springing up on both banks of the Danube. This process is still going on, and Budapest has become one of the handsomest capitals of Europe.

Education.—Budapest is the intellectual capital of Hungary. At the head of its educational institutions stands the university, which was attended in 1900 by 4983 students—only about 2000 in 1880—and has a staff of nearly 200 professors and lecturers. It has been completely transformed into a national Hungarian seat of learning since 1867, and great efforts have been made to keep at home the Hungarian students, who before then frequented other universities and specially that of Vienna. It is well provided with scientific laboratories, botanic garden, and various collections, and possesses a library with nearly a quarter of a million volumes. The university of Budapest, the only one in Hungary proper, was established at Tyrnau in 1635, removed to Buda in 1777, and transferred to Pest in 1783. Next to it comes the polytechnic, attended by 1816 students in 1900, which is also thoroughly equipped for a scientific training. Other high schools are a veterinary academy, a Roman Catholic seminary, a Protestant theological college, a rabbinical institute, a commercial academy, to which has been added in 1899 an academy for the study of oriental languages, and military academies for the training of Hungarian officers. Budapest possesses an adequate number of elementary and secondary schools, as well as a great number of special and technical schools. At the head of the scientific societies stands the academy of sciences, founded in 1825, for the encouragement of the study of the Hungarian language and the various sciences except theology. Next to it comes the national museum, founded in 1807 through the donations of Count Stephan Szechényi, which contains extensive collections of antiquities, natural history and ethnology, and a rich library which, in its manuscript department of over 20,000 MSS., contains the oldest specimens of the Hungarian language. Another society which has done great service for the cultivation of the Hungarian language is the Kisfaludy society, founded in 1836. It began by distributing prizes for the best literary productions of the year, then it started the collection and publication of the Hungarian folklore, and lastly undertook the translation into the Hungarian language of the masterpieces of foreign literatures. The influence exercised by this society is very great, and it has attracted within its circle the best writers of Hungary. Another society similar in aim with this one is the Petöfi society, founded in 1875. Amongst the numerous scientific associations are the central statistical department, and the Budapest communal bureau of statistics, which under the directorship of Dr Joseph de Körösy has gained a European reputation.

The artistic life in Budapest is fostered by the academy of music, which once had Franz Liszt as its director, a *conservatoire* of music, a dramatic school, and a school for painting and for drawing, all maintained by the government. Budapest possesses,

besides an opera house, eight theatres, of which two are subsidized by the government and one by the municipality. The performances are almost exclusively in Hungarian, the exceptions being the occasional appearance of French, Italian and other foreign artists. Performances in German are under a popular taboo, and they are never given in a theatre at Budapest.

Trade.—In commerce and industry Budapest is by far the most important town in Hungary, and in the former, if not also in the latter, it is second to Vienna alone in the Austro-Hungarian monarchy. The principal industries are steam flour-milling, distilling, and the manufacture of machinery, railway plant, carriages, cutlery, gold and silver wares, chemicals, bricks, jute, and the usual articles produced in large towns for home consumption. The trade of Budapest is mainly in corn, flour, cattle, horses, pigs, wines, spirits, wool, wood, hides, and in the articles manufactured in the town. The efforts of the Hungarian government to establish a great home industry, and the measures taken to that effect, have benefited Budapest to a greater degree than any other Hungarian town, and the progress made is remarkable. The increase in the number of joint-stock companies, and the capital thus invested in industrial undertakings, furnish a valuable indication. In 1873 there were 28 such companies with a total capital of £2,224,000; in 1890, 75 with a capital of £9,352,000; and in 1899 no fewer than 242 with a total capital of £31,378,655. Budapest owes its great commercial importance to its situation on the Danube, on which the greater part of its trade is carried. The introduction of steamboats on the Danube in 1830 was one of the earliest material causes of the progress of Budapest, and gave a great stimulus to its corn trade. This still continues to operate, having been promoted by the flour-milling industry, which was revolutionized by certain local inventions. Budapest is actually one of the greatest milling centres in the world, possessing a number of magnificent establishments, fitted with machinery invented and manufactured in the city. Budapest is, besides, connected with all the principal places in Austria and Hungary by a well-developed net of railways, which all radiate from here.

Population.—Few European towns grew so rapidly as Budapest generally, and Pest particularly, during the 19th century, and probably none has witnessed such a thorough transformation since 1867. In 1799 the joint population of Buda and Pest was 54,179, of which 24,306 belonged to Buda, and 29,870 belonged to Pest, being the first time that the population of Pest exceeded that of Buda. By 1840, however, Buda had added but 14,000 to its population, while that of Pest had more than doubled; and of the joint population of 270,685 in 1869, fully 200,000 fell to the share of Pest. In 1880 the civil population of Budapest was 360,551, an increase since 1869 of 32%; and in 1890 it was 401,938, an increase of 36.57% in the decade. In the matter of the increase of its population alone, Budapest has only been slightly surpassed by one European town, namely, Berlin. Both capitals multiplied their population by nine in the first nine decades of the century. According to an interesting and instructive comparison of the growth of twenty-eight European cities made by Dr Joseph de Körösy, Berlin in 1890 showed an increase, as compared with the beginning of the century, of 818% and Budapest of 809%. Within the same period the increase of Paris was 343%, and of London 340%. In 1900 the civil population of Budapest was 716,476 inhabitants, showing an increase of 44.82% in the decade. To this must be added a garrison of 15,846 men, making a total population of 732,322. Of the total population, civil and military, 578,458 were Magyars, 104,520 were Germans, 25,168 were Slovaks, and the remainder was composed of Croats, Servians, Rumanians, Russians, Greeks, Armenians, Gypsies, &c. According to religion, there were 445,023 Roman Catholics, 5806 Greek Catholics, 4422 Greek Orthodox; 67,319 were Protestants of the Helvetic, and 38,811 were Protestants of the Augsburg Confessions; 168,985 were Jews, and the remainder belonged to various other creeds. A striking feature in the progress of Budapest is the decline in the death-rate, which sank from 43.4 per thousand in 1874 to 20.6 per thousand in 1900. In addition to the increased influx of

persons in the prime of life, this is due largely to the improved water-supply and better sanitary conditions generally, including increased hospital accommodation.

Social Position.—Budapest is the seat of the government of Hungary, of the parliament, and of all the highest official authorities—civil, military, judicial and financial. It is the meeting-place, alternately with Vienna, of the Austro-Hungarian delegations, and it was elected to an equality with Vienna as a royal residence in 1892. It is the see of a Roman Catholic archbishop. The town is administered by an elected municipal council, which consists of 400 members. As Paris is sometimes said to be France, so may Budapest with almost greater truth be said to be Hungary. Its composite population is a faithful reflection of the heterogeneous elements in the dominions of the Habsburgs, while the trade and industry of Hungary are centralized at Budapest in a way that can scarcely be affirmed of any other European capital. In virtue of its cultural institutions, it is also the intellectual and artistic centre of Hungary. The movement in favour of Magyarizing all institutions has found its strongest development in Budapest, where the German names have all been removed from the buildings and streets. The wonderful progress of Budapest is undoubtedly due to the revival of the Hungarian national spirit in the first half of the 19th century, and to the energetic and systematic efforts of the government and people of Hungary since the restoration of the constitution. So far as Hungary was concerned, Budapest in 1867 at once became the favoured rival of Vienna, with the important additional advantage that it had no such competitors within its own sphere as Vienna had in the Austrian provincial capitals. The political, intellectual, and social life of Hungary was centred in Budapest, and had largely been so since 1848, when it became the seat of the legislature, as it was that of the Austrian central administration which followed the revolution. The ideal of a prosperous, brilliant and attractive Magyar capital, which would keep the nobles and the intellectual flower of the country at home, uniting them in the service of the Fatherland, had received a powerful impetus from Count Stephan Széchenyi, the great Hungarian reformer of the pre-revolutionary period. His work, continued by patriotic and able successors, was now taken up as the common task of the government and the nation. Thus the promotion of the interests of the capital and the centralization of the public and commercial life of the country have formed an integral part of the policy of the state since the restoration of the constitution. Budapest has profited largely by the encouragement of agriculture, trade and industry, by the nationalization of the railways, by the development of inland navigation, and also by the neglect of similar measures in favour of Vienna.

From that time to the present day the record of the Hungarian capital has been one of uninterrupted advance, not merely in externals, such as the removal of slums, the reconstruction of the town, the development of communications, industry and trade, and the erection of important public buildings, but also in the mental, moral and physical elevation of the inhabitants, besides another important gain from the point of view of the Hungarian statesman, namely, the progressive increase and improvement of status of the Magyar element of the population. When it is remembered that the ideal of both the authorities and the people is the ultimate monopoly of the home market by Hungarian industry and trade, and the strengthening of the Magyar influence by centralization, it is easy to understand the progress of Budapest.

Politically, this ambitious and progressive capital is the creation of the Magyar upper classes. Commercially and industrially, it may be said to be the work of the Jews. The sound judgment of the former led them to welcome and appreciate the co-operation of the latter. Indeed, a readiness to assimilate foreign elements is characteristic of Magyar patriotism, which has, particularly within the last generation, made numerous converts among the other nationalities of Hungary, and—for national purposes—may be considered to have quite absorbed the Hungarian Jews. It has thus come to pass that there is no

anti-Semitism in Budapest, although the Hebrew element is proportionately much larger (21% as compared with 9%) than it is in Vienna, the Mecca of the Jew-baiter.

Budapest has long been celebrated for its mineral springs and baths, some of them having been already used during the Roman period. They rise at the foot of the Blocksberg, and are powerful chalybeate and sulphureous hot springs, with a temperature of 80°–150° Fahr. The principal baths are the Bruckbad and the Kaiserbad, both dating from the Turkish period; the St Lucasbad; and the Raitzenbad, rebuilt in 1860, one of the most magnificent establishments of its kind, which was connected through a gallery with the royal palace in the time of Matthias Corvin. There is an artesian well of sulphureous water with a temperature of 153° Fahr. in the Stadtwaldchen; and another yielding sulphureous water with a temperature of 110° Fahr., which is used for both drinking and bathing, in the Margaret island. The mineral springs, which yield bitter alkaline waters, are situated in the plain south of the Blocksberg, and are over 40 in number. The principal are the Hunyadi-János spring of which about 1,000,000 bottles are exported annually, the Arpad spring, and the Apenta spring.

The largest and most popular of the parks in Budapest is the Városliget, on the north-east side of the town. It has an area of 286 acres, and contains the zoological garden. On an island in its large pond are situated the agricultural (1902–1904) and the ethnographical museums. It was in this park that the millennium exhibition of 1896 took place. A still more delightful resort is the Margaret island, a long narrow island in the Danube, the property of the archduke Joseph, which has been laid out in the style of an English park, with fine trees, velvety turf and a group of villas and bath-houses. The name of the island is derived from St Margaret, the daughter of King Bela IV. (13th century), who built here a convent, the ruins of which are still in existence. To the west of Buda extends the hill (1463 ft) of Sváb-Hegy (*Schwabenberg*), with extensive view and numerous villas; it is ascended by a rack-and-pinion railway. A favourite spot is the Zugliget (*Auswinkel*), a wooded dale on the northern slope of the hill. To the north of Ó-Buda, about 4 m. from the Margaret island, on the right bank of the Danube, are the remains of the Roman colony of Aquincum. They include the foundations of an amphitheatre, of a temple, of an aqueduct, of baths and of a castrum. The objects found here are preserved in a small museum. To the north of Pest lies the historic Rákóts field, where the Hungarian diets were held in the open air from the 10th to the 14th century; and 23 m. to the north lies the royal castle of Godólló, with its beautiful park.

History.—The history of Budapest consists of the separate history of the two sister towns, Buda and Pest. The Romans founded, in the 2nd century A.D., on the right bank of the Danube, on the site of the actual Ó-Buda, a colony, on the place of a former Celtic settlement. This colony was named Aquincum, a transformation from the former Celtic name of *Ak-inh*, meaning "rich waters." The Roman occupation lasted till A.D. 376, and then the place was invaded by Huns, Ostrogoths, and later by Avars and Slavs. When the Magyars came into the country, at the end of the 10th century, they preserved the names of Buda and Pest, which they found for these two places. The origin of Pest proper is obscure, but the name, apparently derived from the old Slavonic *pestj*, a stove (like *Ofen*, the German name of Buda), seems to point to an early Slavonic settlement. The Romans never gained a foothold on this side of the river.

When it first appears in history Pest was essentially a German settlement, and a chronicler of the 13th century describes it as "Villa Teutonica ditissima." Christianity was introduced only in the 11th century. In 1241 Pest was destroyed by the Tatars, after whose departure in 1244 it was created a royal free city by Bela IV., and repopulated with colonists of various nationalities. The succeeding period seems to have been one of considerable prosperity, though Pest was completely eclipsed by the sister town of Buda with its fortress and palace. This fortress and palace were built by King Bela IV. in 1247, and were the nucleus round which the town of Buda was built, which soon gained

great importance, and became in 1361 the capital of Hungary. In 1526 Pest was taken and pillaged by the Turks, and from 1541 to 1686 Buda was the seat of a Turkish pasha. Pest in the meantime entirely lost its importance, and on the departure of the Turks was left little more than a heap of ruins. Its favourable situation and the renewal of former privileges helped it to revive, and in 1723 it became the seat of the highest Hungarian officials. Maria Theresa and Joseph II. did much to increase its importance, but the rapid growth which enabled it completely to outstrip Buda belongs entirely to the 19th century. A signal proof of its vitality was given in 1838 by the speed and ease with which it recovered from a disastrous inundation that destroyed 3000 houses. In 1848 Pest became the seat of the revolutionary diet, but in the following year the insurgents had to retire before the Austrians under Windischgrätz. A little later the Austrians had to retire in their turn, leaving a garrison in the fortress of Buda, and, while the Hungarians endeavoured to capture this position, General Hentzi retaliated by bombarding Pest, doing great damage to the town. In 1872 both towns were united into one municipality. In 1896 took place here the millennium exhibition, in celebration of the thousandth anniversary of the foundation of the kingdom of Hungary.

BIBLIOGRAPHY.—The official publications of the Budapest Communal Bureau of Statistics have acquired a European repute for their completeness, and their fearless exposure of shortcomings has been an element in the progress of the town. Reference should also be made to separate works of the director of that institution, Dr Joseph de Kőrösy, known in England for his discovery of the law of marital fertility, published by the Royal Society, and by his labours in the development of comparative international statistics. His *Statistique Internationale des grandes villes* and *Bulletin annuel des finances des grandes villes* give valuable comparative data. See also *Die Österreichisch-Ungarische Monarchie in Wort und Bild* (Wien, 1886-1902, 24 vols.); volume xii., published in 1893, is devoted to Budapest. (O. Ba.)

BUDAUN, a town and district of British India, in the Rohilkhand division of the United Provinces. The town is near the left bank of the river Sot. Pop. (1901) 39,031. There are ruins of an immense fort and a very handsome mosque of imposing size, crowned with a dome, and built in 1223 in great part from the materials of an ancient Hindu temple. The American Methodist mission maintains several girls' schools, and there is a high school for boys. According to tradition Budaun was founded about A.D. 905, and an inscription, probably of the 12th century, gives a list of twelve Rathor kings reigning at Budaun (called Vodamaya). The first authentic historical event connected with it, however, is its capture by Kutb-ud-din in 1196, after which it became a very important post on the northern frontier of the Delhi empire. In the 13th century two of its governors, Shams-ud-din Altamsh, the builder of the great mosque referred to above, and his son Rukn-ud-din Firoz, attained the imperial throne. In 1571 the town was burnt, and about a hundred years later, under Shah Jahan, the seat of the governorship was transferred to Bareilly; after which the importance of Budaun declined. It ultimately came into the power of the Rohillas, and in 1838 was made the headquarters of a British district. In 1857 the people of Budaun sided with the mutineers, and a native government was set up, which lasted until General Penny's victory at Kakrala (April 1858) led to the restoration of British authority.

The DISTRICT OF BUDAUN has an area of 1987 sq. m. Pop. (1901) 1,025,753. The country is low, level, and is generally fertile, and watered by the Ganges, the Ramganga, the Sot or Yarwafadar, and the Mahawa. Budaun district was ceded to the British government in 1801 by the nawab of Oudh. There are several indigo factories. The district is crossed by two lines of the Oudh & Rohilkhand railway, and by a narrow-gauge line from Bareilly. The chief centre of trade is Bilsī.

BUDEUS, JOHANN FRANZ (1667-1729), German Lutheran divine, was born at Anklam, a town of Pomerania, where his father was pastor. He studied with great distinction at Greifswald and at Wittenberg, and having made a special study of languages, theology and history, was appointed professor of Greek and Latin at Coburg in 1692, professor of moral philosophy

in the university of Halle in 1693, and in 1705 professor of theology at Jena. Here he was held in high esteem, and in 1715 became Primarius of his faculty and member of the Consistory. His principal works are: *Leipzig, allgemeines historisches Lexikon* (Leipzig, 1709 ff.); *Historia Ecclesiastica Veteris Testamenti* (4 vols., Halle, 1709); *Elementa Philosophiæ Practicæ, Instrumentalis, et Theoreticæ* (3 vols., 1697); *Selecta Juris Naturæ et Gentium* (Halle, 1704); *Miscellanea Sacra* (3 vols., Jena, 1727); and *Isagoge Historico-Theologica ad Theologiam Universam, singulasque ejus partes* (2 vols., 1727).

BUDDHA. According to the Buddhist theory (see BUDDHISM), a "Buddha" appears from time to time in the world and preaches the true doctrine. After a certain lapse of time this teaching is corrupted and lost, and is not restored till a new Buddha appears. In Europe, Buddha is used to designate the last historical Buddha, whose family name was Gotama, and who was the son of Suddhōdana, one of the chiefs of the tribe of the Sākīyas, one of the republican clans then still existent in India.

We are accustomed to find the legendary and the miraculous gathering, like a halo, around the early history of religious leaders, until the sober truth runs the risk of being altogether neglected for the glittering and edifying falsehood. The Buddha has not escaped the fate which has befallen the founders of other religions; and as late as the year 1854 Professor Wilson of Oxford read a paper before the Royal Asiatic Society of London in which he maintained that the supposed life of Buddha was a myth, and "Buddha himself merely an imaginary being." No one, however, would now support this view; and it is admitted that, under the mass of miraculous tales which have been handed down regarding him, there is a basis of truth already sufficiently clear to render possible an intelligent history.

The circumstances under which the future Buddha has been born were somewhat as follows.¹ In the 6th century B.C. the Aryan tribes had long been settled far down the valley of the Ganges. The old child-like joy in life so manifest in the Vedas had died away; the worship of nature had developed or degenerated into the worship of new and less pure divinities; and the Vedic songs themselves, whose freedom was little compatible with the spirit of the age, had faded into an obscurity which did not lessen their value to the priests. The country was politically split up into little principalities, most of them governed by some petty despot, whose interests were not often the same as those of the community. There were still, however, about a dozen free republics, most of them with aristocratic government, and it was in these that reforming movements met with most approval and support. A convenient belief in the doctrine of the transmigrating of souls satisfied the unfortunate that their woes were the natural result of their own deeds in a former birth, and, though unavoidable now, might be escaped in a future state of existence by present good conduct. While hoping for a better fate in their next birth, the poor turned for succour and advice in this to the aid of astrology, witchcraft and animism—a belief in which seems to underlie all

¹ *Note on the Date of the Buddha.*—The now generally accepted date of the Buddha is arrived at by adding together two numbers, one being the date of the accession of Asoka to the throne, the second being the length of the interval between that date and that of the death of the Buddha. The first figure, that of the date of Asoka, is arrived at by the mention in one of his edicts of certain Greek kings, as then living. The dates of these last are approximately known; and arguing from these dates the date of Asoka's accession has been fixed by various scholars (at dates varying only by a difference of five years more or less) at about 270 B.C. The second figure, the total interval between Asoka's accession and the Buddha's death, is given in the Ceylon Chronicles as 218 years. Adding these two together, the date of the Buddha's death would be 488 B.C., and, as he was eighty years old at the time of his death, the date of his birth would be 568 B.C. The dates for his death and birth accepted in Burma, Siam and Ceylon are about half a century earlier, namely, 543 and 623 B.C., the difference being in the date of Asoka's accession. It will be seen that the dates as adopted in Europe are approximate only, and liable to correction if better data are obtainable. The details of this chronological question are discussed at length in Professor Rhys Davids' *Ancient Coins and Measures of Ceylon* (London, 1877), where the previous discussions are referred to.

religions, and still survives even in England.¹ The inspiring wars against the enemies of the Aryan people, the infidel deniers of the Aryan gods, had given place to a succession of internecine feuds between the chiefs of neighbouring clans. In literature an age of poets had long since made way for an age of commentators and grammarians, who thought that the old poems must have been the work of gods. But the darkest period was succeeded by the dawn of a reformation; travelling logicians were willing to maintain these against all the world; whilst here and there ascetics strove to raise themselves above the gods, and hermits earnestly sought for some satisfactory solution of the mysteries of life. These were the teachers whom the people chiefly delighted to honour. Though the ranks of the priesthood were for ever firmly closed against intruders, a man of lay birth, a Kshatriya or Vaisya, whose mind revolted against the orthodox creed, and whose heart was stirred by mingled zeal and ambition, might find through these irregular orders an entrance to the career of a religious teacher and reformer.

The Sākya clan was then seated in a tract of country probably two or three thousand square miles in extent, the chief town of which was Kapilavastu, situate about 27° 37' N. by 83° 11' E., some days' journey north of Benares. Their territory stretched up into the lower slopes of the mountains, and was mostly in what is now Nepal, but it included territory now on the British side of the frontier. It is in this part of the Sākya country that the interesting discovery was made of the monument they erected to their famous clansman. From their well-watered rice-fields, the main source of their wealth, they could see the giant Himalāyas looming up against the clear blue of the Indian sky. Their supplies of water were drawn from the river Rohini, the modern Kohāna; and though the use of the river was in times of drought the cause of disputes between the Sākya and the neighbouring Koliyans, the two clans were then at peace; and two daughters of a chieftain of Koli, which was only 11 m. east of Kapilavastu, were the principal wives of Suddhōdana. Both were childless, and great was the rejoicing when, in about the forty-fifth year of her age, the elder sister, Mahā Māyā, promised her husband a son. In due time she started with the intention of being confined at her parents' home, but the party halting on the way under the shade of some lofty satin-trees, in a pleasant garden called Lumbini on the river-side, her son, the future Buddha, was there unexpectedly born. The exact site of this garden has been recently rediscovered, marked by an inscribed pillar put up by Asoka (see *J.R.A.S.*, 1898).

He was in after years more generally known by his family name of Gotama, but his individual name was Siddhattha. When he was nineteen years old he was married to his cousin Yasodharā, daughter of a Koliyan chief, and gave himself up to a life of luxury. This is the solitary record of his youth; we hear nothing more till, in his twenty-ninth year, it is related that, driving to his pleasure-grounds one day, he was struck by the sight of a man utterly broken down by age, on another occasion by the sight of a man suffering from a loathsome disease, and some months after by the horrible sight of a decomposing corpse. Each time his charioteer, whose name was Channa, told him that such was the fate of all living beings. Soon after he saw an ascetic walking in a calm and dignified manner, and asking who that was, was told by his charioteer the character and aims of the Wanderers, the travelling teachers, who played so great a part in the intellectual life of the time. The different accounts of these visions vary so much as to cast great doubts on their accuracy; and the oldest one of all (*Anguttara*, i. 145) speaks of ideas only, not of actual visions. It is, however, clear from what follows, that about this time the mind of the young Rājput must, from some cause or other, have been deeply stirred. Many an earnest heart full of disappointment or enthusiasm has gone through a similar struggle, has learnt to look upon all earthly gains and hopes as worse than vanity, has envied the calm life of the cloister, troubled by none of these things, and has longed for an opportunity of entire self-surrender to abstinence and meditation.

¹ See report of *Rex. v. Newhaus*, Clerkenwell Sessions, September 15, 1906.

Subjectively, though not objectively, these visions may be supposed to have appeared to Gotama. After seeing the last of them, he is said, in the later accounts, to have spent the afternoon in his pleasure-grounds by the river-side; and having bathed, to have entered his chariot in order to return home. Just then a messenger arrived with the news that his wife Yasodharā had given birth to a son, his only child. "This," said Gotama quietly, "is a new and strong tie I shall have to break." But the people of Kapilavastu were greatly delighted at the birth of the young heir, the rāja's only grandson. Gotama's return became an ovation; musicians preceded and followed his chariot, while shouts of joy and triumph fell on his ear. Among these sounds one especially attracted his attention. It was the voice of a young girl, his cousin, who sang a stanza, saying, "Happy the father, happy the mother, happy the wife of such a son and husband." In the word "happy" lay a double meaning; it meant also freed from the chains of rebirth, delivered, saved. Grateful to one who, at such a time, reminded him of his highest hopes, Gotama, to whom such things had no longer any value, took off his collar of pearls and sent it to her. She imagined that this was the beginning of a courtship, and began to build day-dreams about becoming his principal wife, but he took no further notice of her and passed on. That evening the dancing-girls came to go through the Nāṭh dances, then as now so common on festive occasions in many parts of India; but he paid them no attention, and gradually fell into an uneasy slumber. At midnight he awoke; the dancing-girls were lying in the ante-room; an overpowering loathing filled his soul. He arose instantly with a mind fully made up—"roused into activity," says the Sinhalese chronicle, "like a man who is told that his house is on fire." He called out to know who was on guard, and finding it was his charioteer Channa, he told him to saddle his horse. While Channa was gone Siddhattha gently opened the door of the room where Yasodharā was sleeping, surrounded by flowers, with one hand on the head of their child. He had hoped to take the babe in his arms for the last time before he went, but now he stood for a few moments irresolute on the threshold looking at them. At last the fear of awakening Yasodharā prevailed; he tore himself away, promising himself to return to them as soon as his mind had become clear, as soon as he had become a Buddha,—i.e. Enlightened,—and then he could return to them not only as husband and father, but as teacher and saviour. It is said to have been broad moonlight on the full moon of the month of July, when the young chief, with Channa as his sole companion, leaving his father's home, his wealth and social position, his wife and child behind him, went out into the wilderness to become a penniless and despised student, and a homeless wanderer. This is the circumstance which has given its name to a Sanskrit work, the Mahābhinishkramana Sūtra, or Sūtra of the Great Renunciation.

Next is related an event in which we may again see a subjective experience given under the form of an objective reality. Māra, the great tempter, appears in the sky, and urges Gotama to stop, promising him, in seven days, a universal kingdom over the four great continents if he will but give up his enterprise.² When his words fail to have any effect, the tempter coaxes himself by the confident hope that he will still overcome his enemy, saying, "Sooner or later some lustful or malicious or angry thought must arise in his mind; in that moment I shall be his master"; and from that hour, adds the legend, "as a shadow always follows the body, so he too from that day always followed the Blessed One, striving to throw every obstacle in his way towards the Buddhahood." Gotama rides a long distance that night, only stopping at the banks of the Anosā beyond the Koliyan territory. There, on the sandy bank of the river, at a spot where later piety erected a diḡaba (a solid dome-shaped relic shrine), he cuts off with his sword his long flowing locks, and, taking off his ornaments, sends them and the horse back in charge of the unwilling Channa to Kapilavastu. The next seven days were spent alone in a grove of mango trees.

² The various legends of Māra are the subject of an exhaustive critical analysis in Windisch's *Māra and Buddha* (Leipzig, 1895).

near by, whence the recluse walks on to Rājagriha, the capital of Magadha, and residence of Bimbisāra, one of the then most powerful rulers in the valley of the Ganges. He was favourably received by the rāja; but though asked to do so, he would not as yet assume the responsibilities of a teacher. He attached himself first to a brahmin sophist named Ālāra, and afterwards to another named Udraka, from whom he learnt all that Indian philosophy had then to teach. Still unsatisfied, he next retired to the jungle of Uruvela, on the most northerly spur of the Vindhya range of mountains, and there for six years, attended by five faithful disciples, he gave himself up to the severest penance and self-torture, till his fame as an ascetic spread in all the country round about "like the sound," says the Burmese chronicle, "of a great bell hung in the canopy of the skies."¹ At last one day, when he was walking in a much enfeebled state, he felt on a sudden an extreme weakness, like that caused by dire starvation, and unable to stand any longer he fell to the ground. Some thought he was dead, but he recovered, and from that time took regular food and gave up his severe penance, so much so that his five disciples soon ceased to respect him, and leaving him went to Benares.

There now ensued a second struggle in Gotama's mind, described with all the wealth of poetry and imagination of which the Indian mind is master. The crisis culminated on a day, each event of which is surrounded in the Buddhist accounts with the wild legends, on which the very thoughts passing through the mind of Buddha appear in gorgeous descriptions as angels of darkness or of light. To us, now taught by the experiences of centuries how weak such exaggerations are compared with the effect of a plain unvarnished tale, these legends may appear childish or absurd, but they have a depth of meaning to those who strive to read between the lines of such rude and inarticulate attempts to describe the indescribable. That which (the previous and subsequent career of the teacher being borne in mind) seems to be possible and even probable, appears to be somewhat as follows.

Disenchanted and dissatisfied, Gotama had given up all that most men value, to seek peace in secluded study and self-denial. Failing to attain his object by learning the wisdom of others, and living the simple life of a student, he had devoted himself to that intense meditation and penance which all philosophers then said would raise men above the gods. Still unsatisfied, longing always for a certainty that seemed ever just beyond his grasp, he had added vigil to vigil, and penance to penance, until at last, when to the wondering view of others he had become more than a saint, his bodily strength and his indomitable resolution and faith had together suddenly and completely broken down. Then, when the sympathy of others would have been most welcome, he found his friends falling away from him, and his disciples leaving him for other teachers. Soon after, if not on the very day when his followers had left him, he wandered out towards the banks of the Neranjara, receiving his morning meal from the hands of Sujāta, the daughter of a neighbouring villager, and set himself down to eat it under the shade of a large tree (a *Ficus religiosa*), to be known from that time as the sacred Bo tree or tree of wisdom. There he remained through the long hours of that day debating with himself what next to do. All his old temptations came back upon him with renewed force. For years he had looked at all earthly good through the medium of a philosophy which taught him that it, without exception, contained within itself the seeds of bitterness, and was altogether worthless and impermanent; but now to his wavering faith the sweet delights of home and love, the charms of wealth and power, began to show themselves in a different light, and glow again with attractive colours. He doubted, and agonized in his doubt; but as the sun set, the religious side of his nature had won the victory, and seems to have come out even purified from the struggle. He had attained to Nirvāna, had become clear in his mind, a Buddha, an Enlightened One. From that night he not only did not claim any merit on account of his self-mortification, but took every opportunity of declaring that from such penances

¹ Bigandet, p. 49; and compare *Jātaka*, p. 67, line 27.

no advantage at all would be derived. All that night he is said to have remained in deep meditation under the Bo tree; and the orthodox Buddhists believe that for seven times seven nights and days he continued fasting near the spot, when the archangel Brahmā came and ministered to him. As for himself, his heart was now fixed,—his mind was made up,—but he realized more than he had ever done before the power of temptation, and the difficulty, the almost impossibility, of understanding and holding to the truth. For others subject to the same temptations, but without that earnestness and insight which he felt himself to possess, faith might be quite impossible, and it would only be waste of time and trouble to try to show to them "the only path of peace." To one in his position this thought would be so very natural, that we need not hesitate to accept the fact of its occurrence as related in the oldest records. It is quite consistent with his whole career that it was love and pity for others—otherwise, as it seemed to him, helplessly doomed and lost—which at last overcame every other consideration, and made Gotama resolve to announce his doctrine to the world.

The teacher, now 35 years of age, intended to proclaim his new gospel first to his old teachers Ālāra and Udraka, but finding that they were dead, he determined to address himself to his former five disciples, and accordingly went to the Deer-forest near Benares where they were then living. An old *gāthā*, or hymn (translated in *Vinaya Texts*, i. 90) tells us how the Buddha, rapt with the idea of his great mission, meets an acquaintance, one Upaka, a wandering sophist, on the way. The latter, struck with his expression, asks him whose religion it is that makes him so glad, and yet so calm. The reply is striking. "I am now on my way," says the Buddha, "to the city of Benares, to beat the drum of the Ambrosia (to set up the light of the doctrine of Nirvāna) in the darkness of the world!" and he proclaims himself the Buddha who alone knows, and knows no teacher. Upaka says: "You profess yourself, then, friend, to be an Arahāt and a conqueror?" The Buddha says: "Those indeed are conquerors who, as I have now, have conquered the intoxications (the mental intoxication arising from ignorance, sensuality or craving after future life). Evil dispositions have ceased in me; therefore is it that I am conqueror!" His acquaintance rejoins: "In that case, venerable Gotama, your way lies yonder!" and he himself, shaking, his head, turns in the opposite direction.

Nothing daunted, the new prophet walked on to Benares, and in the cool of the evening went on to the Deer-forest where the five ascetics were living. Seeing him coming, they resolved not to recognize as a superior one who had broken his vows; to address him by his name, and not as "master" or "teacher"; only, he being a Kshatriya, to offer him a seat. He understands their change of manner, calmly tells them not to mock him by calling him "the venerable Gotama"; that he has found the ambrosia of truth and can lead them to it. They object, naturally enough, from the ascetic point of view, that he had failed before while he was keeping his body under, and how can his mind have won the victory now, when he serves and yields to his body. Buddha replies by explaining to them the principles of his new gospel, in the form of noble truths, and the Noble Eightfold Path (see BUDDHISM).

It is nearly certain that Buddha had a commanding presence, and one of those deep, rich, thrilling voices which so many of the successful leaders of men have possessed. We know his deep earnestness, and his thorough conviction of the truth of his new gospel. When we further remember the relation which the five students mentioned above had long borne to him, and that they had passed through a similar culture, it is not difficult to understand that his persuasions were successful, and that his old disciples were the first to acknowledge him in his new character. The later books say that they were all converted at once; but, according to the most ancient Pāli record—though their old love and reverence had been so rekindled when the Buddha came near that their cold resolutions quite broke down, and they vied with each other in such acts of personal attention as an

Indian disciple loves to pay to his teacher,—yet it was only after the Buddha had for five days talked to them, sometimes separately, sometimes together, that they accepted in its entirety his plan of salvation.¹

The Buddha then remained at the Deer-forest near Benares until the number of his personal followers was about threescore, and that of the outside believers somewhat greater. The principal among the former was a rich young man named Yasa, who had first come to him at night out of fear of his relations, and afterwards shaved his head, put on the yellow robe, and succeeded in bringing many of his former friends and companions to the teacher, his mother and his wife being the first female disciples, and his father the first lay devotee. It should be noticed in passing that the idea of a priesthood with mystical powers is altogether repugnant to Buddhism; every one's salvation is entirely dependent on the modification or growth of his own inner nature, resulting from his own exertions. The life of a recluse is held to be the most conducive to that state of sweet serenity at which the more ardent disciples aim, but that of a layman, of a believing householder, is held in high honour; and a believer who does not as yet feel himself able or willing to cast off the ties of home or of business, may yet "enter the paths," and by a life of rectitude and kindness ensure for himself a rebirth under more favourable conditions for his growth in holiness.

After the rainy season Gotama called together those of his disciples who had devoted themselves to the higher life, and said to them: "I am freed from the five hindrances which, like an immense net, hold men and angels in their power; you too (owing to my teaching) are set free. Go ye now, brethren, and wander for the gain and welfare of the many, out of compassion for the world, to the benefit of gods and men. Preach the doctrine, beauteous in inception, beauteous in continuation, beauteous in its end. Proclaim the pure and perfect life. Let no two go together. I also go, brethren, to the General's village in the wilds of Uruvelā."² Throughout his career, Gotama yearly adopted the same plan, collecting his disciples round him in the rainy season, and after it was over travelling about as an itinerant preacher; but in subsequent years he was always accompanied by some of his most attached disciples.

In the solitudes of Uruvelā there were at this time three brothers, fire-worshippers and hermit philosophers, who had gathered round them a number of scholars, and enjoyed a considerable reputation as teachers. Gotama settled among them, and after a time they became believers in his system,—the elder brother, Kassapa, taking henceforth a principal place among his followers. His first set sermon to his new disciples is called by Bishop Bigandet the Sermon on the Mount. Its subject was a jungle-fire which broke out on the opposite hillside. He warned his hearers against the fires of concupiscence, anger, ignorance, birth, death, decay and anxiety; and taking each of the senses in order he compared all human sensations to a burning flame which seems to be something it is not, which produces pleasure and pain, but passes rapidly away, and ends only in destruction.³

Accompanied by his new disciples, the Buddha walked on to Rājagaha, the capital of King Bimbisāra, who, not unmindful of their former interview, came out to welcome him. Seeing Kassapa, who as the chronicle puts it, was as well known to them as the banner of the city, the people at first doubted who was the teacher and who the disciple, but Kassapa put an end to their hesitation by stating that he had now given up his belief in the efficacy of sacrifices either great or small; that Nirvāna was a state of rest to be attained only by a change of heart; and that he had become a disciple of the Buddha. Gotama then spoke to the king on the miseries of the world which arise from passion, and on the possibility of release by following the

¹ *Vinaya Texts*, i. 97-99; cf. *Jātaka*, vol. i. p. 82, lines 11-19.

² *Samyutta*, i. 105.

³ Cf. Big. p. 99, with Hardy, *M.B.* p. 101. The Pāli name is *aditta-pariyaya*; the sermon on the lessons to be drawn from burning. The text is *Vinaya*, i. 34 = *Samyutta*, iv. 19. A literal translation will be found in *Vinaya Texts*, l. 134, 135.

way of salvation. The rāja invited him and his disciples to eat their simple mid-day meal at his house on the following morning; and then presented the Buddha with a garden called Veluvāra or Bamboo-grove, afterwards celebrated as the place where the Buddha spent many rainy seasons, and preached many of his most complete discourses. There he taught for some time, attracting large numbers of hearers, among whom two, Śāriputta and Moggallāna, who afterwards became conspicuous leaders in the new crusade, then joined the Sangha or Society, as the Buddha's order of mendicants was called.

Meanwhile the prophet's father, Suddhōdana, who had anxiously watched his son's career, heard that he had given up his asceticism, and had appeared as a Wanderer, an itinerant preacher and teacher. He sent therefore to him, urging him to come home, that he might see him once more before he died. The Buddha accordingly started for Kapilavastu, and stopped according to his custom in a grove outside the town. His father and uncles and others came to see him there, but the latter were angry, and would pay him no reverence. It was the custom to invite such teachers and their disciples for the next day's meal, but they all left without doing so. The next day, therefore, Gotama set out at the usual hour, carrying his bowl to beg for a meal. As he entered the city, he hesitated whether he should not go straight to his father's house, but determined to adhere to his custom. It soon reached his father's ears that his son was walking through the streets begging. Startled at such news he rose up, seizing the end of his outer robe, and hastened to the place where Gotama was, exclaiming, "Illustrious Buddha, why do you expose us all to such shame? Is it necessary to go from door to door begging your food? Do you imagine that I am not able to supply the wants of so many mendicants?" "My noble father," was the reply, "this is the custom of all our race." "How so?" said his father. "Are you not descended from an illustrious line? no single person of our race has ever acted so indecorously." "My noble father," said Gotama, "you and your family may claim the privileges of Kshatriya descent; my descent is from the prophets (Buddhas) of old, and they have always acted so; the customs of the law (Dharma) are good both for this world and the world that is to come. But, my father, when a man has found a treasure, it is his duty to offer the most precious of the jewels to his father first. Do not delay, let me share with you the treasure I have found." Suddhōdana, abashed, took his son's bowl and led him to his house.

Eighteen months had now elapsed since the turning-point of Gotama's career—his great struggle under the Bo tree. Thus far all the accounts follow chronological order. From this time they simply narrate disconnected stories about the Buddha, or the persons with whom he was brought into contact,—the same story being usually found in more than one account, but not often in the same order. It is not as yet possible, except very partially, to arrange chronologically the snatches of biography to be gleaned from these stories. They are mostly told to show the occasion on which some memorable act of the Buddha took place, or some memorable saying was uttered, and are as exact as to place as they are indistinct as to time. It would be impossible within the limits of this article to give any large number of them, but space may be found for one or two.

A merchant from Sūnaparanta having joined the Society was desirous of preaching to his relations, and is said to have asked Gotama's permission to do so. "The people of Sūnaparanta," said the teacher, "are exceedingly violent. If they revile you what will you do?" "I will make no reply," said the mendicant. "And if they strike you?" "I will not strike in return," was the reply. "And if they try to kill you?" "Death is no evil in itself; many even desire it, to escape from the vanities of life, but I shall take no steps either to hasten or to delay the time of my departure." These answers were held satisfactory, and the monk started on his mission.

At another time a rich farmer held a harvest home, and the Buddha, wishing to preach to him, is said to have taken his alms-bowl and stood by the side of the field and begged. The farmer, a wealthy brāhmin, said to him, "Why do you come and beg?

I plough and sow and earn my food; you should do the same." "I too, O brahmin," said the beggar, "plough and sow; and having ploughed and sown I eat." "You profess only to be a farmer; no one sees your ploughing, what do you mean?" said the brahmin. "For my cultivation," said the beggar, "faith is the seed, self-combat is the fertilizing rain, the weeds I destroy are the cleaving to existence, wisdom is my plough, and its guiding-shaft is modesty; perseverance draws my plough, and I guide it with the rein of my mind; the field I work is in the law, and the harvest that I reap is the never-dying nectar of Nirvāna. Those who reap this harvest destroy all the weeds of sorrow."

On another occasion he is said to have brought back to her right mind a young mother whom sorrow had for a time deprived of reason. Her name was Kisāgotamī. She had been married early, as is the custom in the East, and had a child when she was still a girl. When the beautiful boy could run alone he died. The young girl in her love for it carried the dead child clasped to her bosom, and went from house to house of her pitying friends asking them to give her medicine for it. But a Buddhist convert thinking "she does not understand," said to her, "My good girl, I myself have no such medicine as you ask for, but I think I know of one who has." "Oh, tell me who that is?" said Kisāgotamī. "The Buddha can give you medicine; go to him," was the answer. She went to Gotama; and doing homage to him said, "Lord and master, do you know any medicine that will be good for my child?" "Yes, I know of some," said the teacher. Now it was the custom for patients or their friends to provide the herbs which the doctors required; so she asked what herbs he would want. "I want some mustard-seed," he said; and when the poor girl eagerly promised to bring some of so common a drug, he added, "you must get it from some house where no son, or husband, or parent or slave has died." "Very good," she said; and went to ask for it, still carrying her dead child with her. The people said, "Here is mustard-seed, take it"; but when she asked, "In my friend's house has any son died, or a husband, or a parent or slave?" They answered, "Lady! what is this that you say? the living are few, but the dead are many." Then she went to other houses, but one said "I have lost a son," another "We have lost our parents," another "I have lost my slave." At last, not being able to find a single house where no one had died, her mind began to clear, and summoning up resolution she left the dead body of her child in a forest, and returning to the Buddha paid him homage. He said to her, "Have you the mustard-seed?" "My lord," she replied, "I have not; the people tell me that the living are few, but the dead are many." Then he talked to her on that essential part of his system, the impermanency of all things, till her doubts were cleared away, she accepted her lot, became a disciple, and entered the "first path."

For forty-five years after entering on his mission Gotama itinerated in the valley of the Ganges, not going farther than about 250 m. from Benares, and always spending the rainy months at one spot—usually at one of the *vikāras*,¹ or homes, which had been given to the society. In the twentieth year his cousin Ānanda became a mendicant, and from that time seems to have attended on the Buddha, being constantly near him, and delighting to render him all the personal service which love and reverence could suggest. — Another cousin, Devadatta, the son of the rāja of Koli, also joined the society, but became envious of the teacher, and stirred up Ajatasattu (who, having killed his father Bimbisara, had become king of Rajagaha) to persecute Gotama. The account of the manner in which the Buddha is said to have overcome the wicked devices of this apostate cousin and his parricidal protector is quite legendary; but the general fact of Ajatasattu's opposition to the new sect and of his subsequent conversion may be accepted.

The confused and legendary notices of the journeyings of

¹ These were at first simple huts, built for the mendicants in some grove of palm-trees as a retreat during the rainy season; but they gradually increased in splendour and magnificence till the decay of Buddhism set in. See the authorities quoted in *Buddhist India*, pp. 141, 142.

Gotama are succeeded by tolerably clear accounts of the last few days of his life.² On a journey towards Kusinārā, a town about 120 m. north-north-east of Benares, and about 80 m. due east of Kapilavastu, the teacher, being then eighty years of age, had rested for a short time in a grove at Pāvā, presented to the society by a goldsmith of that place named Chunda. Chunda prepared for the mendicants a mid-day meal, and after the meal the Buddha started for Kusinārā. He had not gone far when he was obliged to rest, and soon afterwards he said, "Ānanda, I am thirsty," and they gave him water to drink. Half-way between the two towns flows the river Kukushtā. There Gotama rested again, and bathed for the last time. Feeling that he was dying, and careful lest Chunda should be reproached by himself or others, he said to Ānanda, "After I am gone tell Chunda that he will receive in a future birth very great reward; for, having eaten of the food he gave me, I am about to die; and if he should still doubt, say that it was from my own mouth that you heard this. There are two gifts which will be blest above all others, namely, Sujātā's gift before I attained wisdom under the Bo tree, and this gift of Chunda's before I pass away." After halting again and again the party at length reached the river Hiranyavati, close by Kusinārā, and there for the last time the teacher rested. Lying down under some Sal trees, with his face towards the south, he talked long and earnestly with Ānanda about his burial, and about certain rules which were to be observed by the society after his death. Towards the end of this conversation, when it was evening, Ānanda broke down and went aside to weep, but the Buddha missed him, and sending for him comforted him with the promise of Nirvāna, and repeated what he had so often said before about the impermanence of all things,—"O Ānanda! do not weep; do not let yourself be troubled. You know what I have said; sooner or later we must part from all we hold most dear. This body of ours contains within itself the power which renews its strength for a time, but also the causes which lead to its destruction. Is there anything put together which shall not dissolve? But you, too, shall be free from this delusion, this world of sense, this law of change. Beloved," added he, speaking to the rest of the disciples, "Ānanda for long years has served me with devoted affection." And he spoke to them at some length on the kindness of Ānanda.

About midnight Subhadra, a brahmin philosopher of Kusinārā, came to ask some questions of the Buddha, but Ānanda, fearing that this might lead to a longer discussion than the sick teacher could bear, would not admit him. Gotama heard the sound of their talk, and asking what it was, told them to let Subhadra come. The latter began by asking whether the six great teachers knew all laws, or whether there were some that they did not know, or knew only partially. "This is not the time," was the answer, "for such discussions. To true wisdom there is only one way, the path that is laid down in my system. Many have already followed it, and conquering the lust and pride and anger of their own hearts, have become free from ignorance and doubt and wrong belief, have entered the calm state of universal kindliness, and have reached Nirvāna even in this life. O Subhadra! I do not speak to you of things I have not experienced. Since I was twenty-nine years old till now I have striven after pure and perfect wisdom, and following the good path, have found Nirvāna." A rule had been made that no follower of a rival system should be admitted to the society without four months' probation. So deeply did the words or the impressive manner of the dying teacher work upon Subhadra that he asked to be admitted at once, and Gotama granted his request. Then turning to his disciples he said, "When I have passed away and am no longer with you, do not think that the Buddha has left you, and is not still in your midst. You have my words, my explanations of the deep things of truth, the laws I have laid down for the society; let them be your guide; the Buddha has not left you." Soon afterwards he again spoke to them, urging them to reverence one another, and rebuked one of the disciples who spoke

² The text of the account of this last journey is the *Mahāparinibbāna Suttanta*, vol. ii. of the *Digha* (ed. Rhys Davids and Carpenter). The translation is in Rhys Davids' *Buddhist Suttas*.

indiscriminately all that occurred to him. Towards the morning he asked whether any one had any doubt about the Buddha, the law or the society; if so, he would clear them up. No one answered, and Ananda expressed his surprise that amongst so many none should doubt, and all be firmly attached to the law. But the Buddha laid stress on the final perseverance of the saints, saying that even the least among the disciples who had entered the first path only, still had his heart fixed on the way to perfection, and constantly strove after the three higher paths. "No doubt," he said, "can be found in the mind of a true disciple." After another pause he said: "Behold now, brethren, this is my exhortation to you. Decay is inherent in all component things. Work out, therefore, your emancipation with diligence!" These were the last words the Buddha spoke; shortly afterwards he became unconscious, and in that state passed away.

AUTHORITIES ON THE LIFE OF THE BUDDHA.—Canonical Pāli (reached their present shape before the 4th century B.C.); episodes only, three of them long: (1) *Birth*; text in *Majjhima Nikāya*, ed. Trencikner and Chalmers (London, Pāli Text Society, 1888-1899), vol. iii, pp. 118-124; also in *Anguttara Nikāya*, ed. Morris and Hardy (Pāli Text Society, 1888-1900), vol. ii, pp. 130-132. (2) *Adoration of the babe*; old ballad; text in *Sutta Nipāta*, ed. Fausbøll (Pāli Text Society, 1884), pp. 128-131; translation by the same in *Sacred Books of the East* (Oxford, 1881), vol. x, pp. 124-131. (3) *Youth at home*; text in *Anguttara Nikāya*, i. 145. (4) *The going forth*; old ballad; text in *Sutta Nipāta*, pp. 70-74 (London, 1896), pp. 99-101; prose account in *Dīgha Nikāya*, ed. Rhys Davids and Carpenter (Pāli Text Society, 1890-1893), vol. i, p. 115, translated by Rhys Davids in *Dialogues of the Buddha* (Oxford, 1899), pp. 147-149. (5) *First long episode*; the going forth, years of study and penance, attainment of Nirvāna and Buddhahood, and conversion of first five converts; text in *Majjhima*, all together at i. 93; parts repeated at i. 163-175, 240-249; ii. 212; *Vinaya*, ed. Oldenberg (London, 1879-1883), vol. i, pp. 1-13. (6) *Second long episode*; from the conversation of the five down to the end of the first year of the teaching; text in *Vinaya*, i. 13-44, translated by Oldenberg in *Vinaya Texts*, i. 73-151. (7) *Visit to Kapilavastu*; text in *Vinaya*, i. 82; translation by Oldenberg in *Vinaya Texts* (Oxford, 1881-1885), vol. i, pp. 207-210. (8) *Third long episode*; the last days; text in *Dīgha Nikāya* (the *Mahāparinibbāna Suttanta*), vol. ii, pp. 72-168, translated by Rhys Davids in *Buddhist Suttas* (Oxford, 1881), pp. 1-136. **Buddhist Sanskrit Texts:** (1) *Mahāvastu* (probably 2d century B.C.); edited by Senart (3 vols., Paris, 1882-1897), summary in French prefixed to each volume; down to the end of first year of the teaching. (2) *Lalitā Vistara* (probably 1st century B.C.); edited by Mitra (Calcutta, 1877); translated into French by Foucaux (Paris, 1884); down to the first sermon. (3) *Buddha Carita*, by Aśvaghoṣa, probably 2d century A.D. edited by Cowell (Oxford, 1892); translated by Cowell (Oxford, 1894, S.B.E. vol. xix.); an elegant poem; stops just before the attainment of Buddhahood. (These three works reproduce and amplify the above episodes Nos. 1-6; they retain here and there a very old tradition as to arrangement of clauses or turns of expression.) Later Pāli: The commentary on the *Jāta*, written probably in the 5th century A.D., gives a consecutive narrative, from the birth to the end of the second year of the teaching, based on the canonical texts, but much altered and amplified; edited by Fausbøll in *Jāta*, vol. i. (London, 1877), pp. 1-94; translated by Rhys Davids in *Buddhist Birth Stories* (London, 1880), pp. 1-133. **Modern Works:** (1) Tibetan: *Life of the Buddha*; episodes collected and translated by W. Woodville Rockhill (London, 1884), from Tibetan texts of the 9th and 10th centuries A.D. (2) Sinhalese: episodes collected and translated by Spence Hardy from Sinhalese texts of the 12th and later centuries, in *Manual of Buddhism* (London, 1897, 2d edition), pp. 138-359. (3) Burmese: *The Life or Legend of Gaudama* (3rd edition, London, 1880), by the Right Rev. P. Bigandet, translated from a Burmese work of A.D. 1773. (The Burmese is, in its turn, a translation from a Pāli work of unknown date; it gives the whole life, and is the only consecutive biography we have.) (4) *Kambojan: Pathama Sambodhina*; translated into French by A. Leclère in *Œuvres sacrées du Cambodge* (Paris, 1906). (T. W. R. D.)

BUDDHAGHOSA, a celebrated Buddhist writer. He was a Brahmin by birth and was born near the great Bodhi tree at Budh Gayā in north India about A.D. 390, his father's name being Kesī. His teacher, Revata, induced him to go to Ceylon, where the commentaries on the scriptures had been preserved in the Sinhalese language, with the object of translating them into Pāli. He went accordingly to Anurādhapura, studied there under Saṅghapāla, and asked leave of the fraternity there to translate the commentaries. With their consent he then did so, having first shown his ability by writing the work *Viśuddhi Magga* (the Path of Purity, a kind of summary of Buddhist doctrine). When he had completed his many years' labours he returned to

the neighbourhood of the Bodhi tree in north India. Before he came to Ceylon he had already written a book entitled *Nānodaya* (the Rise of Knowledge), and had commenced a commentary on the principal psychological manual contained in the *Piṭakas*. This latter work he afterwards rewrote in Ceylon, as the present text (now published by the Pāli Text Society) shows. One volume of the *Samangala Vildāsi* (a portion of the commentaries mentioned above) has been edited, and extracts from his comment on the Buddhist canon law. This last work has been discovered in a nearly contemporaneous Chinese translation (an edition in Pāli is based on a comparison with that translation). The works here mentioned form, however, only a small portion of what Buddhaghosa wrote. His industry must have been prodigious. He is known to have written books that would fill about 20 octavo volumes of about 400 pages each; and there are other writings ascribed to him which may or may not be really his work. It is too early therefore to attempt a criticism of it. But it is already clear that, when made acceptable, it will be of the greatest value for the history of Indian literature and of Indian ideas. So much is uncertain at present in that history for want of definite dates that the voluminous writings of an author whose date is approximately certain will afford a standard by which the age of other writings can be tested. And as the original commentaries in Sinhalese are now lost his works are the only evidence we have of the traditions then handed down in the Buddhist community. The main source of our information about Buddhaghosa is the *Mahāvamsa*, written in Anurādhapura about fifty years after he was working there. But there are numerous references to him in Pāli books on Pāli literature; and a Burmese author of unknown date, but possibly of the 15th century, has compiled a biography of him, the *Buddhaghos' Uppatti*, of little value and no critical judgment.

See *Mahāvamsa*, ch. xxxvii. (ed. Turnour, Colombo, 1837); "Gandhavarāma," p. 59, in *Journal of the Pāli Text Society* (1886); *Buddhaghosupatti* (text and translation, ed. by E. Gray, London, 1893); *Samangala Vildāsi*, edited by T. W. Rhys Davids and J. E. Carpenter, vol. i. (London, Pāli Text Society, 1886). (T. W. R. D.)

BUDDHISM, the religion held by the followers of the Buddha (*q.v.*), and covering a large area in India and east and central Asia.

Essential Doctrines.—We are fortunate in having preserved for us the official report of the Buddha's discourse, in which he expounded what he considered the main features of his system to the five men he first tried to win over to his new-found faith. There is no reason to doubt its substantial accuracy, not as to words, but as to purport. In any case it is what the compilers of the oldest extant documents believed their teacher to have regarded as the most important points in his teaching. Such a summary must be better than any that could now be made. It is incorporated into two divisions of their sacred books, first among the *suttas* containing the doctrine, and again in the rules of the society or order he founded (*Samyutta*, v. 421 = *Vinaya*, i. 10). The gist of it, omitting a few repetitions, is as follows:—

"There are two aims which he who has given up the world ought not to follow after—devotion, on the one hand, to those things whose attractions depend upon the passions, a low and vulgar ideal fit only for the worldly-minded, ignoble, unprofitable, and the practice on the other hand of asceticism, which is painful, ignoble, unprofitable. There is a Middle Path discovered by the Tathāgata—a path which opens the eyes, and bestows understanding, which leads to peace, to insight, to the higher wisdom, to Nirvāna. Verily: it is this Noble Eightfold Path; that is to say, Right Views, Right Aspirations, Right Speech, Right Conduct, Right Mode of Livelihood, Right Effort, Right Mindfulness, and Right Rapture.

"Now this is the Noble Truth as to suffering. Birth is attended with pain, decay is painful, disease is painful, death is painful. Union with the unpleasant is painful, painful is separation from the pleasant; and any craving unsatisfied, that too is painful. In brief, the five aggregates of clinging (that is, the conditions of individuality) are painful.

"Now this is the Noble Truth as to the origin of suffering. Verily: it is the craving thirst that causes the renewal of becoming, that is accompanied by sensual delights, and seeks satisfaction now here, now there—that is to say, the craving for the gratification of the senses, or the craving for a future life, or the craving for prosperity.

"That is by the Arahant, the title the Buddha always uses of himself. He does not call himself the Buddha, and his followers never address him as such.

"Now this is the Noble Truth as to the passing away of pain. Verily! it is the passing away so that no passion remains, the giving up, the getting rid of, the being emancipated from, the harbouring no longer of this craving thirst.

"Now this is the Noble Truth as to the way that leads to the passing away of pain. Verily! it is this Noble Eightfold Path, that is to say, Right Views, Right Aspirations, Right speech, conduct and mode of livelihood, Right Effort, Right Mindfulness and Right Rapture."

A few words follow as to the threefold way in which the speaker claimed to have grasped each of these Four Truths. That is all. There is not a word about God or the soul, not a word about the Buddha or Buddhism. It seems simple, almost jejune; so thin and weak that one wonders how it can have formed the foundation for a system so mighty in its historical results. But the simple words are pregnant with meaning. Their implications were clear enough to the hearers to whom they were addressed. They were not intended, however, to answer the questionings of a 20th-century European questioner, and are liable now to be misunderstood. Fortunately each word, each clause, each idea in the discourse is repeated, commented on, enlarged upon, almost *ad nauseam*, in the *suttas*, and a short comment in the light of those explanations may bring out the meaning that was meant.¹

The passing away of pain or suffering is said to depend on an emancipation. And the Buddha is elsewhere (*Vinaya* ii. 239) made to declare: "Just as the great ocean has one taste only, the taste of salt, just so have this doctrine and discipline but one flavour only, the flavour of emancipation"; and again, "When a brother has, by himself, known and realized, and continues to abide, here in this visible world, in that emancipation of mind, in that emancipation of heart, which is Arahatsip; that is a condition higher still and sweeter still, for the sake of which the brethren lead the religious life under me."² The emancipation is found in a habit of mind, in the being free from a specified sort of craving that is said to be the origin of certain specified sorts of pain. In some European books this is completely spoiled by being represented as the doctrine that existence is misery, and that desire is to be suppressed. Nothing of the kind is said in the text. The description of suffering or pain is, in fact, a string of truisms, quite plain and indisputable until the last clause. That clause declares that the *Upādāna Skandhas*, the five groups of the constituent parts of every individual, involve pain. Put into modern language this is that the conditions necessary to make an individual are also the conditions that necessarily give rise to sorrow. No sooner has an individual become separate, become an individual, than disease and decay begin to act upon it. Individuality involves limitation, limitation in its turn involves ignorance, and ignorance is the source of sorrow. Union with the unpleasant, separation from the pleasant, unsatisfied craving, are each a result of individuality. This is a deeper generalization than that which says, "A man is born to trouble as the sparks fly upward." But it is put forward as a mere statement of fact. And the previous history of religious belief in India would tend to show that emphasis was laid on the fact, less as an explanation of the origin of evil, than as a protest against a then current pessimistic idea that salvation could not be reached on earth, and must therefore be sought for in a rebirth in heaven, in the *Brahmaloka*. For if the fact—the fact that the conditions of individuality are the conditions, also, of pain—were admitted, then the individual there would still not have escaped from sorrow. If the five ascetics to whom the words were addressed once admitted this implication, logic would drive them also to admit all that followed.

The threefold division of craving at the end of the second truth might be rendered "the lust of the flesh, the lust of life and the love of this present world." The two last are said elsewhere to be directed against two sets of thinkers called the Eternalists and the Annihilationists, who held respectively

¹ One very ancient commentary on the Path has been preserved in three places in the canon: *Dīgha*, ii. 305-307 and 311-313; *Majjhima*, iii. 251, and *Samyutta*, v. 8.
² *Mahāvī Sūtas*; translated in Rhys Davids' *Dialogues of the Buddha*, vol. i. p. 201 (cf. p. 204).

the everlasting-life-heresy and the let-us-eat-and-drink-for-tomorrow-we-die-heresy.³ This may be so, but in any case the division of craving would have appealed to the five hearers as correct.

The word translated "noble" in Noble Path, Noble Truth, is *ariya*, which also means Aryan.⁴ The negative, un-Aryan, is used of each of the two low aims. It is possible that this rendering should have been introduced into the translation; but the ethical meaning, though still associated with the tribal meaning, had probably already become predominant in the language of the time.

The details of the Path include several terms whose meaning and implication are by no means apparent at first sight. Right Views, for instance, means mainly right views as to the Four Truths and the Three Signs. Of the latter, one is identical, or nearly so, with the First Truth. The others are Impermanence and Non-soul (the absence of a soul)—both declared to be "signs" of every individual, whether god, animal or man. Of these two again the Impermanence has become an Indian rather than a Buddhist idea, and we are to a certain extent familiar with it also in the West. There is no Being, there is only a Becoming. The state of every individual is unstable, temporary, sure to pass away. Even in the lowest class of things, we find, in each individual, form and material qualities. In the higher classes there is a continually rising series of mental qualities also. It is the union of these that makes the individual. Every person, or thing, or god, is therefore a putting together, a compound; and in each individual, without any exception, the relation of its component parts is ever changing, is never the same for two consecutive moments. It follows that no sooner has separateness, individuality, begun, than dissolution, disintegration, also begins. There can be no individuality without a putting together: there can be no putting together without a becoming: there can be no becoming without a becoming different: and there can be no becoming different without a dissolution, a passing away, which sooner or later will inevitably be complete.

Heraclitus, who was a generation or two later than the Buddha, had very similar ideas;⁵ and similar ideas are found in post-Buddhist Indian works.⁶ But in neither case are they worked out in the same uncompromising way. Both in Europe, and in all Indian thought except the Buddhist, souls, and the gods who are made in imitation of souls are considered as exceptions. To these spirits is attributed a Being without Becoming, an individuality without change, a beginning without an end. To hold any such view would, according to the doctrine of the Noble (or Aryan) Path, be erroneous, and the error would block the way against the very entrance on the Path.

So important is this position in Buddhism that it is put in the forefront of Buddhist expositions of Buddhism. The Buddha himself is stated in the books to have devoted to it the very first discourse he addressed to the first converts.⁷ The first in the collection of the *Dialogues of Gotama* discusses, and completely, categorically, and systematically rejects, all the current theories about "souls." Later books follow these precedents. Thus the *Kathā Vālluh*, the latest book included in the canon, discusses points of disagreement that had arisen in the community. It places this question of "soul" at the head of all the points it deals with, and devotes to it an amount of space quite overshadowing all the rest.⁸ So also in the earliest Buddhist book later than the canon—the very interesting and suggestive series of conversations between the Greek king Menander and the Buddhist teacher Nāgasena. It is precisely this question of the "soul" that the unknown author takes up first, describing how Nāgasena convinces the king that there is no such thing as the

³ See *Iti-vuttaka*, p. 44; *Samyutta*, iii. 57.

⁴ See *Dīgha*, ii. 28; *Jāt.* v. 48, ii. 80.

⁵ Burnett, *Early Greek Philosophy*, p. 149.

⁶ *Kathā Up.* 2, 10; *Bhag. Gītā*, 2, 14; 9, 33.

⁷ The *Anatta-lakkhana Sutta* (*Vinaya*, i. 13 = *Samyutta*, iii. 66 and iv. 34); translated in *Vinaya Texts*, i. 100-102.

⁸ See article on "Buddhist Schools of Thought," by Rhys Davids, in the *J.R.A.S.* for 1892.

"soul" in the ordinary sense, and he returns to the subject again and again.¹

After Right Views come Right Aspirations. It is evil desires, low ideals, useless cravings, idle excitements, that are to be suppressed by the cultivation of the opposite—of right desires, lofty aspirations. In one of the Dialogues² instances are given—the desire for emancipation from sensuality, aspirations towards the attainment of love to others, the wish not to injure any living thing, the desire for the eradication of wrong and for the promotion of right dispositions in one's own heart, and so on. This portion of the Path is indeed quite simple, and would require no commentary were it not for the still constantly repeated blunder that Buddhism teaches the suppression of all desire.

Of the remaining stages of the Path it is only necessary to mention two. The one is Right Effort. A constant intellectual alertness is required. This is not only insisted upon elsewhere in countless passages; but of the three cardinal sins in Buddhism (*vāga, dosa, moha*) the last and worst is stupidity or dullness, the others being sensuality and ill-will. Right Effort is closely connected with the seventh stage, Right Mindfulness. Two of the dialogues are devoted to this subject, and it is constantly referred to elsewhere.³ The disciple, whatsoever he does—whether going forth or coming back, standing or walking, speaking or silent, eating or drinking—is to keep clearly in mind all that it means, the temporary character of the act, its ethical significance, and above all that behind the act there is no actor (goer, seer, eater, speaker) that is an eternally persistent unity. It is the Buddhist analogue to the Christian precept: "Whether therefore ye eat or drink, or whatsoever ye do, do all to the glory of God."

Under the head of Right Conduct the two most important points are Love and Joy. Love is in Pāli *Metta*, and the *Metta Sutta*⁴ says (no doubt with reference to the Right Mindfulness just described): "As a mother, even at the risk of her own life, protects her son, her only son, so let him cultivate love without measure towards all beings. Let him cultivate towards the whole world—above, below, around—a heart of love unstinted, unmixed with the sense of differing or opposing interests. Let a man maintain this mindfulness all the while he is awake, whether he be standing, walking, sitting or lying down. This state of heart is the best in the world."⁵

Often elsewhere four such states are described, the Brahma Vihāras or Sublime Conditions. They are Love, Sorrow at the sorrows of others, Joy in the joys of others, and Equanimity as regards one's own joys and sorrows.⁶ Each of these feelings was to be deliberately practised, beginning with a single object, and gradually increasing till the whole world was suffused with the feeling. "Our mind shall not waver. No evil speech will we utter. Tender and compassionate will we abide, loving in heart, void of malice within. And we will be ever suffusing such a one with the rays of our loving thought. And with that feeling as a basis we will ever be suffusing the whole wide world with thought of love far-reaching, grown great, beyond measure, void of anger or ill-will."⁷

The relative importance of love, as compared with other habits, is thus described. "All the means that can be used as bases for doing right are not worth the sixteenth part of the emancipation of the heart through love. That takes all those up into itself, outshining them in radiance and glory. Just as whatsoever stars there be their radiance avails not the sixteenth part of the radiance of the moon. That takes all those up into itself, outshining them in radiance and glory—just as in the last month of the rains, at harvest time, the sun, mounting up on high into the clear and cloudless sky, overwhelms all darkness in the highs

of space, and shines forth in radiance and glory—just as in the night, when the dawn is breaking, the morning star shines out in radiance and glory—just so all the means that can be used as helps towards doing right avail not the sixteenth part of the emancipation of the heart through love."⁸

The above is the positive side; the qualities (*dhammas*) that have to be acquired. The negative side, the qualities that have to be suppressed by the cultivation of the opposite virtues, are the Ten Bonds (*Samyojanas*), the Four Intoxications (*Āsava*) and the Five Hindrances (*Nivaraṇas*).

The Ten Bonds are: (1) Delusion about the soul; (2) Doubt; (3) Dependence on good works; (4) Sensuality; (5) Hatred, ill-feeling; (6) Love of life on earth; (7) Desire for life in heaven; (8) Pride; (9) Self-righteousness; (10) Ignorance. The Four Intoxications are the mental intoxication arising respectively from (1) Bodily passions, (2) Becoming, (3) Delusion, (4) Ignorance. The Five Hindrances are (1) Hankering after worldly advantages, (2) The corruption arising out of the wish to injure, (3) Torpor of mind, (4) Fretfulness and worry, (5) Wavering of mind.⁹ "When these five hindrances have been cut away from within him, he looks upon himself as freed from debt, rid of disease, out of jail, a free man and secure. And gladness springs up within him on his realizing that, and joy arises to him thus gladdened, and so rejoicing all his frame becomes at ease, and being thus at ease he is filled with a sense of peace, and in that peace his heart is stayed."¹⁰

To have realized the Truths, and traversed the Path; to have broken the Bonds, put an end to the Intoxications, and got rid of the Hindrances, is to have attained the ideal, the Fruit, as it is called, of Arāhatsip. One might fill columns with the praises, many of them among the most beautiful passages in Pāli poetry and prose, lavished on this condition of mind, the state of the man made perfect according to the Buddhist faith. Many are the pet names, the poetic epithets bestowed upon it—the harbour of refuge, the cool cave, the island amidst the floods, the place of bliss, emancipation, liberation, safety, the supreme, the transcendent, the uncreated, the tranquil, the home of peace, the calm, the end of suffering, the medicine for all evil, the unshaken, the ambrosia, the immaterial, the imperishable, the abiding, the farther shore, the unending, the bliss of effort, the supreme joy, the ineffable, the detachment, the holy city, and many others. Perhaps the most frequent in the Buddhist text is Arāhatsip, "the state of him who is worthy"; and the one exclusively used in Europe is Nirvāna, the "dying out"; that is, the dying out in the heart of the fell fire of the three cardinal sins—sensuality, ill-will and stupidity.¹¹

The choice of this term by European writers, a choice made long before any of the Buddhist canonical texts had been published or translated, has had a most unfortunate result. Those writers did not share, could not be expected to share, the exuberant optimism of the early Buddhists. Themselves giving up this world as hopeless, and looking for salvation in the next, they naturally thought the Buddhists must do the same, and in the absence of any authentic scriptures, to correct the mistake, they interpreted Nirvāna, in terms of their own belief, as a state to be reached after death. As such they supposed the "dying out" must mean the dying out of a "soul"; and endless were the discussions as to whether this meant eternal trance, or absolute annihilation, of the "soul." It is now thirty years since the right interpretation, founded on the canonical texts, has been given, but outside the ranks of Pāli scholars the old blunder is still often repeated. It should be added that the belief in salvation in this world, in this life, has appealed so strongly to Indian sympathies that from the time of the rise of Buddhism down to the present day it has been adopted as a part of general Indian belief, and *Jivanmukti*, salvation during this life, has become a commonplace in the religious language of India.

Adopted Doctrines.—The above are the essential doctrines of

¹ *Questions of King Milinda*, translated by Rhys Davids (Oxford, 1890-1894), vol. i. pp. 40, 41, 85-87; vol. ii. pp. 21-25, 86-89.

² *Majjhima*, iii. 251, cf. *Samyutta*, v. 8.

³ *Digha*, ii. 290-315. *Majjhima*, i. 55 et seq. Cf. Rhys Davids' *Dialogues of the Buddha*, i. 81.

⁴ No. 8 in the *Sutta Nipata* (p. 26 of Fausbøll's edition). It is translated by Fausbøll in vol. x. of the *S.B.E.*, and by Rhys Davids, *Buddhism*, p. 100.

⁵ *Digha*, ii. 186-187.

⁶ *Majjhima*, i. 129.

⁷ *Iti-vuttaka*, pp. 19-21.

⁸ On the details of these see *Digha*, i. 71-73, translated by Rhys Davids in *Dialogues of the Buddha*, i. 82-84.

⁹ *Digha*, i. 74.

¹⁰ *Samyutta*, iv. 251, 261.

the original Buddhism. They are at the same time its distinctive doctrines; that is to say, the doctrines that distinguish it from all previous teaching in India. But the Buddha, while rejecting the sacrifices and the ritualistic magic of the brahmin schools, the animistic superstitions of the people, the asceticism and soul-theory of the Jains, and the pantheistic speculations of the poets of the pre-Buddhistic *Upanishads*, still retained the belief in transmigration. This belief—the transmigration of the soul, after the death of the body, into other bodies, either of men, beasts or gods—is part of the animistic creed so widely found throughout the world that it was probably universal. In India it had already, before the rise of Buddhism, been raised into an ethical conception by the associated doctrine of *Karma*, according to which a man's social position in life and his physical advantages, or the reverse, were the result of his actions in a previous birth. The doctrine thus afforded an explanation, quite complete to those who believed it, of the apparent anomalies and wrongs in the distribution here of happiness or woe. A man, for instance, is blind. This is owing to his lust of the eye in a previous birth. But he has also unusual powers of hearing. This is because he loved, in a previous birth, to listen to the preaching of the law. The explanation could always be exact, for it was scarcely more than a repetition of the point to be explained. It fits the facts because it is derived from them. And it cannot be disproved, for it lies in a sphere beyond the reach of human inquiry.

It was because it thus provided a moral cause that it was retained in Buddhism. But as the Buddha did not acknowledge a soul, the link of connexion between one life and the next had to be found somewhere else. The Buddha found it (as Plato also found it)¹ in the influence exercised upon one life by a desire felt in the previous life. When two thinkers of such eminence (probably the two greatest ethical thinkers of antiquity) have arrived independently at this strange conclusion, have agreed in ascribing to cravings, felt in this life, so great, and to us so inconceivable, a power over the future life, we may well hesitate before we condemn the idea as intrinsically absurd, and we may take note of the important fact that, given similar conditions, similar stages in the development of religious belief, men's thoughts, even in spite of the most unquestioned individual originality, tend though they may never produce exactly the same results, to work in similar ways.

In India, before Buddhism, conflicting and contradictory views prevailed as to the precise mode of action of *Karma*; and we find this confusion reflected in Buddhist theory. The prevailing views are tacked on, as it were, to the essential doctrines of Buddhism, without being thoroughly assimilated to them, or logically incorporated with them. Thus in the story of the good layman Citta, it is an aspiration expressed on the death-bed;² in the dialogue on the subject, it is a thought dwelt on during life;³ in the numerous stories in the *Peta* and *Vimāna Vatthus* it is usually some isolated act, in the discussions in the *Dhamma Saṅgami* it is some mental disposition, which is the *Karma* (doing or action) in the one life determining the position of the individual in the next. These are really conflicting propositions. They are only alike in the fact that in each case a moral cause is given for the position in which the individual finds himself now; and the moral cause is his own act.

In the popular belief, followed also in the brahmin theology, the bridge between the two lives was a minute and subtle entity called the soul, which left the one body at death, through a hole at the top of the head, and entered into the new body. The new body happened to be there, ready, with no soul in it. The soul did not make the body. In the Buddhist adaptation of this theory no soul, no consciousness, no memory, goes over from one body to the other. -It is the grasping, the craving, still existing at the death of the one body that causes the new set of *Skandhas*, that is, the new body with its mental tendencies and capacities, to arise. How this takes place is nowhere explained.

The Indian theory of *Karma* has been worked out with many

¹ *Phaedo*, 69 et seq. The idea is there also put forward in connexion with a belief in transmigration.

² *Samyutta*, iv. 302.

³ *Majjhima*, iii. 99 et seq.

points of great beauty and ethical value. And the Buddhist adaptation of it, avoiding some of the difficulties common to it and to the allied European theories of fate and predestination, tries to explain the weight of the universe in its action on the individual, the heavy hand of the immeasurable past we cannot escape, the close connexion between all forms of life, and the mysteries of inherited character. Incidentally it held out the hope, to those who believed in it, of a mode of escape from the miseries of transmigration. For as the Arahats had conquered the cravings that were supposed to produce the new body, his actions were no longer *Karma*, but only *Kiriya*, that led to no rebirth.⁴

Another point of Buddhist teaching adopted from previous belief was the practice of ecstatic meditation. In the very earliest times of the most remote animism we find the belief that a person, rapt from all sense of the outside world, possessed by a spirit, acquired from that state a degree of sanctity, was supposed to have a degree of insight, denied to ordinary mortals. In India from the soma frenzy in the *Vedas*, through the mystic reveries of the *Upanishads*, and the hypnotic trances of the ancient Yoga, allied beliefs and practices had never lost their importance and their charm. It is clear from the *Dialogues*, and other of the most ancient Buddhist records,⁵ that the belief was in full force when Buddhism arose, and that the practice was followed by the Buddha's teachers. It was quite impossible for him to ignore the question; and the practice was admitted as a part of the training of the Buddhist Bhikkhu. But it was not the highest or the most important part, and might be omitted altogether. The states of Rapture are called Conditions of Bliss, and they are regarded as useful for the help they give towards the removal of the mental obstacles to the attainment of Arahatsip.⁶ Of the thirty-seven constituent parts of Arahatsip they enter into one group of four. To seek for Arahatsip in the practice of the ecstasy alone is considered a deadly heresy.⁷ So these practices are both pleasant in themselves, and useful as one of the means to the end proposed. But they are not the end, and the end can be reached without them. The most ancient form these exercises took is recorded in the often recurring paragraphs translated in Rhys Davids' *Dialogues of the Buddha* (i. 84-92). More modern, and much more elaborate, forms are given in the *Yogācāras Manual of Indian Mysticism as practised by Buddhists*, edited by Rhys Davids from a unique MS. for the Pāli Text Society in 1896. In the Introduction to this last work the various phases of the question are discussed at length.

Buddhist Texts. The Canonical Books.—It is necessary to remember that the Buddha, like other Indian teachers of his period, taught by conversation only. A highly-educated man (according to the education current at the time), speaking constantly to men of similar education, he followed the literary habit of his day by embodying his doctrines in set phrases (*sūtras*), on which he enlarged, on different occasions, in different ways. Writing was then widely known. But the lack of suitable writing materials made any lengthy books impossible. Such *sūtras* were therefore the recognized form of preserving and communicating opinion. They were catchwords, as it were, *memoria technica*, which could easily be remembered, and would recall the fuller expositions that had been based upon them. Shortly after the Buddha's time the Brahmins had their *sūtras* in Sanskrit, already a dead language. He purposely put his into the ordinary conversational idiom of the day, that is to say, into Pāli. When the Buddha died these sayings were collected together by his disciples into what they call the Four Nikāyas, or "collections." These cannot have reached their final form till about fifty or sixty years afterwards. Other sayings and verses, most of them ascribed, not to the Buddha, but to the disciples themselves, were put into a supplementary Nikāya. We know

⁴ The history of the Indian doctrine of Karma has yet to be written. On the Buddhist side see Rhys Davids' *Hibbert Lectures*, pp. 73-120, and Dahlke, *Aufsätze zum Verständnis des Buddhismus* (Berlin, 1903), i. 92-106, and ii. 1-11.

⁵ For instance, *Majjhima*, i. 163-166

⁶ *Anguttara*, iii. 119.

⁷ *Dīgha*, i. 38.

of slight additions made to this Nikāya as late as the time of Asoka, 3rd century B.C. And the developed doctrine, found in certain portions of it, shows that these are later than the four old Nikāyas. For a generation or two the books so put together were handed down by memory, though probably written memoranda were also used. And they were doubtless accompanied from the first, as they were being taught, by a running commentary. About one hundred years after the Buddha's death there was a schism in the community. Each of the two schools kept an arrangement of the canon—still in Pāli, or some allied dialect. Sanskrit was not used for any Buddhist works till long afterwards, and never used at all, so far as is known, for the canonical books. Each of these two schools broke up in the following centuries, into others. Several of them had their different arrangements of the canonical books, differing also in minor details. These books remained the only authorities for about five centuries, but they all, except only our extant Pāli Nikāyas, have been lost in India. These then are our authorities for the earliest period of Buddhism. Now what are these books?

We talk necessarily of Pāli books. They are not books in the modern sense. They are memorial sentences or verses intended to be learnt by heart. And the whole style and method of arrangement is entirely subordinated to this primary necessity. Each sūtra (Pāli, *sutta*) is very short; usually occupying only a page, or perhaps two, and containing a single proposition. When several of these, almost always those that contain propositions of a similar kind, are collected together in the framework of one dialogue, it is called a *suttanta*. The usual length of such a *suttanta* is about a dozen pages; only a few of them are longer, and a collection of such *suttantas* might be called a book. But it is as yet neither narrative nor essay. It is at most a string of passages, drawn up in similar form to assist the memory, and intended, not to be read, but to be learnt by heart. The first of the four Nikāyas is a collection of the longest of these *suttantas*, and it is called accordingly the *Dīgha Nikāya*, that is "the Collection of Long Ones" (*sci. Suttantas*). The next is the *Majjhima Nikāya*, the "Collection of the *suttantas* of Medium Length"—medium, that is, as being shorter than the *suttantas* in the *Dīgha*, and longer than the ordinary *suttas* preserved in the two following collections. Between them these first two collections contain 186 dialogues, in which the Buddha, or in a few cases one of his leading disciples, is represented as engaged in conversation on some one of the religious, or philosophic, or ethical points in that system which we now call Buddhism. In depth of philosophic insight, in the method of Socratic questioning often adopted, in the earnest and elevated tone of the whole, in the evidence they afford of the most cultured thought of the day, these dialogues constantly remind the reader of the dialogues of Plato. But not in style. They have indeed a style of their own; always dignified, and occasionally rising into eloquence. But for the reasons already given, it is entirely different from the style of Western writings which are always intended to be read. Historical scholars will, however, revere this collection of dialogues as one of the most priceless of the treasures of antiquity still preserved to us. It is to it, above all, that we shall always have to go for our knowledge of the most ancient Buddhism. Of the 186, 175 had by 1907 been edited for the Pāli Text Society, and the remainder were either in the press or in preparation.

A disadvantage of the arrangement in dialogues, more especially as they follow one another according to length and not according to subject, is that it is not easy to find the statement of doctrine on any particular point which is interesting one at the moment. It is very likely just this consideration which led to the compilation of the two following Nikāyas. In the first of these, called the *Anguttara Nikāya*, all those points of Buddhist doctrine capable of expression in classes are set out in order. This practically includes most of the psychology and ethics of Buddhism. For it is a distinguishing mark of the dialogues themselves that the results arrived at are arranged in carefully systematized groups. We are familiar enough in the West with

similar classifications, summed up in such expressions as the Seven Deadly Sins, the Ten Commandments, the Thirty-six Articles, the Four Cardinal Virtues, the Seven Sacraments and a host of others. These numbered lists (it is true) are going out of fashion. The aid which they afford to memory is no longer required in an age in which books of reference abound. It was precisely as a help to memory that they were found so useful in the early Buddhist times, when the books were all learnt by heart, and had never as yet been written. And in the *Anguttara* we find set out in order first of all the units, then all the pairs, then all the trios, and so on. It is the longest book in the Buddhist Bible, and fills 1840 pages 8vo. The whole of the Pāli text has been published by the Pāli Text Society, but only portions have been translated into English. The next, and last, of these four collections contains again the whole, or nearly the whole, of the Buddhist doctrine; but arranged this time in order of subjects. It consists of 55 *Samyuttas* or groups. In each of these the *suttas* on the same subject, or in one or two cases the *suttas* addressed to the same sort of people, are grouped together. The whole of it has been published in five volumes by the Pāli Text Society. Only a few fragments have been translated.

Many hundreds of the short *suttas* and verses in these two collections are found, word for word, in the dialogues. And there are numerous instances of the introductory story stating how, and when, and to whom the *sutta* was enunciated—a sort of narrative framework in which the *sutta* is set—recurring also. This is very suggestive as to the way in which the earliest Buddhist records were gradually built up. The *suttas* came first embodying, in set phrases, the doctrine that had to be handed down. Those episodes, found in two or three different places, and always embodying several *suttas*, came next. Then several of these were woven together to form a *suttanta*. And finally the *suttantas* were grouped together into the two Nikāyas, and the *suttas* and episodes separately into the two others. Parallel with this evolution, so to say, of the *suttas*, the short statements of doctrine, in prose, ran the treatment of the verses. There was a great love of poetry in the communities in which Buddhism arose. Verses were helpful to the memory. And they were adopted not only for this reason. The adherents of the new view of life found pleasure in putting into appropriate verse the feelings of enthusiasm and of ecstasy which the reforming doctrines inspired. When particularly happy in literary finish, or peculiarly rich in religious feeling, such verses were not lost. These were handed on, from mouth to mouth, in the small companies of the brethren or sisters. The oldest verses are all lyrics, expressions either of emotion, or of some deep saying, some pregnant thought. Very few of them have been preserved alone. And even then they are so difficult to understand, so much like puzzles, that they were probably accompanied from the first by a sort of comment in prose, stating when, and why, and by whom they were supposed to have been uttered. As a general rule such a framework in prose is actually preserved in the old Buddhist literature. It is only in the very latest books included in the canon that the narrative part is also regularly in verse, so that a whole work consists of a collection of ballads. The last step, that of combining such ballads into one long epic poem, was not taken till after the canon was closed. The whole process, from the simple anecdote in mixed prose and verse, the so-called *skhāyāna*, to the complete epic, comes out with striking clearness in the history of the Buddhist canon. It is typical, one may notice in passing, of the evolution of the epic elsewhere; in Iceland, for instance, in Persia and in Greece. And we may safely draw the conclusion that if the great Indian epics, the *Mahā-bhārata* and the *Rāmāyana*, had been in existence when the formation of the Buddhist canon began, the course of its development would have been very different from what it was.

As will easily be understood, the same reasons which led to literary activity of this kind, in the earliest period, continued to hold good afterwards. A number of such efforts, after the Nikāyas had been closed, were included in a supplementary Nikāya called the *Khuddaka Nikāya*. It will throw very useful light upon the intellectual level in the Buddhist community just

after the earliest period, and upon literary life in the valley of the Ganges in the 4th or 5th century B.C., if we briefly explain what the tractates in this collection contain. The first, the *Khuddaka Pāṭha*, is a little tract of only a few pages. After a profession of faith in the Buddha, the doctrine and the order, there follows a paragraph setting out the thirty-four constituents of the human body—bones, blood, nerves and so on—strangely incongruous with what follows. For that is simply a few of the most beautiful poems to be found in the Buddhist scriptures. There is no apparent reason, except their exquisite versification, why these particular pieces should have been here brought together. It is most probable that this tiny volume was simply a sort of first lesson book for young neophytes when they joined the order. In any case that is one of the uses to which it is put at present. The text book is the *Dhammapada*. Here are brought together from ten to twenty stanzas on each of twenty-six selected points of Buddhist self-training or ethics. There are altogether 423 verses, gathered from various older sources, and strung together without any other internal connexion than that they relate more or less to the same subject. And the collector has not thought it necessary to choose stanzas written in the same metre, or in the same number of lines. We know that the early Christians were accustomed to sing hymns, both in their homes and on the occasions of their meeting together. These hymns are now irretrievably lost. Had some one made a collection of about twenty isolated stanzas, chosen from these hymns, on each of about twenty subjects—such as Faith, Hope, Love, the Converted Man, Times of Trouble, Quiet Days, the Saviour, the Tree of Life, the Sweet Name, the Dove, the King, the Land of Peace, the Joy Unspeakable—we should have a Christian *Dhammapada*, and very precious such a collection would be. The Buddhist *Dhammapada* has been edited by Professor Fausbøll (2nd ed., 1900), and has been frequently translated. Where the verses deal with those ideas that are common to Christians and Buddhists, the versions are easily intelligible, and some of the stanzas appeal very strongly to the Western sense of religious beauty. Where the stanzas are full of the technical terms of the Buddhist system of self-culture and self-control, it is often impossible, without expansions that spoil the poetry, or learned notes that distract the attention, to convey the full sense of the original. In all these distinctively Buddhist verses the existing translations (of which Professor Max Müller's is the best known, and Dr Karl Neumann's the best) are inadequate and sometimes quite erroneous. The connexion in which they were spoken is often apparent in the more ancient books from which these verses have been taken, and has been preserved in the commentary on the work itself.

In the next little work the framework, the whole paraphernalia of the ancient akhāṇa, is included in the work itself, which is called *Uddāsa*, or "ecstatic utterances." The Buddha is represented, on various occasions during his long career, to have been so much moved by some event, or speech, or action, that he gave vent, as it were, to his pent-up feelings in a short, ecstatic utterance, couched, for the most part, in one or two lines of poetry. These outbursts, very terse and enigmatic, are charged with religious emotion, and turn often on some subtle point of Arahātship, that is, of the Buddhist ideal of life. The original text has been published by the Pāli Text Society. The little book, a garland of fifty of these gems, has been translated by General Strong. The next work is called the *Iti Vuttaka*. This contains 120 short passages, each of them leading up to a terse deep saying of the Buddha's, and introduced, in each case, with the words *Iti vuttam Bhagavā*—"thus was it spoken by the Exalted One." These anecdotes may or may not be historically accurate. It is quite possible that the memory of the early disciples, highly trained as it was, enabled them to preserve a substantially true record of some of these speeches, and of the circumstances in which they were uttered. Some or all of them may also have been invented. In either case they are excellent evidence of the sort of questions on which discussions among the earliest Buddhists must have turned. These ecstatic utterances and deep sayings are attributed to the Buddha himself, and accompanied by the prose framework. There has also been preserved a collection of

stanzas ascribed to his leading followers. Of these 107 are brethren, and 73 sisters, in the order. The prose framework is in this case preserved only in the commentary, which also gives biographies of the authors. This work is called the *Thera-theri-gāthā*.

Another interesting collection is the *Jātaka* book, a set of verses supposed to have been uttered by the Buddha in some of his previous births. These are really 550 of the folk-tales current in India when the canon was being formed, the only thing Buddhist about them being that the Buddha, in a previous birth, is identified in each case with the hero in the little story. Here again the prose is preserved only in the commentary. And it is a most fortunate chance that this—the oldest, the most complete, and the most authentic collection of folklore extant—has thus been preserved intact to the present day. Many of these stories and fables have wandered to Europe, and are found in medieval homilies, poems and story-books. A full account of this curious migration will be found in the introduction to the present writer's *Buddhist Birth Stories*. A translation of the whole book is now published, under the editorship of Professor Cowell, at the Cambridge University Press. The last of these poetical works which it is necessary to mention is the *Sutta Nipāta*, containing fifty-five poems, all except the last merely short lyrics, many of great beauty. A very ancient commentary on the bulk of these poems has been included in the canon as a separate work. The poems themselves have been translated by Professor Fausbøll in the *Sacred Books of the East*. The above works are our authority for the philosophy and ethics of the earliest Buddhists. We have also a complete statement of the rules of the order in the *Vīśayas*, edited, in five volumes, by Professor Oldenberg. Three volumes of translations of these rules, by him and by the present writer, have also appeared in the *Sacred Books of the East*.

There have also been added to the canonical books seven works on *Abhidhamma*, a more elaborate and more classified exposition of the Dhamma or doctrine as set out in the *Nikāyas*. All these works are later. Only one of them has been translated, the so-called Dhamma Sangani. The introduction to this translation, published under the title of *Buddhist Psychology*, contains the fullest account that has yet appeared of the psychological conceptions on which Buddhist ethics are throughout based. The translator, Mrs Caroline Rhys Davids, estimates the date of this ancient manual for Buddhist students as the 4th century B.C.

Later Works.—So far the canon, almost all of which is now accessible to readers of Pāli. But a good deal of work is still required before the harvest of historical data contained in these texts shall have been made acceptable to students of philosophy and sociology. These works of the oldest period, the two centuries and a half, between the Buddha's time and that of Asoka, were followed by a voluminous literature in the following periods—from Asoka to Kanishka, and from Kanishka to Buddhaghosa,—each of about three centuries. Many of these works are extant in MS.; but only five or six of the more important have so far been published. Of these the most interesting is the *Milinda*, one of the earliest historical novels preserved to us. It is mainly religious and philosophical, and purports to give the discussion, extending over several days, in which a Buddhist elder named Nāgasena succeeds in converting Milinda, that is Menander, the famous Greek king of Bactria, to Buddhism. The Pāli text has been edited and the work translated into English. More important historically, though greatly inferior in style and ability, is the *Mahāvastu* or *Sublime Story*, in Sanskrit. The story is the one of chief importance to the Buddhists—the story, namely, of how the Buddha won, under the Bo Tree, the victory over ignorance, and attained to the Sambodhi, "the higher wisdom," of Nirvāna. The story begins with his previous births, in which also he was accumulating the Buddha qualities. And as the *Mahāvastu* was a standard work of a particular sect, or rather school, called the *Mahā-saṅghika*, it has thus preserved for us the theory of the Buddha as held outside the followers of the canon, by those whose views developed, in after centuries, into the *Mahāyāna* or modern form of Buddhism in India. But this book, like all the ancient books, was composed, not in the north, in Nepal, but in the valley of the Ganges, and it is partly

may be as old as the Christian era; the latter belongs to the 2nd century after Christ. Both of them have been edited and translated. The older one contains still a good deal of prose, the gist of it being often repeated in the verses. The later one is entirely in verse, and shows off the author's mastery of the artificial rules of prosody and poetics, according to which a poem, a mahā-kāvya, ought, according to the later writers on the *Ars poetica*, to be composed.

These three works deal only quite briefly and incidentally with any point of Buddhism outside of the Buddha legend. Of greater importance for the history of Buddhism are two later works, the *Neti Pakarava* and the *Saddharma Pundarika*. The former, in Pāli, discusses a number of questions then of importance in the Buddhist community; and it relies throughout, as does the Milinda, on the canonical works, which it quotes largely. The latter, in Sanskrit, is the earliest exposition we have of the later Mahāyāna doctrine. Both these books may be dated in the 2nd or 3rd century of our era. The latter has been translated into English. We have now also the text of the *Fraññā Pāramitā*, a later treatise on the Mahāyāna system, which in time entirely replaced in India the original doctrines. To about the same age belongs also the *Divyāvadāna*, a collection of legends about the leading disciples of the Buddha, and important members of the order, through the subsequent three centuries. These legends are, however, of different dates, and in spite of the comparatively late period at which it was put into its present form, it contains some very ancient fragments.

The whole of the above works were composed in the north of India; that is to say, either north or a few miles south of the Ganges. The record is at present full of gaps. But we can even now obtain a full and accurate idea of the earliest Buddhism, and are able to trace the main lines of its development through the first eight or nine centuries of its career. The Pāli Text Society is still publishing two volumes a year; and the Russian Academy has inaugurated a series to contain the most important of the Sanskrit works still buried in MS. We have also now accessible in Pāli fourteen volumes of the commentaries of the great 5th-century scholars in south India and Ceylon, most of them the works either of Buddhaghosa of Buddh Gaya, or of Dhammapāla of Kāncipura (the ancient name of Conjeevaram). These are full of important historical data on the social, as well as the religious, life of India during the periods of which they treat.

Modern Research.—The striking archaeological discoveries of recent years have both confirmed and added to our knowledge of the earliest period. Pre-eminent among these is the discovery, by Mr William Peppé, on the Birdpur estate, adjoining the boundary between English and Nepalese territory, of the stūpa, or cairn, erected by the Śākya clan over their share of the ashes from the cremation pyre of the Buddha. About 12 m. to the north-east of this spot has been found an inscribed pillar, put up by Asoka as a record of his visit to the Lumbini Garden, as the place where the future Buddha had been born. Although more than two centuries later than the event to which it refers, this inscription is good evidence of the site of the garden. There had been no interruption of the tradition; and it is probable that the place was then still occupied by the descendants of the possessors in the Buddha's time. North-west of this another Asoka pillar has been discovered, recording his visit to the cairn erected by the Sakyas over the remains of Koṅāgamana, one of the previous Buddhas or teachers, whose follower Gotama the Buddha had claimed to be. These discoveries definitely determine the district occupied by the Śākya republic in the 6th and 7th centuries B.C. The boundaries, of course, are not known; but the clan must have spread 30 m. or more along the lower slopes of the Himalayas and 30 m. or more southwards over the plains. It has been abandoned jungle since the 3rd century A.D., or perhaps earlier, so that the ruined sites, numerous through the whole district, have remained undisturbed, and further discoveries may be confidently expected.

1. We have learnt that the division of Buddhism, originating with Burnouf, into northern and southern, is misleading. He found that the Buddhism in his Pāli MSS., which came from Ceylon, differed from that in his Sanskrit MSS., which came from Nepal. Now that the works he used have been made accessible in printed editions, we find that, wherever the existing MSS. came from, the original works themselves were all composed in the same stretch of country, that is, in the valley of the Ganges. The difference of the opinions expressed in the MSS. is due, not to the place where they are now found, but to the difference of time at which they were originally composed. Not one of the books mentioned above is either northern or southern. They all claim, and rightly claim, to belong, so far as their place of origin is concerned, to the Majjhima Dēsa, the middle country. It is undesirable to base the main division of our subject on an adventitious circumstance, and especially so when the nomenclature thus introduced (it is not found in the books themselves) cuts right across the true line of division. The use of the terms northern and southern as applied, not to the existing MSS., but to the original books, or to the Buddhism they teach, not only does not help us, it is the source of serious misunderstanding. It inevitably leads careless writers to take for granted that we have, historically, two Buddhisms—one manufactured in Ceylon, the other in Nepal. Now this is admittedly wrong. What we have to consider is Buddhism varying through slight degrees, as the centuries pass by, in almost every book. We may call it one, or we may call it many. What is quite certain is that it is not two. And the most useful distinction to emphasize is, not the ambiguous and misleading geographical one—derived from the places where the modern copies of the MSS. are found; nor even, though that would be better, the linguistic one—but the chronological one. The use, therefore, of the inaccurate and misleading terms northern and southern ought no longer to be followed in scholarly works on Buddhism.

2. Our ideas as to the social conditions that prevailed, during the Buddha's lifetime, in the eastern valley of the Ganges have been modified. The people were divided into clans, many of them governed as republics, more or less aristocratic. In a few cases several of such republics had formed confederations, and in four cases such confederations had already become hereditary monarchies. The right historical analogy is not the state of Germany in the middle ages, but the state of Greece in the time of Socrates. The Śākiyas were still a republic. They had republics for their neighbours on the east and south, but on the western boundary was the kingdom of Kosala, the modern Oudh, which they acknowledged as a suzerain power. The Buddha's father was not a king. There were rājas in the clan, but the word meant at most something like consul or archon. All the four real kings were called Mahā-rāja. And Suddhodana, the teacher's father, was not even rāja. One of his cousins, named Bhaddiya, is styled a rāja; but Suddhodana is spoken of, like other citizens, as Suddhodana the Śākiyan. As the ancient books are very particular on this question of titles, this is decisive.

3. There was no caste—no caste, that is, in the modern sense of the term. We have long known that the conubium was the cause of a long and determined struggle between the patricians and the plebeians in Rome. Evidence has been yearly accumulating on the existence of restrictions as to intermarriage, and as to the right of eating together (commensality) among other Aryan tribes, Greeks, Germans, Russians and so on. Even without the fact of the existence now of such restrictions among the modern successors of the ancient Aryans in India, it would have been probable that they also were addicted to similar customs. It is certain that the notion of such usages was familiar enough to some at least of the tribes that preceded the Aryans in India. Rules of endogamy and exogamy; privileges, restricted to certain classes, of eating together, are not only Indian or Aryan, but world-wide phenomena. Both the spirit, and to a large degree the actual details, of modern Indian caste-usages are identical

with these ancient, and no doubt universal, customs. It is in them that we have the key to the origin of caste.

At any moment in the history of a nation such customs seem, to a superficial observer, to be fixed and immutable. As a matter of fact they are never quite the same in successive centuries, or even generations. The numerous and complicated details which we sum up under the convenient, but often misleading, single name of caste, are solely dependent for their sanction on public opinion. That opinion seems stable. But it is always tending to vary as to the degree of importance attached to some particular one of the details, as to the size and complexity of the particular groups in which each detail ought to be observed.

Owing to the fact that the particular group that in India worked its way to the top, based its claims on religious grounds, not on political power, nor on wealth, the system has, no doubt, lasted longer in India than in Europe. But public opinion still insists, in considerable circles even in Europe, on restrictions of a more or less defined kind, both as to marriage and as to eating together. And in India the problem still remains to trace, in the literature, the gradual growth of the system—the gradual formation of new sections among the people, the gradual extension of the institution to the families of people engaged in certain trades, belonging to the same group, or sect, or tribe, tracing their ancestry, whether rightly or wrongly, to the same source. All these factors, and others besides, are real factors. But they are phases of the extension and growth, not explanations of the origin of the system.

There is no evidence to show that at the time of the rise of Buddhism there was any substantial difference, as regards the barriers in question, between the peoples dwelling in the valley of the Ganges and their contemporaries, Greek or Roman, dwelling on the shores of the Mediterranean Sea. The point of greatest weight in the establishment of the subsequent development, the supremacy in India of the priests, was still being hotly debated. All the new evidence tends to show that the struggle was being decided rather against than for the Brahmins. What we find in the Buddha's time is caste in the making. The great mass of the people were distinguished quite roughly into four classes, social strata, of which the boundary lines were vague and uncertain. At one end of the scale were certain outlying tribes and certain hereditary crafts of a dirty or despised kind. At the other end the nobles claimed the superiority. But Brahmins by birth (not necessarily sacerdotal priests, for they followed all sorts of occupations) were trying to oust the nobles from the highest grade. They only succeeded, long afterwards, when the power of Buddhism had declined.

4. It had been supposed on the authority of late priestly texts, where boasts of persecution are put forth, that the cause of the decline of Buddhism in India had been Brahmin persecution. The now accessible older authorities, with one doubtful exception,¹ make no mention of persecution. On the other hand, the comparison we are now able to make between the canonical books of the older Buddhism and the later texts of the following centuries, shows a continual decline from the old standpoint, a continual approximation of the Buddhist views to those of the other philosophies and religions of India. We can see now that the very event which seemed, in the eyes of the world, to be the most striking proof of the success of the new movement, the conversion and strenuous support, in the 3rd century B.C., of Asoka, the most powerful ruler India had had, only hastened the decline. The adhesion of large numbers of nominal converts, more especially from the newly incorporated and less advanced provinces, produced weakness rather than strength in the movement for reform. The day of compromise had come. Every relaxation of the old thoroughgoing position was welcomed and supported by converts only half converted. And so the margin of difference between the Buddhists and their opponents gradually faded almost entirely away. The soul theory, step by step, gained again the upper hand. The popular gods and the popular superstitions are once more favoured by Buddhists themselves. The philosophical basis of the old ethics is overshadowed by new

speculations. And even the old ideal of life, the salvation of the Arahats to be won in this world and in this world only, by self-culture and self-mastery, is forgotten, or mentioned only to be condemned. The end was inevitable. The need of a separate organization became less and less apparent. The whole pantheon of the Vedic gods, with the ceremonies and the sacrifices associated with them, passed indeed away. But the ancient Buddhism, the party of reform, was overwhelmed also in its fall; and modern Hinduism arose on the ruins of both.

AUTHORITIES.—The attention of the few scholars at work on the subject being directed to the necessary first step of publishing the ancient authorities, the work of exploring them, of analysing and classifying the data they contain, has as yet been very imperfectly done. The annexed list contains only the most important works.

Texts.—*Pāli Text Society*, 57 vols.; *Jātaka*, 7 vols., ed. Fausbøll, 1877-1897; *Vinaya*, 5 vols., ed. Oldenberg, 1879-1883; *Dhammapada*, ed. Fausbøll, 2nd ed., 1900; *Divyāvadāna*, ed. Cowell and Neil, 1882; *Mahāvastu*, ed. Senart, 3 vols., 1882-1897; *Buddha Carita*, ed. Cowell, 1892; *Milinda-panha*, ed. Trenckner, 1880.

Translations.—*Vinaya Texts*, by Rhys Davids and Oldenberg, 3 vols., 1881-1885; *Dhammapada*, by Max Müller, and *Sutta Nipata*, by Fausbøll, 1881; *Questions of King Milinda*, by Rhys Davids, 2 vols., 1890-1894; *Buddhist Suttas*, by Rhys Davids, 1881; *Saddharma Pundarika*, by Kern, 1884; *Buddhist Mahāyāna Texts*, by Cowell and Max Müller, 1893—all the above in the "Sacred Books of the East"; *Jātaka*, vol. i., by Rhys Davids, under the title *Buddhist Birth Stories*, 1880; vols. i.-vi., by Chalmers, Neil, Francis, and Rouse, 1895-1897; *Buddhism in Translations*, by Warren, 1896; *Buddhistische Anthologie*, by Neumann, 1892. *Lieder der Mönche und Nonnen*, 1899, by the same; *Dialogues of the Buddha*, by Rhys Davids, 1899; *Die Reden Gotamo Buddhas*, by Neumann, 3 vols., 1899-1903; *Buddhist Psychology*, by Mrs Rhys Davids, 1900.

Manuals, Monographs, &c.—*Buddhism*, by Rhys Davids, 12mo, 20th thousand, 1903; *Buddha, sein Leben, seine Lehre und seine Gemeinde*, by Oldenberg, 5th edition, 1906; *Der Buddhismus und seine Geschichte in Indien*, by Kern, 1882; *Der Buddhismus*, by Edmund Hardy, 1890; *American Lectures, Buddhism*, by Rhys Davids, 1896; *Inscriptions de Piyadasi*, by Senart, 2 vols., 1881-1886; *Mara und Buddha*, by Windisch, 1895; *Buddhist India*, by Rhys Davids, 1903. (T. W. R. D.)

BUDÉ [BUDAËVUS], GUILLAUME (1467-1540), French scholar, was born at Paris. He went to the university of Orleans to study law, but for several years, being possessed of ample means, he led an idle and dissipated life. When about twenty-four years of age he was seized with a sudden passion for study, and made rapid progress, particularly in the Latin and Greek languages. The work which gained him greatest reputation was his *De Asse et Partibus* (1514), a treatise on ancient coins and measures. He was held in high esteem by Francis I., who was persuaded by him, and by Jean du Bellay, bishop of Narbonne, to found the Collegium Trilingue, afterwards the Collège de France, and the library at Fontainebleau, which was removed to Paris and was the origin of the Bibliothèque Nationale. He also induced Francis to refrain from prohibiting printing in France, which had been advised by the Sorbonne in 1533. He was sent by Louis XII. to Rome as ambassador to Leo X., and in 1522 was appointed *maître des requêtes* and was several times *préôt des marchands*. He died in Paris on the 23rd of August 1540.

Budé was also the author of *Annotaciones in XXIV. libros Pandectarum* (1508), which, by the application of philology and history, had a great influence on the study of Roman law, and of *Commentarii linguae Graecae* (1529), an extensive collection of lexicographical notes, which contributed greatly to the study of Greek literature in France. Budé corresponded with the most learned men of his time, amongst them Erasmus, who called him the marvel of France, and Thomas More. He wrote with equal facility in Greek and Latin, although his Latin is inferior to his Greek, being somewhat harsh and full of Greek constructions. His request that he should be buried at night, and his widow's open profession of Protestantism at Geneva (where she retired after his death), caused him to be suspected of leanings towards Calvinism. At the time of the massacre of St Bartholomew, the members of his family were obliged to flee from France. Some took refuge in Switzerland, where they worthily upheld the traditions of their house, while others settled in Pomerania, under the name Budde or Buudeus.

¹ See *Journal of the Pāli Text Society*, 1896, pp. 87-92.

See Le Roy, *Vita G. Budæi* (1540); Rebitté, *G. Budé, restaurateur des études grecques en France* (1846); E. de Budé, *Vie de G. Budé* (1884), who refutes the idea of his ancestor's Protestant views; D'Hozier, *La Maison de Budé*; L. Delaruelle, *Études sur l'humanisme français* (1907).

BUDE, a small seaport and watering-place in the Launceston parliamentary division of Cornwall, England, on the north coast at the mouth of the river Bude. With the market town of Stratton, 1½ m. inland to the east, it forms the urban district of Stratton and Bude, with a population (1901) of 2308. Bude is served by a branch of the London & South-Western railway. Its only notable building is the Early English parish church of St Michael and All Angels. The climate is healthy and the coast scenery in the neighbourhood fine, especially towards the south. There the gigantic cliffs, with their banded strata, have been broken into fantastic forms by the waves. Many ships have been wrecked on the jagged reefs which fringe their base. The figure-head of one of these, the "Bencellon," lost in 1862, is preserved in the churchyard. The harbour, sheltered by a breakwater, will admit vessels of 300 tons at high water; and the river has been dammed to form a basin for the canal which runs to Launceston. Some fishing is carried on: but the staple trade is the export of sand, which, being highly charged with carbonate of lime, is much used for manure. There are golf links near the town. The currents in the bay make bathing dangerous.

BUDGELL, EUSTACE (1686-1737), English man of letters, the son of Dr Gilbert Budge, was born on the 19th of August 1686 at St Thomas, near Exeter. He matriculated in 1705 at Trinity College, Oxford, and afterwards joined the Inner Temple, London; but instead of studying law he devoted his whole attention to literature. Addison, who was first cousin to his mother, befriended him, and, on being appointed secretary to Lord Wharton, lord-lieutenant of Ireland in 1710, took Budge with him as one of the clerks of his office. Budge took part with Steele and Addison in writing the *Taller*. He was also a contributor to the *Spectator* and the *Guardian*,—his papers being marked with an X in the former, and with an asterisk in the latter. He was subsequently made under-secretary to Addison, chief secretary to the lords justices of Ireland, and deputy-clerk of the council, and became a member of the Irish parliament. In 1717, when Addison became principal secretary of state in England, he procured for Budge the place of accountant and comptroller-general of the revenue in Ireland. But the next year, the duke of Bolton being appointed lord-lieutenant, Budge wrote a lampoon against E. Webster, his secretary. This led to his being removed from his post of accountant-general, upon which he returned to England, and, contrary to the advice of Addison, published his case in a pamphlet. In the year 1720 he lost £20,000 by the South Sea scheme, and afterwards spent £5000 more in unsuccessful attempts to get into parliament. He began to write pamphlets against the ministry, and published many papers in the *Craftsman*. In 1733 he started a weekly periodical called the *Bee*, which he continued for more than a hundred numbers. By the will of Matthew Tindal, the deist, who died in 1733, a legacy of 2000 guineas was left to Budge; but the bequest (which had, it was alleged, been inserted in the will by Budge himself) was successfully disputed by Tindal's nephew and nearest heir, Nicholas Tindal, who translated and wrote a *Continuation of the History of England* of Paul de Rapin-Thoyras. Hence Pope's lines—

"Let Budge charge low Grub Street on his quill,
And write whatever he pleased—except his will."¹

Budge is said to have sold the second volume of Tindal's *Christianity as Old as the Creation* to Bishop Gibson, by whom it was destroyed. The scandal caused by these transactions ruined him. On the 4th of May 1737, after filling his pockets with stones, he took a boat at Somerset-stairs, and while the boat was passing under the bridge threw himself into the river. On his desk was found a slip of paper with the words—"What Cato did, and Addison approved, cannot be wrong." Besides the works mentioned above, he wrote a translation (1714) of the *Characters*

¹ *Epistle to Dr Arbuthnot*, lines 378-379.

of Theophrastus. He never married, but left a natural daughter, Anne Eustace, who became an actress at Drury Lane.

See Cibber's *Lives of the Poets*, vol. v.

BUDGET (originally from a Gallic word meaning sack, latinized as *bulga*, leather wallet or bag, thence in O. Fr. *bougette*, from which the Eng. form is derived), the name applied to an account of the ways and means by which the income and expenditure for a definite period are to be balanced, generally by a finance minister for his state, or by analogy for smaller bodies.¹ The term first came into use in England about 1760. In the United Kingdom the chancellor of the exchequer, usually in April, lays before the House of Commons a statement of the actual results of revenue and expenditure in the past finance year (now ending March 31), showing how far his estimates have been realized, and what surplus or deficit there has been in the income as compared with the expenditure. This is accompanied by another statement in which the chancellor gives an estimate of what the produce of the revenue may be in the year just entered upon, supposing the taxes and duties to remain as they were in the past year, and also an estimate of what the expenditure will be in the current year. If the estimated revenue, after allowing for normal increase of the principal sources of income, be less than the estimated expenditure, this is deemed a case for the imposition of some new, or the increase of some existing, tax or taxes. On the other hand, if the estimated revenue shows a large surplus over the estimated expenditure, there is room for remitting or reducing some tax or taxes, and the extent of this relief is generally limited to the amount of surplus realized in the previous year. The chancellor of the exchequer has to take parliament into confidence on his estimates, both as regards revenue and expenditure; and these estimates are prepared by the various departments of the administration. They are divided into two parts, the consolidated fund services and the supply services, the first comprising the civil list, debt charge, pensions and courts of justice, while the "supply" includes the remaining expenditure of the country, as the army, the navy, the civil service and revenue departments, the post-office and telegraph services. The consolidated fund services are an annual charge, fixed by statute, and alterable only by statute, but the supply services may be gone through in detail, item by item, by the House of Commons, which forms itself into a committee of supply for the purpose. These items can be criticized, and reduced (but not increased) by amendments proposed by private members. The committee of ways and means (also a committee of the whole House) votes the supplies when granted and originates all taxes. The resolutions of these committees are reported to the House, and when the taxation and expenditure obtain the assent of parliament, the results as thus adjusted become the final budget estimate for the year, and are passed as the Finance Act. This system of annual review and adjustment of the public finances obtains not only in the British colonies, but in British India. The Indian budget, giving the results of income and expenditure in the year ending 31st of December, and the prospective estimates, is laid before the imperial parliament in the course of the ensuing session.

The budget, though modified by different forms, has also long been practised in France, the United States, and other constitutional countries, and has in some cases been adopted by autocratic Powers. Russia began the publication of annual budgets in 1866; Egypt has followed the example; so also has Turkey, by an imperial decree of 1875. All countries agree in taking a yearly period, but the actual date of commencement varies considerably. The German and Danish financial year, like that of the United Kingdom, begins on the 1st of April; in France, Belgium and Austria, it begins on the 1st of January; in Italy, Spain, the United States and Canada, on the 1st of July.

¹ It was a name applied also to a leather-covered case or small coffer. Cotgrave translates *bougette* "a little coffer or trunk . . . covered with leather." It became a common word for a despatch box in which official papers were kept. The chancellor of the exchequer thus was said to "open his budget" when he made his annual statement.

Previously to 1832, however, the English financial year ran from the 1st of January to the 31st of December.

It may be mentioned that Disraeli introduced a budget (on which he was defeated) in the autumn of 1852; and in 1860, owing to the ratification of the commercial treaty with France, the budget was introduced on the 10th of February. In 1859, through a change of administration, the budget was not introduced until the 18th of July, while in 1880 there were two budgets, one introduced in March under Disraeli's administration, and the other in June, under Gladstone's administration.

National budgets are to be discriminated (1) as budgets passing under parliamentary scrutiny and debate from year to year, and (2) budgets emitted on executive authority. In most constitutional countries the procedure is somewhat of a mean between the extremes of the United Kingdom and the United States. In the United Kingdom the budget is placed by the executive before the whole House, without any previous examination except by the cabinet, and it is scrutinized by the House sitting as a committee; in the majority of countries, however, the budget undergoes a preliminary examination by a specially selected committee, which has the power to make drastic changes in the proposals of the executive. In the United States, on the other hand, the budget practically emanates from Congress, for there is no connexion between the executive and the legislative departments. The estimates prepared by the various executive departments are submitted to the House of Representatives by the secretary of the treasury. With these estimates two separate committees deal. The committee on ways and means deals with taxation, and the committee on appropriations with expenditure. The latter committee is divided into various sub-committees, each of which brings in an appropriation bill for the department or subject with which it is charged.

There are also, in all the greater countries, local and municipal taxations and expenditures of only less account than the national. In federal governments such as the United States, the German empire, or the Argentine republic, the budgets of the several states of the federation have to be consulted, as well as the federal budgets, for a knowledge of the finances.

AUTHORITIES.—Stourm, *Le Budget, son histoire et son mécanisme* (1889), which gives a comparative study of the budgets of different countries, is the best book upon the subject. See also Siedler, *Budget und Budgetrecht* (1885); Sendel, *Über Budgetrecht* (1890); Benson, *Le Contrôle des budgets en France et à l'étranger* (1899); Baskable, *Public Finance* (3rd ed., 1903); Eugene E. Agger, *The Budget in American Commonwealths* (New York, 1907).

BUDINI, an ancient nation in the N.E. of the Scythia (*g.v.*) of Herodotus (iv. 21, 108, 109), probably on the middle course of the Volga about Samara. They are described as light-eyed and red-haired, and lived by hunting in their thick forests. They were probably Finns of the branch now represented by the Votiaks and Permiaks, forced northwards by later immigrants. In their country was a woody city inhabited by a distinct race, the Geloni, who seem to have spoken an Indo-European tongue. Later writers add nothing to our knowledge, and are chiefly interested in the tarandus, an animal which dwelt in the woods of the Budini and seems to have been the reindeer (Aristotle *ap. Aelian, Hist. Anim.* xv. 33). (E. H. M.)

BUDWEIS (Czech *Budějovice*), a town of Bohemia, Austria, 80 m. S.S.W. of Prague by rail. Pop. (1900) 39,630. It is situated at the junction of the Maltsh with the Moldau, which here becomes navigable, and possesses a beautiful square, lined with fine arcaded buildings, the principal one being the town-hall, built in 1730 in Renaissance style. Other interesting buildings are the cathedral with its detached tower, dating from 1500, and the Marien-Kirche with fine cloisters. Budweis has a large, varied and growing industry, which comprises the manufacture of chemicals, matches, paper, machinery, bricks and tiles, corn and saw mills, boat-building, bell-founding and black-lead pencils. It is the principal commercial centre of South Bohemia, being an important railway junction, as well as a river port, and carries on a large trade in corn, timber, lignite, salt, industrial products and beer, the latter mostly exported to America. It is the see of a bishop since 1783, and is the centre of a German enclave in Czech

Bohemia. But the Czech element is steadily increasing, and the population of the town was in 1908 60% Czech. The railway from Budweis to Litz, laid in 1827 for horse-cars, was the first line constructed in Austria. A little to the north, in the Moldau valley, stands the beautiful castle of Frauenberg, belonging to Prince Schwarzenberg. It stands on the site formerly occupied by a 13th-century castle, and was built in the middle of the 19th century, after the model of Windsor Castle.

The old town of Budweis was founded in the 13th century by Budivoj Vitkovec, father of Závřil of Falkenstein. In 1265 Ottokar II. founded the new town, which was soon afterwards created a royal city. Charles IV. and his son Wenceslaus granted the town many privileges. Although mainly Catholic, Budweis declared for King George Poděbrad, and in 1468 was taken by the crusaders under Zdenko of Stenberg. From this time the town remained faithful to the royal cause, and in 1547 was granted by the emperor Ferdinand the privilege of ranking at the diet next to Prague and Pilsen. After the outbreak of the Thirty Years' War Budweis was confirmed in all its privileges.

BUELL, DON CARLOS (1818-1898), American soldier, was born near Marietta, Ohio, on the 23rd of March 1818. He graduated at West Point in 1841, and as a company officer of infantry took part in the Seminole War of 1841-42 and the Mexican War, during which he was present at almost all the battles fought by Generals Taylor and Scott, winning the brevet of captain at Monterey, and that of major at Contreras-Churubusco, where he was wounded. From 1848 to 1861 he performed various staff duties, chiefly as assistant-adjutant-general. On the outbreak of the Civil War he was appointed lieutenant-colonel on the 11th of May 1861, brigadier-general of volunteers a few days later, and major-general of volunteers in March 1862. He aided efficiently in organizing the Army of the Potomac, and, at the instance of General McClellan, was sent, in November 1861, to Kentucky to succeed General William T. Sherman in command. Here he employed himself in the organization and training of the Army of the Ohio (subsequently of the Cumberland), which to the end of its career retained a standard of discipline and efficiency only surpassed by that of the Army of the Potomac. In the spring of 1862 Buell followed the retiring Confederates under Sidney Johnston, and appeared on the field of Shiloh (*g.v.*) at the end of the first day's fighting. On the following day, aided by Buell's fresh and well-trained army, Grant carried all before him. Buell subsequently served under Halleck in the advance on Corinth, and in the autumn commanded in the campaign in Kentucky against Bragg. After a period of manoeuvring in which Buell scarcely held his own, this virtually ended in the indecisive battle of Perryville. The alleged tardiness of his pursuit, and his objection to a plan of campaign ordered by the Washington authorities, brought about Buell's removal from command. With all his gifts as an organizer and disciplinarian, he was haughty in his dealings with the civil authorities, and, in high command, he showed, on the whole, unnecessary tardiness of movement and an utter disregard for the requirements of the political situation. Moreover, as McClellan's friend, holding similar views, adverse politically to the administration, he suffered by McClellan's displacement. The complaints made against him were investigated in 1862-1863; but the result of the investigation was not published. Subsequently he was offered military employment, which he declined. He resigned his volunteer commission in May, and his regular commission in June 1864. He was president of Green River ironworks (1865-1870), and subsequently engaged in various mining enterprises; he served (1885-1889) as pension agent at Louisville. He died near Rockport, Kentucky, on the 19th of November 1898.

BUENAVENTURA, a Pacific port of Colombia, in the department of Cauca, about 210 m. W.S.W. of Bogotá. Pop. about 1200. The town is situated on a small island, called Cascajal, at the head of a broad estuary or bay projecting inland from the Bay of Chocó and 10 m. from its mouth. Its geographical position is lat. 3° 48' N., long. 77° 12' W. The estuary is deep enough for vessels of 24 ft. draught and affords an excellent harbour. Buenaventura is a port of call for two lines of steamers (English

and German), and is the Colombian landing-place of the West Coast cable. The town is mean in appearance, and has a very unhealthy climate, oppressively hot and humid. It is the port for the upper basin of the Cauca, an elevated and fertile region, with two large commercial centres, Popayan and Cali. In 1907 a railway was under construction to the latter, and an extension to Bogotá was also projected.

BUENOS AIRES, a maritime province of Argentina, South America, bounded N. by the province of Santa Fé and Entre Rios, E. by the latter, the La Plata estuary, and the Atlantic, S. by the Atlantic, and W. by the territories (*gobernaciones*) of Rio Negro and Las Pampas, and the provinces of Córdoba and Santa Fé. Its area is 117,812 sq. m., making it the largest province of the republic. It is also the most populous, even excluding the federal district, an official estimate of 1903 giving it a population of 1,251,000. Although it has a frontage of over 900 m. on the La Plata and the Atlantic, the province has but few good natural ports, the best being Bahía Blanca, where the Argentine government has constructed a naval port, and Ensenada (La Plata), where extensive artificial basins have been constructed for the reception of ocean-going steamers. San Nicolas in the extreme north has a fairly good river port, while at Buenos Aires, a costly artificial port has been constructed.

In its general aspect the province forms a part of the great treeless plain extending from the Atlantic and La Plata estuary westward to the Andes. A fringe of small tangled wood covers the low river banks and delta region of the Paraná between San Nicolas and Buenos Aires; thence southward to Bahía Blanca the sea-shore is low and sandy, with a zone of lagoons and partially submerged lands immediately behind. The south-eastern and central parts of the province are low and marshy, and their effective drainage has long been an urgent problem. Two ranges of low mountains extend partly across the southern part of the province—the first from Mar del Plata, on the coast, in a north-east direction, known at different points as the Sierra del Volcan (85 ft.), Sierra de Tandil (1476 ft.); and Sierra Baya, and the second and shorter range nearer Bahía Blanca, having the same general direction, known at different points as the Sierra Pillahuinco and Sierra de la Ventana (3543 ft.). The country is well watered with numerous lakes and small rivers, the largest river being the Rio Salado del Sud, which rises near the north-western boundary and flows entirely across the province in a south-easterly direction with a course of about 360 m. The Rio Colorado crosses the extreme southern extension of the province, a distance of about 80 m., but its mouth is obstructed, and its lower course is subject to occasional disastrous inundations.

Cattle-raising naturally became the principal industry of this region soon after its settlement by the Spaniards, and sheep-raising on a profitable basis was developed about the middle of the 19th century. Toward the end of that century the exports of wool, live-stock and dressed meats reached enormous proportions. There is a large export of jerked beef (*asado*) to Brazil and Cuba, and of live-stock to Europe, South Africa and neighbouring South American republics. Much attention also has been given to raising horses, asses, mules, swine and goats, all of which thrive on these grassy plains. Butter and cheese-making have gained considerable prominence in the province since 1890, and butter has become an article of export. Little attention had been given to cereals up to 1875, but subsequently energetic efforts were made to increase the production of wheat, Indian corn, linseed, barley, oats and alfalfa, so that by the end of the century the exports of wheat and flour had reached a considerable value. In 1895 there were 3,400,000 acres under cultivation in the province, and in 1900 the area devoted to wheat alone aggregated 1,960,000 acres. Fruit-growing also has made good progress, especially on the islands of the Paraná delta, and Argentine peaches, pears, strawberries, grapes and figs are highly appreciated.

The navigation of the Paraná is at all times difficult, and is impossible for the larger ocean-going steamers. The greater part of the trade of the northern and western provinces, therefore, must pass through the ports of Buenos Aires and Ensenada, at

which an immense volume of business is concentrated. All the great trunk railways of the republic pass through the province and converge at these ports, and from them a number of transatlantic steamship lines carry away the products of its fertile soil. The province is also liberally supplied with branch railways. In the far south the new port of Bahía Blanca has become prominent in the export of wool and wheat.

The principal cities and towns of the province (apart from Buenos Aires and its suburbs of Belgrano and Flores) are its capital La Plata; Bahía Blanca, San Nicolas, a river port on the Paraná 150 m. by rail north-west of Buenos Aires, with a population (1901) of 13,000; Campana (pop. 5419 in 1895), the former river port of Buenos Aires on one of the channels of the Paraná, 51 m. by rail north-west of that city, and the site of the first factory in Argentina (1883) for freezing mutton for export; Chivilcoy, an important interior town, with a population (1901) of 15,000; Pergamino (9540 in 1895), a northern inland railway centre; Mar del Plata, a popular seaside resort 750 m. by rail south of Buenos Aires; Azul (9494), Tandil (7288), Chascomús (5667), Mercedes (9269), and Barracas al Sud (10,155), once the centre of the jerked beef industries.

The early history of the province of Buenos Aires was a struggle for supremacy over the other provinces for a period of two generations. Its large extent of territory was secured through successive additions by conquest of adjoining Indian territories south and west, the last additions being as late as 1879. Buenos Aires became a province of the Confederation in 1820, and adopted a constitution in 1854, which provides for its administration by a governor and legislature of two chambers, both chosen by popular vote. An unsuccessful revolt in 1880 against the national government led to the federalization of the city of Buenos Aires, and the selection of La Plata as the provincial capital, the republic assuming the public indebtedness of the provinces at that time as an indemnification. Before the new capital was finished, however, the province had incurred further liabilities of ten millions sterling, and has since then been greatly handicapped in its development in consequence. (A. J. L.)

BUENOS AIRES, a city and port of Argentina, and capital of the republic, in 34° 36' 21" S. lat. and 58° 21' 33" W. long., on the west shore of the La Plata estuary, about 155 m. above its mouth, and 127 m. W. by N. from Montevideo. The estuary at this point is 34 m. wide, and so shallow that vessels can enter the docks only through artificial channels kept open by constant dredging. Previously to the construction of the new port, ocean-going vessels of over 15 ft. draught were compelled to anchor in the outer roads some 12 m. from the city, and communication with the shore was effected by means of steam tenders and small boats, connecting with long landing piers, or with carts driven out from the beach. The city is built upon an open grassy plain extending inland from the banks of the estuary, and north from the Riachuelo or Matanzas river where the "Boca" port is located. Its average elevation is about 65 ft. above sea-level. The federal district, which includes the city and its suburbs and covers an area of 72 sq. m., was detached from the province of Buenos Aires by an act of congress in 1880. With the construction of the new port and reclamation of considerable areas of the shallow water frontage, the area of the city has been greatly extended below the line of the original estuary banks. The streets of the old city, which are narrow and laid out to enclose rectangular blocks of uniform size, run nearly parallel with the cardinal points of the compass, but this plan is not closely followed in the new additions and suburbs. This uniformity in plan, combined with the level ground and the style of buildings first erected, gave to the city an extremely monotonous and uninteresting appearance, but with its growth in wealth and population, greater diversity and better taste in architecture have resulted.

The prevailing style of domestic architecture is that introduced from Spain and used throughout all the Spanish colonies—the grouping of one-storey buildings round one or two *patios*, which open on the street through a wide doorway. These residences have heavily barred windows on the street, and flat roofs with

parapets admirably adapted for defence. The domiciliation of wealthy foreigners, and the introduction of foreign customs and foreign culture, have gradually modified the style of architecture, both public and domestic, and modern Buenos Aires is adorned with many costly and attractive public edifices and residences. French renaissance, lavishly decorated, has become the prevailing style. The Avenida Alvear is particularly noted for the elegance of its private residences, and the new Avenida de Mayo for its display of elaborately ornamented public and business edifices, while the suburban districts of Belgrano and Flores are distinguished for the attractiveness of their country-houses and gardens. A part of the population is greatly overcrowded, one-fifth living in *conventillos*, or tenement-houses.

Among the city's many *plazas*, or squares, twelve are especially worthy of mention, viz.: 25 de Mayo (formerly Victoria) on which face the Government-House and Cathedral, San Martín (or Retiro), Lavalle, Libertad, Lorea, Belgrano, 6 de Junio, Once de Setiembre, Independencia (formerly Concepción), Constitución, Caridad and 29 de Diciembre. These vary in size from one to three squares, or 4 to 12 acres each, and are handsomely laid out with flowers, shrubbery, walks and shade trees. There are also two elaborately laid out *alamedas*, the Recoleta and the Paseo de Julio, the latter on the river front and partially absorbed by the new port works, and the great park at Palermo, officially called 3 de Febrero, which contains 840 acres, beautifully laid out in drives, footpaths, lawns, gardens and artificial lakes. In all, the *plazas* and parks of Buenos Aires cover an area of 960 acres.

The cathedral, which is one of the largest in South America, dating from 1752, resembles the Madeleine of Paris in design, and its classical portico facing the Plaza 25 de Mayo has twelve stately Corinthian columns supporting an elaborately sculptured pediment. The archbishop's palace (Buenos Aires became an archiepiscopal see in 1866) adjoins the cathedral. There are about twenty-five Roman Catholic churches in the city, one of the richest and most popular of which is the Merced on Calle Reconquista, and four Protestant churches—English, Scottish Presbyterian, American Methodist and German Lutheran. Twenty asylums for orphans and indigent persons and one for lunatics are maintained at public expense and by private religious associations, while the demand for organized medical and surgical treatment is met by fifteen well-appointed hospitals, having an aggregate of 2600 beds, and treating 17,000 patients annually. Of these, five belong to foreign nationalities. The city has six cemeteries covering 230 acres.

Among the more noteworthy public buildings are the Casa Rosada (government-house), facing the Plaza 25 de Mayo and occupying in part the site of the fort built by Garay in 1580; the new congress hall on Calle Callao and Avenida de Mayo, finished in 1906 at a cost of £1,300,000; the new municipal hall on Avenida de Mayo; the *bolsa* or exchange, distributing reservoir, mint, and some of the more modern educational buildings. Higher education is represented by the university of Buenos Aires, with its several faculties, including law and medicine, and 3562 students (1901), four national colleges, three normal schools and various technical schools. There are, also, a national library, a national museum, a zoological garden and an aquarium. The people are fond of music, the drama and amusements, and devote much time and expense to diversions of a widely varied character, from Italian opera to horse-racing and *pelota*. They have two or three large public baths, and a large number of social, sporting and athletic clubs. The *Porteños*, as the residents of Buenos Aires are called, are accustomed to call their city the "Paris of America," and not without reason. Buenos Aires has become the principal manufacturing centre of the republic, and its industrial establishments are numbered by thousands and their capital by hundreds of millions of dollars.

The growth of Buenos Aires since settled conditions have prevailed, and especially since its federalization, has been very rapid, and the city has finally outstripped all rivals and become the largest city of South America. At the time of its first

authentic census in 1869, it had a population of 177,767. In 1887, when the suburbs of Belgrano and Flores with an aggregate population of 28,000 were annexed, its population without this increment was estimated at 404,000. In 1895 the national census gave the population as 663,854, and in 1904 a municipal census increased it to 950,891. At the close of 1905 the national statistical office estimated it at 1,025,653. The excess of births over deaths is unusually large (about 14 per thousand in 1905). The city has about one-fifth of the population of the whole republic. The government is vested in an *intendente municipal* (mayor) appointed by the national executive with the approval of the senate, and a *concejo deliberante* (legislative council) elected by the people and composed of two councillors from each parish. The police force is a military organization under the control of the national executive, and the higher municipal courts are subject to the same authority. Every ratepayer, whether foreigner or native, has the right to vote in municipal elections and to serve in the municipal council.

The water-supply is drawn from the estuary at Belgrano and conducted 33 m. to the Recoleta, where three great settling basins, with an aggregate capacity of 12,000,000 gallons, and six acres of covered filters, are located. It is then pumped to the great distributing reservoir at Calles Córdoba and Viamonte, which covers four acres and has a capacity of 13,500,000 gallons. These works were begun in 1873. Up to 1873, when the water and drainage works were initiated by English engineers and contractors, there were no public sewers, and the sanitary state of the city was indescribably bad. The cholera epidemic of 1867-1868, with 15,000 victims, and the yellow fever epidemic of 1871, with 26,000 victims, were greatly intensified by these insanitary conditions. The construction of the sewers lasted about 19 years, when in 1892 the water and drainage works were taken over by the government, and are now administered at public expense and at a profit. The main sewer is 16 m. long and extends southward beyond Quilmes. The total cost of the two systems exceeded six millions sterling. Buenos Aires is now provided with a good water-supply, and its sanitary condition compares favourably with that of other great cities, the annual death-rate being about 18 per thousand, against 27 per thousand in 1887. Its mean annual temperature is 64° Fahr., and its annual rainfall 34 in.

The lighting includes both gas and electricity, the former dating from 1856. Previously to that time street lighting had been effected at first with lamps burning mares' grease, and then with tallow candles. The streets were at first paved with cobble-stones, then with dressed granite paving-stones (parallel-pipedons), and finally with wood and asphalt. The tram service is in the hands of nine private companies, operating 313 m. of track (31st of December 1905), on almost five-sevenths of which electric traction is employed. The city is the principal terminus and port for nearly all the trunk railway lines of the republic, which have large passenger stations at the Retiro, Once de Setiembre, and Constitución plazas, and are connected with the central produce market and the new Madero port. The great central produce market at Barracas al Sud (*Mercado Central de Frutos*), whose lands, buildings, railway sidings, machinery and mole cost £750,000, is designed to handle the pastoral and agricultural products of the country on a large scale, while 20 markets in the city meet the needs of local consumers.

The most important feature of the port of Buenos Aires is the "Madero docks," constructed to enlarge and improve its shipping facilities. Improvements had been begun in 1872 at the "Boca," as the port on the Riachuelo is called, and nearly £1,500,000 was spent there in landing facilities and dredging a channel 12 m. in length, to deep water. These improvements were found insufficient, and in 1887 work was begun on plans executed by Sir John Hawkshaw for a series of four docks and two basins in front of the city, occupying 3 m. of reclaimed shore-line, and connected with deep water by two dredged channels. The north basin is provided with two dry docks, and the new quays are equipped with 24 warehouses, hydraulic cranes, and 28 m. of railway sidings and connexions. The total cost of the new port works

up to 1908 was about £8,000,000 sterling (\$40,000,000 gold). In September of that year it was decided by congress to borrow £5,000,000 for still further extensions which were found to be required. The channels to deep water require constant dredging because of the great quantity of silt deposited by the river, and on this and allied purposes an expenditure of £560,000 was voted in 1908. In 1907 there were 29,178 shipping entries in the port, with an aggregate of 13,335,737 tons, the merchandise movement being 4,360,000 tons imports and 2,900,000 tons of produce exports. The revenues for 1907 were \$5,452,000 gold, and working expenses, \$2,213,000 gold, the profit (\$3,229,000) being equal to about 8% on the cost of construction.

History.—Three attempts were made to establish a colony where the city of Buenos Aires stands. The first was in 1535 by Don Pedro de Mendoza with a large and well-equipped expedition from Spain, which, through mismanagement and the hostility of the Indians, resulted in complete failure. An expedition sent up the river by Mendoza founded Asunción, and thither went the colonists from his "Santa Maria de Buenos Ayres" when that settlement was abandoned. The second was in 1542 by a part of the expedition from Spain under Cabeza de Vaca, but with as little success. The third was in 1580 by Don Juan de Garay, governor of Paraguay, who had already established a half-way post at Santa Fé in 1573, and from this attempt dates the foundation of the city. The need of a port near the sea, where supplies from Spain could be received and ships provisioned, was keenly felt by the Spanish colonists at Asunción, and Garay's expedition down the Paraná in 1580 had that special object in view. Garay built a fort and laid out a town in the prescribed Spanish style above Mendoza's abandoned settlement, giving it the name of "Ciudad de la Santissima Trinidad," but retaining Mendoza's descriptive name for the port in appreciation of the agreeable and invigorating atmosphere of that locality. Buenos Aires remained a dependency of Asunción until 1620, when the Spanish settlements of the La Plata region were divided into three provinces, Paraguay, Tucuman and Buenos Aires, and Garay's "city" became the capital of the latter and also the seat of a new bishopric. The increasing population and trade of the La Plata settlements naturally contributed to the importance and prosperity of Buenos Aires, but Spain seems to have taken very little interest in the town at that time. Peru still dazzled the imagination with her stores of gold and silver, and the king and his councillors and merchants had no thought for the little trading station on the La Plata, for which one small shipment of supplies each year was at first thought sufficient. The proximity of the Portuguese settlements of Brazil and the unprotected state of the coast, however, made smuggling easy, and the colonists soon learned to supply their own needs in that way. The heavy seigniorage tax on gold and silver, and the costs of transportation by way of Panama, also sent a stream of contraband metal from Charcas to Buenos Aires, where it found eager buyers among the Portuguese traders from Brazil, who even founded the town of Colonia on the opposite bank of the estuary to facilitate their hazardous traffic. In time the magnitude of these operations attracted attention at Madrid and efforts were made to suppress them, but without complete success until more liberal provisions were made to promote trade between Spain and her colonies. In 1776 the Rio de la Plata provinces were erected into a viceroyalty, and Buenos Aires became its capital. Two years later the old commercial restrictions were abolished and a new code was promulgated, so liberal in character compared with the old that it was called the "free trade regulations." Under the old system all intercourse with foreign countries had been prohibited, with the exception of Great Britain and Portugal—the former having a contract (1715 to 1730) to introduce African slaves, and permission to send one shipload of merchandise each year to certain colonial ports, and the latter's Brazilian colonies having permission to import from Buenos Aires each year 2000 fanegas of wheat, 500 quintals of jerked beef and 500 of tallow. The African slaves introduced into Buenos Aires in this way were limited to 800 a year, and were the only slaves of that character ever received except some from Brazil after 1778, when greater

commercial activity in the port created a sudden demand for labourers. Under the new regulations of ports in Spain and in the colonies were declared *puertos habilitados*, or ports of entry, and trade between them was permitted, though under many restrictions. The effect of this change may be seen in the exportation of hides to the mother country, which had been only 150,000 a year before 1778, but rose to 700,000 and 800,000 a year after that date. (For the later history of the city see ARGENTINA.)

(A. J. L.)

BUFF (from Fr. *buffle*, a buffalo), a leather originally made from the skin of the buffalo, now also from the skins of other animals, of a dull pale yellow colour, used for making the buff-coat or jerkin, a leathern military coat. The old 3rd Foot regiment of the line in the British army (now the East Kent Regiment), and the old 78th Foot (now 2nd battalion Seaforth Highlanders), are called the "Buffs" and the "Ross-shire Buffs" respectively, from the yellow or buff-colour of their facings. The term is commonly used now of the colour alone.

BUFFALO, a city and port of entry, and the county-seat of Erie county, New York, U.S.A., the second city in population in the state, and the eighth in the United States, at the E. extremity of Lake Erie, and at the upper end of the Niagara river; distant by rail from New York City 423 m., from Boston 499 m., and from Chicago 540 m.

The site of the city, which has an area of 42 sq. m., is a broad, undulating tract, rising gradually from the lake to an elevation of from 50 to 80 ft., its altitude averaging somewhat less than 600 ft. above sea-level. The high land and temperate climate, and the excellent drainage and water-supply systems, make Buffalo one of the most healthy cities in the United States, its death-rate in 1900 being 14.8 per thousand, and in 1907 15.58. As originally platted by Joseph Ellicott, the plan of Buffalo somewhat resembled that of Washington, but the plan was much altered and even then not adhered to. Buffalo to-day has broad and spacious streets, most of which are lined by trees, and many small parks and squares. The municipal park system is one of unusual beauty, consisting of a chain of parks with a total area of about 1030 acres, encircling the city and connected by boulevards and driveways. The largest is Delaware Park, about 365 acres, including a lake of 464 acres, in the north part of the city; the north part of the park was enclosed in the grounds of the Pan-American Exposition of 1901. Adjoining it is the Forest Lawn cemetery, in which are monuments to President Millard Fillmore, and to the famous Seneca chief Red Jacket (1751-1830), a friend of the whites, who was faithful when approached by Tecumseh and the Prophet, and warned the Americans of their danger; by many he has been considered the greatest orator of his race. Among the other parks are Cazenovia Park, Humboldt Park, South Park on the Lake Shore, and "The Front" on a bluff overlooking the source of the Niagara river; in the last is Fort Porter (named in honour of Peter B. Porter), where the United States government maintains a garrison.

Principal Buildings.—Buffalo is widely known for the beauty of its residential sections, the houses being for the most part detached, set well back from the street, and surrounded by attractive lawns. Among the principal buildings are the Federal building, erected at a cost of \$2,000,000; the city and county hall, cost \$1,500,000, with a clock tower 245 ft. high; the city convention hall, the chamber of commerce, the builders' exchange, the Masonic temple, two state armouries, the Prudential, Fidelity Trust, White and Mutual Life buildings, the Teck, Star and Shea's Park theatres, and the Ellicott Square building, one of the largest office structures in the world; and, in Delaware Park, the Albright art gallery, and the Buffalo Historical Society building, which was originally the New York state building erected for the Pan-American Exposition held in 1901. Among the social clubs the Buffalo, the University, the Park, the Saturn and the Country clubs, and among the hotels the Iroquois, Lafayette, Niagara and Genesee, may be especially mentioned. There are many handsome churches, including St. Joseph's (Roman Catholic) and St. Paul's (Protestant Episcopal) cathedrals.

and Trinity (Protestant Episcopal), the Westminster Presbyterian, the Delaware Avenue Baptist, and the First Presbyterian churches.

Education.—In addition to the usual high and grammar schools, the city itself supports a city training school for teachers, and a system of night schools and kindergartens. Here, too, is a state normal school. The university of Buffalo (organized in 1845) comprises schools of medicine (1845), law (1887), dentistry (1892), and pharmacy (1886). Canisius College is a Roman Catholic (Jesuit) institution for men (established in 1870 and chartered in 1883), having in 1907 a college department and an academic (or high school) department, and a library of about 26,000 volumes. Martin Luther Seminary, established in 1854, is a theological seminary of the Evangelical Lutheran Church. Among the best-known schools are the Academy of the Sacred Heart, Buffalo Seminary, the Franklin and the Heathcote schools, Holy Angels and St Mary's academies, St Joseph's Collegiate Institute, and St Margaret's school for girls. The Buffalo public library, founded in 1837, is housed in a fine building erected in 1887 (valued at \$1,000,000), and contains about 300,000 books and pamphlets. Other important libraries, with the approximate number of their books, are the Grosvenor (founded in 1850), for reference (75,000 volumes and 7000 pamphlets); the John C. Lord, housed in the building of the Historical Society (10,620); the Law (8th judicial district) (17,000); the Catholic Institute (12,000); and the library of the Buffalo Historical Society (founded 1862) (26,600), now in the handsome building in Delaware Park used as the New York state building during the Pan-American Exposition of 1901. The Buffalo Society of Natural Sciences has a museum in the public library building.

Public Institutions.—The hospitals and the charitable and correctional institutions are numerous and are well administered. Many private institutions are richly endowed. Among the hospitals are a state hospital for the insane, the Erie county, the Buffalo general, the Children's, the United States marine (maintained by the Federal government), the German, the Homeopathic, the Women's, the German Deaconess and the Riverside hospitals, and the Buffalo hospital of the Sisters of Charity. Nurses' training schools are connected with most of these. Among the charitable institutions are the Home for the Friendless, the Buffalo, St Vincent's and St Joseph's orphan asylums, St John's orphan home, St Mary's asylum for widows and foundlings, and the Ingleside home for erring women. One of the most noteworthy institutions in the city is the Charity Organization Society, with headquarters in Fitch Institute. Founded in 1877, it was the first in the United States, and its manifold activities have not only contributed much to the amelioration of social conditions in Buffalo, but have caused it to be looked to as a model upon which similar institutions have been founded elsewhere.

The first newspaper, the *Gazette* (a weekly), was established in 1811 and became the *Commercial*, a daily, in 1835. The first daily was the *Courier*, established in 1831. There were in 1908 eleven daily papers published, three of which were in German and two in Polish. The weekly papers include several in German, three in Polish, and one in Italian.

Government and Population.—Buffalo is governed under an amended city charter of 1896 by which the government is vested in a bicameral city council, and a mayor elected for a term of four years. The mayor appoints the heads of the principal executive departments (health, civil service, parks, police and fire). The city clerk is elected by the city council. The municipality maintains several well-equipped public baths, and owns its water-supply system, the water being obtained from Lake Erie. The city is lighted by electricity generated by the water power of Niagara Falls, and by manufactured gas. Gas, obtained by pipe lines from the Ohio-Pennsylvania and the Canadian (Welland) natural gas fields, is also used extensively for lighting and heating purposes.

From the first census enumeration in 1820 the population has steadily and rapidly increased from about 2000 till it reached 352,387 inhabitants in 1900, and 423,715 (20% increase) in 1910.

In 1900 there were 248,135 native-born and 104,252 foreign-born; 350,586 were white and only 1801 coloured, of whom 1068 were negroes. Of the native-born whites, 155,716 had either one or both parents foreign-born; and of the total population 93,256 were of unmixed German parentage. Of the foreign-born population 36,720 were German, the other large elements in their order of importance being Polish, Canadian, Irish, the British (other than Irish). Various sections of the poorer part of the city are occupied almost exclusively by the immigrants from Poland, Hungary and Italy.

Communications and Commerce.—Situated almost equidistant from Chicago, Boston and New York, Buffalo, by reason of its favourable location in respect to lake transportation and its position on the principal northern trade route between the East and West, has become one of the most important commercial and industrial centres in the Union. Some fourteen trunk lines have terminals at, or pass through, Buffalo. Tracks of a belt line transfer company encircle the city, and altogether there are more than 500 m. of track within the limits of Buffalo. Of great importance also is the lake commerce. Almost all the great steamship transportation lines of the Great Lakes have an eastern terminus at Buffalo, which thus has direct passenger and freight connexion with Cleveland, Detroit, Chicago, Milwaukee and the "Head of the Lakes" (Duluth-Superior). With the latter port it is connected by the Great Northern Steamship Company, a subsidiary line of the Great Northern railway, the passenger service of which is carried on by what are probably the largest and finest inland passenger steamships in existence. The tonnage of the port of Buffalo is considerably more than 5,000,000 tons annually. With a water front of approximately 20 m. and with 8 to 10 m. of wharfs, the shipping facilities have been greatly increased by the extensive harbour improvements undertaken by the Federal government. These improvements comprise a series of inner breakwaters and piers and an outer breakwater of stone and cement, 4 m. in length, constructed at a cost of more than \$2,000,000. Another artery of trade of great importance is the Erie Canal, which here has its western terminus, and whose completion (1825) gave the first impetus to Buffalo's commercial growth. With the Canadian shore Buffalo is connected by ferry, and by the International bridge (from Squaw Island), which cost \$1,500,000 and was completed in 1873.

It is as a distributing centre for the manufactured products of the East to the West, and for the raw products of the West to the East, and for the trans-shipment from lake to rail and vice versa, that Buffalo occupies a position of greatest importance. It is one of the principal grain and flour markets in the world. Here in 1843 Joseph Dart erected the first grain elevator ever constructed. In 1906 the grain elevators had a capacity of between twenty and thirty millions of bushels, and annual receipts of more than 200,000,000 bushels. The receipts of flour approximate 10,000,000 barrels yearly. More than 10,000,000 head of live stock are handled in a year in extensive stock-yards (75 acres) at East Buffalo; and the horse market is the largest in America. Other important articles of commerce are lumber, the receipts of which average 200,000,000 ft. per annum; fish (15,000,000 lb annually); and iron ore and coal, part of which, however, is handled at Tonawanda, really a part of the port of Buffalo. Buffalo is the port of entry of Buffalo Creek customs district; in 1908 its imports were valued at \$6,708,919, and its exports at \$26,192,563.

Manufactures.—As a manufacturing centre Buffalo ranks next to New York among the cities of the state. The manufactures were valued in 1900 at \$122,230,061 (of which \$105,627,182 was the value of the factory product), an increase of 22.2% over 1890; value of factory product in 1905, \$147,377,873. The value of the principal products in 1900 was as follows: slaughtering and meat packing, \$9,631,187 (in 1905 slaughtering and meat-packing \$12,216,433, and slaughtering, not including meat-packing, \$3,919,940); foundry and machine shop products, \$6,816,057 (1905, \$11,402,855); linseed oil, \$6,271,170; cars and shop construction, \$4,513,333 (1905, \$3,609,471); malt liquors, \$4,269,973 (1905, \$5,187,216); soap and candles, \$3,818,571 (in 1905, soap

\$4,792,915); flour and grist mill products, \$3,263,697 (1905, \$9,807,906); lumber and planing mill products, \$3,095,760 (1905, \$4,286,668); clothing, \$3,246,723 (1905, \$4,231,126); iron and steel products, \$2,624,547. Other industrial establishments of importance include petroleum refineries, ship-yards, brick, stone and lime works, saddlery and harness factories, lithographing establishments, patent medicine works, chemical works, and copper smelters and refineries. Some of the plants are among the largest in existence, notably the Union and the Wagner Palace car works, the Union dry docks, the steel plants of the Lackawanna Iron and Steel Company, and the Larkin soap factory.

History.—The first white men to visit the site of Buffalo were undoubtedly the adventurous French trappers and various Jesuit missionaries. Near here, on the east bank of the Niagara river at the mouth of Cayuga Creek, La Salle in 1679 built his ship the "Griffin," and at the mouth of the river built Fort Conti, which, however, was burned in the same year. In 1687 marquis de Denonville built at the mouth of the river a fort which was named in his honour and was the predecessor of the fortifications on or near the same site successively called Fort Niagara; and the neighbourhood was the scene of military operations up to the close of the War of Independence. As early as 1784 the present site of the city of Buffalo came to be known as "the Buffalo Creek region" either from the herds of buffalo or bison which, according to Indian tradition, had frequented the salt licks of the creek, or more probably from an Indian chief. A little later, possibly in 1788-1789, Cornelius Winney, an Indian trader, built a cabin near the mouth of the creek and thus became the first permanent white resident. Slowly other settlers gathered. The land was a part of the original Phelps-Gorham Purchase, and subsequently (about 1793) came into the possession of the Holland Land Company, being part of the tract known as the Holland Purchase. Joseph Elliott, the agent of the company, who has been called the "Father of Buffalo," laid out a town in 1801-1802, calling it New Amsterdam, and by this name it was known on the company's books until about 1810. The name of Buffalo Creek or Buffalo, however, proved more popular; the village became the county-seat of Niagara county in 1808, and two years later the town of Buffalo was erected. Upon the outbreak of the second war with Great Britain, Buffalo and the region about Niagara Falls became a centre of active military operations; directly across the Niagara river was the British Fort Erie. It was from Buffalo that Lieutenant Jesse D. Elliott (1782-1845) made his brilliant capture of the "Detroit" and "Caledonia" in October 1812; and on the 30th and 31st of December 1813 the settlement was attacked, captured, sacked, and almost completely destroyed by a force of British, Canadians and Indians under General Sir Phineas Riall (c. 1769-1851). After the cessation of hostilities, however, Buffalo, which had been incorporated as a village in 1813, was rapidly rebuilt. Its advantages as a commercial centre were early recognized, and its importance was enhanced on the opening up of the middle West to settlement, when Buffalo became the principal gateway for the lake routes. Here in 1818 was rebuilt the "Walk-in-the-Water," the first steamboat upon the Great Lakes, named in honour of a famous Wyandot Indian chief. In 1825 the completion of the Erie Canal with its western terminus at Buffalo greatly increased the importance of the place, which now rapidly outstripped and soon absorbed Black Rock, a village adjoining it on the N., which had at one time threatened to be a dangerous rival. In 1832 Buffalo obtained a city charter, and Dr Ebenezer Johnson (1786-1849) was chosen the first mayor. In that year, and again in 1834, a cholera epidemic caused considerable loss of life. At Buffalo in 1848 met the Free-Soil convention that nominated Martin van Buren for the presidency and Charles Francis Adams for the vice-presidency. Grover Cleveland lived in Buffalo from 1855 until 1884, when he was elected president, and was mayor of Buffalo in 1882, when he was elected governor of New York state. The Pan-American Exposition, in celebration of the progress of the Western hemisphere in the nineteenth century, was held there (May 1-November 2, 1901). It was

during a reception in the Temple of Music on the Exposition grounds that President McKinley was assassinated (September 6th); he died at the home of John G. Milburn, the president of the Exposition. In the house of Ansley Wilcox here Vice-President Theodore Roosevelt took the oath of office as president. A marble shaft 80 ft. high, in memory of McKinley, has been erected in Niagara Square.

See William Ketchum, *History of Buffalo* (2 vols., Buffalo, 1864-1865); H. P. Smith, *History of Buffalo and Erie County* (Syracuse, 1884); *Publications of the Buffalo Historical Society* (Buffalo, 1879 et seq.); O. Turner, *History of the Holland Purchase* (Buffalo, 1890); T. H. Hotchkiss, *History of Western New York* (New York, 1841); and the sketch in Lyman P. Powell's *Historic Towns of the Middle States* (New York, 1901).

BUFFALO, a name properly pertaining to an aberrant species of cattle which has been kept in a state of domestication in India and Egypt from time immemorial, and had been introduced from the latter country into southern Europe. It is now taken, however, to include not only this species, whose native home is India, but all more or less nearly related animals.¹ Buffaloes are heavily built oxen, with sparsely haired skin, large ears, long, tufted tails, broad muzzles and massive angulated horns. In having only 13 pairs of ribs they resemble the typical ox. African buffaloes all have the hair of the back directed backwards.

In the Cape buffalo, *Bos (Bubalus) caffer*, the horns do not attain an excessive length, but in old bulls are so expanded and thickened at the base as to form a helmet-like mass protecting the whole forehead. Several more or less nearly allied local races have been named; and in Eastern Africa the buffaloes (*B. caffer acuminatilis*) have smaller horns, which do not meet in the middle line. From this animal, which is brown instead of black, there seems to be a transition towards the red dwarf buffalo (*B. nanus*) of West Africa, an animal scarcely more than two-thirds the size of its gigantic southern cousin, with relatively small, much flattened, upwardly curved horns. In South Africa buffaloes frequent reedy swamps, where they associate in herds of from fifty to a hundred or more individuals. Old bulls may be met with either alone or in small parties of from two or three to eight or ten. This buffalo formerly roamed in herds over the plains of Central and Southern Africa, always in the near vicinity of water, but the numbers are greatly diminished. In Cape Colony some herds are protected by the government in the eastern forest-districts. This species has never been domesticated, nor does there appear to have been any attempt to reduce it to service. Like its Indian ally it is fond of water, which it visits at regular intervals during the twenty-four hours; it also plants itself with mud, which, when hardened by the sun, protects it from the bite of the gadflies which in spite of its thick hide seem to cause it considerable annoyance. It is relieved of a portion of the parasitic ticks, so common on the hides of thick-skinned animals, by means of the red-beaked rhinoceros birds, *Buphaga erythrorhynchos*, a dozen or more of which may be seen partly perched on its horns and partly moving about on its back, and picking up the ticks on which they feed. The hunter is often guided by these birds in his search for the buffalo, but oftener still they give timely warning to their host of the dangerous proximity of the hunter, and have thus earned the title of "the buffalo's guardian birds."

In a wild state the typical Indian buffalo, *Bos (Bubalus) bubalis*, seems to be restricted to India and Ceylon, although some of the buffaloes found in the Malay Peninsula and Islands probably represent local races. The species has been introduced into Asia Minor, Egypt, Italy and elsewhere. The large size and wide separation of the horns, as well as the less thickly fringed ears, and the more elongated and narrow head, form marked points of distinction between the Asiatic and South African species. Moreover, all Asiatic buffaloes are distinguished from the African forms by having the hair on the fore-part of the back directed forwards; and these go far to support the view of those who would make them the types of a distinct subgenus.

¹ In America, it is worth noting, the term "buffalo" is almost universally taken, at all events in popular parlance, to designate the American bison, for which see BISON.

or genus, *Buffelus*. In Assam there formerly existed a local race, *B. bubalis macrocerus*, characterized by the horns, which are of immense size, being directed mainly outwards, instead of curving upwards in a circular form. Another Assam race (*B. bubalis fulvus*) is characterized by the tawny, in place of black, colour of its hair and hide. The haunts of the Indian buffalo are the grass-jungles near swamps, in which the grass exceeds 20 ft. in height. Here the buffaloes—like the Indian rhinoceros—form covered pathways, in which they are completely concealed. The herds frequently include fifty or more individuals. These animals are fond of passing the day in marshes, where they love to wallow in the mud; they are by no means shy, and do much harm to the crops. The rutting-season occurs in autumn, when several females follow a single male, forming for the time a small herd. The period of gestation lasts for ten months, and the female produces one or two calves at a birth. The bull is capable, it is said, of overthrowing an elephant, and generally more than a match even for the tiger, which usually declines the combat when not impelled by hunger. The Indian driver of a herd of tame buffaloes does not shrink from entering a tiger-frequented jungle, his cattle, with their massive horns, making short work of any tiger that may come in their way. Buffalo fights and fights between buffaloes and tigers were recognized Indian sports in the old days. Domesticated buffaloes differ from their wild brethren merely by their inferior size and smaller horns; some of the latter being of the circular and others of the straight type. The milk is good and nourishing, but of a roppy consistency and a peculiar flavour.

The tamarao, or Philippine buffalo, *Bos (Bubalus) mindorensis*, is a smaller animal, in many respects intermediate between the Indian buffalo and the dwarf anoa, or Celebes buffalo (*B. depressicornis*). (R. L.*)

BUFFET, LOUIS JOSEPH (1813-1898), French statesman, was born at Mirecourt. After the revolution of February 1848 he was elected deputy for the department of the Vosges, and in the Assembly sat on the right, pronouncing for the repression of the insurrection of June 1848 and for Louis Napoleon Bonaparte. He was minister of agriculture from August to December 1849 and from August to October 1851. Re-elected deputy in 1863, he was one of the supporters of the "Liberal Empire" of *Emile Ollivier*, being finance minister in *Ollivier's* cabinet from January to the 10th of April 1870. He was president of the National Assembly from the 4th of April 1872 to the 10th of March 1875, and minister of the interior in 1875. Then, elected senator for life (1876), he pronounced himself in favour of the *coup d'état* of the 16th of May 1877. Buffet had some oratorical talent, but shone most in opposition.

BUFFET, a piece of furniture which may be open or closed, or partly open and partly closed, for the reception of dishes, china, glass and plate. The word may also signify a long counter at which one stands to eat and drink, as at a restaurant, or—which would appear to be the original meaning—the room in which the counter stands. The word, like the thing it represents, is French. The buffet is the descendant of the credence, and the ancestor of the sideboard, and consequently has a close affinity to the dresser. Few articles of furniture, while preserving their original purpose, have varied more widely in form. In the beginning the buffet was a tiny apartment, or recess, little larger than a cupboard, separated from the room which it served either by a breast-high balustrade or by pillars. It developed into a definite piece of furniture, varying from simplicity to splendour, but always provided with one or more flat spaces, or broad shelves, for the reception of such necessities of the dining-room as were not placed upon the table. The early buffets were sometimes carved with the utmost elaboration; the Renaissance did much to vary their form and refine their ornament. Often the lower part contained receptacles as in the characteristic English court-cupboard. The rage for collecting china in the middle of the 18th century was responsible for a new form—the high glazed back, fitted with shelves, for the display of fine pieces of crockery-ware. This, however, was hardly a true buffet, and was the very antithesis of the

primary arrangement, in which the huge goblets and beakers and fantastic pieces of plate, of which so extremely few examples are left, were displayed upon the open "gradines." The tiers of shelves, with or without a glass front, which are still often found in Georgian houses, were sometimes called buffets—in short, any dining-room receptacle for articles that were not immediately wanted came at last to bear the name. In France the variations of type were even more numerous than in England, and it is sometimes difficult to distinguish a commode from a buffet. In the latter part of the 18th century the buffet occasionally took the form of a console table.

BUFFIER, CLAUDE (1661-1737), French philosopher, historian and educationalist, was born in Poland, on the 25th of May 1661, of French parents, who returned to France, and settled at Rouen, soon after his birth. He was educated at the Jesuit college there, and was received into the order at the age of nineteen. A dispute with the archbishop compelled him to leave Rouen, and after a short stay in Rome he returned to Paris to the college of the Jesuits, where he spent the rest of his life. He seems to have been an admirable teacher, with a great power of lucid exposition. His object in the *Traité des vérités premières* (1717), his best-known work, is to discover the ultimate principle of knowledge. This he finds in the sense we have of our own existence and of what we feel within ourselves. He thus takes substantially the same ground as Descartes, but he rejected the *a priori* method. In order to know what exists distinct from the self, "common sense" is necessary. Common sense he defined as "that disposition which nature has placed in all or most men, in order to enable them, when they have arrived at the age and use of reason, to form a common and uniform judgment with respect to objects different from the internal sentiment of their own perception, which judgment is not the consequence of any anterior judgment." The truths which this "disposition of nature" obliges us to accept can be neither proved nor disproved; they are practically followed even by those who reject them speculatively. But Buffier does not claim for these truths of "common sense" the absolute certainty which characterizes the knowledge we have of our own existence or the logical deductions we make from our thoughts; they possess merely the highest probability, and the man who rejects them is to be considered a fool, though he is not guilty of a contradiction. Buffier's aversion to scholastic refinements has given to his writings an appearance of shallowness and want of metaphysical insight, and unquestionably he failed entirely even to indicate the nature of that universality and necessity which he ascribed to his "eternal verities"; he was, however, one of the earliest to recognize the psychological as distinguished from the metaphysical side of Descartes's principle, and to use it, with no inconsiderable skill, as the basis of an analysis of the human mind, similar to that enjoined by Locke. In this he has anticipated the spirit and method as well as many of the results of Reid and the Scottish school. Voltaire described him as "the only Jesuit who has given a reasonable system of philosophy."

He wrote also *Éléments de métaphysique* (1724), a "French Grammar on a new plan," and a number of historical essays. Most of his works appeared in a collected form in 1732, and an English translation of the *Traité* was published in 1780.

BUFFON, GEORGE LOUIS LECLERC, COMTE DE (1707-1788), French naturalist, was born on the 7th of September 1707, at Montbard (Côte d'Or), his father, Benjamin François Leclerc de Buffon (1683-1775), being councillor of the Burgundian parlement. He studied law at the college of Jesuits at Dijon; but he soon exhibited a marked predilection for the study of the physical sciences, and more particularly for mathematics. Whilst at Dijon he made the acquaintance of a young Englishman, Lord Kingston, and with him travelled through Italy and then went to England. He published a French translation of Stephen Hales's *Vegetable Statics* in 1735, and of Sir I. Newton's *Fluxions* in 1740. At twenty-five years of age he succeeded to a considerable property, inherited from his mother, and from this time onward his life was devoted to regular scientific labour. At first he directed his attention more especially to mathematics, physics,

and agriculture, and his chief original papers are connected with these subjects. In the spring of 1739 he was elected an associate of the Academy of Sciences; and at a later period of the same year he was appointed keeper of the Jardin du Roi and of the Royal Museum. This appears to have finally determined him to devote himself to the biological sciences in particular, and he began to collect materials for his *Natural History*. In the preparation of this voluminous work he associated with himself L. J. M. Daubenton, to whom the descriptive and anatomical portions of the treatise were entrusted, and the first three volumes made their appearance in the year 1749. In 1752 (not in 1743 or 1760, as sometimes stated) he married Marie Françoise de Saint-Belin. He seems to have been fondly attached to her, and felt deeply her death at Montbard in 1769. The remainder of Buffon's life as a private individual presents nothing of special interest. He belonged to a very long-lived race, his father having attained the age of ninety-three, and his grandfather eighty-seven. He himself died at Paris on the 15th of April 1788, at the age of eighty-one, of vesical calculus, having refused to allow any operation for his relief. He left one son, George Louis Marie Leclerc Buffon, who was an officer in the French army, and who died by the guillotine, at the age of thirty, on the 10th of July 1793 (22 Messidor, An II.), having espoused the party of the duke of Orleans.

Buffon was a member of the French Academy (his inaugural address being the celebrated *Discours sur le style*, 1753), perpetual treasurer of the Academy of Sciences, fellow of the Royal Society of London, and member of the Academies of Berlin, St Petersburg, Dijon, and of most of the learned societies then existing in Europe. Of handsome person and noble presence, endowed with many of the external gifts of nature, and rejoicing in the social advantages of high rank and large possessions, he is mainly known by his published scientific writings. Without being a profound original investigator, he possessed the art of expressing his ideas in a clear and generally attractive form. His chief defects as a scientific writer are that he was given to excessive and hasty generalization, so that his hypotheses, however seemingly brilliant, are often destitute of any sufficient basis in observed facts, whilst his literary style is not unfrequently theatrical and turgid, and a great want of method and order is commonly observable in his writings.

His great work is the *Histoire naturelle, générale et particulière*; and it can undoubtedly claim the merit of having been the first work to present the previously isolated and apparently disconnected facts of natural history in a popular and generally intelligible form. The sensation which was made by its appearance in successive parts was very great, and it certainly effected much good in its time by generally diffusing a taste for the study of nature. For a work so vast, however—aiming, as it did, at being little less than a general encyclopaedia of the sciences—Buffon's capacities may, without disparagement, be said to have been insufficient, as is shown by the great weakness of parts of the work (such as those relating to mineralogy). The *Histoire naturelle* passed through several editions, and was translated into various languages. The edition most highly prized by collectors, on account of the beauty of its plates, is the first, which was published in Paris (1749–1804) in forty-four quarto volumes, the publication extending over more than fifty years. In the preparation of the first fifteen volumes of this edition (1749–1767) Buffon was assisted by Daubenton, and subsequently by P. Guéneau de Montbéliard, the abbé G. L. C. A. Bexon, and C. N. S. Sonnini de Manoncourt. The following seven volumes form a supplement to the preceding, and appeared in 1774–1789, the famous *Époques de la nature* (1779) being the fifth of them. They were succeeded by nine volumes on the birds (1770–1783), and these again by five volumes on minerals (1783–1788). The remaining eight volumes, which complete this edition, appeared after Buffon's death, and comprise reptiles, fishes and cetaceans. They were executed by B. G. E. de Lacépède, and were published in successive volumes between 1788 and 1804. A second edition begun in 1774 and completed in 1804, in thirty-six volumes quarto, is in most respects similar to the first, except that the

anatomical descriptions are suppressed and the supplement recast.

See Humbert-Bazile, *Buffon, sa famille, &c.* (1863); M. J. P. Flourens, *Hist. des travaux et des idées de Buffon* (1844, 3rd ed., 1870); H. Nadault de Buffon, *Correspondance de Buffon* (1860); A. S. Packard, *Lamarck* (1901).

BUG, the name of two rivers of Europe. (1) A stream of European Russia, distinguished sometimes as the Southern Bug, which rises in the S. of the government of Volhynia, and flows generally S.E. through the governments of Podolia and Kherson, and after picking up the Ingul from the left at Nikolayev, enters the *liman* or lagoon into which the Dniester also discharges. Its length is 470 m. Its upper part is beset with rapids, and its lower is of little value for navigation on account of the numerous sandbanks and blocks of rock which choke its bed. (2) A river distinguished as the Western Don, which rises in the E. of Austrian Galicia between Tamopol and Brody, and flows N.N.W. as far as Brest-Litovsk, separating the Polish provinces of Lublin and Siedlce from the Russian governments of Volhynia and Grodno; it then swings away almost due W., through the provinces of Warsaw and Lomza, and joins the Vistula, 23 m. below the city of Warsaw. Length, 470 m. It is navigable from Brest-Litovsk downwards.

BUG, the common name for hemipterous insects of the family *Cimicidae*, of which the best-known example is the house bug or bed bug (*Cimex lectularius*). This disgusting insect is of an oval shape, of a rusty red colour, and, in common with the whole tribe to which it belongs, gives off an offensive odour when touched; unlike the others, however, it is wingless. The bug is provided with a proboscis, which when at rest lies along the inferior side of the thorax, and through which it sucks the blood of man, the sole food of this species. It is nocturnal in its habits, remaining concealed by day in crevices of bed furniture, among the hangings, or behind the wall paper, and shows considerable activity in its nightly raids in search of food. The female deposits her eggs at the beginning of summer in crevices of wood and other retired situations, and in three weeks the young emerge as small, white, and almost transparent larvae. These change their skin very frequently during growth, and attain full development in about eleven weeks. Two centuries ago the bed bug was a rare insect in Britain, and probably owes its name, which is derived from a Celtic word signifying "ghost" or "goblin," to the terror which its attacks at first inspired. An allied species, the dove-cote bug (*Cimex columbaria*), attacks domestic fowls and pigeons.

BUGEAUD DE LA PICONNERIE, THOMAS ROBERT, CCXXI of ISLY (1784–1849), marshal of France, was born at Limoges on the 15th of October 1784. He came of a noble family of Périgord, and was the youngest of his parents' thirteen children. Harsh treatment led to his flight from home, and for some years about 1800 he lived in the country, engaged in agriculture, to which he was ever afterwards devoted. At the age of twenty he became a private soldier in the *Vétiles* of the Imperial Guard (1804), with which he took part in the Austerlitz campaign of the following year. Early in 1806 he was given a commission, and as a sub-lieutenant he served in the Jena and Eylau campaigns, winning his promotion to the rank of lieutenant at Pultusk (December 1806). In 1808 he was in the first French corps which entered Spain, and was stationed in Madrid during the revolt of the *Dos Mayo*. At the second siege of Saragossa he won further promotion to the rank of captain, and in 1809–1810 found opportunities for winning distinction under General (Marshal) Suchet in the eastern theatre of the Peninsular War, in which he rose to the rank of major and the command of a full regiment. At the first restoration he was made a colonel, but he rejoined Napoleon during the Hundred Days, and under his old chief Suchet distinguished himself greatly in the war in the Alps. For fifteen years after the fall of Napoleon he was not re-employed, and during this time he displayed great activity in agriculture and in the general development of his district of Périgord. The July revolution of 1830 reaped his military career, and after a short tenure of a regimental command he was in 1831 made a *maréchal de camp*. In the chamber

of deputies, to which he was elected in the same year, he showed himself to be an inflexible opponent of democracy, and in his military capacity he was noted for his severity in police work and the suppression of *émutes*. His conduct as gaoler of the duc de Berry led to a duel between Bugeaud and the deputy Dulong, in which the latter was killed (1834); this affair and the incidents of another *émute* exposed Bugeaud to ceaseless attacks in the Chamber and in the press, but his opinion was sought by all parties in matters connected with agriculture and industrial development. He was re-elected in 1834, 1837 and 1839.

About this time Bugeaud became much interested in the question of Algeria. At first he appears to have disapproved of the conquest, but his undeviating adherence to Louis Philippe brought him into agreement with the government, and with his customary decision he proposed to employ at once whatever forces were necessary for the swift, complete and lasting subjugation of Algeria. Later events proved the soundness of his views; in the meantime Bugeaud was sent to Africa in a subordinate capacity, and proceeded without delay to initiate his war of flying columns. He won his first victory on the 7th of July 1836, made a brilliant campaign of six weeks' duration, and returned home with the rank of lieutenant-general. In the following year he signed the treaty of Tafna (June 1st, 1837), with Abd-el-Kader, an act which, though justified by the military and political situation, led to a renewal of the attacks upon him in the chamber, to the refutation of which Bugeaud devoted himself in 1839. Finally, in 1840, he was nominated governor-general of Algeria, and early in 1841 he put into force his system of flying columns. His swiftness and energy drove back the forces of Abd-el-Kader from place to place, while the devotion of the rank and file to "Père Bugeaud" enabled him to carry all before him in action. In 1842 he secured the French positions by undertaking the construction of roads. In 1843 Bugeaud was made marshal of France, and in this and the following year he continued his operations with unvarying success. His great victory of Isly on the 14th of August 1844 won for him the title of duke. In 1845, however, he had to take the field again in consequence of the disaster of Sidi Brahim (22nd of September 1845), and up to his final retirement from Algeria (July 1846) he was almost constantly employed in the field. His resignation was due to differences with the home government on the question of the future government of the province. Amidst his other activities he had found time to study the agricultural characteristics of the conquered country, and under his régime the number of French colonists had grown from 17,000 to 100,000. In 1848 the marshal was in Paris during the revolution, but his orders prevented him from acting effectually to suppress it. He was asked, but eventually refused, to be a candidate for the presidency in opposition to Louis Napoleon. His last public service was the command of the army of the Alps, formed in 1848-1849 to observe events in Italy. He died in Paris on the 10th of June 1849.

Bugeaud's writings were numerous, including his *Œuvres militaires*, collected by Weil (Paris, 1883), many official reports on Algeria and the war there, and some works on economics and political science. See Comte d'Iderville, *Le Maréchal Bugeaud* (Paris, 1881-1882).

BUGENHAGEN, JOHANN (1485-1558), surnamed POMERANUS, German Protestant reformer, was born at Wollin near Stettin on the 24th of June 1485. At the university of Greifswald he gained much distinction as a humanist, and in 1504 was appointed by the abbot of the Praemonstratensian monastery at Belbuck rector of the town school at Treptow. In 1509 he was ordained priest and became a vicar in the collegiate *Marienkirche* at Treptow; in 1517 he was appointed lecturer on the Bible and Church Fathers at the abbey school at Belbuck. In 1520 Luther's *De Captivitate Babilonica* converted him into a zealous supporter of the Reformer's views, to which he won over the abbot among others. In 1521 he went to Wittenberg, where he formed a close friendship with Luther and Melancthon, and in 1522 he married. He preached and lectured in the university, but his zeal and organizing skill soon spread his reforming

influence far beyond its limits. In 1528 he arranged the church affairs of Brunswick and Hamburg; in 1530 those of Lübeck and Pomerania. In 1537 he was invited to Denmark by Christian III., and remained five years in that country, organizing the church (though only a presbyter, he consecrated the new Danish bishops) and schools. He passed the remainder of his life at Wittenberg, braving the perils of war and persecution rather than desert the place dear to him as the home of the Reformation. He died on the 20th of April 1558. Among his numerous works is a history of Pomerania, which remained unpublished till 1728. Perhaps his best book is the *Interpretatio in Librum Psalmorum* (1523), and he is also remembered as having helped Luther in his translation of the Bible.

See Life by H. Hering (Halle, 1888); Emil Görigk, *Bugenhagen und die Protestantisierung Pommerns* (1895). O. Vogt published a collection of Bugenhagen's correspondence in 1888, and a supplement in 1890.

BUGGE, SOPHUS (1833-1907), Norwegian philologist, was born at Laurvik, Norway, on the 5th of January 1833. He was educated at Christiania, Copenhagen and Berlin, and in 1866 he became professor of comparative philology and Old Norse at Christiania University. In addition to collecting Norwegian folk-songs and traditions, and writing on Runic inscriptions, he made considerable contributions to the study of the Celtic, Romance, Oscean, Umbrian and Etruscan languages. He was the author of a very large number of books on philology and folklore. His principal work, a critical edition of the elder Edda (*Norrens Fornkvæði*), was published at Christiania in 1867. He maintained that the songs of the Edda and the earlier sagas were largely founded on Christian and Latin tradition imported into Scandinavian literature by way of England. His writings also include *Gamle Norske Folkeviser* (1858), a collection of Old Norse folk-songs; *Bidrag til den ældste skaldedigtningens historie* (Christiania, 1894); *Helge-digtene i den Ældre Edda* (Copenhagen, 1896, Eng. trans., *The Home of the Eddic Poems*, 1899); *Norsk Sagafortælling og Sagaskrivning i Island* (Christiania, 1901), and various books on Runic inscriptions. He died on the 8th of July 1907.

For a further list of his works see J. B. Halvorsen, *Norsk Forfatter-Lexikon*, vol. i. (Christiania, 1885).

BUGGY, a vehicle with either two (in England and India) or four wheels (in America). English buggies are generally hooded and for one horse. American buggies are for one horse or two, and either covered with a hood or open; among the varieties are the "Goddard" (the name of the inventor), the "box," so called from the shape of the body, the "cut under," *i.e.* cut out for the front wheels to cramp beneath and so turn in a narrow space, the "end-spring" and "side-bar," names referring to the style of hanging. A skeleton buggy, lightly constructed, is used on the American "speedways," built and maintained for fast driving. The word is of unknown origin; it may be connected with "bogie" (*q.v.*) a truck. The supposed Hindustani *baggi*, a gig, often given as the source, appears to be an invention or an adaptation into the vernacular of the English word.

BUGIS, or **BUCINS**, a people of Malayan stock, originally occupying only the kingdom of Boni in the south-western peninsula of the island of Celebes. From this district they spread over the whole island, and founded settlements throughout the whole Malay Archipelago. They are of middle size and robust, of very active, enterprising nature and of a complexion slightly lighter than the average Malay. In disposition they are brave, haughty and fierce, and are said to be more predisposed towards "running amuck" than any other Malaysians. They speak a language allied to that of the Macassars, and write it with similar characters. It has been studied, and its letters reproduced in type by Dr B. F. Mathes of the Netherlands Bible Society. The Bugis are industrious and ingenious; they practise agriculture more than the neighbouring tribes, and manufacture cotton-cloth not only for their own use but for export. They also carry on a considerable trade in the mineral and vegetable products of Boni, such as gold-dust, tortoise-shell, pearls, nut-megs and camphor. Their love of the sea has given them almost a monopoly of trade around Celebes. Their towns

are well built and they have schools of their own. The king is elected generally for life, and always from their own number, by the chiefs of the eight petty states that compose the confederation of Boni, and he cannot decide on any public measure without their consent. In some of the states the office of chief is hereditary; in others any member of the privileged classes may aspire to the dignity, and it not infrequently happens that the state is governed by a woman. The Bugis have been Mahomedans since the 17th century. Their original form of nature-worship had been much affected by Hindu influences, and even now they retain rites connected with the worship of Siva. See further BONI; CELEBES.

BUGLE, BUGLE-HORN, KEYS BUGLE, KENT BUGLE or REGENT'S BUGLE (Fr. *Bugle, Clairon, Cor à clefs; Bugle à clefs*; Ger. *Flügelhorn, Signalhorn, Bügelhorn, Klappenhorn, Kenhorn*; Ital. *Corna cromatica*), a treble brass wind instrument with cup-shaped mouthpiece and conical bore, used as a military duty and signal instrument. The bugle was originally, as its name denotes, a bull's horn,¹ of which it has preserved the characteristic conical bore of rapidly increasing diameter.

Those members of the brass wind such as the horns, bugle, trumpet and tubas, which, in their simplest form, consist of



FIG. 1.—Modern Service Bugle, British Army (Charles Mahillon).

tubes without lateral openings, depend for their scale on the harmonic series obtained by overblowing, *i.e.* by greater pressure of breath and by the increased tension of the lips, acting as reeds, across the mouth-piece. The harmonic series thus produced, which depends on the acoustic principles of the tube itself, and is absolutely uninfluenced by the manner in which the tube is bent, forms a natural subdivision in classifying these instruments:—(1) Those in which the lower harmonics from the second to the sixth or eighth are employed, such as the bugle, post-horn, the cornet à pistons, the trombone. (2) Those in which the higher harmonics from the third or fourth to the twelfth or sixteenth are mostly used, such as the French horn and trumpet. (3) Those which give out the fundamental tone and harmonics up to the eighth, such as the tubas and opficleide.

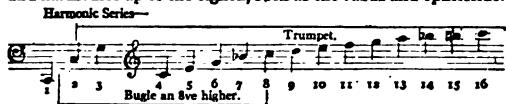

We thus find a fundamental difference between the trumpet and the bugle as regards the harmonic series. But although, to the casual beholder, these instruments may present a general similarity, there are other important structural distinctions. The tube of the trumpet is cylindrical, widening only at the bell, whereas that of the bugle, as stated above, is conical. Both instruments have cup-shaped mouthpieces outwardly similar. The peculiar shape of the basins, however, at the place where they open into the tube, angular in the trumpet and bevelled in the bugle, taken in conjunction with the bore of the main tube, gives to the trumpet its brilliant blaring tone, and to the bugle its more veiled but penetrating quality, characteristic of the whole family.³ Only five notes are required for the various bugle-calls, although the actual compass of the instrument consists of eight, of which the first or fundamental, however, being of poor quality, is never used. There are bugles in C and in E flat, but the bugle in B flat is most generally used; the key of C is used in notation.

¹ The word is derived from Lat. *buculus*, a young bull. "Bugle," meaning a long jet or black glass bead, used in trimming ladies' dresses, is possibly connected with the Ger. *Bügel*, a bent piece of metal. The English name "bugle" is also given to a common labiate plant, the *Ajuga reptans*, not to be confused with the "Bugloss" or *Anchusa officinalis*.

³ For diagrams of these mouthpieces see V. C. Mahillon, *Éléments d'acoustique* (Brussels, 1874), p. 96.

In order to increase the compass and musical possibilities of the bugle, two methods have been adopted, the use of (1) keys and (2) valves. The application of keys to the bugle produced the Kent bugle, and later the opficleide. The application of valves produced the family of saxhorns. The use of keys for wood wind instruments was known early in the 15th century,³ perhaps before. In 1438, the duke of Burgundy paid Hennequin Haulx, instrument-maker of Brussels, 4 ridders a piece for three tenor bombards with keys. In the 16th century we find a key applied to the bass fûte-à-bec⁴ and later to the large tenor cornetto.⁵ In 1770, a horn-player named Köbel, belonging to the imperial Russian band, experimented with keys on the trumpet, and in 1795 Weidinger of Vienna produced a trumpet with five keys. In 1810 Joseph Halliday, the bandmaster of the Cavan militia, patented the keyed bugle, with five keys and a compass of twenty-five notes, calling it the "Royal Kent Bugle" out of compliment to the duke of Kent, who was at the time commander-in-chief, and encouraged the introduction of the instrument into the regimental bands. A Royal Kent Bugle in C, stamped with Halliday's name as inventor, and made by P. Turton, 5 Wormwood Gate, Dublin, was exhibited by Col. Shaw-Hellier at the Royal Military Exhibition in 1890.⁶ The instrument measures 17 in., and the total length of the tubing, including the mouthpiece, 50½ in. The diameter at the mouthpiece is ½ in. and at the bell 5½ in. The instrument has a chromatic compass of two octaves.

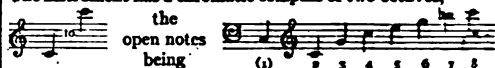

Mahillon (*op. cit.* p. 117) points out that the tonality of the key-bugle and kindred instruments is determined by the second harmonic given out by the open tube, the first key remaining open. To the original instrument specified in the patent, Halliday added a sixth key, which became the first and was in the normal position open; this key when closed gave B flat, with the same series of harmonics as the open tube. The series, however, becomes shorter with each successive key. Thus, on

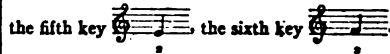
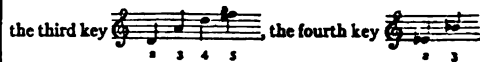
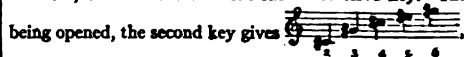

The bore of the instrument is just wide enough in proportion to its length to make possible the playing of the fundamental tones in the first two series, but these notes are never used, and the harmonics above the sixth are also avoided, being of doubtful intonation. In the opficleide, the bass of the key-bugle, the bore is sufficiently wide to produce the fundamentals of a satisfactory quality.

The keyed bugle was chiefly used in B flat, a crook for B flat being frequently added to the bugle in C; the soprano bugle in E flat was also much used in military bands.

The origin of the bugle, in common with that of the hunting horn, is of the highest antiquity. During the middle ages, the word "bugle" was applied to the ox and also to its horns, whether used as musical instruments or for drinking. The *New English Dictionary* quotes a definition of bugle dating from c. 1398: "The Bugle . . . is lyke to an oxe and is a fyrr

³ See E. van der Straeten, *La Musique aux Pays-bas*, vol. vii. p. 38, where the instrument is not mentioned as a novelty; also Léon, comte de Laborde, *Les Ducs de Bourgogne*, pt. ii. (*Præcis*), (Paris, 1849), tom. i. p. 365, No. 1266.

⁴ Martin Agricola, *Musica Instrumentalis deutsch* (Wittenberg, 1528), f. viii^r.

⁵ Michael Praetorius, *Synalagma Musicum* (Wolfenbüttel, 1618), pl. viii. No. 5.

⁶ See Captain C. R. Day, *Descript. Catalogue* (London, 1891), pp. 168-169, and pl. xi. fig. D.

beest."¹ In 1300 a romance² contains the word used in both acceptations, "A thousand bugles of Ynde," and "tweye bugle-hornes and a bowe." F. Godefroy³ gives quotations from early French which show that, as in England, the word bugle was frequently used as an adjective, and as a verb:—"III cors bugleres fist soner de rondon" (*Quatre fils Aymon*, ed. P. Tarbé, p. 32), and "I grant cor buglerenc fit en sa tor soner" (*Aiol*, 7457, *Société des anciens textes français*). Tubas, horns, cornets and bugles have as common archetype the horn of ram, bull or other animal, whose form was copied and modified in bronze, wood, brass, ivory, silver, &c. Of all these instruments, the bugle has in the highest degree retained the acoustic properties and the characteristic scale of the prototype, and is still put to the original use for giving military signals. The shofar of the ancient Hebrews, used at the siege of Jericho, was a cow's horn (Josh. vi. 4, 5, 8, 13, &c.), translated in the Vulgate *buccina*, in the paraphrase of the Chaldee *buccina ex cornu*. The directions given for sounding the trumpets of beaten silver described in Numbers 2. form the earliest code of signals yet known; the narrative shows that the Israelites had metal wind instruments; if, therefore, they retained the more primitive cow's horn and ram's horn (shofar), it was from choice, because they attached special significance to them in connexion with their ritual. The trumpet of silver mentioned above was the *Khatsotrah*, probably the long straight trumpet or tuba which also occurs among the instruments in the musical scenes of the ancient Egyptians and Assyrians. Gideon's use of a massed band of three hundred shofars to terrify and defeat the Midianites (Judges vii. 16), and Saul's call to arms (1 Sam. xiii. 3) show that the value of the shofar as a military instrument was well understood by the Jews. The cornu was used by the Roman infantry to sound the military calls, and Vegetius⁴ states that the tuba and buccina were also used for the same purpose. Mahillon possesses a facsimile of an ancient Etruscan cornu, the length of which is 1.40 in.; he gives its scale,⁵ pitched one tone below that of the bugle in E flat, as that of D flat, of which the harmonics



from the second to the sixth are available. The same department of the British Museum was enriched in 1904 with a terra-cotta model (fig. 2) of a late Roman bugle (c. 4th century A.D.), bent completely round upon itself to form a coil between the mouth-piece and the bell-end (the latter has been broken off). This precious relic was found at Ventoux in France and has been acquired from the collection of M. Morel. This is precisely the form of bugle now used as a badge by the first battalion of the King's Own Light Infantry.⁶ During the middle ages the use of the bugle-horn by knights and huntsmen, and perhaps also in naval warfare, was general in Europe, as the following additional quotations will show: "XXX cors bugleres, fait l'amirax soner" (*Conq. de Jerusalem*, 6811, Hippeau); "Two squyers blew . . . with ij grete bugles hornes" (Caxton, *Chron. Engl.*

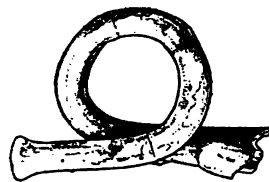

FIG. 2.—Terra Cotta Model of Roman Bugle, 4th cent. (British Museum).

¹ Barthol. Trevisa, *De Propri. Rebus*, xviii., xv., 1495. 774.
² *King Alisaunder*, 5112 and 5282.
³ *Dictionnaire de l'ancienne langue française du IX^e au XV^e siècle*.
⁴ *De re militari*, bk. iii. ch. v.
⁵ See *Catal. descriptif du musée instrumental du conservatoire de Bruxelles*, vol. i. (Ghent, 1880), p. 331. There are, in the department of Greek and Roman antiquities at the British Museum, two bronze Etruscan cornua, No. 2734, resembling the hunting horns of the middle ages and bent in a semicircular shape. They measure from end to end respectively 2 ft. 1 in. and 2 ft. 2 in.
⁶ Maj. J. H. L. Archer, *The British Army Records* (London, 1888), p. 402.

ccix. 192). The oliphant was a glorified bugle-horn made of rich material, such as ivory, carved and inlaid with designs in gold and silver.

The history of the bugle as a military instrument is in England closely connected with the creation of the light infantry, in which it gradually superseded the drum⁷ as a duty and signal instrument. It was during the 17th century that the change was inaugurated; improvements in firearms brought about the gradual abandonment of armour by the infantry, and the formation of the light infantry and the adoption of the bugle followed by degrees. One of the oldest light infantry regiments, Prince Albert's 1st Somerset Light Infantry, formed in 1685 by the earl of Huntingdon, employed a drummer at that date at a shilling per day.⁸ At the end of the 18th century we find the bugle the recognized signal instrument in the light infantry, while the trumpet remained that of the cavalry. The general order introducing the bugle as a minor badge for the light infantry is under date 28th of December 1814. In 1856 the popularity of the keyed or Royal Kent bugle in the army had reached its height. A bugle-band was formed in the Royal Artillery as a substitute for the drum and fife band.⁹ The organization and training of this bugle-band were entrusted to Trumpet-major James Lawson, who raised it to a very high standard of excellence. Major Lawson was a fine cornet player, and finding the scale of the service bugle too restricted he obtained permission to add to it a valve attachment, which made the bugle a chromatic instrument like the cornet, in fact practically a saxhorn. Before long, horns in E flat, tenor horns in B flat, euphoniums and bass tubas were added, all made of copper, and in 1869 the name of "bugle band" was changed to R.A. Brass Band, and in 1877 it was merged in the Mounted Band. The bugle with its double development by means of keys into Royal Kent bugle and ophicleide, and by means of valves into saxhorns and tubas, formed the nucleus of brass bands of all countries during the greater part of the 19th century. The Flügelhorn, as its name denotes, became the signal instrument of the infantry in Germany as in England, and still holds it own with the keyed bugle in the fine military bands of Austro-Hungary.

There is in the department of prehistoric antiquities at the British Museum a fine bugle-horn belonging to the Bronze Age in Denmark; the tube, which has an accentuated conical bore, is bent in a semi-circle, and has on the inner bend a series of little rings from which were probably suspended ornaments or cords. An engraved design runs spirally round the whole length of the tube, which is in an excellent state of preservation. Meyerbeer introduced the bugle in B flat in his opera *Robert-le-Diable* in the scene of the resurrection of the nuns, and a bugle in A in the fifth act.

See, for further information on the technique of the instrument, Logier's *Introduction to the Art of Playing on the Royal Kent Bugle* (London, Clementi, 1820); and for the use of the bugle in the French army, C. Kastner, *Le Manuel général de musique militaire* (with illustrations, Paris, 1848). (K. S.)

BUGTI, a Baluch tribe of Rind (Arab) origin, numbering about 15,500, who occupy the hills to the east of the Sind-Peshin railway, between Jacobabad and Sibi, with the Marris (a cognate tribe) to the north of them. Like the Marris, the Bugtis are physically a magnificent race of people, fine horsemen, good swordsmen and hereditary robbers. An expedition against them was organized by Sir C. Napier in 1845, but they were never brought under control till Sir Robert Sandeman ruled Baluchistan. Since the construction of the railway, which completely outflanks their country, they have been fairly orderly.

BUHLE, JOHANN GOTTLIEB (1763-1821), German scholar and philosopher, was born at Brunswick, and educated at Göttingen. He became professor of philosophy at Göttingen, Moscow (1840) and Brunswick. Of his numerous publications,

⁷ For the use of the drum in the 16th century, see Sir John Smyth, *Instructions and Observations for all Chieftaines, Captaines, &c.* (London, 1595), pp. 158-159.

⁸ See Richard Cannon, *Historical Records of the regiment* (London, 1848), p. 3.

⁹ See H. G. Farmer, *Memoirs of the Royal Artillery Band* (London, 1904), p. 183.

the most important are the *Handbuch der Geschichte der Philosophie* (8 vols., 1796-1804), and *Geschichte der neueren Philosophie* (6 vols., 1800-1805). The latter, elaborate and well written, is lacking in critical appreciation and proportion; there are French and Italian translations. He edited Aratus (2 vols., 1793, 1801) and part of Aristotle (Bipontine edition, vols. i.-v., 1791-1904).

BUHTURĪ [al-Walid ibn 'Ubad Allāh] (820-897), Arabian poet, was born at Manbij (Hierapolis) in Syria, between Aleppo and the Euphrates. Like Abū Tammām, he was of the tribe of Tāi. While still young, he went to visit Abū Tammām at Homs, and by him was commended to the authorities at Ma'arrat un-Nu'mān, who gave him a pension of 4000 dirhems (about £90) yearly. Later he went to Bagdad, where he wrote verses in praise of the caliph Motawakkil and of the members of his court. Although long resident in Bagdad he devoted much of his poetry to the praise of Aleppo, and much of his love-poetry is dedicated to Alwa, a maiden of that city. He died at Manbij Hierapolis in 897. His poetry was collected and edited twice in the 10th century, arranged in one edition alphabetically (i.e. according to the last consonant in each line); in the other according to subjects. It was published in Constantinople (A.D. 883). Like Abū Tammām he made a collection of early poems, known as the Hamāsa (index of the poems contained in it, in the *Journal of the German Oriental Society*, vol. 47, pp. 418 ff., cf. vol. 45, pp. 470 ff.).

Biography in M.G. de Slane's translation of Ibn Khallikān's *Biographical Dictionary* (Paris and London, 1842), vol. iii. pp. 657 ff.; and in the *Book of Songs* (see ABULFARAJ), vol. xviii. pp. 167-175. (G. W. T.)

BUILDERS' RITES. Many people familiar with the ceremonies attendant on the laying of foundation stones, whether ecclesiastical, masonic or otherwise, may be at a loss to account for the actual origin of the custom in placing within a cavity beneath the stone, a few coins of the realm, newspapers, &c. The ordinary view that by such means particulars may be found of the event on the removal of the stone hereafter, may suffice as respects latter-day motives, but such memorials are deposited in the hope that they will never be disturbed, and so another reason must be found for such an ancient survival. Whilst old customs continue, the reasons for them are ever changing, and certainly this fact applies to laying foundation stones. Originally, it appears that living victims were selected as "a sacrifice to the gods," and especially to ensure the stability of the building. Grimm remarks "It was often thought necessary to immure live animals and even men in the foundation, on which the structure was to be raised, to secure immovable stability." There is no lack of evidence as to this gruesome practice, both in savage and civilized communities. "The old pagan laid the foundation of his house and fortress in blood."¹ Under the walls of two round towers in Ireland (the only ones examined) human skeletons have been discovered. In the 15th century, the wall of Holsworthy church was built over a living human being, and when this became unlawful, images of living beings were substituted (*Folk-Lore Journal*, i. 23-24).

The best succinct account of these rites is to be obtained in G. W. Speth's *Builders' Rites and Ceremonies* (1893). (W. J. H.*)

BUILDING.² The art of building comprises the practice of civil architecture, or the mechanical operations necessary to carry the designs of the architect into effect. It is not infrequently called "practical architecture," but the adoption of this form would lead only to confusion, by rendering it difficult to make the distinction generally understood between architecture (*q.v.*) as a fine or liberal art, and architecture as a mechanical art. The execution of works of architecture necessarily includes building, but building is frequently employed when the result is not archi-

¹ *Teutonic Mythology* (1883-1884), (trans. Stalleybrass).

² Baring-Gould on "Foundations," *Murray's Mag.* (1887).

³ The verb "to build" (O.E. *byldan*) is apparently connected with O.E. *bōld*, a dwelling, of Scandinavian origin; cf. Danish *ból*, a farm, Icelandic *ból*, farm, abode. Skeat traces it eventually to Sanskrit *bhū*, to be, build meaning "to construct a place in which to be or dwell."

tectural; a man may be a competent builder without being an architect, but no one can be an accomplished architect unless he be competent to specify and direct all the operations of building. An architect should have a scientific knowledge of the various soils he may meet with, such as clay, earth, silt, rock, gravel, chalk, &c., so that when the trial holes are dug out on the site, he can see the nature of the soil, and at once know what kind of a foundation to put to the building, and the depth to which he must go to get a good bottom. He should also have a good knowledge of chemistry, so that he may understand the effects of the various acids, gases, &c., that are contained in the materials he uses, and the objections to their presence. He must be acquainted with the principles of timbering in trenches, and excavations, shoring, brickwork, fireproof construction, stonework, carpentry and joinery, smiths' work, plumbing, heating, ventilation, bells, electric and gas lighting, water-supply, drainage, plastering, tiling to internal walls or pavings and roofs, slating of roofs, glazing, painting and decoration. He should be able to calculate the various strengths and strains to be placed on any portion of the structure, and have a general knowledge of the building trade, enabling him to deal with any difficulty or defects that may arise.

An important feature in the qualification of the architect is that he should be thoroughly conversant with the by-laws of the different towns or districts, as to the requirements for the various classes of buildings, and the special features of portions of the different buildings. The following are examples of the various buildings which he may have to design, and the erection of which he may have to superintend:—dwelling-houses, domestic buildings, shops, dwellings for the working class, public buildings such as churches, schools, hospitals, libraries and hotels, factories of all kinds for all general trades, studios, electric power stations, cold storage buildings, stables and slaughter-houses. With regard to factories, places for the storage or making of different patent foods, and for slaughter of beasts intended for human consumption, stringent by-laws are in most countries laid down and enforced by the public health authorities. In England, the Public Health Acts and By-laws are carried out by the various borough or district authorities, who appoint inspectors especially to study the health of the public with regard to sanitary arrangements. The inspectors have special powers to deal with all improper or defective food, or with any defects in buildings that may affect its clean preparation.

In addition to meeting the requirements of the clients, the various buildings have to be constructed and planned on clearly defined lines, according to the rules of the various authorities that control their erection; thus the *By-laws for special construction and planning of public schools are type of plans* governed in England by the Board of education, and churches are governed by the various societies that assist in financing the erection of these edifices; of these the Incorporated Church Building Society exercises the strongest control. Factories both in England and France must be planned and erected to meet the separate acts that deal with these buildings. The fire insurance companies lay down certain requirements according to the size of the building, and the special trade for which it is erected, and fix their rate of premiums accordingly. Dwelling-houses in London must be erected in accordance with the many building acts which govern the materials to be used, and the methods by which they shall be employed, the thickness of walls, rates of inclination of roofs, means of escape from fire, drainage, space at rear, &c. &c.; these laws especially forbid the use of timber framed buildings. In sundry districts in England where the model by-laws are not in force, notably at Letchworth, Herts, it is possible to erect buildings with sound materials untrammelled by by-laws. With regard to premises used in a combined way, as shop and dwelling-house, if in London, and the building exceeds 10 squares, or 1000 sq. ft. super in area, the stairs and a large portion of the building must be built of fire-resisting materials. In the erection of London flats under certain conditions the stairs and corridors

must be of fire-resisting materials, while in parts of New York timber buildings are allowed; for illustrations of these see the article CARPENTRY. In public buildings and theatres in London, Paris and New York not only the construction, but also the exits and seating accommodation and stage, including the scenery dock and flies, must conform to certain regulations.

The conditions necessary for planning a successful building may be summarized as follows:—(1) Ease of access; (2) Good light; (3) Good service; (4) Pleasing environment and approaches; (5) Minimum cost with true economy; in the case of office buildings, also ease of rearrangement to suit tenants. An architect should also be practically acquainted with all the modes of operation in all the trades or arts employed in building, and be able minutely to estimate beforehand the absolute cost involved in the execution of a proposed structure. The power to do this necessarily involves that of measuring work (usually done by the quantity surveyor at an advanced stage of the work), and of ascertaining the quantities to be done. In ordinary practice the architect usually cubes a building at a price per foot cube, as will be described hereafter, but an architect should know how to measure and prepare quantities, or he cannot be said to be master of his profession.

Building includes what is called construction, which is the branch of the science of architecture relating to the practical execution of the works required to produce any structure; it will therefore be necessary to explain the subject in a general manner before entering upon building in detail.

Although the styles of architecture have varied at different periods, buildings, wherever similar materials are employed, must be constructed on much the same principles. Scientific knowledge of the natures and properties of materials has, however, given to the modern workman immense advantages over his medieval brother-craftsman, and caused many changes in the details of the trade, or art of building, although stones, bricks, mortar, &c., then as now, formed the element of the more solid parts of all edifices.

The object of constructions is to adapt, combine and fit materials in such a manner that they shall retain in use the forms and dispositions assigned to them. If an upright wall be properly constructed upon a sufficient foundation, the combined mass will retain its position and bear pressure acting in the direction of gravity to any extent that the ground on which it stands, and the compound materials of the wall, can sustain. But pressure acting laterally has a necessary tendency to overthrow a wall, and therefore it will be the aim of the constructor to compel, as far as possible, all forces that can act upon an upright wall, to act in the direction of gravity, or else to give it permanent means of resistance in the direction opposite to that in which a disturbing force may act. Thus when an arch is built to bear against an upright wall, a buttress or other counterfort is applied in a direction opposed to the pressure of the arch. In like manner the inclined roof of a building spanning from wall to wall tends to thrust out the walls, and hence a tie is applied to hold the opposite sides of the roof together at its base, where alone a tie can be fully efficient, and thus the roof is made to act upon the walls wholly in the direction of gravity; or where an efficient tie is inapplicable, as in the case of a hammer beam roof, buttresses or counterforts are added to the walls, to enable them to resist the pressure outwards. A beam laid horizontally from wall to wall, as a girder to carry a floor and its load, may sag or bend downwards, and tend thereby to force out the walls, or the beam itself may break. Both these contingencies are obviated by trussing, which renders the beam stiff enough to place its load on the walls in the direction of gravity, and strong enough to carry it safely. Or if the beam be rigid in its nature, or uncertain in its structure, or both (as cast-iron is), and will break without bending, the constructor by the smiths' art will supply a check and ensure it against the possible contingency.

Perfect stability, however, is not to be obtained with materials

which are subject to influences beyond the control of man, and all matter is subject to certain influences of that nature. The influences mostly to be contended against are heat and humidity, the former of which produces movement of some kind or to some extent in all bodies, the latter, in many kinds of matter; whilst the two acting together contribute to the disintegration or decay of materials available for the purposes of construction. These pervading influences the constructor seeks to counteract, by proper selection and disposition of his materials.

Stone and brick, the principal materials in general construction, keep their places in combination by means of gravity. They may be merely packed together, but in general they are compacted by means of mortar or cement, so that although the main constituent materials are wholly incompressible, masses of either, or of both, combined in structures are compressible, until the setting medium has indurated to a like condition of hardness. That kind of stone is best fitted for the purposes of general construction which is least absorbent of moisture, and at the same time free to work. Absorbent stone exposed to the weather rapidly disintegrates, and for the most part non-absorbent stone is so hard that it cannot always be used with a due regard to economy. When, therefore, suitable stone of both qualities can be obtained, the harder stone can be exposed to the weather, or to the action which the softer stone cannot resist, and made to form the main body of the structure of the latter so protected. The hard and the soft should be made to bear alike, and should therefore be coursed and bonded together by the mason's art, whether the work be of stone wrought into blocks and gauged to thickness, or of rough dressed or otherwise unshaped rubble compacted with mortar.

Good bricks are less absorbent of moisture than any stone of the same degree of hardness, and are better non-conductors of heat than stone. As the basis of a stable structure, brickwork is more to be relied upon than stone in the form of rubble, when the constituents bear the relation to one another last above referred to, the setting material being the same in both; because the brick by its shaped form seats itself truly, and produces by bonding a more perfectly combined mass, whilst the imperfectly shaped and variously sized stone as dressed rubble can neither bed nor bond truly, the inequalities of the form having to be compensated for with mortar, and the irregularity of size of the main constituent accounted for by the introduction of larger and smaller stones. The most perfect stability is to be obtained, nevertheless, from truly wrought and accurately seated and bonded blocks of stone, mortar being used to no greater extent than may be necessary to exclude wind and water and prevent the disintegrating action of these agents upon even the most durable stone. When water alone is to be dealt with, and especially when it is liable to act with force, mortar is necessary for securing to every block in the structure its own full weight, and the aid of every other collateral and superimposed stone, in order to resist the loosening effect which water in powerful action is bound to produce.

In the application of construction to any particular object, the nature of the object will naturally affect the character of the constructions and the materials of which they are to be formed. Every piece of construction should be complete in itself, and independent as such of everything beyond it. A door or a gate serves its purpose by an application wholly foreign to itself, but it is a good and effective, or a bad and ineffective, piece of construction, independently of the posts to which it may be hung, whilst the wheel of a wheelbarrow, comprising felloes, spokes and axletree, is a piece of construction complete in itself, and independent as such of everything beyond it. An arch of masonry, however large it may be, is not necessarily a piece of construction complete in itself, for it would fall to pieces without abutments. Thus a bridge consisting of a series of arches, however extensive, may be but one piece of construction, no arch being complete in itself without the collateral arches in the series to serve as its abutments, and the whole series being dependent thereby upon

the ultimate abutments of the bridge, without which the structure would not stand. This illustration is not intended to apply to the older bridges with widely distended masses, which render each pier sufficient to abut the arches springing from it, but tend, in providing for a way over the river, to choke up the way by the river itself, or to compel the river either to throw down the structure or else to destroy its own banks.

Some soils are liable to change in form, expanding and contracting under meteorological influences; such are clays which swell when wetted and shrink when dried. Concrete foundations are commonly interposed upon such soils to protect the building from derangement from this cause; or walls of the cheaper material, concrete, instead of the more expensive brick or stone structure, are brought up from a level sufficiently below the ordinary surface of the ground. When concrete is used to obviate the tendency of the soil to yield to pressure, expanse or extent of base is required, and the concrete being widely spread should therefore be deep or thick as a layer, only with reference to its own power of transmitting to the ground the weight of the wall to be built upon it, without breaking across or being crushed. But when concrete is used as a substitute for a wall, in carrying a wall down to a low level, it is in fact a wall in itself, wide only in proportion to its comparative weakness in the absence of manipulated bond in its construction, and encased by the soil within which it is placed. When a concrete wall is used in place of brick the London Building Act requires an extra thickness of one-third; on the question of reinforced concrete no regulations as to thickness have at present been made.

The foundation of a building of ordinary weight is for the most part sufficiently provided for by applying what are technically termed "footings" to the walls. The reason for a footing is, that the wall obtains thereby a bearing upon a breadth of ground so much greater than its own width or thickness above the footing as to compensate for the difference between the power of resisting pressure of the wall, and of the ground or ultimate foundation upon which the wall is to rest. It will be clear from this that if a building is to be erected upon rock as hard as the main constituent of the walls theoretically no expanded footings will be necessary; if upon chalk, upon strong or upon weak gravel, upon sand or upon clay, the footing must be expanded with reference to the power of resistance of the structure to be used as a foundation; whilst in or upon made ground or other loose and badly combined or imperfectly resisting soil, a solid platform bearing evenly over the ground, and wide enough not to sink into it, becomes necessary under the constructed footing. For this purpose the easiest, the most familiar, and for most purposes the most effectual and durable is a layer of concrete.

The English government, when it has legislated upon building matters, has generally confined itself to making provision that the enclosing walls of buildings should be formed of incombustible materials. In provisions regarding the least thicknesses of such walls, these were generally determined with reference to the height and length of the building.

In the general and usual practice of developing land at the present day, the owner or freeholder of the land first consults an architect and states his intentions of building, the size of what he requires, what it is to be used for, if for trade how many hands he intends to employ, and the sub-buildings and departments, &c., that will be wanted. The architect gathers as much information as he can as to his client's requirements, and from this information prepares his sketches. This first step is usually done with rough sketches or outlines only, and when approved by the client as regards the planning and situation of rooms, &c., the architect prepares the plans, elevations, and sections on the lines of the approved rough sketches; at the same time he strictly observes the building acts, and makes every portion of the building comply with these acts as regards the thickness of walls, open spaces, light and air, distances from surrounding property, frontage lines, and a host of other points too numerous to mention, as far as he can interpret the meaning of the enactments. (The London

and New York Building Acts are very extensive, with numerous amendments made as occasion requires.) An architect, whilst preparing the working drawings from the rough approved sketches, and endeavouring to conform with the Building Act requirements, often finds after consultation with the district surveyor, or the London County Council, or other local authorities, that the plans have to be altered; and when so altered the client may disapprove of them, and thus delay often occurs in settling them.

Another important point is that after the architect has obtained the consent of the building authorities, and also the approval of the client, then he may have to fight the adjoining owners with regard to ancient lights, or air space, or party walls. In the city of London these last difficulties often mean the suspension of the work for a long time, and a great loss to the client.

If the site is a large one, or the nature of the soil uncertain, trial holes should be sunk directly the sketch plans are approved. (See FOUNDATIONS.)

Where the property is leasehold there are always at this stage negotiations as to obtaining the approval of the senior lessors and the freeholders; these having been obtained, the architect is then free to serve the various notices that may be required *re* party walls, &c.

The contract plans should be very carefully prepared, and sections, plans and elevations of all parts of the buildings and the levels from a datum line be given. In addition to the general set of drawings, larger scale details of the principal portions of the building should be given.

If there are any existing buildings on the site these should be carefully surveyed and accurate detail plans be made for reference; this is especially necessary with regard to easements and rights of adjoining owners. Also in the preparation of the site plan the various levels of the ground should be shown.

The plans having been approved by all parties concerned, the next operation is the preparation of the *specification*. This is a document which describes the materials to be used in the building, states how they are to be mixed, and how the various works are to be executed, and specifies every trade, and every portion of work in the building. The specification is necessary to enable the builder to erect the structure according to the architect's requirements, and is written by the architect; usually two copies of this document are made, one for the builder, the other for the architect, and the latter is signed as the contract copy in the same manner as the drawings.

From the specification and drawings usually an approximate estimate of the cost of the proposed building is prepared by the architect, and the most general method adopted is to cube the building by a multiplication of the length, breadth and height of the building, and to multiply the product or cubic contents by a price ranging from fivepence to three shillings per cubic foot. In the case of churches, chapels and schools, the cost may be roughly computed by taking the number of seats at a price per seat. In the case of churches and chapels, taking a minimum area of 8 ft. each, the cost varies from £10 upwards, the difference being due to the amount of architectural embellishment or the addition of a tower. Schools may be estimated as averaging £9 per scholar; we find that, taking schools of various sizes erected by the late London School Board, their cost varied from £7:12:4 to £10:1:10 per scholar. Hospitals vary from £100 per bed upwards, the lowest cost being taken from a cottage hospital type; while in the case of St Thomas's hospital, London, the cost per bed, including the proportion of the administrative block, was £650, and without this portion the wards alone cost £250. The Herbert hospital at Woolwich cost only £130 per bed.

The bills of quantities are prepared by the quantity surveyor, and are generally made to form part of the contract, and so mentioned in "the contract." The work of the quantity surveyor is to measure from the drawings the whole of the materials required for the structure, and state the amounts or quantities of the respective materials in the form of a bill usually made out on foolscap paper specially ruled, so that

the builders can price each item, together with the labour required to work and fix it, thus forming the building. The idea is to be able to arrive at a lump sum for which the builders will undertake to erect the building. It is of frequent occurrence, in fact it occurs in four-fifths of building contracts, that when a building is commenced, the client, or other interested person, will alter some portion, thereby causing deviations from the bills of quantities. By having the prices of the different materials before him, it is easy for the quantity surveyor to remeasure the portion altered, adding or deducting as the case may be, and thus to ascertain what difference the alteration makes. This method of bills of quantities and prices is absolutely necessary to any one about to build, and means a considerable saving to the client in the end. For example:—Suppose that bills of quantities are not prepared for a certain job by a quantity surveyor, and, as is often done, the drawings and specification are sent to several builders asking them for a quotation to build the house or factory or whatever it may be, according to the drawings and specification. The prices are duly sent in to the architect, and probably the lowest price is accepted and the successful builder starts the job. During the progress of the works certain alterations take place by the owner's instructions, and when the day of settlement comes, the builder puts in his claim for "extras," then owing to the alterations and to the architect having no prices to work upon, litigation often ensues.

Before the work of erecting a structure is entrusted to a builder he has to sign a contract in the same manner as the drawings and specification. This contract is an important document wherein the builder agrees to carry out the work for a stated sum of money, in accordance with the drawings and specification, and bills of quantities, and instructions of the architect, and to his entire satisfaction; and it also states the description of the materials and workmanship, and the manner of carrying out the work, responsibilities of the builder, particularly clauses indemnifying the employer against accidents to employees, and against numerous other risks, the time of completion of works under a penalty for non-completion (the usual allowance being made for bad weather, fire or strikes), and also how payments will be made to the builder as he proceeds with the building. This form of contract is generally prepared by the architect, and varies in part as may be necessary to meet the requirements of the case.

When the drawings have been approved by the owner or client, also by the district surveyor or local authorities, and by adjoining owners, one copy of them, made on linen, is usually deposited (in London) either with the district surveyor, or with the London County Council, another is prepared for the freeholder if a lease of the land is granted, and a third is given to the builder. In addition, in complicated cases such as occur in the city of London, when a building is erected on land which has four or five distinct owners, an architect may have to prepare a large number of complete copies to be deposited with the various parties interested.

The duties of the builder are very similar to those of the architect, except that he is not expected to be able to plan and design, but to carry out the plans and designs of the architect in the actual work of building. The builder should also know the various acts, and in particular the acts specially relating to the erection of scaffoldings, boardings, gentries, shoring and pulling down of old buildings. He should have a thorough knowledge of all materials, their qualifying marks or brands, and the special features of good and bad in each class, their uses and method of use. He should be able to control and manage both the men and materials; and briefly, in a builder, as opposed to an architect, the constructive knowledge should predominate.

On large or important works it is usual to have a clerk of works or delegate from the architect; his duties are to be on the works while they are in progress and endeavour by constant attention to secure the use of the best materials and construction, and to report to the architect for his instruction any difficulties that may arise. He should be a thoroughly practical man as opposed to

the architectural draughtsman. His salary is paid by the client, and is not included in the architect's remuneration.

American building acts agree in a general manner with those enforced in London. But whereas New York allows the erection of frame or wood structures, while defining a certain portion of the city inside which no new frame or wood structures shall be erected, in London and the large cities of Great Britain the erection of wood frame buildings as dwellings is prohibited. In New York City provision is made for a space at the rear of domestic buildings at least 10 ft. deep, but such depth is increased when the building is over 60 ft. high, and is varied under special circumstances. In London this depth is the same, but the height of the building in relation to the space required in the rear thereof shall be constructed to keep within an angle of $63\frac{1}{2}$ degrees, inclining from the rear boundary towards the building from the level of pavement in front of building; the position from which the angle is taken is varied under special circumstances. In the smaller English towns the building regulations are framed on the model by-laws, and these increase the depth of the yard or garden according to the height of the building.

With regard to the strength and proportion of materials, these are not dealt with in the London Building Act to the same extent as in the New York; for example, in the New York acts (parts 4 and 5)¹ it is prescribed that the bricks used shall be good, hard, well-burned bricks. The sand used for mortar shall be clean, sharp, grit sand, free from loam or dirt, and shall not be finer than the standard samples kept in the office of the department of buildings; also the quality of lime and mortar is fully described, and the strengths of steel and cast-iron, and tests of new materials. Also it is required that all excavations for buildings shall be properly guarded and protected so as to prevent them from becoming dangerous to life or limb, and shall be sheath-piled where necessary by the person or persons causing the excavations to be made, to prevent the adjoining earth from caving in. Plans filed in the department of buildings shall be accompanied by a statement of the character of the soil at the level of the footings. There are also requirements as to protecting adjoining property. The bearing capacity of soils, pressure under footings of foundations, and in part 6 the materials of walls and the methods to be observed in building them are defined. Part 23 deals with floor loads, and the strength of floors constructed of various materials, and requires that the temporary support shall be strong enough to carry the load placed upon them during the progress of any works to buildings. Part 24 deals with the calculations and strength of materials, and wind pressure. Parts 4 and 5 of the New York Building Code are not dealt with by the London Building Act, but the local by-laws of the various districts deal with these. Part 6 of the New York code is dealt with partly by the London Building Act, and partly by the local by-laws. Parts 23 and 24 of the New York code are not dealt with in the English acts at all. In America the standard quality for all materials is set out, but in no English acts do we find the definition of the quality of timber, new materials, steel, &c. Iron and steel construction is in its infancy in England as compared with America, and probably this accounts for no special regulations being in force; but part 22 of the New York Building Code, section 110 to 129 inclusive, deals very fully with iron and steel construction, and this is further supplemented by sections 137 to 140 inclusive.

Sanitary work is dealt with in London by section 39 of the Public Health (London) Act, and the drainage by-laws of the London County Council, in which every detail is very fully gone into with regard to the laying of drains, and fitting up of soil pipes, w.c.'s, &c., all of which is to be carried out and tested to the satisfaction of the local borough's sanitary inspector. The general requirements of New York with regard to sanitary work are very similar with a few more restrictions, and are carried out under "the rules and regulations for plumbing, drainage,

¹ *Building and Health Laws and Regulations affecting the City of New York, including the Building Code of New York City as amended to 1st May 1903.*

American practice.

water-supply, and ventilation of buildings." The noticeable feature of the New York regulations is that all master plumbers have to be registered, which is not so in England. The New York regulations have 183 sections relating to sanitary work, and the English regulations have 96 sections. Also by part 16 of the Amendments to Plumbing Rules 1903, the New York laws require that, before any construction of, or alterations to, any gas piping or fittings are commenced, permits must be obtained from the superintendent of buildings; these are only issued to a registered plumber. The application must be accompanied by plans of the different floors showing each outlet, and the number of burners to each outlet; a statement must also be made of the quality of the pipes and fittings, all of which are to be tested by the inspector. In London there are no such laws; the gas companies control a small portion of the work as regards the connexion to meters, while the insurance companies require gas jets to be covered with a wire guard where liable to come in contact with inflammable goods. As to water, the various water companies in England have each their own set of regulations as to the kind of fittings and thickness and quality of pipe to be used, whether for service, wastes or main.

The importance of fire-resisting construction is being more fully recognized now by all countries. In France the regulations for factories, shops and workshops relating to "exits" require that all doors should open outwardly when they open on to courts, vestibules, staircases or interior passages. When they give access to the open air, outward opening is not obligatory unless it has been judged necessary in the interests of safety. If the doors open on to a passage or staircase they must be fixed in such a manner as not to project into the passage or staircase when open. The exits must be numerous, and signs indicating the quickest way out are to be placed in conspicuous positions. The windows are to open outwardly. Staircases in offices or other buildings serving as places for work shall be constructed in incombustible materials, or shall be walled in fully in plaster. The number of staircases shall be in proportion to the number of employees, &c. It is prohibited to use any liquid emitting vapours inflammable under 35° C. for the purpose of lighting or heating, unless the apparatus containing the liquid is solidly closed during work, that part of the apparatus containing the liquid being so closed as to avoid any oozing out of the liquid, &c. &c. Instructions are added as to precautions to be taken in case of fire.

In London fire-resisting construction is dealt with in the London Building Act, and its second schedule, and in London County Council Theatre and Factory Acts, &c. In New York the building code (parts 10, 20 and 21) deals with fire appliances, escapes, and fire-proof shutters and doors, fire-proof buildings and fire-proof floors, and requires that all tenement houses shall have an iron ladder for escape. A section somewhat similar to the last came into force in London in 1907 under the London Building Act, being framed with a view to require all existing projecting one-storey shops to have a fire-resisting roof, and all existing buildings over 50 ft. in height to have means of escape to and from the roof in case of fire.

There are several patents now in use with which it would be possible to erect a fire-proof dwelling at small cost with walls 3 to 5 in. in thickness. One of these has been used where the building act does not apply, as in the case of the Newgate prison cells, London, where the outside walls were from 3 to 4 in. thick only, and were absolutely fire and burglar proof. This method consists in using steel dovetailed sheets fixed between small steel stanchions and plastered in cement on both sides. This form of construction was also used at the British pavilion, Paris Exhibition 1900, and has been employed in numerous other buildings in England, and also in South Africa, Venezuela, and India (Delhi durbar). The use of many of these convenient and sound forms of building construction for ordinary buildings in London, and in districts of England where the model by-laws are in force, is prohibited because they do not comply with some one or other of the various clauses relating to materials, or to the thickness of a wall.

The various details of construction are described and illustrated under separate headings. See BRICKWORK, CARPENTRY, FOUNDATIONS, GLAZING, JOINERY, MASONRY, PAINTER-WORK, PLASTERING, ROOFS, SCAFFOLD, SEORING, STAIRCASE, STEEL CONSTRUCTION, STONE, TIMBER, WALL-COVERINGS, &c.

The principal publications for reference in connexion with this subject are: *The Building and Health Laws of the City of New York*, Brooklyn Eagle Library, No. 85; *Rules and Regulations affecting Building Operations in the administrative County of London*, compiled by Ellis Marsland; *Annotated By-Laws as to House Drainage*, &c., by Jensen; *Metropolitan Sanitation*, by Herbert Daw. (J. B.)

BUILDING SOCIETIES, the name given to societies "for the purpose of raising, by the subscriptions of the members, a stock or fund for making advances to members out of the funds of the society upon freehold, copyhold, or leasehold estate by way of mortgage," may be "either terminating or permanent" (Building Societies Act 1874, § 13). A "terminating" society is one "which by its rules is to terminate at a fixed date, or when a result specified in its rules is attained"; a "permanent" society is one "which has not by its rules any such fixed date or specified result, at which it shall terminate" (§ 5). A more popular description of these societies would be—societies by means of which every man may become "his own landlord," their main purpose being to collect together the small periodical subscriptions of a number of members, until each in his turn has been able to receive a sum sufficient to aid him materially in buying his dwelling-house. The origin and early history of these societies is very clearly traceable. A mention of "building clubs" in Birmingham occurs in 1795; one is known to have been established by deed in the year 1809 at Greenwich; another is said to have been founded in 1825, under the auspices of the earl of Selkirk at Kirkcudbright in Scotland, and we learn (Scratchley, *On Building Societies*, p. 5) that similar societies in that kingdom adopted the title of "menages."

United Kingdom.—When the Friendly Societies Act of 1834 gave effect to the wise and liberal policy of extending its benefits to societies for frugal investment, and generally to all associations having a similar legal object, several building societies were certified under it,—so many, indeed, that in 1836 a short act was passed confirming to them the privileges granted by the Friendly Societies Act, and according to them the additional privileges (very valuable at that time) of exemption from the usury laws, simplicity in forms of conveyance, power to recover by a mere endorsement under the hands of the trustees for the time being, and exemption from stamp duty. This act remained unaltered until 1874, when an act was passed at the instance of the building societies conferring upon them several other privileges, and relieving them of some disabilities and doubts, which had grown up from the judicial expositions of the act of 1836. It made future building societies incorporated bodies, and extended the privilege of incorporation to existing societies upon application, so that members and all who derive title through them were relieved from having to trace that title through the successive trustees of a society. It also gave a distinct declaration to the members of entire freedom from liability to pay anything beyond the arrears due from them at the time of winding up, or the amount actually secured by their mortgage deeds. Power to borrow money was also expressly given to the societies by the act, but upon two conditions: that the limitation of liability must be made known to the lender, by being printed on the acknowledgment for the loan, and that the borrowed money must not exceed two-thirds of the amount secured by mortgage from the members, or, in a terminating society, one year's income from subscriptions. Previous to the passing of the act (or rather to the judicial decision in *Laing v. Read*, which the clause of the act made statutory) there had been, on the one hand, grave doubts on high legal authority whether a society could borrow money at all; while, on the other hand, many societies in order to raise funds carried on the business of deposit banks to an extent far exceeding the amounts used by them for their legitimate purpose of investment on mortgage. It enacted, that if a society borrowed more than the statute authorizes, the directors accepting the loan should be personally

responsible for the excess. By an act passed in 1894 all the Benefit Building Societies established under the act of 1836 after the year 1856 were required to become incorporated under the act of 1874.

There are, therefore, three categories of building societies:— (1) Those established before 1856, which have not been incorporated under the act of 1874 and remain under the act of 1836. (2) Those established before 1874 under the act of 1836, which have been incorporated under the act of 1874. (3) Those which have been established since the act of 1874 was passed. The first class still act by means of trustees. Of these societies there are only 62 remaining in existence, and their number cannot be increased. The second and third classes exceed 2000 in number.

The early societies were all "terminating,"—consisting of a limited number of members, and coming to an end as soon as every member had received the amount agreed upon as the value of his shares. Take, as a simple typical example of the working of such a society, one the shares of which are £120 each, realizable by subscriptions of 10s. a month during 14 years. Fourteen years happens to be nearly the time in which, at 5% compound interest, a sum of money becomes doubled. Hence the present value, at the commencement of the society, of the £120 to be realized at its conclusion, or (what is the same thing) of the subscriptions of 10s. a month by which that £120 is to be raised, is £60. If such a society had issued 120 shares, the aggregate subscriptions for the first month of its existence would amount to exactly the sum required to pay one member the present value of one share. One member would accordingly receive a sum down of £60, and in order to protect the other members from loss, would execute a mortgage of his dwelling-house for ensuring the payment of the future subscription of 10s. per month until every member had in like manner obtained an advance upon his shares, or accumulated the £120 per share. As £60 is not of itself enough to buy a house, even of the most modest kind, every member desirous of using the society for its original purpose of obtaining a dwelling-house by its means would require to take more than one share. The act of 1836 limited the amount of each share to £150, and the amount of the monthly contributions on each share to £1, but did not limit the number of shares a member might hold.

The earlier formed societies (in London at least) did not usually adopt the title "Building Society"; or they added to it some further descriptive title, as "Accumulating Fund," "Savings Fund," or "Investment Association." Several are described as "Societies for obtaining freehold property," or simply as "Mutual Associations," or "Societies of Equality." The building societies in Scotland are mostly called "Property Investment," or "Economic." Although the term "Benefit Building Society" occurs in the title to the act of 1836, it was not till 1849 that it became in England the sole distinctive name of these societies; and it cannot be said to be a happy description of them, for as ordinarily constituted they undertake no building operations whatever, and merely advance money to their members to enable them to build or to buy dwelling-houses or land.

The name "Building Society," too, leaves wholly out of sight the important functions these societies fulfil as means of investment of small savings. The act of 1836 defined them as societies to enable every member to receive the amount or value of a share or shares to erect or purchase a dwelling-house, &c., but a member who did not desire to erect or purchase a dwelling-house might still receive out of the funds of the society the amount or value of his shares, improved by the payments of interest made by those to whom shares had been advanced.

About 1846 an important modification of the system of these societies was introduced, by the invention of the "permanent" plan, which was adopted by a great number of the societies established after that date. It was seen that these societies really consist of two classes of members; that those who do not care to have, or have not yet received, an advance upon mortgage security are mere investors, and that it matters little when they

commence investing, or to what amount; while those to whom advances have been made are really debtors to the society, and arrangements for enabling them to pay off their debt in various terms of years, according to their convenience, would be of advantage both to themselves and the society. By permitting members to enter at any time without back-payment, and by granting advances for any term of years agreed upon, a continuous inflow of funds, and a continuous means of profitable investment of them, would be secured. The interest of each member in the society would terminate when his share was realized, or his advance paid off, but the society would continue with the accruing subscriptions of other members employed in making other advances.

Under this system building societies largely increased and developed. The royal commissioners who inquired into the subject in 1872 estimated the total assets of the societies in 1870 at 17 millions, and their annual income at 11 millions. The more complete returns, afterwards obtained, indicate that this was an under-estimate.

A variety of the terminating class of societies met at one time with considerable favour under the name of "Starr Bowkett" or "mutual" societies, of which more than a thousand were established. They differed from the typical society above described, in the contribution of a member who had not received an advance being much smaller, while the amount of the advance was much larger, and it was made without any calculation of interest. Thus a society issued, say, 500 shares, on which the contributions were to be 1s. 3d. per week, and, as soon as a sum of £300 accumulated allotted it by ballot to one of the shareholders, on condition that he was to repay it without interest by instalments in 10 or 12½ years, and at the same time to keep up his share-contributions. The fortunate recipient of the appropriation was at liberty to sell it, and frequently did so at a profit; but (except from fines) no profit whatever was earned by those who did not succeed in getting an appropriation, and as the number of members successful in the ballot must necessarily be small in the earlier years of the society, the others frequently became discontented and retired. These societies could not borrow money, for as they received no interest they could not pay any. The plan was afterwards modified by granting the appropriations alternately by ballot and sale, so that by the premiums paid on the sales (which are the same in effect as payments of interest on the amount actually advanced) profits might be earned for the investing members. The formation of societies of this class ceased on the passing of the act of 1894, by which balloting for advances was prohibited in societies thereafter established. A further modification of the "mutual" plan was to make all the appropriations by sale. The effect of this was to bring the mutual society back to the ordinary form; for it amounts to precisely the same thing for a man to pay 10s. a month on a loan of £60 for 14 years, as for him to borrow a nominal sum of £84 for the same period, repayable in the same manner, but to allow £24 off the loan as a "bidding" at the sale. The only difference between the two classes of societies is that the interest which the member pays who bids for his advance depends on the amount of competition at the bidding, and is not fixed by a rule of the society.

For several years the progress of building societies in general was steady, but there were not wanting signs that their prosperity was unsubstantial. A practice of receiving deposits repayable at call had sprung up, which must lead to embarrassment where the funds are invested in loans repayable during a long term of years. It was surmised, if not actually known, that many societies had large amounts of property on their hands, which had been reduced into possession in consequence of the default of borrowers in paying their instalments. A practice had also grown up of establishing mushroom societies, which did little more than pay fees to the promoters. The vicious system of trafficking in advances that had been awarded by ballot, near akin to gambling, prevailed in many societies. These signs of weakness had been observed by the well-informed, and the disastrous failure of a large society incorporated under

the act of 1874, the Liberator, which had in fact long ceased to do any genuine building society business, hastened the crisis.

The Liberator. This society had drawn funds to the amount of more than a million sterling from provident people in all classes of the population and all parts of the country by specious representations, and had applied those funds not to the legitimate purpose of a building society, but to the support of other undertakings in which the same persons were concerned who were the active managers of the society. The consequence was that the whole group of concerns became insolvent (Oct. 1892), and the Liberator depositors and shareholders were defrauded of every penny of their investments. Many of them suffered great distress from the loss of their savings, and some were absolutely ruined. The result was to weaken confidence in building societies generally, and this was very marked in the rapid decline of the amount of the capital of the incorporated building societies. From its highest point (nearly 54 millions) reached in 1887, it fell to below 43 millions in 1895. On some societies, which had adopted the deposit system, a run was made, and several were unable to stand it. The Birkbeck Society was for two days besieged by an anxious crowd of depositors clamouring to withdraw their money; but luckily for that society, and for the building societies generally, a very large portion of its funds was invested in easily convertible securities, and it was enabled by that means to get sufficient assistance from the Bank of England to pay without a moment's hesitation every depositor who asked for his money. Its credit was so firmly established by this means that many persons sought to pay money in. Had this very large society succumbed, the results would have been disastrous to the whole body of building societies. As the case stood, the energetic means it adopted to save its own credit reacted in favour of the societies generally.

The Liberator disaster convinced everybody that something must be done towards avoiding such calamities in future. The government of the day brought in a bill for that purpose, and several private members also prepared measures—most of them more stringent than the government bill. All the bills were referred to a select committee, of which Mr Herbert Gladstone was the chairman. As the result of the deliberations of the committee, the Building Societies Act of 1894 was passed. Meanwhile the Rt. Hon. W. L. Jackson (afterwards Lord Allerton), a member of the committee, moved for an address to the crown for a return of the property held in possession by building societies. This was the first time such a return had been called for, and the managers of the societies much resented it; there were no means of enforcing the return, and the consequence was that many large societies failed to make it, notwithstanding frequent applications by the registrar. The act provided that henceforth all incorporated societies should furnish returns in a prescribed form, including schedules showing respectively the mortgages for amounts exceeding £500; the properties of which the societies had taken possession for more than twelve months through default of the mortgagors; and the mortgages which were more than twelve months in arrear of repayment subscription. The act did not come into operation till the 1st of January 1895, and the first complete return under it was not due till 1896, when it appeared that the properties in possession at the time of Mr Jackson's return must have been counted for at least seven and a half millions in the assets of the societies. In a few years after the passing of the act the societies reduced their properties in possession from 14% of the whole of the mortgages to 5% or, in other words, reduced them to one-third of the original amount, from 7½ millions to 2½ millions. Though this operation must have been attended with some sacrifice in many societies, upon the whole the balance of profit has increased rather than diminished. Thus this provision of the act, though it greatly alarmed the managers of societies, was really a blessing in disguise. The act also gave power to the registrar, upon the application of ten members, to order an inspection of the books of a society, but it did not confer upon individual members the right to inspect the books, which would have been more effective. It empowered the registrar, upon the

application of one-fifth of the members, to order an inspection upon oath into the affairs of a society, or to investigate its affairs with a view to dissolution, and even in certain cases to proceed without an application from members. It gave him ample powers to deal with a society which upon such investigation proved to be insolvent, and these were exercised so as to procure the cheap and speedy dissolution of such societies. It also prohibited the future establishment of societies making advances by ballot, or dependent on any chance or lot, and provided an easy method by which existing societies could discontinue the practice of balloting. This method has been adopted in a few instances only. The act, or the circumstances which led to it, has greatly diminished the number of new societies applying for registry.

The statistics of building societies belonging to all the three classes mentioned show that there were on the 31st of December 1904, 2118 societies in existence in the United Kingdom. Of these, 2075, having 609,785 members, made returns. Their gross receipts for the financial year were £38,729,000, and the amount advanced on mortgage during the year was £9,589,864. The capital belonging to their members was £19,408,430, and the undivided balance of profit £4,004,547. Their liabilities to depositors and other creditors were £24,838,290. To meet this they had mortgages on which £53,196,112 was due, but of this £2,443,255 was on properties which had been in possession more than a year, and £222,444 on mortgages which had fallen into arrear more than a year. Their other assets were £14,952,485, and certain societies showed a deficit balance which in the aggregate was £102,670. As compared with 1895, when first returns were obtained from unincorporated societies, these figures show an increase in income of 30% in assets of 23%, and in profit balances of 46% and a diminution of the properties in possession and mortgages in arrear of 14% in the same years. The total assets and income are more than three times the amount of the conjectural estimate made for 1870 by the royal commission. It is not too much to say that a quarter of a million persons have been enabled by means of building societies to become the proprietors of their own homes.

In recent years, several rivals to building societies have sprung up. Friendly societies have largely taken to investing their surplus funds in loans to members on the building society principle. Industrial and provident land and building societies have been formed. The legislature has authorized local authorities to lend money to the working classes to enable them to buy their dwelling-houses. Bond and investment companies have been formed under the Companies Acts, and are under no restriction as to balloting for appropriation. All these have not yet had any perceptible effect in checking the growth of the building society movement, and it is not thought that they will permanently do so.

British Colonies.—In several of the British colonies, legislation similar to that of the mother country has been adopted. In Victoria, Australia, a crisis occurred, in which many building societies suffered severely. In the other Australian colonies the building society movement has made progress, but not to a very large extent. In the Dominion of Canada these societies are sometimes called "loan companies" and are not restricted in their investments to loans on real estates, but about 90% of their advances are on that security. At the close of the year 1904 their liabilities to stockholders exceeded £13,000,000, and to the public £21,000,000. The uncalled capital was £5,000,000. The balance of current loans was £28,000,000, and the property owned by the societies exceeded £7,000,000.

Belgium, &c.—In Belgium, the Government Savings Bank has power to make advances of money to societies of credit or of construction to enable their members to become owners of dwelling-houses. The advance is made to the society at 3 or sometimes at 2½% interest, and the borrower pays 4%. In the great majority of cases the borrower effects an insurance with the savings bank so that his repayments terminate at his death. On the 31st of December 1903 nearly 25,000 advances were in course of repayment. In Germany, building societies are recognized as a form of societies for self-help, but are not many in number, being overshadowed by the great organization of credit societies founded by Schulze-Delitzsch. In other countries there has been no special legislation for building societies similar to that of the United Kingdom, and though societies with the same special object probably exist, separate information with regard to them is not available. (E. W. B.)

United States.—"Building and loan association" is a general term applied in the United States to such institutions as mutual loan associations, homestead aid associations, savings fund and loan associations, co-operative banks, co-operative savings and loan associations, &c. They are private corporations, for the accumulation of savings, and for the loaning of money to build homes. The first association of this kind in the United States of which there is any record was organized at Frankford, a suburb

safe as it can be, for the monthly dues and the accumulated profits, which give the actual capital of the association, are lent or sold, as it is termed, by the association as fast as they accumulate, and upon real estate or upon the stock of the association itself. The opportunities for embezzlement, therefore, or for shrinkage of securities, are reduced to the minimum, and an almost absolute safety of the investment is secured.

The growth of these associations has been very rapid since 1840, and at the opening of the 20th century they numbered nearly 6000. The Federal government, through the department of labour, made an investigation of building and loan associations, and published its report in 1893. The total dues paid in on instalment shares amounted then to \$450,667,594. The business represented by this great sum, conducted quietly, with little or no advertising, and without the experienced banker in charge, shows that the common people, in their own ways, are quite competent to take care of their savings, especially when it was shown that but thirty-five of the associations then in existence met with a net loss at the end of their latest fiscal year, and that this loss amounted to only a little over \$23,000. Bulletin No. 10 (May 1897) of the U. S. department of labour contained a calculation of the business at that date, based upon such states' reports as were available. That calculation showed a growth in almost every item. During the years of depression ending with 1899 the growth of building and loan associations was naturally slower than in prosperous periods.

See *Ninth Annual Report of U.S.A. Commissioner of Labour* (1893); *Bulletin*, No. 10 (May 1897), of the Department of Labour; Edmund Rigley, *How to manage Building Associations* (1873); Seymour Dexter, *A Treatise on Co-operation Savings and Loan Associations* (New York, 1891); Charles N. Thompson, *A Treatise on Building Associations* (Chicago, 1892). (C. D. W.)

BUILTH, or **BUILTH WELLS**, a market town of Brecknockshire, Wales. Pop. of urban district (1901), 1805. It has a station on the Cambrian line between Moat Lane and Brecon, and two others (high and low levels) at Builth Road about 1½ m. distant where the London & North-Western and the Cambrian cross one another. It is pleasantly situated in the upper valley of the Wye, in a bend of the river on its right bank below the confluence of its tributary the Irfon. During the summer it is a place of considerable resort for the sake of its waters—saline, chalybeate and sulphur—and it possesses the usual accessories of pump-rooms, baths and a recreation ground. The scenery of the Wye valley, including a succession of rapids just above the town, also attracts many tourists. The town is an important agricultural centre, its fairs for sheep and ponies in particular being well attended.

The town, called in Welsh *Llanfair (yn) Mualt*, i.e. St Mary's in Builth, took its name from the ancient territorial division of Buallt in which it is situated, which was, according to Nennius, an independent principality in the beginning of the 9th century, and later a cantref, corresponding to the modern hundred of Builth. Towards the end of the 11th century, when the tide of Norman invasion swept upwards along the Wye valley, the district became a lordship marcher annexed to that of Brecknock, but was again severed from it on the death of William de Breos, when his daughter Matilda brought it to her husband, Roger Mortimer of Wigmore. Its castle, built probably in Newmarch's time, or shortly after, was the most advanced outpost of the invaders in a wild part of Wales where the tendency to revolt was always strong. It was destroyed in 1260 by Llewellyn ab Gruffydd, prince of Wales, with the supposed connivance of Mortimer, but its site was reoccupied by the earl of Lincoln in 1277, and a new castle at once erected. It was with the expectation that he might, with local aid, seize the castle, that Llewellyn invaded this district in December 1282, when he was surprised and killed by Stephen de Frankton in a ravine called *Cwm Llewellyn* on the left bank of the Irfon, 2½ m. from the town. According to local tradition he was buried at *Cefn-y-bedd* ("the ridge of the grave") close by, but it is more likely that his headless trunk was taken to Abbey Cwmhir. No other important event was associated with the castle, of which not a stone is now standing. The lordship remained in the marches till the Act of Union 1536, when it was grouped with a number of others so as to form the shire of Brecknock. The town was governed by a local board from 1866 until the establishment of an urban district council in 1894; the urban district was then made conterminous with the civil parish, and in 1898 it was re-named Builth Wells.

BUISSON, FERDINAND (1841—), French educationalist, was born at Paris on the 20th of December 1841. In 1868, when

attached to the teaching staff of the Academy of Geneva, he obtained a philosophical fellowship. In 1870 he settled in Paris, and in the following year was nominated an inspector of primary education. His appointment was, however, strongly opposed by the bishop of Orleans (who saw danger to clerical influence over the schools), and the nomination was cancelled. But the bishop's action only served to draw attention to Buisson's abilities. He was appointed secretary of the statistical commission on primary education, and sent as a delegate to the Vienna exhibition of 1873, and the Philadelphia exhibition of 1876. In 1878 he was instructed to report on the educational section of the Paris exhibition, and in the same year was appointed inspector-general of primary education. In 1879 he was promoted to the directorship of primary education, a post which he occupied until 1896, when he became professor of education at the Sorbonne. At the general election of 1901 he was returned to the chamber of deputies as a radical socialist by the XIII^e arrondissement of Paris. He supported the policy of M. Combes, and presided over the commission for the separation of church and state.

BUIZENZORG, a hill station in the residency of Batavia, island of Java, Dutch East Indies. It is beautifully situated among the hills at the foot of the Salak volcano; about 860 ft. above sea-level, and has a cool and healthy climate. Buitenzorg is the usual residence of the governor-general of the Dutch East Indies, and is further remarkable on account of its splendid botanical garden and for its popularity as a health resort. The botanic gardens are among the finest in the world; they originally formed a part of the park attached to the palace of the governor-general, and were established in 1817. Under J. S. Teysmann, who became *hortulanus* in 1830, the collection was extended, and in 1868 was recognized as a government institution with a director. Between this and 1880 a museum, a school of agriculture, and a culture garden were added, and since then library, botanical, chemical, and pharmacological laboratories, and a herbarium have been established. The palace of the governor-general was founded by Governor-General van Imhoff in 1744, and rebuilt after being destroyed by an earthquake in 1834. Buitenzorg is also the seat of the general secretary of the state railway and of the department of mines. Buitenzorg, which is called Bogor by the natives, was once the capital of the princess of Pajajaran. Close by, at *Bato Tulis* ("inscribed stone"), are some Hindu remains. The district of Buitenzorg (till 1866 an assistant residency) forms the southern part of the residency of Batavia, with an area of 1447 sq. m. It occupies the northern slopes of a range of hills separating it from Preanger, and has a fertile soil. Tea, coffee, cinchona, sugar-cane, rice, nutmegs, cloves and pepper are cultivated.

BUJNŪRD, a town of Persia, in the province of Khorassan, in a fertile plain encompassed by hills, in 37° 29' N., 57° 21' E., at an elevation of 3600 ft. Pop. about 8000. Its old name was Buzinjird, and thus it still appears in official registers. It is the chief place of the district of same name, which extends in the west to the borders of Shahrud and Astarabad; in the north it is bounded by Russian Transcaspia, in the east by Kuchan, and in the south by Jovain. The greater part of the population consists of Shadillu Kurds, the remainder being Zafraulu Kurds, Garaili Turks, Goklan Turkomans and Persians.

BUKHĀRĪ [Mahommed ibn Ismā'īl al-Bukhārī] (810-822), Arabic author of the most generally accepted collection of traditions (*hadith*) from Mahomet, was born at Bokhara (*Bukhārā*), of an Iranian family, in A.H. 194 (A.D. 810). He early distinguished himself in the learning of traditions by heart, and when, in his sixteenth year, his family made the pilgrimage to Mecca, he gathered additions to his store from the authorities along the route. Already, in his eighteenth year, he had devoted himself to the collecting, sifting, testing and arranging of traditions. For that purpose he travelled over the Moslem world, from Egypt to Samarkand, and learned (as the story goes) from over a thousand men three hundred thousand traditions, true and false. He certainly became the acknowledged authority on the subject, and developed a power and speed of memory

BUILDING SOCIETIES

miraculous, even to his contemporaries. His was conservative and anti-nationalistic; his respect and respect of Ahmad Ibn Hanbal. He has been a Sha'fi'ite. After sixteen years' labors, and there drew up his *Shahih*, a system of jurisprudence without a book of its kind (see MAHOMMED in banishment at Kartank, attained a quasi-canonical status in the Koran, and to his prayers are believed

Slane's transl. of *Jamische Studien*, (D. B. M.A.)

769

by from the is occupied by pastures and is fertile, and agricultural principal products being potatoes, flax and hemp. Cattle- important source of revenue. The salt, which is extracted at the mine of to the government. Brewing, distilling and the chief industries. Commerce is mostly in the Jews and Armenians, and chiefly confined to raw products, such as agricultural produce, cattle, wool and wood. Bukovina had in 1900 a population of 729,921, which is equivalent to 181 inhabitants per sq. m. According to nationality, over 40% were Ruthenians, 35% Rumanians, 13% Jews, and the remainder was composed of Germans, Poles, Hungarians, Russians and Armenians. The official language of the administration, of the law-courts, and of instruction in the university is German. Nearly 70% of the population belong to the Greek Orthodox Church, and stand under the ecclesiastical jurisdiction of the archbishop or metropolitan of Czernowitz. To the Roman Catholic Church belong 11%, to the Greek United Church 3.25%, while 2.5% are Protestants. Elementary education is improving, but, after Dalmatia, Bukovina still shows the largest number of illiterates in Austria. The local diet, of which the archbishop of Czernowitz and the rector of the university are members *ex officio*, is composed of 31 members, and Bukovina sends 14 deputies to the Reichsrat at Vienna. For administrative purposes, the country is divided into 9 districts and an autonomous municipality, Czernowitz (pop. 69,619), the capital. Other towns are Radautz (14,343), Suczawa (10,946), Kuczurmare (9417), Kimpolung (8024) and Sereth (7610).

Bukovina was originally a part of the principality of Moldavia, whose ancient capital Suczawa was situated in this province. It was occupied by the Russians in 1769, and by the Austrians in 1774. In 1777 the Porte, under whose suzerainty Moldavia was, ceded this province to Austria. It was incorporated with Galicia in a single province in 1786, but was separated from it in 1840, and made a separate crownland.

See Bidermann, *Die Bukovina unter der österreichischen Verwaltung*, 1775-1875 (Lemberg, 1876).

BULACÁN, a town of the province of Bulacán, Luzon, Philippine Islands, on an arm of the Pampanga delta, 22 m. N.N.W.

of Manila. Pop. (1903) 11,589; after the census enumeration, the town of Guiguintó (pop. 3948) was annexed. Bulacán is served by the Manila-Dagupan railway. Sugar, rice, indigo and tropical fruits are the chief products of the fertile district in which the town lies; it is widely known for its fish-ponds and its excellent fish, and its principal manufactures are just, piña, ilang ilang perfume and sugar. With the exception of the churches and a few stone buildings, Bulacán was completely destroyed by fire in 1898.

BULANDESHAHR, a town and district of British India in the Meerut division of the United Provinces. The town is situated on a height on the right bank of the Kali-Nadi, whence the substitution of the names Unchanagar and Bulandshahr (high town) for its earlier name of Baran, by which it is still sometimes called. The population in 1901 was 18,959. Its present handsome appearance is due to several successive collectors, notably F. S. Growse, who was active in erecting public buildings, and in encouraging the local gentry to beautify their own houses. In particular, it boasts a fine bathing-ghat, a town-hall, a marketplace, a tank to supply water, and a public garden.

The DISTRICT OF BULANDESHAHR has an area of 1899 sq. m. The district stretches out in a level plain, with a gentle slope from N.W. to S.E., and a gradual but very slight elevation about midway between the Ganges and Jumna. Principal rivers are the Ganges and Jumna—the former navigable all the round, the latter only during the rains. The Ganges canal traverses the district, and serves both for irrigation and navigation. The Lower Ganges canal has its headworks at Narora. The climate of the district is liable to extremes, being very cold in the winter and excessively hot in the summer. In 1901 the population was 1,138,101, showing an increase of 20% in the decade. The district is very highly cultivated and thickly populated. There are several indigo factories, and mills for pressing and cleaning cotton, but the former have greatly suffered by the decline in indigo of recent years. The main line of the East Indian railway and the Oudh and Rohilkhand railway cross the district. The chief centre of trade is Khurja.

Nothing certain is known of the history of the district before A.D. 1018, when Mahmud of Ghazni appeared before Baran and received the submission of the Hindu raja and his followers to Islam. In 1193 the city was captured by Kutb-ud-din. In the 14th century the district was subject to invasions of Rajput and Mongol clans who left permanent settlements in the country. With the firm establishment of the Mogul empire peace was restored, the most permanent effect of this period being the large proportion of Mussulmans among the population, due to the zeal of Aurangzeb. The decline of the Mogul empire gave free play to the turbulent spirit of the Jats and Gujars, many of whose chieftains succeeded in carving out petty principalities for themselves at the expense of their neighbours. During this period, however, Baran had properly no separate history, being a dependency of Koil, whence it continued to be administered under the Mahratta domination. After Koil and the fort of Aligarh had been captured by the British in 1803, Bulandshahr and the surrounding country were at first incorporated in the newly created district of Aligarh (1805). Bulandshahr enjoyed an evil reputation in the Mutiny of 1857, when the Gujar peasantry plundered the towns. The Jats took the side of the government, while the Gujars and Mussulman Rajputs were most actively hostile.

See *Imperial Gazetteer of India* (Oxford, ed. 1908); F. S. Growse, *Bulandshahr* (Benares, 1884).

BULAWAYO, the capital of Matabeleland, the western province of southern Rhodesia, South Africa. White population (1904) 3840. It occupies a central position on the tableland between the Limpopo and Zambezi rivers, is 4469 ft. above the sea and 1362 m. north-east of Cape Town by rail. Beira, the nearest port, is 398 m. east in a direct line, but distant 675 m. by railway. Another railway, part of the Cape to Cairo connexion, runs north-west from Bulawayo, crossing the Zambezi just below the Victoria Falls. In the centre of the town is a large market square to which roads lead in regular lines north, south, east and

west. Those going east and west are called avenues and are numbered, those running north and south are called streets and are named. Through the centre of Market Square runs Rhodes Street. There are many handsome public and private buildings. In front of the stock exchange is a monument in memory of the 257 settlers killed in the Matabele rebellion of 1896, and at the junction of two of the principal streets is a colossal bronze statue of Cecil Rhodes. East of the town is a large park and botanical gardens, beyond which is a residential suburb. The railway station and water and electric supply works are in the south-west quarter. An avenue 130 ft. broad and nearly 1½ m. long, planted throughout its length with trees, leads from the town to Government House, which is built on the site of Lobengula's royal kraal. The tree under which that chieftain sat when giving judgment has been preserved. A number of gold reefs intersect the surrounding district and in some of the reefs gold is mined. South-south-east of the town are the Matoppo Hills. In a grave in one of these hills, 33 m. from Bulawayo, Rhodes is buried.

The "Place of Slaughter," as the Zulu word Bulawayo is interpreted, was founded about 1838 by Lobengula's father, Mosilikatze, some distance south of the present town, and continued to be the royal residence till its occupation by the British South Africa Company's forces in November 1893, when a new town was founded. Four years later the railway connecting it with Cape Town was completed (see RHODESIA).

BULDANA, a town and district of India, in Berar. The town had a population in 1901 of 4137. The district has an area of 3662 sq. m. The southern part forms a portion of Berar Balaghat or Berar—above the Ghats. Here the general contour of the country may be described as a succession of small plateaus decreasing in elevation to the extreme south. Towards the eastern side of the district the country assumes more the character of undulating high lands, favoured with soil of a good quality. A succession of plateaus descends from the highest ridges on the north to the south, where a series of small ghats march with the nizam's territory. The small fertile valleys between the plateaus are watered by streams during the greater portion of the year, while wells of particularly good and pure water are numerous. These valleys are favourite village sites. The north portion of the district occupies the rich valley of the Purna. The district is rich in agricultural produce; in a seasonable year a many-coloured sheet of cultivation, almost without a break, covers the valley of the Purna. In the Balaghat also the crops are very fine. Situated as the district is in the neighbourhood of the great cotton market of Khamgaon, and nearer to Bombay than the other Berar districts, markets for its agricultural produce on favourable terms are easily found. In 1901 the population was 423,616, showing a decrease of 12% in the decade due to the effects of famine. The district was reconstituted, and given an additional area of 853 sq. m. in 1905; the population on the enlarged area in 1901 was 613,756. The only manufacture is cotton cloth. Cotton, wheat and oil-seeds are largely exported. The Nagpur line of the Great Indian Peninsula railway runs through the north of the district. The most important place of trade is Malkapur—pop. (1901) 13,112—with several factories for ginning and pressing cotton.

BULDUR, or **BURDUR**, chief town of a sanjak of the Konia vilayet in Asia Minor. It is called by the Christians *Polydoron*. Its altitude is 3150 ft. and it is situated in the midst of gardens, about 2 m. from the brackish lake, Buldur Geul (anc. *Ascomia Limne*). Linen-weaving and leather-tanning are the principal industries. There is a good carriage road to Dineir, by which much grain is sent from the Buldur plain, and a railway connects it with Dineir and Egirdir. Pop. 12,000.

BULFINCH, CHARLES (1763–1844), American architect, was born in Boston, Massachusetts, on the 8th of August 1763, the son of Thomas Bulfinch, a prominent and wealthy physician. He was educated at the Boston Latin school and at Harvard, where he graduated in 1781, and after several years of travel and study in Europe, settled in 1787 in Boston, where he was the first to practise as a professional architect. Among his early

works were the old Federal Street theatre (1793), the first play-house in New England, and the "new" State House (1798). For more than twenty-five years he was the most active architect in Boston, and at the same time took a leading part in the public life of the city. As chairman of the board of selectmen for twenty-one years (1797–1818), an important position which made him practically chief magistrate, he exerted a strong influence in modernizing Boston, in providing for new systems of drainage and street-lighting, in reorganizing the police and fire departments, and in straightening and widening the streets. He was one of the promoters in 1787 of the voyage of the ship "Columbia," which under command of Captain Robert Gray (1755–1806) was the first to carry the American flag round the world. In 1818 Bulfinch succeeded B. H. Latrobe (1764–1820) as architect of the National Capitol at Washington. He completed the unfinished wings and central portion, constructing the rotunda from plans of his own after suggestions of his predecessor, and designed the new western approach and portico. In 1830 he returned to Boston, where he died on the 15th of April 1844. Bulfinch's work was marked by sincerity, simplicity, refinement of taste and an entire freedom from affectation, and it greatly influenced American architecture in the early formative period. His son, Stephen Greenleaf Bulfinch (1809–1870), was a well-known Unitarian clergyman and author.

See *The Life and Letters of Charles Bulfinch* (Boston, 1896), edited by his grand-daughter, and "The Architects of the American Capitol," by James Q. Howard, in *The International Review*, vol. i (New York, 1874).

BULGARIA, a kingdom of south-eastern Europe, situated in the north-east of the Balkan Peninsula, and on the Black Sea. From 1878 until the 5th of October 1908, Bulgaria was an autonomous and tributary principality, under the suzerainty of the sultan of Turkey. The area of the kingdom amounts to 37,240 sq. m., and comprises the territories between the Balkan chain and the river Danube; the province of Eastern Rumelia, lying south of the Balkans; and the western highlands of Kiustendil, Samakov, Sofia and Trn. Bulgaria is bounded on the N. by the Danube, from its confluence with the Timok to the eastern suburbs of Silistria whence a line, forming the Rumanian frontier, is drawn to a point on the Black Sea coast 10 m. S. of Mangalia. On the E. it is washed by the Black Sea; on the S. the Turkish frontier, starting from a point on the coast about 12 m. S. of Sozopolis, runs in a south-westerly direction, crossing the river Maritza at Mustafa Pasha, and reaching the Arda at Adakali. The line laid down by the Berlin Treaty (1878) ascended the Arda to Ishiklar, thence following the crest of Rhodope to the westwards, but the cantons of Krjali and Rupchus included in this boundary were restored to Turkey in 1886. The present frontier, passing to the north of these districts, reaches the watershed of Rhodope a little north of the Dostal valley, and then follows the crest of the Rilka Planina to the summit of Tcherni Vrkh, where the Servian, Turkish and Bulgarian territories meet. From this point the western or Servian frontier passes northwards, leaving Trn to the east and Piro to the west, reaching the Timok near Kula, and following the course of that river to its junction with the Danube. The Berlin Treaty boundary was far from corresponding with the ethnological limits of the Bulgarian race, which were more accurately defined by the abrogated treaty of San Stefano (see below, under *History*). A considerable portion of Macedonia, the districts of Piro and Vranja belonging to Servia, the northern half of the vilayet of Adrianople, and large tracts of the Dobrudja, are, according to the best and most impartial authorities, mainly inhabited by a Bulgarian population.

Physical Features.—The most striking physical features are two mountain-chains; the Balkans, which run east and west through the heart of the country; and Rhodope, which, for a considerable distance, forms its southern boundary. The Balkans constitute the southern half of the great semicircular range known as the anti-Dacian system, of which the Carpathians form the northern portion. This great chain is sundered at the Iron Gates by the passage of the Danube; its two component parts present many points of resemblance in their aspect and outline, geological formation and flora. The Balkans (ancient *Haemus*) run almost parallel to the Danube,

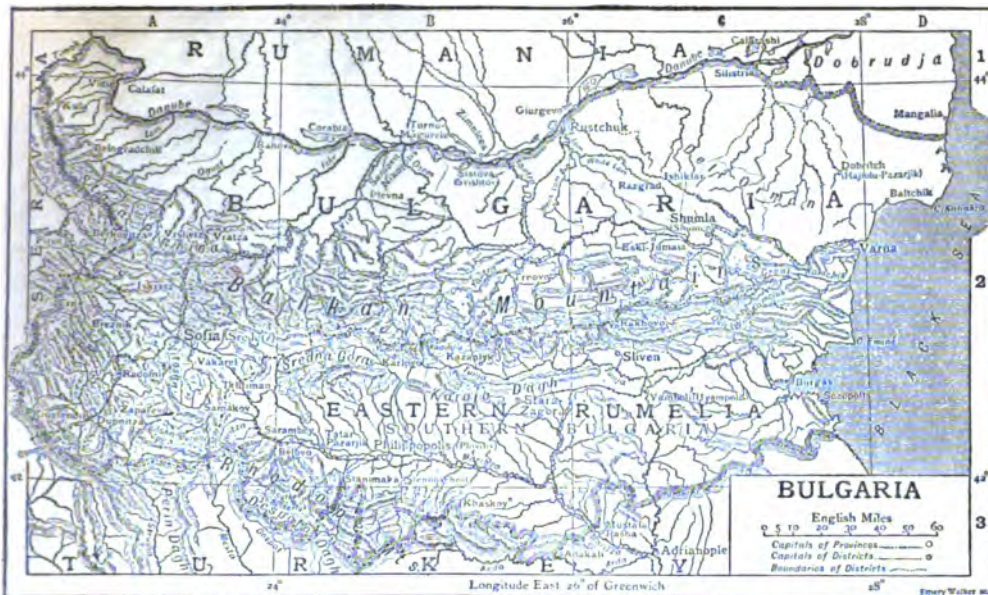

the mean interval being 60 m.; the summits are, as a rule, rounded, and the slopes gentle. The culminating points are in the centre of the range: Yumrukchál (7835 ft.), Maragudúk (7808 ft.), and Kadimla (7464 ft.). The Balkans are known to the people of the country as the *Sara Planina* or "Old Mountain," the adjective denoting their greater size as compared with that of the adjacent ranges: "Balkan" is not a distinctive term, being applied by the Bulgarians, as well as the Turks, to all mountains. Closely parallel, on the south, are the minor ranges of the *Sredna Gora* or "Middle Mountains" (highest summit 3167 ft.) and the *Karaja Dag*, enclosing respectively the sheltered valleys of Karlovo and Kazanlyk. At its eastern extremity the Balkan chain divides into three ridges, the central terminating in the Black Sea at Cape Eminé ("Haemus"), the northern forming the watershed between the tributaries of the Danube and the rivers falling directly into the Black Sea. The Rhodope, or southern group, is altogether distinct from the Balkans, with which, however, it is connected by the Malk: Planina and the Ikhtiman hills, respectively west and east of Sofia; it may be regarded as a continuation of the great Alpine system which traverses the Peninsula from the Dinaric Alps and the Shar Planina on the west to the Shabkhana Dag near the Aegean coast; its sharper outlines and pine-clad steeps reproduce the scenery of the Alps rather than that of the Balkans. The imposing summit of Musallá (9631 ft.), next to Olympus, the highest in the Peninsula, forms the centre-point of the group; it stands within the Bulgarian frontier at the head of the Mesta valley, on either side of which the *Perin Dag* and the *Desporto Dag* descend south and south-east respectively towards the Aegean. The chain of Rhodope proper radiates to the east; owing to the retrocession of territory already mentioned, its central ridge no longer completely coincides with the Bulgarian boundary, but two of its principal summits, Sytké (7179 ft.) and Karlyk (6828 ft.), are within the frontier. From Musallá in a westerly direction extends the majestic range of the *Rilska Planina*, enclosing in a picturesque valley the celebrated monastery of Rila; many summits of this chain attain 7000 ft. Farther west, beyond the *Struma* valley, is the *Osogovska Planina*, culminating in Ruyen (7392 ft.). To the north of the *Rilska Planina* the almost isolated mass of *Vitosha* (7517 ft.) overhangs Sofia. Snow and ice remain in the sheltered crevices of Rhodope and the Balkans throughout the summer. The fertile slope trending northwards from the Balkans to the Danube is for the most part gradual and broken by hills; the eastern portion known as the *Deli Orman*, or "Wild Wood," is covered by forest, and thinly inhabited. The abrupt and sometimes precipitous character of the Bulgarian bank of the Danube contrasts with the swampy lowlands and lagoons of the Rumanian side. Northern Bulgaria is watered by the Lom, Ogust, Iskr, Vid, Osem, Yantra and Eastern Lom, all, except the Iskr, rising in the Balkans, and all flowing into the Danube. The channels of these rivers are deeply furrowed and the fall is rapid; irrigation is consequently

difficult and navigation impossible. The course of the Iskr is remarkable: rising in the *Rilska Planina*, the river descends into the basin of Samakov, passing thence through a serpentine defile into the plateau of Sofia, where in ancient times it formed a lake; it now forces its way through the Balkans by the picturesque gorge of Iskretz. Somewhat similarly the *Deli*, or "Wild," Kamchik breaks the central chain of the Balkans near their eastern extremity and, uniting with the *Great Kamchik*, falls into the Black Sea. The *Maritza*, the ancient *Hebrus*, springs from the slopes of *Musallá*, and, with its tributaries, the *Tunja* and *Arda*, waters the wide plain of Eastern Rumelea. The *Struma* (ancient and modern *Greek Strymon*) drains the valley of *Kiustendil*, and, like the *Maritza*, flows into the Aegean. The elevated basins of Samakov (lowest altitude 3050 ft.), *Trn* (2525 ft.), *Breznik* (2460 ft.), *Radomir* (2065 ft.), *Sofia* (1640 ft.), and *Kiustendil* (1540 ft.), are a peculiar feature of the western highlands.

Geology.—The stratified formation presents a remarkable variety, almost all the systems being exemplified. The Archaean, composed of gneiss and crystalline schists, and traversed by eruptive veins, extends over the greater part of the Eastern Rumelean plain, the *Rilska Planina*, Rhodope, and the adjacent ranges. North of the Balkans it appears only in the neighbourhood of *Berkovitz*. The other earlier Palaeozoic systems are wanting, but the Carboniferous appears in the western Balkans with a continental *faunes* (*Kulm*). Here anthraciferous coal is found in beds of argillite and sandstone. Red sandstone and conglomerate, representing the Permian system, appear especially around the basin of Sofia. Above these, in the western Balkans, are Mesozoic deposits, from the Trias to the upper Jurassic, also occurring in the central part of the range. The Cretaceous system, from the infra-Cretaceous *Hauterivien* to the Senonian, appears throughout the whole extent of Northern Bulgaria, from the summits of the Balkans to the Danube. Gosau beds are found on the southern declivity of the chain. Flysch, representing both the Cretaceous and Eocene systems, is widely distributed. The Eocene, or older Tertiary, further appears with nummulitic formations on both sides of the eastern Balkans; the Oligocene only near the Black Sea coast at *Burgas*. Of the Neogene, or younger Tertiary, the Mediterranean, or earlier, stage appears near *Pleven* (*Plevna*) in the *Leitshalk* and *Tegel* forms, and between *Varna* and *Burgas* with beds of spianodons, as in the Crimea; the Sarmatian stage in the plain of the Danube and in the districts of *Silistria* and *Varna*. A rich mammaliferous deposit (*Hipparion Rhinoceros*, *Dinoltherium Mastodon*, &c.) of this period has been found near *Mesevria*. Other Neogene strata occupy a more limited space. The Quaternary era is represented by the typical loess, which covers most of the Danubian plain; to its later epochs belong the alluvial deposits of the riparian districts with remains of the *Ursus*, *Equus*, &c., found in bone-caverns. Eruptive masses intrude in the Balkans and *Sredna Gora*, as well as in the Archaean formation of the southern

ranges, presenting granite, syenite, diorite, diabase, quartz-porphyr, melaphyre, liparite, trachyte, andesite, basalt, &c.

Minerals.—The mineral wealth of Bulgaria is considerable, although, with the exception of coal, it remains largely unexploited. The minerals which are commercially valuable include gold (found in small quantities), silver, graphite, galena, pyrite, marcasite, chalcosine, sphalerite, chalcopryite, bornite, cuprite, hematite, limonite, ochre, chromite, magnetite, azurite, manganese, malachite, gypsum, &c. The combustibles are anthraciferous coal, coal, "brown coal" and lignite. The lignite mines opened by the government at Pernik in 1891 yielded in 1904 142,000 tons. Coal beds have been discovered at Trevna and elsewhere. Thermal springs, mostly sulphureous, exist in forty-three localities along the southern slope of the Balkans, in Rhodope, and in the districts of Sofia and Kiustendil; maximum temperature at Zaparevo, near Dupnitsa, 18.0-5° (Fahrenheit), at Sofia 11.8-4°. Many of these are frequented now, as in Roman times, owing to their valuable therapeutic qualities. The mineral springs on the north of the Balkans are, with one exception (Vrnhetz, near Berkovitsa), cold.

Climate.—The severity of the climate of Bulgaria in comparison with that of other European regions of the same latitude is attributable in part to the number and extent of its mountain ranges, in part to the general configuration of the Balkan Peninsula. Extreme heat in summer and cold in winter, great local contrasts, and rapid transitions of temperature occur here as in the adjoining countries. The local contrasts are remarkable. In the districts extending from the Balkans to the Danube, which are exposed to the bitter north wind, the winter cold is intense, and the river, notwithstanding the volume and rapidity of its current, is frequently frozen over; the temperature has been known to fall to 24° below zero. Owing to the shelter afforded by the Balkans against hot southerly winds, the summer heat in this region is not unbearable; its maximum is 99°. The high tableland of Sofia is generally covered with snow in the winter months; it enjoys, however, a somewhat more equable climate than the northern district, the maximum temperature being 86°, the minimum 2°; in the eastern districts the summer nights are cool and fresh. In the eastern districts the proximity of the sea moderates the extremes of heat and cold; the sea is occasionally frozen at Varna. The coast-line is exposed to violent north-east winds, and the Black Sea, the *stóros ékúros* or "inhospitable sea" of the Greeks, maintains its evil reputation for storms. The sheltered plain of Eastern Rumelia possesses a comparatively warm climate; spring begins six weeks earlier than elsewhere in Bulgaria, and the vegetation is that of southern Europe. In general the Bulgarian winter is short and severe; the spring short, changeable and rainy; the summer hot, but tempered by thunderstorms; the autumn (*osén*), "the clear time," magnificently fine and sometimes prolonged into the month of December. The mean temperature is 53°. The climate is healthy, especially in the mountainous districts. Malarial fever prevails in the valley of the Maritza, in the low-lying regions of the Black Sea coast, and even in the upland plain of Sofia, owing to neglect of drainage. The mean annual rainfall is 25.59 in. (Gabrovo, 41-73; Sofia, 27-68; Varna, 18-50).

Fauna.—Few special features are noticeable in the Bulgarian fauna. Bears are still abundant in the higher mountain districts, especially in the Rilská Planina and Rhodope; the Bulgarian bear is small and of brown colour, like that of the Carpathians. Wolves are very numerous, and in winter commit great depredations even in the larger country towns and villages; in hard weather they have been known to approach the outskirts of Sofia. The government offers a reward for the destruction of both these animals. The roe deer is found in all the forests, the red deer is less common; the chamois haunts the higher regions of the Rilská Planina, Rhodope and the Balkans. The jackal (*Canis aureus*) appears in the district of Burgas; the lynx is said to exist in the Sredna Gora; the wild boar, otter, fox, badger, hare, wild cat, marten, polecat (*Foelarius putorius*); the rare tiger polecat, *Foelorius sarmaticus*, is also found; weasel and shrewmouse (*Spermophilus citillus*) are common. The beaver (Bulg. *bebr*) appears to have been abundant in certain localities, e.g. Bebrovo, Bebreah, &c., but it is now apparently extinct. Snakes (*Coluber natrix* and other species), vipers (*Vipera berus* and *V. ammodytes*), and land and water tortoises are numerous. The domestic animals are the same as in the other countries of south-eastern Europe; the fierce shaggy grey sheep-dog leaves a lasting impression on most travellers in the interior. Fowls, especially turkeys, are everywhere abundant, and great numbers of geese may be seen in the Moslem villages. The ornithology of Bulgaria is especially interesting. Eagles (*Aquila imperialis* and the rarer *Aquila falco*), vultures (*Vultur monachus*, *Gyps fulvus*, *Neophron percnopterus*), owls, kites, and the smaller birds of prey are extraordinarily abundant; singing birds are consequently rare. The lammergeier (*Gypopterus barbatus*) is not uncommon. Immense flocks of wild swans, geese, pelicans, herons and other waterfowl haunt the Danube and the lagoons of the Black Sea coast. The cock of the woods (*Tetrao urogallus*) is found in the Balkan and Rhodope forests, the wild pheasant in the Tunja valley, the bustard (*Otis larda*) in the Eastern Rumelian plain. Among the migratory birds are the crane, which hibernates in the Maritza valley, woodcock, snipe and quail; the great spotted cuckoo (*Coccyzus glandarius*) is

an occasional visitant. The red stork (*Pastor roseus*) sometimes appears in large flights. The stork, which is never molested, adds a picturesque feature to the Bulgarian village. Of fresh-water fish, the sturgeon (*Acipenser sturio* and *A. kuso*), sterlet, salmon (*Salmo hucho*), and carp are found in the Danube; the mountain streams abound in trout. The Black Sea supplies turbot, mackerel, &c.; dolphins and flying fish may sometimes be seen.

Flora.—In regard to its flora the country may be divided into (1) the northern plain sloping from the Balkans to the Danube, (2) the southern plain between the Balkans and Rhodope, (3) the districts adjoining the Black Sea, (4) the elevated basins of Sofia, Samakov and Kiustendil, (5) the Alpine and sub-Alpine regions of the Balkans and the southern mountain group. In the first-mentioned region the vegetation resembles that of the Russian and Rumanian steppes; in the spring the country is adorned with the flowers of the crocus, orchis, iris, tulip and other bulbous plants, which in summer give way to tall grasses, umbelliferous growths, *diantsi*, *astragali*, &c. In the more sheltered district south of the Balkans the richer vegetation recalls that of the neighbourhood of Constantinople and the adjacent parts of Asia Minor. On the Black Sea coast many types of the Crimean, Transcaucasian and even the Mediterranean flora present themselves. The plateaus of Sofia and Samakov furnish specimens of sub-alpine plants, while the vine disappears; the hollow of Kiustendil, owing to its southerly aspect, affords the vegetation of the Macedonian valleys. The flora of the Balkans corresponds with that of the Carpathians; the Rila and Rhodope group is rich in purely indigenous types combined with those of the central European Alps and the mountains of Asia Minor. The Alpine types are often represented by variants: e.g. the *Campanula alpina* by the *Campanula orbicula*, the *Primula farinosa* by the *Primula frondosa* and *P. exigua*, the *Gentiana germanica* by the *Gentiana bulgarica*, &c. The southern mountain group, in common, perhaps, with the unexplored highlands of Macedonia, presents many isolated types, unknown elsewhere in Europe, and in some cases corresponding with those of the Caucasus. Among the most characteristic genera of the Bulgarian flora are the following:—*Centaurea*, *Cirsium*, *Linaria*, *Scrophularia*, *Verbascum*, *Dianthus*, *Silene*, *Trifolium*, *Euphorbia*, *Cytisus*, *Astragalus*, *Ornithogalum*, *Allium*, *Crocus*, *Iris*, *Thymus*, *Umbellifera*, *Sedum*, *Hypericum*, *Scabiosa*, *Ranunculus*, *Orchis*, *Ophrys*.

Forests.—The principal forest trees are the oak, beech, ash, elm, walnut, cornel, poplar, pine and juniper. The oak is universal in the thickets, but large specimens are now rarely found. Magnificent forests of beech clothe the valleys of the higher Balkans and the Rilská Planina; the northern declivities of the Balkans is, in general, well wooded, but the southern slope is bare. The walnut and chestnut are mainly confined to eastern Rumelia. Conifers (*Pinus silvestris*, *Pinus excelsa*, *Pinus laricina*, *Pinus mugo*) are rare in the Balkans, but abundant in the higher regions of the southern mountain group, where the *Pinus peuce*, otherwise peculiar to the Himalayas, also flourishes. The wild lilac forms a beautiful feature in the spring landscape. Wild fruit trees, such as the apple, pear and plum, are common. The vast forests of the middle ages disappeared under the supine Turkish administration, which took no measures for their protection, and even destroyed the woods in the neighbourhood of towns and highways in order to deprive brigands of shelter. A law passed in 1889 prohibits deforesting, limits the right of cutting timber, and places the state forests under the control of inspectors. According to official statistics, 11,640 sq. m. or about 30% of the whole superficies of the kingdom, are under forest, but the greater part of this area is covered only by brushwood and scrub. The beautiful forests of the Rila district are rapidly disappearing under exploitation.

Agriculture.—Agriculture, the main source of wealth to the country, is still in an extremely primitive condition. The ignorance and conservatism of the peasantry, the habits engendered by widespread insecurity and the fear of official rapacity under Turkish rule, insufficiency of communications, want of capital, and in some districts sparsity of population, have all tended to retard the development of this most important industry. The peasants cling to traditional usage, and look with suspicion on modern implements and new-fangled modes of production. The plough is of a primeval type, rotation of crops is only partially practised, and the use of manure is almost unknown. The government has sedulously endeavoured to introduce more enlightened methods and ideas by the establishment of agricultural schools, the appointment of itinerant professors and inspectors, the distribution of better kinds of seeds, improved implements, &c. Efforts have been made to improve the breeds of native cattle and horses, and stallions have been introduced from Hungary and distributed throughout the country. Oxen and buffaloes are the principal animals of draught; the buffalo, which was apparently introduced from Asia in remote times, is much prized by the peasants for its patience and strength; it is, however, somewhat delicate and requires much care. It

the eastern districts camels are also employed. The Bulgarian horses are small, but remarkably hardy, wiry and intelligent; they are as a rule unfitted for draught and cavalry purposes. The best sheep are found in the district of Karnobat in Eastern Rumelia. The number of goats in the country tends to decline, a relatively high tax being imposed on these animals owing to the injury they inflict on young trees. The average price of oxen is £5 each, draught oxen £12 the pair, buffaloes £14 the pair, cows £2, horses £6, sheep, 7s., goats 5s., each. The principal cereals are wheat, maize, rye, barley, oats and millet. The cultivation of maize is increasing in the Danubian and eastern districts. Rice-fields are found in the neighbourhood of Philippopolis. Cereals represent about 80% of the total exports. Besides grain, Bulgaria produces wine, tobacco, attar of roses, silk and cotton. The quality of the grape is excellent, and could the peasants be induced to abandon their highly primitive mode of wine-making the Bulgarian vintages would rank among the best European growths. The tobacco, which is not of the highest quality, is grown in considerable quantities for home consumption and only an insignificant amount is exported. The best tobacco-fields in Bulgaria are on the northern slopes of Rhodope, but the southern declivity, which produces the famous Kavala growth, is more adapted to the cultivation of the plant. The rose-fields of Kazanlyk and Karlovo lie in the sheltered valleys between the Balkans and the parallel chains of the Sredna Gora and Karaja Dagh. About 6000 lb of the rose-essence is annually exported, being valued from £12 to £14 per lb. Beetroot is cultivated in the neighbourhood of Sofia. Sericulture, formerly an important industry, has declined owing to disease among the silkworms, but efforts are being made to revive it with promise of success. Cotton is grown in the southern districts of Eastern Rumelia.

Peasant proprietorship is universal, the small freeholds averaging about 18 acres each. There are scarcely any large estates owned by individuals, but some of the monasteries possess considerable domains. The large *ichifiks*, or farms, formerly belonging to Turkish landowners, have been divided among the peasants. The rural proprietors enjoy the right of pasturing their cattle on the common lands belonging to each village, and of cutting wood in the state forests. They live in a condition of rude comfort, and poverty is practically unknown, except in the towns. A peculiarly interesting feature in Bulgarian agricultural life is the *sadruga*, or house-community, a patriarchal institution apparently dating from prehistoric times. Family groups, sometimes numbering several dozen persons, dwell together on a farm in the observance of strictly communistic principles. The association is ruled by a house-father (*domakin, stareshina*), and a house-mother (*domakinja*), who assign to the members their respective tasks. In addition to the farm work the members often practise various trades, the proceeds of which are paid into the general treasury. The community sometimes includes a priest, whose fees for baptisms, &c., augment the common fund. The national aptitude for combination is also displayed in the associations of market gardeners (*gradinarshi družini, taifi*), who in the spring leave their native districts for the purpose of cultivating gardens in the neighbourhood of some town, either in Bulgaria or abroad, returning in the autumn, when they divide the profits of the enterprise; the number of persons annually thus engaged probably exceeds 10,000. Associations for various agricultural, mining and industrial undertakings and provident societies are numerous: the handicraftsmen in the towns are organized in *esnaf*s or guilds.

Manufactures.—The development of manufacturing enterprise on a large scale has been retarded by want of capital. The principal establishments for the native manufactures of *aba* and *shuyuk* (rough and fine homespuns), and of *gaitan* (braided embroidery) are at Sliven and Gabrovo respectively. The Bulgarian homespuns, which are made of pure wool, are of admirable quality. The exportation of textiles is almost exclusively to Turkey: value in 1896, £104,046; in 1898, £144,720; in 1902, £108,685. Unfortunately the home demand for native fabrics is diminishing owing to foreign competition; the smaller

textile industries are declining, and the picturesque, durable, and comfortable costume of the country is giving way to cheap ready-made clothing imported from Austria. The government has endeavoured to stimulate the home industry by ordering all persons in its employment to wear the native cloth, and the army is supplied almost exclusively by the factories at Sliven. A great number of small distilleries exist throughout the country; there are breweries in all the principal towns, tanneries at Sevlievo, Varna, &c.; numerous corn-mills worked by water and steam, and sawmills, turned by the mountain torrents, in the Balkans and Rhodope. A certain amount of foreign capital has been invested in industrial enterprises; the most notable are sugar-refineries in the neighbourhood of Sofia and Philippopolis, and a cotton-spinning mill at Varna, on which an English company has expended about £60,000.

Commerce.—The usages of internal commerce have been considerably modified by the development of communications. The primitive system of barter in kind still exists in the rural districts, but is gradually disappearing. The great fairs (*panafri, raznyras*) held at Eski-Jumala, Dobritsch and other towns, which formerly attracted multitudes of foreigners as well as natives, have lost much of their importance; a considerable amount of business, however, is still transacted at these gatherings, of which ninety-seven were held in 1898. The principal seats of the export trade are Varna, Burgas and Baltchik on the Black Sea, and Svishtov, Rustchuk, Nikopolis, Silistria, Rakhovo, and Vidin on the Danube. The chief centres of distribution for imports are Varna, Sofia, Rustchuk, Philippopolis and Burgas. About 10% of the exports passes over the Turkish frontier, but the government is making great efforts to divert the trade to Varna and Burgas, and important harbour works have been carried out at both these ports. The new port of Burgas was formally opened in 1904, that of Varna in 1906.

In 1887 the total value of Bulgarian foreign commerce was £4,419,580. The following table gives the values for the six years ending 1904. The great fluctuations in the exports are due to the variations of the harvest, on which the prosperity of the country practically depends:—

Year.	Exports.	Imports.	Total.
1899	£ 2,138,684	£ 2,407,123	£ 4,545,807
1900	2,159,305	1,853,684	4,012,989
1901	3,310,790	2,801,762	6,112,552
1902	4,147,381	2,849,059	7,996,440
1903	4,322,945	3,272,103	7,595,048
1904	6,504,756	5,187,583	11,492,339

The principal exports are cereals, live stock, homespuns, hides, cheese, eggs, attar of roses. Exports to the United Kingdom in 1900 were valued at £239,665; in 1904 at £98,127. The principal imports are textiles, metal goods, colonial goods, implements, furniture, leather, petroleum. Imports from the United Kingdom in 1900, £101,150; in 1904, £793,972.

The National Bank, a state institution with a capital of £400,000, has its central establishment at Sofia, and branches at Philippopolis, Rustchuk, Varna, Trnovo and Burgas. Besides conducting the ordinary banking operations, it issues loans on mortgage. Four other banks have been founded at Sofia by groups of foreign and native capitalists. There are several private banks in the country. The Imperial Ottoman Bank and the Industrial Bank of Kiev have branches at Philippopolis and Sofia respectively. The agricultural chests, founded by Midhat Pasha in 1863, and reorganized in 1894, have done much to rescue the peasantry from the hands of usurers. They serve as treasuries for the local administration, accept deposits at interest, and make loans to the peasants on mortgage or the security of two solvent landowners at 8%. Their capital in 1887 was £569,260; in 1904, £1,440,000. Since 1893 they have been constituted as the "Bulgarian Agricultural Bank"; the central direction is at Sofia. The post-office savings bank, established 1896, had in 1905 a capital of £1,360,560.

There are over 200 registered provident societies in the country. The legal rate of interest is 10%, but much higher rates are not uncommon.

Bulgaria, like the neighbouring states of the Peninsula, has adopted the metric system. Turkish weights and measures, however, are still largely employed in local commerce. The monetary unit is the *lev*, or "lion" (pl. *leva*), nominally equal to the franc, with its submultiple the *stotinka* (pl. *stoti*), or centime. The coinage consists of nickel and bronze coins (2½, 5, 10 and 20 *stotinki*) and silver coins

(50 *stotinki*; 1, 2 and 5 *levo*). A gold coinage was struck in 1893 with pieces corresponding to those of the Latin Union. The Turkish pound and foreign gold coins are also in general circulation. The National Bank issues notes for 5, 10, 20, 50 and 100 *leva*, payable in gold. Notes payable in silver are also issued.

Finance.—It is only possible here to deal with Bulgarian finance prior to the declaration of independence in 1908. At the outset of its career the principality was practically unencumbered with any debt, external or internal. The stipulations of the Berlin Treaty (Art. ix.) with regard to the payment of a tribute to the sultan and the assumption of an "equitable proportion" of the Ottoman Debt were never carried into effect. In 1883 the claim of Russia for the expenses of the occupation (under Art. xx. of the treaty) was fixed at 26,545,625 fr. (£1,061,820) payable in annual instalments of 2,100,000 fr. (£84,000). The union with Eastern Rumelia in 1885 entailed liability for the obligations of that province consisting of an annual tribute to Turkey of 2,951,000 fr. (£118,040) and a loan of 3,375,000 fr. (£135,000) contracted with the Imperial Ottoman Bank. In 1888 the purchase of the Varna-Rustchuk railway was effected by the issue of treasury bonds at 6% to the vendors. In 1889 a loan of 30,000,000 fr. (£1,200,000) bearing 6% interest was contracted with the Vienna Landerbank and Bankverein at 8%. In 1892 a further 6% loan of 142,780,000 fr. (£5,711,200) was contracted with the Landerbank at 8%, 86 and 89. In 1902 a 5% loan of 106,000,000 fr. (£4,240,000), secured on the tobacco dues and the stamp-tax, was contracted with the Banque de l'Etat de Russie and the Banque de Paris et des Pays Bas at 8%, for the purpose of consolidating the floating debt, and in 1904 a 5% loan of 99,980,000 fr. (£4,099,200) at 8%, with the same guarantees, was contracted with the last-named bank mainly for the purchase of war material in France and the construction of railways. In January 1906 the national debt stood as follows:—Outstanding amount of the consolidated loans, 363,070,500 fr. (£14,522,820); internal debt, 15,603,774 fr. (£624,151); Eastern Rumelian debt, 1,910,208 (£76,408). In February 1907 a 4% loan of 145,000,000 fr. at 85, secured on the surplus proceeds of the revenues already pledged to the loans of 1902 and 1904, was contracted with the Banque de Paris et des Pays Bas associated with some German and Austrian banks for the conversion of the loans of 1888 and 1889 (requiring about 53,000,000 fr.) and for railway construction and other purposes. The total external debt was thus raised to upwards of 450,000,000 fr. The Eastern Rumelian tribute and the rent of the Sarambey-Belovo railway, if capitalized at 6%, would represent a further sum of 50,919,100 fr. (£2,036,765). The national debt was not disproportionately great in comparison with annual revenue. After the union with Eastern Rumelia the budget receipts increased from 40,807,262 leva (£1,635,730) in 1886 to 119,655,507 leva (£4,786,220) in 1904; the estimated revenue for 1905 was 111,920,000 leva (£4,476,800), of which 41,179,000 (£1,647,160) were derived from direct and 38,610,000 (£1,544,400) from indirect taxation; the estimated expenditure was 111,903,281 leva (£4,476,131), the principal items being: public debt, 31,317,346 (£1,252,603); army, 26,540,720 (£1,061,628); education, 10,402,470 (£416,098); public works, 14,461,171 (£578,446); interior, 7,559,517 (£302,380). The actual receipts in 1905 were 127,011,393 leva. In 1895 direct taxation, which pressed heavily on the agricultural class, was diminished and indirect taxation (import duties and excise) considerably increased. In 1906 direct taxation amounted to 9 fr. 92 c., indirect to 8 fr. 58 c., per head of the population. The financial difficulties in which the country was involved at the close of the 19th century were attributable not to excessive indebtedness but to heavy outlay on public works, the army, and education, and to the maintenance of an unnecessary number of officials; the economic situation being aggravated by a succession of bad harvests. The war budget during ten years (1888-1897) absorbed the large sum of 275,822,017 leva (£11,033,300) or 35.77% of the whole national income within that period. In subsequent years military expenditure continued to increase; the total during the period since the union with Eastern Rumelia amounting to 599,520,698 leva (£23,980,800).

Communications.—In 1878 the only railway in Bulgaria was the Rustchuk-Varna line (137 m.), constructed by an English company in 1867. In Eastern Rumelia the line from Sarambey to Philippopolis and the Turkish frontier (122 m.), with a branch to Yamboli (66 m.), had been built by Baron Hirsch in 1873, and leased by the Turkish government to the Oriental Railways Company until 1958. It was taken over by the Bulgarian government in 1908 (see *History*, below). The construction of a railway from the Servian frontier at Tzaribrod to the Eastern Rumelian frontier at Vakarel was imposed on the principality by the Berlin Treaty, but political difficulties intervened, and the line, which touches Sofia, was not completed till 1888. In that year the Bulgarian government seized the short connecting line Belovo-Sarambey belonging to Turkey, and a railway communication between Constantinople and the western capitals was established. Since that time great progress has been made in railway construction. In 1888, 240 m. of state railways were open to traffic; in 1899, 777 m.; in 1902, 880 m. Up to October 1908 all these lines were worked by the state, and, with the exception of the Belovo-Sarambey line (29 m.), which was worked under a convention with Turkey, were its property. The completion of the important line Radomir-Sofia-Shumen (November

1899) opened up the rich agricultural district between the Balkans and the Danube and connected Varna with the capital. Branches to Samovit and Rustchuk establish connexion with the Rumanian railway system on the opposite side of the river. It was hoped, with the consent of the Turkish government, to extend the line Sofia-Radomir-Kiustendil to Uskub, and thus to secure a direct route to Salonica and the Aegean. Road communication is still in an unsatisfactory condition. Roads are divided into three classes: "state roads," or main highways, maintained by the government; "district roads," maintained by the district councils; and "inter-village roads" (*meschujushtski shosseto*), maintained by the communes. Repairs are effected by the *corve* with requisitions of material. There are no canals, and inland navigation is confined to the Danube. The Austrian *Donaudampfschiffahrtsgesellschaft* and the Russian *Gagarine* steamship company compete for the river traffic; the grain trade is largely served by steamers belonging to Greek merchants. The coasting trade on the Black Sea is carried on by a Bulgarian steamship company; the steamers of the Austrian Lloyd, and other foreign companies call at Varna, and occasionally at Burgas.

The development of postal and telegraphic communication has been rapid. In 1886, 1,468,494 letters were posted, in 1903, 29,063,043. Receipts of posts and telegraphs in 1886 were £40,975 in 1903 £134,942. In 1903 there were 3261 m. of telegraph lines and 531 m. of telephones.

Towns.—The principal towns of Bulgaria are Sofia, the capital (Bulgarian *Sredets*, a name now little used), pop. in January 1906, 82,187; Philippopolis, the capital of Eastern Rumelia (Bulg. *Plodiv*), pop. 45,572; Varna, 37,155; Rustchuk (Bulg. *Russe*), 33,552; Sliven, 25,049; Shumla (Bulg. *Shumen*), 22,290; Plevna (Bulg. *Pleven*), 21,208; Stara-Zagora, 20,647; Tatar-Pazarjik, 17,549; Vidin, 16,168; Yamboli (Greek *Hyampolis*), 15,708; Dobrich (Turkish *Hajjiok-Pasariji*), 15,369; Haskovo, 15,061; Vratsa, 14,832; Stanimaka (Greek *Stenimachos*), 14,120; Razgrad, 13,783; SistoVA (Bulg. *Svishtov*), 13,408; Burgas, 12,846; Kiustendil, 12,353; Trnovo, the ancient capital, 12,171. All these are described in separate articles.

Population.—The area of northern Bulgaria is 24,535 sq. m.; of Eastern Rumelia 12,705 sq. m.; of united Bulgaria, 37,240 sq. m. According to the census of the 12th of January 1906, the population of northern Bulgaria was 2,853,704; of Eastern Rumelia, 1,174,535; of united Bulgaria, 4,028,239 or 88 per sq. m. Bulgaria thus ranks between Rumania and Portugal in regard to area; between the Netherlands and Switzerland in regard to population; in density of population it may be compared with Spain and Greece.

The first census of united Bulgaria was taken in 1888: it gave the total population as 3,154,375. In January 1893 the population was 3,310,713; in January 1901, 3,744,283.

The movement of the population at intervals of five years has been as follows:—

Year.	Marriages.	Births (living).	Still-born.	Deaths.	Natural Increase. ¹
1882	19,795	74,642	300	38,884	35,758
1887	20,089	83,179	144	39,396	43,783
1892	27,553	117,883	321	103,590	14,333
1897	29,227	149,631	858	90,134	59,497
1902	36,041	149,542	823	91,093	58,449

The death-rate shows a tendency to rise. In the five years 1882-1886 the mean death-rate was 18.0 per 1000; in 1887-1891, 20.4; in 1892-1896, 27.0; in 1897-1902, 33.92. Infant mortality is high especially among the peasants. As the less healthy infants rarely survive, the adult population is in general robust, hardy and long-lived. The census of January 1901 gives 2719 persons of 100 years and upwards. Young men, as a rule, marry before the age of twenty-five, girls before eighteen. The number of illegitimate births is inconsiderable, averaging only 0.12 of the total. The population according to sex in 1901 is given as 1,909,557 males and 1,834,710 females, or 51 males to 49 females. A somewhat similar disparity may be observed in the other countries of the Peninsula. Classified according to occupation, 2,802,603 persons, or 74.85% of the population, are engaged in agriculture; 360,834 in various productive industries; 118,824 in the service of the government or the exercise of liberal professions, and 148,999 in commerce. The population according to race cannot be stated with absolute accuracy, but it is approximately shown by the census of 1901, which gives the various nationalities according to language as follows:—Bulgars, 2,888,919; Turks, 531,240; Rumanians, 71,063; Greeks, 66,615; Gipsies (Tziganes), 89,549; Jews (Spanish speaking), 33,661; Tatars,

¹ Excess of births over deaths.

18,884; Armenians, 14,581; other nationalities, 30,451. The Bulgarian inhabitants of the Peninsula beyond the limits of the principality may, perhaps, be estimated at 1,500,000 or 1,600,000, and the grand total of the race possibly reaches 3,500,000.

Ethnology.—The Bulgarians, who constitute 77.14% of the inhabitants of the kingdom, are found in their purest type in the mountain districts, the Ottoman conquest and subsequent colonization having introduced a mixed population into the plains.

The devastation of the country which followed the Turkish invasion resulted in the extirpation or flight of a large proportion of the Bulgarian inhabitants of the lowlands, who were replaced by Turkish colonists. The mountainous districts, however, retained their original population and sheltered large numbers of the fugitives. The passage of the Turkish armies during the wars with Austria, Poland and Russia led to further Bulgarian emigrations. The flight to the Banat, where 22,000 Bulgarians still remain, took place in 1730. At the beginning of the 19th century the majority of the population of the Eastern Rumanian plain was Turkish. The Turkish colony, however, declined, partly in consequence of the drain caused by military service, while the Bulgarian remnant increased, notwithstanding a considerable emigration to Bessarabia before and after the Russo-Turkish campaign of 1828. Efforts were made by the Porte to strengthen the Moslem element by planting colonies of Tatars in 1861 and Circassians in 1864. The advance of the Russian army in 1877-1878 caused an enormous exodus of the Turkish population, of which only a small proportion returned to settle permanently. The emigration continued after the conclusion of peace, and is still in progress, notwithstanding the efforts of the Bulgarian government to arrest it. In twenty years (1879-1899), at least 150,000 Turkish peasants left Bulgaria. Much of the land thus abandoned still remains unoccupied. On the other hand, a considerable influx of Bulgarians from Macedonia, the vilayet of Adrianople, Bessarabia, and the Dobrudja took place within the same period, and the inhabitants of the mountain villages show a tendency to migrate into the richer districts of the plains.

The northern slopes of the Balkans from Belogradchik to Elena are inhabited almost exclusively by Bulgarians; in Eastern Rumelia the national element is strongest in the Sredna Gora and Rhodope. Possibly the most genuine representatives of the race are the Pomaks or Mahomedan Bulgarians, whose conversion to Islam preserved their women from the licence of the Turkish conqueror; they inhabit the highlands of Rhodope and certain districts in the neighbourhood of Lovtcha (Lovetch) and Plevna. Retaining their Bulgarian speech and many ancient national usages, they may be compared with the indigenous Cretan, Bosnian and Albanian Moslems. The Pomaks in the principality are estimated at 26,000, but their numbers are declining. In the north-eastern district between the Yantra and the Black Sea the Bulgarian race is as yet thinly represented; most of the inhabitants are Turks, a quiet, submissive, agricultural population, which unfortunately shows a tendency to emigrate. The Black Sea coast is inhabited by a variety of races. The Greek element is strong in the maritime towns, and displays its natural aptitude for navigation and commerce. The Gagäuzi, a peculiar race of Turkish-speaking Christians, inhabit the littoral from Cape Eminé to Cape Kaliakra: they are of Turanian origin and descend from the ancient Kumani. The valleys of the Maritza and Arda are occupied by a mixed population consisting of Bulgarians, Greeks and Turks; the principal Greek colonies are in Stanimaka, Kavakly and Philippopolis. The origin of the peculiar Shóp tribe which inhabits the mountain tracts of Sofia, Breznik and Radomir is a mystery. The Shóps are conceivably a remnant of the aboriginal race which remained undisturbed in its mountain home during the Slavonic and Bulgarian incursions: they cling with much tenacity to their distinctive customs, apparel and dialect. The considerable Vlach or Ruman colony in the Danubian districts dates from the 18th century, when large numbers of Walachian peasants sought a refuge on Turkish soil from the tyranny of the boyars or nobles: the department

of Vidin alone contains 36 Ruman villages with a population of 30,550. Especially interesting is the race of nomad shepherds from the Macedonian and the Aegean coast who come in thousands every summer to pasture their flocks on the Bulgarian mountains; they are divided into two tribes—the Kutzovlachs, or "lame Vlachs," who speak Rumanian, and the Hellenized Karakatchans or "black shepherds" (compare the Morlachs, or Mavro-vlachs, *μαύροι βλάχες*, of Dalmatia), who speak Greek. The Tatars, a peaceable, industrious race, are chiefly found in the neighbourhood of Varna and Silistria; they were introduced as colonists by the Turkish government in 1861. They may be reckoned at 12,000. The gipsies, who are scattered in considerable numbers throughout the country, came into Bulgaria in the 14th century. They are for the most part Moslems, and retain their ancient Indian speech. They live in the utmost poverty, occupy separate cantonments in the villages, and are treated as outcasts by the rest of the population. The Bulgarians, being of mixed origin, possess few salient physical characteristics. The Slavonic type is far less pronounced than among the kindred races; the Ugrian or Finnish cast of features occasionally asserts itself in the central Balkans. The face is generally oval, the nose straight, the jaw somewhat heavy. The men, as a rule, are rather below middle height, compactly built, and, among the peasantry, very muscular; the women are generally deficient in beauty and rapidly grow old. The upper class, the so-called *intelligensia*, is physically very inferior to the rural population.

National Character.—The character of the Bulgarians presents a singular contrast to that of the neighbouring nations. Less quick-witted than the Greeks, less prone to idealism than the Servians, less apt to assimilate the externals of civilization than the Rumanians, they possess in a remarkable degree the qualities of patience, perseverance and endurance, with the capacity for laborious effort peculiar to an agricultural race. The tenacity and determination with which they pursue their national aims may eventually enable them to vanquish their more brilliant competitors in the struggle for hegemony in the Peninsula. Unlike most southern races, the Bulgarians are reserved, taciturn, phlegmatic, unresponsive, and extremely suspicious of foreigners. The peasants are industrious, peaceable and orderly; the vendetta, as it exists in Albania, Montenegro and Macedonia, and the use of the knife in quarrels, so common in southern Europe, are alike unknown. The tranquillity of rural life has, unfortunately, been invaded by the intrigues of political agitators, and bloodshed is not uncommon at elections. All classes practise thrift bordering on parsimony, and any display of wealth is generally resented. The standard of sexual morality is high, especially in the rural districts; the unfaithful wife is an object of public contempt, and in former times was punished with death. Marriage ceremonies are elaborate and protracted, as is the case in most primitive communities; elopements are frequent, but usually take place with the consent of the parents on both sides, in order to avoid the expense of a regular wedding. The principal amusement on Sundays and holidays is the *choró* (*χορός*), which is danced on the village green to the strains of the *gaida* or bagpipe, and the *gásla*, a rudimentary fiddle. The Bulgarians are religious in a simple way, but not fanatical, and the influence of the priesthood is limited. Many ancient superstitions linger among the peasantry, such as the belief in the vampire and the evil eye; witches and necromancers are numerous and are much consulted.

Government.—Bulgaria is a constitutional monarchy; by Art. iii. of the Berlin Treaty it was declared hereditary in the family of a prince "freely elected by the population and confirmed by the Sublime Porte with the assent of the powers." According to the constitution of Trnovo, voted by the Assembly of Notables on the 20th of April 1879, revised by the Grand Sobranje on the 27th of May 1893, and modified by the proclamation of a Bulgarian kingdom on the 5th of October 1908, the royal dignity descends in the direct male line. The king must profess the Orthodox faith, only the first elected sovereign and his immediate heir being released from this obligation. The legislative power is vested in the king in conjunction with the

national assembly; he is supreme head of the army, supervises the executive power, and represents the country in its foreign relations. In case of a minority or an interregnum, a regency of three persons is appointed. The national representation is embodied in the Sobrane, or ordinary assembly (Bulgarian, *Sibrante*, the Russian form *Sobranie* being usually employed by foreign writers), and the Grand Sobrane, which is convoked in extraordinary circumstances. The Sobrane is elected by manhood suffrage, in the proportion of 1 to 20,000 of the population, for a term of five years. Every Bulgarian citizen who can read and write and has completed his thirtieth year is eligible as a deputy. Annual sessions are held from the 27th of October to the 27th of December. All legislative and financial measures must first be discussed and voted by the Sobrane and then sanctioned and promulgated by the king. The government is responsible to the Sobrane, and the ministers, whether deputies or not, attend its sittings. The Grand Sobrane, which is elected in the proportion of 2 to every 20,000 inhabitants, is convoked to elect a new king, to appoint a regency, to sanction a change in the constitution, or to ratify an alteration in the boundaries of the kingdom. The executive is entrusted to a cabinet of eight members—the ministers of foreign affairs and religion, finance, justice, public works, the interior, commerce and agriculture, education and war. Local administration, which is organized on the Belgian model, is under the control of the minister of the interior. The country is divided into twenty-two departments (*okrag*, pl. *okrasi*), each administered by a prefect (*upravitel*), assisted by a departmental council, and eighty-four sub-prefectures (*okoltsa*), each under a sub-prefect (*okolitski natchalnik*). The number of these functionaries is excessive. The four principal towns have each in addition a prefect of police (*gradonatchalnik*) and one or more commissaries (*pristav*). The gendarmery numbers about 4000 men, or 1 to 825 of the inhabitants. The prefects and sub-prefects have replaced the Turkish *mutessarifis* and *kaimakams*; but the system of municipal government, left untouched by the Turks, descends from primitive times. Every commune (*obshchina*), urban or rural, has its *kmet*, or mayor, and council; the commune is bound to maintain its primary schools, a public library or reading-room, &c.; the *kmet* possesses certain magisterial powers, and in the rural districts he collects the taxes. Each village, as a rule, forms a separate commune, but occasionally two or more villages are grouped together.

Justice.—The civil and penal codes are, for the most part, based on the Ottoman law. While the principality formed a portion of the Turkish empire, the privileges of the capitulations were guaranteed to foreign subjects (Berlin Treaty, Art. viii.). The lowest civil and criminal court is that of the village *kmet*, whose jurisdiction is confined to the limits of the commune; no corresponding tribunal exists in the towns. Each sub-prefecture and town has a justice of the peace—in some cases two or more; the number of these officials is 130. Next follows the departmental tribunal or court of first instance, which is competent to pronounce sentences of death, penal servitude and deprivation of civil rights; in specified criminal cases the judges are aided by three assessors chosen by lot from an annually prepared panel of forty-eight persons. Three courts of appeal sit respectively at Sofia, Rustchuk and Philippopolis. The highest tribunal is the court of cassation, sitting at Sofia, and composed of a president, two vice-presidents and nine judges. There is also a high court of audit (*vrkhovna smeina palata*), similar to the French *comptes des comptes*. The judges are poorly paid and are removable by the government. In regard to questions of marriage, divorce and inheritance the Greek, Mahomedan and Jewish communities enjoy their own spiritual jurisdiction.

Army and Navy.—The organization of the military forces of the principality was undertaken by Russian officers, who for a period of six years (1879–1885) occupied all the higher posts in the army. In Eastern Rumelia during the same period the "militia" was instructed by foreign officers; after the union it was merged in the Bulgarian army. The present organization is based on the law of the 1st of January 1904. The army consists

of: (1) the active or field army (*deistvoynushka armia*), divided into (i.) the active army, (ii.) the active army reserve; (2) the reserve army (*rezervna armia*); (3) the *optchenis* or militia; the two former may operate outside the kingdom, the latter only within the frontier for purposes of defence. In time of peace the active army (i.) alone is on a permanent footing.

The peace strength in 1905 was 2500 officers, 48,200 men and 8000 horses, the active army being composed of 9 divisions of infantry, each of 4 regiments, 5 regiments of cavalry together with 12 squadrons attached to the infantry divisions, 9 regiments of artillery each of 3 groups of 3 batteries, together with 2 groups of mountain artillery, each of 3 batteries, and 3 battalions of siege artillery; 9 battalions of engineers with 1 railway and balloon section and 1 bridging section. At the same date the army was locally distributed in nine divisional areas with headquarters at Sofia, Philippopolis, Sliven, Shumla, Rustchuk, Vratza, Pleвна, Stara-Zagora and Dupnitsa, the divisional area being subdivided into four districts, from each of which one regiment of four battalions was recruited and completed with reservists. In case of mobilization each of the nine areas would furnish 20,106 men (16,000 infantry, 1200 artillery, 1000 engineers, 300 divisional cavalry and 1606 transport and hospital services, &c.). The war strength thus amounted to about 380,954 of the active army and its reserve, exclusive of the five regiments of cavalry. In addition the 36 districts each furnished 3 battalions of the reserve army and one battalion of *optchenis*, or 144,000 infantry, which with the cavalry regiments (3000 men) and the reserves of artillery, engineers, divisional cavalry, &c. (about 10,000), would bring the grand total in time of war to about 338,000 officers and men with 18,000 horses. The men of the reserve battalions are drafted into the active army as occasion requires, but the militia serves as a separate force. Military service is obligatory, but Moslems may claim exemption on payment of £20; the age of recruitment in time of peace is nineteen, in time of war eighteen. Each conscript serves two years in the infantry and subsequently eight years in the active reserve, or three years in the other corps and six years in the active reserve; he is then liable to seven years' service in the reserve army and finally passes into the *optchenis*. The Bulgarian peasant makes an admirable soldier—courageous, obedient, persevering, and inured to hardship; the officers are painstaking and devoted to their duties. The active army and reserve, with the exception of the engineer regiments, are furnished with the 315th Mannlicher magazine rifle, the engineer and militia with the Berdan; the artillery in 1905 mainly consisted of 8.7- and 7.5-cm. Krupp guns (field) and 6.5-cm. Krupp (mountain), 12-cm. Krupp and 15-cm. Creuzot (Schneider) howitzers, 15-cm. Krupp and 11-cm. Creuzot siege guns, and 7.5-cm. Creuzot quick-firing guns; total of all description, 1154. Defensive works were constructed at various strategical points near the frontier and elsewhere, and at Varna and Burgas. The naval force consisted of a flotilla stationed at Rustchuk and Varna, where a canal connects Lake Devno with the sea. It was composed in 1905 of 1 prince's yacht, 1 armoured cruiser, 3 gunboats, 3 torpedo boats and 10 other small vessels, with a complement of 107 officers and 1231 men.

Religion.—The Orthodox Bulgarian National Church claims to be an indivisible member of the Eastern Orthodox communion, and asserts historic continuity with the autocephalous Bulgarian church of the middle ages. It was, however, declared schismatic by the Greek patriarch of Constantinople in 1872, although differing in no point of doctrine from the Greek Church. The Exarch, or supreme head of the Bulgarian Church, resides at Constantinople; he enjoys the title of "Beatitude" (*negovo Blazhenstvo*), receives an annual subvention of about £6000 from the kingdom, and exercises jurisdiction over the Bulgarian hierarchy in all parts of the Ottoman empire. The exarch is elected by the Bulgarian episcopate, the Holy Synod, and a general assembly (*obshchi sbor*), in which the laity is represented; their choice, before the declaration of Bulgarian independence, was subject to the sultan's approval. The occupant of the dignity is titular metropolitan of a Bulgarian diocese. The organization of the church within the principality was regulated

by statute in 1883. There are eleven eparchies or dioceses in the country, each administered by a metropolitan with a diocesan council; one diocese has also a suffragan bishop. Church government is vested in the Holy Synod, consisting of four metropolitans, which assembles once a year. The laity take part in the election of metropolitans and parish priests, only the "black clergy," or monks, being eligible for the episcopate. All ecclesiastical appointments are subject to the approval of the government. There are 2106 parishes (*eporisi*) in the kingdom with 9 archimandrites, 1936 parish priests and 21 deacons, 78 monasteries with 184 monks, and 12 convents with 346 nuns. The celebrated monastery of Rila possesses a vast estate in the Rilska Planina; its abbot or *hegumen* owns no spiritual superior but the exarch. Ecclesiastical affairs are under the control of the minister of public worship; the clergy of all denominations are paid by the state, being free, however, to accept fees for baptisms, marriages, burials, the administering of oaths, &c. The census of January 1901 gives 3,019,999 persons of the Orthodox faith (including 66,635 Patriarchist Greeks), 643,300 Mahomedans, 33,663 Jews, 28,569 Catholics, 13,809 Gregorian Armenians, 4,524 Protestants and 419 whose religion is not stated. The Greek Orthodox community has four metropolitans dependent on the patriarchate. The Mahomedan community is rapidly diminishing; it is organized under 16 muftis who with their assistants receive a subvention from the government. The Catholics, who have two bishops, are for the most part the descendants of the medieval Paulicians; they are especially numerous in the neighbourhood of Philippopolis and Sistova. The Armenians have one bishop. The Protestants are mostly Methodists; since 1857 Bulgaria has been a special field of activity for American Methodist missionaries, who have established an important school at Samakov. The Berlin Treaty (Art. V.) forbade religious disabilities in regard to the enjoyment of civil and political rights, and guaranteed the free exercise of all religions.

Education.—No educational system existed in many of the rural districts before 1878; the peasantry was sunk in ignorance, and the older generation remained totally illiterate. In the towns the schools were under the superintendence of the Greek clergy, and Greek was the language of instruction. The first Bulgarian school was opened at Gabrovo in 1835 by the patriots Aprilov and Neophyt Rilski. After the Crimean War, Bulgarian schools began to appear in the villages of the Balkans and the south-eastern districts. The children of the wealthier class were generally educated abroad. The American institution of Robert College on the Bosphorus rendered an invaluable service to the newly created state by providing it with a number of well-educated young men fitted for positions of responsibility. In 1878, after the liberation of the country, there were 1658 schools in the towns and villages. Primary education was declared obligatory from the first, but the scarcity of properly qualified teachers and the lack of all requisites proved serious impediments to educational organization. The government has made great efforts and incurred heavy expenditure for the spread of education; the satisfactory results obtained are largely due to the keen desire for learning which exists among the people. The present educational system dates from 1891. Almost all the villages now possess "national" (*narodni*) primary schools, maintained by the communes with the aid of a state subvention and supervised by departmental and district inspectors. The state also assists a large number of Turkish primary schools. The penalties for non-attendance are not very rigidly enforced, and it has been found necessary to close the schools in the rural districts during the summer, the children being required for labour in the fields.

The age for primary instruction is six to ten years; in 1890, 47.01 % of the boys and 16.11 % of the girls attended the primary schools; in 1898, 85 % of the boys and 40 % of the girls. In 1904 there were 4344 primary schools, of which 3060 were "national," or communal, and 1284 denominational (Turkish, Greek, Jewish, &c.), attended by 340,668 pupils, representing a proportion of 9.1 per hundred inhabitants. In addition to the primary schools, 40 infant schools for children of 3 to 6 years of age were attended

by 2707 pupils. In 1888 only 327,766 persons, or 11 % of the population, were literate; in 1893 the proportion rose to 19.88 %; in 1901 to 23.9 %.

In the system of secondary education the distinction between the classical and "real" or special course of study is maintained as in most European countries; in 1904 there were 175 secondary schools and 18 gymnasia (10 for boys and 8 for girls). In addition to these there are 6 technical and 3 agricultural schools; 5 of pedagogy, 1 theological, 1 commercial, 1 of forestry, 1 of design, 1 for surgeons' assistants, and a large military school at Sofia. Government aid is given to students of limited means, both for secondary education and the completion of their studies abroad. The university of Sofia, formerly known as the "high school," was reorganized in 1904; it comprises 3 faculties (philology, mathematics and law), and possesses a staff of 17 professors and 25 lecturers. The number of students in 1905 was 943.

POLITICAL HISTORY

The ancient Thracio-Illyrian race which inhabited the district between the Danube and the Aegean was expelled, or more probably absorbed, by the great Slavonic immigration which took place at various intervals between the end of the 3rd century after Christ and the beginning of the 6th. The numerous tumuli which are found in all parts of the country (see Herodotus v. 8) and some stone tablets with bas-reliefs remain as monuments of the aboriginal population; and certain structural peculiarities, which are common to the Bulgarian and Rumanian languages, may conceivably be traced to the influence of the primitive Illyrian speech, now probably represented by the Albanian. The Slavs, an agricultural people, were governed, even in those remote times, by the democratic local institutions to which they are still attached; they possessed no national leaders or central organization, and their only political unit was the *pleme*, or tribe. They were considerably influenced by contact with Roman civilization. It was reserved for a foreign race, altogether distinct in origin, religion and customs, to give unity and coherence to the scattered Slavonic groups, and to weld them into a compact and powerful state which for some centuries played an important part in the history of eastern Europe and threatened the existence of the Byzantine empire.

The Bulgars.—The Bulgars, a Turanian race akin to the Tatars, Huns, Avars, Petchenegs and Finns, made their appearance on the banks of the Pruth in the latter part of the 7th century. They were a horde of wild horsemen, fierce and barbarous, practising polygamy, and governed despotically by their *khans* (chiefs) and *boyars* or *boyars* (nobles). Their original abode was the tract between the Ural mountains and the Volga, where the kingdom of Great (or Black) Bolgary existed down to the 13th century. In 679, under their khan Asparukh (or Isperikh), they crossed the Danube, and, after subjugating the Slavonic population of Moesia, advanced to the gates of Constantinople and Salonica. The East Roman emperors were compelled to cede to them the province of Moesia and to pay them an annual tribute. The invading horde was not numerous, and during the next two centuries it became gradually merged in the Slavonic population. Like the Franks in Gaul the Bulgars gave their name and a political organization to the more civilized race which they conquered, but adopted its language, customs and local institutions. Not a trace of the Ugrian or Finnish element is to be found in the Bulgarian speech. This complete assimilation of a conquering race may be illustrated by many parallels.

Early Dynasties.—The history of the early Bulgarian dynasties is little else than a record of continuous conflicts with the Byzantine emperors. The tribute first imposed on the Greeks by Asparukh was again exacted by Kardam (791-797) and Krum (802-815), a sovereign noted alike for his cruelty and his military and political capacity. Under his rule the Bulgarian realm extended from the Carpathians to the neighbourhood of Adrianople; Serdica (the present Sofia) was taken, and the valley of the Struma conquered. Prěslav, the Bulgarian capital, was attacked and burned by the emperor Nicephorus, but the Greek army on its return was annihilated in one of the Balkan passes; the emperor was slain, and his skull was converted by Krum into a goblet. The reign of Boris (852-884) is memorable

for the introduction of Christianity into Bulgaria. Two monks of Salonica, SS. Cyril and Methodius, are generally revered as the national apostles; the scene of their labours, however, was among the Slavs of Moravia, and the Bulgars were evangelized by their disciples. Boris, finding himself surrounded by Christian states, decided from political motives to abandon paganism. He was baptized in 864, the emperor Michael III. acting as his sponsor. It was at this time that the controversies broke out which ended in the schism between the Churches of the East and West. Boris long wavered between Constantinople and Rome, but the refusal of the pope to recognize an autocephalous Bulgarian church determined him to offer his allegiance to the Greek patriarch. The decision was fraught with momentous consequences for the future of the race. The nation altered its religion in obedience to its sovereign, and some of the boyars who resisted the change paid with their lives for their fidelity to the ancient belief. The independence of the Bulgarian church was recognized by the patriarchate, a fact much dwelt upon in recent controversies. The Bulgarian primates subsequently received the title of patriarch; their see was transferred from Prěslav to Sofia, Voden and Prespa successively, and finally to Ochrida.

The First Empire.—The national power reached its zenith under Simeon (893-927), a monarch distinguished in the arts of war and peace. In his reign, says Gibbon, "Bulgaria assumed a rank among the civilized powers of the earth." His dominions extended from the Black Sea to the Adriatic, and from the borders of Thessaly to the Save and the Carpathians. Having become the most powerful monarch in eastern Europe, Simeon assumed the style of "Emperor and Autocrat of all the Bulgars and Greeks" (*tsar i samodržavets vsēm Blgarom i Grkom*), a title which was recognized by Pope Formosus. During the latter years of his reign, which were spent in peace, his people made great progress in civilization, literature flourished, and Prěslav, according to contemporary chroniclers, rivalled Constantinople in magnificence. After the death of Simeon the Bulgarian power declined owing to internal dissensions; the land was distracted by the Bogomil heresy (see BOGOMILS), and a separate or western empire, including Albania and Macedonia, was founded at Ochrida by Shishman, a boyar from Trnovo. A notable event took place in 967, when the Russians, under Sviatoslav, made their first appearance in Bulgaria. The Bulgarian tsar, Boris II., with the aid of the emperor John Zimisces, expelled the invaders, but the Greeks took advantage of their victory to dethrone Boris, and the first Bulgarian empire thus came to an end after an existence of three centuries. The empire at Ochrida, however, rose to considerable importance under Samuel, the son of Shishman (976-1014), who conquered the greater part of the Peninsula, and ruled from the Danube to the Morea. After a series of campaigns this redoubtable warrior was defeated at Bělasitza by the emperor Basil II., surnamed Bulgaroktonos, who put out the eyes of 15,000 prisoners taken in the fight, and sent them into the camp of his adversary. The Bulgarian tsar was so overpowered by the spectacle that he died of grief. A few years later his dynasty finally disappeared, and for more than a century and a half (1018-1186) the Bulgarian race remained subject to the Byzantine emperors.

The Second Empire.—In 1186, after a general insurrection of Vlachs and Bulgars under the brothers Ivan and Peter Asēn of Trnovo, who claimed descent from the dynasty of the Shishmanovtzi, the nation recovered its independence, and Ivan Asēn assumed the title of "Tsar of the Bulgars and Greeks." The seat of the second, or "Bulgaro-Vlach" empire was at Trnovo, which the Bulgarians regard as the historic capital of their race. Kaloyan, the third of the Asēn monarchs, extended his dominions to Belgrade, Nish and Skopje (Uskub); he acknowledged the spiritual supremacy of the pope, and received the royal crown from a papal legate. The greatest of all Bulgarian rulers was Ivan Asēn II. (1218-1241), a man of humane and enlightened character. After a series of victorious campaigns he established his sway over Albania, Epirus, Macedonia and Thrace, and governed his wide dominions with justice, wisdom and moderation. In his time the nation attained a prosperity hitherto

unknown: commerce, the arts and literature flourished; Trnovo, the capital, was enlarged and embellished, and great numbers of churches and monasteries were founded or endowed. The dynasty of the Asēns became extinct in 1257, and a period of decadence began. Two other dynasties, both of Kuman origin, followed—the Terterovtzi, who ruled at Trnovo, and the Shishmanovtzi, who founded an independent state at Vidin, but afterwards reigned in the national capital. Eventually, on the 28th June 1330, a day commemorated with sorrow in Bulgaria, Tsar Michael Shishman was defeated and slain by the Servians, under Stephen Urosh III., at the battle of Vělbuzhd (Kjüstendil). Bulgaria, though still retaining its native rulers, now became subject to Servia, and formed part of the short-lived empire of Stephen Dushan (1331-1355). The Servian hegemony vanished after the death of Dushan, and the Christian races of the Peninsula, distracted by the quarrels of their petty princes, fell an easy prey to the advancing might of the Moslem invader.

The Turkish Conquest.—In 1340 the Turks had begun to ravage the valley of the Maritza; in 1362 they captured Philippopolis, and in 1382 Sofia. In 1366 Ivan Shishman III., the last Bulgarian tsar, was compelled to declare himself the vassal of the sultan Murad I., and to send his sister to the harem of the conqueror. In 1389 the rout of the Servians, Bosnians and Croats on the famous field of Kossovo decided the fate of the Peninsula. Shortly afterwards Ivan Shishman was attacked by the Turks; and Trnovo, after a siege of three months, was captured, sacked and burnt in 1393. The fate of the last Bulgarian sovereign is unknown: the national legend represents him as perishing in a battle near Samakov. Vidin, where Ivan's brother, Strazhimir, had established himself, was taken in 1396, and with its fall the last remnant of Bulgarian independence disappeared.

The five centuries of Turkish rule (1396-1878) form a dark epoch in Bulgarian history. The invaders carried fire and sword through the land; towns, villages and monasteries were sacked and destroyed, and whole districts were converted into desolate wastes. The inhabitants of the plains fled to the mountains, where they founded new settlements. Many of the nobles embraced the creed of Islam, and were liberally rewarded for their apostasy; others, together with numbers of the priests and people, took refuge across the Danube. All the regions formerly ruled by the Bulgarian tsars, including Macedonia and Thrace, were placed under the administration of a governor-general, styled the beylerbey of Rum-ili, residing at Sofia; Bulgaria proper was divided into the sanjaks of Sofia, Nikopolis, Vidin, Silistria and Kjustendil. Only a small proportion of the people followed the example of the boyars in abandoning Christianity; the conversion of the isolated communities now represented by the Pomaks took place at various intervals during the next three centuries. A new kind of feudal system replaced that of the boyars, and fiefs or *spahiliks* were conferred on the Ottoman chiefs and the renegade Bulgarian nobles. The Christian population was subjected to heavy imposts, the principal being the *haratch*, or capitation-tax, paid to the imperial treasury, and the tithes on agricultural produce, which was collected by the feudal lord. Among the most cruel forms of oppression was the requisitioning of young boys between the ages of ten and twelve, who were sent to Constantinople as recruits for the corps of janissaries. Notwithstanding the horrors which attended the Ottoman conquest, the condition of the peasantry during the first three centuries of Turkish government was scarcely worse than it had been under the tyrannical rule of the boyars. The contemptuous indifference with which the Turks regarded the Christian *rayas* was not altogether to the disadvantage of the subject race. Military service was not exacted from the Christians, no systematic effort was made to extinguish either their religion or their language, and within certain limits they were allowed to retain their ancient local administration and the jurisdiction of their clergy in regard to inheritances and family affairs. At the time of the conquest certain towns and villages, known as the *vojnichki sela*, obtained important privileges which were not infringed till the 18th century; on condition of

furnishing contingents to the Turkish army or grooms for the sultan's horses they obtained exemption from most of the taxes and complete self-government under their *voivodi* or chiefs. Some of them, such as Koprivshitzia in the Sredna Gora, attained great prosperity, which has somewhat declined since the establishment of the principality. While the Ottoman power was at its height the lot of the subject-races was far less intolerable than during the period of decadence, which began with the unsuccessful siege of Vienna in 1683. Their rights and privileges were respected, the law was enforced, commerce prospered, good roads were constructed, and the great caravans of the Ragusan merchants traversed the country. Down to the end of the 18th century there appears to have been only one serious attempt at revolt—that occasioned by the advance of Prince Sigismund Báthory into Walachia in 1595. A kind of guerilla warfare was, however, maintained in the mountains by the *kaidusi*, or outlaws, whose exploits, like those of the Greek *klephts*, have been highly idealized in the popular folk-lore. As the power of the sultans declined anarchy spread through the Peninsula. In the earlier decades of the 18th century the Bulgarians suffered terribly from the ravages of the Turkish armies passing through the land during the wars with Austria. Towards its close their condition became even worse owing to the horrors perpetrated by the *Krjalis*, or troops of disbanded soldiers and desperadoes, who, in defiance of the Turkish authorities, roamed through the country, supporting themselves by plunder and committing every conceivable atrocity. After the peace of Belgrade (1737), by which Austria lost her conquests in the Peninsula, the Servians and Bulgarians began to look to Russia for deliverance, their hopes being encouraged by the treaty of Kuchuk Kalnarji (1774), which foreshadowed the claim of Russia to protect the Orthodox Christians in the Turkish empire. In 1794 Pasvanoglu, one of the chiefs of the *Krjalis*, established himself as an independent sovereign at Vidin, putting to flight three large Turkish armies which were despatched against him. This adventurer possessed many remarkable qualities. He adorned Vidin with handsome buildings, maintained order, levied taxes and issued a separate coinage. He died in 1807. The memoirs of Sofronii, bishop of Vratza, present a vivid picture of the condition of Bulgaria at this time. "My diocese," he writes, "was laid desolate; the villages disappeared—they had been burnt by the *Krjalis* and Pasvan's brigands; the inhabitants were scattered far and wide over Walachia and other lands."

The National Revival.—At the beginning of the 19th century the existence of the Bulgarian race was almost unknown in Europe, even to students of Slavonic literature. Disheartened by ages of oppression, isolated from Christendom by their geographical position, and cowed by the proximity of Constantinople, the Bulgarians took no collective part in the insurrectionary movement which resulted in the liberation of Servia and Greece. The Russian invasions of 1810 and 1828 only added to their sufferings, and great numbers of fugitives took refuge in Bessarabia, annexed by Russia under the treaty of Bucharest. But the long-dormant national spirit now began to awake under the influence of a literary revival. The precursors of the movement were Paisii, a monk of Mount Athos, who wrote a history of the Bulgarian tsars and saints (1762), and Bishop Sofronii, whose memoirs have been already mentioned. After 1824 several works written in modern Bulgarian began to appear, but the most important step was the foundation, in 1835, of the first Bulgarian school at Gabrovo. Within ten years at least 53 Bulgarian schools came into existence, and five Bulgarian printing-presses were at work. The literary movement led the way to a reaction against the influence and authority of the Greek clergy. The spiritual domination of the Greek patriarchate had tended more effectually than the temporal power of the Turks to the effacement of Bulgarian nationality. After the conquest of the Peninsula the Greek patriarch became the representative at the Sublime Porte of the *Râm-millet*, the Roman nation, in which all the Christian nationalities were comprised. The independent patriarchate of Trnovo was

suppressed; that of Ochrida was subsequently Hellenized. The Phanariot clergy—unscrupulous, rapacious and corrupt—succeeded in monopolizing the higher ecclesiastical appointments and filled the parishes with Greek priests, whose schools, in which Greek was exclusively taught, were the only means of instruction open to the population. By degrees Greek became the language of the upper classes in all the Bulgarian towns, the Bulgarian language was written in Greek characters, and the illiterate peasants, though speaking the vernacular, called themselves Greeks. The Slavonic liturgy was suppressed in favour of the Greek, and in many places the old Bulgarian manuscripts, images, testaments and missals were committed to the flames. The patriots of the literary movement, recognizing in the patriarchate the most determined foe to a national revival, directed all their efforts to the abolition of Greek ecclesiastical ascendancy and the restoration of the Bulgarian autonomous church. Some of the leaders went so far as to open negotiations with Rome, and an archbishop of the Uniate Bulgarian church was nominated by the pope. The struggle was prosecuted with the utmost tenacity for forty years. Incessant protests and memorials were addressed to the Porte, and every effort was made to undermine the position of the Greek bishops, some of whom were compelled to abandon their sees. At the same time no pains were spared to diffuse education and to stimulate the national sentiment. Various insurrectionary movements were attempted by the patriots Rakovski, Panayot Khitoff, Haji Dimitr, Stephen Karaja and others, but received little support from the mass of the people. The recognition of Bulgarian nationality was won by the pen, not the sword. The patriarchate at length found it necessary to offer some concessions, but these appeared illusory to the Bulgarians, and long and acrimonious discussions followed. Eventually the Turkish government intervened, and on the 28th of February 1870 a firman was issued establishing the Bulgarian exarchate, with jurisdiction over fifteen dioceses, including Nish, Pirot and Veles; the other dioceses in dispute were to be added to these in case two-thirds of the Christian population so desired. The election of the first exarch was delayed till February 1872, owing to the opposition of the patriarch, who immediately afterwards excommunicated the new head of the Bulgarian church and all his followers. The official recognition now acquired tended to consolidate the Bulgarian nation and to prepare it for the political developments which were soon to follow. A great educational activity at once displayed itself in all the districts subjected to the new ecclesiastical power.

The Revolt of 1876.—Under the enlightened administration of Midhat Pasha (1864–1868) Bulgaria enjoyed comparative prosperity, but that remarkable man is not remembered with gratitude by the people owing to the severity with which he repressed insurrectionary movements. In 1861, 12,000 Crimean Tatars, and in 1864 a still larger number of Circassians from the Caucasus, were settled by the Turkish government on lands taken without compensation from the Bulgarian peasants. The Circassians, a lawless race of mountaineers, proved a veritable scourge to the population in their neighbourhood. In 1875 the insurrection in Bosnia and Herzegovina produced immense excitement throughout the Peninsula. The fanaticism of the Moslems was aroused, and the Bulgarians, fearing a general massacre of Christians, endeavoured to anticipate the blow by organizing a general revolt. The rising, which broke out prematurely at Koprivshitzia and Panagurishtë in May 1876, was mainly confined to the sanjak of Philippopolis. Bands of bashi-bazouks were let loose throughout the district by the Turkish authorities, the Pomaks, or Moslem Bulgarians, and the Circassian colonists were called to arms, and a succession of horrors followed to which a parallel can scarcely be found in the history of the middle ages. The principal scenes of massacre were Panagurishtë, Perushitzia, Bratizgovo and Batak; at the last-named town, according to an official British report, 5000 men, women and children were put to the sword by the Pomaks under Achmet Aga, who was decorated by the sultan for this exploit. Altogether some 15,000 persons were massacred in the

district of Philippopolis, and fifty-eight villages and five monasteries were destroyed. Isolated risings which took place on the northern side of the Balkans were crushed with similar barbarity. These atrocities, which were first made known by an English journalist and an American consular official, were denounced by Gladstone in a celebrated pamphlet which aroused the indignation of Europe. The great powers remained inactive, but Servia declared war in the following month, and her army was joined by 2000 Bulgarian volunteers. A conference of the representatives of the powers, held at Constantinople towards the end of the year, proposed, among other reforms, the organization of the Bulgarian provinces, including the greater part of Macedonia, in two vilayets under Christian governors, with popular representation. These recommendations were practically set aside by the Porte, and in April 1877 Russia declared war (see RUSSO-TURKISH WARS, and PLEVNA). In the campaign which followed the Bulgarian volunteer contingent in the Russian army played an honourable part; it accompanied Gourko's advance over the Balkans, behaved with great bravery at Stara Zagora, where it lost heavily, and rendered valuable services in the defence of Shipka.

Treaties of San Stefano and Berlin.—The victorious advance of the Russian army to Constantinople was followed by the treaty of San Stefano (3rd March 1878), which realized almost to the full the national aspirations of the Bulgarian race. All the provinces of European Turkey in which the Bulgarian element predominated were now included in an autonomous principality, which extended from the Black Sea to the Albanian mountains, and from the Danube to the Aegean, enclosing Ohrida, the ancient capital of the Shishmans, Dibra and Kastoria, as well as the districts of Vranja and Pirot, and possessing a Mediterranean port at Kavala. The Dobrudja, notwithstanding its Bulgarian population, was not included in the new state, being reserved as compensation to Rumania for the Russian annexation of Bessarabia; Adrianople, Salonica and the Chalcidian peninsula were left to Turkey. The area thus delimited constituted three-fifths of the Balkan Peninsula, with a population of 4,000,000 inhabitants. The great powers, however, anticipating that this extensive territory would become a Russian dependency, intervened; and on the 13th of July of the same year was signed the treaty of Berlin, which in effect divided the "Big Bulgaria" of the treaty of San Stefano into three portions. The limits of the principality of Bulgaria, as then defined, and the autonomous province of Eastern Rumelia, have been already described; the remaining portion, including almost the whole of Macedonia and part of the vilayet of Adrianople, was left under Turkish administration. No special organization was provided for the districts thus abandoned; it was stipulated that laws similar to the organic law of Crete should be introduced into the various parts of Turkey in Europe, but this engagement was never carried out by the Porte. Vranja, Pirot and Nish were given to Servia, and the transference of the Dobrudja to Rumania was sanctioned. This artificial division of the Bulgarian nation could scarcely be regarded as possessing elements of permanence. It was provided that the prince of Bulgaria should be freely elected by the population, and confirmed by the Sublime Porte with the assent of the powers, and that, before his election, an assembly of Bulgarian notables, convoked at Trnovo, should draw up the organic law of the principality. The drafting of a constitution for Eastern Rumelia was assigned to a European commission.

The Constitution of Trnovo.—Pending the completion of their political organization, Bulgaria and Eastern Rumelia were occupied by Russian troops and administered by Russian officials. The assembly of notables, which met at Trnovo in 1879, was mainly composed of half-educated peasants, who from the first displayed an extremely democratic spirit, in which they proceeded to manipulate the very liberal constitution submitted to them by Prince Dondukov-Korsakov, the Russian governor-general. The long period of Turkish domination had effectually obliterated all social distinctions, and the radical element,

which now formed into a party under Tzankoff and Karaveloff, soon gave evidence of its predominance. Manhood suffrage, a single chamber, payment of deputies, the absence of property qualification for candidates, and the prohibition of all titles and distinctions, formed salient features in the constitution now elaborated. The organic statute of Eastern Rumelia was largely modelled on the Belgian constitution. The governor-general, nominated for five years by the sultan with the approbation of the powers, was assisted by an assembly, partly representative, partly composed of *ex-officio* members; a permanent committee was entrusted with the preparation of legislative measures and the general supervision of the administration, while a council of six "directors" fulfilled the duties of a ministry.

Prince Alexander.—On the 29th of April 1879 the assembly at Trnovo, on the proposal of Russia, elected as first sovereign of Bulgaria Prince Alexander of Battenberg, a member of the grand ducal house of Hesse and a nephew of the tsar Alexander II. Arriving in Bulgaria on the 7th of July, Prince Alexander, then in his twenty-third year, found all the authority, military and civil, in Russian hands. The history of the earlier portion of his reign is marked by two principal features—a strong Bulgarian reaction against Russian tutelage and a vehement struggle against the autocratic institutions which the young ruler, under Russian guidance, endeavoured to inaugurate. Both movements were symptomatic of the determination of a strong-willed and egoistic race, suddenly liberated from secular oppression, to enjoy to the full the moral and material privileges of liberty. In the assembly at Trnovo the popular party had adopted the watchword "Bulgaria for the Bulgarians," and a considerable anti-Russian contingent was included in its ranks. Young and inexperienced, Prince Alexander, at the suggestion of the Russian consul-general, selected his first ministry from a small group of "Conservative" politicians whose views were in conflict with those of the parliamentary majority, but he was soon compelled to form a "Liberal" administration under Tzankoff and Karaveloff. The Liberals, once in power, initiated a violent campaign against foreigners in general and the Russians in particular; they passed an alien law, and ejected foreigners from every lucrative position. The Russians made a vigorous resistance, and a state of chaos ensued. Eventually the prince, finding good government impossible, obtained the consent of the tsar to a change of the constitution, and assumed absolute authority on the 9th of May 1881. The Russian general Ernsth was appointed sole minister, and charged with the duty of holding elections for the Grand Sobranje, to which the right of revising the constitution appertained. So successfully did he discharge his mission that the national representatives, almost without debate, suspended the constitution and invested the prince with absolute powers for a term of seven years (July 1881). A period of Russian government followed under Generals Skobeljev and Kaulbars, who were specially despatched from St Petersburg to enhance the authority of the prince. Their administration, however, tended to a contrary result, and the prince, finding himself reduced to impotence, opened negotiations with the Bulgarian leaders and effected a coalition of all parties on the basis of a restoration of the constitution. The generals, who had made an unsuccessful attempt to remove the prince, withdrew; the constitution of Trnovo was restored by proclamation (19th September 1883), and a coalition ministry was formed under Tzankoff. Prince Alexander, whose relations with the court of St Petersburg had become less cordial since the death of his uncle, the tsar Alexander II., in 1881, now incurred the serious displeasure of Russia, and the breach was soon widened by the part which he played in encouraging the national aspirations of the Bulgarians.

Union with Eastern Rumelia.—In Eastern Rumelia, where the Bulgarian population never ceased to protest against the division of the race, political life had developed on the same lines as in the principality. Among the politicians two parties had come into existence—the Conservatives or self-styled "Unionists," and the Radicals, derisively called by their opponents

"Kazioni" or treasury-seekers; both were equally desirous of bringing about the union with the principality. Neither party, however, while in power would risk the sweets of office by embarking in a hazardous adventure. It was reserved for the Kazioni, under their famous leader Zakharia Stoyánoff, who in early life had been a shepherd, to realize the national programme. In 1885 the Unionists were in office, and their opponents lost no time in organizing a conspiracy for the overthrow of the governor-general, Krstovitch Pasha. Their designs were facilitated by the circumstance that Turkey had abstained from sending troops into the province. Having previously assured themselves of Prince Alexander's acquiescence, they seized the governor-general and proclaimed the union with Bulgaria (18th September). The revolution took place without bloodshed, and a few days later Prince Alexander entered Philippopolis amid immense enthusiasm. His position now became precarious. The powers were scandalized at the infraction of the Berlin Treaty; Great Britain alone showed sympathy, while Russia denounced the union and urged the Porte to reconquer the revolted province—both powers thus reversing their respective attitudes at the congress of Berlin.

War with Servia.—The Turkish troops were massed at the frontier, and Servia, hoping to profit by the difficulties of her neighbour, suddenly declared war (14th November). At the moment of danger the Russian officers, who filled all the higher posts in the Bulgarian army, were withdrawn by order of the tsar. In these critical circumstances Prince Alexander displayed considerable ability and resource, and the nation gave evidence of hitherto unsuspected qualities. Contrary to general expectation, the Bulgarian army, imperfectly equipped and led by subaltern officers, successfully resisted the Servian invasion. After brilliant victories at Slivnitza (19th November) and Tsaribrod, Prince Alexander crossed the frontier and captured Pirot (27th November), but his farther progress was arrested by the intervention of Austria (see SERVO-BULGARIAN WAR). The treaty of Bucharest followed (3rd of March 1886), declaring, in a single clause, the restoration of peace. Servia, notwithstanding her aggression, escaped a war indemnity, but the union with Eastern Rumelia was practically secured. By the convention of Top-Khané (5th April) Prince Alexander was recognized by the sultan as governor-general of eastern Rumelia; a personal union only was sanctioned, but in effect the organic statute disappeared and the countries were administratively united. These military and diplomatic successes, which invested the prince with the attributes of a national hero, quickened the decision of Russia to effect his removal. An instrument was found in the discontent of several of his officers, who considered themselves slighted in the distribution of rewards, and a conspiracy was formed in which Tzankoff, Karaveloff (the prime minister), Archbishop Clement, and other prominent persons were implicated. On the night of the 21st of August the prince was seized in his palace by several officers and compelled, under menace of death, to sign his abdication; he was then hurried to the Danube at Rakhovo and transported to Russian soil at Reni. This violent act met with instant disapproval on the part of the great majority of the nation. Stamboloff, the president of the assembly, and Colonel Mulkuroff, commandant of the troops at Philippopolis, initiated a counter-revolution; the provisional government set up by the conspirators immediately fell, and a few days later the prince, who had been liberated by the Russian authorities, returned to the country amid every demonstration of popular sympathy and affection. His arrival forestalled that of a Russian imperial commissioner, who had been appointed to proceed to Bulgaria. He now committed the error of addressing a telegram to the tsar in which he offered to resign his crown into the hands of Russia. This unfortunate step, by which he ignored the suzerainty of Turkey, and represented Bulgaria as a Russian dependency, exposed him to a stern rebuff, and fatally compromised his position. The national leaders, after obtaining a promise from the Russian representative at Sofia that Russia would abstain from interference in the internal affairs of the country, consented to his departure; on

the 8th of September he announced his abdication, and on the following day he left Bulgaria.

The Regency.—A regency was now formed, in which the prominent figure was Stamboloff, the most remarkable man whom modern Bulgaria has produced. A series of attempts to throw the country into anarchy were firmly dealt with, and the Grand Sobrane was summoned to elect a new prince. The candidature of the prince of Mingrelia was now set up by Russia, and General Kaulbars was despatched to Bulgaria to make known to the people the wishes of the tsar. He vainly endeavoured to postpone the convocation of the Grand Sobrane in order to gain time for the restoration of Russian influence, and proceeded on an electoral tour through the country. The failure of his mission was followed by the withdrawal of the Russian representatives from Bulgaria. The Grand Sobrane, which assembled at Trnovo, offered the crown to Prince Valdemar of Denmark, brother-in-law of the tsar, but the honour was declined, and an anxious period ensued, during which a deputation visited the principal capitals of Europe with the twofold object of winning sympathy for the cause of Bulgarian independence and discovering a suitable candidate for the throne.

Prince Ferdinand.—On the 7th of July 1887, the Grand Sobrane unanimously elected Prince Ferdinand of Saxe-Coburg-Gotha, a grandson, maternally, of King Louis Philippe. The new prince, who was twenty-six years of age, was at this time a lieutenant in the Austrian army. Undeterred by the difficulties of the international situation and the distracted condition of the country, he accepted the crown, and took over the government on the 14th of August at Trnovo. His arrival, which was welcomed with enthusiasm, put an end to a long and critical interregnum, but the dangers which menaced Bulgarian independence were far from disappearing. Russia declared the newly-elected sovereign a usurper; the other powers, in deference to her susceptibilities, declined to recognize him, and the grand vizier informed him that his presence in Bulgaria was illegal. Numerous efforts were made by the partisans of Russia to disturb internal tranquillity, and Stamboloff, who became prime minister on the 1st of September, found it necessary to govern with a strong hand. A raid led by the Russian captain Nabokov was repulsed; brigandage, maintained for political purposes, was exterminated; the bishops of the Holy Synod, who, at the instigation of Clement, refused to pay homage to the prince, were forcibly removed from Sofia; a military conspiracy organized by Major Panitza was crushed, and its leader executed. An attempt to murder the energetic prime minister resulted in the death of his colleague, Beltcheff, and shortly afterwards Dr Vikovitch, the Bulgarian representative at Constantinople, was assassinated. While contending with unscrupulous enemies at home, Stamboloff pursued a successful policy abroad. Excellent relations were established with Turkey and Rumania, valuable concessions were twice extracted from the Porte in regard to the Bulgarian episcopate in Macedonia, and loans were concluded with foreign financiers on comparatively favourable terms. His overbearing character, however, increased the number of his opponents, and alienated the goodwill of the prince.

In the spring of 1893 Prince Ferdinand married Princess Marie-Louise of Bourbon-Parma, whose family insisted on the condition that the issue of the marriage should be brought up in the Roman Catholic faith. In view of the importance of establishing a dynasty, Stamboloff resolved on the unpopular course of altering the clause of the constitution which required that the heir to the throne should belong to the Orthodox Church, and the Grand Sobrane, which was convoked at Trnovo in the summer, gave effect to this decision. The death of Prince Alexander, which took place in the autumn, and the birth of an heir, tended to strengthen the position of Prince Ferdinand, who now assumed a less compliant attitude towards the prime minister. In 1894 Stamboloff resigned office; a ministry was formed under Dr Stoloff, and Prince Ferdinand inaugurated a policy of conciliation towards Russia with a view to obtaining his recognition by the powers. A Russophil

reaction followed, large numbers of political refugees returned to Bulgaria, and Stamboloff, exposed to the vengeance of his enemies, was assassinated in the streets of Sofia (15th July 1895).

The prince's plans were favoured by the death of the tsar Alexander III. in November 1894, and the reconciliation was practically effected by the conversion of his eldest son, Prince Boris, to the Orthodox faith (14th February 1896). The powers having signified their assent, he was nominated by the sultan prince of Bulgaria and governor-general of Eastern Rumelia (14th March). Russian influence now became predominant in Bulgaria, but the cabinet of St Petersburg wisely abstained from interfering in the internal affairs of the principality. In February 1896 Russia proposed the reconciliation of the Greek and Bulgarian churches and the removal of the exarch to Sofia. The project, which involved a renunciation of the exarch's jurisdiction in Macedonia, excited strong opposition in Bulgaria, and was eventually dropped. The death of Princess Marie-Louise (30th January 1899), caused universal regret in the country. In the same month the Stoloff government, which had weakly tampered with the Macedonian movement (see MACEDONIA) and had thrown the finances into disorder, resigned, and a ministry under Grekoff succeeded, which endeavoured to mend the economic situation by means of a foreign loan. The loan, however, fell through, and in October a new government was formed under Ivanchoff and Radoslavoff. This, in its turn, was replaced by a cabinet *d'affaires* under General Petroff (January 1901).

In the following March Karaveloff for the third time became prime minister. His efforts to improve the financial situation, which now became alarming, proved abortive, and in January 1902 a Tzankovist cabinet was formed under Daneff, who succeeded in obtaining a foreign loan. Russian influence now became predominant, and in the autumn the grand-duke Nicholas, General Ignatiev, and a great number of Russian officers were present at the consecration of a Russian church and monastery in the Shipka pass. But the appointment of Mgr. Firmilian, a Servian prelate, to the important see of Uskub at the instance of Russia, the suspected designs of that power on the ports of Varna and Burgas, and her unsympathetic attitude in regard to the Macedonian Question, tended to diminish her popularity and that of the government. A cabinet crisis was brought about in May 1903, by the efforts of the Russian party to obtain control of the army, and the Stambolovists returned to power under General Petroff. A violent recrudescence of the Macedonian agitation took place in the autumn of 1902; at the suggestion of Russia the leaders were imprisoned, but the movement nevertheless gained force, and in August 1903 a revolt broke out in the vilayet of Monastir, subsequently spreading to the districts of northern Macedonia and Adrianople (see MACEDONIA). The barbarities committed by the Turks in repressing the insurrection caused great exasperation in the principality; the reserves were partially mobilized, and the country was brought to the brink of war. In pursuance of the policy of Stamboloff, the Petroff government endeavoured to inaugurate friendly relations with Turkey, and a Turco-Bulgarian convention was signed (8th April 1904) which, however, proved of little practical value.

The outrages committed by numerous Greek bands in Macedonia led to reprisals on the Greek population in Bulgaria in the summer of 1906, and the town of Anchialo was partially destroyed. On the 6th of November in that year Petroff resigned, and Petkoff, the leader of the Stambolovist party, formed a ministry. The prime minister, a statesman of undoubted patriotism but of overbearing character, was assassinated on the 11th of March 1907 by a youth who had been dismissed from a post in one of the agricultural banks, and the cabinet was reconstituted under Gudeff, a member of the same party.

Declaration of Independence.—During the thirty years of its existence the principality had made rapid and striking progress. Its inhabitants, among whom a strong sense of nationality had grown up, were naturally anxious to escape from the restrictions imposed by the treaty of Berlin. That Servia should be an

independent state, while Bulgaria, with its greater economic and military resources, remained tributary to the Sultan, was an anomaly which all classes resented; and although the Ottoman suzerainty was little more than a constitutional fiction, and the tribute imposed in 1878 was never paid, the Bulgarians were almost unanimous in their desire to end a system which made their country the vassal of a Moslem state notorious for its maladministration and corruption. This desire was strengthened by the favourable reception accorded to Prince Ferdinand when he visited Vienna in February 1908, and by the so-called "Geshoff incident," i.e. the exclusion of M. Geshoff, the Bulgarian agent, from a dinner given by Tewfik Pasha, the Ottoman minister for foreign affairs, to the ministers of all the sovereign states represented at Constantinople (12th of September 1908). This was interpreted as an insult to the Bulgarian nation, and as the explanation offered by the grand vizier was unsatisfactory, M. Geshoff was recalled to Sofia. At this time the bloodless revolution in Turkey seemed likely to bring about a fundamental change in the settled policy of Bulgaria. For many years past Bulgarians had hoped that their own orderly and progressive government, which had contrasted so strongly with the evils of Turkish rule, would entitle them to consideration, and perhaps to an accession of territory, when the time arrived for a definite settlement of the Macedonian Question. Now, however, the reforms introduced or foreshadowed by the Young Turkish party threatened to deprive Bulgaria of any pretext for future intervention; there was nothing to be gained by further acquiescence in the conditions laid down at Berlin. An opportunity for effective action occurred within a fortnight of M. Geshoff's recall, when a strike broke out on those sections of the Eastern Rumelian railways which were owned by Turkey and leased to the Oriental Railways Company. The Bulgarians alleged that during the strike Turkish troops were able to travel on the lines which were closed to all other traffic, and that this fact constituted a danger to their own autonomy. The government therefore seized the railway, in defiance of European opinion, and in spite of the protests of the suzerain power and the Oriental Railways Company. The bulk of the Turkish army was then in Asia, and the new régime was not yet firmly established, while the Bulgarian government were probably aware that Russia would not intervene, and that Austria-Hungary intended to annex Bosnia and Herzegovina, and thus incidentally to divert attention from their own violation of the treaty of Berlin. On the 5th of October Prince Ferdinand publicly proclaimed Bulgaria, united since the 6th of September 1885 (i.e. including Eastern Rumelia), an independent kingdom. This declaration was read aloud by the king in the church of the Forty Martyrs at Trnovo, the ancient capital of the Bulgarian tsars. The Porte immediately protested to the powers, but agreed to accept an indemnity. In February 1909 the Russian government proposed to advance to Bulgaria the difference between the £4,800,000 claimed by Turkey and the £1,520,000 which Bulgaria undertook to pay. A preliminary Russo-Turkish protocol was signed on the 16th of March, and in April, after the final agreement had been concluded, the independence of Bulgaria was recognized by the powers. Of the indemnity, £1,680,000 was paid on account of the Eastern Rumelian railways; the allocation of this sum between Turkey and the Oriental railways was submitted to arbitration. (See TURKEY: *History*.)

LANGUAGE AND LITERATURE

Language.—The Bulgarian is at once the most ancient and the most modern of the languages which constitute the Slavonic group. In its groundwork it presents the nearest approach to the old ecclesiastical Slavonic, the liturgical language common to all the Orthodox Slavs, but it has undergone more important modifications than any of the sister dialects in the simplification of its grammatical forms; and the analytical character of its development may be compared with that of the neo-Latin and Germanic languages. The introduction of the definite article, which appears in the form of a suffix, and the almost total disappearance of the ancient declensions, for which the use of

prepositions has been substituted, distinguish the Bulgarian from all the other members of the Slavonic family. Notwithstanding these changes, which give the language an essentially modern aspect, its close affinity with the ecclesiastical Slavonic, the oldest written dialect, is regarded as established by several eminent scholars, such as Safarik, Schleicher, Leskien and Brugman, and by many Russian philologists. These authorities agree in describing the liturgical language as "Old Bulgarian." A different view, however, is maintained by Miklosich, Kopitar and some others, who regard it as "Old Slovene." According to the more generally accepted theory, the dialect spoken by the Bulgarian population in the neighbourhood of Salonica, the birthplace of SS. Cyril and Methodius, was employed by the Slavonic apostles in their translations from the Greek, which formed the model for subsequent ecclesiastical literature. This view receives support from the fact that the two nasal vowels of the Church-Slavonic (the greater and lesser *ѣ*), which have been modified in all the cognate languages except Polish, retain their original pronunciation locally in the neighbourhood of Salonica and Castoria; in modern literary Bulgarian the *rhinesmas* has disappeared, but the old nasal vowels preserve a peculiar pronunciation, the greater *ѣ* changing to *ѣ*, as in English "but," the lesser to *ѣ*, as in "bet," while in Servian, Russian and Slovene the greater *ѣ* becomes *ѣ* or *ѣ*, the lesser *ѣ* or *ѣ*. The remnants of the declensions still existing in Bulgarian (mainly in pronominal and adverbial forms) show a close analogy to those of the old ecclesiastical language.

The Slavonic apostles wrote in the 9th century (St Cyril died in 869, St Methodius in 885), but the original manuscripts have not been preserved. The oldest existing copies, which date from the 10th century, already betray the influence of the contemporary vernacular speech, but as the alterations introduced by the copyists are neither constant nor regular, it is possible to reconstruct the original language with tolerable certainty. The "Old Bulgarian," or archaic Slavonic, was an inflexional language of the synthetic type, containing few foreign elements in its vocabulary. The Christian terminology was, of course, mainly Greek; the Latin or German words which occasionally occur were derived from Moravia and Pannonia, where the two saints pursued their missionary labours. In course of time it underwent considerable modifications, both phonetic and structural, in the various Slavonic countries in which it became the liturgical language, and the various MSS. are consequently classified as "Servian-Slavonic," "Croatian-Slavonic," "Russian-Slavonic," &c., according to the different recensions. The "Russian-Slavonic" is the liturgical language now in general use among the Orthodox Slavs of the Balkan Peninsula owing to the great number of ecclesiastical books introduced from Russia in the 17th and 18th centuries; until comparatively recent times it was believed to be the genuine language of the Slavonic apostles. Among the Bulgarians the spoken language of the 9th century underwent important changes during the next three hundred years. The influence of these changes gradually asserts itself in the written language; in the period extending from the 12th to the 15th century the writers still endeavoured to follow the archaic model, but it is evident that the vernacular had already become widely different from the speech of SS. Cyril and Methodius. The language of the MSS. of this period is known as the "Middle Bulgarian"; it stands midway between the old ecclesiastical Slavonic and the modern speech.

In the first half of the 16th century the characteristic features of the modern language became apparent in the literary monuments. These features undoubtedly displayed themselves at a much earlier period in the oral speech; but the progress of their development has not yet been completely investigated. Much light may be thrown on this subject by the examination of many hitherto little-known manuscripts and by the scientific study of the folk-songs. In addition to the employment of the article, the loss of the noun-declensions, and the modification of the nasal vowels above alluded to, the disappearance in pronunciation of the final vowels *ъ*, *ѣ*, *ѣ* and *ъ*, the loss of the infinitive, and the increased variety of the conjugations, distinguish the modern from the ancient language. The suffix-article, which is derived from the demonstrative pronoun, is a feature peculiar to the Bulgarian among Slavonic and to the Rumanian among Latin languages. This and other points of resemblance between these remotely related members of the Indo-European group are shared by the Albanian, probably the representative of the old Illyrian language, and have consequently been attributed to the influence of the aboriginal speech of the Peninsula. A demonstrative suffix, however, is sometimes found in Russian and Polish, and traces of the article in an embryonic state occur in the "Old Bulgarian" MSS. of the 10th and 11th centuries. In some Bulgarian dialects it assumes different forms according to the proximity or remoteness of the object mentioned. Thus *shena-ta* is "the woman"; *shena-vo* or *shena-sa*, "the woman close by";

shena-na, "the woman yonder." In the borderland between the Servian and Bulgarian nationalities the local use of the article supplies the means of drawing an ethnological frontier; it is nowhere more marked than in the immediate neighbourhood of the Servian population, as, for instance, at Dibra and Friep. The modern Bulgarian has admitted many foreign elements. It contains about 2000 Turkish and 1000 Greek words dispersed in the various dialects; some Persian and Arabic words have entered through the Turkish medium, and a few Rumanian and Albanian words are found. Most of these are rejected by the purism of the literary language, which, however, has been compelled to borrow the phraseology of modern civilization from the Russian, French and other European languages. The dialects spoken in the kingdom may be classed in two groups—the eastern and the western. The main point of difference is the pronunciation of the letter *ѣ*, which in the eastern has frequently the sound of *yo*, in the western invariably that of *e* in "pet." The literary language began in the western dialect under the twofold influence of Servian literature and the Church Slavonic. In a short time, however, the eastern dialect prevailed, and the influence of Russian literature became predominant. An anti-Russian reaction was initiated by Borgroff (1818–1892), and has been maintained by numerous writers educated in the German and Austrian universities. Since the foundation of the university of Sofia the literary language has taken a middle course between the ultra-Russian models of the past generation and the dialectic Bulgarian. Little uniformity, however, has yet been attained in regard to diction, orthography, or pronunciation.

The Bulgarians of pagan times are stated by the monk Khrabr, a contemporary of Tsar Simeon, to have employed a peculiar writing, of which inscriptions recently found near Kasplitchan may possibly be specimens. The earliest manuscripts of the "Old Bulgarian" are written in one or other of the two alphabets known as the glagolitic and Cyrillic (see SLAVS). The former was used by Bulgarian writers concurrently with the Cyrillic down to the 12th century. Among the orthodox Slavs the Cyrillic finally superseded the glagolitic; as modified by Peter the Great it became the Russian alphabet, which, with the revival of literature, was introduced into Servia and Bulgaria. Some Russian letters which are superfluous in Bulgarian have been abandoned by the native writers, and a few characters have been restored from the ancient alphabet.

Literature.—The ancient Bulgarian literature, originating in the works of SS. Cyril and Methodius and their disciples, consisted for the most part of theological works translated from the Greek. From the conversion of Boris down to the Turkish conquest the religious character predominates, and the influence of Byzantine literature is supreme. Translations of the gospels and epistles, lives of the saints, collections of sermons, exegetic religious works, translations of Greek chronicles, and miscellanies such as the *Sbornik* of St Sviatoslav, formed the staple of the national literature. In the time of Tsar Simeon, himself an author, considerable literary activity prevailed; among the more remarkable works of this period was the *Shestodnev*, or Hexameron, of John the exarch, an account of the creation. A little later the heresy of the Bogomils gave an impulse to controversial writing. The principal champions of orthodoxy were St Kosmas and the monk Athanas of Jerusalem; among the Bogomils the *Questions of St Ivan Bogosloff*, a work containing a description of the beginning and the end of the world, was held in high esteem. Contemporaneously with the spread of this sect a number of apocryphal works, based on the Scripture narrative, but embellished with Oriental legends of a highly imaginative character, obtained great popularity. Together with these religious writings works of fiction, also of Oriental origin, made their appearance, such as the life of Alexander the Great, the story of Troy, the tales of *Stephanis and Ichnilat* and *Barlaam and Josaphat*, the latter founded on the biography of Buddha. These were for the most part reproductions or variations of the fantastical romances which circulated through Europe in the middle ages, and many of them have left traces in the national legends and folk-songs. In the 13th century, under the Asen dynasty, numerous historical works or chronicles (*letopisi*) were composed. State records appear to have existed, but none of them have been preserved. With the Ottoman conquest literature disappeared; the manuscripts became the food of moths and worms, or fell a prey to the fanaticism of the Phanariot clergy. The library of the patriarchs of Trnovo was committed to the flames by the Greek metropolitan Hilarion in 1825.

The monk Paisii (born about 1720) and Bishop Sofronii (1739–1815) have already been mentioned as the precursors of the literary

revival. The *Istoria Slaveno-Bolgarska* (1762) of Paisii, written in the solitude of Mount Athos, was a work of little historical value, but its influence upon the Bulgarian race was immense. An ardent patriot, Paisii recalls the glories of the Bulgarian tsars and saints, rebukes his fellow-countrymen for allowing themselves to be called Greeks, and denounces the arbitrary proceedings of the Phanariot prelates. The *Life and Sufferings of sinful Sofronii* (1804) describes in simple and touching language the condition of Bulgaria at the beginning of the 19th century. Both works were written in a modified form of the church Slavonic. The first printed work in the vernacular appears to have been the *Kryakodromion*, a translation of sermons, also by Sofronii, published in 1806. The Servian and Greek insurrections quickened the patriotic sentiments of the Bulgarian refugees and merchants in Rumania, Bessarabia and southern Russia, and Bucharest became the centre of their political and literary activity. A modest *bukvar*, or primer, published at Kronstadt by Berovitch in 1824, was the first product of the new movement. Translations of the Gospels, school reading-books, short histories and various elementary treatises now appeared. With the multiplication of books came the movement for establishing Bulgarian schools, in which the monk Neophyt Rilski (1793-1881) played a leading part. He was the author of the first Bulgarian grammar (1835) and other educational works, and translated the New Testament into the modern language. Among the writers of the literary renaissance were George Rakovski (1818-1867), a fantastic writer of the patriotic type, whose works did much to stimulate the national zeal, Liuben Karaveloff (1837-1879), journalist and novelist, Christo Boteff (1847-1876), lyric poet, whose ode on the death of his friend Haji Dimitr, an insurgent leader, is one of the best in the language, and Petko Slavevich (died 1895), whose poems, patriotic, satirical and erotic, moulded the modern poetical language and exercised a great influence over the people. Gavril Krastovitch, formerly governor-general of eastern Rumelia, and Marin Drinov, a Slavist of high repute, have written historical works. Stamboloff, the statesman, was the author of revolutionary and satirical ballads; his friend Zacharia Stoyanoff (d. 1889), who began life as a shepherd, has left some interesting memoirs. The most distinguished Bulgarian man of letters is Ivan Vazov (b. 1850), whose epic and lyric poems and prose works form the best specimens of the modern literary language. His novel *Pod Igoto* (Under the Yoke) has been translated into several European languages. The best dramatic work is *Jvanko*, a historical play by Archbishop Clement, who also wrote some novels. With the exception of Zlatarski's and Boncheff's geological treatises and contributions by Georgieff, Petkoff, Toshoff and Urumoff to Velnovski's *Flora Bulgariaica*, no original works on natural science have as yet been produced; a like dearth is apparent in the fields of philosophy, criticism and fine art, but it must be remembered that the literature is still in its infancy. The ancient folk-songs have been preserved in several valuable collections; though inferior to the Servian in poetic merit, they deserve scientific attention. Several periodicals and reviews have been founded in modern times. Of these the most important are the *Periodichesko Spisanie*, issued since 1869 by the Bulgarian Literary Society, and the *Sbornik*, a literary and scientific miscellany, formerly edited by Dr Shishmanoff, latterly by the Literary Society, and published by the government at irregular intervals.

AUTHORITIES.—C. J. Jireček, *Das Fürstenthum Bulgarien* (Prague, 1891), and *Cesty po Bulharsku* (Travels in Bulgaria), (Prague, 1888), both works of the first importance; Léon Lamouche, *La Bulgarie dans le passé et le présent* (Paris, 1892); Prince Francis Joseph of Battenberg, *Die Volkswirtschaftliche Entwicklung Bulgariens* (Leipzig, 1891); F. Kanitz, *Donau-Bulgarien und der Balkan* (Leipzig, 1882); A. G. Drander, *Éléments politiques en Bulgarie* (Paris, 1896); and *Le Prince Alexandre de Battenberg* (Paris, 1884); A. Strausz, *Die Bulgaren* (Leipzig, 1898); A. Tuma, *Die östliche Balkanhalbinsel* (Vienna, 1886); A. de Gubernatis, *La Bulgarie et les Bulgares* (Florence, 1899); E. Blech, *Consular Report on Bulgaria in 1889* (London, 1890); *La Bulgarie contemporaine* (issued by the Bulgarian Ministry of Commerce and Agriculture), (Brussels, 1905). Geology: F. Toula, *Reisen und geologische Untersuchungen in Bulgarien* (Vienna, 1890); J. Cvijić, "Die Tektonik der Balkanhalbinsel," in *C.R. IX. Cong. géol. intern. de Vienne*, pp. 348-370, with map, 1904. History: C. J. Jireček, *Geschichte der Bulgaren* (Prague, 1876); (a summary in *The Balkans*, by William Miller, London, 1896); Sokolov, *Iz drevnei istorii Bolgar* (Petersburg, 1879); Uspenski, *Obrazovanie starogo Bolgarskogo tsarstva* (Odessa, 1879); *Acta Bulgarica ecclesiastica*, published by the South Slavonic Academy (Agram, 1887). Language: F. Miklosich, *Vergleichende Grammatik* (Vienna, 1879); and *Geschichte d. Lautbezeichnung in Bulgarischen* (Vienna, 1883); A. Leskien, *Handbuch d. albulgarischen Sprache* (with a glossary), (Wienmar, 1886); L. Milčitch, *Starobulgarska Gramatika* (Sofia, 1896); *Dus Orbhulgarische* (Vienna, 1903); Labrov, *Obzor evulgoobskh i formulnikh obovnenii Bolgarskogo yezika* (Moscow, 1893); W. R. Morfill, *A Short Grammar of the Bulgarian Language* (London, 1897); F. Vymazal, *Die Kunst die bulgarische Sprache leicht und schnell zu erlernen* (Vienna, 1888). Literature: L. A. H. Dozon, *Chansons populaires bulgares inédites* (with French translations), (Paris, 1875); A. Strausz, *Bulgarische Volksdichtungen* (translations with a preface and notes), (Vienna and Leipzig, 1895); Lydia Shishmanov, *Légendes religieuses bulgares*

(Paris, 1896); Pypin and Spasovich, *History of the Slavonic Literature* (in Russian, St Petersburg, 1879), (French translation, Paris, 1881); Vazov and Velitchkov, *Bulgarian Chrestomathy* (Philippopolis, 1884); Teodorov, *Bulgariska Literaturata* (Philippopolis, 1896); Collections of folk-songs, proverbs, &c., by the brothers Mladinov (Agram, 1861), Beazonov (Moscow, 1855), Kachanovskiy (Petersburg, 1884), Shapkarov (Philippopolis, 1895), Iliev (Sofia, 1886), P. Slavevich (Sofia, 1896). See also *The Slaves of the Balkans*, by Pencho Slavevich, H. Bernard and E. J. Dillon (London, 1904). (J. D. B.)

BULGARIA, EASTERN, formerly a powerful kingdom which existed from the 5th to the 15th century on the middle Volga, in the present territory of the provinces of Samara, Simbirsk, Saratov and N. Astrakhan, perhaps extending also into Perm. The village Bolgari near Kazan, surrounded by numerous graves in which most interesting archaeological finds have been made, occupies the site of one of the cities—perhaps the capital—of that extinct kingdom. The history, *Tarikh Bulgar*, said to have been written in the 12th century by an Arabian cadi of the city Bolgari, has not yet been discovered; but the Arabian historians, Ibn Fosalan, Ibn Haukal, Abul Hamid Andalusi, Abu Abdallah Harnati, and several others, who had visited the kingdom, beginning with the 10th century, have left descriptions of it. The Bulgars of the Volga were of Turkish origin, but may have assimilated Finnish and, later, Slavonian elements. In the 5th century they attacked the Russians in the Black Sea pines, and afterwards made raids upon the Greeks. In 922, when they were converted to Islam, Ibn Fosalan found them not quite nomadic, and already having some permanent settlements and houses in wood. Stone houses were built soon after that by Arabian architects. Ibn Dasta found amongst them agriculture besides cattle breeding. Trade with Persia and India, as also with the Khazars and the Russians, and undoubtedly with Biarmia (Uzals), was, however, their chief occupation, their main riches being furs, leather, wool, nuts, wax and so on. After their conversion to Islam they began building forts, several of which are mentioned in Russian annals. Their chief town, Bolgari or Velikij Gorod (Great Town) of the Russian annals, was often raided by the Russians. In the 13th century it was conquered by the Mongols, and became for a time the seat of the khans of the Golden Horde. In the second half of the 15th century Bolgari became part of the Kazan kingdom, lost its commercial and political importance, and was annexed to Russia after the fall of Kazan. (P. A. K.)

BULGARUS, an Italian jurist of the 12th century, born at Bologna, sometimes erroneously called Bulgarianus, which was properly the name of a jurist of the 15th century. He was the most celebrated of the famous "Four Doctors" of the law school of that university, and was regarded as the Chrysostom of the Gloss-writers, being frequently designated by the title of the "Golden Mouth" (*os aureum*). He died in 1166 A.D., at a very advanced age. Popular tradition represents all the Four Doctors (Bulgarus, Martinus Gosia, Hugo de Porta Ravennate and Jacobus de Boragine) as pupils of Imericus (*q.v.*), but while there is no insuperable difficulty in point of time in accepting this tradition as far as regards Bulgarus, Savigny considers the general tradition inadmissible as regards the others. Martinus Gosia and Bulgarus were the chiefs of two opposite schools at Bologna, corresponding in many respects to the Proculians and Sabinians of Imperial Rome, Martinus being at the head of a school which accommodated the law to what his opponents styled the equity of "the purse" (*aequitas bursalis*), whilst Bulgarus adhered more closely to the letter of the law. The school of Bulgarus ultimately prevailed, and it numbered amongst its adherents Joannes Bassianus, Azo and Accursius, each of whom in his turn exercised a commanding influence over the course of legal studies at Bologna. Bulgarus took the leading part amongst the Four Doctors at the diet of Roncaglia in 1158, and was one of the most trusted advisers of the emperor Frederick I. His most celebrated work is his commentary *De Regulis Juris*, which was at one time printed amongst the writings of Placentinus, but has been properly reassigned to its true author by Cujacius, upon the internal evidence contained in the additions annexed to it, which are undoubtedly from the pen of Placentinus. The

Commentary, which is the earliest extant work of its kind emanating from the school of the Gloss-writers, is, according to Savigny, a model specimen of the excellence of the method introduced by Irenaeus, and a striking example of the brilliant results which had been obtained in a short space of time by a constant and exclusive study of the sources of law.

BULL, GEORGE (1634–1710), English divine, was born at Wells on the 25th of March 1634, and educated at Tiverton school, Devonshire. He entered Exeter College, Oxford, in 1647, but had to leave in 1649 in consequence of his refusal to take the oath of allegiance to the Commonwealth. He was ordained privately by Bishop Skinner in 1655. His first benefice held was that of St George's near Bristol, from which he rose successively to be rector of Suddington in Gloucestershire (1658), prebendary of Gloucester (1678), archdeacon of Llandaff (1686), and in 1705 bishop of St David's. He died on the 17th of February 1710. During the time of the Commonwealth he adhered to the forms of the Church of England, and under James II. preached strenuously against Roman Catholicism. His works display great erudition and powerful thinking. The *Harmonia Apostolica* (1670) is an attempt to show the fundamental agreement between the doctrines of Paul and James with regard to justification. The *Defensio Fidei Nicenae* (1685), his greatest work, tries to show that the doctrine of the Trinity was held by the ante-Nicene fathers of the church, and retains its value as a thoroughgoing examination of all the pertinent passages in early church literature. The *Judicium Ecclesiae Catholicae* (1694) and *Primitiva et Apostolica Traditio* (1710) won high praise from Bossuet and other French divines. Following on Bossuet's criticisms of the *Judicium*, Bull wrote a treatise on *The Corruptions of the Church of Rome*, which became very popular.

The best edition of Bull's works is that in 7 vols., published at Oxford by the Clarendon Press, under the superintendence of E. Burton, in 1827. This edition contains the *Life* by Robert Nelson. The *Harmonia*, *Defensio* and *Judicium* are translated in the Library of Anglo-Catholic Theology (Oxford, 1842–1855).

BULL, JOHN (c. 1562–1628), English composer and organist, was born in Somersetshire about 1562. After being organist in Hereford cathedral, he joined the Chapel Royal in 1585, and in the next year became a Mus. Bac. of Oxford. In 1591 he was appointed organist in Queen Elizabeth's chapel in succession to Blitheman, from whom he had received his musical education. In 1592 he received the degree of doctor of music at Cambridge University; and in 1596 he was made music professor at Gresham College, London. As he was unable to lecture in Latin according to the foundation-rules of that college, the executors of Sir Thomas Gresham made a dispensation in his favour by permitting him to lecture in English. He gave his first lecture on the 6th of October 1597. In 1601 Bull went abroad. He visited France and Germany, and was everywhere received with the respect due to his talents. Anthony Wood tells an impossible story of how at St Omer Dr Bull performed the feat of adding, within a few hours, forty parts to a composition already written in forty parts. Honourable employments were offered to him by various continental princes; but he declined them, and returned to England, where he was given the freedom of the Merchant Taylors' Company in 1606. He played upon a small pair of organs before King James I. on the 16th of July 1607, in the hall of the Company, and he seems to have been appointed one of the king's organists in that year. In the same year he resigned his Gresham professorship and married Elizabeth Walter. In 1613 he again went to the continent on account of his health, obtaining a post as one of the organists in the archduke's chapel at Brussels. In 1617 he was appointed organist to the cathedral of Notre Dame at Antwerp, and he died in that city on the 12th or 13th of March 1628. Little of his music has been published, and the opinions of critics differ much as to its merits (see Dr Willibald Nagel's *Geschichte der Musik in England*, ii. (1807), p. 155, &c.; and Dr Seiffert's *Geschichte der Klaviermusik* (1899), p. 54, &c.). Contemporary writers speak in the highest terms of Bull's skill as a performer on the organ and the virginals, and there is no doubt that he contributed much to the development of harpsichord music. Jan Swielinck (1562–

1621), the great organist of Amsterdam, did not regard his work on composition as complete without placing in it a canon by John Bull, and the latter wrote a fantasia upon a fugue of Swielinck. For the ascription to Bull of the composition of the British national anthem, see NATIONAL ANTHEMS. Good modern reprints, e.g. of the Fitzwilliam *Virginal-Book*, "The King's Hunting Jig," and one or two other pieces, are in the repertoires of modern pianists from Rubinstein onwards.

BULL, OLE BORNEMANN (1810–1880), Norwegian violinist, was born in Bergen, Norway, on the 5th of February 1810. At first a pupil of the violinist Paulsen, and subsequently self-taught, he was intended for the church, but failed in his examinations in 1828 and became a musician, directing the philharmonic and dramatic societies at Bergen. In 1829 he went to Cassel, on a visit to Spohr, who gave him no encouragement. He now began to study law, but on going to Paris he came under the influence of Paganini, and definitely adopted the career of a violin virtuoso. He made his first appearance in company with Ernst and Chopin at a concert of his own in Paris in 1832. Successful tours in Italy and England followed soon afterwards, and he was not long in obtaining European celebrity by his brilliant playing of his own pieces and arrangements. His first visit to the United States lasted from 1843 to 1845, and on his return to Norway he formed a scheme for the establishment of a Norse theatre in Bergen; this became an accomplished fact in 1850; but in consequence of harassing business complications he went again to America. During this visit (1852–1857) he bought 125,000 acres in Totter county, Pennsylvania, for a Norwegian colony, which was to have been called Oleana after his name; but his title turned out to be fraudulent, and the troubles he went through in connexion with the undertaking were enough to affect his health very seriously, though not to hinder him for long from the exercise of his profession. Another attempt to found an academy of music in Christiania had no permanent result. In 1836 he had married Alexandrine Félicie Villeminot, the grand-daughter of a lady to whom he owed much at the beginning of his musical career in Paris; she died in 1862. In 1870 he married Sara C. Thorpe of Wisconsin; henceforth he confined himself to the career of a violinist. He died at Lysø, near Bergen, on the 17th of August 1880. Ole Bull's "polacca guerriera" and many of his other violin pieces, among them two concertos, are interesting to the virtuoso, and his fame rests upon his prodigious technique. The memoir published by his widow in 1886 contains many illustrations of a career that was exceptionally brilliant; it gives a picture of a strong individuality, which often found expression in a somewhat boisterous form of practical humour.

There is a fountain and portrait statue to his memory in the Ole Bulls Plads in Bergen.

BULL. (1) The male of animals belonging to the section *Bovina* of the family *Bovidae* (q.v.), particularly the uncastrated male of the domestic ox (*Bos taurus*). (See CATTLE.) The word, which is found in M.E. as *bole*, *bolle* (cf. Ger. *Bulle*, and Dutch *bul* or *bol*), is also used of the males of other animals of large size, e.g. the elephant, whale, &c. The O.E. diminutive form *bulluc*, meaning originally a young bull, or bull calf, survives in bullock, now confined to a young castrated male ox kept for slaughter for beef.

On the London and New York stock exchanges "bull" and "bear" are correlative technical slang terms. A "bull" is one who "buys for a rise," i.e. he buys stocks or securities, grain or other commodities (which, however, he never intends to take up), in the hope that before the date on which he must take delivery he will be able to sell the stocks, &c., at a higher price, taking as a profit the difference between the buying and selling price. A "bear" is the reverse of a "bull." He is one who "sells for a fall," i.e. he sells stock, &c., which he does not actually possess, in the hope of buying it at a lower price before the time at which he has contracted to deliver (see ACCOUNT; STOCK EXCHANGE). The word "bull," according to the *New English Dictionary*, was used in this sense as early as the beginning of the 18th century. The origin of the use is not known, though it is tempting to connect it with the fable of the frog and the bull.

The term "bull's eye" is applied to many circular objects, and particularly to the boss or protuberance left in the centre of a sheet of blown glass. This when cut off was formerly used for windows in small leaded panes. The French term *œil de bœuf* is used of a circular window. Other circular objects to which the word is applied are the centre of a target or a shot that hits the central division of the target, a plano-convex lens in a microscope, a lantern with a convex glass in it, a thick circular piece of glass left into the deck or side of a ship, &c., for lighting the interior, a ring-shaped block grooved round the outer edge, and with a hole through the centre through which a rope can be passed, and also a small lurid cloud which in certain latitudes presages a hurricane.

(2) The use of the word "bull" for a verbal blunder, involving a contradiction in terms, is of doubtful origin. In this sense it is used with a possible punning reference to papal bulls in Milton's *True Religion*, "and whereas the Papist boasts himself to be a Roman Catholic, it is a mere contradiction, one of the Pope's Bulls, as if he should say a universal particular, a Catholic schismatic." Probably this use may be traced to a M.E. word *bul*, first found in the *Cursor Mundi*, c. 1300, in the sense of falsehood, trickery, deceit; the *New English Dictionary* compares an O. Fr. *boul, boule* or *bole*, in the same sense. Although modern associations connect this type of blunder with the Irish, possibly owing to the many famous "bulls" attributed to Sir Boyle Roche (q.v.), the early quotations show that in the 17th century, when the meaning now attached to the word begins, no special country was credited with them.

(3) *Bulla* (Lat for "bubble"), which gives us another "bull" in English, was the term used by the Romans for any boss or stud, such as those on doors, sword-belts, shields and boxes. It was applied, however, more particularly to an ornament, generally of gold, a round or heart-shaped box containing an amulet, worn suspended from the neck by children of noble birth until they assumed the *toga virilis*, when it was hung up and dedicated to the household gods. The custom of wearing the bulla, which was regarded as a charm against sickness and the evil eye, was of Etruscan origin. After the Second Punic War all children of free birth were permitted to wear it; but those who did not belong to a noble or wealthy family were satisfied with a bulla of leather. Its use was only permitted to grown-up men in the case of generals who celebrated a triumph. Young girls (probably till the time of their marriage), and even favourite animals, also wore it (see Ficononi, *La Bulla d'Oro*, 1732; Yates, *Archaeological Journal*, vi, 1849; viii., 1851). In ecclesiastical and medieval Latin, *bulła* denotes the seal of oval or circular form, bearing the name and generally the image of its owner, which was attached to official documents. A metal was used instead of wax in the warm countries of southern Europe. The best-known instances are the papal *bullae*, which have given their name to the documents (bulls) to which they are attached. (See DIPLOMATIC; SEALS; CURIA ROMANA; GOLDEN BULL.)

BULLER, CHARLES (1806–1848), English politician, son of Charles Buller (d. 1848), a member of a well-known Cornish family (see below), was born in Calcutta on the 6th of August 1806; his mother, a daughter of General William Kirkpatrick, was an exceptionally talented woman. He was educated at Harrow, then privately in Edinburgh by Thomas Carlyle, and afterwards at Trinity College, Cambridge, becoming a barrister in 1831. Before this date, however, he had succeeded his father as member of parliament for West Looe; after the passing of the Reform Bill of 1832 and the consequent disenfranchisement of this borough, he was returned to parliament by the voters of Liskeard. He retained this seat until he died in London on the 29th of November 1848, leaving behind him, so Charles Greville says, "a memory cherished for his delightful social qualities and a vast credit for undeveloped powers." An eager reformer and a friend of John Stuart Mill, Buller voted for the great Reform Bill, favoured other progressive measures, and presided over the committee on the state of the records and the one appointed to inquire into the state of election law in Ireland in 1836. In 1838 he went to Canada with Lord Durham as private

secretary, and after rendering conspicuous service to his chief returned with him to England in the same year. After practising as a barrister, Buller was made judge-advocate-general in 1844, and became chief commissioner of the poor law about a year before his death. For a long time it was believed that Buller wrote Lord Durham's famous "Report on the affairs of British North America." However, this is now denied by several authorities, among them being Durham's biographer, Stuart J. Reid, who mentions that Buller described this statement as a "groundless assertion" in an article which he wrote for the *Edinburgh Review*. Nevertheless it is quite possible that the "Report" was largely drafted by Buller, and it almost certainly bears traces of his influence. Buller was a very talented man, witty, popular and generous, and is described by Carlyle as "the genialest radical I have ever met." Among his intimate friends were Grote, Thackeray, Monckton Milnes and Lady Ashburton. A bust of Buller is in Westminster Abbey, and another was unveiled at Liskeard in 1905. He wrote "A Sketch of Lord Durham's mission to Canada," which has not been printed.

See T. Carlyle, *Reminiscences* (1881); and S. J. Reid, *Life and Letters of the 1st earl of Durham* (1906).

BULLER, SIR REDVERS HENRY (1839–1908), British general, son of James Wentworth Buller, M.P., of Crediton, Devonshire, and the descendant of an old Cornish family, long established in Devonshire, tracing its ancestry in the female line to Edward I., was born in 1839, and educated at Eton. He entered the army in 1858, and served with the 60th (King's Royal Rifles) in the China campaign of 1860. In 1870 he became captain, and went on the Red River expedition, where he was first associated with Colonel (afterwards Lord) Wolsley. In 1873–74 he accompanied the latter in the Ashantee campaign as head of the Intelligence Department, and was slightly wounded at the battle of Ordabai; he was mentioned in despatches, made a C.B., and raised to the rank of major. In 1874 he inherited the family estates. In the Kafir War of 1878–79 and the Zulu War of 1879 he was conspicuous as an intrepid and popular leader, and acquired a reputation for courage and dogged determination. In particular his conduct of the retreat at Inhlobane (March 28, 1879) drew attention to these qualities, and on that occasion he earned the V.C.; he was also created C.M.G. and made lieutenant-colonel and A.D.C. to the queen. In the Boer War of 1881 he was Sir Evelyn Wood's chief of staff, and thus added to his experience of South African conditions of warfare. In 1882 he was head of the field intelligence department in the Egyptian campaign, and was knighted for his services. Two years later he commanded an infantry brigade in the Sudan under Sir Gerald Graham, and was at the battles of El Teb and Tamai, being promoted major-general for distinguished service. In the Sudan campaign of 1884–85 he was Lord Wolsley's chief of staff, and he was given command of the desert column when Sir Herbert Stewart was wounded. He distinguished himself by his conduct of the retreat from Gubat to Gakdul, and by his victory at Abu Klea (February 16–17), and he was created K.C.B. In 1886 he was sent to Ireland to inquire into the "moonlighting" outrages, and for a short time he acted, as under-secretary for Ireland; but in 1887 he was appointed quartermaster-general at the war office. From 1806 to 1897 he held the office of adjutant-general, attaining the rank of lieutenant-general in 1891. At the war office his energy and ability inspired the belief that he was fitted for the highest command, and in 1895, when the duke of Cambridge was about to retire, it was well known that Lord Rosebery's cabinet intended to appoint Sir Redvers as chief of the staff under a scheme of reorganization recommended by Lord Hartington's commission. On the eve of this change, however, the government was defeated, and its successors appointed Lord Wolsley to the command under the old title of commander-in-chief. In 1896 he was made a full general.

In 1898 he took command of the troops at Aldershot, and when the Boer War broke out in 1899 he was selected to command the South African Field Force (see TRANSVAAL), and headed

at Cape Town on the 31st of October. Owing to the Boer investment of Ladysmith and the consequent gravity of the military situation in Natal, he unexpectedly hurried thither in order to supervise personally the operations, but on the 15th of December his first attempt to cross the Tugela at Colenso (see LADYSMITH) was repulsed. The government, alarmed at the situation and the pessimistic tone of Buller's messages, sent out Lord Roberts to supersede him in the chief command, Sir Redvers being left in subordinate command of the Natal force. His second attempt to relieve Ladysmith (January 10-27) proved another failure, the result of the operations at Spion Kop (January 24) causing consternation in England. A third attempt (Vaalkrantz, February 5-7) was unsuccessful, but the fatal army finally accomplished its task in the series of actions which culminated in the victory of Pieter's Hill and the relief of Ladysmith on the 27th of February. Sir Redvers Buller remained in command of the Natal army till October 1900, when he returned to England (being created G.C.M.G.), having in the meanwhile slowly done a great deal of hard work in driving the Boers from the Biggarsberg (May 15), forcing Lang's Nek (June 12), and occupying Lydenburg (September 6). But though these latter operations had done much to re-establish his reputation for dogged determination, and he had never lost his confidence of his own men, his capacity for an important command in delicate and difficult operations was now seriously questioned. The continuance, therefore, in 1901 of his appointment to the important Aldershot command met with a vigorous press criticism, in which the detailed objections taken to his conduct of the operations before Ladysmith (and particularly a message to Sir George White in which he seriously contemplated and provided for the contingency of surrender) were given new prominence. On the 10th of October 1901, at a reception in London, Sir Redvers Buller made a speech in answer to these criticisms in terms which were held to be a breach of discipline, and he was placed on half-pay a few days later. For the remaining years of his life he played an active part as a country gentleman, accepting in dignified silence the prolonged attacks on his failures in South Africa; among the public generally, and particularly in his own country, he never lost his popularity. He died on the 2nd of June 1908. He had married in 1882 Lady Audrey, daughter of the 4th Marquess Townshend, and survived him with one daughter.

A *Memoir*, by Lewis Butler, was published in 1909.

BULLET (Fr. *boulet*, diminutive of *boule*, ball). The original meaning (a "small ball") has, since the end of the 16th century, been narrowed down to the special case of the projectile used in small arms of all kinds, irrespective of its size or shape. For details see AMMUNITION; GUN; RIFLE, &c.)

BULL-FIGHTING, the national Spanish sport. The Spanish name is *tauromaquia* (Gr. *ταύρος*; bull, and *μαχη*, combat). Combats with bulls were common in ancient Thessaly as well as in the amphitheatres of imperial Rome, but probably partook more of the nature of worrying than fighting, like the bull-baiting formerly common in England. The Moors of Africa also possessed part of this kind, and it is probable that they introduced it into Andalusia when they conquered that province. It is certain that they held bull-fights in the half-ruined Roman amphitheatres of Merida, Cordova, Tarragona, Toledo and other places, and that these constituted the favourite sport of Moorish chieftains. Although patriotic tradition names the great Cid himself as the original Spanish bull-fighter, it is probable that the first Spaniard to kill a bull in the arena was Rodrigo Diaz de Vivar, who about 1040, employing the sword, which remained for centuries the chief weapon used in the sport, proved himself superior to the flower of the Moorish warriors. A spirited rivalry in the art between the Christian and Moorish warriors resulted, in which even the kings of Castile and other Spanish princes took an ardent interest. After the Moors were driven from Spain by Ferdinand II., bull-fighting continued to be the favourite sport of the aristocracy, the mode of fighting being on horseback with the lance. At the close of the accession of the house of Austria it had become an

indispensable accessory of every court function, and Charles V. ensured his popularity with the people by killing a bull with his own lance on the birthday of his son, Philip II. Philip IV. is also known to have taken a personal part in bull-fights. During this period the lance was discarded in favour of the short spear (*rejoncillo*), and the leg armour still worn by the *picadores* was introduced. The accession of the house of Bourbon witnessed a radical transformation in the character of the bull-fight, which the aristocracy began gradually to neglect, admitting to the combats professional subordinates who, by the end of the 17th century, had become the only active participants in the bull-ring. The first great professional *espada* (i.e. swordsman, the chief bull-fighter, who actually kills the bull) was Francisco Romero, of Ronda in Andalusia (about 1700), who introduced the *estoque*, the sword still used to kill the bull, and the *muleta*, the red flag carried by the *espada* (see below), the spear falling into complete disuse.

For the past two centuries the art of bull-fighting has developed gradually into the spectacle of to-day. Imitations of the Spanish bull-fights have been repeatedly introduced into France and Italy, but the cruelty of the sport has prevented its taking firm root. In Portugal a kind of bull-baiting is practised, in which neither man nor beast is much hurt, the bulls having their horns truncated and padded and never being killed. In Spain many vain attempts have been made to abolish the sport, by Ferdinand II. himself, instigated by his wife Isabella, by Charles III., by Ferdinand VI., and by Charles IV.; and several popes placed its devotees under the ban of excommunication with no perceptible effect upon its popularity. Before the introduction of railways there were comparatively few bull-rings (*plazas de toros*) in Spain, but these have largely multiplied in recent years, in both Spain and Spanish America. At the present day nearly every larger town and city in Spain has its *plaza de toros* (about 225 altogether), built in the form of the Roman circuses with an oval open arena covered with sand, surrounded by a stout fence about 6 ft. high. Between this and the seats of the spectators is a narrow passage-way, where those bull-fighters who are not at the moment engaged take their stations. The *plazas de toros* are of all sizes, from that of Madrid, which holds more than 12,000 spectators, down to those seating only two or three thousand. Every bull-ring has its hospital for the wounded, and its chapel where the *toreros* (bull-fighters) receive the Holy Eucharist.

The bulls used for fighting are invariably of well-known lineage and are reared in special establishments (*sacadas*), the most celebrated of which is now that of the duke of Veragua in Andalusia. When quite young they are branded with the emblems of their owners, and later are put to a test of their courage, only those that show a fighting spirit being trained further. When full grown, the health, colour, weight, character of horns, and action in attack are all objects of the keenest observation and study. The best bulls are worth from £40 to £60. About 1300 bulls are killed annually in Spain. Bull-fighters proper, most of whom are Andalusians, consist of *espadas* (or *matadores*), *banderilleros* and *picadores*, in addition to whom there are numbers of assistants (*chulos*), drivers and other servants. For each bull-fight two or three *espadas* are engaged, each providing his own quadrille (*cuadrilla*), composed of several *banderilleros* and *picadores*. Six bulls are usually killed during one *corrida* (bull-fight), the *espadas* engaged taking them in turn. The *espada* must have passed through a trying novitiate in the art at the royal school of bull-fighting, after which he is given his *alternativa*, or licence.

The bull-fight begins with a grand entry of all the bull-fighters with *aguaciles*, municipal officers in ancient costume, at the head, followed, in three rows, by the *espadas*, *banderilleros*, *picadores*, *chulos* and the richly caparisoned triple mule-team used to drag from the arena the carcasses of the slain bulls and horses. The greatest possible brilliance of costume and accoutrements is aimed at, and the picture presented is one of dazzling colour. The *espadas* and *banderilleros* wear short jackets and small-clothes of satin richly embroidered in gold and silver, with

light silk stockings and heelless shoes; the *picadores* (pikemen on horseback) usually wear yellow, and their legs are enclosed in steel armour covered with leather as a protection against the horns of the bull.

The fight is divided into three divisions (*suertes*). When the opening procession has passed round the arena the president of the *corrida*, usually some person of rank, throws down to one of the *alguaciles* the key to the *toril*, or bull-cells. As soon as the supernumeraries have left the ring, and the *picadores*, mounted upon blindfolded horses in wretched condition, have taken their places against the barrier, the door of the *toril* is opened, and the bull, which has been goaded into fury by the affixing to his shoulder of an iron pin with streamers of the colours of his breeder attached, enters the ring. Then begins the *suerte de picar*, or division of lancing. The bull at once attacks the mounted *picadores*, ripping up and wounding the horses, often to the point of complete disembowelment. As the bull attacks the horse, the *picador*, who is armed with a short-pointed, stout pike (*garrocha*), thrusts this into the bull's back with all his force, with the usual result that the bull turns its attention to another *picador*. Not infrequently, however, the rush of the bull and the blow dealt to the horse is of such force as to overthrow both animal and rider, but the latter is usually rescued from danger by the *chulos* and *banderilleros*, who, by means of their red cloaks (*capas*), divert the bull from the fallen *picador*, who either escapes from the ring or mounts a fresh horse. The number of horses killed in this manner is one of the chief features of the fight, a bull's prowess being reckoned accordingly. About 6000 horses are killed every year in Spain. At the sound of a trumpet the *picadores* retire from the ring, the dead horses are dragged out, and the second division of the fight, the *suerte de banderillar*, or planting the darts, begins. The *banderillas* are barbed darts about 18 in. long, ornamented with coloured paper, one being held in each hand of the bull-fighter, who, standing 20 or 30 yds. from the bull, draws its attention to him by means of violent gestures. As the bull charges, the *banderillero* steps towards him, dexterously plants both darts in the beast's neck, and draws aside in the nick of time to avoid its horns. Four pairs of *banderillas* are planted in this way, rendering the bull mad with rage and pain. Should the animal prove of a cowardly nature and refuse to attack repeatedly, *banderillas de fuego* (fire) are used. These are furnished with fulminating crackers, which explode with terrific noise as the bull careers about the ring. During this division numerous manoeuvres are sometimes indulged in for the purpose of tiring the bull out, such as leaping between his horns, vaulting over his back with the *garrocha* as he charges, and inviting his rushes by means of elaborate flourishes of the cloak (*floritos*, flourishes).

Another trumpet-call gives the signal for the final division of the fight, the *suerte de matar* (killing). This is carried out by the *espada* alone, his assistants being present only in the case of emergency or to get the bull back to the proper part of the ring, should he bolt to a distance. The *espada*, taking his stand before the box of the president, holds aloft in his left hand sword and *muleta* and in his right his hat, and in set phrases formally dedicates (*brinde*) the death of the bull to the president or some other personage of rank, finishing by tossing his hat behind his back and proceeding bareheaded to the work of killing the bull. This is a process accompanied by much formality. The *espada*, armed with the *estoque*, a sword with a heavy flat blade, brings the bull into the proper position by means of passes with the *muleta*, a small red silk flag mounted on a short staff, and then essays to kill him with a single thrust, delivered through the back of the neck close to the head and downward into the heart. This stroke is a most difficult one, requiring long practice as well as great natural dexterity, and very frequently fails of its object, the killing of the bull often requiring repeated thrusts. The stroke (*estocada*) is usually given *a volapié* (half running), the *espada* delivering the thrust while stepping forward, the bull usually standing still. Another method is *recibiendo* (receiving), the *espada* receiving the onset of the bull upon the point of his sword. Should the bull need a *coup de grâce*, it is given by a

chulo, called *puntillero*, with a dagger which pierces the spinal marrow. The dead beast is then dragged out of the ring by the triple mule-team, while the *espada* makes a tour of honour, being acclaimed, in the case of a favourite, with the most extravagant enthusiasm. The ring is then raked over, a second bull is introduced, and the spectacle begins anew. Upon great occasions such as a coronation, a *corrida* in the ancient style is given to amateurs, who are clad in gala costumes without armour of any kind, and mounted upon steeds of good breed and condition. They are armed with sharp lances, with which they essay to kill the bull while protecting themselves and their steeds from its horns. As the bulls in these encounters have not been weakened by many wounds and tired out by much running, the performances of the gentleman fighters are remarkable for pluck and dexterity.

See Moratin, *Origen y Progreso de las Fiestas de Toros*. Bedoya's *Historia del Torero*; J. S. Lozano, *Manual de Tauromagia* (Sev., s. 1882); A. Chapman and W. T. Buck, *Wild Spain* (London, 1893).

BULLFINCH (*Pyrrhula vulgaris*), the ancient English name given to a bird belonging to the family *Fringillidae* (see FINCH), of a bluish-grey and black colour above, and generally of a bright tile-red beneath, the female differing chiefly in having its under parts chocolate-brown. It is a shy bird, not associating with other species, and frequents well-wooded districts, being very rarely seen on moors or other waste lands. It builds a shallow nest composed of twigs lined with fibrous roots, on low trees or thick underwood, only a few feet from the ground, and lays 4 or 5 eggs of a bluish-white colour speckled and streaked with purple. The young remain with their parents during summer and winter, and pair in spring, not building their nests, however, till May. In spring and summer they feed on the buds of trees and bushes, choosing, it is said, such only as contain the incipient blossom, and thus doing immense injury to orchards and gardens. In autumn and winter they feed principally on wild fruits and on seeds. The note of the bullfinch, in the wild state, is soft and pleasant, but so low as scarcely to be audible; it possesses, however, great powers of imitation, and considerable memory, and can thus be taught to whistle a variety of tunes. Bullfinches are very abundant in the forests of Germany, and it is there that most of the piping bullfinches are trained. They are taught continuously for nine months, and the lesson is repeated through out the first moulting, as during that change the young birds are apt to forget all that they have previously acquired. The bullfinch is a native of the northern countries of Europe, occurs in Italy and other southern parts only as a winter visitor. White and black varieties are occasionally met with; the latter are often produced by feeding the bullfinch exclusively on hop-seed, when its plumage gradually changes to black. It runs and breeds in confinement, and hybrids between it and the chaffinch have been produced on but few occasions.

BULLI, a town of Camden county, New South Wales, Australia, 59 m. by rail S. of Sydney. Pop. (1901) 2500. It is the headquarters of the Bulli Mining Company, whose coal-mines on the flank of the Illawarra Mountains is worked by a tunnel 2 m. long, driven into the heart of the mountain. From this tunnel the coal is conveyed by rail for $1\frac{1}{2}$ m. to a pier, whence it is shipped to Sydney, Melbourne and Brisbane by a fleet of steam colliers. The beautiful Bulli Pass, 1000 ft. above the sea, over the Illawarra range, is one of the most attractive tourist resorts in Australia.

BULLINGER, HEINRICH (1504-1575), Swiss reformer. Son of Dean Heinrich Bullinger by his wife Anna (Wiederkehr), was born at Bremgarten, Aargau, on the 18th of July 1504. He studied at Emmerich and Cologne, where the teaching of Peter Lombard led him, through Augustine and Chrysostom, to the hand study of the Bible. Next the writings of Luther and Melancthon appealed to him. Appointed teacher (1521) in the cloister school of Cappel, he lectured on Melancthon's *L. Communes* (1523). He heard Zwingli at Zürich in 1527, and next year accompanied him to the disputation at Berne. He next made pastor of Bremgarten in 1530, and married Anna Adelsweiler, a nun, by whom he had eleven children. After the battle

of Cappel (11th of October 1531), in which Zwingli fell, he left Bremsgarten. On the 9th of December 1531 he was chosen to succeed Zwingli as chief pastor of Zürich. A strong writer and thinker, his spirit was essentially unifying and sympathetic, in an age when these qualities won little sympathy. His controversies on the Lord's Supper with Luther, and his correspondence with Lelio Sozini (see SOCRINUS), exhibit, in different connexions, his admirable mixture of dignity and tenderness. With Calvin he concluded (1549) the *Consensus Tigurrinus* on the Lord's Supper. The (second) Helvetic Confession (1566) adopted in Switzerland, Hungary, Bohemia and elsewhere, was his work. The volumes of the *Zürich Letters*, published by the Parker Society, testify to his influence on the English reformation in later stages. Many of his sermons were translated into English (reprinted, 4 vols., 1849). His works, mainly expository and polemical, have not been collected. He died at Zürich on the 7th of September 1575.

See Carl Pestalozzi, *Leben* (1858); Raget Christoffel, *H. Bullinger* (1875); Justus Heer, in Hauck's *Realencyklopädie* (1897). (A. G. *)

BULLION, a term applied to the gold and silver of the mines wrought to a standard of purity. The word appears in an English act of 1336 in the French form "puissant sauvement vter à les exchanges ou bullion . . . argent en plate, vessel argent, &c.;" and apparently it is connected with *boillon*, a sense of "boiling" being transferred in English to the melting of metal, so that *bullion* in the passage quoted meant melting-house "or" "mint." The first recorded instance of use of the word for precious metal as such in the mass is an act of 1451. From the use of gold and silver as a medium of exchange, it followed that they should approximate in all things to a common degree of fineness; and though this is not uniform even in coins, yet the proportion of alloy in silver, and carats alloy to carats fine in gold, has been reduced to infinitesimal differences in the bullion of commerce, and is a prime element of value even in gold and silver plate, jewelry, and articles of manufacture. Bullion, whether in the form of bars, or of bars and ingots stamped, is subject, as a general rule to the London market, not only to weight but to assay, and gives a corresponding value.

BULLOCK, WILLIAM (c. 1657-c. 1740); English actor, "of it glee and much comic vivacity," was the original Clincher in *Quarhar's Constant Couple* (1699), Boniface in *The Beau's Progress* (1707), and Sir Francis Courtall in *Pavener's Arifal* (1717). He played at all the London theatres of his time, in the summer at a booth at Bartholomew Fair. He had six sons, all actors, of whom the eldest was Christopher (c. 1690-1744), who at Drury Lane, the Haymarket, and the Swan and Dolphin in the Inn Fields displayed "a considerable versatility of it." Christopher created a few original parts in comedies farces of which he was the author or adapter:—*A Woman's Progress* (1715); *Slip*; *Adventures of Half an Hour* (1716); *Cobbler of Preston*; *Woman's a Riddle*; *The Perjurer* (1717); *The Traitor* (1718).

BULLROARER, the English name for an instrument made of a small flat slip of wood, through a hole in one end of which a string is passed; swung round rapidly it makes a booming, roaring noise. Though treated as a toy by Europeans, the bullroarer has had the highest mystic significance and sanctity among primitive people. This is notably the case in Australia, where it figures in the initiation ceremonies and is regarded with most awe by the "blackfellows." Their bullroarers, or "tunduns," are of two types, the "grandfather" or "tundun," distinguished by its deep tone, and the "woman's," which, being smaller, gives forth a weaker, shriller sound.

Women or girls, and boys before initiation, are never allowed to see the tundun. At the Bora, or initiation ceremonies, the bullroarer's hum is believed to be the voice of the "Great Spirit" and on hearing it the women hide in terror. A Maori bullroarer is preserved in the British Museum, and travellers in that state that it is known and held sacred there. Thus among the Maori tribe of the Yoruba race the supposed "Voice of Oro," the god of vengeance, is produced by a bullroarer, which is

actually worshipped as the god himself. The sanctity of the bullroarer has been shown to be very widespread. There is no doubt that the rhombus (Gr. *ῥόμβος*) which was whirled at the Greek mysteries was one. Among North American Indians it was common. At certain Moqui ceremonies the procession of dancers was led by a priest who whirled a bullroarer. The instrument has been traced among the Tusayan, Apache and Navaho Indians (J. G. Bourke, *Ninth Annual Report of Bureau of Amer. Ethnol.*, 1892), among the Koskimo of British Columbia (Fr. Boas, "Social Organization, &c., of the Kwakiutl Indians," *Report of the U.S. National Museum for 1895*), and in Central Brazil. In New Guinea, in some of the islands of the Torres Straits (where it is swung as a fishing-charm), in Ceylon (where it is used as a toy and figures as a sacred instrument at Buddhist festivals), and in Sumatra (where it is used to induce the demons to carry off the soul of a woman, and so drive her mad), the bullroarer is also found. Sometimes, as among the Minangkabos of Sumatra, it is made of the frontal bone of a man renowned for his bravery.

See A. Lang, *Custom and Myth* (1884); J. D. E. Schmelz, *Das Schwirrhols* (Hamburg, 1896); A. C. Haddon, *The Study of Man*, and in the *Journ. Anthropol. Instit.* xix., 1890; G. M. C. Theal, *Kaffir Folk-Lore*; A. B. Ellis, *Yoruba-Speaking Peoples* (1894); R. C. Codrington, *The Melanesians* (1891).

BULL RUN, a small stream of Virginia, U.S.A., which gave the name to two famous battles in the American Civil War.

(1) The first battle of Bull Run (called by the Confederates *Manassas*) was fought on the 21st of July 1861 between the Union forces under Brigadier-General Irvin McDowell and the Confederates under General Joseph E. Johnston. Both armies were newly raised and almost untrained. After a slight action on the 18th at Blackburn's Ford, the two armies prepared for a battle. The Confederates were posted along Bull Run, guarding all the passages from the Stone Bridge down to the railway bridge. McDowell's forces rendezvoused around Centreville, and both commanders, sensible of the temper of their troops, planned a battle for the 21st. On his part McDowell ordered one of his four divisions to attack the Stone Bridge, two to make



a turning movement via Sudley Springs, the remaining division (partly composed of regular troops) was to be in reserve and to watch the lower fords. The local Confederate commander, Brigadier-General P. G. T. Beauregard, had also intended to advance, and General Johnston, who arrived by rail on the evening of the 20th with the greater part of a fresh army, and now assumed command of the whole force, approved an offensive movement against Centreville for the 21st; but orders miscarried, and the Federal attack opened before the movement had begun. Johnston and Beauregard then decided to fight a defensive battle, and hurried up troops to support the single brigade of Evans which held the Stone Bridge. Thus there was no serious fighting at the lower fords of Bull Run throughout the day. The Federal staff was equally inexperienced, and the divisions

engaged in the turning movement met with many unnecessary checks. At 6 a.m., when the troops told off for the frontal attack appeared before the Stone Bridge, the turning movement was by no means well advanced. Evans had time to change position so as to command both the Stone Bridge and Sudley Springs, and he was promptly supported by the brigades of Bee, Bartow and T. J. Jackson. About 9.30 the leading Federal brigade from Sudley Springs came into action, and two hours later Evans, Bee and Bartow had been driven off the Matthews hill in considerable confusion. But on the Henry House hill Jackson's brigade stood, as General Bee said to his men, "like a stone wall," and the defenders rallied, though the Federals were continually reinforced. The fighting on the Henry House hill was very severe, but McDowell, who dared not halt to re-form his enthusiastic volunteers, continued to attack. About 1.30 p.m. he brought up two regular batteries to the fighting line; but a Confederate regiment, being mistaken for friendly troops and allowed to approach, silenced the guns by close rifle fire, and from that time, though the hill was taken and retaken several times, the Federal attack made no further headway. At 2.45 more of Beauregard's troops had come up; Jackson's brigade charged with the bayonet, and at the same time the Federals were assailed in flank by the last brigades of Johnston's army, which arrived at the critical moment from the railway. They gave way at once, tired out, and conscious that the day was lost, and after one rally melted away slowly to the rear, the handful of regulars alone keeping their order. But when, at the defile of the Cub Run, they came under shell fire the retreat became a panic flight to the Potomac. The victors were too much exhausted to pursue, and the U.S. regulars of the reserve division formed a strong and steady rearguard. The losses were—Federals, 2866 men out of about 18,500 engaged; Confederates, 1982 men out of 18,000.

(2) The operations of the last days of August 1862, which include the second battle of Bull Run (second Manassas), are amongst the most complicated of the war. At the outset the Confederate general Lee's army (Longstreet's and Jackson's corps) lay on the Rappahannock, faced by the Federal Army of Virginia under Major-General John Pope, which was to be reinforced by troops from McClellan's army to a total strength of 150,000 men as against Lee's 60,000. Want of supplies soon forced Lee to move, though not to retreat, and his plan for attacking Pope was one of the most daring in all military history. Jackson with half the army was despatched on a wide turning movement which was to bring him via Salem and Thoroughfare Gap to Manassas Junction in Pope's rear; when Jackson's task was accomplished Lee and Longstreet were to follow him by the same route. Early on the 25th of August Jackson began his march round the right of Pope's army; on the 26th the column passed Thoroughfare Gap, and Bristoe Station, directly in Pope's rear, was reached on the same evening, while a detachment drove a Federal post from Manassas Junction. On the 27th the immense magazines at the Junction were destroyed. On his side Pope had soon discovered Jackson's departure, and had arranged for an immediate attack on Longstreet. When, however, the direction of Jackson's march on Thoroughfare Gap became clear, Pope fell back in order to engage him, at the same time ordering his army to concentrate on Warrenton, Greenwich and Gainesville. He was now largely reinforced. On the evening of the 27th one of his divisions, marching to its point of concentration, met a division of Jackson's corps, near Bristoe Station; after a sharp fight the Confederate general, Ewell, retired on Manassas. Pope now realized that he had Jackson's corps in front of him at the Junction, and at once took steps to attack Manassas with all his forces. He drew off even the corps at Gainesville for his intended battle of the 28th; McDowell, however, its commander, on his own responsibility, left Ricketts's division at Thoroughfare Gap. But Pope's blow was struck in the air. When he arrived at Manassas on the 28th he found nothing but the ruins of his magazines, and one of McDowell's divisions (King's) marching from Gainesville on Manassas Junction met Jackson's infantry near Groveton. The situation

had again changed completely. Jackson had no intention of awaiting Pope at Manassas, and after several feints made with a view to misleading the Federal scouts he finally withdrew to a hidden position between Groveton and Sudley Springs, to await the arrival of Longstreet, who, taking the same route as Jackson had done, arrived on the 28th at Thoroughfare Gap and, engaging Ricketts's division, finally drove it back to Gainesville. On the evening of this day Jackson's corps held the line Sudley Springs—Groveton, his right wing near Groveton opposing King's division; and Longstreet held Thoroughfare Gap, facing Ricketts at Gainesville. On Ricketts's right was King near Groveton, and the line was continued thence by McDowell's remaining division and by Sigel's corps to the Stone Bridge. At Centreville, 7 m. away, was Pope with three divisions, a fourth was north-east of Manassas Junction, and Porter's corps at Bristoe Station. Thus, while Ricketts continued at Gainesville to mask Longstreet, Pope could concentrate a superior force against Jackson, whom he now believed to be meditating a retreat to the Gap. But a series of misunderstandings resulted in the withdrawal of Ricketts and King, so that nothing intervened between Longstreet and Jackson; while Sigel and McDowell's other division alone remained to face Jackson until such time as Pope could bring up the rest of his scattered forces. Jackson now closed on his left and prepared for battle, and on the morning of the 29th the Confederates, posted behind a high railway embankment, repelled two sharp attacks made by Sigel. Pope arrived at noon with the divisions from Centreville, which led by the general himself and by Reno and Hooker, two of the bravest officers in the Union army, made a third and most desperate attack on Jackson's line. The latter, repulsing it with difficulty, carried its counter-stroke too far and was in turn repulsed by Grover's brigade of Hooker's division. Grover then made a fourth assault, but was driven back with terrible loss. The last assault, gallantly delivered by two divisions under Kearny and Stevens, drove the Confederate left out of its position; but a Confederate counter-attack, led by the brave Jubal Early, dislodged the assailants with the bayonet.

In the meanwhile events had taken place near Groveton which were, for twenty years after the war, the subject of controversy and recrimination (see PORTER, FITZ-JOHN). When Porter's and part of McDowell's corps, acting on various orders sent by Pope, approached Gainesville from the south-east, Longstreet had already reached that place, and the Federals thus encountered a force of unknown strength at the moment when Sigel's guns to the northward showed him to be closely engaged with Jackson. The two generals consulted, and McDowell marched off to join Sigel, while Porter remained to hold the new enemy in check. In this he succeeded; Longstreet, though far superior in numbers, made no forward move, and his advanced guard alone came into action. On the night of the 29th Lee reunited the wings of his army on the field of battle. He had forced Pope back many miles from the Rappahannock, and expecting that the Federals would retire to the line of Bull Run before giving battle, he now decided to wait for the last divisions of Longstreet's corps, which were still distant. But Pope, still sanguine, ordered a "general pursuit" of Jackson for the 30th. There was some ground for his suppositions; for Jackson had retired a short distance and Longstreet's advanced guard had also fallen back. McDowell, however, who was a general charge of the Federal right on the 30th, soon saw that Jackson was not retreating and stopped the "pursuit," and the attack on Jackson's right, which Pope had ordered Porter to make, was repulsed by Longstreet's overwhelming forces. The Lee's whole line, 4 m. long, made its grand counter-stroke (4 p.m.). There was now no hesitation in Longstreet's attack; the Federal left was driven successively from every position it took up, and Longstreet finally captured Bald Hill. Jackson, though opposed by the greater part of Pope's forces, advanced to the Matthews hill, and his artillery threatened the Stone Bridge. The Federals, driven back to the banks of Bull Run, were only saved by the gallant defence of the Henry House hill by the Pennsylvania division of Reynolds and the regular

under Sykes. Pope withdrew under cover of night to Centreville. Here he received fresh reinforcements, but Jackson was already marching round his new right, and after the action of Chantilly (1st of September) the whole Federal army fell back to Washington. The Union forces present on the field on the 29th and 30th numbered about 63,000, the strength of Lee's army being on the same dates about 54,000. Besides their killed and wounded the Federals lost very heavily in prisoners.

BULLY (of uncertain origin, but possibly connected with a Teutonic word seen in many compounds, as the Low Ger. *bullyjaan*, meaning "noisy"; the word has also, with less probability, been derived from the Dutch *boel*, and Ger. *Buhle*, a lover), originally a fine, swaggering fellow, as in "Bully Bottom" in *A Midsummer Night's Dream*, later an overbearing ruffian, especially a coward who abuses his strength by ill-treating the weak; more technically a *soulenour*, a man who lives on the earnings of a prostitute. The term in its early use of "fine" or "splendid" survives in American slang.

BÜLOW, BERNHARD ERNST VON (1815-1879), Danish and German statesman, was the son of Adolf von Bülow, a Danish official, and was born at Cismar in Holstein on the 2nd of August 1815. He studied law at the universities of Berlin, Göttingen and Kiel, and began his political career in the service of Denmark, in the chancery of Schleswig-Holstein-Lauenburg at Copenhagen, and afterwards in the foreign office. In 1842 he became councillor of legation, and in 1847 Danish *chargé d'affaires* in the Hanse towns, where his intercourse with the merchant princes led to his marriage in 1848 with a wealthy heiress, Louise Victorine Rücker. When the insurrection broke out in the Elbe duchies (1848) he left the Danish service, and offered his services to the provisional government of Kiel, an offer that was not accepted. In 1849, accordingly, he re-entered the service of Denmark, was appointed a royal chamberlain and in 1850 sent to represent the duchies of Schleswig and Holstein at the restored federal diet of Frankfurt. Here he came into intimate touch with Bismarck, who admired his statesmanlike handling of the growing complications of the Schleswig-Holstein Question. With the radical "Eider-Dane" party he was utterly out of sympathy; and when, in 1862, this party gained the upper hand, he was recalled from Frankfurt. He now entered the service of the grand-duke of Mecklenburg-Strelitz, and remained at the head of the grand-ducal government until 1867, when he became plenipotentiary for the two Mecklenburg duchies in the council of the German Confederation (Bundesrat), where he distinguished himself by his successful defence of the medieval constitution of the duchies against Liberal attacks. In 1873 Bismarck, who was in thorough sympathy with his views, persuaded him to enter the service of Prussia as secretary of state for foreign affairs, and from this time till his death he was the chancellor's most faithful henchman. In 1875 he was appointed Prussian plenipotentiary in the Bundesrat; in 1877 he became Bismarck's lieutenant in the secretaryship for foreign affairs of the Empire; and in 1878 he was, with Bismarck and Hohenlohe, Prussian plenipotentiary at the congress of Berlin. He died at Frankfurt on the 20th of October 1879, his end being hastened by his exertions in connexion with the political crisis of that year. Of his six sons the eldest, Bernhard Heinrich Karl (see below), became chancellor of the Empire.

See the biography of H. von Peterdorff in *Allgemeine deutsche Biographie*, Band 47, p. 350.

BÜLOW, BERNHARD HEINRICH KARL MARTIN, PRINCE (1849-), German statesman, was born on the 3rd of May 1849, at Klein-Flottbeck, in Holstein. The Bülow family is a very widely extended in north Germany, and many members have attained distinction in the civil and military service of Russia, Denmark and Mecklenburg. Prince Bülow's great-uncle, Heinrich von Bülow, who was distinguished for his admiration of England and English institutions, was Prussian ambassador in England from 1827 to 1840, and married a daughter Wilhelm von Humboldt (see the letters of Gabrielle von Bülow). His father, Bernhard Ernst von Bülow, is separately cited above.

Prince Bülow must not be confused with his contemporary Otto v. Bülow (1827-1901), an official in the Prussian foreign office, who in 1882 was appointed German envoy at Bern, from 1892 to 1898 was Prussian envoy to the Vatican, and died at Rome on the 22nd of November 1901.

Bernhard von Bülow, after serving in the Franco-Prussian War, entered the Prussian civil service, and was then transferred to the diplomatic service. In 1876 he was appointed attaché to the German embassy in Paris, and after returning for a while to the foreign office at Berlin, became second secretary to the embassy in Paris in 1880. From 1884 he was first secretary to the embassy at St Petersburg, and acted as *chargé d'affaires*; in 1888 he was appointed envoy at Bucharest, and in 1893 to the post of German ambassador at Rome. In 1897, on the retirement of Baron Marshall von Bieberstein, he was appointed secretary of state for foreign affairs (the same office which his father had held) under Prince Hohenlohe, with a seat in the Prussian ministry. The appointment caused much surprise at the time, as Bülow was little known outside diplomatic circles. The explanations suggested were that he had made himself very popular at Rome and that his appointment was therefore calculated to strengthen the loosening bonds of the Triple Alliance, and also that his early close association with Bismarck would ensure the maintenance of the Bismarckian tradition. As foreign secretary Herr von Bülow was chiefly responsible for carrying out the policy of colonial expansion with which the emperor had identified himself, and in 1899, on bringing to a successful conclusion the negotiations by which the Caroline Islands were acquired by Germany, he was raised to the rank of count. On the resignation of Hohenlohe in 1900 he was chosen to succeed him as chancellor of the empire and president of the Prussian ministry.

The *Berliner Neueste Nachrichten*, commenting on this appointment, very aptly characterized the relations of the new chancellor to the emperor, in contrast to the position occupied by Bismarck. "The Germany of William II.," it said, "does not admit a Titan in the position of the highest official of the Empire. A cautious and versatile diplomatist like Bernhard von Bülow appears to be best adapted to the personal and political necessities of the present situation." Count Bülow, indeed, though, like Bismarck, a "realist," utilitarian and opportunist in his policy, made no effort to emulate the masterful independence of the great chancellor. He was accused, indeed, of being little more than the complacent executor of the emperor's will, and defended himself in the Reichstag against the charge. The substance of the relations between the emperor and himself, he declared, rested on mutual good-will, and added: "I must lay it down most emphatically that the prerogative of the emperor's personal initiative must not be curtailed, and will not be curtailed, by any chancellor. . . . As regards the chancellor, however, I say that no imperial chancellor worthy of the name . . . would take up any position which in his conscience he did not regard as justifiable." It is clear that the position of a chancellor holding these views in relation to a ruler so masterful and so impulsive as the emperor William II. could be no easy one; and Bülow's long continuance in office is the best proof of his genius. His first conspicuous act as chancellor was a masterly defence in the Reichstag of German action in China, a defence which was, indeed, rendered easier by the fact that Prince Hohenlohe had— to use his own words—"dug a canal" for the flood of imperial ambition of which warning had been given in the famous "mailed fist" speech. Such incidents as this, however, though they served to exhibit consummate tact and diplomatic skill, give little index to the fundamental character of his work as chancellor. Of this it may be said, in general, that it carried on the best traditions of the Prussian service in whole-hearted devotion to the interests of the state. The accusation that he was an "agrarian" he thought it necessary to rebut in a speech delivered on the 18th of February 1906 to the German Handelstag. He was an agrarian, he declared, in so far as he came of a land-owning family, and was interested in the prosperity of agriculture; but as chancellor, whose function it is to watch over the welfare

of all classes, he was equally concerned with the interests of commerce and industry (*Kölnische Zeitung*, Feb. 20, 1906). Some credit for the immense material expansion of Germany under his chancellorship is certainly due to his zeal and self-devotion. This was generously recognized by the emperor in a letter publicly addressed to the chancellor on the 21st of May 1906, immediately after the passage of the Finance Bill. "I am fully conscious," it ran, "of the conspicuous share in the initiation and realization of this work of reform . . . which must be ascribed to the statesmanlike skill and self-sacrificing devotion with which you have conducted and promoted those arduous labours." Rumours had from time to time been rife of a "chancellor crisis" and Bülow's dismissal; in the *Berliner Tageblatt* this letter was compared to the "Never!" with which the emperor William I. had replied to Bismarck's proffered resignation.

On the 6th of June 1905 Count Bülow was raised to the rank of prince (*Fürst*), on the occasion of the marriage of the crown prince. The coincidence of this date with the fall of M. Delcassé, the French minister for foreign affairs—a triumph for Germany and a humiliation for France—was much commented on at the time (see *The Times*, June 7, 1905); and the elevation of Bismarck to the rank of prince in the Hall of Mirrors at Versailles was recalled. Whatever element of truth there may have been in this, however, the significance of the incident was much exaggerated.

On the 5th of April 1906, while attending a debate in the Reichstag, Prince Bülow was seized with illness, the result of overwork and an attack of influenza, and was carried unconscious from the hall. At first it was thought that the attack would be fatal, and Lord Fitzmaurice in the House of Lords compared the incident with that of the death of Chatham, a compliment much appreciated in Germany. The illness, however, quickly took a favourable turn, and after a month's rest the chancellor was able to resume his duties. In 1907 Prince Bülow was made the subject of a disgraceful libel, which received more attention than it deserved because it coincided with the Harden-Moltke scandals; his character was, however, completely vindicated, and the libeller, a journalist named Brand, received a term of imprisonment.

The parliamentary skill of Prince Bülow in holding together the heterogeneous elements of which the government majority in the Reichstag was composed, no less than the diplomatic tact with which he from time to time "interpreted" the imperial indiscretions to the world, was put to a rude test by the famous "interview," with the German emperor, published in the London *Daily Telegraph* of the 28th of October 1908 (see WILLIAM II., German emperor), which aroused universal reprobation in Germany. Prince Bülow assumed the official responsibility, and tendered his resignation to the emperor, which was not accepted; but the chancellor's explanation in the Reichstag on the 10th of November showed how keenly he felt his position. He declared his conviction that the disastrous results of the interview would "induce the emperor in future to observe that strict reserve, even in private conversations, which is equally indispensable in the interest of a uniform policy and for the authority of the crown," adding that, in the contrary case, neither he nor any successor of his could assume the responsibility (*The Times*, Nov. 11, 1908, p. 9). The attitude of the emperor showed that he had taken the lesson to heart. It was not the imperial indiscretions, but the effect of his budget proposals in breaking up the Liberal-Conservative bloc, on whose support he depended in the Reichstag, that eventually drove Prince Bülow from office (see GERMANY: History). At the emperor's request he remained to pilot the mutilated budget through the House; but on the 14th of July 1909 the acceptance of his resignation was announced.

Prince Bülow married, on the 9th of January 1886, Maria Anna Zoe Rosalia Beccadelli di Bologna, Princess Camporeale, whose first marriage with Count Karl von Dönhoff had been dissolved and declared null by the Holy See in 1884. The princess, an accomplished pianist and pupil of Liszt, was a step-daughter of the Italian statesman Minghetti.

See J. Penzler, *Graf Bülow's Reden nebst urkundlichen Beiträgen zu seiner Politik* (Leipzig, 1903).

BÜLOW, DIETRICH HEINRICH, FREIHERR VON (1757-1807), Prussian soldier and military writer, and brother of General Count F. W. Bülow, entered the Prussian army in 1773. Routine work proved distasteful to him, and he read with avidity the works of the chevalier Folard and other theoretical writers on war, and of Rousseau. After sixteen years' service he left Prussia, and endeavoured without success to obtain a commission in the Austrian army. He then returned to Prussia, and for some time managed a theatrical company. The failure of this undertaking involved Bülow in heavy losses, and soon afterwards he went to America, where he seems to have been converted to, and to have preached, Swedenborgianism. On his return to Europe he persuaded his brother to engage in a speculation for exporting glass to the United States, which proved a complete failure. After this for some years he made a precarious living in Berlin by literary work, but his debts accumulated, and it was under great disadvantages that he produced his *Geist des Neuen Kriegssystems* (Hamburg, 1799) and *Der Feldzug 1800* (Berlin, 1801). His hopes of military employment were again disappointed, and his brother, the future field marshal, who had stood by him in all his troubles, finally left him. After wandering in France and the smaller German states, he reappeared at Berlin in 1804, where he wrote a revised edition of his *Geist des Neuen Kriegssystems* (Hamburg, 1805), *Lehrbuch des Neuen Kriegs* (Berlin, 1805), *Geschichte des Prinzen Heinrich von Preussen* (Berlin, 1805), *Neue Taktik der Neuern wie sie sein sollte* (Leipzig, 1805), and *Der Feldzug 1805* (Leipzig, 1806). He also edited, with G. H. von Behrenhorst (1733-1814) and others, *Annalen des Krieges* (Berlin, 1806). These brilliant but unorthodox works, distinguished by an open contempt of the Prussian system, cosmopolitanism hardly to be distinguished from high treason, and the mordant sarcasm of a disappointed man, brought upon Bülow the enmity of the official classes and of the government. He was arrested as insane, but medical examination proved him sane and he was then lodged as a prisoner in Colberg, where he was harshly treated, though Gneisenau obtained some mitigation of his condition. Thence he passed into Russian hands and died in prison at Riga in 1807, probably as a result of ill-treatment.

In Bülow's writings there is evident a distinct contrast between the spirit of his strategical and that of his tactical ideas. As a strategist (he claimed to be the first of strategists) he reduces to mathematical rules the practice of the great generals of the 18th century, ignoring "friction," and manoeuvring his armies *in vacuo*. At the same time he professes that his system provides working rules for the armies of his own day, which in point of fact were "armed nations," infinitely more affected by "friction" than the small dynastic and professional armies of the preceding age. Bülow may therefore be considered as anything but a reformer in the domain of strategy. With more justice he has been styled the "father of modern tactics." He was the first to recognize that the conditions of swift and decisive war brought about by the French Revolution involved wholly new tactics, and much of his teaching had a profound influence on European warfare of the 19th century. His early training had shown him merely the pedantic *manière* of Frederick's methods, and, in the absence of any troops capable of illustrating the real linear tactics, he became an enthusiastic supporter of the methods, which (more of necessity than from judgment) the French revolutionary generals had adopted, of fighting in small columns covered by skirmishers. Battles, he maintained, were won by skirmishers. "We must organize disorder," he said; indeed, every argument of writers of the modern "extended order" school is to be found *mutatis mutandis* in Bülow, whose system acquired great prominence in view of the mechanical improvements in armament. But his tactics, like his strategy, were vitiated by the absence of "friction," and their dependence on the realization of an unattainable standard of bravery.

See von Voss, *H. von Bülow* (Köln, 1806); P. von Bülow, *Denkbuch der v. Bülow* (Berlin, 1859); Ed. von Bülow, *Aus den Lehrbüchern v. Bülow*, also *Vermischte Schriften aus dem Nachlass von Behrenhorst* (1845); Ed. von Bülow, and von Rüstow, *Militärische und vermischte Schriften von Heinrich Dietrich v. Bülow* (Leipzig, 1853); Memoirs by Freiherr v. Meerheimb in *Allgemeines deutsches*

Biographie, vol. 3 (Leipzig, 1876), and "Behrenhorst und Bülow" (*Historische Zeitschrift*, 1861, vi.); Max Jähns, *Geschichte der Kriegswissenschaften*, vol. iii. pp. 2133-2145 (Munich, 1891); General von Cammerer (transl. von Donat), *Development of Strategic Science* (London, 1905), ch. i.

BÜLOW, FRIEDRICH WILHELM, FÜRST VON, count of Dennewitz (1755-1816), Prussian general, was born on the 16th of February 1755, at Falkenberg in the Altmark; he was the elder brother of the foregoing. He received an excellent education, and entered the Prussian army in 1768, becoming ensign in 1772, and second lieutenant in 1775. He took part in the "Potato War" of 1778, and subsequently devoted himself to the study of his profession and of the sciences and arts. He was throughout his life devoted to music, his great musical ability bringing him to the notice of Frederick William II., and about 1790 he was conspicuous in the most fashionable circles of Berlin. He did not, however, neglect his military studies, and in 1792 he was made military instructor to the young prince Louis Ferdinand, becoming at the same time full captain. He took part in the campaigns of 1792-93-94 on the Rhine, and received for signal courage during the siege of Mainz the order *pour le mérite* and promotion to the rank of major. After this he went to garrison duty at Soldau. In 1802 he married the daughter of Colonel v. Auer, and in the following year he became lieutenant-colonel, remaining at Soldau with his corps. The vagaries and misfortunes of his brother Dietrich affected his happiness as well as his fortune. The loss of two of his children was followed in 1806 by the death of his wife, and a further source of disappointment was the exclusion of his regiment from the field army sent against Napoleon in 1806. The disasters of the campaign aroused his energies. He did excellent service under Lessocq's command in the latter part of the war, was wounded in action, and finally designated for a brigade command in Blücher's force. In 1808 he married the sister of his first wife, a girl of eighteen. He was made a major-general in the same year, and henceforward he devoted himself wholly to the regeneration of Prussia. The intensity of his patriotism threw him into conflict even with Blücher and led to his temporary retirement; in 1811, however, he was again employed. In the critical days preceding the War of Liberation he kept his troops in hand without committing himself to any irrevocable step until the decision was made. On the 14th of March 1813 he was made lieutenant-general. He fought against Oudinot in defence of Berlin (see NAPOLEONIC CAMPAIGNS), and in the summer came under the command of Bernadotte, crown prince of Sweden. At the head of an army corps Bülow distinguished himself very greatly in the battle of Gross Beeren, a victory which was attributed almost entirely to his leadership. A little later he won the great victory of Dennewitz, which for the third time checked Napoleon's advance on Berlin. This inspired the greatest enthusiasm in Prussia, as being won by purely Prussian forces, and rendered Bülow's popularity almost equal to that of Blücher. Bülow's corps played a conspicuous part in the final overthrow of Napoleon at Leipzig, and he was then entrusted with the task of evicting the French from Holland and Belgium. In an almost uniformly successful campaign he won a signal victory at Hoogerstraaten, and in the campaign of 1814 he invaded France from the north-west, joined Blücher, and took part in the brilliant victory of Laon in March. He was now made general of infantry and received the title of Count Bülow von Dennewitz. In the short peace of 1814-1815 he was at Königsberg as commander-in-chief in Prussia proper. He was soon called to the field again, and in the Waterloo campaign commanded the IV. corps of Blücher's army. He was not present at Ligny, but his corps added the flank attack upon Napoleon at Waterloo, and bore the heaviest part in the fighting of the Prussian troops. He took part in the invasion of France, but died suddenly on the 25th of February 1816, a month after his return to the Königsberg command.

See *General Graf Bülow von Dennewitz, 1813-1814* (Leipzig, 1843); *Erzählungen von Enns, Leben des G. Grafen B. von D.* (Berlin, 1854).

BÜLOW, HANS GUIDO VON (1830-1894), German pianist and conductor, was born at Dresden, on the 8th of January 1830.

At the age of nine he began to study music under Friedrich Wieck as part of a genteel education. It was only after an illness while studying law at Leipzig University in 1848 that he determined upon music as a career. At this time he was a pupil of Moritz Hauptmann. In 1849 revolutionary politics took possession of him. In the Berlin *Abendpost*, a democratic journal, the young aristocrat poured forth his opinions, which were strongly coloured by Wagner's *Art and Revolution*. Wagner's influence was musical no less than political, for a performance of *Lohengrin* under Liszt at Weimar in 1850 completed von Bülow's determination to abandon a legal career. From Weimar he went to Zürich, where the exile Wagner instructed him in the elements of conducting. But he soon returned to Weimar and Liszt; and in 1853 he made his first concert tour, which extended from Vienna to Berlin. Next he became principal professor of the piano at the Stern Academy, and married in his twenty-eight year Liszt's daughter Cosima. For the following nine years von Bülow laboured incessantly in Berlin as pianist, conductor and writer of musical and political articles. Thence he removed to Munich, where, thanks to Wagner, he had been appointed *Hofkapellmeister* to Louis II., and chief of the Conservatorium. There, too, he organized model performances of *Tristan* and *Die Meistersinger*. In 1869 his marriage was dissolved, his wife subsequently marrying Wagner, an incident which, while preventing Bülow from revisiting Bayreuth, never dimmed his enthusiasm for Wagner's dramas. After a temporary stay in Florence, Bülow set out on tour again as a pianist, visiting most European countries as well as the United States of America, before taking up the post of conductor at Hanover, and, later, at Meiningen, where he raised the orchestra to a pitch of excellence till then unparalleled. In 1885 he resigned the Meiningen office, and conducted a number of concerts in Russia and Germany. At Frankfurt he held classes for the higher development of piano-playing. He constantly visited England, for the last time in 1888, in which year he went to live in Hamburg. Nevertheless he continued to conduct the Berlin Philharmonic Concerts. He died at Cairo, on the 13th of February 1894. Bülow was a pianist of the highest order of intellectual attainment, an artist of remarkably catholic tastes, and a great conductor. A passionate hater of humbug and affectation, he had a ready pen, and a biting, sometimes almost rude wit, yet of his kindness and generosity countless tales were told. His compositions are few and unimportant, but his annotated editions of the classical masters are of great value. Bülow's writings and letters (*Briefe und Schriften*), edited by his widow, have been published in 8 vols. (Leipzig, 1895-1908).

BULRUSH, a name now generally given to *Typha latifolia*, the reed-mace or club-rush, a plant growing in lakes, by edges of rivers and similar localities, with a creeping underground stem, narrow, nearly flat leaves, 3 to 6 ft. long, arranged in opposite rows, and a tall stem ending in a cylindrical spike, half to one foot long, of closely packed male (above) and female (below) flowers. The familiar brown spike is a dense mass of minute one-seeded fruits, each on a long hair-like stalk and covered with long downy hairs, which render the fruits very light and readily carried by the wind. The name bulrush is more correctly applied to *Scirpus lacustris*, a member of a different family (Cyperaceae), a common plant in wet places, with tall spongy, usually leafless stems, bearing a tuft of many-flowered spikelets. The stems are used for matting, &c. The bulrush of Scripture, associated with the hiding of Moses, was the *Papyrus* (*q.v.*), also a member of the order Cyperaceae, which was abundant in the Nile.

BULSTRODE, SIR RICHARD (1610-1711), English author and soldier, was a son of Edward Bulstrode (1588-1650), and was educated at Pembroke College, Cambridge; after studying law in London he joined the army of Charles I. on the outbreak of the Civil War in 1642. In 1673 he became a resident agent of Charles II. at Brussels; in 1675 he was knighted; then following James II. into exile he died at St Germain on the 3rd of October 1711. Bulstrode is chiefly known by his *Memoirs and Reflections upon the Reign and Government of King Charles I. and King Charles II.*, published after his death in 1721. He also

wrote *Life of James II.*, and *Original Letters written to the Earl of Arlington* (1712). The latter consists principally of letters written from Brussels giving an account of the important events which took place in the Netherlands during 1674.

His second son, WHITELOCKE BULSTRODE (1650-1724), remained in England after the flight of James II.; he held some official positions, and in 1717 wrote a pamphlet in support of George I. and the Hanoverian succession. He published *A Discourse of Natural Philosophy*, and was a prominent Protestant controversialist. He died in London on the 27th of November 1724.

BULWARK (a word probably of Scandinavian origin, from *bol* or *bole*, a tree-trunk, and *werk*, work, in Ger. *Bollwerk*, which has also been derived from an old German *boles*, to throw, and so a machine for throwing missiles), a barricade of beams, earth, &c., a work in 15th and 16th century fortifications designed to mount artillery (see *BOULEVARD*). On board ship the term is used of the woodwork running round the ship above the level of the deck. Figuratively it means anything serving as a defence.

BUMBOAT, a small boat which carries vegetables, provisions, &c., to ships lying in port or off the shore. The word is probably connected with the Dutch *bumboot* or *boomboot*, a broad Dutch fishing-boat, the derivation of which is either from *boom*, Cf. Ger. *bäume*, a tree, or from *bon*, a place in which fish is kept alive, and *boot*, a boat. It appears first in English in the Trinity House By-laws of 1685 regulating the scavenging boats attending ships lying in the Thames.

BUMBULUM, **BOMBULUM** or **BUNIBULUM**, a fabulous musical instrument described in an apocryphal letter of St Jerome to Dardanus,¹ and illustrated in a series of illuminated MSS. of the 9th to the 11th century, together with other instruments described in the same letter. These MSS. are the *Psalter of Emmeran*, 9th century, described by Martin Gerbert,² who gives a few illustrations from it; the Cotton MS. *Tiberius C. VI.* in the British Museum, 11th century; the famous *Boulogne Psalter*, A.D. 1000; and the *Psalter of Angers*, 9th century.³ In the Cotton MS. the instrument consists of an angular frame, from which depends by a chain a rectangular metal plate having twelve bent arms attached in two rows of three on each side, one above the other. The arms appear to terminate in small rectangular bells or plates, and it is supposed that the standard frame was intended to be shaken like a sistrum in order to set the bells jangling. Sebastian Virdung⁴ gives illustrations of these instruments of Jerome, and among them of the one called *bumbulum* in the Cotton MS., which Virdung calls *Fistula Hieronimi*. The general outline is the same, but instead of metal arms there is the same number of bent pipes with conical bore. Virdung explains, following the apocryphal letter, that the stand resembling the draughtsman's square represents the Holy Cross, the rectangular object dangling therefrom signifies Christ on the Cross, and the twelve pipes are the twelve apostles. Virdung's illustration, probably copied from an older work in manuscript, conforms more closely to the text of the letter than does the instrument in the Cotton MS. There is no evidence whatever of the actual existence of such an instrument during the middle ages, with the exception of this series of fanciful pictures drawn to illustrate an instrument known from description only. The word *bombulum* was probably derived from the same root as the *βουβαύλιος* of Aristophanes (*Acharnians*, 866) (*βῆβος* and *αὐλός*), a comic compound for a bag-pipe with a play on *βουβυλός*, an insect that hums or buzzes (see *BAG-PİPE*). The original described in the letter, also from hearsay, was probably an early type of organ. (K. S.)

BUN, a small cake, usually sweet and round. In Scotland the word is used for a very rich spiced type of cake and in the north of Ireland for a round loaf of ordinary bread. The derivation of the word has been much disputed. It has been affiliated to the old provincial French *bugne*, "swelling," in the sense of a

"fritter," but the *New English Dictionary* doubts the usage of the word. It is quite as probable that it has a far older and more interesting origin, as is suggested by an inquiry into the origin of hot cross buns. These cakes, which are now solely associated with the Christian Good Friday, are traceable to the remotest period of pagan history. Cakes were offered by ancient Egyptians to their moon-goddess; and these had imprinted on them a pair of horns, symbolic of the ox at the sacrifice of which they were offered on the altar, or of the horned moon-goddess, the equivalent of Ishtar of the Assyro-Babylonians. The Greeks offered such sacred cakes to Astarte and other divinities. This cake they called *bous* (ox), in allusion to the ox-symbol marked on it, and from the accusative *bous* it is suggested that the word "bun" is derived. Diogenes Laertius (c. A.D. 300), speaking of the offering made by Empedocles, says "He offered one of the sacred liba, called a *bosse*, made of fine flour and honey." Hesychius (c. 6th century) speaks of the *bous*, and describes it as a kind of cake with a representation of two horns marked on it. In time the Greeks marked these cakes with a cross, possibly as allusion to the four quarters of the moon, or more probably to facilitate the distribution of the sacred bread which was eaten by the worshippers. Like the Greeks, the Romans eat cross-bread at public sacrifices, such bread being usually purchased at the doors of the temple and taken in with them,—a custom alluded to by St Paul in 1 Cor. x. 28. At Herculaneum two small loaves about 5 in. in diameter, and plainly marked with a cross, were found. In the Old Testament a reference is made in Jer. vii. 18-xliv. 19, to such sacred bread being offered to the moon-goddess. The cross-bread was eaten by the pagan Saxons in honour of Eoster, their goddess of light. The Mexicans and Peruvians are shown to have had a similar custom. The custom, in fact, was practically universal, and the early Church adventively adopted the pagan practice, grafting it on to the Eucharist. The *bous* with its Greek cross became akin to the Eucharistic bread or cross-marked wafers mentioned in St Chrysostom's *Liturgy*. In the medieval church, buns made from the dough for the consecrated Host were distributed to the communicants after Mass on Easter Sunday. In France and other Catholic countries, such blessed bread is still given in the churches to communicants who have a long journey before they can break their fast. The Holy Eucharist in the Greek church has a cross printed on it. In England there seems to have early been a disposition on the part of the bakers to imitate the church, and they did a good trade in buns and cakes stamped with a cross, for as far back as 1252 the practice was forbidden by royal proclamation; but this seems to have had little effect. With the rise of Protestantism the cross bun lost its sacramental nature, and became a mere eatable associated for no particular reason with Good Friday. Cross-bread is not, however, reserved for that day; in the north of England people usually crossmark their cakes with a knife before putting them in the oven. Many superstitions cling round hot cross buns. Thus it is still a common belief that one bun should be kept for luck's sake to the following Good Friday. In Dorsetshire it is thought that a cross-loaf baked on that day and hung over the chimney-piece prevents the bread baked in the house during the year from "going stringy."

BUNBURY, HENRY WILLIAM (1750-1811), English caricaturist, was the second son of Sir William Bunbury, 5th baronet, of Mildenhall, Suffolk, and came of an old Norman family. He was educated at Westminster school and St Catherine's Hall, Cambridge, and soon showed a talent for drawing, and especially for humorous subjects. His more serious efforts did not rise to a high level, but his caricatures are as famous as those of his contemporaries Rowlandson and Gillray, good examples being his "Country Club" (1788), "Barber's Shop" (1811) and "A Long Story" (1782). He was a popular character, and the friend of most of the notabilities of his day, whom he never offended by attempting political satire; and his easy circumstances and social position (he was colonel of the West Suffolk Militia, and was appointed equerry to the duke of York in 1787) enabled him to exercise his talents in comfort.

¹ Ad Dardanum, de diversis generibus musicorum instrumentorum.

² De Cantu et Musica Sacra (1774).

³ For illustrations see *Annales archéologiques*, iii. p. 82 et seq.

⁴ *Musica getuscht und ausgezogen* (Basle, 1511).

His son Sir HENRY EDWARD BUNBURY, Bart. (1778-1860), who succeeded to the family title on the death of his uncle, was a distinguished soldier, and rose to be a lieutenant-general; he was an active member of parliament, and the author of several historical works of value; and the latter's second son, Sir Edward Herbert Bunbury, also a member of parliament, was well known as a geographer and archaeologist, and author of a *History of Ancient Geography*.

BUNBURY, a seaport and municipal town of Wellington county, Western Australia, 112 m. by rail S. by W. of Perth. Pop. (1901) 2455. The harbour, known as Koombanah Bay, is protected by a breakwater built on a coral reef. Coal is worked on the Collie river, 30 m. distant, and is shipped from this port, together with tin, timber, sandal-wood and agricultural produce.

BUNCOMBE, or **BUNKUM** (from Buncombe county, North Carolina, United States), a term used for insincere political action or speaking to gain support or the favour of a constituency, and so any humbug or clap-trap. The phrase "to talk for (or to) Buncombe" arose in 1820, during the debate on the Missouri Compromise in Congress; the member for the district containing Buncombe county confessed that his long and much interrupted speech was only made because his electors expected it, and that he was "speaking for Buncombe."

BUNCRANA, a market-town and watering-place of Co. Donegal, Ireland, in the north parliamentary division on the east shore of Lough Swilly, on the Londonderry & Lough Swilly & Letterkenny railway. Pop. (1901) 1316. There is a trade in agricultural produce, a salmon fishery, sea fisheries and a manufacture of linen. The town is beautifully situated, being flanked on the east and south by hills exceeding 1000 ft. The picturesque square keep of an ancient castle remains, but the present Bunrana Castle is a residence erected in 1717. The golf-links are well known.

BUNDABERG, a municipal town and river port of Cook county, Queensland, Australia, 10 m. from the mouth of the river Burnett, and 217 m. by rail N. by W. of Brisbane. Pop. (1901) 5200. It lies on both sides of the river, and connexion between the two ports is maintained by road and railway bridges. There are saw-mills, breweries, brickfields and distilleries in the town, and numerous sugar factories in the vicinity, notably at Millaquin, on the river below the town. There are wharves on both sides of the river, and the staple exports are sugar, golden-syrup and timber. The climate is remarkably healthy.

BUNDELKHAND, a tract of country in Central India, lying between the United and the Central Provinces. Historically it includes the five British districts of Hamirpur, Jalaun, Jhansi, Lalitpur and Banda, which now form part of the Allahabad division of the United Provinces, but politically it is restricted to a collection of native states, under the Bundelkhand agency. There are 9 states, 13 estates and the pargana of Alampur belonging to Indore state, with a total area of 9851 sq. m. and a total population (1901) of 1,308,326, showing a decrease of 13% in the decade, due to the effects of famine. The most important of the states are Orchha, Panna, Samthar, Charkhari, Chhatarpur, Datia, Bijawar and Ajaigarh. A branch of the Great Indian Peninsula railway traverses the north of the country. A garrison of all arms is stationed at Nowgong.

The surface of the country is uneven and hilly, except in the north-east part, which forms an irregular plain cut up by ravines scooped out by torrents during the periodical rains. The plains of Bundelkhand are intersected by three mountain ranges, the Bindhachal, Panna and Bander chains, the highest elevation not exceeding 2000 ft. above sea-level. Beyond these ranges the country is further diversified by isolated hills rising abruptly from a common level, and presenting from their steep and nearly inaccessible scarps eligible sites for castles and strongholds, whence the mountaineers of Bundelkhand have frequently set at defiance the most powerful of the native states of India. The general slope of the country is towards the north-east, as indicated by the course of the rivers which traverse or bound the territory, and finally discharge themselves into the Jumna.

The principal rivers are the Sind, Betwa, Ken, Baighin, Paisuni, Tons, Pahuj, Dhasan, Berma, Urmal and Chandrawal. The Sind, rising near Sironj in Malwa, marks the frontier line of Bundelkhand on the side of Gwalior. Parallel to this river, but more to the eastward, is the course of the Betwa. Still farther to the east flows the Ken, followed in succession by the Baighin, Paisuni and Tons. The Jumna and the Ken are the only two navigable rivers. Notwithstanding the large number of streams, the depression of their channels and height of their banks render them for the most part unsuitable for the purposes of irrigation,—which is conducted by means of *jhils* and tanks. These artificial lakes are usually formed by throwing embankments across the lower extremities of valleys, and thus arresting and accumulating the waters flowing through them. Some of the tanks are of great capacity; the Barwa Sagar, for instance, is 2½ m. in diameter. Diamonds are found, particularly near the town of Panna, in a range of hills called by the natives Band-Ahil.

The mines of Maharajpur, Rajpur, Kimera and Gadasia have been famous for magnificent diamonds; and a very large one dug from the last was kept in the fort of Kalinjar among the treasures of Raja Himmat Bahadur. In the reign of the emperor Akbar the mines of Panna produced diamonds to the amount of £100,000 annually, and were a considerable source of revenue, but for many years they have not been so profitable.

The tree vegetation consists rather of jungle or copse than forest, abounding in game which is preserved by the native chiefs. There are also within these coverts several varieties of wild animals, such as the tiger, leopard, hyena, wild boar, *nilgái* and jackal.

The people represent various races. The Bundelas—the race who gave the name to the country—still maintain their dignity as chieftains, by disdain to cultivate the soil, although by no means conspicuous for lofty sentiments of honour or morality. An Indian proverb avers that "one native of Bundelkhand commits as much fraud as a hundred Dandis" (weighers of grain, and notorious rogues). About Datia and Jhansi the inhabitants are a stout and handsome race of men, well off and contented. The prevailing religion in Bundelkhand is Hinduism.

The earliest dynasty recorded to have ruled in Bundelkhand were the Garhwars, who were succeeded by the Parihars; but nothing is known of either. About A.D. 800 the Parihars are said to have been ousted by the Chandels, and Dangha Varma, chief of the Chandel Rajputs, appears to have established the earliest paramount power in Bundelkhand towards the close of the 10th century A.D. Under his dynasty the country attained its greatest splendour in the early part of the 11th century, when its raja, whose dominions extended from the Jumna to the Nerbudda, marched at the head of 36,000 horse and 45,000 foot, with 640 elephants, to oppose the invasion of Mahmud of Ghazni. In 1182 the Chandel dynasty was overthrown by Prithwi Raj, the ruler of Ajmer and Delhi, after which the country remained in ruinous anarchy until the close of the 14th century, when the Bundelas, a spurious offshoot of the Garhwa tribe of Rajputs, established themselves on the right bank of the Jumna. One of these took possession of Orchha by treacherously poisoning its chief. His successor succeeded in further aggrandizing the Bundela state, but he is represented to have been a notorious plunderer, and his character is further stained by the assassination of the celebrated Abul Fazl, the prime minister and historian of Akbar. Jajhar Singh, the third Bundela chief, unsuccessfully revolted against the court of Delhi, and his country became incorporated for a short time with the empire. The struggles of the Bundelas for independence resulted in the withdrawal of the royal troops, and the admission of several petty states as feudatories of the empire on condition of military service. The Bundelas, under Champat Rai and his son Chhatar Sal, offered a successful resistance to the proselytizing efforts of Aurangzeb. On the occasion of a Mahomedan invasion in 1732, Chhatar Sal asked and obtained the assistance of the Mahratta Peshwa, whom he adopted as his son, giving him a third of his dominions. The Mahrattas gradually extended their influence over Bundelkhand,

and in 1792 the peshwa was acknowledged as the lord paramount of the country. The Marhatta power was, however, on the decline; the flight of the peshwa from his capital to Bassein before the British arms changed the aspect of affairs, and by the treaty concluded between the peshwa and the British government, the districts of Banda and Hamirpur were transferred to the latter. Two chiefs then held the ceded districts, Himmat Bahadur, the leader of the Sanyasis, who promoted the views of the British, and Shamsheer, who made common cause with the Marhattas. In September 1803, the united forces of the English and Himmat Bahadur compelled Shamsheer to retreat with his army. In 1809 Ajajgarh was besieged by a British force, and again three years later Kalinjar was besieged and taken after a heavy loss. In 1817, by the treaty of Poona, the British government acquired from the peshwa all his rights, interests and pretensions, feudal, territorial or pecuniary, in Bundelkhand. In carrying out the provisions of the treaty, an assurance was given by the British government that the rights of those interested in the transfer should be scrupulously respected, and the host of petty native principalities in the province is the best proof of the sincerity and good faith with which this clause has been carried out. During the mutiny of 1857, however, many of the chiefs rose against the British, the rani of Jhansi being a notable example.

BUNDI, or **BOONDEE**, a native state of India, in the Rajputana agency, lying on the north-east of the river Chambal, in a hilly tract historically known as Haraoti, from the Hara sept of the great clan of Chauhan Rajputs, to which the maharao raja of Bundi belongs. It has an area of 2220 sq. m. Many parts of the state are wild and hilly, inhabited by a large Mina population, formerly notorious as a race of robbers. Two rivers, the Chambha and the Mej, water the state; the former is navigable by boats. In 1901 the population was 171,227, showing a decrease of 42% due to the effects of famine. The estimated revenue is £46,000, the tribute £8000. There is no railway, but the metalled road from Kotah to the British cantonment of Deoli passes through the state. The town of Bundi had a population in 1901 of 19,313. A school for the education of boys of high rank was opened in 1897.

The state of Bundi was founded about A.D. 1342 by the Hara chief Rao Dewa, or Deora], who captured the town from the Minas. Its importance, however, dates from the time of Rao Surjan, who succeeded to the chieftainship in 1554 and by throwing in his lot with the Mahomedan emperors of Delhi (1560) received a considerable accession of territory. From this time the rulers of Bundi bore the title of rao raja. In the 17th century their power was curtailed by the division of Haraoti into the two states of Kotah and Bundi; but they continued to play a prominent part in Indian history, and the title of maharao raja was conferred on Budh Singh for the part played by him in securing the imperial throne for Bahadur Shah I. after the death of Aurangzeb in 1707. In 1804 the maharao raja Bishan Singh gave valuable assistance to Colonel Monson in his disastrous retreat before Holkar, in revenge for which the Marhattas and Pindaris continually ravaged his state up to 1817. On the 10th of February 1818, by a treaty concluded with Bishan Singh, Bundi was taken under British protection. In 1821 Bishan Singh was succeeded by his son Ram Singh, who ruled till 1889. He is described as a grand specimen of the Rajput gentleman, and "the most conservative prince in conservative Rajputana." His rule was popular and beneficent; and though during the mutiny of 1857 his attitude was equivocal, he continued to enjoy the favour of the British government, being created G.C.S.I. and a counsellor of the empire in 1877 and C.I.E. in 1878. He was succeeded by his son Raghuraj Singh, who was made a K.C.S.I. in 1897 and a G.C.I.E. in 1901.

BUNER, a valley on the Peshawar border of the North-West Frontier Province of India. It is a small mountain valley, dotted with villages and divided into seven sub-divisions. The Mora Hills and the Ilam range divide it from Swat, the Sinawar range from Yusufzai, the Guru mountains from the Chamlia valley, and the Duma range from the Pura Valley. It is in-

habited by the Iliaszai and Malizai divisions of the Pathan tribe of Yusufzais, who are called after their country the Bunerwals. There is no finer race on the north-west frontier of India than the Bunerwals. Simple and austere in their habits, religious and truthful in their ways, hospitable to all who seek shelter amongst them, free from secret assassinations, they are bright examples of the Pathan character at its best. They are a powerful and warlike tribe, numbering 8000 fighting men. The Umbeyla Expedition of 1863 under Sir Neville Chamberlain was occasioned by the Bunerwals siding with the Hindostani Fanatics, who had settled down at Malka in their territory. In the end the Bunerwals were subdued by a force of 9000 British troops, and Malka was destroyed, but they made so fierce a resistance, in particular in their attack upon the "Crag" picket, that the Indian medal with a clasp for "Umbeyla" was granted in 1869 to the survivors of the expedition. The government of India refrained from interfering with the tribe again until the Buner campaign of 1897 under Sir Bindon Blood. Many Bunerwals took part in the attack of the Swatis on the Malakand fort, and a force of 3000 British troops was sent to punish them; but the tribe made only a feeble resistance at the passes into their country, and speedily handed in the arms demanded of them and made complete submission.

BUNGALOW (an Anglo-Indian word from the Hindustani *bangla*, belonging to Bengal), a one-storeyed house with a verandah and a projecting roof, the typical dwelling for Europeans in India; the name is also used for similar buildings which have become common for seaside and summer residences in America and Great Britain. Dak or dawk bungalows (from *dak* or *dawk*, a post, a relay of men for carrying the mails, &c.) are the government rest-houses established at intervals for the use of travellers on the high roads of India.

BUNGAY, a market-town in the Lowestoft parliamentary division of Suffolk, England; 113 m. N.E. from London on a branch from Beccles of the Great Eastern railway. Pop. (1901) 3314. It is picturesquely placed in a deep bend of the river Waveney, the boundary with Norfolk. Of the two parish churches that of St Mary has a fine Perpendicular tower, and that of Holy Trinity a round tower of which the lower part is Norman. St Mary's was attached to a Benedictine nunnery founded in 1160. The ruins of the castle date from 1281. They are fragmentary though massive; and there are traces of earth-works of much earlier date. The castle was a stronghold of the powerful family of Bigod, being granted to Roger Bigod, a Norman follower of the Conqueror, in 1075. A grammar school was founded in 1592. There are large printing-works, and founding and malting are prosecuted. There is a considerable carrying trade on the Waveney.

BUNION (a word usually derived from the Ital. *bugnare*, a swelling, but, according to the *New English Dictionary*, the late and rare literary use of the word makes an Italian derivation unlikely; there is an O. Eng. word "bunny," also meaning a swelling, and an O. Fr. *bugne*, modern *bugne*, showing a probable common origin now lost, cf. also "bunch"), an inflamed swelling of the *bursa mucosa*, the sac containing synovial fluid on the metatarsal joint of the big toe, or, more rarely, of the little toe. This may be accompanied by corns or suppuration, leading to an ulcer or even gangrene. The cause is usually pressure; removal of this, and general palliative treatment by dressings, &c. are usually effective, but in severe and obstinate cases a surgical operation may be necessary.

BUNKER HILL, the name of a small hill in Charlestown (Boston), Massachusetts, U.S.A., famous as the scene of the first considerable engagement in the American War of Independence (June 17, 1775). Bunker Hill (110 ft.) was connected by a ridge with Breed's Hill (75 ft.), both being on a narrow peninsula a short distance to the north of Boston, joined by a causeway with the mainland. Since the affair of Lexington (April 19, 1775) General Gage, who commanded the British forces, had remained inactive at Boston awaiting reinforcements from England; the headquarters of the Americans were at Cambridge, with advanced posts occupying much of the 4 m. separating

Cambridge from Bunker Hill. When Gage received his reinforcements at the end of May, he determined to repair his strange neglect by which the hills on the peninsula had been allowed to remain unoccupied and unfortified. As soon as the Americans became aware of Gage's intention they determined to frustrate it, and accordingly, on the night of the 16th of June, a force of about 1200 men, under Colonel William Prescott and Major-General Israel Putnam, with some engineers and a few field-guns, occupied Breed's Hill—to which the name Bunker Hill is itself now popularly applied—and when daylight disclosed their presence to the British they had already strongly entrenched their position. Gage lost no time in sending troops across from Boston with orders to assault. The British force, between 2000 and 3000 strong, under (Sir) William Howe, supported by artillery and by the guns of men-of-war and floating batteries stationed in the anchorage on either side of the peninsula, were fresh and well disciplined. The American force consisted for the most part of inexperienced volunteers, numbers of whom were already wearied by the trench work of the night. As communication was kept up with their camp the numbers engaged on the hill fluctuated during the day, but at no time exceeded about 1500 men. The village of Charlestown, from which a galling musketry fire was directed against the British, was by General Howe's orders almost totally destroyed by hot shot during the attack. Instead of attempting to cut off the Americans by occupying the neck to the rear of their position, Gage ordered the advance to be made up the steep and difficult ascent facing the works on the hill. Whether or not in obedience—as tradition asserts—to an order to reserve fire until they could see the whites of their assailants' eyes, the American volunteers with admirable steadiness waited till the attack was on the point of being driven home, when they delivered a fire so sustained and deadly that the British line broke in disorder. A second assault, made like the first, with the precision and discipline of the parade-ground met the same fate, but Gage's troops had still spirit enough for a third assault, and this time they carried the position with the bayonet, capturing five pieces of ordnance and putting the enemy to flight. The loss of the British was 1054 men killed and wounded, among whom were 89 commissioned officers; while the American casualties amounted to 420 killed and wounded, including General Joseph Warren, and 30 prisoners. (See AMERICAN WAR OF INDEPENDENCE.)

The significance of the battle of Bunker Hill is not, however, to be gauged by the losses on either side, heavy as they were in proportion to the numbers engaged, nor by its purely military results, but by the moral effect which it produced; and when it is considered from this standpoint its far-reaching consequences can hardly be over-estimated. "It roused at once the fierce instinct of combat in America . . . and dispelled . . . the almost superstitious belief in the impossibility of encountering regular troops with hastily levied volunteers. . . . No one questioned the conspicuous gallantry with which the provincial troops had supported a long fire from the ships and awaited the charge of the enemy, and British soldiers had been twice driven back in disorder before their fire."¹ The pride which Americans naturally felt in such an achievement, and the self-confidence which it inspired, were increased when they learnt that the small force on Bunker Hill had not been properly reinforced, and that their ammunition was running short before they were dislodged from their position.² Had the character of the fighting on that day been other than it was; had the American volunteers been easily, and at the first assault, driven from their fortified position by the troops of George III., it is not impossible that the resistance to the British government would have died out in the North American colonies through lack of confidence in their own power on the part of the colonists. Bunker Hill, whatever it may have to teach the student of war, taught the American colonists in 1775 that the odds against them in the enterprise in

which they had embarked were not so overwhelming as to deny them all prospect of ultimate success.

In 1843 a monument, 221 ft. high, in the form of an obelisk, of Quincy granite, was completed on Breed's Hill (now Bunker Hill) to commemorate the battle, when an address was delivered by Daniel Webster, who had also delivered the famous dedicatory oration at the laying of the corner-stone in 1825. Bunker Hill day is a state holiday.

See R. Frothingham, *The Centennial: Battle of Bunker Hill* (Boston, 1895), and *Life and Times of Joseph Warren* (Boston, 1865); Boston City Council, *Celebration of Centes. Anniv. of Battle of Bunker Hill* (Boston, 1875); G. E. Ellis, *Hist. of Battle of Bunker's (Breed's) Hill* (Boston, 1875); S. Sweet, *Who was the Commander at Bunker Hill?* (Boston, 1850); W. E. H. Lecky, *History of England in the Eighteenth Century*, vol. iii (London, 1883); Sir George O. Trevelyan, *The American Revolution* (London, 1899); Fortescue, *History of the British Army*, vol. iii. pp. 153 seq. (London, 1902). (R. J. M.)

BUNN, ALFRED (1796-1860), English theatrical manager, was appointed stage-manager of Drury Lane theatre, London, in 1823. In 1826 he was managing the Theatre Royal, Birmingham, and in 1833 he undertook the joint management of Drury Lane and Covent Garden, London. In this undertaking he met with vigorous opposition. A bill for the abolition of the patent theatres was passed in the House of Commons, but on Bunn's petition was thrown out by the House of Lords. He had difficulties first with his company, then with the lord chamberlain, and had to face the keen rivalry of the other theatres. A long-standing quarrel with Macready resulted in the tragedian assaulting the manager. In 1840 Bunn was declared a bankrupt, but he continued to manage Drury Lane till 1848. Artistically his control of the two chief English theatres was highly successful. Nearly every leading English actor played under his management, and he made a courageous attempt to establish English opera, producing the principal works of Balfe. He had some gift for writing, and most of the libretti of these operas were translated by himself. In *The Stage Before and Behind the Curtain* (3 vols., 1840) he gave a full account of his managerial experiences. He died at Boulogne on the 20th of December 1860.

BUNNER, HENRY CUYLER (1855-1896), American writer, was born in Oswego, New York, on the 3rd of August 1855. He was educated in New York City. From being a clerk in an importing house, he turned to journalism, and after some work as a reporter, and on the staff of the *Arcadian* (1873), he became in 1877 assistant editor of the comic weekly *Puck*. He soon assumed the editorship, which he held until his death in Nutley, N. J., on the 11th of May 1896. He developed *Puck* from a new struggling periodical into a powerful social and political organ. In 1886 he published a novel, *The Midge*, followed in 1887 by *The Story of a New York House*. But his best efforts in fiction were his short stories and sketches—*Short Sixes* (1891), *More Short Sixes* (1894), *Made in France* (1893), *Zadoc Pine and Other Stories* (1891), *Love in Old Clothes and Other Stories* (1896), and *Jersey Street and Jersey Lane* (1896). His verses—*Airs from Arcady and Elsewhere* (1884), containing the well-known poem, *The Way to Arcady*; *Rowen* (1892); and *Poems* (1896), edited by his friend Brander Matthews—display a light play of imagination and a delicate workmanship. He also wrote clever *vers de société* and parodies. Of his several plays (usually written in collaboration), the best was *The Tower of Babel* (1883).

BUNSEN, CHRISTIAN CHARLES JOSIAS, BARON VON (1791-1860), Prussian diplomatist and scholar, was born on the 25th of August 1791 at Korbach, an old town in the little Gerhald principality of Waldeck. His father was a farmer who was driven by poverty to become a soldier. Having studied at the Korbach grammar school and Marburg university, Bunsen went in his nineteenth year to Göttingen, where he supported himself by teaching and later by acting as tutor to W. B. Astor, the American merchant. He won the university prize essay of the year 1812 by a treatise on the *Athenian Law of Inheritance*, and a few months later the university of Jena granted him the honorary degree of doctor of philosophy. During 1813 he travelled with Astor in South Germany, and then turned to the study of the religion, laws, language and literature of the Teutonic

¹ W. E. H. Lecky, *History of England in the Eighteenth Century*, iii. 428.

² General Gage's despatch. *American Remembrancer*, 1776, part 11, p. 132.

ances. He had read Hebrew when a boy, and now worked at Arabic at Munich, Persian at Leiden, and Norse at Copenhagen. At the close of 1815 he went to Berlin, to lay before Niebuhr the plan of research which he had mapped out. Niebuhr was so impressed with Bunsen's ability that, two years later, when he became Prussian envoy to the papal court, he made the young scholar his secretary. The intervening years Bunsen spent in assiduous labour among the libraries and collections of Paris and Florence. In July 1817 he married Frances Waddington, eldest daughter and co-heiress of B. Waddington of Llanover, Monmouthshire.

As secretary to Niebuhr, Bunsen was brought into contact with the Vatican movement for the establishment of the papal church in the Prussian dominions, to provide for the largely increased Catholic population. He was among the first to realize the importance of this new vitality on the part of the Vatican, and he made it his duty to provide against its possible dangers by urging upon the Prussian court the wisdom of fair and impartial treatment of its Catholic subjects. In this object he was at first successful, and both from the Vatican and from Frederick William III., who put him in charge of the legation on Niebuhr's resignation, he received unqualified approbation. Owing partly to the wise statesmanship of Count Spiegel, archbishop of Cologne, an arrangement was made by which the thorny question of "mixed" marriages (*i.e.* between Catholic and Protestant) would have been happily solved; but the archbishop died in 1835, the arrangement was never ratified, and the Prussian king was foolish enough to appoint as Spiegel's successor the narrow-minded partisan Baron Droste. The pope gladly accepted the appointment, and in two years the forward policy of the Jesuits had brought about the strife which Bunsen and Spiegel had tried to prevent. Bunsen rashly recommended that Droste should be seized, but the *coup* was so clumsily attempted, that the incriminating documents were, it is said, destroyed in advance. The government, in this *impasse*, took the safest course, refused to support Bunsen, and accepted his resignation in April 1838.

After leaving Rome, where he had become intimate with all that was most interesting in the cosmopolitan society of the papal capital, Bunsen went to England, where, except for a short term as Prussian ambassador to Switzerland (1839-1841), he was destined to pass the rest of his official life. The accession to the throne of Prussia of Frederick William IV., on June 7th, 1840, made a great change in Bunsen's career. Ever since their first meeting in 1828 the two men had been close friends and had exchanged ideas in an intimate correspondence, published under Ranke's editorship in 1873. Enthusiasm for evangelical religion and admiration for the Anglican Church they held in common, and Bunsen was the instrument naturally selected for realizing the king's fantastic scheme of setting up at Jerusalem a Prusso-Anglican bishopric as a sort of advertisement of the unity and aggressive force of Protestantism. The special mission of Bunsen to England, from June to November 1841, was completely successful, in spite of the opposition of English high churchmen and Lutheran extremists. The Jerusalem bishopric, with the consent of the British government and the active encouragement of the archbishop of Canterbury and the bishop of London, was duly established, endowed with Prussian and English money, and remained for some forty years an isolated symbol of Protestant unity and a rock of stumbling to Anglican Catholics.

During his stay in England Bunsen had made himself very popular among all classes of society, and he was selected by Queen Victoria, out of three names proposed by the king of Prussia, as ambassador to the court of St James's. In this post he remained for thirteen years. His tenure of the office coincided with the critical period in Prussian and European affairs which culminated in the revolutions of 1848. With the visionary schemes of Frederick William, whether that of setting up a strict episcopal organization in the Evangelical Church, or that of reviving the defunct ideal of the medieval Empire, Bunsen found himself increasingly out of sympathy. He realized the significance of the signs that heralded the coming storm, and tried in

vain to move the king to a policy which would have placed him at the head of a Germany united and free. He felt bitterly the humiliation of Prussia by Austria after the victory of the reaction; and in 1852 he set his signature reluctantly to the treaty which, in his view, surrendered the "constitutional rights of Schleswig and Holstein." His whole influence was now directed to withdrawing Prussia from the blighting influence of Austria and Russia, and attempting to draw closer the ties that bound her to Great Britain. On the outbreak of the Crimean War he urged Frederick William to throw in his lot with the western powers, and create a diversion in the north-east which would have forced Russia at once to terms. The rejection of his advice, and the proclamation of Prussia's attitude of "benevolent neutrality," led him in April 1854 to offer his resignation, which was accepted.

Bunsen's life as a public man was now practically at an end. He retired first to a villa on the Neckar near Heidelberg and later to Bonn. He refused to stand for a seat in the Liberal interest, in the Lower House of the Prussian diet, but continued to take an active interest in politics, and in 1855 published in two volumes a work, *Die Zeichen der Zeit: Briefe, &c.*, which exercised an immense influence in reviving the Liberal movement which the failure of the revolution had crushed. In September 1857 Bunsen attended, as the king's guest, a meeting of the Evangelical Alliance at Berlin; and one of the last papers signed by Frederick William, before his mind gave way in October, was that which conferred upon him the title of baron and a peerage for life. In 1858, at the special request of the regent (afterwards the emperor) William, he took his seat in the Prussian Upper House, and, though remaining silent, supported the new ministry, of which his political and personal friends were members.

Literary work was, however, his main preoccupation during all this period. Two discoveries of ancient MSS. made during his stay in London, the one containing a shorter text of the *Epistles of St Ignatius*, and the other an unknown work *On all the Heresies*, by Bishop Hippolytus, had already led him to write his *Hippolytus and his Age: Doctrine and Practice of Rome under Commodus and Severus* (1852). He now concentrated all his efforts upon a translation of the Bible with commentaries. While this was in preparation he published his *God in History*, in which he contends that the progress of mankind marches parallel to the conception of God formed within each nation by the highest exponents of its thought. At the same time he carried through the press, assisted by Samuel Birch, the concluding volumes of his work (published in English as well as in German) *Egypt's Place in Universal History*—containing a reconstruction of Egyptian chronology, together with an attempt to determine the relation in which the language and the religion of that country stand to the development of each among the more ancient non-Aryan and Aryan races. His ideas on this subject were most fully developed in two volumes published in London before he quitted England—*Outlines of the Philosophy of Universal History as applied to Language and Religion* (2 vols., 1854).

In 1858 Bunsen's health began to fail; visits to Cannes in 1858 and 1859 brought no improvement, and he died on November 28th, 1860. One of his last requests having been that his wife would write down recollections of their common life, she published his *Memoirs* in 1868, which contain much of his private correspondence. The German translation of these *Memoirs* has added extracts from unpublished documents, throwing a new light upon the political events in which he played a part. Baron Humboldt's letters to Bunsen were printed in 1869.

Bunsen's English connexion, both through his wife (d. 1876) and through his own long residence in London, was further increased in his family. He had ten children, including five sons: Henry (1818-1855), Ernest (1819-1903), Karl (1821-1887), Georg (1824-1896) and Theodor (1832-1892). Of these Karl (Charles) and Theodor had careers in the German diplomatic service; and Georg, who for some time was an active politician in Germany, eventually retired to live in London; Henry, who was an English clergyman, became a naturalized Englishman.

and Ernest, who in 1845 married an Englishwoman, Miss Gurney, subsequently resided and died in London. The form of "de" Bunsen was adopted for the surname in England. Ernest de Bunsen was a scholarly writer, who published various works both in German and in English, notably on Biblical chronology and other questions of comparative religion. His son, Sir Maurice de Bunsen (b. 1852), entered the English diplomatic service in 1877, and after a varied experience became minister at Lisbon in 1905.

See also L. von Ranke, *Aus dem Briefwechsel Friedrich Wilhelm IV. mit Bunsen* (Berlin, 1873). The biography in the 9th edition of this encyclopaedia, which has been drawn upon above, was by Georg von Bunsen.

BUNSEN, ROBERT WILHELM VON (1811-1890), German chemist, was born at Göttingen on the 31st of March 1811, his father, Christian Bunsen, being chief librarian and professor of modern philology at the university. He himself entered the university in 1828, and in 1834 became *Privat-docent*. In 1836 he became teacher of chemistry at the Polytechnic School of Cassel, and in 1839 took up the appointment of professor of chemistry at Marburg, where he remained till 1851. In 1852, after a brief period in Breslau, he was appointed to the chair of chemistry at Heidelberg, where he spent the rest of his life, in spite of an urgent invitation to migrate to Berlin as successor to E. Mitscherlich. He retired from active work in 1880, and died at Heidelberg on the 16th of August 1890. The first research by which attention was drawn to Bunsen's abilities was concerned with the cacodyl compounds (see ARSENIC), though he had already, in 1834, discovered the virtues of freshly precipitated hydrated ferric oxide as an antidote to arsenical poisoning. It was begun in 1837 at Cassel, and during the six years he spent upon it he not only lost the sight of one eye through an explosion, but nearly killed himself by arsenical poisoning. It represents almost his only excursion into organic chemistry, and apart from its accuracy and completeness it is of historical interest in the development of that branch of the science as being the forerunner of the fruitful investigations on the organo-metallic compounds subsequently carried out by his English pupil, Edward Frankland. Simultaneously with his work on cacodyl, he was studying the composition of the gases given off from blast furnaces. He showed that in German furnaces nearly half the heat yielded by the fuel was being allowed to escape with the waste gases, and when he came to England, and in conjunction with Lyon Playfair investigated the conditions obtaining in English furnaces, he found the waste to amount to over 80%. These researches marked a stage in the application of scientific principles to the manufacture of iron, and they led also to the elaboration of Bunsen's famous methods of measuring gaseous volumes, &c., which form the subject of the only book he ever published (*Gasometrische Methoden*, 1857). In 1841 he invented the carbon-zinc electric cell which is known by his name, and which conducted him to several important achievements. He first employed it to produce the electric arc, and showed that from 44 cells a light equal to 1171.3 candles could be obtained with the consumption of one pound of zinc per hour. To measure this light he designed in 1844 another instrument, which in various modifications has come into extensive use—the grease-spot photometer. In 1852 he began to carry out electrolytical decompositions by the aid of the battery. By means of a very ingenious arrangement he obtained magnesium for the first time in the metallic state, and studied its chemical and physical properties, among other things demonstrating the brilliance and high actinic qualities of the flame it gives when burnt in air. From 1855 to 1863 he published with Roscoe a series of investigations on photochemical measurements, which W. Ostwald has called the "classical example for all future researches in physical chemistry." Perhaps the best known of the contrivances which the world owes to him is the "Bunsen burner" which he devised in 1855 when a simple means of burning ordinary coal gas with a hot smokeless flame was required for the new laboratory at Heidelberg. Other appliances invented by him were the ice-calorimeter (1870), the vapour

calorimeter (1887), and the filter pump (1868), which was worked out in the course of a research on the separation of the platinum metals. Mention must also be made of another piece of work of a rather different character. Travelling was one of his favourite relaxations, and in 1846 he paid a visit to Iceland. There he investigated the phenomena of the geysers, the composition of the gases coming off from the fumaroles, their action on the rocks with which they came into contact, &c., and on his observations was founded a noteworthy contribution to geological theory. But the most far-reaching of his achievements was the elaboration, about 1859, jointly with G. R. Kirchhoff, of spectrum analysis, which has put a new weapon of extraordinary power into the hands both of chemists and astronomers. It led Bunsen himself almost immediately to the isolation of two new elements of the alkali group, caesium and rubidium. Having noticed some unknown lines in the spectra of certain salts he was examining, he set to work to obtain the substance or substances to which these were due. To this end he evaporated large quantities of the Dürkheim mineral water, and it says much both for his perseverance and powers of manipulation that he dealt with 40 tons of the water to get about 17 grammes of the mixed chlorides of the two substances, and that with about one-third of that quantity of caesium chloride was able to prepare the most important compounds of the element and determine their characteristics, even making goniometrical measurements of their crystals.

Bunsen founded no school of chemistry; that is to say, no body of chemical doctrine is associated with his name. Indeed, he took little or no part in discussions of points of theory, and, although he was conversant with the trend of the chemical thought of his day, he preferred to spend his energies in the collection of experimental data. One fact, he used to say, properly proved is worth all the theories that can be invented. But as a teacher of chemistry he was almost without rival, and his success is sufficiently attested by the scores of pupils who flocked from every part of the globe to study under him, and by the number of those pupils who afterwards made their mark in the chemical world. The secret of this success lay largely in the fact that he never delegated his work to assistants, but was constantly present with his pupils in the laboratory, assisting each with personal direction and advice. He was also one of the first to appreciate the value of practical work to the student, and he instituted a regular practical course at Marburg so far back as 1840. Though alive to the importance of applied science, he considered truth alone to be the end of scientific research, and the example he set his pupils was one of single-hearted devotion to the advancement of knowledge.

See Sir Henry Roscoe's "Bunsen Memorial Lecture," *Trans. Chem. Soc.*, 1900, which is reprinted (in German) with other obituary notices in an edition of Bunsen's collected works published by Ostwald and Bodenstein in 3 vols. at Leipzig in 1904.

BUNTER, the name applied by English geologists to the lower stage or subdivision of the Triassic rocks in the United Kingdom. The name has been adapted from the German *Buntsandstein*, *Der bunte Sandstein*, for it was in Germany that this continental type of Triassic deposit was first carefully studied. In France, the Bunter is known as the *Grès bigarré*. In northern and central Germany, in the Harz, Thuringia and Hesse, the Bunter is usually conformable with the underlying Permian formation; in the south-west and west, however, it transgresses on to older rocks, on to Coal Measures near Saarbruck, and upon the crystalline schists of Odenwald and the Black Forest.

The German subdivisions of the Bunter are as follows—(1) *Upper Buntsandstein*, or *Rot*, mottled red and green marls and clays with occasional beds of shale, sandstone, gypsum, rocksalt and dolomite. In Hesse and Thuringia, a quartzitic sandstone prevails in the lower part. The "Rhizocorallium Dolomite" (*R. Jenense*, probably a sponge) of the latter district contains the only Bunter fauna of any importance. In Lorraine and the Eifel and Saar districts there are micaceous clays and sandstones with plant remains—the *Volstia* sandstone. The lower beds in the Black Forest, Vosges, Odenwald and Lorraine very generally contain strings of dolomite and carnelian—the so-called "Carnool bank." (2) *Middle Buntsandstein-Hauptbuntsandstein* (900 ft.), the bulk

of this subdivision is made up of weakly-cemented, coarse-grained sandstones, oblique lamination is very prevalent, and occasional conglomeratic beds make their appearance. The uppermost bed is usually fine-grained and bears the footprints of *Cheirotherium*. In the Vosges district, this subdivision of the Bunter is called the *Grès des Vosges*, or the *Grès principal*, which comprises: (i.) red micaceous and argillaceous sandstone; (ii.) the *conglomérat principal*; and (iii.) *Grès bigarré principal* (= *grès des Vosges*, properly so-called). (3) *Lower Buntsandstein*, fine-grained clayey and micaceous sandstones, red-grey, yellow, white and mottled. The cement of the sandstones is often felspathic; for this reason they yield useful porcelain clays in the Thuringerwald. Clay galls are common in the sandstones of some districts, and in the neighbourhood of the Harz an oolitic calcareous sandstone, *Ropenstein*, occurs. In eastern Hesse, the lowest beds are crumbly, shaly clays, *Bröckelschiefer*.

The following are the subdivisions usually adopted in England:— (1) *Upper Mottled Sandstone*, red variegated sandstones, soft and generally free from pebbles. (2) *Bunter Pebble Beds*, harder red and brown sandstones with quartzose pebbles, very abundant in some places. (3) *Lower Mottled Sandstone*, very similar to the upper division. The Bunter beds occupy a large area in the midland counties where they form dry, healthy ground of moderate elevation (Cannock Chase, Trentham, Sherwood Forest, Sutton Coldfield, &c.). Southward they may be followed through west Somerset to the cliffs of Budleigh Salterton in Devon; while northward they pass through north Staffordshire, Cheshire and Lancashire to the Vale of Eden and St Bees, reappearing in Elgin and Arran. A deposit of these rocks lies in the Vale of Clwyd and probably flanks the eastern side of the Pennine Hills, although here it is not so readily differentiated from the Keuper beds. The English Bunter rests with a slight unconformity upon the older formations. It is generally absent in the south-eastern counties, but thickens rapidly in the opposite direction, as is shown by the following table:—

Lancashire and W. Cheshire.	Staffordshire.	Leicestershire and Warwickshire.
(1) 500 ft.	50-200 ft.	Absent
(2) 500-750 ft.	100-300 ft.	0-100 ft.
(3) 200-500 ft.	0-100 ft.	Absent

The material forming the Bunter beds of England came probably from the north-west, but in Devonshire there are indications which point to an alpine source.

In the Alpine region, most of the Trias differs markedly from that of England and northern Germany, being of distinctly marine origin; here the Bunter is represented by the *Werfen beds* (from Werfen in Salzburg) in the northern Alps, a series of red and greenish-grey micaceous shales with gypsum, rock salt and limestones in the upper part; while in the southern Alps (S. Tirol) there is an upper series of red clays, the *Campil beds*, and a lower series of thin sandstones, the *Seis beds*. Mojsisovics von Mojsvar has pointed out that the Alpine Bunter belongs to the single zone of *Nalica costata* and *Tirolietes cassianus*.

Fossils in the Bunter are very scarce; in addition to the footprints of *Cheirotherium*, direct evidence of amphibians is found in such forms as *Trematosaurus* and *Mastodonsaurus*. *Myophoria costata* and *Gerrilla Murchisoni* are characteristic fossils. Plants are represented by *Volzia* and by equesterns and ferns.

In England, the Bunter sandstones frequently act as valuable reservoirs of underground water; sometimes they are used for building stone or for foundry sand. In Germany some of the harder beds have yielded building stones, which were much used in the middle ages in the construction of cathedrals and castles in southern Germany and on the Rhine. In the northern Eifel region, at Mechernich and elsewhere, this formation contains lead ore in the form of spots and patches (*Knochenz*) in the sandstone; some of the lead ore was worked by the Romans.

For a consideration of the relationship of the Bunter beds to formations of the like age in other parts of the world, see TRIASSIC SYSTEM. (J. A. H.)

BUNTING, JABEZ (1779-1858), English Wesleyan divine, was born of humble parentage at Manchester on the 13th of May 1779. He was educated at Manchester grammar school, and at the age of nineteen began to preach, being received into full connexion in 1803. He continued to minister for upwards of fifty-seven years in Manchester, Sheffield, Leeds, Liverpool, London and elsewhere. In 1835 he was appointed president of the first Wesleyan theological college (at Hoxton), and in this position he succeeded in materially raising the standard of

education among Wesleyan ministers. He was four times chosen to be president of the conference, was repeatedly secretary of the "Legal Hundred," and for eighteen years was secretary to the Wesleyan Missionary Society. Under him Methodistism ceased to be a society based upon Anglican foundation, and became a distinct church. He favoured the extension of lay power in committees, and was particularly zealous in the cause of foreign missions. Bunting was a popular preacher, and an effective platform speaker; in 1818 he was given the degree of M.A. by Aberdeen University, and in 1834 that of D.D. by Wesleyan University of Middletown, Conn., U.S.A. He died on the 16th of June 1858. His eldest son, William MacLardie Bunting (1805-1866), was also a distinguished Wesleyan minister; and his grandson Sir Percy William Bunting (b. 1836), son of T. P. Bunting, became prominent as a liberal nonconformist and editor of the *Contemporary Review* from 1882, being knighted in 1908.

See *Lives of Jabez Bunting* (1859) and W. M. Bunting (1870) by Thomas Percival Bunting.

BUNTING, properly the common English name of the bird called by Linnaeus *Emberiza miliaria*, but now used in a general sense for all members of the family *Emberizidae*, which are closely allied to the finches (*Fringillidae*), though in Professor W. K. Parker's opinion, to be easily distinguished therefrom—the *Emberizidae* possessing what none of the *Fringillidae* do, an additional pair of palatal bones, "palato-maxillaries." It will probably follow from this diagnosis that some forms of birds, particularly those of the New World, which have hitherto been commonly assigned to the latter, really belong to the former, and among them the genera *Cardinalis* and *Phrygilus*. The additional palatal bones just named are also found in several other peculiarly American families, namely, *Tanagridae*, *Icteridae* and *Mniotiltidae*—whence it may be perhaps inferred that the *Emberizidae* are of Transatlantic origin. The buntings generally may be also outwardly distinguished from the finches by their angular gape, the posterior portion of which is greatly deflected; and most of the Old-World forms, together with some of those of the New World, have a bony knob on the palate—a swollen outgrowth of the dentary edges of the bill. Correlated with this peculiarity the maxilla usually has the tomsia sinuated, and is generally concave, and smaller and narrower than the mandible, which is also concave to receive the palatal knob. In most other respects the buntings greatly resemble the finches, but their eggs are generally distinguishable by the irregular hair-like markings on the shell. In the British Islands by far the commonest species of bunting is the yellow-hammer (*E. citrinella*), but the true bunting (or corn-bunting, or bunting-lark, as it is called in some districts) is a very well-known bird, while the reed-bunting (*E. schoeniclus*) frequents marshy soils almost to the exclusion of the two former. In certain localities in the south of England the curl-bunting (*E. cirlus*) is also a resident; and in winter vast flocks of the snow-bunting (*Plectrophenax nivalis*), at once recognizable by its pointed wings and elongated hind-claws, resort to our shores and open grounds. This last is believed to breed sparingly on the highest mountains of Scotland, but the majority of the examples which visit us come from northern regions, for it is a species which in summer inhabits the whole circumpolar area. The ortolan (*E. hortulanus*), so highly prized for its delicate flavour, occasionally appears in England, but the British Islands seem to lie outside its proper range. On the continent of Europe, in Africa and throughout Asia, many other species are found, while in America the number belonging to the family cannot at present be computed. The beautiful and melodious cardinal (*Cardinalis virginianus*), commonly called the Virginian nightingale, must be included in this family. (A. N.)

BUNTING (a word of doubtful origin, possibly connected with *bunt*, to sift, or with the Ger. *bunt*, of varied colour), a loosely woven woollen cloth for making flags; the term is also used of a collection of flags, and particularly those of a ship.

BUNYAN, JOHN (1628-1688), English religious writer, was born at Elstow, about a mile from Bedford, in November 1628. His father, Thomas Bunyan,¹ was a tinker, or, as he described himself, a "brasier." The tinkers then formed a hereditary caste, which was held in no high estimation. Bunyan's father had a fixed residence, and was able to send his son to a village school where reading and writing were taught.

The years of John's boyhood were those during which the Puritan spirit was in the highest vigour all over England; and nowhere had that spirit more influence than in Bedfordshire. It is not wonderful, therefore, that a lad to whom nature had given a powerful imagination and sensibility which amounted to a disease, should have been early haunted by religious terrors. Before he was ten his sports were interrupted by fits of remorse and despair; and his sleep was disturbed by dreams of fiends trying to fly away with him. As he grew older his mental conflicts became still more violent. The strong language in which he described them strangely misled all his earlier biographers except Southey. It was long an ordinary practice with pious writers to cite Bunyan as an instance of the supernatural power of divine grace to rescue the human soul from the lowest depths of wickedness. He is called in one book the most notorious of profligates; in another, the brand plucked from the burning. Many excellent persons, whose moral character from boyhood to old age has been free from any stain discernible to their fellow-creatures, have, in their autobiographies and diaries, applied to themselves, and doubtless with sincerity, epithets as severe as could be applied to Titus Oates or Mrs Brownrigg. It is quite certain that Bunyan was, at eighteen, what, in any but the most austere puritanical circles, would have been considered as a young man of singular gravity and innocence. Indeed, it may be remarked that he, like many other penitents who, in general terms, acknowledge themselves to have been the worst of mankind, fired up, and stood vigorously on his defence, whenever any particular charge was brought against him by others. He declares, it is true, that he had let loose the reins on the neck of his lusts, that he had delighted in all transgressions against the divine law, and that he had been the ringleader of the youth of Elstow in all manner of vice. But when those who wished him ill accused him of licentious amours, he called on God and the angels to attest his purity. No woman, he said, in heaven, earth or hell, could charge him with having ever made any improper advances to her. Not only had he been strictly faithful to his wife; but he had, even before his marriage, been perfectly spotless. It does not appear from his own confessions, or from the railings of his enemies, that he ever was drunk in his life. One bad habit he contracted, that of using profane language; but he tells us that a single reproof cured him so effectually that he never offended again. The worst that can be laid to his charge is that he had a great liking for some diversions, quite harmless in themselves, but condemned by the rigid precisians among whom he lived, and for whose opinion he had a great respect. The four chief sins of which he was guilty were dancing, ringing the bells of the parish church, playing at tipcat and reading the history of Sir Bevis of Southampton. A rector of the school of Laud would have held such a young man up to the whole parish as a model. But Bunyan's notions of good and evil had been learned in a very different school; and he was made miserable by the conflict between his tastes and his scruples.

When he was about seventeen the ordinary course of his life was interrupted by an event which gave a lasting colour to his thoughts. He enlisted in the Parliamentary army,² and served

during the decisive campaign of 1645. All that we know of his military career is, that, at the siege of some town,³ one of his comrades, who had marched with the besieging army instead of him, was killed by a shot. Bunyan ever after considered himself as having been saved from death by the special interference of Providence. It may be observed that his imagination was strongly impressed by the glimpse which he had caught of the pomp of war. To the last he loved to draw his illustrations of sacred things from camps and fortresses, from guns, drums, trumpets, flags of truce, and regiments arrayed each under its own banner. His *Greatheart*, his *Captain Boanerges* and his *Captain Credence* are evidently portraits, of which the originals were among those martial saints who fought and expounded in Fairfax's army.

In 1646 Bunyan returned home and married about two years later. His wife had some pious relations, and brought him as her only portion some pious books. His mind, excitable by nature, very imperfectly disciplined by education, and exposed to the enthusiasm which was then epidemic in England, began to be fearfully disordered. The story of the struggle is told in Bunyan's *Grace Abounding*.

In outward things he soon became a strict Pharisee. He was constant in attendance at prayers and sermons. His favourite amusements were, one after another, relinquished, though not without many painful struggles. In the middle of a game at tipcat he paused, and stood staring wildly upwards with his stick in his hand. He had heard a voice asking him whether he would leave his sins and go to heaven, or keep his sins and go to hell; and he had seen an awful countenance frowning on him from the sky. The odious vice of bell-ringing he renounced; but he still for a time ventured to go to the church tower and look on while others pulled the ropes. But soon the thought struck him that, if he persisted in such wickedness, the steeple would fall on his head; and he fled in terror from the accursed place. To give up dancing on the village green was still harder; and some months elapsed before he had the fortitude to part with his darling sin. When this last sacrifice had been made, he was, even when tried by the maxims of that austere time, faultless. All Elstow talked of him as an eminently pious youth. But his own mind was more unquiet than ever. Having nothing more to do in the way of visible reformation, yet finding in religion no pleasures to supply the place of the juvenile amusements which he had relinquished, he began to apprehend that he lay under some special malediction; and he was tormented by a succession of fantasies which seemed likely to drive him to suicide or to Bedlam. At one time he took it into his head that all persons of Israelite blood would be saved, and tried to make out that he partook of that blood; but his hopes were speedily destroyed by his father, who seems to have had no ambition to be regarded as a Jew. At another time Bunyan was disturbed by a strange dilemma: "If I have not faith, I am lost; if I have faith, I can work miracles." He was tempted to cry to the puddles between Elstow and Bedford, "Be ye dry," and to stake his eternal hopes on the event. Then he took up a notion that the day of grace for Bedford and the neighbouring villages was past; that all who were to be saved in that part of England were already converted; and that he had begun to pray and strive some months too late. Then he was harassed by doubts whether the Turks were not in the right and the Christians in the wrong. Then he was troubled by a maniacal impulse which prompted him to pray to the trees, to a broomstick, to the parish bull.

As yet, however, he was only entering the valley of the shadow of death. Soon the darkness grew thicker. Hideous forms floated before him. Sounds of cursing and wailing were in his ears. His way ran through stench and fire, close to the mouth of the bottomless pit. He began to be haunted by a strange curiosity about the unpardonable sin, and by a morbid longing to commit it. But the most frightful of all the forms which

³ There is no means of identifying the place besieged. It has been assumed to be Leicester, which was captured by the Royalists in May 1645, and recovered by Fairfax in the next month.

¹ The name, in various forms as Buignon, Buniun, Bonyon or Binyan, appears in the local records of Elstow and the neighbouring parishes at intervals from as far back as 1199. They were small freeholders, but all the property except the cottage had been lost in the time of Bunyan's grandfather. Bunyan's own account of his family as the "meanest and most despised of all the families of the land" must be put down to his habitual self-depreciation. Thomas Bunyan had a forge and workshop at Elstow.

² There is no direct evidence to show on which side he fought, but the balance of probability justifies this view.

his disease took was a propensity to utter blasphemy, and especially to renounce his share in the benefits of the redemption. Night and day, in bed, at table, at work, evil spirits, as he imagined, were repeating close to his ear the words, "Sell him, sell him." He struck at the hobgoblins; he pushed them from him; but still they were ever at his side. He cried out in answer to them, hour after hour, "Never, never; not for thousands of worlds; not for thousands." At length, worn out by this long agony, he suffered the fatal words to escape him, "Let him go if he will." Then his misery became more fearful than ever. He had done what could not be forgiven. He had forfeited his part of the great sacrifice. Like Esau, he had sold his birth-right; and there was no longer any place for repentance. "None," he afterwards wrote, "knows the terrors of those days but myself." He has described his sufferings with singular energy, simplicity and pathos. He envied the brutes; he envied the very stones on the street, and the tiles on the houses. The sun seemed to withhold its light and warmth from him. His body, though cast in a sturdy mould, and though still in the highest vigour of youth, trembled whole days together with the fear of death and judgment. He fancied that this trembling was the sign set on the worst reprobates, the sign which God had put on Cain. The unhappy man's emotion destroyed his power of digestion. He had such pains that he expected to burst asunder like Judas, whom he regarded as his prototype.

Neither the books which Bunyan read, nor the advisers whom he consulted, were likely to do much good in a case like his. His small library had received a most unseasonable addition, the account of the lamentable end of Francis Spira. One ancient man of high repute for piety, whom the sufferer consulted, gave an opinion which might well have produced fatal consequences. "I am afraid," said Bunyan, "that I have committed the sin against the Holy Ghost." "Indeed," said the old fanatic, "I am afraid that you have."

At length the clouds broke; the light became clearer and clearer; and the enthusiast who had imagined that he was branded with the mark of the first murderer, and destined to the end of the arch-traitor, enjoyed peace and a cheerful confidence in the mercy of God. Years elapsed, however, before his nerves, which had been so perilously overstrained, recovered their tone. When he had joined a Baptist society at Bedford, and was for the first time admitted to partake of the eucharist, it was with difficulty that he could refrain from imprecating destruction on his brethren while the cup was passing from hand to hand. After he had been some time a member of the congregation he began to preach; and his sermons produced a powerful effect. He was indeed illiterate; but he spoke to illiterate men. The severe training through which he had passed had given him such an experimental knowledge of all the modes of religious melancholy as he could never have gathered from books; and his vigorous genius, animated by a fervent spirit of devotion, enabled him not only to exercise a great influence over the vulgar, but even to extort the half-contemptuous admiration of scholars. Yet it was long before he ceased to be tormented by an impulse which urged him to utter words of horrible impiety in the pulpit.¹

Bunyan was finally relieved from the internal sufferings which had embittered his life by sharp persecution from without. He had been five years a preacher when the Restoration put it in the power of the Cavalier gentlemen and clergymen all over the country to oppress the dissenters. In November 1660 he was flung into Bedford gaol; and there he remained, with some intervals of partial and precarious liberty, during twelve years.

¹ Bunyan had joined, in 1653, the nonconformist community which met under a certain Mr Gifford at St John's church, Bedford. This congregation was not Baptist, properly so called, as the question of baptism, with other doctrinal points, was left open. When Bunyan removed to Bedford in 1655, he became a deacon of this church, and two years later he was formally recognized as a preacher, his fame soon spreading through the neighbouring counties. His wife died soon after their removal to Bedford, and he also lost his friend and pastor, Mr Gifford. His earliest work was directed against Quaker mysticism and appeared in 1656. It was entitled *Some Gospel Truths Opened*; it was followed in the same year by a second tract in the same sense, *A Vindication of Gospel Truths*.

The authorities tried to extort from him a promise that he would abstain from preaching; but he was convinced that he was divinely set apart and commissioned to be a teacher of righteousness, and he was fully determined to obey God rather than man. He was brought before several tribunals, laughed at, caressed, reviled, menaced, but in vain. He was facetiously told that he was quite right in thinking that he ought not to hide his gift; but that his real gift was skill in repairing old kettles. He was compared to Alexander the coppersmith. He was told that if he would give up preaching he should be instantly liberated. He was warned that if he persisted in disobeying the law he would be liable to banishment, and that if he were found in England after a certain time his neck would be stretched. His answer was, "If you let me out to-day, I will preach again to-morrow." Year after year he lay patiently in a dungeon, compared with which the worst prison now to be found in the island is a palace.² His fortitude is the more extraordinary because his domestic feelings were unusually strong. Indeed, he was considered by his stern brethren as somewhat too fond and indulgent a parent. He had four small children, and among them a daughter who was blind, and whom he loved with peculiar tenderness. He could not, he said, bear even to let the wind blow on her; and now she must suffer cold and hunger; she must beg; she must be beaten; "yet," he added, "I must, I must do it."

His second wife, whom he had married just before his arrest, tried in vain for his release; she even petitioned the House of Lords on his behalf. While he lay in prison he could do nothing in the way of his old trade for the support of his family. He determined, therefore, to take up a new trade. He learned to make long-tagged thread laces; and many thousands of these articles were furnished by him to the hawkers. While his hands were thus busied he had other employments for his mind and his lips. He gave religious instruction to his fellow-captives, and formed from among them a little flock, of which he was himself the pastor. He studied indefatigably the few books which he possessed. His two chief companions were the Bible and Fox's *Book of Martyrs*. His knowledge of the Bible was such that he might have been called a living concordance; and on the margin of his copy of the *Book of Martyrs* are still legible the ill-spelt lines of doggerel in which he expressed his reverence for the brave sufferers, and his implacable enmity to the mystical Babylon.

Prison life gave him leisure to write, and during his first imprisonment he wrote, in addition to several tracts and some verse, *Grace Abounding to the Chief of Sinners*, the narrative of his own religious experience. The book was published in 1666. A short period of freedom was followed by a second offence and a further imprisonment. Bunyan's works were coarse, indeed, but they showed a keen mother wit, a great command of the homely mother tongue, an intimate knowledge of the English Bible, and a vast and dearly bought spiritual experience. They therefore, when the corrector of the press had improved the syntax and the spelling, were well received.

Much of Bunyan's time was spent in controversy. He wrote sharply against the Quakers, whom he seems always to have held in utter abhorrence. He wrote against the liturgy of the Church of England. No two things, according to him, had less affinity than the form of prayer and the spirit of prayer. Those, he said with much point, who have most of the spirit of prayer are all to be found in gaol; and those who have most zeal for the form of prayer are all to be found at the alehouse. The doctrinal Articles, on the other hand, he warmly praised and defended. The most acrimonious of all his works is his *Defence of Justification by Faith*, an answer to what Bunyan calls "the brutish and beastly latitudinarianism" of Edward Fowler, afterwards bishop of Gloucester, an excellent man, but not free from the taint of Pelagianism.

Bunyan had also a dispute with some of the chiefs of the sect to which he belonged. He doubtless held with perfect sincerity

² He was not, however, as has often been stated, confined in the old gaol which stood on the bridge over the Ouse, but in the county gaol.

the distinguishing tenet of that sect, but he did not consider that tenet as one of high importance, and willingly joined in communion with pious Presbyterians and Independents. The sterner Baptists, therefore, loudly pronounced him a false brother. A controversy arose which long survived the original combatants. The cause which Bunyan had defended with rude logic and rhetoric against Kiffin and Danvers has since been pleaded by Robert Hall with an ingenuity and eloquence such as no polemical writer has ever surpassed.

During the years which immediately followed the Restoration, Bunyan's confinement seems to have been strict. But as the passions of 1660 cooled, as the hatred with which the Puritans had been regarded while their reign was recent gave place to pity, he was less and less harshly treated. The distress of his family, and his own patience, courage and piety, softened the hearts of his judges. Like his own Christian in the cage, he found protectors even among the crowd at Vanity Fair. The bishop of the diocese, Dr Barlow, is said to have interceded for him. At length the prisoner was suffered to pass most of his time beyond the walls of the gaol, on condition, as it should seem, that he remained within the town of Bedford.

He owed his complete liberation to one of the worst acts of one of the worst governments that England has ever seen. In 1671 the Cabal was in power. Charles II. had concluded the treaty by which he bound himself to set up the Roman Catholic religion in England. The first step which he took towards that end was to annul, by an unconstitutional exercise of his prerogative, all the penal statutes against the Roman Catholics; and in order to disguise his real design, he annulled at the same time the penal statutes against Protestant nonconformists. Bunyan was consequently set at large.¹ In the first warmth of his gratitude he published a tract, in which he compared Charles to that humane and generous Persian king, who, though not himself blest with the light of the true religion, favoured the chosen people, and permitted them, after years of captivity, to rebuild their beloved temple.

Before he left his prison he had begun the book which has made his name immortal.² The history of that book is remarkable. The author was, as he tells us, writing a treatise, in which he had occasion to speak of the stages of the Christian progress. He compared that progress, as many others had compared it, to a pilgrimage. Soon his quick wit discovered innumerable points of similarity which had escaped his predecessors. Images came crowding on his mind faster than he could put them into words, quagmires and pits, steep hills, dark and horrible glens, soft vales, sunny pastures, a gloomy castle, of which the courtyard was strewn with the skulls and bones of murdered prisoners, a town all bustle and splendour, like London on the Lord Mayor's Day, and the narrow path, straight as a rule could make it, running on up hill and down hill, through city and through wilderness, to the Black River and the Shining Gate. He had found out, as most people would have said, by accident, as he would doubtless have said, by the guidance of Providence, where his powers lay. He had no suspicion, indeed, that he was producing a masterpiece. He could not guess what place his allegory would occupy in English literature; for of English literature he knew nothing. Those who suppose him to have studied the *Faery Queen* might easily be confuted, if this were the proper place for a detailed examination of the passages in which the two allegories have been thought to resemble each other. The only work of fiction, in all probability, with which he could compare his *Pilgrim* was his old favourite, the legend of Sir Bevis of Southampton. He would have thought it a sin to borrow any time from the serious business of his life, from his expositions,

his controversies and his lace tags, for the purpose of amusing himself with what he considered merely as a trifle. It was only, he assures us, at spare moments that he returned to the House Beautiful, the Delectable Mountains and the Enchanted Ground. He had no assistance. Nobody but himself saw a line till the whole was complete. He then consulted his pious friends. Some were pleased. Others were much scandalized. It was a vain story, a mere romance, about giants, and lions, and goblins, and warriors, sometimes fighting with monsters, and sometimes regaled by fair ladies in stately palaces. The loose atheistical wits at Will's might write such stuff to divert the painted Jezebels of the court; but did it become a minister of the gospel to copy the evil fashions of the world? There had been a time when the cant of such fools would have made Bunyan miserable. But that time was past; and his mind was now in a firm and healthy state. He saw that in employing fiction to make truth clear and goodness attractive, he was only following the example which every Christian ought to propose to himself; and he determined to print.

The *Pilgrim's Progress* was published in February 1678. Soon the irresistible charm of a book which gratified the imagination of the reader with all the action and scenery of a fairy tale, which exercised his ingenuity by setting him to discover a multitude of curious analogies, which interested his feelings for human beings, frail like himself, and struggling with temptations from within and from without, which every moment drew a smile from him by some stroke of quaint yet simple pleasantry, and nevertheless left on his mind a sentiment of reverence for God and of sympathy for man, began to produce its effect. In puritanical circles, from which plays and novels were strictly excluded, that effect was such as no work of genius, though it were superior to the *Iliad*, to *Don Quixote* or to *Othello*, can ever produce on a mind accustomed to indulge in literary luxury. A second edition came out in the autumn with additions; and the demand became immense. The eighth edition, which contains the last improvements made by the author, was published in 1682, the ninth in 1684, the tenth in 1685. The help of the engraver had early been called in; and tens of thousands of children looked with terror and delight on execrable copperplates, which represented Christian thrusting his sword into Apollyon, or writhing in the grasp of Giant Despair. In Scotland, and in some of the colonies, the *Pilgrim* was even more popular than in his native country. Bunyan has told us, with very pardonable vanity, that in New England his dream was the daily subject of the conversation of thousands, and was thought worthy to appear in the most superb binding. He had numerous admirers in Holland, and amongst the Huguenots of France.

He continued to work the gold-field which he had discovered, and to draw from it new treasures, not indeed with quite such ease and in quite such abundance as when the precious soil was still virgin, but yet with success, which left all competition far behind. In 1680 appeared the *Life and Death of Mr Badman*; in 1684 the second part of the *Pilgrim's Progress*. In 1682 appeared the *Holy War*, which if the *Pilgrim's Progress* did not exist, would be the best allegory that ever was written.

Bunyan's place in society was now very different from what it had been. There had been a time when many dissenting ministers, who could talk Latin and read Greek, had affected to treat him with scorn. But his fame and influence now far exceeded theirs. He had so great an authority among the Baptists that he was popularly called Bishop Bunyan. His episcopal visitations were annual. From Bedford he rode every year to London, and preached there to large and attentive congregations. From London he went his circuit through the country, animating the zeal of his brethren, collecting and distributing alms and making up quarrels. The magistrates seem in general to have given him little trouble. But there is reason to believe that, in the year 1685, he was in some danger of again occupying his old quarters in Bedford gaol. In that year the rash and wicked enterprise of Monmouth gave the government a pretext for prosecuting the nonconformists; and scarcely one eminent divine of the Presbyterian, Independent

¹ His formal pardon is dated the 13th of September 1672; but five months earlier he had received a royal licence to preach, and acted for the next three years as pastor of the nonconformist body to which he belonged, in a barn on the site of which stands the present Bunyan Meeting.

² It is now generally supposed that Bunyan wrote his *Pilgrim's Progress*, not during his twelve years' imprisonment, but during a short period of incarceration in 1675, probably in the old gaol on the bridge.

or Baptist persuasion remained unmolested. Baxter was in prison: Howe was driven into exile: Henry was arrested. Two eminent Baptists, with whom Bunyan had been engaged in controversy, were in great peril and distress. Danvers was in danger of being hanged; and Kiffin's grandsons were actually hanged. The tradition is that, during those evil days, Bunyan was forced to disguise himself as a wagoner, and that he preached to his congregation at Bedford in a smock-frock, with a cart-whip in his hand. But soon a great change took place. James II. was at open war with the church, and found it necessary to court the dissenters. Some of the creatures of the government tried to secure the aid of Bunyan. They probably knew that he had written in praise of the indulgence of 1672, and therefore hoped that he might be equally pleased with the indulgence of 1687. But fifteen years of thought, observation and commerce with the world had made him wiser. Nor were the cases exactly parallel. Charles was a professed Protestant; James was a professed Papist. The object of Charles's indulgence was disguised; the object of James's indulgence was patent. Bunyan was not deceived. He exhorted his hearers to prepare themselves by fasting and prayer for the danger which menaced their civil and religious liberties, and refused even to speak to the courtier who came down to remodel the corporation of Bedford, and who, as was supposed, had it in charge to offer some municipal dignity to the bishop of the Baptists.

Bunyan did not live to see the Revolution.¹ In the summer of 1688 he undertook to plead the cause of a son with an angry father, and at length prevailed on the old man not to disinheritor the young one. This good work cost the benevolent intercessor his life. He had to ride through heavy rain. He came drenched to his lodgings on Snow Hill, was seized with a violent fever, and died in a few days (August 31). He was buried in Bunhill Fields; and many Puritans, to whom the respect paid by Roman Catholics to the reliques and tombs of saints seemed childish or sinful, are said to have begged with their dying breath that their coffins might be placed as near as possible to the coffin of the author of the *Pilgrim's Progress*.

The fame of Bunyan during his life, and during the century which followed his death, was indeed great, but was almost entirely confined to religious families of the middle and lower classes. Very seldom was he during that time mentioned with respect by any writer of great literary eminence. Young coupled his prose with the poetry of the wretched D'Urfey. In the *Spiritual Quixote*, the adventures of Christian are ranked with those of Jack the Giant-Killer and John Hickathrift. Cowper ventured to praise the great allegorist, but did not venture to name him. It is a significant circumstance that, for a long time all the numerous editions of the *Pilgrim's Progress* were evidently meant for the cottage and the servants' hall. The paper, the printing, the plates, were all of the meanest description. In general, when the educated minority and the common people differ about the merit of a book, the opinion of the educated minority finally prevails. The *Pilgrim's Progress* is perhaps the only book about which the educated minority has come over to the opinion of the common people.

The attempts which have been made to improve and to imitate this book are not to be numbered. It has been done into verse; it has been done into modern English. The Pilgrimage of Tender Conscience, the Pilgrimage of Good Intent, the Pilgrimage of Seek Truth, the Pilgrimage of Theophilus, the Infant Pilgrim, the Hindoo Pilgrim, are among the many feeble copies of the great original. But the peculiar glory of Bunyan is that those who most hated his doctrines have tried to borrow the help of his genius. A Catholic version of his parable may be seen with the head of the virgin in the title-page. On the other hand, those Antinomians for whom his Calvinism is not strong enough, may study the Pilgrimage of Hephzibah, in which

¹ He had resumed his pastorate in Bedford after his imprisonment of 1675, and, although he frequently preached in London to crowded congregations, and is said in the last year of his life to have been, of course unofficially, chaplain to Sir John Shorter, lord mayor of London, he remained faithful to his own congregation.

nothing will be found which can be construed into an admission of free agency and universal redemption. But the most extraordinary of all the acts of Vandalism by which a fine work of art was ever defaced was committed in the year 1853. It was determined to transform the *Pilgrim's Progress* into a Tractarian book. The task was not easy; for it was necessary to make two sacraments the most prominent objects in the allegory, and of all Christian theologians, avowed Quakers excepted, Bunyan was the one in whose system the sacraments held the least prominent place. However, the Wicket Gate became a type of baptism, and the House Beautiful of the eucharist. The effect of this change is such as assuredly the ingenious person who made it never contemplated. For, as not a single pilgrim passes through the Wicket Gate in infancy, and as Faithful hurries past the House Beautiful without stopping, the lesson which the fable in its altered shape teaches, is that none but adults ought to be baptized, and that the eucharist may safely be neglected. Nobody would have discovered from the original *Pilgrim's Progress* that the author was not a Paedobaptist. To turn his book into a book against Paedobaptism, was an achievement reserved for an Anglo-Catholic divine. Such blunders must necessarily be committed by every man who mutilates parts of a great work, without taking a comprehensive view of the whole. (M.)

The above article has been slightly corrected as to facts, as compared with its form in the 9th edition. Bunyan's works were first partially collected in a folio volume (1692) by his friend Charles Doe. A larger edition (2 vols., 1736-1737) was edited by Samuel Wilson of the Barbican. In 1853 a good edition (3 vols., Glasgow) was produced by George Offor. Southey's edition (1830) of the *Pilgrim's Progress* contained his *Life* of Bunyan. Since then various editions of the *Pilgrim's Progress*, many illustrated (by Cruikshank, Byan Shaw, W. Strang and others), have appeared. An interesting life by "the author of *Mark Rutherford*" (W. Hale White) was published in 1904. Other lives are by J. A. Froude (1880) in the "English Men of Letters" series, and E. Venables (1888); but the standard work on the subject is *John Bunyan; his Life, Times and Work* (1885), by the Rev. J. Brown of Bedford. A bronze statue, by Boehm, was presented to the town by the duke of Bedford in 1874.

BUNZLAU, a town of Germany, in Prussian Silesia, on the right bank of the Bober, 27 m. from Liegnitz on the Berlin-Breslau railway, which crosses the river by a great viaduct. Pop. (1900) 14,590. It has a handsome market square, an Evangelical and a Roman Catholic church, and monuments to the Russian field marshal Kutusov, who died here, and to the poet Martin Opitz von Boberfeld. The Bunzlau pottery is famous; woollen and linen cloth are manufactured, and there is a considerable trade in grain and cattle. Bunzlau (Boleslavia) received its name in the 12th century from Duke Boleslav, who separated it from the duchy of Glogau. Its importance was increased by numerous privileges and the possession of extensive mining works. It was frequently captured and recaptured in the wars of the 17th century, and in 1730 was completely destroyed by fire. On the 30th of August 1813 the French were here defeated on the retreat from the Katzbach by the Silesian army of the allies.

BUONAFEDE, APPIANO (1716-1793), Italian philosopher, was born at Comachio, in Ferrara, and died in Rome. He became professor of theology at Naples in 1740, and, entering the religious body of the Celestines, rose to be general of the order. His principal works, generally published under the assumed name of "Agatopisto Cromazione," are on the history of philosophy:—*Della Istoria e delle Indole di ogni Filosofia*, 7 vols., 1772 seq.; and *Della Restaurazione di ogni Filosofia ne' Secoli*, xvi., xvii., xviii., 3 vols., 1789 (German trans. by C. Heydenreich). The latter gives a valuable account of 16th-century Italian philosophy. His other works are *Istoria critica e filosofica del suicidio* (1761); *Delle conquiste celebri esaminate col naturale diritto delle genti* (1763); *Istoria critica del moderno diritto di natura e delle genti* (1789); and a few poems and philosophic comedies.

BUOY (15th century "boye"; through O. Fr. or Dutch, from Lat. *boia*, fetter; the word is now usually pronounced as "boy," and it has been spelt in that form; but Hakluyt's

Voyages spells it "bwoy," and this seems to indicate a different pronunciation, which is also given in some modern dictionaries), a floating body employed to mark the navigable limits of channels, their fairways, sunken dangers or isolated rocks, mined or torpedo grounds, telegraph cables, or the position of a ship's anchor after letting go; buoys are also used for securing a ship to instead of anchoring. They vary in size and construction from a log of wood to steel mooring buoys for battleships or a steel gas buoy.

In 1882 a conference was held upon a proposal to establish a uniform system of buoyage. It was under the presidency of the then duke of Edinburgh, and consisted of representatives from the various bodies interested. The questions of colour, visibility, shape and size were considered, and any modifications necessary owing to locality. The committee proposed the following uniform system of buoyage, and it is now adopted by the general lighthouse authorities of the United Kingdom:—

(1) The mariner when approaching the coast must determine

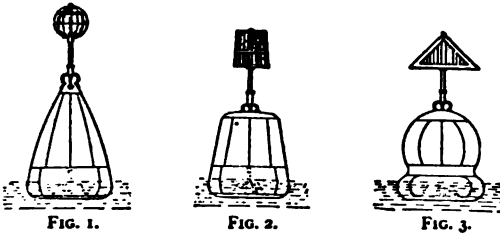

his position on the chart, and note the direction of flood tide. (2) The term "starboard-hand" shall denote that side which would be on the right hand of the mariner either going with the main stream of the flood, or entering a harbour, river or estuary from seaward; the term "port-hand" shall denote the left hand of the mariner in the same circumstances. (3)¹ Buoys showing the pointed top of a cone above water shall be called conical (fig. 1) and shall always be starboard-hand buoys, as above defined. (4)¹ Buoys showing a flat top above water shall be called can (fig. 2) and shall always be port-hand buoys, as above defined. (5) Buoys showing a domed top above water shall be called spherical (fig. 3) and shall mark the ends of middle grounds. (6) Buoys having a tall central structure on

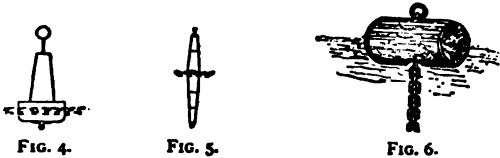

a broad face shall be called pillar buoys (fig. 4), and like all other special buoys, such as bell buoys, gas buoys, and automatic sounding buoys, shall be placed to mark special positions either on the coast or in the approaches to harbours. (7) Buoys showing only a mast above water shall be called spar-buoys² (fig. 5). (8) Starboard-hand buoys shall always be painted in one colour only. (9) Port-hand buoys shall be painted of another characteristic colour, either single or parti-colour. (10) Spherical buoys (fig. 3) at the ends of middle grounds shall always be distinguished by horizontal stripes of white colour. (11) Surmounting beacons, such as staff and globe and others,³ shall always be painted of one dark colour. (12) Staff and globe (fig. 1) shall only be used on starboard-hand

¹ In carrying out the above system the Northern Lights Commissioners have adopted a red colour for conical or starboard-hand buoys, and black colour for can or port-hand buoys, and this system is applicable to the whole of Scotland.

² Useful where floating ice is encountered.

³ St George and St Andrew crosses are principally employed to surmount shore beacons.

buoys, staff and cage (fig. 2) on port hand; diamonds (fig. 7) at the outer ends of middle grounds; and triangles (fig. 3) at the inner ends. (13) Buoys on the same side of a channel, estuary or tideway may be distinguished from each other by names, numbers or letters, and where necessary by a staff surmounted with the appropriate beacon. (14) Buoys intended for moorings (fig. 6) may be of shape and colour according to the discretion of the authority within whose jurisdiction they are laid, but for marking submarine telegraph cables the colour shall be green with the word "Telegraph" painted thereon in white letters.



FIG. 7.

Buoys and Marking of Wrecks.—(15) Wreck buoys in the open sea, or in the approaches to a harbour or estuary, shall be coloured green, with the word "Wreck" painted in white letters on them. (16) When possible, the buoy should be laid near to the side of the wreck next to mid-channel. (17) When a wreck-marking vessel is used, it shall, if possible, have its top sides coloured green, with the word "Wreck" in white letters thereon, and shall exhibit by day, three balls on a yard 20 ft. above the sea, two placed vertically at one end and one at the other, the single ball being on the side nearer to the wreck; in fog a gong or bell is rung in quick succession at intervals not exceeding one minute (wherever practicable); by night, three white fixed lights are similarly arranged as the balls in daytime, but the ordinary riding lights are not shown. (18) In narrow waters or in rivers and harbours under the jurisdiction of local authorities, the same rules may be adopted, or at discretion, varied as follows:—When a wreck-marking vessel is used she shall carry a cross-yard on a mast with two balls by day, placed horizontally not less than 6 nor more than 12 ft. apart, and by night two lights similarly placed. When a barge or open boat only is used, a flag or ball may be shown in the daytime. (19) The position in which the marking vessel is placed with reference to the wreck shall be at the discretion of the local authority having jurisdiction. A uniform system by shape has been adopted by the Mersey Dock and Harbour Board, to assist a mariner by night, and, in addition, where practicable, a uniform colour; the fairway buoys are specially marked by letter, shape and colour.

British India has practically adopted the British system, United States and Canada have the same uniform system; in the majority of European maritime countries and China various uniform systems have been adopted. In Norway and Russia the compass system is used, the shape, colour and surmountings of the buoys indicating the compass bearing of the danger from the buoy; this method is followed in the open sea by Sweden. An international uniform system of buoyage, although desirable, appears impracticable. Germany employs yellow buoys to mark boundaries of quarantine stations. The question of shape versus colour, irrespective of size, is a disputed one; the shape is a better guide at night and colour in the daytime. All markings (figs. 8, 9, 10 and 11) should be subordinate to the main colour of the buoy; the varying backgrounds and atmospheric conditions render the question a complex one.

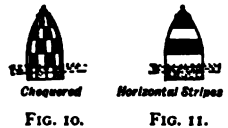
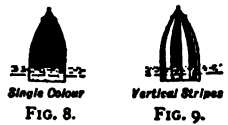

London Trinity House buoys are divided into five classes, their use depending on whether the spot to be marked is in the open sea or otherwise exposed position, or in a sheltered harbour, or according to the depth of water and weight of moorings, or the importance of the danger. Buoys are moored with specially tested cables; the eye at the base of the buoy is of wrought iron to prevent it becoming "reezy" and the cable is secured to blocks (see ANCHOR) or mushroom anchors according to the nature of the ground. London Trinity House buoys are

built of steel, with bulkheads to lessen the risk of their sinking by collision, and, with the exception of bell buoys, do not contain water ballast. In 1878 gas buoys, with fixed and occulting lights of 10-candle power, were introduced. In 1896 Mr T. Matthews, engineer-in-chief in the London Trinity Corporation, developed the present design (fig. 12). It is of steel, the lower plates being

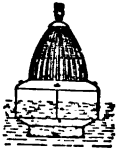

FIG. 12.

$\frac{1}{4}$ in. and the upper $\frac{1}{2}$ in. in thickness, thus adding to the stability. The buoy holds 380 cub. ft. of gas, and exhibits an occulting light for 2533 hours. This light is placed 10 ft. above the sea, and, with an intensity of 50 candles, is visible 8 m. It occults every ten seconds, and there is seven seconds' visibility, with three seconds' obscuration. The occultations are actuated by a double valve arrangement. In the body of the apparatus there is a gas chamber having sufficient capacity, in the case of an occulting light, for maintaining the flame in action for seven seconds, and by means of a by-pass a jet remains alight in the centre of the burner. During the period of three seconds' darkness the gas chamber is re-charged, and at the end of that period is again opened to the main burner by a tripping arrangement of the valve, and remains in action seven seconds. The gas chamber of the buoy, charged to five atmospheres, is replenished from a steamer fitted with a pump and transport receivers carrying indicating valves, the receivers being charged to ten atmospheres. Practically no inconvenience has resulted from saline or other deposits, the glazing (glass) of the lantern being thoroughly cleaned when re-charging the buoy. Acetylene, generated from calcium carbide inside the buoy, is also used. Electric light is exhibited from some buoys in the United States. In England an automatic electric buoy has been suggested, worked by the motion of the waves, which cause a stream of water to act on a turbine connected with a dynamo generating electricity. Boat-shaped buoys are also used (river Humber) for carrying a light and bell. The Courtenay whistling buoy

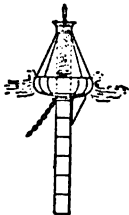

FIG. 13.

(fig. 13) is actuated by the undulating movement of the waves. A hollow cylinder extends from the lower part of the buoy to still water below the movement of the waves, ensuring that the water inside keeps at mean level, whilst the buoy follows the movements of the waves. By a special apparatus the compressed air is forced through the whistle at the top of the buoy, and the air is replenished by two tubes at the upper part of the buoy. It is fitted with a rudder and secured in the usual manner. Automatic buoys cannot be relied on in calm days with a smooth sea. The nun buoy (fig. 14) for indicating the position of an anchor after letting go, is secured to the crown of the anchor by a buoy rope. It is usually made of galvanized iron, and consists of two cones joined together at the base. It is painted red for the port anchor and green for the starboard.



FIG. 14.

Mooring buoys (fig. 6) for battleships are built of steel in four watertight compartments, and have sufficient buoyancy to keep afloat should a compartment be pierced; they are 13 ft. long with a diameter of $6\frac{1}{2}$ ft. The mooring cable (bridle) passes through a watertight 16-in. trunk pipe, built vertically in the centre of the buoy, and is secured to a "rocking shackle" on the upper surface of the buoy. Large mooring buoys are usually protected by horizontal wooden battens and are fitted with life chains. (J. W. D.)

BUPALUS AND ATHENIS, sons of Archermus, and members of the celebrated school of sculpture in marble which flourished in Chios in the 6th century B.C. They were contemporaries of the poet Hipponax (about 540 B.C.), whom they were said to have caricatured. Their works consisted almost entirely of draped

female figures, Artemis, Fortune, the Graces, whence the Chian school has been well called a school of Madonnas. Augustus brought many of the works of Bupalus and Athenis to Rome, and placed them on the gable of the temple of Apollo Palatinus.

BUPHONIA, in Greek antiquities, a sacrificial ceremony, forming part of the Diipolia, a religious festival held on the 14th of the month Skirophorion (June-July) at Athens, when a labouring ox was sacrificed to Zeus Polieus as protector of the city in accordance with a very ancient custom. The ox was driven forward to the altar, on which grain was spread, by members of the family of the Kentriadae (from *κέντρον*, a goad), on whom this duty devolved hereditarily. When it began to eat, one of the family of the Thaulonidae advanced with an axe, slew the ox, then immediately threw away the axe and fled. The axe, as being polluted by murder, was now carried before the court of the Prytaneum (which tried inanimate objects for homicide) and there charged with having caused the death of the ox, for which it was thrown into the sea. Apparently this is an early instance analogous to deodand (*q.v.*). Although the slaughter of a labouring ox was forbidden, it was considered excusable in the exceptional circumstances; none the less it was regarded as a murder.

Porphyrius, *De Abstinētia*, ii. 29; Aelian, *Var. Hist.* viii. 3. Schol. Aristoph. *Nubes*, 485; Pausanias, i. 24, 28; see also Baad, *De Diipoliorum Sacra Atheniensium* (1873).

BUR, or **BURR** (apparently the same word as Danish *borre*, burdock, cf. Swed. *kard-boore*), a prickly fruit or head of fruits, as of the burdock. In the sense of a woody outgrowth on the trunk of a tree, or "gnaur," the effect of a crowded bud-development, the word is probably adapted from the Fr. *bourre*, a vine-bud.

BURANO, a town of Venetia, in the province of Venice, on an island in the lagoons, 6 m. N.E. of Venice by sea. Pop. (1901) 8169. It is a fishing town, with a large royal school of lacemaking employing some 500 girls. It was founded, like all the towns in the lagoons, by fugitives from the mainland cities at the time of the barbarian invasions. Torcello is a part of the commune of Burano.

BURAJEN, a town of the province of Leyte, island of Leyte, Philippine Islands, on the Dagitan river, 21 m. S. by W. of Tacloban, the capital. Pop. (1903) 18,197. Burajen is situated in a rich hemp-growing region, and hemp is its only important product. The language is Visayan.

BURBAGE, JAMES (d. 1597), English actor, is said to have been born at Stratford-on-Avon. He was a member of the earl of Leicester's players, probably for several years before he is first mentioned (1574) as being at the head of the company. In 1576, having secured the lease of land at Shoreditch, Burbage erected there the successful house which was known for twenty years as *The Theatre* from the fact that it was the first ever erected in London. He seems also to have been concerned in the erection of a second theatre in the same locality, the Curtain, and later, in spite of all difficulties and a great deal of local opposition, he started what became the most celebrated home of the rising drama,—the Blackfriars theatre, built in 1596 near the old Dominican friary.

His son **RICHARD BURBAGE** (c. 1567-1619), more celebrated than his father, was the Garrick of the Elizabethan stage, and acted all the great parts in Shakespeare's plays. He, too, is said to have been born at Stratford-on-Avon, and made his first appearance at an early age at one of his father's theatres. He had established a reputation by the time he was twenty, and in the next dozen years was the most popular English actor, the "Roscius" of his day. At the time of his father's death, a lawsuit was in progress against the lessor from whom James Burbage held the land on which *The Theatre* stood. This suit was continued by Richard and his brother Cuthbert, and in 1579 they pulled down the Shoreditch house and used the materials to erect the Globe theatre, famous for its connexion with Shakespeare. They occupied it as a summer playhouse, retaining the Blackfriars, which was roofed in, for winter performances. In this venture Richard Burbage had Shakespeare and others

as his partners, and it was in one or the other of these houses that he gained his greatest triumphs, taking the leading part in almost every new play. He was specially famous for his impersonation of Richard III. and other Shakespearian characters, and it was in tragedy that he especially excelled. Every playwright of his day endeavoured to secure his services. He died on the 13th of March 1619. Richard Burbage was a painter as well as an actor. The Felton portrait of Shakespeare is attributed to him, and there is a portrait of a woman, undoubtedly by him, preserved at Dulwich College.

BURBOT, or **EEL-POUR** (*Lota vulgaris*), a fish of the family Gadidae, which differs from the ling and anal fins reaching the caudal, and in the small size of all the teeth. It exceeds a length of 3 ft. and is a freshwater fish, although examples are exceptionally taken in British estuaries and in the Baltic; some specimens are handsomely marbled with dark brown, with black blotches on the back and dorsal fins. It is very locally distributed in central and northern Europe, and an uncommon fish in England. Its flesh is excellent. The American burbot (*Lota maculosa*) is coarser, and not favoured for the table.

BURCKHARDT, JAKOB (1818-1897), Swiss writer on art, was born at Basel on the 25th of May 1818; he was educated there and at Neuchâtel, and till 1839 was intended to be a pastor. In 1838 he made his first journey to Italy, and also published his first important articles *Bemerkungen über schweizerische Kathedralen*. In 1839 he went to the university of Berlin, where he studied till 1843, spending part of 1841 at Bonn, where he was a pupil of Franz Kugler, the art historian, to whom his first book, *Die Kunstwerke d. belgischen Skulptur* (1842), was dedicated. He was professor of history at the university of Basel (1845-1847, 1849-1855 and 1858-1893) and at the federal polytechnic school at Zürich (1855-1858). In 1847 he brought out new editions of Kugler's two great works, *Geschichte der Malerei und Kunstgeschichte*, and in 1853 published his own work, *Die Zeit Constantins des Grossen*. He spent the greater part of the years 1853-1854 in Italy, where he collected the materials for one of his most famous works, *Der Cicerone: eine Anleitung zum Genuss der Kunstwerke Italiens*, which was dedicated to Kugler and appeared in 1855 (7th German edition, 1890; English translation of the sections relating to paintings, by Mrs A. H. Clough, London, 1873). This work, which includes sculpture and architecture, as well as painting, has become indispensable to the art traveller in Italy. About half of the original edition was devoted to the art of the Renaissance, so that Burckhardt was naturally led on to the preparation of his two other celebrated works, *Die Cultur der Renaissance in Italien* (1860, 5th German edition 1896, and English translation, by S. G. C. Middlemore, in 2 vols., London, 1878), and the *Geschichte der Renaissance in Italien* (1867, 3rd German edition 1897). In 1867 he refused a professorship at Tübingen, and in 1872 another (that left vacant by Ranke) at Berlin, remaining faithful to Basel. He died in 1897.

See Life by Hans Trog in the *Basler Jahrbuch* for 1898, pp. 1-172. (W. A. B. C.)

BURCKHARDT, JOHN LEWIS [JOHANN LUDWIG] (1784-1817), Swiss traveller and orientalist, was born at Lausanne on the 24th of November 1784. After studying at Leipzig and Göttingen he visited England in the summer of 1806, carrying a letter of introduction from the naturalist Blumenbach to Sir Joseph Banks, who, with the other members of the African Association, accepted his offer to explore the interior of Africa. After studying in London and Cambridge, and inuring himself to all kinds of hardships and privations, Burckhardt left England in March 1809 for Malta, whence he proceeded, in the following autumn, to Aleppo. In order to obtain a better knowledge of oriental life he disguised himself as a Mussulman, and took the name of Sheikh Ibrahim Ibn Abdallah. After two years passed in the Levant he had thoroughly mastered Arabic, and had acquired such accurate knowledge of the Koran, and of the commentaries upon its religion and laws, that after a critical examination the most learned Mussulmans entertained no doubt of his being really what he professed to be, a learned doctor

of their law. During his residence in Syria he visited Palmyra, Damascus, Lebanon and thence journeyed via Petra to Cairo with the intention of joining a caravan to Fezzan, and of exploring from there the sources of the Niger. In 1812, whilst waiting for the departure of the caravan, he travelled up the Nile as far as Dar Mahass; and then, finding it impossible to penetrate westward, he made a journey through the Nubian desert in the character of a poor Syrian merchant, passing by Berber and Shendi to Suakin, on the Red Sea, whence he performed the pilgrimage to Mecca by way of Jidda. At Mecca he stayed three months and afterwards visited Medina. After enduring privations and sufferings of the severest kind, he returned to Cairo in June 1815 in a state of great exhaustion; but in the spring of 1816 he travelled to Mount Sinai, whence he returned to Cairo in June, and there again made preparations for his intended journey to Fezzan. Several hindrances prevented his prosecuting this intention, and finally, in April 1817, when the long-expected caravan prepared to depart, he was seized with illness and died on the 15th of October. He had from time to time carefully transmitted to England his journals and notes, and a very copious series of letters, so that nothing which appeared to him to be interesting in the various journeys he made has been lost. He bequeathed his collection of 800 vols. of oriental MSS. to the library of Cambridge University.

His works were published by the African Association in the following order:—*Travels in Nubia* (to which is prefixed a biographical memoir) (1819); *Travels in Syria and the Holy Land* (1822); *Travels in Arabia* (1829); *Arabic Proverbs, or the Manners and Customs of the Modern Egyptians* (1830); *Notes on the Bedouins and Wahabys* (1831).

BURDEAU, AUGUSTE LAURENT (1851-1894), French politician, was the son of a labourer at Lyons. Forced from childhood to earn his own living, he was enabled to secure an education by bursarships at the Lycée at Lyons and at the Lycée Louis Le Grand in Paris. In 1870 he was at the École Normale Supérieure in Paris, but enlisted in the army, and was wounded and made prisoner in 1871. In 1874 he became professor of philosophy, and translated several works of Herbert Spencer and of Schopenhauer into French. His extraordinary aptitude for work secured for him the position of *chef de cabinet* under Paul Bert, the minister of education, in 1881. In 1885 he was elected deputy for the department of the Rhone, and distinguished himself in financial questions. He was several times minister, and became minister of finance in the cabinet of Casimir-Périer (from the 3rd of November 1893 to the 22nd of May 1894). On the 5th of July 1894 he was elected president of the chamber of deputies. He died on the 12th of December 1894, worn out with overwork.

BURDEN, or **BURTHEN**. (1) (A.S. *byrthen*, from *beran*, to bear), a load, both literally and figuratively; especially the carrying capacity of a ship; in mining and smelting, the tops or heads of stream-work which lie over the stream of tin, and the proportion of ore and flux to fuel in the charge of a blast-furnace. In Scots and English law the term is applied to an encumbrance on real or personal property. (2) (From the Fr. *bourdon*, a droning, humming sound) an accompaniment to a song, or the refrain of a song; hence a chief or recurrent topic, as "the burden of a speech."

BURDER, GEORGE (1752-1832), English Nonconformist divine, was born in London on the 5th of June 1752. In early manhood he was an engraver, but in 1776 he began preaching, and was minister of the Independent church at Lancaster from 1778 to 1783. Subsequently he held charges at Coventry (1784-1803) and at Fetter Lane, London (1803-1832). He was one of the founders of the British and Foreign Bible Society, the Religious Tract Society, and the London Missionary Society, and was secretary to the last-named for several years. As editor of the *Evangelical Magazine* and author of *Village Sermons*, he commanded a wide influence. He died on the 29th of May 1832, and a Life (by H. Burder) appeared in 1833.

BURDETT, SIR FRANCIS (1770-1844), English politician, was the son of Francis Burdett by his wife Eleanor, daughter of William Jones of Ramsbury manor, Wiltshire, and grandson of

Sir Robert Burdett, Bart. Born on the 25th of January 1770, he was educated at Westminster school and Oxford, and afterwards travelled in France and Switzerland. He was in Paris during the earlier days of the French Revolution, a visit which doubtless influenced his political opinions. Returning to England he married in 1793 Sophia, daughter of Thomas Coutts the banker, and this lady brought him a large fortune. In 1796 he became member of parliament for Boroughbridge, having purchased this seat from the representatives of the 4th duke of Newcastle, and in 1797 succeeded his grandfather as fifth baronet. In parliament he soon became prominent as an opponent of Pitt, and as an advocate of popular rights. He denounced the war with France, the suspension of the Habeas Corpus Act, the proposed exclusion of John Horne Tooke from parliament, and quickly became the idol of the people. He was instrumental in securing an inquiry into the condition of Coldbath Fields prison, but as a result of this step he was for a time prevented by the government from visiting any prison in the kingdom. In 1797 he made the acquaintance of Horne Tooke, whose pupil he became, not only in politics, but also in philology. At the general election of 1802 Burdett was a candidate for the county of Middlesex, but his return was declared void in 1804, and in the subsequent contest he was defeated. In 1805 this return was amended in his favour, but as this was again quickly reversed, Burdett, who had spent an immense sum of money over the affair, declared he would not stand for parliament again.

At the general election of 1806 Burdett was a leading supporter of James Paull, the reform candidate for the city of Westminster; but in the following year a misunderstanding led to a duel between Burdett and Paull in which both combatants were wounded. At the general election in 1807 Burdett, in spite of his reluctance, was nominated for Westminster, and amid great enthusiasm was returned at the top of the poll. He took up again the congenial work of attacking abuses and agitating for reform, and in 1810 came sharply into collision with the House of Commons. A radical named John Gale Jones had been committed to prison by the House, a proceeding which was denounced by Burdett, who questioned the power of the House to take this step, and vainly attempted to secure the release of Jones. He then issued a revised edition of his speech on this occasion, and it was published by William Cobbett in the *Weekly Register*. The House voted this action a breach of privilege, and the speaker issued a warrant for Burdett's arrest. Barring himself in his house, he defied the authorities, while the mob gathered in his defence. At length his house was entered, and under an escort of soldiers he was conveyed to the Tower. Released when parliament was prorogued, he caused his supporters much disappointment by returning to Westminster by water, and so avoiding a demonstration in his honour. He then brought actions against the speaker and the serjeant-at-arms, but the courts upheld the action of the House. In parliament Burdett denounced corporal punishment in the army, and supported all attempts to check corruption, but his principal efforts were directed towards procuring a reform of parliament, and the removal of Roman Catholic disabilities. In 1809 he had proposed a scheme of parliamentary reform, and returning to the subject in 1817 and 1818 he anticipated the Chartist movement by suggesting universal male suffrage, equal electoral districts, vote by ballot, and annual parliaments; but his motions met with very little support. He succeeded, however, in carrying a resolution in 1825 that the House should consider the laws concerning Roman Catholics. This was followed by a bill embodying his proposals, which passed the Commons but was rejected by the Lords. In 1827 and 1828 he again proposed resolutions on this subject, and saw his proposals become law in 1829. In 1820 Burdett had again come into serious conflict with the government. Having severely censured its action with reference to the "Manchester massacre," he was prosecuted at Leicester assizes, fined £1000, and committed to prison for three months. After the passing of the Reform Bill in 1832 the ardour of the veteran reformer was somewhat abated, and a number of his constituents soon took umbrage at his changed attitude.

Consequently he resigned his seat early in 1827, but was re-elected. However, at the general election in the same year he forsook Westminster and was elected member for North Wiltshire, which seat he retained, acting in general with the Conservatives, until his death on the 23rd of January 1844. He left a son, Robert, who succeeded to the baronetcy, and five daughters, the youngest of whom became the celebrated Baroness Burdett-Coutts. Impetuous and illogical, Burdett did good work as an advocate of free speech, and an enemy of corruption. He was exceedingly generous, and spent money lavishly in furthering projects of reform.

See A. Stephens, *Life of Horne Tooke* (London, 1813); Spencer Walpole, *History of England* (London, 1878-1886); C. Abbot, Baron Colchester, *Diary and Correspondence* (London, 1861). (A. W. H.)

BURDETT-COUTTS, ANGELA GEORGINA BURDETT-COUTTS, BARONESS (1814-1906), English philanthropist, youngest daughter of Sir Francis Burdett, was born on the 21st of April 1814. When she was three-and-twenty, she inherited practically the whole of the immense wealth of her grandfather Thomas Coutts (approaching two millions sterling, a fabulous sum in those days), by the will of the duchess of St Albans, who, as the actress Henrietta Mellon, had been his second wife and had been left it on his death in 1821. Miss Burdett then took the name of Coutts in addition to her own. "The faynale heiress, Miss Anjaley Coutts," as the author of the *Ingoldby Legends* called her in his ballad on the queen's coronation in that year (1837), at once became a notable subject of public curiosity and private cupidity; she received numerous offers of marriage, but remained resolutely single, devoting herself and her riches to philanthropic work, which made her famous for well-applied generosity. In May 1871 she was created a peeress, as Baroness Burdett-Coutts of Highgate and Brookfield, Middlesex. On the 18th of July 1872 she was presented at the Guildhall with the freedom of the city of London, the first case of a woman being admitted to that fellowship. It was not till 1881 that, when sixty-seven years old, she married William Lehman Ashmead-Bartlett, an American by birth, and brother of Sir E. A. Ashmead-Bartlett, the Conservative member of parliament; and he then took his wife's name, entering the House of Commons as member for Westminster, 1885. Full of good works, and of social interest and influence, the baroness lived to the great age of ninety-two, dying at her house in Stratton Street, Piccadilly, on the 30th of December 1906, of bronchitis. She was buried in Westminster Abbey.

The extent of her benefactions during her long and active life can only be briefly indicated; but the baroness must remain a striking figure in the social history of Victorian England, for the thoughtful and conscientious care with which she "held her wealth in trust" for innumerable good objects. It was her aim to benefit the working-classes in ways involving no loss of independence or self-respect. She carefully avoided taking any side in party politics, but she was actively interested in phases of Imperial extension which were calculated to improve the condition of the black races, as in Africa, or the education and relief of the poor or suffering in any part of the world. Though she made no special distinction of creed in her charities, she was a notable benefactor of the Church of England, building and endowing churches and church schools, endowing the bishoprics of Cape Town and of Adelaide (1847), and founding the bishopric of British Columbia (1857). Among her many educational endowments may be specified the St Stephen's Institute in Vincent Square, Westminster (1846); she started sewing schools in Spitalfields when the silk trade began to fail; helped to found the shoe-black brigade; and placed hundreds of destitute boys in training-ships for the navy and merchant service. She established Columbia fish market (1869) in Bethnal Green, and presented it to the city, but owing to commercial difficulties this effort, which cost her over £200,000, proved abortive. She supported various schemes of emigration to the colonies; and in Ireland helped to promote the fishing industry by starting schools, and providing boats, besides

advancing £250,000 in 1880 for supplying seed to the impoverished tenants. She was devoted to the protection of animals and prevention of cruelty, and took up with characteristic zeal the cause of the costermongers' donkeys, building stables for them on her Columbia market estate, and giving prizes for the best-kept animals. She helped to inaugurate the society for the prevention of cruelty to children, and was a keen supporter of the ragged school union. Missionary efforts of all sorts; hospitals and nursing; industrial homes and refuges; relief funds, &c., found in her a generous supporter. She was associated with Louisa Twining and Florence Nightingale; and in 1877-1878 raised the Turkish compassionate fund for the starving peasantry and fugitives in the Russo-Turkish War (for which she obtained the order of the Medjidieh, a solitary case of its conferral on a woman). She relieved the distressed in far-off lands as well as at home, her helping hand being stretched out to the Dyaks of Borneo and the aborigines of Australia. She was a liberal patroness of the stage, literature and the arts, and delighted in knowing all the cultured people of the day. In short, her position in England for half a century may well be summed up in words attributed to King Edward VII., "after my mother (Queen Victoria) the most remarkable woman in the kingdom."

BURDON-SANDERSON, SIR JOHN SCOTT, Bart. (1828-1905), English physiologist, was born at West Jesmond, near Newcastle, on the 21st of December 1828. A member of a well-known Northumbrian family, he received his medical education at the university of Edinburgh and at Paris. Settling in London, he became medical officer of health for Paddington in 1856 and four years later physician to the Middlesex and the Brompton Consumption hospitals. When diphtheria appeared in England in 1858 he was sent to investigate the disease at the different points of outbreak, and in subsequent years he carried out a number of similar inquiries, e.g. into the cattle plague and into cholera in 1866. He became first principal of the Brown Institution at Lambeth in 1871, and in 1874 was appointed Jodrell professor of physiology at University College, London, retaining that post till 1882. When the Waynflete chair of physiology was established at Oxford in 1882, he was chosen to be its first occupant, and immediately found himself the object of a furious anti-vivisectionist agitation. The proposal that the university should spend £10,000 in providing him with a suitable laboratory, lecture-rooms, &c., in which to carry on his work, was strongly opposed, by some on grounds of economy, but largely because he was an upholder of the usefulness and necessity of experiments upon animals. It was, however, eventually carried by a small majority (88 to 85), and in the same year the Royal Society awarded him a royal medal in recognition of his researches into the electrical phenomena exhibited by plants and the relations of minute organisms to disease, and of the services he had rendered to physiology and pathology. In 1885 the university of Oxford was asked to vote £500 a year for three years for the purposes of the laboratory, then approaching completion. This proposal was fought with the utmost bitterness by Sanderson's opponents, the anti-vivisectionists including E. A. Freeman, John Ruskin and Bishop Mackarness of Oxford. Ultimately the money was granted by 412 to 244 votes. In 1895 Sanderson was appointed regius professor of medicine at Oxford, resigning the post in 1904; in 1899 he was created a baronet. His attainments, both in biology and medicine, brought him many honours. He was Croonian lecturer to the Royal Society in 1867 and 1877 and to the Royal College of Physicians in 1891; gave the Harveian oration before the College of Physicians in 1878; acted as president of the British Association at Nottingham in 1893; and served on three royal commissions—Hospitals (1883), Tuberculosis, Meat and Milk (1890), and University for London (1892). He died at Oxford on the 23rd of November 1905.

BURDWAN, or BARDWAN, a town of British India, in Bengal, which gives its name to a district and to a division. It has a station on the East Indian railway, 67 m. N.W. from Calcutta. Pop. (1901) 35,022. The town consists really of numerous villages scattered over an area of 9 sq. m., and is entirely rural

in character. It contains several interesting ancient tombs, and at Nawab Hat, some 2 m. distant, is a group of 108 Siva *lingam* temples built in 1788. The place was formerly very unhealthy, but this has been to a large extent remedied by the establishment of water-works, a good supply of water being derived from the river Banka. Within the town, the principal objects of interest are the palaces and gardens of the maharaja. The chief educational institution is the Burdwan Raj college, which is entirely supported out of the maharaja's estate.

The town owes its importance entirely to being the headquarters of the maharaja of Burdwan, the premier nobleman of lower Bengal, whose rent-roll is upwards of £300,000. The *raj* was founded in 1657 by Abu Ra Kapur, of the Kapur Khatri family of Kotli in Lahore, Punjab, whose descendants served in turn the Mogul emperors and the British government. The great prosperity of the *raj* was due to the excellent management of Maharaja Mahtab Chand (d. 1879), whose loyalty to the government—especially during the Santal rebellion of 1855 and the mutiny of 1857—was rewarded with the grant of a coat of arms in 1868 and the right to a personal salute of 13 guns in 1877. Maharaja Bijai Chand Mahtab (b. 1881), who succeeded his adoptive father in 1888, earned great distinction by the courage with which he risked his life to save that of Sir Andrew Fraser, the lieutenant-governor of Bengal, on the occasion of the attempt to assassinate him made by Bengali malcontents on the 7th of November 1908.

The DISTRICT OF BURDWAN lies along the right bank of the river Bhagirathi or Hugli. It has an area of 2689 sq. m. It is a flat plain, and its scenery is uninteresting. Chief rivers are the Bhagirathi, Damodar, Ajai, Banka, Kunur and Khari, of which only the Bhagirathi is navigable by country cargo boats throughout the year. The district was acquired by the East India Company under the treaty with Nawab Mir Kasim in 1760, and confirmed by the emperor Shah Alam in 1765. The land revenue was fixed in perpetuity with the zamindar in 1793. In 1901 the population was 1,532,475, showing an increase of 10% in the decade. There are several indigo factories. The district suffered from drought in 1896-1897. The Eden Canal, 20 m. long, has been constructed for irrigation. The weaving of silk is the chief native industry. As regards European industries, Burdwan takes the first place in Bengal. It contains the great coal-field of Raniganj, first opened in 1874, with an output of more than three million tons. The Barrakar ironworks produce pig-iron, which is reported to be as good as that of Middlesbrough. Apart from Burdwan town and Raniganj, the chief places are the river-marts of Katwa and Kalna. The East Indian-railway has several lines running through the district.

The DIVISION OF BURDWAN comprises the six districts of Burdwan, Birbhum, Bankura, Midnapore, Hugli and Howrah, with a total area of 13,949 sq. m., and a population in 1901 of 8,240,076.

BUREAU (a Fr. word from *buret* or *bureau*, a coarse cloth used for coverings), a writing-table or desk (q.v.), also in America a low chest of drawers. From the meaning of "desk," the word is applied to an office or place of business, and particularly a government department; in the United States the term is used of certain subdivisions of the executive departments, as the bureau of statistics, a division of the treasury department. The term "bureaucracy" is often employed to signify the concentration of administrative power in bureaux or departments, and the undue interference by officials not only in the details of government, but in matters outside the scope of state interference. The word is also frequently used in the sense of "red-tapism."

BURFORD, a market town in the Woodstock parliamentary division of Oxfordshire, England, 18 m. W.N.W. of Oxford. Pop. (1901) 1146. It is pleasantly situated in the valley of the Windrush, the broad, picturesque main street sloping upward from the stream, beside which stands the fine church, to the summit of the ridge flanking the valley on the south, along which runs the high road from Oxford. The church of St John the Baptist has a nave and aisles, mainly Perpendicular in appearance owing to alterations in that period, but actually of

earlier construction, the south aisle flanked by two beautiful chapels and an ornate porch; transepts and a central tower, and choir with flanking chapels. The massive Norman tower contrasts strongly with the delicate Perpendicular spire rising upon it. The church contains many interesting memorials, and, in the nave, a Perpendicular shrine dedicated to St Peter. Near the church is the half-ruined priory house, built in the 17th century, and containing much fine plaster ornament characteristic of the period; a curious chapel adjoins it. William Lenthall, speaker of the Long Parliament, was granted this mansion, died here in 1662, and is buried in the church. In the High Street nearly every house is of some antiquity. The Tolsey or old town hall is noteworthy among them; and under one of the houses is an Early English crypt. Burford is mentioned as the scene of a synod in 705; in 752 Cuthred, king of the West Saxons, fighting for independence, here defeated Æthelbald, king of Mercia; and in 1649 the town and district were the scene of victorious operations by Cromwell.

BURG, a town of Germany, in Prussian Saxony, on the river Ille, and the railway from Berlin to Magdeburg, 14 m. N.E. of the latter. Pop. (1900) 22,432. It is noted for its cloth manufactures and boot-making, which afford employment to a great part of its population. The town belonged originally to the lordship of Querfurt, passed with this into the possession of the archbishops of Magdeburg in 1496, and was ceded in 1635 with other portions of the Magdeburg territories to Saxony; in 1687 it was ceded to Brandenburg. It owes its prosperity to the large influx of industrious French, Palatinate and Walloon refugees, which took place about the end of the 17th century.

BURGAGE (from Lat. *Burgus*, a borough), a form of tenure, both in England and Scotland, applicable to the property connected with the old municipal corporations and their privileges. In England, it was a tenure whereby houses or tenements in an ancient borough were held of the king or other person as lord at a certain rent. The term is of less practical importance in the English than in the Scottish system, where it held an important place in the practice of conveyancing, real property having been generally divided into feudal-holding and burgage-holding. Since the Conveyancing (Scotland) Act 1874, there is, however, not much distinction between burgage tenure and free holding. It is usual to speak of the English burgage-tenure as a relic of Saxon freedom resisting the shock of the Norman conquest and its feudalism, but it is perhaps more correct to consider it a local feature of that general exemption from feudality enjoyed by the *municipia* as a relic of their ancient Roman constitution. The reason for the system preserving for so long its specifically distinct form in Scottish conveyancing was because burgage-holding was an exception to the system of subinfeudation which remained prevalent in Scotland when it was suppressed in England. While other vassals might hold of a graduated hierarchy of overlords up to the crown, the burgess always held directly of the sovereign. It is curious that while in England the burgage-tenure was deemed a species of socage, to distinguish it from the military holdings, in Scotland it was strictly a military holding, by the service of watching and warding for the defence of the burgh. In England the franchises enjoyed by burgesses, freemen and other consuetudinary constituencies in burghs, were dependent on the character of the burgage-tenure. Tenure by burgage was subject to a variety of customs, the principal of which was Borough-English (*q.v.*).

See Pollock and Maitland, *History of English Law* (1898).

BURGAS (sometimes written *Burghas*, *Bourgas* or *Borgas*, and, in the middle ages, *Pyrgos*), a seaport, and capital of the department of Burgas, in Bulgaria (Eastern Rumelia), on the gulf of Burgas, an inlet of the Black Sea, in 42° 27' N. and 27° 35' E. Pop. (1906) 12,846. Burgas is built on a low foreland, between the lagoons of Ludzha, on the north, and Kara-Yunus, on the west; it faces towards the open sea on the east, and towards its own harbour on the south. The principal approach is a broad isthmus on the north-west, along which runs the railway to Philippopolis and Adrianople. Despite its small population and the rivalry of Varna and the Turkish port of

Dedeagatch, Burgas has a considerable transit trade. Its fine harbour, formally opened in 1904, has an average depth of five fathoms; large vessels can load at the quays, and the outer waters of the gulf are well lit by lighthouses on the islets of Hagios Anastasios and Megalo-Nisi. In 1904, the port accommodated over 1400 ships, of about 700,000 tons. These included upwards of 800 Bulgarian and Turkish sailing-vessels, engaged in the coasting trade. Fuel, machinery and miscellaneous goods are imported, chiefly from Austria-Hungary, Belgium, Germany and the United Kingdom; the exports include grain, wool, tallow, cheese, butter, attar of roses, &c. Pottery and pipes are manufactured from clay obtained in the neighbourhood.

BURGDORF (Fr. *Berthold*), an industrial town in the Swiss canton of Bern. It is built on the left bank of the Emme and is 14 m. by rail N.E. of Bern. The lower (or modern) town is connected by a curious spiral street with the upper (or old) town. The latter is picturesquely perched on a hill, at a height of 1947 ft. above sea-level (or 167 ft. above the river); it is crowned by the ancient castle and by the 15th-century parish church, in the former of which Pestalozzi set up his educational establishment between 1798 and 1804. A large trade is carried on at Burgdorf in the cheese of the Emmenthal, while among the industrial establishments are railway works, and factories of cloth, white lead and tin-foil. In 1900 the population was 804, practically all Protestants and German-speaking. A fine view of the Bernese Alps is obtained from the castle, while a still finer one may be enjoyed from the Lueg hill (2917 ft.), north-east of the town. The castle dates from the days of the dukes of Züringen (11th-12th centuries), the last of whom (Berchtold V.) built walls round the town at its foot, and granted it a charter of liberties. On the extinction (1218) of that dynasty both castle and town passed to the counts of Kyburg, and from them, with the rest of their possessions, in 1272 by marriage to the cadet line of the Habsburgs. By that line they were sold in 1344, with Thun, to the town of Bern, whose bailiffs ruled in the castle till 1798. (W. A. B. C.)

BURGER (of unknown origin), a small three-cornered or swallow-tailed flag or pennant used by yachts or merchant vessels; also a kind of small coal burnt in engine furnaces.

BÜRGER, GOTTFRIED AUGUST (1748-1794), German poet, was born on the 1st of January 1748 at Molmerswenke near Halberstadt, of which village his father was the Lutheran pastor. He was a backward child, and at the age of twelve was practically adopted by his maternal grandfather, Bauer, at Aschersleben, who sent him to the *Pädagogium* at Halle. Hence in 1764 he passed to the university, as a student of theology, which, however, he soon abandoned for the study of jurisprudence. Here he fell under the influence of C. A. Klotz (1738-1771), who directed Bürger's attention to literature, but encouraged rather than discouraged his natural disposition to a wild and unregulated life. In consequence of his dissipated habits, he was in 1767 recalled by his grandfather, but on promising to reform was in 1768 allowed to enter the university of Göttingen as a law student. As he continued his wild career, however, his grandfather withdrew his support and he was left to his own devices. Meanwhile he had made fair progress with his legal studies, and had the good fortune to form a close friendship with a number of young men of literary tastes. In the Göttingen *Musenalmannach*, edited by H. Boie and F. W. Gotter, Bürger's first poems were published, and by 1771 he had already become widely known as a poet. In 1772, through Boie's influence, Bürger obtained the post of "Amstmann" or district magistrate at Altengleichen near Göttingen. His grandfather was now reconciled to him, paid his debts and established him in his new sphere of activity. Meanwhile he kept in touch with his Göttingen friends, and when the "Göttinger Band" or "Hain" was formed, Bürger, though not himself a member, kept in close touch with it. In 1773 the ballad *Lenore* was published in the *Musenalmannach*. This poem, which in dramatic force and in its vivid realization of the weird and supernatural remains without a rival, made his name a household word in Germany. In 1774 Bürger married Dorette Leonhart, the

daughter of a Hanoverian official; but his passion for his wife's younger sister Auguste (the "Molly" of his poems and elegies) rendered the union unhappy and unsettled his life. In 1778 Bürger became editor of the *Musensalmanach*, and in the same year published the first collection of his poems. In 1780 he took a farm at Appenrode, but in three years lost so much money that he had to abandon the venture. Pecuniary troubles oppressed him, and being accused of neglecting his official duties, and feeling his honour attacked, he gave up his official position and removed in 1784 to Göttingen, where he established himself as *Privat-docent*. Shortly before his removal thither his wife died (30th of July 1784), and on the 29th of June in the next year he married his sister-in-law "Molly." Her death on the 9th of January 1786 affected him deeply. He appeared to lose at once all courage and all bodily and mental vigour. He still continued to teach in Göttingen; at the jubilee of the foundation of the university in 1787 he was made an honorary doctor of philosophy, and in 1789 was appointed extraordinary professor in that faculty, though without a stipend. In the following year he married a third time, his wife being a certain Elise Hahn, who, enchanted with his poems, had offered him her heart and hand. Only a few weeks of married life with his "Schwabenmädchen" sufficed to prove his mistake, and after two and a half years he divorced her. Deeply wounded by Schiller's criticism, in the 14th and 15th part of the *Allgemeine Literaturzeitung* of 1791, of the 2nd edition of his poems, disappointed, wrecked in fortune and health, Bürger eked out a precarious existence as a teacher in Göttingen until his death there on the 8th of June 1794.

Bürger's character, in spite of his utter want of moral balance, was not lacking in noble and lovable qualities. He was honest in purpose, generous to a fault, tender-hearted and modest. His talent for popular poetry was very considerable, and his ballads are among the finest in the German language. Besides *Lenore*, *Das Lied vom braven Manne*, *Die Kuh*, *Der Kaiser und der Abt* and *Der wilde Jäger* are famous. Among his purely lyrical poems, but few have earned a lasting reputation; but mention may be made of *Das Blümchen Wunderhold*, *Lied an den lieben Mond*, and a few love songs. His sonnets, particularly the elegies, are of great beauty.

Editions of Bürger's *Sämmtliche Schriften* appeared at Göttingen, 1817 (incomplete); 1829-1833 (8 vols.), and 1835 (one vol.): also a selection by E. Griebach (5th ed., 1804). The *Gedächtnis* have been published in innumerable editions, the best being that by A. Sauer (2 vols., 1884). *Briefe von und an Bürger* were edited by A. Strödtmann in 4 vols. (1874). On Bürger's life see the biography by H. Prühle (1856), the introduction to Sauer's edition of the poems, and W. von Wurzbach, *G. A. Bürger* (1900).

BURGERS, THOMAS FRANÇOIS (1834-1881), president of the Transvaal Republic, was born in Cape Colony on the 15th of April 1834, and was educated at Utrecht, Holland, where he took the degree of doctor of theology. On his return to South Africa he was ordained minister of the Dutch Reformed Church, and stationed at Hanover in Cape Colony, where he exercised his ministrations for eight years. In 1862 his preaching attracted attention, and two years later an ecclesiastical tribunal suspended him for heretical opinions. He appealed, however, to the colonial government, which had appointed him, and obtained judgment in his favour, which was confirmed by the privy council of England on appeal in 1865. On the resignation of M. W. Pretorius and the refusal of President Brand of the Orange Free State to accept the office, Burgers was elected president of the Transvaal, taking the oath on the 1st of July 1872. In 1873 he endeavoured to persuade Montsioa to agree to an alteration in the boundary of the Barolong territory as fixed by the Keate award, but failed (see BECHUANALAND). In 1875 Burgers, leaving the Transvaal in charge of Acting-President Joubert, went to Europe mainly to promote a scheme for linking the Transvaal to the coast by a railway from Delagoa Bay, which was that year definitely assigned to Portugal by the MacMahon award. With the Portuguese Burgers concluded a treaty, December 1875, providing for the construction of the railway. After meeting with refusals of financial help in London,

Burgers managed to raise £50,000 in Holland, and bought a quantity of railway plant, which on its arrival at Delagoa Bay was mortgaged to pay freight, and this, so far as Burgers was concerned, was the end of the matter. In June 1876 he induced the raad to declare war against Sikukuni (Secocoeni), a powerful native chief in the eastern Transvaal. The campaign was unsuccessful, and with its failure the republic fell into a condition of lawlessness and insolvency, while a Zulu host threatened invasion. Burgers in an address to the raad (3rd of March 1877) declared "I would rather be a policeman under a strong government than the president of such a state. It is you—you members of the raad and the Boers—who have lost the country, who have sold your independence for a drink." Sir Theophilus Shepstone, who had been sent to investigate the condition of affairs in the Transvaal, issued on the 12th of April a proclamation annexing the Transvaal to Great Britain. Burgers fully acquiesced in the necessity for annexation. He accepted a pension from the British government, and settled down to farming in Hanover, Cape Colony. He died at Richmond in that colony on the 9th of December 1881, and in the following year a volume of short stories, *Tooneelen uit ons dorp*, originally written by him for the Cape *Volksblad*, was published at the Hague for the benefit of his family. A patriot, a fluent speaker both in Dutch and in English, and possessed of unbounded energy, the failure of Burgers was due to his fondness for large visionary plans, which he attempted to carry out with insufficient means (see TRANSVAAL: *History*).

For the annexation episode see John Martineau, *The Life of Sir Bartle Frere*, vol. ii. chap. xviii. (London 1895).

BURGERSDYK, or BURGERSDICIUS, FRANCIS (1590-1629), Dutch logician, was born at Lier, near Delft, and died at Leiden. After a brilliant career at the university of Leiden, he studied theology at Saumur, where while still very young he became professor of philosophy. After five years he returned to Leiden, where he accepted the chair of logic and moral philosophy, and afterwards that of natural philosophy. His *Logic* was at one time widely used, and is still valuable. He wrote also *Idea Philosophiæ Moralis* (1644).

BURGES, GEORGE (1786-1864), English classical scholar, was born in India. He was educated at Charterhouse school and Trinity College, Cambridge, taking his degree in 1807, and obtaining one of the members' prizes both in 1808 and 1809. He stayed up at Cambridge and became a most successful "coach." He had a great reputation as a Greek scholar, and was a somewhat acrimonious critic of rival scholars, especially Bishop Blomfield. Subsequently he fell into embarrassed circumstances through injudicious speculation, and in 1841 a civil list pension of £100 per annum was bestowed upon him. He died at Ramsgate, on the 11th of January 1864. Burges was a man of great learning and industry, but too fond of introducing arbitrary emendations into the text of classical authors. His chief works are: Euripides' *Troades* (1807) and *Phoenissæ* (1809); Aeschylus' *Supplikes* (1821), *Eumenides* (1822) and *Prometheus* (1831); Sophocles' *Philocetes* (1833); E. F. Poppo's *Prolegomena to Thucydides* (1837), an abridged translation with critical remarks; *Hermesianactis Fragments* (1839). He also edited some of the dialogues of Plato with English notes, and translated nearly the whole of that author and the Greek anthology for Bohn's Classical Library. He was a frequent contributor to the *Classical Journal* and other periodicals, and dedicated to Byron a play called *The Son of Erin, or, The Cause of the Greeks* (1823).

BURGESS, DANIEL (1645-1713), English Presbyterian divine, was born at Staines, in Middlesex, where his father was minister. He was educated under Busby at Westminster school, and in 1660 was sent to Magdalen Hall, Oxford, but not being able conscientiously to subscribe the necessary formulæ he quitted the university without taking his degree. In 1667, after taking orders, he was appointed by Roger Boyle, first Lord Orrery, to the headmastership of a school recently established by that nobleman at Charleville, Co. Cork, and soon after he became private chaplain to Lady Mervin, near Dublin. There he was

ordained by the local presbytery, and on returning to England was imprisoned for preaching at Marlborough. He soon regained his liberty, and went to London, where he speedily gathered a large and influential congregation, as much by the somewhat excessive fervour of his piety as by the vivacious illustrations which he frequently employed in his sermons. He was a master of epigram, and theologically inclined to Calvinism. The Sacheverell mob gutted his chapel in 1710, but the government repaired the building. Besides preaching, he gave instruction to private pupils, of whom the most distinguished was Henry St John, afterwards Lord Bolingbroke. His son, Daniel Burgess (d. 1747), was secretary to the princess of Wales, and in 1723 obtained a *regium donum* or government grant of £500 half-yearly for dissenting ministers.

BURGESS, THOMAS (1756-1837), English divine, was born at Odiham, in Hampshire. He was educated at Winchester, and at Corpus Christi College, Oxford. Before graduating, he edited a reprint of John Burton's *Pentateuologia*. In 1781 he brought out an annotated edition of Richard Dawes's *Miscellanea Critica* (reprinted, Leipzig, 1800). In 1783 he became a fellow of his college, and in 1785 was appointed chaplain to Shute Barrington, bishop of Salisbury, through whose influence he obtained a prebendal stall, which he held till 1803. In 1788 he published his *Considerations on the Abolition of Slavery*, in which he advocated the principle of gradual emancipation. In 1791 he accompanied Barrington to Durham, where he did evangelistic work among the poorer classes. In 1803 he was appointed to the vacant bishopric of St David's, which he held for twenty years with great success. He founded the Society for Promoting Christian Knowledge in the diocese, and also St David's College at Lampeter, which he liberally endowed. In 1820 he was appointed first president of the recently founded Royal Society of Literature; and three years later he was promoted to the see of Salisbury, over which he presided for twelve years, prosecuting his benevolent designs with unwearied industry. As at St David's, so at Salisbury, he founded a Church Union Society for the assistance of infirm and distressed clergymen. He strenuously opposed both Unitarianism and Catholic emancipation. He died on the 10th of February 1837.

A list of his works, which are very numerous, will be found in his biography by J. S. Harford (2nd ed., 1841). In addition to those already referred to may be mentioned his *Essay on the Study of Antiquities*, *The First Principles of Christian Knowledge*; *Reflections on the Controversial Writings of Dr Priestley*, *Emendationes in Suidam et Herychium et alios Lexicographos Græcos*; *The Bible, and nothing but the Bible, the Religion of the Church of England*.

BURGESS (Med. Lat. *burgensis*, from *burgus*, a borough, a town), a term, in its earliest sense, meaning an inhabitant of a borough, one who occupied a tenement therein, but now applied solely to a registered parliamentary, or more strictly, municipal voter. An early use of the word was to denote a member elected to parliament by his fellow citizens in a borough. In some of the American colonies (e.g. Virginia), a "burgess" was a member of the legislative body, which was termed the "House of Burgesses." Previously to the Municipal Reform Act 1835, burgess was an official title in some English boroughs, and in this sense is still used in some of the states of the United States, as in Connecticut, New Jersey, Pennsylvania. The *Burgess-roll* is the register or official list of burgesses in a borough.

BURGH (**BOURKE**, **BURKE**), the name of an historic Irish house, associated with Connaught for more than seven centuries. It was founded by William de Burgh, brother of Hubert de Burgh (q.v.). Before the death of Henry II. (1189) he received a grant of lands from John as lord of Ireland. At John's accession (1199) he was installed in Thomond and was governor of Limerick. In 1199-1201 he was supporting in turn Cathal Carrach and Cathal Croderg for the native throne, but he was expelled from Limerick in 1203, and, losing his Connaught, though not his Munster estates, died in 1205. His son Richard, in 1227, received the land of "Connok" [Connaught], as forfeited by its king, whom he helped to fight. From 1228 to 1232 he held the high office of justiciar of Ireland. In 1234 he aided with the crown against Richard, earl marshal, who fell in battle

against him. Dying in 1243, he was succeeded as lord of Connaught by his son Richard, and then (1248) by his younger son Walter, who carried on the family warfare against the native chieftains, and added greatly to his vast domains by obtaining (c. 1255) from Prince Edward a grant of "the county of Ulster," in consequence of which he was styled later earl of Ulster. At his death in 1271, he was succeeded by his son Richard as 2nd earl. In 1286 Richard ravaged and subdued Connaught, and deposed Bryan O'Neill as chief native king, substituting a nominee of his own. The native king of Connaught was also attacked by him, in favour of that branch of the O'Connors whom his own family supported. He led his forces from Ireland to support Edward I. in his Scottish campaigns, and on Edward Bruce's invasion of Ulster in 1315 Richard marched against him, but he had given his daughter Elizabeth in marriage to Robert Bruce, afterwards king of Scotland, about 1304. Occasionally summoned to English parliaments, he spent most of his forty years of activity in Ireland, where he was the greatest noble of his day, usually fighting the natives or his Anglo-Norman rivals. The patent roll of 1290 shows that in addition to his lands in Ulster, Connaught and Munster, he had held the Isle of Man, but had surrendered it to the king.

His grandson and successor William, the 3rd earl (1326-1333), was the son of John de Burgh by Elizabeth, lady of Clare, sister and co-heir of the last Clare earl of Hertford (d. 1314). He married a daughter of Henry, earl of Lancaster, and was appointed lieutenant of Ireland in 1331, but was murdered in his 21st year, leaving a daughter, the sole heiress, not only of the de Burgh possessions, but of vast Clare estates. She was married in childhood to Lionel, son of Edward III., who was recognized in her right as earl of Ulster, and their direct representative, the duke of York, ascended the throne in 1461 as Edward IV., since when the earldom of Ulster has been only held by members of the royal family.

On the murder of the 3rd earl (1333), his male kinsmen, who had a better right, by native Irish ideas, to the succession than his daughter, adopted Irish names and customs, and becoming virtually native chieftains succeeded in holding the bulk of the de Burgh territories. Their two main branches were those of "MacWilliam Eighter" in southern Connaught, and "MacWilliam Oughter" to the north of them, in what is now Mayo. The former held the territory of Clanricarde, lying in the neighbourhood of Galway, and in 1543 their chief, as Ulick "Bourck, alias Makwilliam," surrendered it to Henry VIII., receiving it back to hold, by English custom, as earl of Clanricarde and Lord Dunkellin. The 4th earl (1601-1635) distinguished himself on the English side in O'Neill's rebellion and afterwards, and obtained the English earldom of St Albans in 1628, his son Ulick receiving further the Irish marquessate of Clanricarde (1646). His cousin and heir, the 6th earl (1657-1666) was uncle of the 8th and 9th earls (1687-1722), both of whom fought for James II. and paid the penalty for doing so in 1691, but the 9th earl was restored in 1702, and his great-grandson, the 12th earl, was created marquess of Clanricarde in 1789. He left no son, but the marquessate was again revived in 1825, for his nephew the 14th earl, whose heir is the present marquess. The family, which changed its name from Bourke to de Burgh in 1752, and added that of Canning in 1862, still own a vast estate in County Galway.

In 1603 "the MacWilliam Oughter," Theobald Bourke, similarly resigned his territory in Mayo, and received it back to hold by English tenure. In 1627 he was created Viscount Mayo. The 2nd and 3rd viscounts (1629-1663) suffered at Cromwell's hands, but the 4th was restored to his estates (some 50,000 acres) in 1666. The peerage became extinct or dormant on the death of the 8th viscount in 1767. In 1781 John Bourke, a Mayo man, believed to be descended from the line of "MacWilliam Oughter," was created Viscount Mayo, and four years later earl of Mayo, a peerage still extant. In 1872 the 6th earl was murdered in the Andaman Islands when viceroy of India.

The baronies of Bourke of Connell (1580) and Bourke of Brittas (1618), both forfeited in 1691, were bestowed on branches

of the family which has also still representatives in the baronetage and landed gentry of Ireland.

The lords Burgh or Borough of Gainsborough (1487-1599) were a Lincolnshire family believed to be descended from a younger son of Hubert de Burgh. The 5th baron was lord deputy of Ireland in 1597, and his younger brother, Sir John (d. 1594), a distinguished soldier and sailor. (J. H. R.)

BURGH, HUBERT DE (d. 1243), chief justiciar of England in the reign of John and Henry III., entered the royal service in the reign of Richard I. He traced his descent from Robert of Mortain, half brother of the Conqueror and first earl of Cornwall; he married about 1200 the daughter of William de Vernon, earl of Devon; and thus, from the beginning of his career, he stood within the circle of the great ruling families. But he owed his high advancement to exceptional ability as an administrator and a soldier. Already in 1201 he was chamberlain to King John, the sheriff of three shires, the constable of Dover and Windsor castles, the warden of the Cinque Ports and of the Welsh Marches. He served with John in the continental wars which led up to the loss of Normandy. It was to his keeping that the king first entrusted the captive Arthur of Brittany. Coggeshall is our authority for the tale, which Shakespeare has immortalized, of Hubert's refusal to permit the mutilation of his prisoner; but Hubert's loyalty was not shaken by the crime to which Arthur subsequently fell a victim. In 1204 Hubert distinguished himself by a long and obstinate defence of Chinon, at a time when nearly the whole of Poitou had passed into French hands. In 1213 he was appointed seneschal of Poitou, with a view to the invasion of France which ended disastrously for John in the next year.

Both before and after the issue of the Great Charter Hubert adhered loyally to the king; he was rewarded, in June 1215, with the office of chief justiciar. This office he retained after the death of John and the election of William, the earl marshal, as regent. But, until the expulsion of the French from England, Hubert was entirely engaged with military affairs. He held Dover successfully through the darkest hour of John's fortunes; he brought back Kent to the allegiance of Henry III.; he completed the discomfiture of the French and their allies by the naval victory which he gained over Eustace the Monk, the noted privateer and admiral of Louis, in the Straits of Dover (Aug. 1217). The inferiority of the English fleet has been much exaggerated, for the greater part of the French vessels were transports carrying reinforcements and supplies. But Hubert owed his success to the skill with which he manoeuvred for the weather-gage, and his victory was not less brilliant than momentous. It compelled Louis to accept the treaty of Lambeth, under which he renounced his claims to the crown and evacuated England. As the saviour of the national cause the justiciar naturally assumed after the death of William Marshal (1219) the leadership of the English loyalists. He was opposed by the legate Pandulf (1218-1221), who claimed the guardianship of the kingdom for the Holy See; by the Poitevin Peter des Roches, bishop of Winchester, who was the young king's tutor; by the foreign mercenaries of John, among whom Falkes de Bréauté took the lead; and by the feudal party under the earls of Chester and Albemarle. On Pandulf's departure the pope was induced to promise that no other legate should be appointed in the lifetime of Archbishop Stephen Langton. Other opponents were weakened by the audacious stroke of 1223, when the justiciar suddenly announced the resumption of all the castles, sheriffdoms and other grants which had been made since the king's accession. A plausible excuse was found in the next year for issuing a sentence of confiscation and banishment against Falkes de Bréauté. Finally in 1227, Hubert having proclaimed the king of age, dismissed the bishop of Winchester from his tutorship.

Hubert now stood at the height of his power. His possessions had been enlarged by four successive marriages, particularly by that which he contracted in 1221 with Margaret, the sister of Alexander II. of Scotland; in 1227 he received the earldom of Kent, which had been dormant since the disgrace of Odo of Bayeux. But the favour of Henry III. was a precarious founda-

tion on which to build. The king chafed against the objections with which his minister opposed wild plans of foreign conquest and inconsiderate concessions to the papacy. They quarrelled violently in 1229, at Portsmouth, when the king was with difficulty prevented from stabbing Hubert, because a sufficient supply of ships was not forthcoming for an expedition to France. In 1231 Henry lent an ear to those who asserted that the justiciar had secretly encouraged armed attacks upon the aliens to whom the pope had given English benefices. Hubert was suddenly disgraced and required to render an account of his long administration. The blow fell suddenly, a few weeks after his appointment as justiciar of Ireland. It was precipitated by one of those fits of passion to which the king was prone; but the influence of Hubert had been for some time waning before that of Peter des Roches and his nephew Peter des Rivaux. Some colour was given to their attacks by Hubert's injudicious plea that he held a charter from King John which exempted him from any liability to produce accounts. But the other charges, far less plausible than that of embezzlement, which were heaped upon the head of the fallen favourite, are evidence of an intention to crush him at all costs. He was dragged from the sanctuary at Bury St Edmunds, in which he had taken refuge, and was kept in strait confinement until Richard of Cornwall, the king's brother, and three other earls offered to be his sureties. Under their protection he remained in honourable detention at Devizes Castle. On the outbreak of Richard Marshal's rebellion (1233), he was carried off by the rebels to the Marshal stronghold of Striguil, in the hope that his name would add popularity to their cause. In 1234 he was admitted, along with the other supporters of the fallen Marshal, to the benefit of a full pardon. He regained his earldom and held it till his death, although he was once in serious danger from the varice of the king (1239), who was tempted by Hubert's enormous wealth to revive the charge of treason.

In his lifetime Hubert was a popular hero; Matthew Paris relates how, at the time of his disgrace, a common smith refused with an oath to put fetters on the man "who restored England to the English." Hubert's ambition of founding a great family was not realized. His earldom died with him, though he left two sons. In constitutional history he is remembered as the last of the great justiciars. The office, as having become too great for a subject, was now shorn of its most important powers and became politically insignificant.

See Roger of Wendover's *Flores Historiarum*, edited for the English Historical Society by H. O. Coxe (4 vols., 1841-1844); the *Chronica Majora* of Matthew Paris, edited by H. R. Luard for the Rolls Series (7 vols., 1873-1883); the *Histoire des ducs de Normandie*, edited by F. Michel for the Soc. de l'Hist. de France (Paris, 1840); the *Histoire de Guillaume le Maréchal*, edited by Paul Meyer for the same society (3 vols., Paris, 1891, &c.); J. E. Doyle's *Official Baronage of England*, ii. pp. 271-274; R. Pauli's *Geschichte von England*, vol. iii.; W. Stubbs's *Constitutional History of England*, vol. ii. (H. W. C. D.)

BURGHESH, HENRY (1292-1340), English bishop and chancellor, was a younger son of Robert, Baron Burghersh (d. 1305), and a nephew of Bartholomew, Lord Badlesmere, and was educated in France. In 1320 owing to Badlesmere's influence Pope John XXII. appointed him bishop of Lincoln in spite of the fact that the chapter had already made an election to the vacant bishopric, and he secured the position without delay. After the execution of Badlesmere in 1322 Burghersh's lands were seized by Edward II., and the pope was urged to deprive him; about 1326, however, his possessions were restored, a proceeding which did not prevent him from joining Edward's queen, Isabella, and taking part in the movement which led to the deposition and murder of the king. Enjoying the favour of the new king, Edward III., the bishop became chancellor of England in 1328; but he failed to secure the archbishopric of Canterbury which became vacant about the same time, and was deprived of his office of chancellor and imprisoned when Isabella lost her power in 1330. But he was soon released and again in a position of influence. He was treasurer of England from 1334 to 1337, and high in the favour and often in the company of Edward III.; he was sent on several important

errands, and entrusted with important commissions. He died at Ghent on the 4th of December 1340.

The bishop's brother, Bartholomew Burghersh (d. 1355), became Baron Burghersh on the death of his brother Stephen in 1310. He acted as assistant to Badlesmere until the execution of the latter; and then, trusted by Edward III., was constable of Dover Castle and warden of the Cinque Ports. He filled other important positions, served Edward III. both as a diplomatist and a soldier, being present at the battle of Crecy in 1346; and retaining to the last the royal confidence, died in August 1355. His son and successor, Bartholomew (d. 1369), was one of the first knights of the order of the Garter, and earned a great reputation as a soldier, specially distinguishing himself at the battle of Poitiers in 1356.

BURGHLEY, WILLIAM CECIL, BARON (1521-1598), was born, according to his own statement, on the 13th of September 1521 at the house of his mother's father at Bourne, Lincolnshire. Pedigrees, elaborated by Cecil himself with the help of Camden, the antiquary, associated him with the Cecils or Sitsyllts of Altyrennes in Herefordshire, and traced his descent from an Owen of the time of King Harold and a Sitsyllt of the reign of Rufus. The connexion with the Herefordshire family is not so impossible as the descent from Sitsyllt; but the earliest authentic ancestor of the lord treasurer is his grandfather, David, who, according to Burghley's enemies, "kept the best inn" in Stamford. David somehow secured the favour of Henry VII., to whom he seems to have been yeoman of the guard. He was serjeant-at-arms to Henry VIII. in 1526, sheriff of Northamptonshire in 1532, and a justice of the peace for Rutland. His eldest son, Richard, yeoman of the wardrobe (d. 1554), married Jane, daughter of William Heckington of Bourne, and was father of three daughters and Lord Burghley.

William, the only son, was put to school first at Grantham and then at Stamford. In May 1535, at the age of fourteen, he went up to St John's College, Cambridge, where he was brought into contact with the foremost educationists of the time, Roger Ascham and John Cheke, and acquired an unusual knowledge of Greek. He also acquired the affections of Cheke's sister, Mary, and was in 1541 removed by his father to Gray's Inn, without, after six years' residence at Cambridge, having taken a degree. The precaution proved useless, and four months later Cecil committed one of the rare rash acts of his life in marrying Mary Cheke. The only child of this marriage, Thomas, the future earl of Exeter, was born in May 1542, and in February 1543 Cecil's first wife died. Three years later he married (21st of December 1546) Mildred, daughter of Sir Anthony Cooke, who was ranked by Ascham with Lady Jane Grey as one of the two most learned ladies in the kingdom, and whose sister, Anne, became the wife of Sir Nicholas, and the mother of Sir Francis, Bacon.

Cecil, meanwhile, had obtained the reversion to the office of *custos rotulorum brevium*, and, according to his autobiographical notes, sat in parliament in 1543; but his name does not occur in the imperfect parliamentary returns until 1547, when he was elected for the family borough of Stamford. Earlier in that year he had accompanied Protector Somerset on his Pinkie campaign, being one of the two "judges of the Marshalsea," *i.e.* in the courts-martial. The other was William Patten, who states that both he and Cecil began to write independent accounts of the campaign, and that Cecil generously communicated his notes for Patten's narrative, which has been reprinted more than once.

In 1548 he is described as the protector's master of requests, which apparently means that he was clerk or registrar of the court of requests which the protector, possibly at Latimer's instigation, illegally set up in Somerset House "to hear poor men's complaints." He also seems to have acted as private secretary to the protector, and was in some danger at the time of the protector's fall (October 1549). The lords opposed to Somerset ordered his detention on the 10th of October, and in November he was in the Tower. On the 25th of January 1550 he was bound over in recognizances to the value of a thousand marks. However, he soon ingratiated himself with Warwick, and on the 15th

of September 1550 he was sworn one of the king's two secretaries. He was knighted on the 11th of October 1551, on the eve of Somerset's second fall, and was congratulated on his success in escaping his benefactor's fate. In April he became chancellor of the order of the Garter. But service under Northumberland was no bed of roses, and in his diary Cecil recorded his release in the phrase *ex misero casu factus liber et mei juris*. His responsibility for Edward's illegal "devises" of the crown has been studiously minimized by Cecil himself and by his biographers. Years afterwards, he pretended that he had only signed the "devises" as a witness, but in his apology to Queen Mary he did not venture to allege so flimsy an excuse; he preferred to lay stress on the extent to which he succeeded in shifting the responsibility on to the shoulders of his brother-in-law, Sir John Cheke, and other friends, and on his intrigues to frustrate the queen to whom he had sworn allegiance. There is no doubt that he saw which way the wind was blowing, and disliked Northumberland's scheme; but he had not the courage to resist the duke to his face. As soon, however, as the duke had set out to meet Mary, Cecil became the most active intriguer against him, and to these efforts, of which he laid a full account before Queen Mary, he mainly owed his immunity. He had, moreover, had no part in the divorce of Catherine or in the humiliation of Mary in Henry's reign, and he made no scruple about conforming to the religious reaction. He went to mass, confessed, and out of sheer zeal and in no official capacity went to meet Cardinal Pole on his pious mission to England in December 1554, again accompanying him to Calais in May 1555. It was rumoured in December 1554 that Cecil would succeed Sir William Petre as secretary, an office which, with his chancellorship of the Garter, he had lost on Mary's accession. Probably the queen had more to do with the falsification of this rumour than Cecil, though he is said to have opposed in the parliament of 1555—in which he represented Lincolnshire—a bill for the confiscation of the estates of the Protestant refugees. But the story, even as told by his biographer (Peck, *Desiderata Curiosa*, i. 11), does not represent Cecil's conduct as having been very courageous; and it is more to his credit that he found no seat in the parliament of 1558, for which Mary had directed the return of "discreet and good Catholic members."

By that time Cecil had begun to trim his sails to a different breeze. He was in secret communication with Elizabeth before Mary died, and from the first the new queen relied on Cecil as she relied on no one else. Her confidence was not misplaced; Cecil was exactly the kind of minister England then required. Personal experience had ripened his rare natural gift for avoiding dangers. It was no time for brilliant initiative or adventurous politics; the need was to avoid Scylla and Charybdis, and a *sic modus* had to be found in church and state, at home and abroad. Cecil was not a political genius; no great ideas emanated from his brain. But he was eminently a safe man, not an original thinker, but a counsellor of unrivalled wisdom. Caution was his supreme characteristic; he saw that above all things England required time. Like Fabius, he restored the fortunes of his country by deliberation. He averted open rupture until England was strong enough to stand the shock. There was nothing heroic about Cecil or his policy; it involved a callous attitude towards struggling Protestants abroad. Huguenots and Dutch were aided just enough to keep them going in the struggles which warded danger off from England's shores. But Cecil never developed that passionate aversion from decided measures which became a second nature to his mistress. His intervention in Scotland in 1559-1560 showed that he could strike on occasion; and his action over the execution of Mary, queen of Scots, proved that he was willing to take responsibility from which Elizabeth shrank. Generally he was in favour of more decided intervention on behalf of continental Protestants than Elizabeth would admit, but it is not always easy to ascertain the advice he gave. He has left endless memoranda lucidly setting forth the pros and cons of every course of action; but there are few indications of the line which he actually recommended when it came to a decision. How far he was personally responsible for the Anglican Settlement, the Poor Laws, and the foreign policy of the reign, how far he was

thwarted by the baleful influence of Leicester and the caprices of the queen, remains to a large extent a matter of conjecture. His share in the settlement of 1559 was considerable, and it coincided fairly with his own somewhat indeterminate religious views. Like the mass of the nation, he grew more Protestant as time wore on; he was readier to persecute Papists than Puritans; he had no love for ecclesiastical jurisdiction, and he warmly re-monstrated with Whitgift over his persecuting Articles of 1583. The finest encomium was passed on him by the queen herself, when she said, "This judgment I have of you, that you will not be corrupted with any manner of gifts, and that you will be faithful to the state."

From 1558 for forty years the biography of Cecil is almost indistinguishable from that of Elizabeth and from the history of England. Of personal incident, apart from his mission to Scotland in 1560, there is little. He represented Lincolnshire in the parliament of 1559, and Northamptonshire in that of 1563, and he took an active part in the proceedings of the House of Commons until his elevation to the peerage; but there seems no good evidence for the story that he was proposed as speaker in 1563. In January 1561 he was given the lucrative office of master of the court of wards in succession to Sir Thomas Parry, and he did something to reform that instrument of tyranny and abuse. In February 1559 he was elected chancellor of Cambridge University in succession to Cardinal Pole; he was created M.A. of that university on the occasion of Elizabeth's visit in 1564, and M.A. of Oxford on a similar occasion in 1566. On the 25th of February 1571 he was raised to the peerage as Baron Burghley of Burghley¹ (or Burleigh); the fact that he continued to act as secretary after his elevation illustrates the growing importance of that office, which under his son became a secretaryship of state. In 1572, however, the marquis of Winchester, who had been lord high treasurer under Edward, Mary and Elizabeth, died, and Burghley succeeded to his post. It was a signal triumph over Leicester; and, although Burghley had still to reckon with cabals in the council and at court, his hold over the queen strengthened with the lapse of years. Before he died, Robert, his only surviving son by his second wife, was ready to step into his shoes as the queen's principal adviser. Having survived all his rivals, and all his children except Robert and the worthless Thomas, Burghley died at his London house on the 4th of August 1598, and was buried in St. Martin's, Stamford.

Burghley's private life was singularly virtuous; he was a faithful husband, a careful father and a considerate master. A book-lover and antiquary, he made a special hobby of heraldry and genealogy. It was the conscious and unconscious aim of the age to reconstruct a new landed aristocracy on the ruins of the old, and Burghley was a great builder and planter. All the arts of architecture and horticulture were lavished on Burghley House and Theobalds, which his son exchanged for Hatfield. His public conduct does not present itself in quite so amiable a light. As the marquis of Winchester said of himself, he was sprung from the willow rather than the oak, and he was not the man to suffer for convictions. The interest of the state was the supreme consideration, and to it he had no hesitation in sacrificing individual consciences. He frankly disbelieved in toleration; "that state," he said, "could never be in safety where there was a toleration of two religions. For there is no enmity so great as that for religion; and therefore they that differ in the service of their God can never agree in the service of their country." With a maxim such as this, it was easy for him to maintain that Elizabeth's coercive measures were political and not religious. To say that he was Machiavellian is meaningless, for every statesman is so more or less; especially in the 16th century men preferred efficiency to principle. On the other hand, principles are valueless without law and order; and Burghley's craft and subtlety prepared a security in which principles might find some scope.

The sources and authorities for Burghley's life are endless. The most important collection of documents is at Hatfield, where there are some ten thousand papers covering the period down to Burghley's

death; these have been calendared in 8 volumes by the Hist. MSS. Comm. At least as many others are in the Record Office and British Museum, the Lansdowne MSS. especially containing a vast mass of his correspondence; see the catalogues of Cotton, Harleian, Royal, Sloane, Egerton and Additional MSS. in the British Museum, and the *Calendars of Domestic, Foreign, Spanish, Venetian, Scottish and Irish State Papers*.

Other official sources are the *Acts of the Privy Council* (vols. i.-xxix.); *Lords' and Commons' Journals*, *D'Ewes' Journals*, *Off. Ret. M.P.'s*; *Rymer's Fœdera*; *Collins's Sydney State Papers*; *Nichols's Progresses of Elizabeth*. See also *Strype's Works* (26 vols.), *Parker Soc. Publ.* (56 vols.); *Camden's Annals*; *Holinshed, Stow and Speed's Chron.*; *Hayward's Annals*; *Machyn's Diary*, *Leycester Coram.*, *Egerton Papers* (Camden Soc.). For Burghley's early life, see *Cooper's Athenæa Cantab.*; *Baker's St John's Coll., Camb.*, ed. Mayor; *Letters and Papers of Henry VIII.*; *Tytler's Edward VI.*; *Nichols's Lit. Remains of Edward VI.*; *Leadam's Court of Requests, Chron. of Queen Jane* (Camden Soc.), and throughout *Froude's Hist.* No satisfactory life of Burghley has yet appeared; some valuable anonymous notes, probably by Burghley's servant Francis Alford, were printed in *Peck's Desiderata Curiosa* (1732), i. 1-66; other notes are in *Naunton's Fragmenta Regalia*. Lives by *Collins* (1732), *Charlton and Melvil* (1738), were followed by *Nares's* biography in three of the most ponderous volumes (1828-1831) in the language; this provoked *Macaulay's* brilliant but misleading essay. *M. A. S. Hume's Great Lord Burghley* (1898) is largely a piecing together of the references to Burghley in the same author's *Calendar of Simancas MSS.* The life by *Dr Jessopp* (1904) is an expansion of his article in the *Dict. Nat. Biog.*; it is still only a sketch, though the volume contains a mass of genealogical and other incidental information by other hands. (A. F. F.)

BURGKMAIR, HANS or **JOHN** (1473-? 1531), German painter and engraver on wood, believed to have been a pupil of Albrecht Dürer, was born at Augsburg. Professor Christ ascribes to him about 700 woodcuts, most of them distinguished by that spirit and freedom which we admire in the works of his supposed master. His principal work is the series of 135 prints representing the triumphs of the emperor Maximilian I. They are of large size, executed in chiaroscuro, from two blocks, and convey a high idea of his powers. Burgkmair was also an excellent painter in fresco and in distemper, specimens of which are in the galleries of Munich and Vienna, carefully and solidly finished in the style of the old German school.

BURGLARY (*burgi latorcinium*; in ancient English law, *hamesucken*), at common law, the offence of breaking and entering the dwelling-house of another with intent to commit a felony. The offence and its punishment are regulated in England by the Larceny Act 1861. The four important points to be considered in connexion with the offence of burglary are (1) the time, (2) the place, (3) the manner and (4) the intent. The *time*, which is now the essence of the offence, was not considered originally to have been very material, the gravity of the crime lying principally in the invasion of the sanctity of a man's domicile. But at some period before the reign of Edward VI. it had become settled that time was essential to the offence, and it was not adjudged burglary unless committed by night. The day was then accounted as beginning at sunrise, and ending immediately after sunset, but it was afterwards decided that if there were left sufficient daylight or twilight to discern the countenance of a person, it was no burglary. This, again, was superseded by the Larceny Act 1861, for the purpose of which night is deemed to commence at nine o'clock in the evening of each day, and to conclude at six o'clock in the morning of the next succeeding day.

The *place* must, according to Sir E. Coke's definition, be a mansion-house, i.e. a man's dwelling-house or private residence. No building, although within the same curtilage as the dwelling-house, is deemed to be a part of the dwelling-house for the purposes of burglary, unless there is a communication between such building and dwelling-house either immediate or by means of a covered and enclosed passage leading from the one to the other. Chambers in a college or in an inn of court are the dwelling-house of the owner; so also are rooms or lodgings in a private house, provided the owner dwells elsewhere, or enters by a different outer door from his lodger, otherwise the lodger is merely an inmate and his apartment a parcel of the one dwelling-house.

¹ In Scots law, the word *hamesucken* meant the feloniously beating or assaulting a man in his own house.

² This was the form always used by Cecil himself.

As to the *manner*, there must be both a breaking and an entry. Both must be at night, but not necessarily on the same night, provided that in the breaking and in the entry there is an intent to commit a felony. The breaking may be either an actual breaking of any external part of a building; or opening or lifting any closed door, window, shutter or lock, or entry by means of a threat, artifice or collusion with persons inside; or by means of such a necessary opening as a chimney. If an entry is obtained through an open window, it will not be burglary, but if an inner door is afterwards opened, it immediately becomes so. Entry includes the insertion through an open door or window, or any aperture, of any part of the body or of any instrument in the hand to draw out goods. The entry may be before the breaking, for the Larceny Act 1861 has extended the definition of burglary to cases in which a person enters another's dwelling with intent to commit felony, or being in such house commits felony therein, and in either case *breaks out* of such dwelling-house by night.

Breaking and entry must be with the *intent* to commit a felony, otherwise it is only trespass. The felony need not be a larceny, it may be either murder or rape. The punishment is penal servitude for life, or any term not less than three years, or imprisonment not exceeding two years, with or without hard labour.

Housebreaking in English law is to be distinguished from burglary, in that it is not essential that it should be committed at night, nor in a dwelling-house. It may, according to the Larceny Act 1861, be committed in a school-house, shop, warehouse or counting-house. Every burglary involves house-breaking, but every housebreaking does not amount to burglary. The punishment for housebreaking is penal servitude for any term not exceeding fourteen years and not less than three years, or imprisonment for any term not exceeding two years, with or without hard labour.

In the United States the common-law definition of burglary has been modified by statute in many states, so as to cover what is defined in England as housebreaking; the maximum punishment nowhere exceeds imprisonment for twenty years.

AUTHORITIES.—Pollock and Maitland, *History of English Law*; Stephen, *History of Criminal Law*; Archbold, *Pleading and Evidence in Criminal Cases*; Russell, *On Crimes and Misdemeanours*; Stephen, *Commentaries*.

BURGON, JOHN WILLIAM (1813-1888), English divine, was born at Smyrna on the 21st of August 1813, the son of a Turkey merchant, who was a skilled numismatist and afterwards became an assistant in the antiquities department of the British Museum. His mother was a Greek. After a few years of business life, Burgon went to Worcester College, Oxford, in 1841, gained the Newdigate prize, took his degree in 1845, and won an Oriel fellowship in 1846. He was much influenced by his brother-in-law, the scholar and theologian Henry John Rose (1800-1873), a churchman of the old conservative type, with whom he used to spend his long vacations. Burgon made Oxford his headquarters, while holding a living at some distance. In 1863 he was made vicar of St Mary's, having attracted attention by his vehement sermons against *Essays and Reviews*. In 1867 he was appointed Gresham professor of divinity. In 1871 he published a defence of the genuineness of the twelve last verses of St Mark's Gospel. He now began an attack on the proposal for a new lectionary for the Church of England, based largely upon his objections to the principles for determining the authority of MS. readings adopted by Westcott and Hort, which he assailed in a memorable article in the *Quarterly Review* for 1881. This, with his other articles, was reprinted in 1884 under the title of *The Revision Revised*. His biographical essays on H. L. Mansel and others were also collected, and published under the title of *Two Good Men* (1888). Protests against the inclusion of Dr Vance Smith among the revisers, against the nomination of Dean Stanley to be select preacher in the university of Oxford, and against the address in favour of toleration in the matter of ritual, followed in succession. In 1876 Burgon was made dean of Chichester. He died on the 4th of August 1888.

His life was written by Dean E. M. Goulburn (1892). Vehement and almost passionate in his convictions, Burgon nevertheless possessed a warm and kindly heart. He may be described as a high churchman of the type prevalent before the rise of the Tractarian school. His extensive collection of transcripts from the Greek Fathers, illustrating the text of the New Testament, was bequeathed to the British Museum.

BURGONET, or **BURGANET** (from Fr. *bourguignote*, Burgundian helmet), a form of light helmet or head-piece, which was in vogue in the 16th and 17th centuries. In its normal form the burgonet was a large roomy cap with a brim shading the eyes, cheek-pieces or flaps, a comb, and a guard for the back of the neck. In many cases a vizor, or other face protection, and a chin-piece are found in addition, so that this piece of armour is sometimes mistaken for an armet (q.v.), but it can always be distinguished by the projecting brim in front. The morion and cabasset have no face, cheek or neck protection. The typical head-piece of the 17th-century soldier in England and elsewhere is a burgonet skull-cap with a straight brim, neck-guard and often, in addition, a fixed vizor of three thin iron bars which are screwed into, and hang down from, the brim in front of the eyes.

BURGOS, a province of northern Spain; bounded on the N.E. by Biscay and Alava, E. by Logroño, S.E. by Soria, S by Segovia, S.W. by Valladolid, W. by Palencia, and N.W. by Santander. Pop. (1900) 338,828, area, 5480 sq. m. Burgos includes the isolated county of Treviño, which is shut in on all sides by territory belonging to Alava. The northern and north-eastern districts of the province are mountainous, and the central and southern form part of the vast and elevated plateau of Old Castile. The extreme northern region is traversed by part of the great Cantabrian chain. Eastwards are the highest peaks of the province in the Sierra de la Demanda (with the Cerro de San Millán, 6995 ft. high) and in the Sierra de Neila. On the eastern frontier, midway between these highlands and the Cantabrian chain, two comparatively low ranges, running east and west of Pancorbo, leave a gap through which run the railway and roads connecting Castile with the valley of the Ebro. This Pancorbo Pass has often been called the "Iron Gates of Castile," as a handful of men could hold it against an army. South and west of this spot begins the plateau, generally covered with snow in winter, and swept by such cold winds that Burgos is considered, with Soria and Segovia, one of the coldest regions of the peninsula. The Ebro runs eastwards through the northern half of the province, but is not navigable. The Douro, or Duero, crosses the southern half, running west-north-west; it also is unnavigable in its upper valley. The other important streams are the Pisuerga, flowing south towards Palencia and Valladolid, and the Arlanzón, which flows through Burgos for over 75 m.

The variations of temperature are great, as from 9° to 70° of frost have frequently been recorded in winter, while the mean summer temperature is 64° (Fahr.). As but little rain falls in summer, and the soil is poor, agriculture thrives only in the valleys, especially that of the Ebro. In live-stock, however, Burgos is one of the richest of Spanish provinces. Horses, mules, asses, goats, cattle and pigs are bred in considerable numbers, but the mainstay of the peasantry is sheep-farming. Vast ranges of almost uninhabited upland are reserved as pasture for the flocks, which at the beginning of the 19th century contained more than 500,000 head of sheep. Coal, china-clay and salt are obtained in small quantities, but, out of more than 150 mines registered, only 4 were worked in 1903. The other industries of the province are likewise undeveloped, although there are many small potteries, stone quarries, tanneries and factories for the manufacture of linen and cotton of the coarsest description. The ancient cloth and woollen industries, for which Burgos was famous in the past, have almost disappeared. Trade is greatly hindered by the lack of adequate railway communication, and even of good roads. The Northern railway from Madrid to the French frontier cross the province in the central districts; the Valladolid-Bilbao line traverses the Cantabrian mountains, in the north; and the Valladolid-Saragossa line skirts the Douro valley, in the south. The only

important town in the province is Burgos, the capital (pop. 30,167). Few parts of Spain are poorer; education makes little progress, and least of all in the thinly peopled rural districts, with their widely scattered hamlets. The peasantry have thus every inducement to migrate to the Basque Provinces, Catalonia and other relatively prosperous regions; and consequently the population does not increase, despite the excess of births over deaths.

BURGOS, the capital formerly of Old Castile, and since 1833 of the Spanish province of Burgos, on the river Arlanzón, and on the Northern railways from Madrid to the French frontier. Pop. (1900) 30,167. Burgos, in the form of an amphitheatre, occupies the lower slopes of a hill crowned by the ruins of an ancient citadel. It faces the Arlanzón, a broad and swift stream, with several islands in mid-channel. Three stone bridges lead to the suburb of La Vega, on the opposite bank. On all sides, except up the castle hill, fine avenues and public gardens are laid out, notably the Paseo de la Isla, extending along the river to the west. Burgos itself was originally surrounded by a wall, of which few fragments remain; but although its streets and broad squares, such as the central Plaza Mayor, or Plaza de la Constitución, have often quite a modern appearance, the city retains much of its picturesque character, owing to the number and beauty of its churches, convents and palaces. Unaffected by the industrial activity of the neighbouring Basque Provinces, it has little trade apart from the sale of agricultural produce and the manufacture of paper and leathern goods.

But it is rich in architectural and antiquarian interest. The citadel was founded in 884 by Diego Rodríguez Porcelos, count of Castile; in the 10th century it was held against the kings of Leon by Count Fernan Gonzalez, a mighty warrior; and even in 1812 it was successfully defended by a French garrison against Lord Wellington and his British troops. Within its walls the Spanish national hero, the Cid Campeador, was wedded to Ximena of Oviedo in 1074; and Prince Edward of England (afterwards King Edward I.) to Eleanor of Castile in 1254. Statues of Porcelos, Gonzalez and the Cid, of Nuño Rasura and Lain Calvo, the first elected magistrates of Burgos, during its brief period of republican rule in the 10th century, and of the emperor Charles V., adorn the massive Arco de Santa Maria, which was erected between 1536 and 1562, and commemorates the return of the citizens to their allegiance, after the rebellion against Charles V. had been crushed in 1522. The interior of this arch serves as a museum. Tradition still points to the site of the Cid's birthplace; and a reliquary preserved in the town hall contains his bones, and those of Ximena, brought hither after many changes, including a partial transference to Sigmaringen in Germany.

Other noteworthy buildings in Burgos are the late 15th century Casa del Córdón, occupied by the captain-general of Old Castile; the Casa de Miranda, which worthily represents the best domestic architecture of Spain in the 16th century; and the barracks, hospitals and schools. Burgos is the see of an archbishop, whose province comprises the diocese of Palencia, Pamplona, Santander and Tudela. The cathedral, founded in 1221 by Ferdinand III. of Castile and the English bishop Maurice of Burgos, is a fine example of florid Gothic, built of white limestone (see ARCHITECTURE, Plate II. fig. 65). It was not completed until 1567, and the architects principally responsible for its construction were a Frenchman in the 13th century and a German in the 15th. Its cruciform design is almost hidden by 26 fifteen chapels added at all angles to the aisles and transepts, and the beautiful 14th-century cloister on the north-west and the archiepiscopal palace on the south-west. Over the three central doorways of the main or western façade rise two lofty and graceful towers. Many of the monuments within the cathedral are of considerable artistic and historical interest. The chapel of Corpus Christi contains the chest which the Cid said to have filled with sand and subsequently pawned for a large sum to the credulous Jews of Burgos. The legend adds that he redeemed his pledge. In the aisleless Gothic church of Santa Agueda, or Santa Gadéa, tradition relates that the Cid

compelled Alphonso VI. of Leon, before his accession to the throne of Castile in 1072, to swear that he was innocent of the murder of Sancho his brother and predecessor on the throne. San Estéban, completed between 1280 and 1350, and San Nicolás, dating from 1505, are small Gothic churches, each with a fine sculptured doorway. Many of the convents of Burgos have been destroyed, and those which survive lie chiefly outside the city. At the end of the Paseo de la Isla stands the nunnery of Santa Maria la Real de las Huelgas, originally a summer palace (*huelga*, "pleasure-ground") of the kings of Castile. In 1187 it was transformed into a Cistercian convent by Alphonso VIII., who invested the abbess with almost royal prerogatives, including the power of life and death, and absolute rule over more than fifty villages. Alphonso and his wife Eleanor, daughter of Henry II. of England, are buried here. The Cartuja de Miraflores, a Carthusian convent, founded by John II. of Castile (1406-1454), lies 2 m. south-east of Burgos. Its church contains a monument of exceptional beauty, carved by Gil de Siloé in the 15th century, for the tomb of John and his second wife, Isabella of Portugal. The convent of San Pedro de Cardena, 7 m. south-east of Burgos, was the original burial-place of the Cid, in 1099, and of Ximena, in 1104. About 50 m. from the city is the abbey of Silos, which appears to have been founded under the Visigothic kings, as early as the 6th century. It was restored in 919 by Fernan Gonzalez, and in the 11th century became celebrated throughout Europe, under the rule of St Dominic or Domingo. It was reoccupied in 1880 by French Benedictine monks.

The known history of Burgos begins in 884 with the foundation of the citadel. From that time forward it steadily increased in importance, reaching the height of its prosperity in the 15th century, when, alternately with Toledo, it was occupied as a royal residence, but rapidly declining when the court was finally removed to Madrid in 1560. Being on one of the principal military roads of the kingdom, it suffered severely during the Peninsular War. In 1808 it was the scene of the defeat of the Spanish army by the French under Marshal Soult. It was unsuccessfully besieged by Wellington in 1812, but was surrendered to him at the opening of the campaign of the following year.

Of the extensive literature relating to Burgos, much remains unedited and in manuscript. A general description of the city and its monuments is given by A. Llacayo y Santa Maria in *Burgos, &c.* (Burgos, 1889). See also *Architectural, Sculptural and Picturesque Studies in Burgos and its Neighbourhood*, a valuable series of architectural drawings in folio, by J. B. Waring (London, 1852). The following are monographs on particular buildings:—*Historia de la Catedral de Burgos, &c.*, by P. Orcajo (Burgos, 1856); *El Castillo de Burgos*, by E. de Oliver-Copons (Barcelona, 1893); *La Real Cartuja de Miraflores*, by F. Tarin y Juaneada (Burgos, 1896). For the history of the city see *En Burgos*, by V. Balaguér (Burgos, 1895); *Burgos en las comunidades de Castilla and Casas de la vieja Burgos*, both by A. Salvá (Burgos, 1895 and 1892). The following relate both to the city and to the province of Burgos:—*Burgos, &c.*, by R. Amador de los Rios, in the series entitled *España* (Barcelona, 1888); *Burgos y su provincia*, anon. (Vitoria, 1898); *Intento de un diccionario biográfico y bibliográfico de autores de la prov. de Burgos*, by M. Anbarro and M. Rives (Madrid, 1890).

BURGOYNE, JOHN (1722-1792), English general and dramatist, entered the army at an early age. In 1743 he made a runaway marriage with a daughter of the earl of Derby, but soon had to sell his commission to meet his debts, after which he lived abroad for seven years. By Lord Derby's interest Burgoyne was then reinstated at the outbreak of the Seven Years' War, and in 1758 he became captain and lieutenant-colonel in the foot guards. In 1758-1759 he participated in expeditions made against the French coast, and in the latter year he was instrumental in introducing light cavalry into the British army. The two regiments then formed were commanded by Elliott (afterwards Lord Heathfield) and Burgoyne. In 1761 he sat in parliament for Midhurst, and in the following year he served as brigadier-general in Portugal, winning particular distinction by his capture of Valencia d'Alcantara and of Villa Velha. In 1768 he became M.P. for Preston, and for the next few years he occupied himself chiefly with his parliamentary duties, in which he was remarkable for his general outspokenness

and, in particular, for his attacks on Lord Clive. At the same time he devoted much attention to art and drama (his first play, *The Maid of the Oaks*, being produced by Garrick in 1775), and gambled recklessly. In the army he had by this time become a major-general, and on the outbreak of the American War of Independence he was appointed to a command. In 1777 he was at the head of the British reinforcements designed for the invasion of the colonies from Canada. In this disastrous expedition he gained possession of Ticonderoga (for which he was made a lieutenant-general) and Fort Edward; but, pushing on, was detached from his communications with Canada, and hemmed in by a superior force at Saratoga (q.v.). On the 17th of October his troops, about 3500 in number, laid down their arms. The success was the greatest the colonists had yet gained, and it proved the turning-point in the war. The indignation in England against Burgoyne was great, but perhaps unjust. He returned at once, with the leave of the American general, to defend his conduct, and demanded, but never obtained, a trial. He was deprived of his regiment and a governorship which he held. In 1782, however, when his political friends came into office, he was restored to his rank, given a colonelcy, and made commander-in-chief in Ireland and a privy councillor. After the fall of the Rockingham government in 1783, Burgoyne withdrew more and more into private life, his last public service being his participation in the impeachment of Warren Hastings. In his latter years he was principally occupied in literary and dramatic work. His comedy, *The Heiress*, which appeared in 1786, ran through ten editions within a year, and was translated into several foreign tongues. He died suddenly on the 4th of June 1792. General Burgoyne, whose wife died in June 1776 during his absence in Canada, had several natural children (born between 1782 and 1788) by Susan Caulfield, an opera singer, one of whom became Field Marshal Sir J. F. Burgoyne. His *Dramatic and Poetical Works* appeared in two vols., 1808.

See E. B. de Fonblanque, *Political and Military Episodes from the Life and Correspondence of Right Hon. J. Burgoyne* (1876); and W. L. Stone, *Campaign of Lieut.-Gen. J. Burgoyne, &c.* (Albany, N.Y., 1877).

BURGOYNE, SIR JOHN FOX, Bart. (1782–1871), British field marshal, was an illegitimate son of General John Burgoyne (q.v.). He was educated at Eton and Woolwich, obtained his commission in 1798, and served in 1800 in the Mediterranean. In 1805, when serving on the staff of General Fox in Sicily, he was promoted second captain. He accompanied the unfortunate Egyptian expedition of 1807, and was with Sir John Moore in Sweden in 1808 and in Portugal in 1808–9. In the Corunna campaign Burgoyne held the very responsible position of chief of engineers with the rear-guard of the British army (see PENINSULAR WAR). He was with Wellesley at the Duro in 1809, and was promoted captain in the same year, after which he was engaged in the construction of the lines of Torres Vedras in 1810. He blew up Fort Concepcion on the river Turones, and was present at Busaco and Torres Vedras. In 1811 he was employed in the unsuccessful siege of Badajoz, and in 1812 he won successively the brevets of major and lieutenant-colonel, for his skilful performance of engineer duties at the historic sieges of Ciudad Rodrigo and Badajoz. He was present in the same year (1812) at the siege and battle of Salamanca, and after the battle of Vittoria in 1813 he became commanding engineer on Lord Wellington's staff. At the close of the war he received the C.B., a reward which, he justly considered, was not commensurate with his services. In 1814–1815 he served at New Orleans and Mobile. Burgoyne was largely employed, during the long peace which followed Waterloo, in other public duties as well as military work. He sat on numerous commissions, and served for fifteen years as chairman of the Irish board of public works. He became a major-general and K.C.B. in 1838, and inspector-general of fortifications in 1845. In 1851 he was promoted lieutenant-general, and in the following year received the G.C.B. When the Crimean War broke out he accompanied Lord Raglan's headquarters to the East, superintended the disembarkation at Old Fort, and was in effect the principal engineer adviser to the English commander during the first part of the siege of

Sevastopol. He was recalled early in 1855, and though he was at first bitterly criticized by the public for his part in the earlier and unsuccessful operations against the fortress the wisdom of his advice was ultimately recognized. In 1856 he was created a baronet, and promoted to the full rank of general. In 1858 he was present at the second funeral of Napoleon I. as Queen Victoria's representative, and in 1865 he was made constable of the Tower of London. Three years later, on resigning his post as inspector-general of fortifications, he was made a field marshal. Parliament granted him, at the same time, a pension of £1500. He died on the 7th of October 1871, a year after the tragic death of his only son, Captain Hugh Talbot Burgoyne, V.C. (1833–1870), who was in command of H.M.S. "Captain" when that vessel went down in the Bay of Biscay (September 7, 1870).

See *Life and Correspondence of F.M. Sir John Fox Burgoyne* (edited by Lt.-Col. Hon. G. Wrottesley, R.E., London, 1871); Sir Francis Head, *A Sketch of the Life and Death of F.M. Sir John Burgoyne* (London, 1872); *Military Opinions of General Sir John Burgoyne* (ed. Wrottesley, London, 1859), a collection of the most important of Burgoyne's contributions to military literature.

BURGRAVE, the Eng. form, derived through the Fr., of the Ger. *Burggraf* and Flem. *burg* or *burgh-graese* (med. Lat. *burggravius* or *burgicomes*), i.e. count of a castle or fortified town. The title is equivalent to that of castellan (Lat. *castellanus*) or *châtelain* (q.v.). In Germany, owing to the peculiar conditions of the Empire, though the office of burgrave had become a sinecure by the end of the 13th century, the title, as borne by feudal nobles having the status of princes of the Empire, obtained a quasi-royal significance. It is still included among the subsidiary titles of several sovereign princes; and the king of Prussia, whose ancestors were burgraves of Nuremberg for over 200 years, is still styled burgrave of Nuremberg.

BURGED, king of Mercia, succeeded to the throne in 852, and in 852 or 853 called upon Æthelwulf of Wessex to aid him in subduing the North Welsh. The request was granted and the campaign proved successful, the alliance being sealed by the marriage of Burgred to Æthelwith, daughter of Æthelwulf. In 868 the Mercian king appealed to Æthelred and Alfred for assistance against the Danes, who were in possession of Nottingham. The armies of Wessex and Mercia did no serious fighting, and the Danes were allowed to remain through the winter. In 874 the march of the Danes from Lindsey to Repton drove Burgred from his kingdom. He retired to Rome and died there.

See *Saxon Chronicle* (Earle and Plummer), years 852–853, 868, 874.

BURGUNDIO, sometimes erroneously styled **BURGOMUS**, an Italian jurist of the 12th century. He was a professor at the university of Paris, and assisted at the Lateran Council in 1179, dying at a very advanced age in 1194. He was a distinguished Greek scholar, and is believed on the authority of Odofredus to have translated into Latin, soon after the Pandects were brought to Bologna, the various Greek fragments which occur in them, with the exception of those in the 27th book, the translation of which has been attributed to Modestinus. The Latin translations ascribed to Burgundio were received at Bologna as an integral part of the text of the Pandects, and form part of that known as *The Vulgate* in distinction from the Florentine text.

BURGUNDY. The name of Burgundy (Fr. *Bourgogne*, Lat. *Burgundia*) has denoted very diverse political and geographical areas at different periods of history and as used by different writers. The name is derived from the Burgundians (*Burgundi*, *Burgundiones*), a people of Germanic origin, who at first settled between the Oder and the Vistula. In consequence of wars against the Alamanni, in which the latter had the advantage, the Burgundians, after having taken part in the great invasion of Radagaisus in 407, were obliged in 411 to take refuge in Gaul, under the leadership of their chief Gundicar. Under the title of allies of the Romans, they established themselves in certain cantons of the Sequani and of upper Germany, receiving a part of the lands, houses and serfs that belonged to the inhabitants. Thus was founded the first kingdom of Burgundy, the boundaries of which were widened at different times by Gundicar and his son

Gunderic; its chief towns being Vienne, Lyons, Besançon, Geneva, Autun and Mâcon. Gundibald (d. 516), grandson of Gunderic, is famous for his codification of the Burgundian law, known consequently as *Lex Gundobada*, in French *Loi Gombette*. His son Sigismund, who was canonized by the church, founded the abbey of St Maurice at Aganum. But, incited thereto by Clotilda, the daughter of Chilperic (a brother of Gundibald, and assassinated by him), the Merovingian kings attacked Burgundy. An attempt made in 524 by Clodomer was unsuccessful; but in 534 Clotaire (Chlothachar) and his brothers possessed themselves of the lands of Gundimar, brother and successor of Sigismund, and divided them between them. In 561 the kingdom of Burgundy was reconstructed by Guntram, son of Clotaire I., and until 613 it formed a separate state under the government of a prince of the Merovingian family.

After 613 Burgundy was one of the provinces of the Frankish kingdom, but in the redistributions that followed the reign of Charlemagne the various parts of the ancient kingdom had different fortunes. In 843, by the treaty of Verdun, Autun, Chalons, Mâcon, Langres, &c., were apportioned to Charles the Bald, and Lyons with the country beyond the Saône to Lothair I. On the death of the latter the duchy of Lyons (Lyonnais and Viennois) was given to Charles of Provence, and the diocese of Besançon with the country beyond the Jura to Lothair, king of Lorraine. In 879 Boso founded the kingdom of Provence, wrongly called the kingdom of Cisjuran Burgundy, which extended to Lyons, and for a short time as far as Mâcon (see PROVENCE).

In 888 the kingdom of Juran Burgundy was founded by Rudolph I., son of Conrad, count of Auxerre, and the German king Arnulf could not succeed in expelling the usurper, whose authority was recognized in the diocese of Besançon, Basel, Lausanne, Geneva and Sion. For a short time his son and successor Rudolph II. (912-937) disputed the crown of Italy with Hugh of Provence, but finally abandoned his claims in exchange for the ancient kingdom of Provence, i.e. the country bounded by the Rhône, the Alps and the Mediterranean. His successor, Conrad the Peaceful (937-993), whose sister Adelaide married Otto the Great, was hardly more than a vassal of the German kings. The last king of Burgundy, Rudolph III. (993-1032), being deprived of all but a shadow of power by the development of the secular and ecclesiastical aristocracy—especially by that of the powerful feudal houses of the counts of Burgundy (see FRANCE-COMTÉ), Savoy and Provence—died without issue, bequeathing his lands to the emperor Conrad II. Such was the origin of the imperial rights over the kingdom designated after the 13th century as the kingdom of Arles, which extended over a part of what is now Switzerland (from the Jura to the Aar), and included Franche-Comté, Lyonnais, Dauphiné, Savoy and Provence.

The name of Burgundy now gradually became restricted to the countship of that name, which included the district between the Jura and the Saône, in later times called Franche-Comté, and to the *duchy* which had been created by the Carolingian kings in the portion of Burgundy that had remained French, with the object of resisting Boso. This duchy had been granted to Boso's brother, Richard the Justiciary, count of Autun. It comprised at first the countships of Autun, Mâcon, Chalons-sur-Saône, Langres, Nevers, Auxerre and Sens, but its boundaries and designations changed many times in the course of the 10th century. Duke Henry died in 1002; and in 1015, after a war which lasted thirteen years, the French king Robert II. reunited the duchy to his kingdom, despite the opposition of Otto William, count of Burgundy, and gave it to his son Henry, afterwards King Henry I. As king of France, the latter in 1032 bestowed the duchy upon his brother Robert, from whom sprang that first ducal house of Burgundy which flourished until 1361. A grandson of this Robert, who went to Spain to fight the Arabs, became the founder of the kingdom of Portugal; but in general the first Capet dukes of Burgundy were pacific princes who took little part in the political events of their time, or in that religious movement which was so marked in Burgundy, at Cluny to begin with, afterwards among the disciples of William of St Bénigne

of Dijon, and later still among the monks of Cliteaux. In the 12th and 13th centuries we may mention Duke Hugh III. (1162-1193), who played an active part in the wars that marked the beginning of Philip Augustus's reign; Odo (Eudes) III. (1193-1218), one of Philip Augustus's principal supporters in his struggle with King John of England; Hugh IV. (1218-1272), who acquired the countships of Châlons and Auxonne; Robert II. (1272-1309), one of whose daughters, Margaret, married Louis X. of France, and another, Jeanne, Philip of Valois; Odo (Eudes) IV. (1315-1350), who gained the countship of Artois in right of his wife, Jeanne of France, daughter of Philip V. the Tall and of Jeanne, countess of Burgundy.

In 1361, on the death of Duke Philip de Rouvres, son of Jeanne of Auvergne and Boulogne, who had married the second time John II. of France, surnamed the Good, the duchy of Burgundy returned to the crown of France. In 1363 John gave it, with hereditary rights, to his son Philip, surnamed the Bold, thus founding that second Capet house of Burgundy which filled such an important place in the history of France during the 14th and 15th centuries, acquiring as it did a territorial power which proved redoubtable to the kingship itself. By his marriage with Margaret of Flanders Philip added to his duchy, on the death of his father-in-law, Louis of Male, in 1384, the countships of Burgundy and Flanders; and in the same year he purchased the countship of Charolais from John, count of Armagnac. On the death of Charles V. in 1380 Philip and his brothers, the dukes of Anjou and Berry, had possessed themselves of the regency, and it was he who led Charles VI. against the rebellious Flemings, over whom the young king gained the victory of Roosebeke in 1382. Momentarily deprived of power during the period of the "Marmousets" government, he devoted himself to the administration of his own dominions, establishing in 1386 an audit-office (*chambre des comptes*) at Dijon and another at Lille. In 1396 he refused to take part personally in the expedition against the Turks which ended in the disaster of Nicopolis, and would only send his son John, then count of Nevers. In 1392 the king's madness caused Philip's recall to power along with the other princes of the blood, and from this time dates that hostility between the party of Burgundy and the party of Orleans which was to become so intense when in May 1404 Duke Philip had been succeeded by his son, John the Fearless.

In 1407 the latter caused the assassination of his political rival, Louis of Orleans, the king's brother. Forced to quit Paris for a time, he soon returned, supported in particular by the guild of the butchers and by the university. The monk Jean Petit pronounced an apology for the murder (1408).

The victory of Hasbain which John achieved on the 23rd of September 1408 over the Liégeois, who had attacked his brother-in-law, John of Bavaria, bishop of Liège, still further strengthened his power and reputation, and during the following years the struggle between the Burgundians and the partisans of the duke of Orleans—or Armagnacs, as they were called—went on with varying results. In 1413 a reaction took place in Paris; John the Fearless was once more expelled from the capital, and only returned there in 1418, thanks to the treason of Perrinet Leclerc, who yielded up the town to him. In 1419, just when he was thinking of making advances towards the party of the dauphin (Charles VII.), he was assassinated by members of that party, during an interview between himself and the dauphin at the bridge of Montereau.

This event inclined the new duke of Burgundy, Philip the Good, towards an alliance with England. In 1420 he signed the treaty of Troyes, which recognized Henry V. as the legitimate successor of Charles VI.; in 1423 he gave his sister Anne in marriage to John, duke of Bedford; and during the following years the Burgundian troops supported the English pretender. But a dispute between him and the English concerning the succession in Hainaut, their refusal to permit the town of Orleans to place itself under his rule, and the defeats sustained by them, all combined to embroil him with his allies, and in 1435 he concluded the treaty of Arras with Charles VII. The king relieved the duke of all homage for his estates during his lifetime,

and gave up to him the countships of Mâcon, Auxerre, Bar-sur-Seine and Ponthieu; and, reserving the right of redemption, the towns of the Somme (Roye, Montdidier, Péronne, &c.). Besides this Philip had acquired Brabant and Holland in 1433 as the inheritance of his mother. He gave an asylum to the dauphin Louis when exiled from Charles VII.'s court, but refused to assist him against his father, and henceforth rarely intervened in French affairs. He busied himself particularly with the administration of his state, founding the university of Dôle, having records made of Burgundian customs, and seeking to develop the commerce and industries of Flanders. A friend to letters and the arts, he was the protector of writers like Olivier de la Marche, and of sculptors of the school of Dijon. He also desired to revive ancient chivalry as he conceived it, and in 1429 founded the order of the Golden Fleece; while during the last years of his life he devoted himself to the preparation of a crusade against the Turks. Neither these plans, however, nor his liberality, prevented his leaving a well-filled treasury and enlarged dominions when he died in 1467.

Philip's successor was his son by his third wife, Isabel of Portugal, Charles, surnamed the Bold, count of Charolois, born in 1433. To him his father had practically abandoned his authority during his last years. Charles had taken an active part in the so-called wars "for the public weal," and in the conditions of nobles against the king which were so frequent during the first years of Louis XI.'s reign. His struggle against the king is especially marked by the interview at Péronne in 1468, when the king had to confirm the duke in his possession of the towns of the Somme, and by a fruitless attempt which Charles the Bold made on Beauvais in 1472. Charles sought above all to realize a scheme already planned by his father. This was to annex territory which would reunite Burgundy with the northern group of her possessions (Flanders, Brabant, &c.), and to obtain the emperor's recognition of the kingdom of "Belgian Gaul." In 1469 he bought the landgraviate of Alsace and the countship of Ferrette from the archduke Sigismund of Austria, and in 1473 the aged duke Arnold ceded the duchy of Gelderland to him. In the same year he had an interview at Trier with the emperor Frederick III., when he offered to give his daughter and heiress, Mary of Burgundy, in marriage to the emperor's son Maximilian in exchange for the concession of the royal title. But the emperor, uneasy at the ambition of the "grand-duke of the West," did not pursue the negotiations.

Meanwhile the tyranny of the duke's lieutenant Peter von Hagenbach, who was established at Ferrette as governor (*grand bailli* or *Landsvogt*) of Upper Alsace, had brought about an insurrection. The Swiss supported the cause of their allies, the inhabitants of the free towns of Alsace, and Duke René II. of Lorraine also declared war against Charles. In 1474 the Swiss invaded Franche-Comté and achieved the victory of Héricourt. In 1475 Charles succeeded in conquering Lorraine, but an expedition against the Swiss ended in the defeat of Grandson (February 1476). In the same year the duke was again beaten at Morat, and the Burgundian nobles had to abandon to the victors a considerable amount of booty. Finally the duke of Lorraine returned to his dominions; Charles advanced against him, but on the 6th of January 1477 he was defeated and killed before Nancy.

By his wife, Isabella of Bourbon, he only left a daughter, Mary, and Louis XI. claimed possession of her inheritance as guardian to the young princess. He succeeded in getting himself acknowledged in the duchy and countship of Burgundy, which were occupied by French garrisons. But Mary, alarmed by this annexation, and by the insurrection at Ghent (secretly fomented by Louis), decided to marry the archduke Maximilian of Austria, to whom she had already been promised (August 1477), and hostilities soon broke out between the two princes. Mary died through a fall from her horse in March 1482, and in the same year the treaty of Arras confirmed Louis XI. in possession of the duchy. Franche-Comté and Artois were to form the dowry of the little Margaret of Burgundy, daughter of Mary and Maximilian, who was promised in marriage to the dauphin. As to the

lands proceeding from the succession of Charles the Bold, which had returned to the Empire (Brabant, Hainaut, Limburg, Namur, Gelderland, &c.), they constituted the "Circle of Burgundy" from 1512 onward.

We know that the title of duke of Burgundy was revived in 1682 for a short time by Louis XIV. in favour of his grandson Louis, the pupil of Fénelon. But from the 16th to the 18th century Burgundy constituted a military government bounded on the north by Champagne, on the south by Lyonnais, on the east by Franche-Comté, on the west by Bourbonnais and Nivernais. It comprised Dijonnais, Autunois, Auxois, and the *pays de la montagne* or Country of the Mountain (Châtillon-sur-Seine), with the "counties" of Chalonnais, Mâconnais, Auxerrois and Bar-sur-Seine, and, so far as administration went, the annexes of Bresse, Bugey, Valromey and the country of Gex. Burgundy was a *pays d'états*. The estates, whose privileges the dukes at first, and later Louis XI., had to swear to maintain, had their assembly at Dijon, usually under the presidency of the governor of the province, the bishop of Autun as representing the clergy, and the mayor of Dijon representing the third estate. In the judiciary point of view the greater part of Burgundy depended on the parlement of Dijon; but Auxerrois and Mâconnais were amenable to the parlement of Paris.

See also U. Plancher, *Histoire générale et particulière de Bourgogne* (Dijon, 1739-1781, 4 vols. 8vo); Courtépée, *Description générale et particulière du duché de Bourgogne* (Dijon, 1774-1785, 7 vols. 8vo); O. Jahn, *Geschichte der Burgundionen* (Halle, 1874, 2 vols. 8vo); E. Petit de Vausse, *Histoire des ducs de Bourgogne de la race capétienne* (Paris, 1885-1905, 9 vols. 8vo); B. de Barante, *Histoire des ducs de Bourgogne de la maison de Valois* (Paris, 1833-1836, 13 vols. 8vo); the marquis Léon E. S. J. de Laborde, *Les Ducs de Bourgogne: Études sur les lettres, les arts et l'industrie pendant le XV^e siècle* (Paris, 1849-1851, 3 vols. 8vo). (R. Fo.)

BURHANPUR, a town of British India in the Nimar district of the Central Provinces, situated on the north bank of the river Tapti, 310 m. N.E. of Bombay, and 2 m. from the Great India Peninsula railway station of Lalbagh. It was founded in A.D. 1400 by a Mahomeddan prince of the Farukhi dynasty of Khandesh, whose successors held it for 200 years, when the Farukhi kingdom was annexed to the empire of Akbar. It formed the chief seat of the government of the Deccan provinces of the Mogul empire till Shah Jahan removed the capital to Aurangabad in 1635. Burhanpur was plundered in 1685 by the Maharrattas, and repeated battles were fought in its neighbourhood in the struggle between that race and the Mussulmans for the supremacy of India. In 1739 the Mahomeddans finally yielded to the demand of the Maharrattas for a fourth of the revenue, and in 1760 the Nizam of the Deccan ceded Burhanpur to the peshwa, who in 1778 transferred it to Sindhia. In the Mahratta War the army under General Wellesley, afterwards the duke of Wellington, took Burhanpur (1803), but the treaty of the same year restored it to Sindhia. It remained a portion of Sindhia's dominions till 1860-1861, when, in consequence of certain territorial arrangements, the town and surrounding estates were ceded to the British government. Under the Moguls the city covered an area of about 5 sq. m., and was about 10½ m. in circumference. In the *Ain-i-Akbari* it is described as a "large city, with many gardens, inhabited by all nations, and abounding with handicraftsmen." Sir Thomas Roe, who visited it in 1614, found that the houses in the town were "only mud cottages, except the prince's house, the chan's and some few others." In 1865-1866 the city contained 8000 houses, with a population of 34,137, which had decreased to 33,341 in 1901. Burhanpur is celebrated for its muslins, flowered silks, and brocades, which, according to Tavernier, who visited it in 1668, were exported in great quantities to Persia, Egypt, Turkey, Russia and Poland. The gold and silver wires used in the manufacture of these fabrics are drawn with considerable care and skill; and in order to secure the purity of the metals employed for their composition, the wire-drawing under the native *rak* was done under government inspection. The town of Burhanpur and its manufactures were long on the decline, but during recent times have made a slight recovery. The buildings of interest

in the town are a palace, built by Akbar, called the Lal Kila or the Red Fort, and the Jama Masjid or Great Mosque, built by Ali Khan, one of the Farukhi dynasty, in 1588. A considerable number of Boras, a class of commercial Mahomedans, reside here.

BURI, or **BURR**, in Norse mythology, the grandfather of Odin. In the creation of the world he was born from the rocks, licked by the cow Andhuma (darkness). He was the father of Bor, and the latter, wedded to Bestla, the daughter of the giant Bolthorn (evil), became the father of Odin, the Scandinavian Jove.

BURIAL and **BURIAL ACTS** (in O. Eng. *byrgels*, whence *byriels*, wrongly taken as a plural, and so Mid. Eng. *buryel*, from O. Eng. *byrgas*, properly to protect, cover, to bury). The main lines of the law of burial in England may be stated very shortly. Every person has the right to be buried in the churchyard or burial ground of the parish where he dies, with the exception of executed felons, who are buried in the precincts of the prison or in a place appointed by the home office. At common law the person under whose roof a death takes place has a duty to provide for the body being carried to the grave decently covered; and the executors or legal representatives of the deceased are bound to bury or dispose of the body in a manner becoming the estate of the deceased, according to their discretion, and they are not bound to fulfil the wishes he may have expressed in this respect. The disposal must be such as will not expose the body to violation, or offend the feelings or endanger the health of the living; and cremation under proper restrictions is allowable. In the case of paupers dying in a parish house, or shipwrecked persons whose bodies are cast ashore, the overseers or guardians are responsible for their burial; and in the case of suicides the coroner has a similar duty. The expenses of burial are payable out of the deceased's estate in priority to all other debts. A husband liable for the maintenance of his wife is liable for her funeral expenses; the parents for those of their children, if they have the means of paying. Legislation has principally affected (1) places of burial, (2) mode of burial, (3) fees for burial, and (4) disinterment.

1. The overcrowded state of churchyards and burial grounds gradually led to the passing of a group of statutes known as the Burial Acts, extending from 1852 up to 1900. By these acts a general system was set up, the aim of which was to remedy the existing deficiencies of accommodation by providing new burial grounds and closing old ones which should be dangerous to health, and to establish a central authority, the home office (now for most purposes the Local Government Board) to superintend all burial grounds with a view to the protection of the public health and the maintenance of public decency in burials. The Local Government Board thus has the power to obtain by order in council the closing of any burial ground it thinks fit, while its consent is necessary to the opening of any new burial ground; and it also has power to direct inspection of any burial ground or cemetery, and to regulate burials in common graves in statutory cemeteries and to compel persons in charge of vaults or places of burial to take steps necessary for preventing their becoming dangerous or injurious to health. The vestry of any parish, whether a common-law or ecclesiastical one, was thus authorized to provide itself with a new burial ground, if its existing one was no longer available; such ground might be wholly or partly consecrated, and chapels might be provided for the performance of burial service. The ground was put under the management of a burial board, consisting of ratepayers elected by the vestry, and the consecrated portion of it took the place of the churchyard in all respects. Disused churchyards and burial grounds in the metropolis may be used as open spaces for recreation, and only buildings for religious purposes can be built on them (1881, 1884, 1887). The Local Government Act 1894 introduced a change into the government of burial grounds (consequent on the general change made in parochial government) by transferring, or allowing to be transferred, the powers, duties, property and liabilities of the burial boards in urban districts to the district councils, and in rural parishes to the parish councils and parish meetings; and by allowing rural parishes

to adopt the Burial Acts, and provide and manage new burial grounds by the parish council, or a burial board elected by the parish meeting.

2. The mode of burial is a matter of ecclesiastical cognizance; in the case of churchyards and elsewhere it is in the discretion of the owners of the burial ground. The Local Government Board now makes regulations for burials in burial grounds provided under the Burial Acts; for cemeteries provided under the Public Health Act 1879. Private cemeteries and burial grounds make their own regulations. Burial may now take place either with or without a religious service in consecrated ground. Before 1880 no body could be buried in consecrated ground except with the service of the Church, which the incumbent of the parish or a person authorized by him was bound to perform; but the canons and prayer-book refused the use of the office for excommunicated persons, *majori excommunicatione*, for some grievous and notorious crime, and no person able to testify of his repentance, unbaptized persons, and persons against whom a verdict of *felo de se* had been found. But by the Burial Laws Amendment Act 1880, the bodies of persons entitled to be buried in parochial burial grounds, whether churchyards or graveyards, may be buried there, on proper notice being given to the minister, without the performance of the service of the Church of England, and either without any religious service or with a Christian and orderly religious service at the grave, which may be conducted by any person invited to do so by the person in charge of the funeral. Clergymen of the Church of England are also by the act allowed, but are not obliged, to use the burial service in any unconsecrated burial ground or cemetery, or building therein, in any case in which it could be used in consecrated ground. In cases where it may not be so used, and where such is the wish of those in charge of the service, the clergy may use a form of service approved by the bishop without being liable to any ecclesiastical or temporal penalty. Except as altered by this act, it is still the law that "the Church knows no such indecency as putting a body into consecrated ground without the service being at the same time performed"; and nothing in the act authorizes the use of the service on the burial of a *felo de se*, which, however, may take place in any way allowed by the act of 1880. The proper performance of the burial office is provided for by the Public Worship Regulation Act 1874. Statutory provision is made by the criminal law in this act for the preservation of order in burial grounds and protection of funeral services.

3. Fees are now payable by custom or under statutory powers on all burials. In a churchyard the parson must perform the office of burial for parishioners, even if the customary fee is denied, and it is doubtful who is liable to pay it. The custom must be immemorial and invariable. If not disputed, its payment can be enforced in the ecclesiastical court; if disputed, its validity must be tried by a temporal court. A special contract for the payment of an annual fee in the case of a non-parishioner can be enforced in the latter court. In the case of paupers and shipwrecked persons the fees are payable by the parish. In other parochial burial grounds and cemeteries the duties and rights to fees of the incumbents, clerks and sextons of the parishes for which the ground has been provided are the same as in burials in the churchyard. Burial authorities may fix the fees payable in such grounds, subject to the approval of the home secretary; but the fees for services rendered by ministers of religion and sextons must be the same in the consecrated as in the unconsecrated part of the burial ground, and no incumbent of a parish or a clerk may receive any fee upon burials except for services rendered by them (act of 1900). On burials under the act of 1880 the same fees are payable as if the burial had taken place with the service of the Church.

4. A corpse is not the subject of property, nor capable of holding property. If interred in consecrated ground, it is under the protection of the ecclesiastical court; if in unconsecrated, it is under that of the temporal court. In the former case it is an ecclesiastical offence, and in either case it is a misdemeanour, to disinter or remove it without proper authority,

whatever the motive for such an act may be. Such proper authority is (1) a faculty from the ordinary, where it is to be removed from one consecrated place of burial to another, and this is often done on sanitary grounds or to meet the wishes of relatives, and has been done for secular purposes, e.g. widening a thoroughfare, by allowing part of the burial ground (disused) to be thrown into it; but it has been refused where the object was to cremate the remains, or to transfer them from a churchyard to a Roman Catholic burial ground; (2) a licence from the home secretary, where it is desired to transfer remains from one unconsecrated place of burial to another; (3) by order of the coroner, in cases of suspected crime. There has been considerable discussion as to the boundary line of jurisdiction between (1) and (2), and whether the disinterment of a body from consecrated ground for purposes of identification falls within (1) only or within both (1) and (2); and an attempt by the ecclesiastical court to enforce a penalty for that purpose without a licence has been prohibited by the temporal court.

See also CHURCHYARD; and, for methods of disposal of the dead, CEMETERY; CREMATION, and FUNERAL RITES.

AUTHORITIES.—Baker, *Law of Burials* (6th ed. by Thomas, London, 1898); Phillimore, *Ecclesiastical Law* (2nd ed., London, 1895); Cripps, *Law of Church and Clergy* (6th ed., London, 1886). (G. G. P.)

BURIAL SOCIETIES, a form of friendly societies, existing mainly in England, and constituted for the purpose of providing by voluntary subscriptions, for insuring money to be paid on the death of a member, or for the funeral expenses of the husband, wife or child of a member, or of the widow of a deceased member. (See FRIENDLY SOCIETIES.)

BURIATS, a Mongolian race, who dwell in the vicinity of the Baikal Lake, for the most part in the government of Irkutsk and the Trans-Baikal Territory. They are divided into various tribes or clans, which generally take their names from the locality they frequent. These tribes are subdivided according to kinship. The Buriats are a broad-shouldered race inclined to stoutness, with small slanting eyes, thick lips, high cheekbones, broad and flat noses and scanty beards. The men shave their heads and wear a pigtail like the Chinese. In summer they dress in silk and cotton gowns, in winter in furs and sheepskins. Their principal occupation is the rearing of cattle and horses. The Buriat horse is famous for its power of endurance, and the attachment between master and animal is very great. At death the horse should, according to their religion, be sacrificed at its owner's grave; but the frugal Buriat heir usually substitutes an old hack, or if he has to tie up the valuable steed to the grave to starve he does so only with the thinnest of cords so that the animal soon breaks his tether and gallops off to join the other horses. In some districts the Buriats have learned agriculture from the Russians, and in Irkutsk are really better farmers than the latter. They are extraordinarily industrious at manuring and irrigation. They are also clever at trapping and fishing. In religion the Buriats are mainly Buddhists; and their head lama (Khambo Lama) lives at the Goose Lake (Guisinoo Ozero). Others are Shamanists, and their most sacred spot is the Shamanic stone at the mouth of the river Angar. Some thousands of them around Lake Baikal are Christians. A knowledge of reading and writing is common, especially among the Trans-Baikal Buriats, who possess books of their own, chiefly translated from the Tibetan. Their own language is Mongolian, and of three distinct dialects. It was in the 16th century that the Russians first came in touch with the Buriats, who were long known by the name of Bratskiye, "Brotherly," given them by the Siberian colonists. In the town of Bratskiyostrog, which grew up around the block-house built in 1631 at the confluence of the Angara and Oka to bring them into subjection, this title is perpetuated. The Buriats made a vigorous resistance to Russian aggression, but were finally subdued towards the end of the 17th century, and are now among the most peaceful of Russian peoples.

See J. G. Gmelin, *Siberia*; Pierre Simon Pallas, *Sammlungen historischer Nachrichten über die mongolischen Völkerschaften* (St. Petersburg, 1776-1802); M. A. Castrén, *Versuch einer Burjatischen Sprachlehre* (1857); Sir H. H. Howorth, *History of the Mongols 1876-1886*.

BURIDAN, JEAN [JOANNES BURIDANUS] (c. 1297-c. 1358), French philosopher, was born at Béthune in Artois. He studied in Paris under William of Occam. He was professor of philosophy in the university of Paris, was rector in 1327, and in 1345 was deputed to defend its interests before Philip of Valois and at Rome. He was more than sixty years old in 1358, but the year of his death is not recorded. The tradition that he was forced to flee from France along with other nominalists, and founded the university of Vienna in 1356, is unsupported and in contradiction to the fact that the university was founded by Frederick II. in 1237. An ordinance of Louis XI., in 1473 directed against the nominalists, prohibited the reading of his works. In philosophy Buridan was a rationalist, and followed Occam in denying all objective reality to universals, which he regarded as mere words. The aim of his logic is represented as having been the devising of rules for the discovery of syllogistic middle terms; this system for aiding slow-witted persons became known as the *pons asinorum*. The parts of logic which he treated with most minuteness are modal propositions and modal syllogisms. In commenting on Aristotle's *Ethics* he dealt in a very independent manner with the question of free will, his conclusions being remarkably similar to those of John Locke. The only liberty which he admits is a certain power of suspending the deliberative process and determining the direction of the intellect. Otherwise the will is entirely dependent on the view of the mind, the last result of examination. The comparison of the will unable to act between two equally balanced motives to an ass dying of hunger between two equal and equidistant bundles of hay is not found in his works, and may have been invented by his opponents to ridicule his determinism. That he was not the originator of the theory known as "liberty of indifference" (*liberum arbitrium indifferentiae*) is shown in G. Fonsegrive's *Essai sur le libre arbitre*, pp. 119, 199 (1887).

His works are—*Summulae de dialectica* (Paris, 1487); *Compendium logicae* (Venice, 1489); *Questiones in viii. libros physicorum* (Paris, 1516); *In Aristotelis Metaphysica* (1518); *Questiones in 7 libris ethicorum Aristotelis* (Paris, 1489; Oxford, 1637); *Questiones in viii. libros politicorum Aristotelis* (1500). See K. Prantl's *Geschichte der Logik*, bk. iv. 14-38; Stöckl's *Geschichte der Philosophie des Mittelalters*, ii. 1023-1028; Herzog-Hauck, *Realencyclopädie*, xv. (1897).

BURKE, EDMUND (1729-1797), British statesman and political writer. His is one of the greatest names in the history of political literature. There have been many more important statesmen, for he was never tried in a position of supreme responsibility. There have been many more effective orators, for lack of imaginative suppleness prevented him from penetrating to the inner mind of his hearers; defects in delivery weakened the intrinsic persuasiveness of his reasoning; and he had not that commanding authority of character and personality which has so often been the secret of triumphant eloquence. There have been many subtler, more original and more systematic thinkers about the conditions of the social union. But no one that ever lived used the general ideas of the thinker more successfully to judge the particular problems of the statesman. No one has ever come so close to the details of practical politics, and at the same time remembered that these can only be understood and only dealt with by the aid of the broad conceptions of political philosophy. And what is more than all for perpetuity of fame, he was one of the great masters of the high and difficult art of elaborate composition.

A certain doubtfulness hangs over the circumstances of Burke's life previous to the opening of his public career. The very date of his birth is variously stated. The most probable opinion is that he was born at Dublin on the 12th of January 1729, new style. Of his family we know little more than his father was a Protestant attorney, practising in Dublin, and that his mother was a Catholic, a member of the family of Nagle. He had at least one sister, from whom descended the only existing representatives of Burke's family; and he had at least two brothers, Garret Burke and Richard Burke, the one older and the other younger than Edmund. The sister, afterwards Mrs French, was brought up and remained throughout life in the religious faith of her

mother; Edmund and his brothers followed that of their father. In 1741 the three brothers were sent to school at Ballitore in the county of Kildare, kept by Abraham Shackleton, an Englishman, and a member of the Society of Friends. He appears to have been an excellent teacher and a good and pious man. Burke always looked back on his own connexion with the school at Ballitore as among the most fortunate circumstances of his life. Between himself and a son of his instructor there sprang up a close and affectionate friendship, and, unlike so many of the exquisite attachments of youth, this was not choked by the just of life, nor parted by divergence of pursuit. Richard Shackleton was endowed with a grave, pure and tranquil nature, constant and austere, yet not without those gentle elements that often redeem the drier qualities of his religious persuasion. When Burke had become one of the most famous men in Europe, a visitor to his house was more welcome than the friend with whom long years before he had tried poetic flights, and exchanged all the sanguine confidences of boyhood. And we are touched to think of the simple-minded guest secretly praying, in the solitude of his room in the fine house at Beaconsfield, that the ay of his anxious and overburdened host might be guided by divine hand.

In 1743 Burke became a student at Trinity College, Dublin, where liver Goldsmith was also a student at the same time. But the rious pupil of Abraham Shackleton would not be likely to see uch of the wild and squalid sizar. Henry Flood, who was two ars younger than Burke, had gone to complete his education Oxford. Burke, like Goldsmith, achieved no academic distinction. His character was never at any time of the academic st. The minor accuracies, the limitation of range, the treading d re-treading of the same small patch of ground, the concentration of interest in success before a board of examiners, re all uncongenial to a nature of exuberant intellectual ossity and of strenuous and self-reliant originality. His wledge of Greek and Latin was never thorough, nor had he r turn for critical niceties. He could quote Homer and ar, and he had read Aristotle. Like others who have gone ough the conventional course of instruction, he kept a place his memory for the various charms of Virgil and Horace, of itus and Ovid; but the master whose page by night and by he turned with devout hand, was the copious, energetic, ible, diversified and brilliant genius of the declamations for has the poet and for Milo, against Catiline and against ony, the author of the disputations at Tusculum and the ions against Verres. Cicero was ever to him the mightiest he ancient names. In English literature Milton seems to e been more familiar to him than Shakespeare, and Spenser perhaps more of a favourite with him than either.

is too often the case to be a mere accident that men who me eminent for wide compass of understanding and pening comprehension, are in their adolescence unsettled and litory. Of this Burke is a signal illustration. He left ity in 1748, with no great stock of well-ordered knowledge. either derived the benefits nor suffered the drawbacks of :matic intellectual discipline.

er taking his degree at Dublin he went in the year 1750 ondon to keep terms at the Temple. The ten years that wed were passed in obscure industry Burke was always rely reserved about his private affairs. All that we know rke exhibits him as inspired by a resolute pride, a certain liness and imperious elevation of mind. Such a character, : free from any weak shame about the shabby necessities of struggles, yet is naturally unwilling to make them pron- in after life. There is nothing dishonourable in such an ation. "I was not swaddled and rocked and dandled into a ator," wrote Burke when very near the end of his days: or in *adversum* is the motto for a man like me. At every of my progress in life (for in every step I was traversed opposed), and at every turnpike I met, I was obliged ow my passport. Otherwise no rank, no toleration even, e."

sorts of whispermongers have been circulated by idle or malicious

gossip about Burke's first manhood. He is said to have been one of the numerous lovers of his fascinating countrywoman, Margaret Woffington. It is hinted that he made a mysterious visit to the American colonies. He was for years accused of having gone over to the Church of Rome, and afterwards recanting. There is not a tittle of positive evidence for these or any of the other statements to Burke's discredit. The common story that he was a candidate for Adam Smith's chair of moral philosophy at Glasgow, when Hume was rejected in favour of an obscure nobody (1751), can be shown to be wholly false. Like a great many other youths with an eminent destiny before them, Burke conceived a strong distaste for the profession of the law. His father, who was an attorney of substance, had a distaste still stronger for so vagrant a profession as letters were in that day. He withdrew the annual allowance, and Burke set to work to win for himself by indefatigable industry and capability in the public interest that position of power or pre-eminence which his detractors acquired either by accident of birth and connexions or else by the vile arts of political intrigue. He began at the bottom of the ladder, mixing with the Bohemian society that haunted the Temple, practising oratory in the free and easy debating societies of Covent Garden and the Strand, and writing for the booksellers.

In 1756 he made his first mark by a satire upon Bolingbroke entitled *A Vindication of Natural Society*. It purported to be a posthumous work from the pen of Bolingbroke, and to present a view of the miseries and evils arising to mankind from every species of artificial society. The imitation of the fine style of that magnificent writer but bad patriot is admirable. As a satire the piece is a failure, for the simple reason that the substance of it might well pass for a perfectly true, no less than a very eloquent statement of social blunders and calamities. Such acute critics as Chesterfield and Warburton thought the performance serious. Rousseau, whose famous discourse on the evils of civilization had appeared six years before, would have read Burke's ironical vindication of natural society without a suspicion of its irony. There have indeed been found persons who insist that the *Vindication* was a really serious expression of the writer's own opinions. This is absolutely incredible, for various reasons. Burke felt now, as he did thirty years later, that civil institutions cannot wisely or safely be measured by the tests of pure reason. His sagacity discerned that the rationalism by which Bolingbroke and the deistic school believed themselves to have overthrown revealed religion, was equally calculated to undermine the structure of political government. This was precisely the actual course on which speculation was entering in France at that moment. His *Vindication* is meant to be a reduction to an absurdity. The rising revolutionary school in France, if they had read it, would have taken it for a demonstration of the theorem to be proved. The only interest of the piece for us lies in the proof which it furnishes, that at the opening of his life Burke had the same scornful antipathy to political rationalism which flamed out in such overwhelming passion at his close.

In the same year (1756) appeared the *Philosophical Inquiry into the Origin of our Ideas on the Sublime and Beautiful*, a crude and narrow performance in many respects, yet marked by an independent use of the writer's mind, and not without fertile suggestion. It attracted the attention of the rising aesthetic school in Germany. Lessing set about the translation and annotation of it, and Moses Mendelssohn borrowed from Burke's speculation at least one of the most fruitful and important ideas of his own influential theories on the sentiments. In England the *Inquiry* had considerable vogue, but it has left no permanent trace in the development of aesthetic thought.

Burke's literary industry in town was relieved by frequent excursions to the western parts of England, in company with William Burke. There was a lasting intimacy between the two namesakes, and they seem to have been involved together in some important passages of their lives; but we have Edmund Burke's authority for believing that they were probably not kinsmen. The seclusion of these rural sojourns, originally dictated by delicate health, was as wholesome to the mind as to

the body. Few men, if any, have ever acquired a settled mental habit of surveying human affairs broadly, of watching the play of passion, interest, circumstance, in all its comprehensiveness, and of applying the instruments of general conceptions and wide principles to its interpretation with respectable constancy, unless they have at some early period of their manhood resolved the greater problems of society in independence and isolation. By 1756 the cast of Burke's opinions was decisively fixed, and they underwent no radical change.

He began a series of *Hints on the Drama*. He wrote a portion of an *Abridgment of the History of England*, and brought it down as far as the reign of John. It included, as was natural enough in a warm admirer of Montesquieu, a fragment on law, of which he justly said that it ought to be the leading science in every well-ordered commonwealth. Burke's early interest in America was shown by an *Account of the European Settlements* on that continent. Such works were evidently a sign that his mind was turning away from abstract speculation to the great political and economic fields, and to the more visible conditions of social stability and the growth of nations. This interest in the concrete phenomena of society inspired him with the idea of the *Annual Register* (1759), which he designed to present a broad grouping of the chief movements of each year. The execution was as excellent as the conception, and if we reflect that it was begun in the midst of that momentous war which raised England to her climax of territorial greatness in East and West, we may easily realize how the task of describing these portentous and far-reaching events would be likely to strengthen Burke's habits of wide and laborious observation, as well as to give him firmness and confidence in the exercise of his own judgment. Dodsley gave him £100 for each annual volume, and the sum was welcome enough, for towards the end of 1756 Burke had married. His wife was the daughter of a Dr Nugent, a physician at Bath. She is always spoken of by his friends as a mild, reasonable and obliging person, whose amiability and gentle sense did much to soothe the too nervous and excitable temperament of her husband. She had been brought up, there is good reason to believe, as a Catholic, and she was probably a member of that communion at the time of her marriage. Dr Nugent eventually took up his residence with his son-in-law in London, and became a popular member of that famous group of men of letters and artists whom Boswell has made so familiar and so dear to all later generations. Burke, however, had no intention of being dependent. His consciousness of his own powers animated him with a most justifiable ambition, if ever there was one, to play a part in the conduct of national affairs. Friends shared this ambition on his behalf; one of these was Lord Charlemont. He introduced Burke to William Gerard Hamilton (1759), now only remembered by the nickname "single-speech," derived from the circumstance of his having made a single brilliant speech in the House of Commons, which was followed by years of almost unbroken silence. Hamilton was by no means devoid of sense and acuteness, but in character he was one of the most despicable men then alive. There is not a word too many nor too strong in the description of him by one of Burke's friends, as "a sullen, vain, proud, selfish, cankered-hearted, envious reptile." The reptile's connexion, however, was for a time of considerable use to Burke. When he was made Irish secretary, Burke accompanied him to Dublin, and there learnt Oxenstiern's eternal lesson, that awaits all who penetrate behind the scenes of government, *quam parvo sapientia mundus regitur*.

The penal laws against the Catholics, the iniquitous restrictions on Irish trade and industry, the selfish factiousness of the parliament, the jobbery and corruption of administration, the absenteeism of the landlords, and all the other too familiar elements of that mischievous and fatal system, were then in full force. As was shown afterwards, they made an impression upon Burke that was never effaced. So much iniquity and so much disorder may well have struck deep on one whose two chief political sentiments were a passion for order and a passion for justice. He may have anticipated with something of remorse the reflection of a modern historian, that the absenteeism of

her landlords has been less of a curse to Ireland than the absenteeism of her men of genius. At least he was never an absentee in his heart. He always took the interest of an ardent patriot in his unfortunate country; and, as we shall see, made more than one weighty sacrifice on behalf of the principles which he deemed to be bound up with her welfare.

When Hamilton retired from his post, Burke accompanied him back to London, with a pension of £300 a year on the Irish Establishment. This modest allowance he hardly enjoyed for more than a single year. His patron having discovered the value of so laborious and powerful a subaltern, wished to bind Burke permanently to his service. Burke declined to sell himself into final bondage of this kind. When Hamilton continued to press his odious pretensions they quarrelled (1765), and Burke threw up his pension. He soon received a more important piece of preferment than any which he could ever have procured through Hamilton.

The accession of George III. to the throne in 1760 had been followed by the disgrace of Pitt, the dismissal of Newcastle, and the rise of Bute. These events marked the resolution of the court to change the political system which had been created by the Revolution of 1688. That system placed the government of the country in the hands of a territorial oligarchy, composed of a few families of large possessions, fairly enlightened principles, and shrewd political sense. It had been preserved by the existence of a Pretender. The two first kings of the house of Hanover could only keep the crown on their own heads by conciliating the Revolution families and accepting Revolution principles. By 1760 all peril to the dynasty was at an end. George III., or those about him, insisted on substituting for the aristocratic division of political power a substantial concentration of it in the hands of the sovereign. The ministers were no longer to be the members of a great party, acting together in pursuance of a common policy accepted by them all as a united body; they were to become nominees of the court, each holding himself answerable not to his colleagues but to the king, separately, individually and by department. George III. had before his eyes the government of his cousin the great Frederick; but not every one can bend the bow of Ulysses, and, apart from difference of personal capacity and historic tradition, he forgot that a territorial and commercial aristocracy cannot be dealt with in the spirit of the barrack and the drill-ground. But he made the attempt, and resistance to that attempt supplies the key-note to the first twenty-five years of Burke's political life.

Along with the change in system went high-handed and absolutist tendencies in policy. The first stage of the new experiment was very short. Bute, in a panic at the storm of unpopularity that menaced him, resigned in 1763. George Grenville and the less enlightened section of the Whigs took his place. They proceeded to tax the American colonists, to interpose vexatiously against their trade, to threaten the liberty of the subject at home by general warrants, and to stifle the liberty of public discussion by prosecutions of the press. Their arbitrary methods disgusted the nation, and the personal arrogance of the ministers at last disgusted the king. The system received a temporary check. Grenville fell, and the king was forced to deliver himself into the hands of the orthodox section of the Whigs. The marquis of Rockingham (July 10, 1765) became prime minister, and he was induced to make Burke his private secretary. Before Burke had begun his duties, an incident occurred which illustrates the character of the two men. The old duke of Newcastle, probably desiring a post for some nominee of his own, conveyed to the ear of the new minister various absurd rumours prejudicial to Burke,—that he was an Irish papist, that his real name was O'Bourke, that he had been a Jesuit, that he was an emissary from St Omer's. Lord Rockingham repeated these tales to Burke, who of course denied them with indignation. His chief declared himself satisfied, but Burke, from a feeling that the indispensable confidence between them was impaired, at once expressed a strong desire to resign his post. Lord Rockingham prevailed upon him to reconsider his resolve, and from that day until Lord Rockingham's death in

82, their relations were those of the closest friendship and affection.

The first Rockingham administration only lasted a year and six days, ending in July 1766. The uprightness and goodness of its leaders did not compensate for the weakness of their political connexions. They were unable to stand against the wishes of the king, against the hostility of the powerful and influential faction of Bedford Whigs, and, above all, against the ruling predominance of William Pitt. That Pitt did not join in one of the many fatal miscarriages of history, as it is one of the many serious reproaches to be made against an extraordinary man's chequered and uneven course. An alliance between Pitt and the Rockingham party was the surest step of a wise and liberal policy towards the colonies. Not further than they did, in holding, like Lord Camden, the view that taxation went with representation, and that the parliament had no right to tax the unrepresented colonies. The ministry asserted, what no competent jurist would think of denying, that parliament is sovereign; and went heartily with Pitt in pronouncing the exercise of taxation in the case of the American colonists thoroughly impolitic and inexpedient. No practical objection, therefore, existed upon the important question. But Pitt's prodigious egoism, stimulated by the flattery of the numerous counsels of men of the stamp of Lord Shelburne, and the fusion of the only two sections of the Whig party: at once able, enlightened and disinterested enough upon the government efficiently, to check the arbitrary will of the king, and to command the confidence of the people, such an opportunity did not return.

Ministerial policy towards the colonies was defended with splendour and unanswerable eloquence. He returned to the House of Commons for the pocket of Wendover, and his first speech (January 27, 1766) was the rising of a new light. For the space of a quarter of a century, from this time down to 1790, Burke was one of the chief and inspirers of a revived Whig party. The "age of reason" was now succeeded by an age of great princely ties of mere families and persons were transacted on a union resting on common conviction and patriotic sentiment. Burke who did more than any one else to give to the nation, under the first half of the reign of George III., an elevation and grandeur. Before leaving office the Rockingham government repealed the Stamp Act; secured personal liberty of the subject by forcing on the ministry one resolution against general warrants, against the seizure of papers; and relieved private property from the intrusion of officers of excise, by repealing the duties which had been done in an English parliament in many years to come. George Grenville, whom he had displaced, and who was bitterly incensed at the reversal of his policy, printed a pamphlet to demonstrate his wisdom and statesmanship. Burke replied in his *late Publication on the Present State of the Nation* in which he showed for the first time that he had a profound knowledge of commerce and finance, and as dealing with figures as Grenville himself, but in a general and luminous way of conceiving and in which neither then nor since has he had any English publicists.

He perplexed points in Burke's private history lived during these long years of parliamentary certainly not altogether mere impertinence to man how he gets what he lives upon, for indeed, which is so hard to the man who lays his head low, is the prime virtue in such men. Probity redly one of the keys to character, though careful in ascertaining and proportioning all. Now, in 1769, Burke bought an estate at the county of Buckingham. It was about 600 acres worth some £500 a year, and cost £22,000, asking ever since how the penniless man of

letters was able to raise so large a sum in the first instance, and how he was able to keep up a respectable establishment afterwards. The suspicions of those who are never sorry to disparage the great have been of various kinds. Burke was a gambler, they hint, in Indian stock, like his kinsmen Richard and William, and like Lord Verney, his political patron at Wendover. Perhaps again, his activity on behalf of Indian princes, like the raja of Tanjore, was not disinterested and did not go unrewarded. The answer to all these calumnious innuendoes is to be found in documents and title-deeds of decisive authority, and is simple enough. It is, in short, this. Burke inherited a small property from his elder brother, which he realized. Lord Rockingham advanced him a certain sum (£6000). The remainder, amounting to no less than two-thirds of the purchase-money, was raised on mortgage, and was never paid off during Burke's life. The rest of the story is equally simple, but more painful. Burke made some sort of income out of his 600 acres, he was for a short time agent for New York, with a salary of £700; he continued to work at the *Annual Register* down to 1788. But, when all is told, he never made as much as he spent; and in spite of considerable assistance from Lord Rockingham, amounting it is sometimes said to as much as £30,000, Burke, like the younger Pitt, got every year deeper into debt. Pitt's debts were the result of a wasteful indifference to his private affairs. Burke, on the contrary, was assiduous and orderly, and had none of the vices of profusion. But he had that quality which Aristotle places high among the virtues—the noble mean of Magnificence, standing midway between the two extremes of vulgar ostentation and narrow pettiness. He was indifferent to luxury, and sought to make life, not commodious nor soft, but high and dignified in a refined way. He loved art, filled his house with statues and pictures, and extended a generous patronage to the painters. He was a collector of books, and, as Crabbe and less conspicuous men discovered, a helpful friend to their writers. Guests were ever welcome at his board; the opulence of his mind and the fervid copiousness of his talk naturally made the guests of such a man very numerous. *Non invidios equidem, miror magis*, was Johnson's good-natured remark, when he was taken over his friend's fine house and pleasant gardens. Johnson was of a very different type. There was something in this external dignity which went with Burke's imperious spirit, his spacious imagination, his turn for all things stately and imposing. We may say, if we please, that Johnson had the far truer and loftier dignity of the two; but we have to take such men as Burke with the defects that belong to their qualities. And there was no corruption in Burke's outlay. When the Pitt administration was formed in 1766, he might have had office, and Lord Rockingham wished him to accept it, but he honourably took his fate with the party. He may have spent £3000 a year, where he would have been more prudent to spend only £2000. But nobody was wronged; his creditors were all paid in time, and his hands were at least clean of traffic in reversions, clerkships, telerhips and all the rest of the rich sinecures which it was thought no shame in those days for the aristocracy of the land and the robe to wrangle for, and gorge themselves upon, with the fierce voracity of famishing wolves. The most we can say is that Burke, like Pitt, was too deeply absorbed in beneficent service in the affairs of his country, to have for his own affairs the solicitude that would have been prudent.

In the midst of intense political preoccupations, Burke always found time to keep up his intimacy with the brilliant group of his earlier friends. He was one of the commanding figures at the club at the Turk's Head, with Reynolds and Garrick, Goldsmith and Johnson. The old sage who held that the first Whig was the Devil, was yet compelled to forgive Burke's politics for the sake of his magnificent gifts. "I would not talk to him of the Rockingham party," he used to say, "but I love his knowledge, his genius, his diffusion and affluence of conversation." And everybody knows Johnson's vivid account of him: "Burke, Sir, is such a man that if you met him for the first time in the street, where you were stopped by a drove of oxen, and you and he stepped aside to take shelter but for five minutes, he'd talk

to you in such a manner that when you parted you would say, "This is an extraordinary man." They all grieved that public business should draw to party what was meant for mankind. They deplored that the nice and difficult test of answering Berkeley had not been undertaken, as was once intended, by Burke, and sighed to think what an admirable display of subtlety and brilliance such a contention would have afforded them, had not politics "turned him from active philosophy aside." There was no jealousy in this. They did not grudge Burke being the first man in the House of Commons, for they admitted that he would have been the first man anywhere.

With all his hatred for the book-man in politics, Burke owed much of his own distinction to that generous richness and breadth of judgment which had been ripened in him by literature and his practice in it. He showed that books are a better preparation for statesmanship than early training in the subordinate posts and among the permanent officials of a public department. There is no copiousness of literary reference in his work, such as over-abounded in the civil and ecclesiastical publicists of the 17th century. Nor can we truly say that there is much, though there is certainly some, of that tact which literature is alleged to confer on those who approach it in a just spirit and with the true gift. The influence of literature on Burke lay partly in the direction of emancipation from the mechanical formulæ of practical politics; partly in the association which it engendered, in a powerful understanding like his, between politics and the moral forces of the world, and between political maxims and the old and great sentences of morals; partly in drawing him, even when resting his case on prudence and expediency, to appeal to the widest and highest sympathies; partly, and more than all, in opening his thoughts to the many conditions, possibilities and "varieties of untried being," in human character and situation, and so giving an incomparable flexibility to his methods of political approach.

This flexibility is not to be found in his manner of composition. That derives its immense power from other sources; from passion, intensity, imagination, size, truth, cogency of logical reason. Those who insist on charm, on winningness in style, on subtle harmonies and fine exquisiteness of suggestion, are disappointed in Burke: they even find him stiff and over-coloured. And there are blemishes of this kind. His banter is nearly always ungainly, his wit blunt, as Johnson said, and often unseasonable. As is usual with a man who has not true humour, Burke is also without true pathos. The thought of wrong or misery moved him less to pity for the victim than to anger against the cause. Again, there are some gratuitous and unredeemed vulgarities; some images that make us shudder. But only a literary fop can be detained by specks like these.

The varieties of Burke's literary or rhetorical method are very striking. It is almost incredible that the superb imaginative amplification of the description of Hyder Ali's descent upon the Carnatic should be from the same pen as the grave, simple, unadorned *Address to the King* (1777), where each sentence falls on the ear with the accent of some golden-tongued oracle of the wise gods. His stride is the stride of a giant, from the sentimental beauty of the picture of Marie Antoinette at Versailles, or the red horror of the tale of Debi Sing in Rungpore, to the learning, positiveness and cool judicial mastery of the *Report on the Lords' Journals* (1794), which Philip Francis, no mean judge, declared on the whole to be the "most eminent and extraordinary" of all his productions. But even in the coolest and driest of his pieces there is the mark of greatness, of grasp, of comprehension. In all its varieties Burke's style is noble, earnest, deep-flowing, because his sentiment was lofty and fervid, and went with sincerity and ardent disciplined travail of judgment. He had the style of his subjects; the amplitude, the weightiness, the laboriousness, the sense, the high flight, the grandeur, proper to a man dealing with imperial themes, with the fortunes of great societies, with the sacredness of law, the freedom of nations, the justice of rulers. Burke will always be read with delight and edification, because in the midst of discussions on the local and the accidental, he scatters apophthegms that take us into

the regions of lasting wisdom. In the midst of the torrent of his most strenuous and passionate deliverances, he suddenly rises aloof from his immediate subject, and in all tranquillity reminds us of some permanent relation of things, some enduring truth of human life or human society. We do not hear the organ tones of Milton, for faith and freedom had other notes in the 18th century. There is none of the complacent and wise-browed sagacity of Bacon, for Burke's were days of personal strife and fire and civil division. We are not exhilarated by the cheerfulness, the polish, the fine manners of Bolingbroke, for Burke had an anxious conscience, and was earnest and intent that the good should triumph. And yet Burke is among the greatest of those who have wrought marvels in the prose of our English tongue.

Not all the transactions in which Burke was a combatant could furnish an imperial theme. We need not tell over again the story of Wilkes and the Middlesex election. The Rockingham ministry had been succeeded by a composite government, of which it was intended that Pitt, now made Lord Chatham and privy seal, should be the real chief. Chatham's health and mind fell into disorder almost immediately after the ministry had been formed. The duke of Grafton was its nominal head, but party ties had been broken, the political connexions of the ministers were dissolved, and, in truth, the king was now at last a king indeed, who not only reigned but governed. The revival of high doctrines of prerogative in the crown was accompanied by a revival of high doctrines of privilege in the House of Commons, and the ministry was so smitten with weakness and confusion as to be unable to resist the current of arbitrary policy, and not many of them were even willing to resist it. The unconstitutional prosecution of Wilkes was followed by the fatal recourse to new plans for raising taxes in the American colonies. These two points made the rallying ground of the new Whig opposition. Burke helped to smooth matters for a practical union between the Rockingham party and the powerful triumvirate, composed of Chatham, whose understanding had recovered from its late disorder, and of his brothers-in-law, Lord Temple and George Grenville. He was active in urging petitions from the freeholders of the counties, protesting against the unconstitutional invasion of the right of election. And he added a durable masterpiece to political literature in a pamphlet which he called *Thoughts on the Cause of the Present Discontents* (1770). The immediate object of this excellent piece was to hold up the court scheme of weak, divided and dependent administrations in the light of its real purpose and design; to describe the distempers which had been engendered in parliament by the growth of royal influence and the faction of the king's friends; to show that the newly formed Whig party had combined for truly public ends, and was no mere family knot like the Grenvilles and the Bedfords; and, finally, to press for the hearty concurrence both of public men and of the nation at large in combining against "a faction ruling by the private instructions of a court against the general sense of the people." The pamphlet was disliked by Chatham on the one hand, on no reasonable grounds that we can discover; it was denounced by the extreme popular party of the Bill of Rights, on the other hand, for its moderation and conservatism. In truth, there is as strong a vein of conservative feeling in the pamphlet of 1770 as in the more resplendent pamphlet of 1790. "Our constitution," he said, "stands on a nice equivoise, with steep precipices and deep waters upon all sides of it. In removing it from a dangerous leaning towards one side, there may be a risk of upsetting it on the other. Every project of a material change in a government so complicated as ours is a matter full of difficulties; in which a considerate man will not be too ready to decide, a prudent man too ready to undertake, or an honest man too ready to promise." Neither now nor ever had Burke any other real conception of a polity for England than government by the territorial aristocracy in the interests of the nation at large, and especially in the interests of commerce, to the vital importance of which in our economy he was always keenly and wisely alive. The policy of George III., and the support which it found among

a who were weary of Whig factions, disturbed this scheme, therefore Burke denounced both the court policy and the party with all his heart and all his strength.

eloquence and good sense, however, were impotent in the such forces as were at this time arrayed against a government on once strong and liberal. The court was confident that on between Chatham and the Rockinghams was impossible. union was in fact hindered by the waywardness and the d pretences of Chatham, and the want of force in Lord ingham. In the nation at large, the late violent ferment en followed by as remarkable a deadness and vapidity, urke himself had to admit a year or two later that any table robbery at Hounslow Heath would make more sation than all the disturbances of America. The duke fton went out, and Lord North became the head of a ment, which lasted twelve years (1770-1782), and brought more than all the disasters that Burke had foretold as vailable issue of the royal policy. For the first six years lamentable period Burke was actively employed in ing, informing and guiding the patrician chiefs of his "Indeed, Burke," said the duke of Richmond, "you re merit than any man in keeping us together." They l-meaning and patriotic men, but it was not always eas em to prefer politics to fox-hunting. When he reached ags at night after a day in the city or a skirmish in the Commons, Burke used to find a note from the duke of d or the marquess of Rockingham, praying him to draw to be entered on the Journals of the Lords, and in fact ll the principal protests of his party between 1767 and e accession of Charles James Fox to the Whig party, k place at this time, and was so important an event ory, was mainly due to the teaching and influence of n the House of Commons his industry was almost

He was taxed with speaking too often, and with forward. And he was mortified by a more serious a murmurs about superfluity of zeal. Men said and that he was Junius. His very proper unwillingness deny an accusation, that would have been so dis- it had been true, made ill-natured and silly people nvinced that it was not wholly false. But whatever world may have thought of him, Burke's energy and character impressed the better minds in the country. eceived the great distinction of being chosen as one entatives by Bristol, then the second town in the

its which ended in the emancipation of the American the monarchy, Burke's political genius shone with that was worthy of the great affairs over which it ificent an illumination. His speeches are almost ment of the struggle on which a lover of English look back with pride and a sense of worthiness, chman feels when he reads Bossuet, or an Anglican over the pages of Taylor or of Hooker. Burke's ese high transactions is really more impressive 's, because he was far less theatrical than Chatham; as no less nobly passionate for freedom and justice, as was found the most strenuous political argumenta- g reason of state. On the other hand he was n that quality which he ascribed to Lord George n "apt to take a sort of undecided, equivocal, that evades the substantial merits of the question, hole upon some temporary, local, accidental or ration." He rose to the full height of that great ke here and everywhere else displayed the rare ument with generalities, and yet never intruding No publicist who deals as largely in general ever been as free from truisms; no one has ever mes with so much elevation, and yet been so gainst the pitfalls of emptiness and the vague. ive to compare the foundation of all his pleas ith that on which they erected their own theo- of independence. The American leaders were

impregnated with the metaphysical ideas of rights which had come to them from the rising revolutionary school in France. Burke no more adopted the doctrines of Jefferson in 1776 than he adopted the doctrines of Robespierre in 1793. He says nothing about men being born free and equal, and on the other hand he never denies the position of the court and the country at large, that the home legislature, being sovereign, had the right to tax the colonies. What he does say is that the exercise of such a right was not practicable; that if it were practicable, it was inexpedient; and that, even if this had not been inexpedient, yet, after the colonies had taken to arms, to crush their resistance by military force would not be more disastrous to them than it would be unfortunate for the ancient liberties of Great Britain. Into abstract discussion he would not enter. "Show the thing you contend for to be reason; show it to be common sense; show it to be the means of attaining some useful end." "The question with me is not whether you have a right to render your people miserable, but whether it is not your interest to make them happy." There is no difference in social spirit and doctrine between his protests against the maxims of the English common people as to the colonists, and his protests against the maxims of the French common people as to the court and the nobles; and it is impossible to find a single principle either asserted or implied in the speeches on the American revolution which was afterwards repudiated in the writings on the revolution in France.

It is one of the signs of Burke's singular and varied eminence that hardly any two people agree precisely which of his works to mark as the masterpiece. Every speech or tract that he composed on a great subject becomes, as we read it, the rival of every other. But the *Speech on Conciliation* (1775) has, perhaps, been more universally admired than any of his other productions, partly because its maxims are of a simpler and less disputable kind than those which adorn the pieces on France, and partly because it is most strongly characterized by that deep ethical quality which is the prime secret of Burke's great style and literary mastery. In this speech, moreover, and in the only less powerful one of the preceding year upon American taxation, as well as in the *Letter to the Sheriffs of Bristol* in 1777, we see the all-important truth conspicuously illustrated that half of his eloquence always comes of the thoroughness with which he gets up his case. No eminent man has ever done more than Burke to justify the definition of genius as the consummation of the faculty of taking pains. Labour incessant and intense, if it was not the source, was at least an inseparable condition of his power. And magnificent rhetorician though he was, his labour was given less to his diction than to the facts; his heart was less in the form than the matter. It is true that his manuscripts were blotted and smeared, and that he made so many alterations in the proofs that the printer found it worth while to have the whole set up in type afresh. But there is no polish in his style, as in that of Junius for example, though there is something a thousand times better than polish. "Why will you not allow yourself to be persuaded," said Francis after reading the *Reflections*, "that polish is material to preservation?" Burke always accepted the rebuke, and flung himself into vindication of the sense, substance and veracity of what he had written. His writing is magnificent, because he knew so much, thought so comprehensively, and felt so strongly.

The succession of failures in America, culminating in Cornwallis's surrender at Yorktown in October 1781, wearied the nation, and at length the persistent and powerful attacks of the opposition began to tell. "At this time," wrote Burke, in words of manly self-assertion, thirteen years afterwards, "having a momentary lead (1780-1782), so aided and so encouraged, and as a feeble instrument in a mighty hand—I do not say I saved my country—I am sure I did my country important service. There were few indeed at that time that did not acknowledge it. It was but one voice, that no man in the kingdom better deserved an honourable provision should be made for him." In the spring of 1782 Lord North resigned. It seemed as if the court system which Burke had been denouncing

for a dozen years was now finally broken, and as if the party which he had been the chief instrument in instructing, directing and keeping together must now inevitably possess power for many years to come. Yet in a few months the whole fabric had fallen, and the Whigs were thrown into opposition for the rest of the century. The story cannot be omitted in the most summary account of Burke's life. Lord Rockingham came into office on the fall of North. Burke was rewarded for services beyond price by being made paymaster of the forces, with the rank of a privy councillor. He had lost his seat for Bristol two years before, in consequence of his courageous advocacy of a measure of tolerance for the Catholics, and his still more courageous exposure of the enormities of the commercial policy of England towards Ireland. He sat during the rest of his parliamentary life (to 1794) for Malton, a pocket borough first of Lord Rockingham's, then of Lord Fitzwilliam's. Burke's first tenure of office was very brief. He had brought forward in 1780 a comprehensive scheme of economical reform, with the design of limiting the resources of jobbery and corruption which the crown was able to use to strengthen its own sinister influence in parliament. Administrative reform was, next to peace with the colonies, the part of the scheme of the new ministry to which the king most warmly objected. It was carried out with greater moderation than had been foreshadowed in opposition. But at any rate Burke's own office was not spared. While Charles Fox's father was at the pay-office (1765-1778) he realized as the interest of the cash balances which he was allowed to retain in his hands, nearly a quarter of a million of money. When Burke came to this post the salary was settled at £4000 a year. He did not enjoy the income long. In July 1782 Lord Rockingham died; Lord Shelburne took his place; Fox, who inherited from his father a belief in Lord Shelburne's duplicity, which his own experience of him as a colleague during the last three months had made stronger, declined to serve under him. Burke, though he had not encouraged Fox to take this step, still with his usual loyalty followed him out of office. This may have been a proper thing to do if their distrust of Shelburne was incurable, but the next step, coalition with Lord North against him, was not only a political blunder, but a shock to party morality, which brought speedy retribution. Either they had been wrong, and violently wrong, for a dozen years, or else Lord North was the guiltiest political instrument since Strafford. Burke attempted to defend the alliance on the ground of the substantial agreement between Fox and North in public aims. The defence is wholly untenable. The Rockingham Whigs were as substantially in agreement on public affairs with the Shelburne Whigs as they were with Lord North. The movement was one of the worst in the history of English party. It served its immediate purpose, however, for Lord Shelburne found himself (February 24, 1783) too weak to carry on the government, and was succeeded by the members of the coalition, with the duke of Portland for prime minister (April 2, 1783). Burke went back to his old post at the pay-office and was soon engaged in framing and drawing the famous India Bill. This was long supposed to be the work of Fox, who was politically responsible for it. We may be sure that neither he nor Burke would have devised any government for India which they did not honestly believe to be for the advantage both of that country and of England. But it cannot be disguised that Burke had thoroughly persuaded himself that it was indispensable in the interests of English freedom to strengthen the party hostile to the court. As we have already said, dread of the peril to the constitution from the new aims of George III. was the main inspiration of Burke's political action in home affairs for the best part of his political life. The India Bill strengthened the anti-court party by transferring the government of India to seven persons named in the bill, and neither appointed nor removable by the crown. In other words, the bill gave the government to a board chosen directly by the House of Commons; and it had the incidental advantage of conferring on the ministerial party patronage valued at £300,000 a year, which would remain for a fixed term of years out of reach of the king. In a word, judging the India Bill from a party point of view, we see that Burke was

now completing the aim of his project of economic reform. That measure had weakened the influence of the crown by limiting its patronage. The measure for India weakened the influence of the crown by giving a mass of patronage to the party which the king hated. But this was not to be. The India Bill was thrown out by means of a royal intrigue in the Lords, and the ministers were instantly dismissed (December 18, 1783). Young William Pitt, then only in his twenty-fifth year, had been chancellor of the exchequer in Lord Shelburne's short ministry, and had refused to enter the coalition government from an honourable repugnance to join Lord North. He was now made prime minister. The country in the election of the next year ratified the king's judgment against the Portland combination and the hopes which Burke had cherished for a political lifetime were irretrievably ruined.

The six years that followed the great rout of the orthodox Whigs were years of repose for the country, but it was now that Burke engaged in the most laborious and formidable enterprise of his life, the impeachment of Warren Hastings for high crimes and misdemeanours in his government of India. His interest in that country was of old date. It arose partly from the fact of William Burke's residence there, partly from his friendship with Philip Francis, but most of all, we suspect, from the effect which he observed Indian influence to have in demoralizing the House of Commons. "Take my advice for once in your life," Francis wrote to Shee; "lay aside 40,000 rupees for a seat in parliament: in this country that alone makes all the difference between somebody and nobody." The relations, moreover, between the East India Company and the government were of the most important kind, and occupied Burke's closest attention from the beginning of the American war down to his own India Bill and that of Pitt and Dundas. In February 1785 he delivered one of the most famous of all his speeches, that on the nabob of Arcot's debts. The real point of this superb declamation was Burke's conviction that ministers supported the claims of the fraudulent creditors in order to secure the corrupt advantages of a sinister parliamentary interest. His proceedings against Hastings had a deeper spring. The story of Hastings's crimes, as Macaulay says, made the blood of Burke boil in his veins. He had a native abhorrence of cruelty, of injustice, of disorder, of oppression, of tyranny, and all these things in all their degrees marked Hastings's course in India. They were, moreover, concentrated in individual cases, which exercised Burke's passionate imagination to its profoundest depths, and raised it to such a glow of fiery intensity as has never been rivalled in our history. For it endured for fourteen years, and was just as burning and as terrible when Hastings was acquitted in 1795, as in the select committee of 1781 when Hastings's enormities were first revealed. "If I were to call for a reward," wrote Burke, "it would be for the services in which for fourteen years, without intermission, I showed the most industry and had the least success, I mean in the affairs of India; they are those on which I value myself the most; most for the importance; most for the labour; most for the judgment; most for constancy and perseverance in the pursuit." Sheridan's speech in the House of Commons upon the charge relative to the begums of Oude probably excelled anything that Burke achieved, as a dazzling performance abounding in the most surprising literary and rhetorical effects. But neither Sheridan nor Fox was capable of that sustained and overflowing indignation at outraged justice and oppressed humanity, that consuming moral fire, which burst forth again and again from the chief manager of the impeachment, with such scorching might as drove even the cool and intrepid Hastings beyond all self-control, and made him cry out with protests and exclamations like a criminal writhing under the scourge. Burke, no doubt, in the course of that unparalleled trial showed some prejudice; made some minor overstatements of his case; used many intemperances; and suffered himself to be provoked into expressions of heat and impatience by the cabals of the defendant and his party, and the intolerable incompetence of the tribunal. It is one of the inscrutable perplexities of human affairs, that in the logic of practical

life, in order to reach conclusions that cover enough for truth, we are constantly driven to premises that cover too much, and that in order to secure their right weight to justice and reason good men are forced to fling the two-edged sword of passion into the same scale. But these excuses were mere trifles, and well deserve to be forgiven, when we think that though the offender was in form acquitted, yet Burke succeeded in these fourteen years of laborious effort in laying the foundations once for all of a moral, just, philanthropic and responsible public opinion in England with reference to India, and in doing so performed, perhaps the most magnificent service that any statesman has ever had it in his power to render to humanity.

Burke's first decisive step against Hastings was a motion for papers in the spring of 1786; the thanks of the House of Commons—the managers of the impeachment were voted in the summer 1794. But in those eight years some of the most astonishing events in history had changed the political face of Europe. Burke was more than sixty years old when the states-general met at Versailles in the spring of 1789. He had taken a prominent part on the side of freedom in the revolution which stripped France of her empire in the West. He had taken a prominent part on the side of justice, humanity and order in dealing with revolution which had brought to England new empire in the East. The same vehement passion for freedom, justice, order and humanity was roused in him at a very early stage in the third great revolution in his history—the revolution which overthrew the old monarchy in France. From the first he looked on the events of 1789 with doubt and misgiving. It had begun in France in 1773, where he had not only the famous portrait of Marie Antoinette at Versailles, "glittering like the morning star, full of life, and splendour and joy," but had also read and discussed with some of the destroyers, the encyclopedists, "the sophisters, economists and calculators." His speech on his return to England was a warning (March 17, 1780) that the props of good government were beginning to decay under the systematic attacks of unbelievers, and that these were being propagated that would not leave to civil society any stability. The apprehension never died out in his mind when he knew that the principles and abstractions, English dialect and destructive dialectic, of his former times were predominant in the National Assembly, his conviction that the movement would end in disastrous miscarriage to its certainty.

One grew still more sinister in his eyes after the march of the king and queen from Paris to Versailles in October, and the violent overthrow of the king and queen from Versailles to Paris. The red of lawlessness and violence which fired him with a rage against the Indian malefactors was aroused by the same red of lawlessness of the Parisian insurgents. The same red of abstractions and naked doctrines of right that had been against the pretensions of the British parliament in 1776, was revived in as lively a degree by political events which he judged to be identical in the French of 1789. And this anger and disgust were exasperated and deepened with which certain proceedings in England had taken place, that the aims, principles, methods and language of the misdoers or abhorred in France were likely to be the same of Great Britain.

In November 1790 the town, which had long been eagerly waiting for a manifesto from Burke's pen, was electrified by the publication of *Reflections on the Revolution in France, and on the proceedings of the National Assembly in London relative to that event*. The generous and generous made an entry in his diary of his reception of the "What shall be said," he added, "of the state of the world. It is remembered that the writer is a man decried, and proscribed; not being much valued even by his friends, and by half the nation considered as little better than an envious madman?" But the writer now ceased to be persecuted and proscribed, and his book was an expression of that new current of opinion in Europe which the recent events of the Revolution had slowly set

flowing. Its vogue was instant and enormous. Eleven editions were exhausted in little more than a year, and there is probably not much exaggeration in the estimate that 30,000 copies were sold before Burke's death seven years afterwards. George III. was extravagantly delighted; Stanislaus of Poland sent Burke words of thanks and high glorification and a gold medal. Catherine of Russia, the friend of Voltaire and the benefactress of Diderot, sent her congratulations to the man who denounced French philosophers as miscreants and wretches. "One wonders," Romilly said, by and by, "that Burke is not ashamed at such success." Mackintosh replied to him temperately in the *Vindiciæ Gallicæ*, and Thomas Paine replied to him less temperately but far more trenchantly and more shrewdly in the *Rights of Man*. Arthur Young, with whom he had corresponded years before on the mysteries of deep ploughing and fattening hogs, added a cogent polemical chapter to that ever admirable work, in which he showed that he knew as much more than Burke about the old system of France as he knew more than Burke about soils and roots. Philip Francis, to whom he had shown the proof-sheets, had tried to dissuade Burke from publishing his performance. The passage about Marie Antoinette, which has since become a stock piece in books of recitation, seemed to Francis a mere piece of foppery; for was she not a Messalina and a jade? "I know nothing of your story of Messalina," answered Burke; "am I obliged to prove judicially the virtues of all those I shall see suffering every kind of wrong and contumely and risk of life, before I endeavour to interest others in their sufferings? . . . Are not high rank, great splendour of descent, great personal elegance and outward accomplishments ingredients of moment in forming the interest we take in the misfortunes of men? . . . I tell you again that the recollection of the manner in which I saw the queen of France in 1774, and the contrast between that brilliancy, splendour and beauty, with the prostrate homage of a nation to her, and the abominable scene of 1789 which I was describing, did draw tears from me and wetted my paper. These tears came again into my eyes almost as often as I looked at the description,—they may again. You do not believe this fact, nor that these are my real feelings; but that the whole is affected, or as you express it, downright foppery. My friend, I tell you it is truth; and that it is true and will be truth when you and I are no more; and will exist as long as men with their natural feelings shall exist" (*Corr.* iii. 139).

Burke's conservatism was, as such a passage as this may illustrate, the result partly of strong imaginative associations clustering round the more imposing symbols of social continuity, partly of a sort of corresponding conviction in his reason that there are certain permanent elements of human nature out of which the European order had risen and which that order satisfied, and of whose immense merits, as of its mighty strength, the revolutionary party in France were most fatally ignorant. When Romilly saw Diderot in 1783, the great encyclopaedic chief assured him that submission to kings and belief in God would be at an end all over the world in a very few years. When Condorcet described the Tenth Epoch in the long development of human progress, he was sure not only that fulness of light and perfection of happiness would come to the sons of men, but that they were coming with all speed. Only those who know the incredible rashness of the revolutionary doctrine in the mouths of its most powerful professors at that time; only those who know their absorption in ends and their inconsiderateness about means, can feel how profoundly right Burke was in all this part of his contention. Napoleon, who had begun life as a disciple of Rousseau, confirmed the wisdom of the philosophy of Burke when he came to make the Concordat. That measure was in one sense the outcome of a mere sinister expediency, but that such a measure was expedient at all sufficed to prove that Burke's view of the present possibilities of social change was right, and the view of the Rousseauites and too sanguine Perfectibilitarians wrong. As we have seen, Burke's very first piece, the satire on Bolingbroke, sprang from his conviction that merely rationalistic or destructive criticism, applied to the vast complexities of man

in the social union, is either mischievous or futile, and mischievous exactly in proportion as it is not futile.

To discuss Burke's writings on the Revolution would be to write first a volume upon the abstract theory of society, and then a second volume on the history of France. But we may make one or two further remarks. One of the most common charges against Burke was that he allowed his imagination and pity to be touched only by the sorrows of kings and queens, and forgot the thousands of oppressed and famine-stricken toilers of the land. "No tears are shed for nations," cried Francis, whose sympathy for the Revolution was as passionate as Burke's execration of it. "When the provinces are scourged to the bone by a mercenary and merciless military power, and every drop of its blood and substance extorted from it by the edicts of a royal council, the case seems very tolerable to those who are not involved in it. When thousands after thousands are dragged out of their country for the sake of their religion, or sent to row in the galleys for selling salt against law,—when the liberty of every individual is at the mercy of every prostitute, pimp or parasite that has access to power or any of its basest substitutes,—my mind, I own, is not at once prepared to be satisfied with gentle palliatives for such disorders" (*Francis to Burke*, November 3, 1790). This is a very terse way of putting a crucial objection to Burke's whole view of French affairs in 1789. His answer was tolerably simple. The Revolution, though it had made an end of the Bastille, did not bring the only real practical liberty, that is to say, the liberty which comes with settled courts of justice, administering settled laws, undisturbed by popular fury, independent of everything but law, and with a clear law for their direction. The people, he contended, were no worse off under the old monarchy than they will be in the long run under assemblies that are bound by the necessity of feeding one part of the community at the grievous charge of other parts, as necessitous as those who are so fed; that are obliged to flatter those who have their lives at their disposal by tolerating acts of doubtful influence on commerce and agriculture, and for the sake of precarious relief to sow the seeds of lasting want; that will be driven to be the instruments of the violence of others from a sense of their own weakness, and, by want of authority to assess equal and proportioned charges upon all, will be compelled to lay a strong hand upon the possessions of a part. As against the moderate section of the Constituent Assembly this was just.

One secret of Burke's views of the Revolution was the contempt which he had conceived for the popular leaders in the earlier stages of the movement. In spite of much excellence of intention, much heroism, much energy, it is hardly to be denied that the leaders whom that movement brought to the surface were almost without exception men of the poorest political capacity. Danton, no doubt, was abler than most of the others, yet the timidity or temerity with which he allowed himself to be vanquished by Robespierre showed that even he was not a man of commanding quality. The spectacle of men so rash, and so incapable of controlling the forces which they seemed to have presumptuously summoned, excited in Burke both indignation and contempt. And the leaders of the Constituent who came first on the stage, and hoped to make a revolution with rose-water, and hardly realized any more than Burke did how rotten was the structure which they had undertaken to build up, almost deserved his contempt, even if, as is certainly true, they did not deserve his indignation. It was only by revolutionary methods, which are in their essence and for a time as arbitrary as despotic methods, that the knot could be cut. Burke's vital error was his inability to see that a root and branch revolution was, under the conditions, inevitable. His cardinal position, from which he deduced so many important conclusions, namely, that the parts and organs of the old constitution of France were sound, and only needed moderate invigoration, is absolutely mistaken and untenable. There was not a single chamber in the old fabric that was not crumbling and tottering. The court was frivolous, vacillating, stone deaf and stone blind; the gentry were amiable, but distinctly bent to the very last on holding to their privileges,

and they were wholly devoid both of the political experience that only comes of practical responsibility for public affairs, and of the political sagacity that only comes of political experience. The parliaments or tribunals were nests of faction and of the deepest social incompetence. The very sword of the state broke short in the king's hand. If the king or queen could either have had the political genius of Frederick the Great, or could have had the good fortune to find a minister with that genius, and the good sense and good faith to trust and stand by him against mobs of aristocrats and mobs of democrats; if the army had been sound and the states-general had been convoked at Bourges or Tours instead of at Paris, then the type of French monarchy and French society might have been modernized without convulsion. But none of these conditions existed.

When he dealt with the affairs of India Burke passed over the circumstances of our acquisition of power in that continent. "There is a sacred veil to be drawn over the beginnings of all government," he said. "The first step to empire is revolution, by which power is conferred; the next is good laws, good order, good institutions, to give that power stability." Exactly on this broad principle of political force, revolution was the first step to the assumption by the people of France of their own government. Granted that the Revolution was inevitable and indispensable, how was the nation to make the best of it? And how were surrounding nations to make the best of it? This was the true point of view. But Burke never placed himself at such a point. He never conceded the postulate, because, though he knew France better than anybody in England except Arthur Young, he did not know her condition well enough. "Alas!" he said, "they little know how many a weary step is to be taken before they can form themselves into a mass which has a true political personality."

Burke's view of French affairs, however consistent with all his former political conceptions, put an end to more than one of his old political friendships. He had never been popular in the House of Commons, and the vehemence, sometimes amounting to fury, which he had shown in the debates on the India Bill, on the regency, on the impeachment of Hastings, had made him unpopular even among men on his own side. In May 1789—that memorable month of May in which the states-general marched in impressive array to hear a sermon at the church of Notre Dame at Versailles—a vote of censure had actually been passed on him in the House of Commons for a too severe expression used against Hastings. Fox, who led the party, and Sheridan, who led Fox, were the intimates of the prince of Wales; and Burke would have been as much out of place in that circle of gamblers and profligates as Milton would have been out of place in the court of the Restoration. The prince, as somebody said, was like his father in having closets within cabinets and cupboards within closets. When the debates on the regency were at their height we have Burke's word that he was not admitted to the private counsels of the party. Though Fox and he were on friendly terms in society, yet Burke admits that for a considerable period before 1790 there had been between them "distance, coolness and want of confidence, if not total alienation on his part." The younger Whigs had begun to press for shorter parliaments, for the ballot, for redistribution of political power. Burke had never looked with any favour on these projects. His experience of the sentiment of the populace in the two greatest concerns of his life,—American affairs and Indian affairs,—had not been likely to prepossess him in favour of the popular voice as the voice of superior political wisdom. He did not absolutely object to some remedy in the state of representation (*Corr.* ii. 387), still he vigorously resisted such proposals as the duke of Richmond's in 1780 for manhood suffrage. The general ground was this:—"The machine itself is well enough to answer any good purpose, provided the materials were sound. But what signifies the arrangement of rottenness?"

Bad as the parliaments of George III. were, they contained their full share of eminent and capable men; and, what is more, their very defects were the exact counterparts of what we now look back upon as the prevailing stupidity in the country.

What Burke valued was good government. His *Report on the Causes of the Duration of Mr Hastings's Trial* shows how wide and sound were his views of law reform. His *Thoughts on Scarcity* test his enlightenment on the central necessities of trade and manufacture, and even furnished arguments to Cobden fifty years afterwards. Pitt's parliaments were competent to discuss, and willing to pass, all measures for which the average political intelligence of the country was ripe. Burke did not believe that mere machinery was at that time needed to improve the ability of legislation. If wiser legislation followed the great storm of 1832, Burke would have said this was because the political intelligence of the country had improved.

Though averse at all times to taking up parliamentary reform, though all such projects downright crimes in the agitation 1791-1792. This was the view taken by Burke, but it was the view of Fox, nor of Sheridan, nor of Francis, nor of many others of his party, and difference of opinion here was naturally bred by difference of opinion upon affairs in France. Fox, Windham, Sheridan, Francis, Lord Fitzwilliam, and most other Whig leaders, welcomed the Revolution in France. So did Pitt, too, for some time. "How much the greatest it is that ever happened in the world," cried Fox, with the exultation of a man ready to dance the carmagnole, "and such the best!" The dissension between a man who felt passionately as Burke, and a man who spoke so impulsively as Fox, lay in the very nature of things. Between Burke and Fox there was an open breach in the House of Commons upon the Revolution so early as February 1790, and Burke's influence with Fox was strong. This divergence of opinion destroyed all the elation that Burke might well have derived from his compliments from kings, his gold medals, his twelve orders.

But he was too fiercely in earnest in his horror of the Revolution to allow mere party associations to guide him. In 1791 the thundercloud burst, and a public rupture between Burke and Fox took place in the House of Commons.

Burke is famous in English parliamentary annals. The Revolution had introduced a measure for the division of the provinces, and for the establishment of a local legislature in each province. Fox in the course of debate went out of his way to attack the Revolution, and to sneer at some of the most effective measures in the *Reflections*. Burke was not present, but he determined to reply. On the day when the Revolution was to come on again, Fox called upon Burke, and they talked together from Burke's house in Duke Street, Westminster. The Quebec Bill was recommitted, and Burke rose and soon began to talk his usual language of the Revolution, the rights of man, and Jacobinism in English or French. There was a call to order. Fox, sharp and intolerant in the House as he was amiable and composed with some words of contemptuous irony. Lord Sheffield, all plunged into confused and angry whether the French Revolution was a good thing, the French Revolution, good or bad, had anything to do with the Quebec Bill. At length Fox, in seconding a motion to divide the House on the subject, burst into the fatal and the subject, taxing Burke with inconsistency.

Burke, with having forgotten that ever-admirable maxim about the insurgent colonists, that he did not draw an indictment against a whole nation. Burke was of firm self-repression; complained of the attack made upon him; reviewed Fox's charges of inconsistency; enumerated the points on which they had disagreed that such disagreements had never broken.

But whatever the risk of enmity, and however of friendship, he would never cease from his love for the French constitution. "But there is no more to be said," said Fox in an eager undertone. "Yes," said Burke, "I know the penalty of my duty at the price of my friend—our end." Fox rose, but was so overcome that he could not speak. At length, his eyes were dimmed, and in a broken voice, he deplored the

breach of a twenty years' friendship on a political question. Burke was inexorable. To him the political question was so vivid, so real, so intense, as to make all personal sentiment no more than dust in the balance. Burke confronted Jacobinism with the relentlessness of a Jacobin. The rupture was never healed, and Fox and he had no relations with one another henceforth beyond such formal interviews as took place in the manager's box in Westminster Hall in connexion with the impeachment.

A few months afterwards Burke published the *Appeal from the New to the Old Whigs*, a grave, calm and most cogent vindication of the perfect consistency of his criticisms upon the English Revolution of 1688 and upon the French Revolution of 1789, with the doctrines of the great Whigs who conducted and afterwards defended in Anne's reign the transfer of the crown from James to William and Mary. The *Appeal* was justly accepted as a satisfactory performance for the purpose with which it was written. Events, however, were doing more than words could do, to confirm the public opinion of Burke's sagacity and foresight. He had always divined by the instinct of hatred that the French moderates must gradually be swept away by the Jacobins, and now it was all coming true. The humiliation of the king and queen after their capture at Varennes; the compulsory acceptance of the constitution; the plain incompetence of the new Legislative Assembly; the growing violence of the Parisian mob, and the ascendancy of the Jacobins at the Common Hall; the fierce day of the 20th of June (1792), when the mob flooded the Tuileries, and the bloodier day of the 10th of August, when the Swiss guard was massacred and the royal family flung into prison; the murders in the prisons in September; the trial and execution of the king in January (1793); the proscription of the Girondins in June, the execution of the queen in October—

if we realize the impression likely to be made upon the sober and homely English imagination by such a heightening of horror by horror, we may easily understand how people came to listen to Burke's voice as the voice of inspiration, and to look on his burning anger as the holy fervour of a prophet of the Lord. Fox still held to his old opinions as stoutly as he could, and condemned and opposed the war which England had declared against the French republic. Burke, who was profoundly incapable of the meanness of letting personal estrangement blind his eyes to what was best for the commonwealth, kept hoping against hope that each new trait of excess in France would at length bring the great Whig leader to a better mind. He used to declaim by the hour in the conclaves at Burlington House upon the necessity of securing Fox; upon the strength which his genius would lend to the administration in its task of grappling with the sanguinary giant; upon the impossibility, at least, of doing either with him or without him. Fox's most important political friends who had long wavered, at length, to Burke's great satisfaction, went over to the side of the government. In July 1794 the duke of Portland, Lord Fitzwilliam, Windham and Grenville took office under Pitt. Fox was left with a minority which was satirically said not to have been more than enough to fill a hackney coach. "That is a calamity," said one of the party, "we should have filled two." The war was prosecuted with the aid of both the great parliamentary parties of the country, and with the approval of the great bulk of the nation. Perhaps the one man in England who in his heart approved of it less than any other was William Pitt. The difference between Pitt and Burke was nearly as great as that between Burke and Fox. Burke would be content with nothing short of a crusade against France, and war to the death with her rulers. "I cannot persuade myself," he said, "that this war bears any the least resemblance to any that has ever existed in the world. I cannot persuade myself that any examples or any reasonings drawn from other wars and other politics are at all applicable to it" (*Corr.* iv. 219). Pitt, on the other hand, as Lord Russell truly says, treated Robespierre and Carnot as he would have treated any other French rulers, whose ambition was to be resisted, and whose interference in the affairs of other nations was to be checked. And he entered upon the matter

in the spirit of a man of business, by sending ships to seize some islands belonging to France in the West Indies, so as to make certain of repayment of the expenses of the war.

In the summer of 1794 Burke was struck to the ground by a blow of his deepest affection in life, and he never recovered from it. His whole soul was wrapped up in his only son, of whose abilities he had the most extravagant estimate and hope. All the evidence goes to show that Richard Burke was one of the most presumptuous and empty-headed of human beings. "He is the most impudent and opinative fellow I ever knew," said Wolfe Tone. Gilbert Elliot, a very different man, gives the same account. "Burke," he says, describing a dinner party at Lord Fitzwilliam's in 1793, "has now got such a train after him as would sink anybody but himself: his son, who is quite *masseated* by all mankind; his brother, who is liked better than his son, but is rather oppressive with animal spirits and brogue; and his cousin, William Burke, who is just returned unexpectedly from India, as much ruined as when he went years ago, and who is a fresh charge on any prospects of power Burke may ever have. Mrs Burke has in her train Miss French [Burke's niece], the most perfect *She Paddy* that ever was caught. Notwithstanding these disadvantages Burke is in himself a sort of power in the state. It is not too much to say that he is a sort of power in Europe, though totally without any of those means or the smallest share in them which give or maintain power in other men." Burke accepted the position of a power in Europe seriously. Though no man was ever more free from anything like the egotism of the intellectual coxcomb, yet he abounded in that active self-confidence and self-assertion which is natural in men who are conscious of great powers, and strenuous in promoting great causes. In the summer of 1791 he despatched his son to Coblenz to give advice to the royalist exiles, then under the direction of Calonne, and to report to him at Beaconsfield their disposition and prospects. Richard Burke was received with many compliments, but of course nothing came of his mission, and the only impression that remains with the reader of his prolix story is his tale of the two royal brothers, who afterwards became Louis XVIII. and Charles X., meeting after some parting, and embracing one another with many tears on board a boat in the middle of the Rhine, while some of the courtiers raised a cry of "Long live the king"—the king who had a few weeks before been carried back in triumph to his capital with Mayor Pétion in his coach. When we think of the pass to which things had come in Paris by this time, and of the unappeasable ferment that boiled round the court, there is a certain touch of the ludicrous in the notion of poor Richard Burke writing to Louis XVI. a letter of wise advice how to comport himself.

At the end of the same year, with the approval of his father he started for Ireland as the adviser of the Catholic Association. He made a wretched emissary, and there was no limit to his arrogance, noisiness and indiscretion. The Irish agitators were glad to give him two thousand guineas and to send him home. The mission is associated with a more important thing, his father's *Letters to Sir Hercules Langrishe*, advocating the admission of the Irish Catholics to the franchise. This short piece abounds richly in maxims of moral and political prudence. And Burke exhibited considerable courage in writing it; for many of its maxims seem to involve a contradiction, first, to the principles on which he withstood the movement in France, and second, to his attitude upon the subject of parliamentary reform. The contradiction is in fact only superficial. Burke was not the man to fall unawares into a trap of this kind. His defence of Catholic relief—and it had been the conviction of a lifetime—was very properly founded on propositions which were true of Ireland, and were true neither of France nor of the quality of parliamentary representation in England. Yet Burke threw such breadth and generality over all he wrote that even these propositions, relative as they were, form a short manual of statesmanship.

At the close of the session of 1794 the impeachment of Hastings had come to an end, and Burke bade farewell to parliament.

Richard Burke was elected in his father's place at Malton. The king was bent on making the champion of the old order of Europe a peer. His title was to be Lord Beaconsfield, and it was designed to annex to the title an income for three lives. The patent was being made ready, when all was arrested by the sudden death of the son who was to Burke more than life. The old man's grief was agonizing and inconsolable. "The storm has gone over me," he wrote in words which are well known, but which can hardly be repeated too often for any who have an ear for the cadences of noble and pathetic speech.—"The storm has gone over me, and I lie like one of those old oaks which the late hurricane has scattered about me. I am stripped of all my honours; I am torn up by the roots and lie prostrate on the earth. . . . I am alone. I have none to meet my enemies in the gate. . . . I live in an inverted order. They who ought to have succeeded me have gone before me. They who should have been to me as posterity are in the place of ancestors."

A pension of £2500 was all that Burke could now be persuaded to accept. The duke of Bedford and Lord Lauderdale made some remarks in parliament upon this paltry reward to a man who, in conducting a great trial on the public behalf, had worked harder for nearly ten years than any minister in any cabinet of the reign. But it was not yet safe to kick up heels in face of the dying lion. The vileness of such criticism was punished, as it deserved to be, in the *Letter to a Noble Lord* (1796), in which Burke showed the usual art of all his compositions in shaking aside the insignificances of a subject. He turned mere personal defence and retaliation into an occasion for a lofty enforcement of constitutional principles, and this, too, with a relevancy and pertinence of consummate skillfulness. There was to be one more effort before the end.

In the spring of 1796 Pitt's constant anxiety for peace had become more earnest than ever. He had found out the instability of the coalition and the power of France. Like the thrifty steward he was, he saw with growing concern the waste of the national resources and the strain upon commerce, with a public debt swollen to what then seemed the desperate sum of £400,000,000. Burke at the notion of negotiation flamed out in the *Letters on a Regicide Peace*, in some respects the most splendid of all his compositions. They glow with passion, and yet with all their rapidity is such steadfastness, the fervour of imagination is so skillfully tempered by close and plausible reasoning, and the whole is wrought with such strength and fire, that we hardly know where else to look either in Burke's own writings or elsewhere for such an exhibition of the rhetorical resources of our language. We cannot wonder that the whole nation was stirred to the very depths, or that they strengthened the aversion of the king, of Windham and other important personages in the government against the plans of Pitt. The prudence of their drift must be settled by external considerations. Those who think that the French were likely to show a moderation and practical reasonableness in success, such as they had never shown in the hour of imminent ruin, will find Burke's judgment full of error and mischief. Those, on the contrary, who think that the nation which was on the very edge of surrendering itself to the Napoleonic absolutism was not in a hopeful humour for peace and the European order, will believe that Burke's protests were as perspicacious as they were powerful, and that anything which chilled the energy of the war was as fatal as he declared it to be.

When the third and most impressive of these astonishing productions came into the hands of the public, the writer was no more. Burke died on the 8th of July 1797. Fox, who with all his faults was never wanting in a fine and generous sensibility, proposed that there should be a public funeral, and that the body should lie among the illustrious dead in Westminster Abbey. Burke, however, had left strict injunctions that his burial should be private; and he was laid in the little church at Beaconsfield. It was the year of Campo Formio. So a black whirl and torrent of rapine, violence and fraud was encircling the Western world, as a life went out which, notwithstanding some eccentricities

and some aberrations, had made great tides in human destiny very luminous. (J. Mo.)

AUTHORITIES.—Of the *Collected Works*, there are two main editions—the quarto and the octavo. (1) *Quarto*, in eight volumes, begun in 1792, under the editorship of Dr F. Lawrence; vols. i.-iii. were published in 1792; vols. iv.-viii., edited by Dr Walter King, sometime bishop of Rochester, were completed in 1827. (2) *Octavo* in sixteen volumes. This was begun at Burke's death, also by Dr Lawrence and King; vols. I.-viii. were published in 1803 and reissued in 1808, when Dr Lawrence died; vols. ix.-xii. were published in 1813 and the remaining four vols. in 1827. A new edition of vols. i.-viii. was published in 1823 and the contents of vols. i.-xii. in 2 vols. octavo in 1834. An edition in nine volumes was published in Boston, Massachusetts, in 1839. This contains the whole of the English edition in sixteen volumes, with a reprint of the *Account of the European Settlements in America* which is not in the English edition.

Among the numerous editions published later may be mentioned that in *Bohn's British Classics*, published in 1853. This contains the fifth edition of Sir James Prior's life; also an edition in twelve volumes, octavo, published by J. C. Nimmo, 1808. There is an edition of the *Select Works* of Burke with introduction and notes by E. J. Payne in the Clarendon Press series, new edition, 3 vols., 1897. *The Correspondence of Edmund Burke*, edited by Earl Fitzwilliam and Sir R. Bourke, with appendix, detached papers and notes for speeches, was published in 4 vols., 1844. *The Speeches of Edmund Burke, in the House of Commons and Westminster Hall*, were published in 4 vols., 1816. Other editions of the speeches are those *On Irish Affairs*, collected and arranged by Matthew Arnold, with a preface (1881); *On American Taxation, On Conciliation with America*, together with *the Letter to the Sheriff of Bristol*, edited with introduction and notes by F. G. Selby (1895).

The standard life of Burke is that by Sir James Prior, *Memoir of the Life and Character of Edmund Burke with Specimens of his Poetry and Letters* (1824). The lives by C. MacCormick (1798) by R. Bisset (1798, 1800) are of little value. Other lives are those by the Rev. George Croly (2 vols., 1847), and by T. MacKnight (3 vols., 1898). Of critical estimates of Burke's life the *Edmund Burke* of John Morley, "English Men of Letters" series (1879), is an elaboration of the above article; see also his *Burke, a Historical Study* (1867); "Three Essays on Burke," by Sir James Fitzjames Stephen in *Horae Sabbaticae*, series iii. (1892); and *Peptographia Dubinensis, Memorial Discourses preached in the Chapel of Trinity College, Dublin, 1895-1902*; *Edmund Burke*, by G. Chadwick, bishop of Derry (1902).

BURKE, SIR JOHN BERNARD (1814-1892), British genealogist, was born in London, on the 5th of January 1814, and was educated in London and in France. His father, John Burke (1787-1849), was also a genealogist, and in 1826 issued a *Genealogical and Heraldic Dictionary of the Peerage and Baronetage of the United Kingdom*. This work, generally known as *Burke's Peerage*, has been issued annually since 1847. While practising as a barrister Bernard Burke assisted his father in his genealogical work, and in 1848 took control of his publications. In 1853 he was appointed Ulster king-at-arms; in 1854 he was knighted; and in 1855 he became keeper of the state papers in Ireland. After having devoted his life to genealogical studies he died in Dublin on the 12th of December 1892. In addition to editing *Burke's Peerage* from 1847 to his death, Burke brought out several editions of a companion volume, *Burke's Landed Gentry*, which was first published between 1833 and 1838. In 1866 and 1883 he published editions of his father's *Dictionary of the Peerages of England, Scotland and Ireland, extinct, dormant and in abeyance* (earlier editions, 1831, 1840, 1846); in 1855 and 1876 editions of his *Royal Families of England, Scotland and Wales* (1st edition, 1847-1851); and in 1878 and 1883 enlarged editions of his *Encyclopædia of Heraldry, or General Armoury of England, Scotland and Ireland*. Burke's own works include *The Roll of Battle Abbey* (1848); *The Romance of the Aristocracy* (1855); *Vicissitudes of Families* (1883 and several earlier editions); and *The Rise of Great Families* (1882). He was succeeded as editor of *Burke's Peerage and Landed Gentry* by his fourth son, Ashworth Peter Burke.

BURKE, ROBERT O'HARA (1820-1861), Australian explorer, was born at St Cleram, Co. Galway, Ireland, in 1820. Descended from a branch of the family of Clanricarde, he was educated in Belgium, and at twenty years of age entered the Austrian army, in which he attained the rank of captain. In 1848 he left the Austrian service, and became a member of the Royal Irish Constabulary. Five years later he emigrated to Tasmania, and

shortly afterwards crossed to Melbourne, where he became an inspector of police. When the Crimean War broke out he went to England in the hope of securing a commission in the army, but peace had meanwhile been signed, and he returned to Victoria and resumed his police duties. At the end of 1857 the Philosophical Institute of Victoria took up the question of the exploration of the interior of the Australian continent, and appointed a committee to inquire into and report upon the subject. In September 1858, when it became known that John McDouall Stuart had succeeded in penetrating as far as the centre of Australia, the sum of £1000 was anonymously offered for the promotion of an expedition to cross the continent from south to north, on condition that a further sum of £2000 should be subscribed within a twelvemonth. The amount having been raised within the time specified, the Victorian parliament supplemented it by a vote of £6000, and an expedition was organized under the leadership of Burke, with W. J. Wills as surveyor and astronomical observer. The story of this expedition, which left Melbourne on the 21st of August 1860, furnishes perhaps the most painful episode in Australian annals. Ten Europeans and three Sepoys accompanied the expedition, which was soon torn by internal dissensions. Near Menindie on the Darling, Landells, Burke's second in command, became insubordinate and resigned, his example being followed by the doctor—a German. On the 11th of November Burke, with Wills and five assistants, fifteen horses and sixteen camels, reached Cooper's Creek in Queensland, where a depot was formed near good grass and abundance of water. Here Burke proposed waiting the arrival of his third officer, Wright, whom he had sent back from Torowoto to Menindie to fetch some camels and supplies. Wright, however, delayed his departure until the 26th of January 1861. Meantime, weary of waiting, Burke, with Wills, King and Gray as companions, determined on the 16th of December to push on across the continent, leaving an assistant named Brahe to take care of the depot until Wright's arrival. On the 4th of February 1861 Burke and his party, worn down by famine, reached the estuary of the Flinders river, not far from the present site of Normantown on the Gulf of Carpentaria. On the 26th of February began their return journey. The party suffered greatly from famine and exposure, and but for the rainy season, thirst would have speedily ended their miseries. In vain they looked for the relief which Wright was to bring them. On the 16th of April Gray died, and the emaciated survivors halted a day to bury his body. That day's delay, as it turned out, cost Burke and Wills their lives; they arrived at Cooper's Creek to find the depot deserted. But a few hours before Brahe, unrelieved by Wright, and thinking that Burke had died or changed his plans, had taken his departure for the Darling. With such assistance as they could get from the natives, Burke, and his two companions struggled on, until death overtook Burke and Wills at the end of June. King sought the natives, who cared for him until his relief by a search party in September. No one can deny the heroism of the men whose lives were sacrificed in this ill-starred expedition. But it is admitted that the leaders were not bushmen and had had no experience in exploration. Disunion and disobedience to orders, from the highest to the lowest, brought about the worst results, and all that now remains to tell the story of the failure of this vast undertaking is a monument to the memory of the foolhardy heroes, from the chisel of Charles Summers, erected on a prominent site in Melbourne.

BURKE, WILLIAM (1792-1829), Irish criminal, was born in Ireland in 1792. After trying his hand at a variety of trades there, he went to Scotland about 1817 as a navvy, and in 1827 was living in a lodging-house in Edinburgh kept by William Hare, another Irish labourer. Towards the end of that year one of Hare's lodgers, an old army pensioner, died. This was the period of the body-snatchers or Resurrectionists, and Hare and Burke, aware that money could always be obtained for a corpse, sold the body to Dr Robert Knox, a leading Edinburgh anatomist, for £7, 10s. The price obtained and the simplicity of the transaction suggested to Hare an easy method of making a

profitable livelihood, and Burke at once fell in with the plan. The two men inveigled obscure travellers to Hare's or some other lodging-house, made them drunk and then suffocated them, taking care to leave no marks of violence. The bodies were sold to Dr Knox for prices averaging from £8 to £14. At least fifteen victims had been disposed of in this way when the suspicions of the police were aroused, and Burke and Hare were arrested. The latter turned king's evidence, and Burke was found guilty and hanged at Edinburgh on the 28th of January 1829. Hare found it impossible, in view of the strong popular feeling, to remain in Scotland. He is believed to have died in England under an assumed name. From Burke's method of killing his victims has come the verb "to burke," meaning to suffocate, strangle or suppress secretly, or to kill with the object of selling the body for the purposes of dissection.

See George Macgregor, *History of Burke and Hare and of the Resurrectionist Times* (Glasgow, 1884).

BURLAMAQUI, JEAN JACQUES (1694-1748), Swiss publicist, was born at Geneva on the 24th of June 1694. At the age of twenty-five he was designated honorary professor of ethics and the law of nature at the university of Geneva. Before taking up the appointment he travelled through France and England, and made the acquaintance of the most eminent writers of the period. On his return he began his lectures, and soon gained a wide reputation, from the simplicity of his style and the precision of his views. He continued to lecture for fifteen years, when he was compelled on account of ill-health to resign. His fellow-citizens at once elected him a member of the council of state, and he gained as high a reputation for his practical sagacity as he had for his theoretical knowledge. He died at Geneva on the 3rd of April 1748. His works were *Principes du droit naturel* (1747), and *Principes du droit politique* (1751). These have passed through many editions, and were very extensively used as text-books. Burlamaqui's style is simple and clear, and his arrangement of the material good. His fundamental principle may be described as rational utilitarianism, and in many ways it resembles that of Cumberland.

BURLESQUE (Ital. *burlesco*, from *burid*, a joke, fun, playful trick), a form of the comic in art, consisting broadly in an imitation of a work of art with the object of exciting laughter, by distortion or exaggeration, by turning, for example, the highly rhetorical into bombast, the pathetic into the mock-sentimental, and especially by a ludicrous contrast between the subject and the style, making gods speak like common men and common men like gods. While parody (*q.v.*), also based on imitation, relies for its effect more on the close following of the style of its counterpart, burlesque depends on broader and coarser effects. Burlesque may be applied to any form of art, and unconsciously, no doubt, may be found even in architecture. In the graphic arts it takes the form better known as "caricature" (*q.v.*). Its particular sphere is, however, in literature, and especially in drama. The *Batrachomachia*, or Battle of the Frogs and Mice, is the earliest example in classical literature, being a travesty of the Homeric epic. There are many true burlesque parts in the comedies of Aristophanes, e.g. the appearance of Socrates in the *Clouds*. The Italian word first appears in the *Opere Burlesche* of Francesco Berni (1497-1535). In France during part of the reign of Louis XIV., the burlesque attained to great popularity; burlesque Aeneids, Iliads and Odysseys were composed, and even the most sacred subjects were not left untravestied. Of the numerous writers of these, P. Scarron is most prominent, and his *Virgile Travesti* (1648-1653) was followed by numerous imitators. In English literature Chaucer's *Rime of Sir Thopas* is a burlesque of the long-winded medieval romances. Among the best-known true burlesques in English dramatic literature may be mentioned the 2nd duke of Buckingham's *The Rehearsal*, a burlesque of the heroic drama; Gay's *Beggar's Opera*, of the Italian opera; and Sheridan's *The Critic*. In the later 19th century the name "burlesque" was given to a form of musical dramatic composition in which the true element of burlesque found little or no place. These musical burlesques, with which the Gaiety theatre, London, and the

names of Edward Terry, Fred Leslie and Nellie Farren are particularly connected, developed from the earlier extravaganzas of J. R. Planché, written frequently round fairy tales. The Gaiety type of burlesque has since given place to the "musical comedy," and its only survival is to be found in the modern pantomime.

BURLINGAME, ANSON (1820-1870), American legislator and diplomat, was born in New Berlin, Chenango county, New York, on the 14th of November 1820. In 1823 his parents took him to Ohio, and about ten years afterwards to Michigan. In 1838-1841 he studied in one of the "branches" of the university of Michigan, and in 1846 graduated at the Harvard law school. He practised law in Boston, and won a wide reputation by his speeches for the Free Soil party in 1848. He was a member of the Massachusetts constitutional convention in 1853, of the state senate in 1853-1854, and of the national House of Representatives from 1855 to 1861, being elected for the first term as a "Know Nothing" and afterwards as a member of the new Republican party, which he helped to organize in Massachusetts. He was an effective debater in the House, and for his impassioned denunciation (June 21, 1856) of Preston S. Brooks (1819-1857), for his assault upon Senator Charles Sumner, was challenged by Brooks. Burlingame accepted the challenge and specified rifles as the weapons to be used; his second chose Navy Island, above the Niagara Falls, and in Canada, as the place for the meeting. Brooks, however, refused these conditions, saying that he could not reach the place designated "without running the gauntlet of mobs and assassins, prisons and penitentiaries, bailiffs and constables." To Burlingame's appointment as minister to Austria (March 22, 1861) the Austrian authorities objected because in Congress he had advocated the recognition of Sardinia as a first-class power and had championed Hungarian independence. President Lincoln thereupon appointed him (June 14, 1861) minister to China. This office he held until November 1867, when he resigned and was immediately appointed (November 26) envoy extraordinary and minister plenipotentiary to head a Chinese diplomatic mission to the United States and the principal European nations. The embassy, which included two Chinese ministers, an English and a French secretary, six students from the Tung-wan Kwang at Peking, and a considerable retinue, arrived in the United States in March 1868, and concluded at Washington (28th of July 1868) a series of articles, supplementary to the Reed Treaty of 1858, and later known as "The Burlingame Treaty." Ratifications of the treaty were not exchanged at Peking until November 23, 1869. The "Burlingame Treaty" recognizes China's right of eminent domain over all her territory, gives China the right to appoint at ports in the United States consuls, "who shall enjoy the same privileges and immunities as those enjoyed by the consuls of Great Britain and Russia"; provides that "citizens of the United States in China of every religious persuasion and Chinese subjects in the United States shall enjoy entire liberty of conscience and shall be exempt from all disability or persecution on account of their religious faith or worship in either country"; and grants certain privileges to citizens of either country residing in the other, the privilege of naturalization, however, being specifically withheld. After leaving the United States, the embassy visited several continental capitals, but made no definite treaties. Burlingame's speeches did much to awaken interest in, and a more intelligent appreciation of, China's attitude toward the outside world. He died suddenly at St Petersburg, on the 23rd of February 1870.

His son Edward Livermore Burlingame (b. 1848) was educated at Harvard and at Heidelberg, was a member of the editorial staff of the *New York Tribune* in 1871-1872 and of the *American Cyclopaedia* in 1872-1876, and in 1886 became the editor of *Scribner's Magazine*.

BURLINGTON, a city and the county-seat of Des Moines county, Iowa, U.S.A., on the Mississippi river, in the S.E. part of the state. Pop. (1890) 22,565; (1900) 23,201; (1905, state census) 25,318 (4492 foreign-born); (1910) 24,324. It is served by the Chicago, Burlington & Quincy (which has extensive

struction and repair shops here), the Chicago, Rock Island Pacific, and the Toledo, Peoria & Western (Pennsylvania em) railways; and has an extensive river commerce. The r is spanned here by the Chicago, Burlington & Quincy ray bridge. Many of the residences are on bluffs commanding beautiful views of river scenery; and good building material been obtained from the Burlington limestone quarries. o Park, of 100 acres, along the river, is one of the attractions e city. Among the principal buildings are the county court e, the free public library, the Tama building, the German- ican savings bank building and the post office. Burlington hree well-equipped hospitals. Among the city's manu- res are lumber, furniture, baskets, pearl buttons, cars, ges and wagons, Corliss engines, waterworks pumps, metallic ases, desks, boxes, crackers, flour, pickles and beer. actory product in 1905 was valued at \$5,779,337, or e, more than in 1900. The first white man to visit the

Burlington seems to have been Lieutenant Zebulon M. who came in 1805 and recommended the erection of a fort. merican Fur Company established a post here in 1829 ier, but settlement really began in 1833, after the Black War, and the place had a population of 1200 in 1838. It d out as a town and named Flint Hills (a translation of ian name, *Shokokon*) in 1834; but the name was soon l to Burlington, after the city of that name in Vermont. on was incorporated as a town in 1837, and was chartered r in 1838 by the territory of Wisconsin, the city charter ned by the territory of Iowa in 1839 and 1841. The l legislature of Wisconsin met here from 1836 to 1838 of Iowa from 1838 to 1840. In 1837 a newspaper, the *in Territorial Gazette*, now the *Burlington Evening and* in 1839 another, the *Burlington Hawk Eye*, were e the latter became widely known in the years e following 1872 from the humorous sketches con- to it by Robert Jones Burdette (b. 1844), an associate own as the "Burlington Hawk Eye Man," who in 1903 he Baptist ministry and became pastor of the Temple hurch in Los Angeles, California, and among whose ns are *Hawkeyetems* (1877), *Hawkeyes* (1879), and *ked with Sighs* (1900).

BURLETON, a city of Burlington county, New Jersey, a the E. bank of the Delaware river, 18 m. N.E. of ia. Pop. (1890) 7264; (1900) 7392, of whom 636 n-born and 590 were of negro descent; (1905) 8038; 36. It is served by the Pennsylvania railway, senger and freight steamboat lines on the Delaware ecting with river and Atlantic coast ports. Burlington nt residential city with a number of interesting old ong antedating the War of Independence, some of summer homes of old Philadelphia families. The Society library, established in 1757 and still conducted riginal charter granted by George II., is one of the c libraries in America. At Burlington are St Mary's ; Protestant Episcopal), founded by Bishop G.W. of the first schools for girls to be established in the an Rensselaer Seminary and the New Jersey State orme. In the old St Mary's church (Protestant hich was built in 1703 and has been called St Anne's t Mary's, Daniel Coxe (1674-1739), first provincial r of the lodge of Masons in America, was buried; ative bronze tablet was erected in 1907. Burlington ded by Bishop Doane in 1864, was closed as a college continued as a church school until 1900; the build- ntly passed into the hands of an iron manufacturer. rincipal industries are the manufacture of shoes water and gas pipes. Burlington was settled in ony of English Quakers. The settlement was first, w Beverly, but was soon renamed after Bridlington e Yorkshire home of many of the settlers. In ibly of West Jersey gave to Burlington "Matinickunk e the town," for the maintaining of a school for of youth"; revenues from a part of the island

are still used for the support of the public schools, and the trust fund is one of the oldest for educational purposes in the United States. Burlington was incorporated as a town in 1693 (re-incorporated, 1733), and became the seat of government of West Jersey. On the union of East and West Jersey in 1702, it became one of the two seats of government of the new royal province, the meetings of the legislature generally alternating between Burlington and Perth Amboy, under both the colonial and the state government, until 1790. In 1777 the *New Jersey Gazette*, the first newspaper in New Jersey, was established here; it was published (here and later in Trenton) until 1786, and was an influential paper, especially during the War of Independence. Burlington was chartered as a city in 1784.

See Henry Armit Brown, *The Settlement of Burlington* (Burlington, 1878); George M. Hills, *History of the Church in Burlington* (Trenton, 1885); and Mrs A. M. Gummere, *Friends in Burlington* (Philadelphia, 1884).

BURLINGTON, a city, port of entry and the county-seat of Chittenden county, Vermont, U.S.A., on the E. shore of Lake Champlain, in the N.W. part of the state, 90 m. S.E. of Montreal, and 300 m. N. of New York. It is the largest city in the state. Pop. (1880) 11,365; (1890) 14,590; (1900) 18,640, of whom 3726 were foreign-born; (1910, census) 20,468. It is served by the Central Vermont and the Rutland railways, and by lines of passenger and freight steamboats on Lake Champlain. The city is attractively situated on an arm of Lake Champlain, being built on a strip of land extending about 6 m. south from the mouth of the Winooski river along the lake shore and gradually rising from the water's edge to a height of 275 ft.; its situation and its cool and equable summer climate have given it a wide reputation as a summer resort, and it is a centre for yachting, canoeing and other aquatic sports. During the winter months it has ice-boat regattas. Burlington is the seat of the university of Vermont (1791; non-sectarian and co-educational), whose official title in 1865 became "The University of Vermont and State Agricultural College." The university is finely situated on a hill (280 ft. above the lake) commanding a charming view of the city, lake, the Adirondacks and the Green Mountains. It has departments of arts, sciences and medicine, and a library of 74,800 volumes and 32,936 pamphlets housed in the Billings Library, designed by H. H. Richardson. The university received the Federal grants under the Morrill acts of 1862 and 1890, and in connexion with it the Vermont agricultural experiment station is maintained. At Burlington are also the Mt St Mary's academy (1880, Roman Catholic), conducted by the Sisters of Mercy; and two business colleges. Among the principal buildings are the city hall, the Chittenden county court house, the Federal and the Y.M.C.A. buildings, the Masonic temple, the Roman Catholic cathedral and the Edmunds high school. Burlington's charitable institutions include the Mary Fletcher hospital, the Adams mission home, the Lousia Howard mission, the Providence orphan asylum, and homes for aged women, friendless women and destitute children. The Fletcher free public library (47,000 volumes in 1908) is housed in a Carnegie building. In the city are two sanitariums. The city has two parks (one, Ethan Allen Park, is on a bluff in the north-west part of the city, and commands a fine view) and four cemeteries; in Green Mount Cemetery, which overlooks the Winooski valley, is a monument over the grave of Ethan Allen, who lived in Burlington from 1778 until his death. Fort Ethan Allen, a United States military post, is about 3 m. east of the city, with which it is connected by an electric line. Burlington is the most important manufacturing centre in the state; among its manufactures are sashes, doors and blinds, boxes, furniture and wooden-ware, cotton and woollen goods, patent medicines, refrigerators, house furnishings, paper and machinery. In 1905 the city's factory products were valued at \$6,355,754, three-tenths of which was the value of lumber and planing mill products, including sashes, doors and blinds. The Winooski river, which forms the boundary between Burlington and the township of Colchester and which enters Lake Champlain N.W. of the city,

furnishes valuable water-power, but most of the manufactories are operated by steam. Quantities of marble were formerly taken from quarries in the vicinity. The city is a wholesale distributing centre for all northern Vermont and New Hampshire, and is one of the principal lumber markets in the east, most of the lumber being imported from Canada. It is the port of entry for the Vermont customs district, whose exports and imports were valued respectively in 1907 at \$8,333,024 and \$5,721,034. A charter for a town to be founded here was granted by the province of New Hampshire in 1763, but no settlement was made until 1774. Burlington was chartered as a city in 1865.

BURMA, a province of British India, including the former kingdom of independent Burma, as well as British Burma, acquired by the British Indian government in the two wars of 1826 and 1852. It is divided into Upper and Lower Burma, the former being the territory annexed on 1st January 1886. The province lies to the east of the Bay of Bengal, and covers a range of country extending from the Pakchan river in 9° 55' north latitude to the Naga and Chingpaw, or Kachin hills, lying roughly between the 27th and 28th degrees of north latitude; and from the Bay of Bengal on the west to the Mekong river, the boundary of the dependent Shan States on the east, that is to say, roughly, between the 92nd and 100th degrees of east longitude. The extreme length from north to south is almost 1200 m., and the broadest part, which is in about latitude 21° north, is 575 m. from east to west. On the N. it is bounded by the dependent state of Manipur, by the Mishmi hills, and by portions of Chinese territory; on the E. by the Chinese Shan States, portions of the province of Yunnan, the French province of Indo-China, and the Siamese Shan, or Lao States and Siam; on the S. by the Siamese Malay States and the Bay of Bengal; and on the W. by the Bay of Bengal and Chittagong. The coast-line from Taknaf, the mouth of the Naaf, in the Akyab district on the north, to the estuary of the Pakchan at Maluon on the south, is about 1200 m. The total area of the province is estimated at 238,738 sq. m., of which Burma proper occupies 168,573 sq. m., the Chin hills 10,250 sq. m., and the Shan States, which comprise the whole of the eastern portion of the province, some 59,915 sq. m.

Natural Divisions.—The province falls into three natural divisions: Arakan with the Chin hills, the Irrawaddy basin, and the old province of Tenasserim, together with the portion of the Shan and Karen-ni states in the basin of the Salween, and part of Kengtung in the western basin of the Mekong. Of these Arakan is a strip of country lying on the seaward slopes of the range of hills known as the Arakan Yomas. It stretches from Cape Negrais on the south to the Naaf estuary, which divides it from the Chittagong division of Eastern Bengal and Assam on the north, and includes the districts of Sandoway, Kyaukpyu, Akyab and northern Arakan, an area of some 18,540 sq. m. The northern part of this tract is barren hilly country, but in the west and south are rich alluvial plains containing some of the most fertile lands of the province. Northwards lie the Chin and some part of the Kachin hills. To the east of the Arakan division, and separated from it by the Arakan Yomas, lies the main body of Burma in the basin of the Irrawaddy. This tract falls into four subdivisions. First, there is the highland tract including the hilly country at the sources of the Chindwin and the upper waters of the Irrawaddy, the Upper Chindwin, Katha, Bhamo, Myitkyina and Ruby Mines districts, with the Kachin hills and a great part of the Northern Shan States. In the Shan States there are a few open plateaus, fertile and well populated, and Maymyo in the Mandalay district, the hill-station to which in the hot weather the government of Burma migrates, stands in the Pyin-ü-lwin plateau, some 3500 ft. above the sea. But the greater part of this country is a mass of rugged hills cut deep with narrow gorges, within which even the biggest rivers are confined. The second tract is that known as the dry zone of Burma, and includes the whole of the lowlands lying between the Arakan Yomas and the western fringe of the Southern Shan States. It stretches along both sides of the Irrawaddy from the north of Mandalay to Thayetmyo, and embraces the Lower Chindwin, Shwebo, Sagaing, Mandalay, Kyaukse, Meiktila, Yamethin, Myingyan, Magwe, Pakökku and Minbu districts. This tract consists mostly of undulating lowlands, but it is broken towards the south by the Pegu Yomas, a considerable range of hills which divides the two remaining tracts of the Irrawaddy basin. On the west, between the Pegu and the Arakan Yomas, stretches the Irrawaddy delta, a vast expanse of level plain 12,000 sq. m. in area falling in a gradual unbroken slope from its apex not far south of Prome down to the sea. This delta, which includes the districts of Bassein, Myaungmya, Thongwa, Hensada, Hantha-

waddy, Tharrawaddy, Pegu and Rangoon town, consists almost entirely of a rich alluvial deposit, and the whole area, which between Cape Negrais and Elephant Point is 137 m. wide, is fertile in the highest degree. To the east lies a tract of country which, though geographically a part of the Irrawaddy basin, is cut off from it by the Yomas, and forms a separate system draining into the Sittang river. The northern portion of this tract, which on the east touches the basin of the Salween river, is hilly; the remainder towards the confluence of the Salween, Gyauing and Attaran rivers consists of broad fertile plains. The whole is comprised in the districts of Toungoo and Thaton, part of the Karen-ni hills, with the Salween hill tract and the northern parts of Amherst, which form the northern portion of the Tenasserim administrative division. The third natural division of Burma is the old province of Tenasserim, which, constituted in 1826 with Moulmein as its capital, formed the nucleus from which the British supremacy throughout Burma has grown. It is a narrow strip of country lying between the Bay of Bengal and the high range of hills which form the eastern boundary of the province towards Siam. It comprises the districts of Mergui and Tavoy and a part of Amherst, and includes also the Mergui Archipelago. The surface of this part of the country is mountainous and much intersected with streams. Northward from this lies the major portion of the Southern Shan States and Karen-ni and a narrowing strip along the Salween of the Northern Shan States.

Mountains.—Burma proper is encircled on three sides by a wall of mountain ranges. The Arakan Yomas starting from Cape Negrais extend northwards more or less parallel with the coast till they join the Chin and Naga hills. They then form part of a system of ranges which curve north of the sources of the Chindwin river, and with the Kumon range and the hills of the Jade and Amber mines, make up a highland tract separated from the great Northern Shan plateau by the gorges of the Irrawaddy river. On the east the Kachin, Shan and Karen hills, extending from the valley of the Irrawaddy into China far beyond the Salween gorge, form a continuous barrier and boundary, and tail off into a narrow range which forms the eastern watershed of the Salween and separates Tenasserim from Siam. The highest peak of the Arakan Yomas, Liklang, rises nearly 10,000 ft. above the sea, and in the eastern Kachin hills, which run northwards from the state of Mong Mit to join the high range dividing the basins of the Irrawaddy and the Salween, are two peaks, Sabu and Worang, which rise to a height of 11,200 ft. above the sea. The Kumon range running down from the Hkasi country east of Assam to near Mogaung ends in a peak known as Shwedaunggyi, which reaches some 5750 ft. There are several peaks in the Ruby Mines district which rise beyond 7000 ft. and Loi Ling in the Northern Shan States reaches 9000 ft. Compared with these ranges the Pegu Yomas assume the proportions of mere hills. Pops, a detached peak in the Myingyan district, belongs to this system and rises to a height of nearly 5000 ft., but it is interesting mainly as an extinct volcano, a landmark and an object of superstitious folklore, throughout the whole of Central Burma. Mud volcanoes occur at Minbu, but they are not in any sense mountains, resembling rather the hot springs which are found in many parts of Burma. They are merely craters raised above the level of the surrounding country by the gradual accretion of the soft oily mud, which overflows at frequent intervals whenever a discharge of gas occurs. Spurs of the Chin hills run down the whole length of the Lower Chindwin district, almost to Sagaing, and one hill, Powindaung, is particularly noted on account of its innumerable cave temples, which are said to hold no fewer than 446,444 images of Buddha. Huge caves, of which the most noted are the Farm Caves, occur in the hills near Moulmein, and they too are full of relics of their ancient use as temples, though now they are chiefly visited in connexion with the bats, whose flight viewed from a distance, as they issue from the caves, resembles a cloud of smoke.

Rivers.—Of the rivers of Burma the Irrawaddy is the most important. It rises possibly beyond the confines of Burma in the unexplored regions, where India, Tibet and China meet, and seems to be formed by the junction of a number of considerable streams of no great length. Two rivers, the Mali and the N'mai, meet; about latitude 25° 45' some 150 m. north of Bhamo, contribute chiefly to its volume, and during the dry weather it is navigable for steamers up to their confluence. Up to Bhamo, a distance of 900 m. from the sea, it is navigable throughout the year, and its chief tributary in Burma, the Chindwin, is also navigable for steamers for 300 m. from its junction with the Irrawaddy at Pakökku. The Chindwin, called in its upper reaches the Tanai, rises in the N.W. south-west of Thama, and flows due north till it enters the south-east corner of the Hukawng valley, where it turns north-west and continues in that direction cutting the valley into two almost equal parts until it reaches its north-west range, when it turns almost due south and takes the name of the Chindwin. It is a swift clear river, fed in its upper reaches by numerous mountain streams. The Mogaung river, rising in the watershed which divides the Irrawaddy and the Chindwin drainages, flows south and south-east for 180 m. before it joins the Irrawaddy, and is navigable for steamers as far as Kamaing for about four months in the year. South of Thayetmyo, where arms of the Arakan Yomas approach the river and almost meet that spur of the Pegu Yomas which formed till 1886 the

thern boundary of British Burma, the valley of the Irrawaddy runs out again, and at Yegin Mingyi near Myanaung the influence of the tide is first felt, and the delta may be said to begin. The called rivers of the delta, the Ngawun, Pyamalaw, Panmawaddy, Inzalu and Pantanaw, are simply the larger mouths of the Irrawaddy, and the whole country towards the sea is a close network of dikes where there are few or no roads and boats take the place of roads for every purpose. There is, however, one true river of some importance, the Hlaing, which rises near Promé, flows southwards and is the Pegu river and the Pasungung creek near Rangoon, and forms an estuary which is known as the Rangoon river and constitutes the harbour of Rangoon. East of the Rangoon river still within the deltaic area, though cut off from the main delta by the southern end of the Pegu Yomas, lies the mouth of the Ng. This river, rising in the Sham-Karen hills, flows first due north and then southward through the Kyaukse, Yamethin and Igo districts, its line being followed by the Mandalay-Rangoon road as far south as Nyaunglebin in the Pegu district. At Igo it is narrow, but below Shwegyin it widens, and at Sittang it is a mile broad. It flows into the Gulf of Martaban, and near its mouth its course is constantly changing owing to erosion and ponding accretions. The second river in the province in point of size is the Salween, a huge river, believed from the volume of its waters to rise in the Tibetan mountains to the north of Lhasa. It is probably actually longer than the Irrawaddy, but it is not so important. It is, in fact, walled either side, with banks varying in British territory from 500 to 1000 ft. high and at present un navigable owing to serious silting in Lower Burma and at one or two places in the Shan States, it is open to traffic for considerable reaches in its middle course. The Ayeyar and the Attaran rivers meet the Salween at its mouth, and the three rivers form the harbour of Moulmein, the second of Burma.

3.—The largest lake in the province is Indawgyi in the Inle district. It has an area of nearly 100 sq. m. and is bounded on three sides by ranges of hills, but is open to the north by an outlet in the Indaw river. In the highlands of the Inle there are the Inle lakes near Yawngweh, and in the Katha also there is another Indaw which covers some 60 sq. m. lakes are the Paunglin lake in Minbu district, the Inma lake in the Tu and Duya in Henzada, the Shahkgyi and the Inyegyi in the sacred lake at Ye in Tenasserim, and the Nagamaik, Raung and Walonbyan in Arakan. The Meiktila lake covers some 5 sq. m., but it is to some extent at least an artificial lake. In the heart of the delta numerous large lakes or marshes are formed by the overflow of the Irrawaddy river in rainy season, but these either assume very diminutive sizes or disappear altogether in the dry season.

4.—The climate of the delta is cooler and more temperate than the rest of Burma, and this is shown in the fairer complexion and physique of the people of the lower province as compared with the inhabitants of the drier and hotter upper districts as far as where there is a great infusion of other types of the Tibeto-Burmese family. North of the apex of the delta and the boundary of the deltaic and inland tracts, the rainfall gradually lessens, and extends as far as Katha. The rainfall in the coast districts varies from about 200 in. in the Arakan and Tenasserim to an average of 90 in Rangoon and the adjoining portion of the waddy delta. In the extreme north of Upper Burma the rainfall is rather less than in the country adjoining Rangoon, and the annual average falls as low as 20 and 30 in. The temperature varies almost as much as the rainfall. In the central zone, the mean of the maximum readings in the districts as Magwe, Myingyan, Kyaukse, Mandalay and the month of May being close on 100° F., while in the sub-montane districts it is nearly ten degrees less. The minimum readings in December in the central zone are few degrees under 60° F. and in the littoral districts a few degrees over that figure. In the hilly district of Mogok (Ruby) the December mean minimum is 36.8° and the mean maximum is 64.4°. The climate of the Chin and Kachin hills and also of the rest of the mountainous region is more temperate. In the shade and off the ground the temperature rarely rises above 80° F. or falls below 25° F. In the open air in the sun as much as 150° F. is registered, and on the hottest weather ten degrees of frost are not uncommon. Frost is seen either in the Chin or Shan hills, but there are no frosts in the extreme north of the Kachin country. In the valleys of the Shan hills, and especially in the Salween valley, the maximum reaches 100° F. regularly for several days. The rainfall in the hills varies very considerably, ranging from about 60 in. in the broader valleys to about 10 in. in the higher forest-clad ranges. Geologically, British Burma consists of two divisions, the eastern and the western. The dividing line runs from the mouth of the Irrawaddy along the railway to Mandalay, and thence northward, with the same general direction but curving to the east. West of this line the rocks are chiefly Palaeozoic; east of it they are mostly Palaeozoic or Tertiary; west of the western mountain ranges the beds are thrown into

a series of folds which form a gentle curve running from south to north with its convexity facing westward. There is an axial zone of Cretaceous and Lower Eocene, and this is flanked on each side by the Upper Eocene and the Miocene, while the valley of the Irrawaddy is occupied chiefly by the Pliocene. Along the southern part of the Arakan coast the sea spreads over the western Miocene zone. The Cretaceous beds have not yet been separated from the overlying Eocene, and the identification of the system rests on the discovery of a single Cenomanian ammonite. The Eocene beds are marine and contain nummulites. The Miocene beds are also marine and are characterized by an abundant molluscan fauna. The Pliocene, on the other hand, is of freshwater origin, and contains silicified wood and numerous remains of Mammalia. Flint chips, which appear to have been fashioned by hand, are said to have been found in the Miocene beds, but to prove the existence of man at so early a period would require stronger evidence than has yet been brought forward.

The older rocks of eastern Burma are very imperfectly known. Gneiss and granite occur; Ordovician fossils have been found in the Upper Shan States, and Carboniferous fossils in Tenasserim and near Moulmein. Volcanic rocks are not common in any part of Burma, but about 50 m. north-north-east of Yenangyaung the extinct volcano of Popa rises to a height of 3000 ft. above the surrounding Pliocene plain. Intrusions of a serpentine-like rock break through the Miocene strata north of Bhamo, and similar intrusions occur in the western ranges. Whether the mud "volcanoes" of the Irrawaddy valley have any connexion with volcanic activity may be doubted. The petroleum of Burma occurs in the Miocene beds, one of the best-known fields being that of Yenangyaung. Coal is found in the Tertiary deposits in the valley of the Irrawaddy and in Tenasserim. Tin is abundant in Tenasserim, and lead and silver have been worked extensively in the Shan States. The famous ruby mines of Upper Burma are in metamorphic rock, while the jadeite of the Bhamo neighbourhood is associated with the Tertiary intrusions of serpentine-like rock already noticed.¹

Population.—The total population of Burma in 1901 was 10,490,624 as against 7,722,953 in 1891; but a considerable portion of this large increase was due to the inclusion of the Shan States and the Chin hills in the census area. Even in Burma proper, however, there was an increase during the decade of 1,530,822, or 19.8%. The density of population per square mile is 44 as compared with 167 for the whole of India and 552 for the Bengal Delta. England and Wales have a population more than twelve times as dense as that of Burma, so there is still room for expansion. The chief races of Burma are Burmese (6,508,682), Arakanese (405,143), Karens (717,859), Shans (787,087), Chins (179,292), Kachins (64,405) and Talings (321,898); but these totals do not include the Shan States and Chin hills. The Burmese in person have the Mongoloid characteristics common to the Indo-Chinese races, the Tibetans and tribes of the Eastern Himalaya. They may be generally described as of a stout, active, well-proportioned form; of a brown but never of an intensely dark complexion, with black, coarse, lank and abundant hair, and a little more beard than is possessed by the Siamese. Owing to their gay and lively disposition the Burmese have been called "the Irish of the East," and like the Irish they are somewhat inclined to laziness. Since the advent of the British power, the immigration of Hindus with a lower standard of comfort and of Chinamen with a keener business instinct has threatened the economic independence of the Burmese in their own country. As compared with the Hindu, the Burmese wear silk instead of cotton, and eat rice instead of the cheaper grains; they are of an altogether freer and less servile, but also of a less practical character. The Burmese women have a keener business instinct than the men, and serve in some degree to redress the balance. The Burmese children are adored by their parents, and are said to be the happiest and merriest children in the world.

Language and Literature.—The Burmese are supposed by modern philologists to have come, as joint members of a vast Indo-Chinese immigration swarm, from western China to the head waters of the Irrawaddy and then separated, some to people Tibet and Assam, the others to press southwards into the

¹ See also, for geology, W. Theobald, "On the Geology of Pegu," *Mem. Geol. Surv. India*, vol. x. pt. ii. (1874); F. Noetling, "The Development and Subdivision of the Tertiary System in Burma," *Rec. Geol. Surv. India*, vol. xviii. (1895), pp. 59-86, pl. ii.; F. Noetling, "The Occurrence of Petroleum in Burma, and its Technical Exploitation," *Mem. Geol. Surv. India*, vol. xvii. pt. ii. (1898).

plains of Burma. The indigenous tongues of Burma are divided into the following groups:—

- | | | |
|------------------------|--------------------------------|--|
| A. Indo-Chinese family | (1) Tibet-Burman sub-family | (a) The Burmese group.
(b) The Kachin group.
(c) The Kuki-Chin group. |
| | (2) Siamese-Chinese sub-family | (d) The Tai group.
(e) The Karen group. |
| | (3) Môn-Aram sub-family | (f) The Upper Middle Mekong or Wa Palaung group.
(g) The North Cambodian group. |
| B. Malay family | | (h) The Selung language. |

Burmese, which was spoken by 7,006,495 people in the province in 1901, is a monosyllabic language, with, according to some authorities, three different tones; so that any given syllable may have three entirely different meanings only distinguishable by the intonation when spoken, or by accents or diacritical marks when written. There are, however, very many weighty authorities who deny the existence of tones in the language. The Burmese alphabet is borrowed from the Aryan Sanskrit through the Pali of Upper India. The language is written from left to right in what appears to be an unbroken line. Thus Burma possesses two kinds of literature, Pali and Burmese. The Pali is by far the more ancient, including as it does the Buddhist scriptures that originally found their way to Burma from Ceylon and southern India. The Burmese literature is for the most part metrical, and consists of religious romances, chronological histories and songs. The *Maha Yazawin* or "Royal Chronicle" forms the great historical work of Burma. This is an authorized history, in which everything unflattering to the Burmese monarchs was rigidly suppressed. After the Second Burmese War no record was ever made in the *Yazawin* that Pegu had been torn away from Burma by the British. The folk songs are the truest and most interesting national literature. The Burmese are fond of stage-plays in which great licence of language is permitted, and great liberty to "gag" is left to the wit or intelligence of the actors.

Government.—The province as a division of the Indian empire is administered by a lieutenant-governor, first appointed 1st May 1897, with a legislative council of nine members, five of whom are officials. There are, besides, a chief secretary, revenue secretary, secretary and two under-secretaries, a public works department secretary with two assistants. The revenue administration of the province is superintended by a financial commissioner, assisted by two secretaries, and a director of land records and agriculture, with a land records departmental staff. There is a chief court for the province with a chief justice and three justices, established in May 1900. Other purely judicial officers are the judicial commissioner for Upper Burma, and the chief judges of Mandalay and Moulmein. There are four commissioners of revenue and circuit, and nineteen deputy commissioners in Lower Burma, and four commissioners and seventeen deputy commissioners in Upper Burma. There are two superintendents of the Shan States, one for the northern and one for the southern Shan States, and an assistant superintendent in the latter; a superintendent of the Arakan hill tracts and of the Chin hills, and a Chinese political adviser taken from the Chinese consular service. The police are under the control of an inspector-general, with deputy inspector-general for civil and military police, and for supply and clothing. The education department is under a director of public instruction, and there are three circles—eastern, western and Upper Burma, each under an inspector of schools.

The Burma forests are divided into three circles each under a conservator, with twenty-one deputy conservators. There are also a deputy postmaster-general, chief superintendent and four superintendents of telegraphs, a chief collector of customs, three collectors and four port officers, and an inspector-general of jails. At the principal towns benches of honorary magistrates,

exercising powers of various degrees, have been constituted. There are forty-one municipal towns, fourteen of which are in Upper Burma. The commissioners of division are *ex officio* sessions judges in their several divisions, and also have civil powers, and powers as revenue officers. They are responsible to the lieutenant-governor, each in his own division, for the working of every department of the public service, except the military department, and the branches of the administration directly under the control of the supreme government. The deputy commissioners perform the functions of district magistrates, district judges, collectors and registrars, besides the miscellaneous duties which fall to the principal district officer as representative of government. Subordinate to the deputy commissioners are assistant commissioners, extra-assistant commissioners and myoüks, who are invested with various magisterial, civil and revenue powers, and hold charge of the townships, as the units of regular civil and revenue jurisdiction are called, and the sub-divisions of districts, into which most of these townships are grouped. Among the salaried staff of officials, the township officers are the ultimate representatives of government who come into most direct contact with the people. Finally, there are the village headmen, assisted in Upper Burma by elders, variously designated according to old custom. Similarly in the towns, there are headmen of wards and elders of blocks. In Upper Burma these headmen have always been revenue collectors. The system under which in towns headmen of wards and elders of blocks are appointed is of comparatively recent origin, and is modelled on the village system.

The Shan States were declared to be a part of British India by notification in 1886. The Shan States Act of 1888 vests the civil, criminal and revenue administration in the chief of the state, subject to the restrictions specified in the *Shan States* or patent granted to him. The law to be administered in each state is the customary law of the state, so far as it is in accordance with the justice, equity and good conscience, and not opposed to the spirit of the law in the rest of British India. The superintendents exercise general control over the administration of criminal justice, and have power to call for cases, and to exercise wide revisionary powers. Criminal jurisdiction in cases in which either the complainant or the defendant is a European, or American, or a government servant, or a British subject not a native of a Shan State, is withdrawn from the chiefs and vested in the superintendents and assistant superintendents. Neither the superintendents nor the assistant superintendents have power to try civil suits, whether the parties are Shans or not. In the Myelat division of the southern Shan States, however, the criminal law is practically the same as the law in force in Upper Burma, and the ngwegunhmus, or petty chiefs, have been appointed magistrates of the second class. The chiefs of the Shan States are of three classes—(1) sawbwas; (2) rhyomas; (3) ngwegunhmus. The last are found only in the *Myelat*, or border country between the southern Shan States and Burma. There are fifteen sawbwas, sixteen rhyomas and thirteen ngwegunhmus in the Shan States proper. Two sawbwas are under the supervision of the commissioner of the Mandalay division, and two under the commissioner of the Sagaing division. The states vary enormously in size, from the 12,000 sq. m. of the Trans-Salween State of King Tung, to the 3,95 sq. m. of Nam Hkâm in the Myelat. The latter contained only 41 houses with 210 inhabitants in 1897 and has since been merged in the adjoining state. There are five states, all sawbwaships, under the supervision of the superintendent of the northern Shan States, besides an indeterminate number of Wa States and communities of other races beyond the Salween river. The superintendent of the southern Shan States supervises thirty-nine, of which ten are sawbwaships. The headquarters of the northern Shan States are at Lashio, of the southern Shan States at Taung-gi. The states included in eastern and western Karen-ia are not part of British India, and are not subject to any of the laws in force in the Shan States, but they are under the supervision of the superintendent of the southern Shan States.

The northern portion of the Karen hills is at present dealt with on the principle of political as distinguished from administrative control. The tribes are not interfered with as long as they keep the peace. What is specifically known as the Kachin hills, the country taken under administration in the Bhamo and Myitkyina districts, is divided into forty tracts. Beyond these tracts there are many Kachins in Katha, Mông-Mit, and the northern Shan States, but though they are often the preponderating, they are not the exclusive population. The country within the forty tracts may be considered the Kachin hills proper, and it lies between 23° 30' and 26° 30' N. lat. and 96° and 98° E. long. Within this area the petty chiefs have appointment orders, the people are disarmed, and the rate of tribute per household is fixed in each case. Government is regulated by the

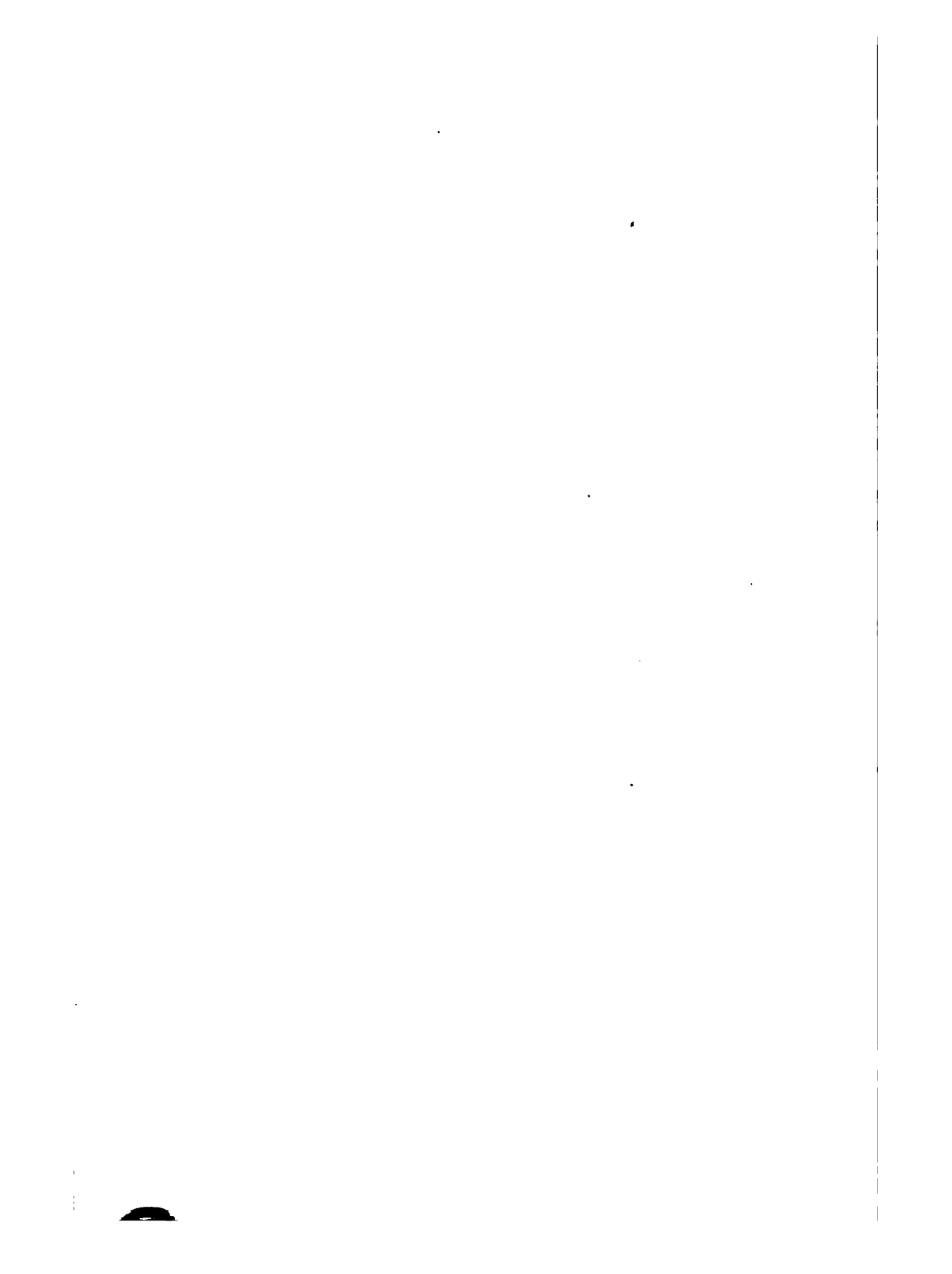

achin hill regulation. Since 1894 the country has been practically adulated, and large numbers of Kachins are enlisted, and ready to enlist in the military police, and seem likely to form as good troops as the Gurkhas of Nepal.

The Chin hills were not declared an integral part of Burma until 1895, but they now form a scheduled district. The chiefs, however, are allowed to administer their own affairs, as far as may be, in accordance with their own customs, subject to the supervision of a superintendent of the Chin hills.

Religion.—Buddhists make up more than 88-6%; Mussulmans 8; spirit-worshippers 3-85; Hindus 2-76, and Christians 1-42 the total population of the province. The large nominal proportion of Buddhists is deceptive. The Burmese are really as decided to denounce as the hill-tribes who are labelled plain spirit-worshippers. The actual figures of the various religions, according to the census of 1901, are as follows:—

Bhists	9,184,121	Sikhs	6,596
pirit-worshippers	399,390	Jews	685
Hindus	285,484	Parsees	243
Mussulmans	339,446	Others	28
Christians	147,525		

The chief religious principle of the Burmese is to acquire merit for their next incarnation by good works done in this life. The sale of alms offerings of rice to priests, the founding of a monastery, the erection of pagodas, with which the country is crowded, the building of a bridge or rest-house for the convenience of travellers, the works of religious merit, prompted, not by love of one's fellow-men, but simply and solely for one's own future advantage. Analysis shows that not quite two in every thousand Burmese are Christians, and there are about the same number of Mahommedans among them. It is admitted by the missionaries themselves that Christianity has progressed very slowly among the Burmese in comparison with the rapid progress made amongst the Karens, amongst the Sgaw Karens that the greatest progress in Christianity has been made, and the number of spirit-worshippers among the very much smaller. The number of Burmese Christians is rapidly increased by the inclusion among them of the Christian converts of the Portuguese settlers of Syriam deported to the old town of Tabayin, a village now included in the Yen subdivision. These Christians returned themselves as Burmese, and of Christianity which make most converts in Burma are the Roman Catholic faiths. Of recent years many converts to Christianity have been made by the American Baptist missionaries amongst the Lahu or Mubo hill tribesmen.

Education.—Compared with other Indian provinces, and even with the countries of Europe, Burma takes a very high place in terms of those able to both read and write. Taking the sexes together, men fall far behind men in the matter of education, men are better educated in Burma than in the rest of India. The average number of each sex in Burma per thousand is:—male 378; female, 45; illiterates, male, 622; female, 955. The proportion of literates per thousand in Bengal is:—male, 104; female, 109.

The proportion was greatly reduced in the 1901 census in the Shan States and the Chin hills, which mostly are illiterates.

That in Upper Burma the proportion of literates is nearly double that of those under instruction even higher than of the corresponding classes in Lower Burma, is a clear indication of primary education, at least, the credit for the superiority of the Shan people over the native of India is due to indigenous schools. In every village in the province there is a monastery, where the regular occupation of one or more of the resident *paugyis*, or monks, is the instruction free of charge of the children of the village. The standard of instruction, however, is very low, very of reading and writing, though this is gradually being improved by many monasteries. The absence of all prejudice against the seclusion of women also is one of the main reasons for the proportion who can read and write is higher in the Shan part of India, Cochin alone excepted. It was not until the education department took action in Upper Burma, that it ascertained that there were 684 public schools with 15,000 and 1664 private schools with 8683 pupils. It is a mark that of these schools 29 were Mahommedan, and there are 176 schools for girls in which upwards of 2000 pupils are receiving instruction.

There are three circles—Eastern, Central and Upper Burma—under the special supervision and encouragement of indigenous education in monastic and in lay schools, each circle of which is divided into sub-circles corresponding with one or more districts, and each sub-circle is placed under a deputy-sub-inspector of schools. There are nine standards of education in the classes in schools correspond with these standards. In all educational grants are paid from imperial funds as well as in Lower Burma. Grants-in-aid are given to private schools. There is only one college, at Rangoon, which is the Calcutta University. There are missionary schools in the Kachins, Kachins and Shans, and a school for the sons of the Shan people in the southern Shan States. A *Palamo* system of marks in the Pali language was first instituted in 1894.

Finance.—The gross revenue of Lower Burma from all sources in 1871-1872 was Rs.1,36,34,550, of which Rs.1,21,70,530 was from imperial taxation, Rs.3,73,200 from provincial services, and Rs.10,90,790 from local funds. The land revenue of the province was Rs.34,45,230. In Burma the cultivators themselves continue to hold the land from government, and the extent of their holdings averages about five acres. The land tax is supplemented by a poll tax on the male population from 18 to 60 years of age, with the exception of immigrants during the first five years of their residence, religious teachers, schoolmasters, government servants and those unable to obtain their own livelihood. In 1890-1891 the revenue of Lower Burma has risen to Rs.2,08,38,872 from imperial taxation, Rs.1,55,51,897 for provincial services, and Rs.12,14,596 from incorporated local funds. The expenditure on the administration of Lower Burma in 1870-1871 was Rs.2,70,020. In 1890-1891 it was Rs.1,58,48,041. In Upper Burma the chief source of revenue is the *thakameda*, a tithe or income tax which was instituted by King Mindon, and was adopted by the British very much as they found it. For the purpose of the assessment every district and town is classified according to its general wealth and prosperity. As a rule the basis of calculation was 100 rupees from every ten houses, with a 10% deduction for those exempted by custom. When the total amount payable by the village was thus determined, the village itself settled the amount to be paid by each individual householder. This was done by *thamadis*, assessors, usually appointed by the villagers themselves. Other important sources of revenue are the rents from state lands, forests, and miscellaneous items such as fishery, revenue and irrigation taxes. In 1886-1887, the year after the annexation, the amount collected in Upper Burma from all sources was twenty-two lakhs of rupees. In the following year it had risen to fifty lakhs. Much of Upper Burma, however, remained disturbed until 1890. The figures for 1890-1891, therefore, show the first really regular collection. The amount then collected was Rs.87,47,020.

The total revenue of Burma in the year ending March 31, 1900 was Rs.7,04,36,240 and in 1905, Rs.9,65,62,298. The total expenditure in the same years respectively was Rs.4,30,81,000 and Rs.5,66,60,047. The principal items of revenue in the budget are the land revenue, railways, customs, forests and excise.

Defence.—Burma is garrisoned by a division of the Indian army, consisting of two brigades, under a lieutenant-general. Of the native regiments seven battalions are Burma regiments specially raised for permanent service in Burma by transformation from military police. These regiments, consisting of Gurkhas, Sikhs and Pathans, are distributed throughout the Shan States and the northern part of Burma. In addition to these there are about 13,500 civil police and 15,000 military police. The military police are in reality a regular military force with only two European officers in command of each battalion; and they are recruited entirely from among the warlike races of northern India. A small battalion of Karens enlisted as sappers and miners proved a failure and had to be disbanded. Experiments have also been made with the Kachin hillmen and with the Shans; but the Burmese character is so averse to discipline and control in petty matters that it is impossible to get really suitable men to enlist even in the civil police. The volunteer forces consist of the Rangoon Port Defence Volunteers, comprising artillery, naval, and engineer corps, the Moulmein artillery, the Moulmein, Rangoon, Railway and Upper Burma rifles.

Minerals and Mining.—In its three chief mineral products, earth-oil, coal and gold, Burma offers a fair field for enterprise and nothing more. Without yielding fortunes for speculators, like South Africa or Australia, it returns a fair percentage upon genuine hard work. Coal is found in the Thayetmyo, Upper Chindwin and Shebo districts, and in the Shan States; it also occurs in Mergui, but the deposits which have been so far discovered have been either of inferior quality or too far from their market to be worked to advantage. The tin mines in Lower Burma are worked by natives, but a company at one time worked mines in the Malawun township of Mergui by European methods. The chief mines and minerals are in Upper Burma. The jade mines of Upper Burma are now practically the only source of supply of that mineral, which is in great demand over all China. The mines are situated beyond Kamaing, north of Mogaung in the Myitkyina district. The miners are all Kachins, and the right to collect the jade duty of 33% is farmed out by government to a lessee, who has hitherto always been a Chinaman. The amount obtained has varied considerably. In 1887-1888 the rent was Rs.50,000. This dwindled to Rs.36,000 in 1892-1893, but the system was then adopted of letting for a term of three years and a higher rent was obtained. The value varies enormously according to colour, which should be a particular shade of dark green. Semi-transparency, brilliancy and hardness are, however, also essential. The old river mines produced the best quality. The quarry mines on the top of the hill near Tawna produce enormous quantities, but the quality is not so good.

The most important ruby-bearing area is the Mogok stone tract, in the hills about 60 m. east of the Irrawaddy and 90 m. north-north-west of Mandalay. The right to mine for rubies by European methods and to levy royalties from persons working by native methods was leased to the Burma Ruby Mines Company, Limited, in 1889, and the lease was renewed in 1896 for 14 years at a rent of Rs.3,15,000 a year plus a share of the profits. The rent was

reduced permanently in 1898 to Rs.2,00,000 a year, but the share of the profits taken by government was increased from 20 to 30%. There are other ruby mines at Nanyaseik in the Myitkyina district and at Sagyin in the Mandalay district, where the mining is by native methods under licence-fees of Rs.5 and Rs.10 a month. They are, however, only moderately successful. Gold is found in most of the rivers in Upper Burma, but the gold-washing industry is for the most part spasmodic in the intervals of agriculture. There is a gold mine at Kyaukpazat in the Mawnaing circle of the Katha district, where the quartz is crushed by machinery and treated by chemical processes. Work was begun in 1895, and the yield of gold in that year was 274 oz., which increased to 893 oz. in 1896-1897. This, however, proved to be merely a pocket, and the mine is now shut down. Dredging for gold, however, seems likely to prove very profitable and gold dust is found in practically every river in the hills. The principal seats of the petroleum industry are Yenangyat in the Magwe, and Yenangyat in the Paköku districts. The wells have been worked for a little over a century by the natives of the country. The Burma Oil Company since 1889 has worked by drilled wells on the American or cable system, and the amount produced is yearly becoming more and more important.

Amber is extracted by Kachins in the Hukawng valley beyond the administrative border, but the quality of the fossil resin is not very good. The amount exported varies considerably. Tourmaline or rubellite is found on the borders of the Ruby Mines district and in the Shan State of Móng Lóng. Steatite is extracted from the Arakan hill quarries. Salt is manufactured at various places in Upper Burma, notably in the lower Chindwin, Sagaing, Shwebo, Myingyan and Yamethin districts, as well as at Mawhkiö in the Shan State of Thibaw. Iron is found in many parts of the hills, and is worked by inhabitants of the country. A good deal is extracted and manufactured into native implements at Pang Lóng in the Lgya (Laihka) Shan State. Lead is extracted by a Chinese lessee from the mines at Bawzaing (Maw-56) in the Myelat, southern Shan States. The ore is rich in silver as well as in lead.

Agriculture.—The cultivation of the land is by far the most important industry in Burma. Only 4% of the people were classed as urban in the census of 1901, and a considerable proportion of this number were natives of India and not Burmese. Nearly two-thirds of the total population are directly or indirectly engaged in agriculture and kindred occupations. Throughout most of the villages in the rural tracts men, women and children all take part in the agricultural operations, although in riverine villages whole families often support themselves from the sale of petty commodities and eatables. The food of the people consists as a rule of boiled rice with salted fresh or dried fish, salt, sesamum-oil, chillies, onions, turmeric, boiled vegetables, and occasionally meat of some sort from elephant flesh down to smaller animals, fowls and almost everything except snakes, by way of condiment.

The staple crop of the province in both Upper and Lower Burma is rice. In Lower Burma it is overwhelmingly the largest crop; in Upper Burma it is grown wherever practicable. Throughout the whole of the moister parts of the province the agricultural season is the wet period of the south-west monsoon, lasting from the middle of May until November. In some parts of Lower Burma and in the dry districts of Upper Burma a hot season crop is also grown with the assistance of irrigation during the spring months. Oxen are used for ploughing the higher lands with light soil, and the heavier and stronger buffaloes for ploughing wet tracts and marshy lands. As rice has to be transplanted as well as sown and irrigated, it needs a considerable amount of labour expended on it; and the Burman has the reputation of being a somewhat indolent cultivator. The Karens and Shans who settle in the plains expend much more care in ploughing and weeding their crops. Other crops which are grown in the province, especially in Upper Burma, comprise maize, tilseed, sugar-cane, cotton, tobacco, wheat, millet, other food grains including pulse, condiments and spices, tea, barley, sago, linseed and other oil-seeds, various fibres, indigo and other dye crops, besides orchards and garden produce. At the time of the British annexation of Burma there were some old irrigation systems in the Kyaukse and Minbu districts, which had been allowed to fall into disrepair, and these have now been renewed and extended. In addition to this the Mandalay Canal, 40 m. in length, with fourteen distributaries was opened in 1902; the Shwebo canal, 27 m. long, was opened in 1906, and a beginning had been made of two branches 29 and 20 m. in length, and of the Mön canal, begun in 1904, 53 m. in length. In all upwards of 300,000 acres are subject to irrigation under these schemes. On the whole the people of Burma are prosperous and contented. Taxes and land revenue are light; markets for the disposal of produce are constant and prices good; while fresh land is still available in most districts. Compared with the congested districts in the other provinces of India, with the exception of Assam, the lot of the Burman is decidedly enviable.

Forests.—The forests of Burma are the finest in British India and

one of the chief assets of the wealth of the country; it is from Burma that the world draws its main supply of teak for shipbuilding, and indeed it was the demand for teak that largely led to the annexation of Burma. At the close of the First Burmese War in 1826 Tenasserim was annexed because it was supposed to contain large supplies of this valuable timber; and it was trouble with a British forest company that directly led to the Third Burmese War of 1853. Since the introduction of iron ships teak has supplanted oak, because it contains an essential oil which preserves iron and steel, instead of corroding them like the tannic acid contained in oak. The forests of Burma, therefore, are now strictly preserved by the government and there is a regular forest department for the conservation and cutting of timber, the planting of young trees for future generations, the prevention of forest fires, and for generally supervising their treatment by the natives. In the reserves the trees of commercial value can only be cut under a licence returning a revenue to the state, while unreserved trees can be cut by the natives for home consumption. There are naturally very many trees in these forests besides the teak. In Lower Burma alone the enumeration of the trees made by Sulpis Kurz in his *Forest Flora of British Burma* (1877) includes some 1500 species, and the unknown species of Upper Burma and the Shan States would probably increase this total very considerably. In addition to teak, which provides the bulk of the revenue, the most valuable woods are *sha* or cutch, india rubber, *pyingado*, or ironwood for railway sleepers, and *padanai*. Outside these reserves enormous tracts of forest and jungle still remain for clearance and cultivation, reservation being mostly confined to forest land unsuitable for crops. In 1870-1871 the state reserved forests covered only 133 sq. m., in all the Rangoon division. The total receipts from the forests then amounted to Rs.7,72,400. In 1889-1890 the total area of reserved forests in Lower Burma was 5574 sq. m., and the gross revenue was Rs. 31,34,720, and the expenditure was Rs. 13,31,930. The work of the forest department did not begin in Upper Burma till 1891. At the end of 1892 the reserved forests in Upper Burma amounted to 1059 sq. m. On 30th June 1896 the reserved area amounted to 5438 sq. m. At the close of 1899 the area of the reserved forests in the whole province amounted to 15,669 sq. m., and in 1903-1904 to 20,038 sq. m. with a revenue of Rs. 85,19,404 and expenditure amounting to Rs.35,00,311. In 1905-1906 there were 20,545 sq. m. of reserved forest, and it is probable that when the work of reservation is complete there will be 25,000 sq. m. of preserves or 12% of the total area.

Fisheries.—Fisheries and fish-curing exist both along the sea-coast of Burma and in inland tracts, and afforded employment to 126,651 persons in 1907. The chief seat of the industry is in the Thongwa and Bassein districts, where the income from the leased fisheries on individual streams sometimes amounts to between £5000 and £7000 a year. Net fisheries, worked by licence-holders in the principal rivers and along the sea-shore, are not nearly so profitable as the closed fisheries—called *lu*—which are from time to time sold by auction for fixed periods of years. Salted fish forms, along with boiled rice, one of the chief articles of food among the Burmese; and as the price of salted fish is gradually rising along with the prosperity and purchasing power of the population, this industry is on a very sound basis. There are in addition some pearling grounds in the Mergui Archipelago, which have a very recent history; they were practically unknown before 1890; in the early 'nineties they were worked by Australian adventurers, most of whom have since departed; and now they are leased in blocks to a syndicate of Chiamen, who grant sub-leases to individual adventurers at the rate of £25 a pump for the pearling year. The chief harvest is of mother-of-pearl, which suffices to pay the working expenses; and there is over and above the chance of finding a pearl of price. Some pearls worth £1000 and upwards have recently been discovered.

Manufactures and Art.—The staple industry of Burma is agriculture, but many cultivators are also artisans in the by-season. In addition to rice-growing and the felling and extraction of timber, and the fisheries, the chief occupations are rice-husking, silk-weaving and dyeing. The introduction of cheap cottons and silk fabrics has dealt a blow to hand-weaving, while aniline dyes are driving out the native vegetable product; but both industries still linger in the rural tracts. The best silk-weavers are to be found at Amarapura. There large numbers of people follow this occupation as their sole means of livelihood, whereas silk and cotton weaving throughout the province generally is carried on by girls and women while unoccupied by other domestic duties. The Burmese are fond of bright colours, and pink and yellow harmonize well with their dark olive complexion, but even here the influence of western civilization is being felt, and in the towns the tendency now is towards maroon, brown, olive and dark green for the women's skirts. The total number of persons engaged in the production of textile fabrics in Burma according to the census of 1901 was 419,007. The chief dy-product of Burma is cutch, a brown dye obtained from the wood

of the *sha* tree. Cutch-bolling forms the chief means of livelihood of a large number of the poorer classes in the Prome and Thayet-nyo districts of Lower Burma, and a subsidiary means of subsistence elsewhere. Cheroot making and smoking is universal among both sexes. The chief arts of Burma are wood-carving and silver work. The floral wood-carving is remarkable for its freedom and spontaneity. The carving is done in teak wood when it is meant for fixtures, but teak has a coarse grain, and herwise *yumaw* dogwood, said to be a species of *gmelina*, is preferred. The tools employed are chisel, gouge and mallet. The design is traced on the wood with charcoal, gouged out in rough, and finished with sharp fine tools, using the mallet every stroke. The great bulk of the silver work is in the form of bowls of different sizes, in shape something like the upper half of a barrel, only more convex, of betel boxes, cups and tin boxes for lime. Both in the wood-carving and silver work Burmese character displays itself, giving boldness, breadth and freedom of design, but a general want of careful finish. Unfortunately the national art is losing its distinctive type through contact with western civilization.

Merchandise.—The chief articles of export from Burma are rice and timber. In 1895 the quantity of rice exported in the foreign coastal trade amounted to 1,419,173 tons valued at Rs. 77,66,132, and in 1905 the figures were 2,187,764 tons, valued at Rs. 15,67,28,288. England takes by far the greatest share of Burma's rice, though large quantities are also consumed in France, Italy, Belgium and Holland also consume considerable amount. The regular course of trade is apt to be affected by famines in India or Japan. In 1900 over one million tons of rice were shipped to India during the famine there. Rice-mills, almost all situated at the various seaports, process the harvest from the cultivator through middlemen. The value of teak exported in 1895 was Rs. 1,34,64,303, and in 1905, Rs. 1,31,03,401. Subordinate products for exports are cutch dye, caoutchouc or india-rubber, cotton, petroleum and opium. By far the largest of the imports are cotton, silk and piece-goods, while subordinate imports include hardware, sugar, tobacco and liquors.

Following table shows the progressive value of the trade of Burma 1871-1872:—

Year	Imports.	Exports.	Total.
	Ra.	Ra.	Ra.
1871-72	3,15,79,860	3,78,02,170	6,93,82,030
1882	6,38,49,840	8,05,71,410	14,44,21,250
1892	10,50,06,247	12,67,21,878	23,17,28,125
1902	12,78,46,636	18,74,47,200	31,52,93,836
1905	17,06,20,796	23,94,69,114	41,00,89,910

Communications.—In 1871-1872 there were 814 m. of telegraph in Upper Burma, but the chief means of internal communication were steamers plied on the Irrawaddy as far as Thayetmyo. The Irrawaddy Flotilla Company now ply to Bassein and points on the Irrawaddy as far north as Bhamo, and in the other to Myitkyina, and also on the Chindwin as far north as to Homa-in during the rains. The Arakan Flotilla is also helped to open up the Arakan division. The telegraph has not greatly increased in Lower Burma, but there has been a deal of road construction in Upper Burma. At the end of 1904-1905 there were in the whole province 7486 m. of which were metalled and 3170 unmetalled, with other tracks. But the chief advance in communications is railway construction. The first railway from Rangoon to Mandalay, 51 m., was opened in 1877, and that from Rangoon to Bhamo, 5 m., was opened in 1884. Since the annexation of Upper Burma this has been extended to Mandalay, and the Myittha branch has been constructed from Sagaing to Myitkyina, a distance of 52 m. from Rangoon. The Mandalay-Lashio railway is completed, and trains run from Mandalay to Lashio, a distance of 78 m. The Sagaing-Monywa-Alon branch and the Myittha branch were opened to traffic during 1900. The Mandalay-Henzada branch was formed and a communication line from Henzada to Letpadaung was opened in 1903. Railways were also constructed from Pegu to Mandalay, 100 m. in length, and from Henzada to Kyang-in, 66 m. The Mandalay construction was contemplated of a railway from Mandalay to Taung-gyi, the headquarters of the southern Shan States, a total length of lines open in 1904-1905 was 1340 m. Communication in Burma is still very incomplete. Five

of the eight commissionerships and Lashio, the capital of the northern Shan States, have communication with each other by railway, but Taung-gyi and the southern Shan States can still only be reached by a hill-road through difficult country for cart traffic, and the headquarters of three commissionerships, Moulmein, Akyab and Minsu, have no railway communication with Rangoon. Arakan is in the worst position of all, for it is connected with Burma by neither railway nor river, nor even by a metalled road, and the only way to reach Akyab from Rangoon is once a week by sea.

Law.—The British government has administered the law in Burma on principles identical with those which have been adopted elsewhere in the British dominions in India. That portion of the law which is usually described as Anglo-Indian law (see INDIAN LAW) is generally applicable to Burma, though there are certain districts inhabited by tribes in a backward state of civilization which are excepted from its operation. Acts of the British parliament relating to India generally would be applicable to Burma, whether passed before or after its annexation, these acts being considered applicable to all the dominions of the crown in India. As regards the acts of the governor-general in council passed for India generally—they, too, were from the first applicable to Lower Burma; and they have all been declared applicable to Upper Burma also by the Burma Laws Act of 1898. That portion of the English law which has been introduced into India without legislation, and all the rules of law resting upon the authority of the courts, are made applicable to Burma by the same act. But consistently with the practice which has always prevailed in India, there is a large field of law in Burma which the British government has not attempted to disturb. It is expressly directed by the act of 1898 above referred to, that in regard to succession, inheritance, marriage, caste or any religious usage or institution, the law to be administered in Burma is (a) the Buddhist law in cases where the parties are Buddhists, (b) the Mahomedan law in cases where the parties are Mahomedans, (c) the Hindu law in cases where the parties are Hindus, except so far as the same may have been modified by the legislature. The reservation thus made in favour of the native laws is precisely analogous to the similar reservation made in India (see INDIAN LAW, where the Hindu law and the Mahomedan Law are described). The Buddhist law is contained in certain sacred books called *Dhammathats*. The laws themselves are derived from one of the collections which Hindus attribute to Manu, but in some respects they now widely differ from the ancient Hindu law so far as it is known to us. There is no certainty as to the date or method of their introduction. The whole of the law administered now in Burma rests ultimately upon statutory authority; and all the Indian acts relating to Burma, whether of the governor-general or the lieutenant-governor of Burma in council, will be found in the Burma Code (Calcutta, 1899), and in the supplements to that volume which are published from time to time at Rangoon. There is no complete translation of the *Dhammathats*, but a good many of them have been translated. An account of these translations will be found in *The Principles of Buddhist Law* by Chan Toon (Rangoon, 1894), which is the first attempt to present those principles in something approaching to a systematic form.

History.—It is probable that Burma is the *Chryse Regio* of Ptolemy, a name parallel in meaning to *Sonaparanta*, the classic Pāli title assigned to the country round the capital in Burmese documents. The royal history traces the lineage of the kings to the ancient Buddhist monarchs of India. This no doubt is fabulous, but it is hard to say how early communication with Gangetic India began. From the 11th to the 13th century the old Burman empire was at the height of its power, and to this period belong the splendid remains of architecture at Pagan. The city and the dynasty were destroyed by a Chinese (or rather Mongol) invasion (1284 A.D.) in the reign of Kublai Khan. After that the empire fell to a low ebb, and Central Burma was often subject to Shan dynasties. In the early part of the 16th century the Burmese princes of Toungoo, in the north-east of Pegu, began to rise to power, and established a dynasty which at one time held possession of Pegu, Ava and Arakan. They made their capital at Pegu, and to this dynasty belong the gorgeous

descriptions of some of the travellers of the 16th century. Their wars exhausted the country, and before the end of the century it was in the greatest decay. A new dynasty arose in Ava, which subdued Pegu, and maintained their supremacy throughout the 17th and during the first forty years of the 18th century. The Peguans or Talaings then revolted, and having taken the capital Ava, and made the king prisoner, reduced the whole country to submission. Alompra, left by the conqueror in charge of the village of Mátahobo, planned the deliverance of his country. He attacked the Peguans at first with small detachments; but when his forces increased, he suddenly advanced, and took possession of the capital in the autumn of 1753.

In 1754 the Peguans sent an armament of war-boats against Ava, but they were totally defeated by Alompra; while in the districts of Prome, Donubyu, &c., the Burmans revolted, and expelled all the Pegu garrisons in their towns. In 1754 Prome was besieged by the king of Pegu, who was again defeated by Alompra, and the war was transferred from the upper provinces to the mouths of the navigable rivers, and the numerous creeks and canals which intersect the lower country. In 1755 the yuva raja, the king of Pegu's brother, was equally unsuccessful, after which the Peguans were driven from Bassain and the adjacent country, and were forced to withdraw to the fortress of Syriam, distant 12 m. from Rangoon. Here they enjoyed a brief repose, Alompra being called away to quell an insurrection of his own subjects, and to repel an invasion of the Siamese; but returning victorious, he laid siege to the fortress of Syriam and took it by surprise. In these wars the French aided with the Peguans, the English with the Burmans. Duplex, the governor of Pondicherry, had sent two ships to the aid of the former; but the master of the first was decoyed up the river by Alompra, where he was massacred along with his whole crew. The other escaped to Pondicherry. Alompra was now master of all the navigable rivers; and the Peguans, shut out from foreign aid, were finally subdued. In 1757 the conqueror laid siege to the city of Pegu, which capitulated, on condition that their own king should govern the country, but that he should do homage for his kingdom, and should also surrender his daughter to the victorious monarch. Alompra never contemplated the fulfilment of the condition; and having obtained possession of the town, abandoned it to the fury of his soldiers. In the following year the Peguans vainly endeavoured to throw off the yoke. Alompra afterwards reduced the town and district of Tavoy, and finally undertook the conquest of the Siamese. His army advanced to Mergui and Tenasserim, both of which towns were taken; and he was besieging the capital of Siam when he was taken ill. He immediately ordered his army to retreat, in hopes of reaching his capital alive; but he expired on the way, in 1760, in the fiftieth year of his age, after he had reigned eight years. In the previous year he had massacred the English of the establishment of Negrais, whom he suspected of assisting the Peguans. He was succeeded by his eldest son Nounгдаугуи, whose reign was disturbed by the rebellion of his brother Sin-byu-shin, and afterwards by one of his father's generals. He died in little more than three years, leaving one son in his infancy; and on his decease the throne was seized by his brother Sin-byu-shin. The new king was intent, like his predecessors, on the conquest of the adjacent states, and accordingly made war in 1765 on the Manipur kingdom, and also on the Siamese, with partial success. In the following year he defeated the Siamese, and, after a long blockade, obtained possession of their capital. But while the Burmans were extending their conquests in this quarter, they were invaded by a Chinese army of 50,000 men from the province of Yunnan. This army was hemmed in by the skill of the Burmans; and, being reduced by the want of provisions, it was afterwards attacked and totally destroyed, with the exception of 2500 men, who were sent in fetters to work in the Burmese capital at their several trades. In the meantime the Siamese revolted, and while the Burman army was marching against them, the Peguan soldiers who had been incorporated in it rose against their companions, and commencing an indiscriminate massacre, pursued the Burman army to the gates of Rangoon,

which they besieged, but were unable to capture. In 1774 Sin-byu-shin was engaged in reducing the marauding tribes. He took the district and fort of Martaban from the revolted Peguans; and in the following year he sailed down the Irrawaddy with an army of 50,000 men, and, arriving at Rangoon, put to death the aged monarch of Pegu, along with many of his nobles, who had shared with him in the offence of rebellion. He died in 1776, after a reign of twelve years, during which he had extended the Burmese dominions on every side. He was succeeded by his son, a youth of eighteen, called Singumin (Chengua of Symes), who proved himself a bloodthirsty despot, and was put to death by his uncle, Bodawpayá or Mentarayá, in 1781, who ascended the vacant throne. In 1783 the new king effected the conquest of Arakan. In the same year he removed his residence from Ava, which, with brief interruptions, had been the capital for four centuries, to the new city of Amaraapura, "the City of the Immortals."

The Siamese who had revolted in 1771 were never afterwards subdued by the Burmans; but the latter retained their dominion over the sea-coast as far as Mergui. In the year 1785 they attacked the island of Junkseylon with a fleet of boats and an army, but were ultimately driven back with loss; and a second attempt by the Burman monarch, who in 1786 invaded Siam with an army of 30,000 men, was attended with no better success. In 1793 peace was concluded between these two powers, the Siamese yielding to the Burmans the entire possession of the coast of Tenasserim on the Indian Ocean, and the two important seaports of Mergui and Tavoy.

In 1795 the Burmese were involved in a dispute with the British in India, in consequence of their troops, to the amount of 5000 men, entering the district of Chittagong in pursuit of three robbers who had fled from justice across the frontier. Explanations being made and terms of accommodation offered by General Erskine, the commanding officer, the Burmese commander retired from the British territories, when the fugitives were restored, and all differences for the time amicably arranged.

But it was evident that the gradual extension of the British and Burmese territories would in time bring the two powers into close contact along a more extended line of frontier, and in all probability lead to a war between them. It happened, accordingly, that the Burmese, carrying their arms into Assam and Manipur, penetrated to the British border near Sylhet, on the north-east frontier of Bengal, beyond which were the possessions of the chiefs of Cachar, under the protection of the British government. The Burmese leaders, arrested in their career of conquest, were impatient to measure their strength with their new neighbours. It appears from the evidence of Europeans who resided in Ava, that they were entirely unacquainted with the discipline and resources of the Europeans. They imagined that, like other nations, they would fall before their superior tactics and valour; and their cupidity was inflamed by the prospect of marching to Calcutta and plundering the country. At length their chiefs ventured on the open violation of the British territories. They attacked a party of sepoy's within the frontier, and seized and carried off British subjects, while at all points their troops, moving in large bodies, assumed the most menacing positions. In the south encroachments were made upon the British frontier of Chittagong. The island of Shahpura, at the mouth of the Naaf river, had been occupied by a small guard of British troops. These were attacked on the 23rd of September 1823 by the Burmese, and driven from their post with the loss of several lives; and to the repeated demands of the British for redress no answer was returned. Other outrages ensued; and at length, on March 5th, 1824, war was declared by the British government. The military operations, which will be found described under BURMESE WARS, ended in the treaty of Yandaboo on the 24th of February 1826, which conceded the British terms and enabled their army to be withdrawn.

For some years the relations of peace continued undisturbed. Probably the feeling of amity on the part of the Burmese government was not very strong; but so long as the prince by whom the treaty was concluded continued in power, no attempt was

made to depart from its main stipulations. That monarch, Ba-ggi-daw, however, was obliged in 1837 to yield the throne to a usurper who appeared in the person of his brother, Tharawaddi (Tharawadi). The latter, at an early period, manifested not only that hatred of British connexion which was almost universal at the Burmese court, but also the extremest contempt. For several years it had become apparent that the period was approaching when war between the British and the Burmese governments would again become inevitable. The British resident, Major Burney, who had been appointed in 1830, finding his presence at Ava agreeable neither to the king nor to himself, removed in 1837 to Rangoon, and shortly afterwards retired from the country. Ultimately it became necessary to forego even the pretence of maintaining relations of friendship, and the British functionary at that time, Captain Macleod, was withdrawn in 1840 altogether from a country where his continuance would have been but a mockery. The state of sullen dislike which followed was after a while succeeded by more active evidences of hostility. Acts of violence were committed on British ships and British seamen. Remonstrance was consequently made by the British government, and its envoys were supported by a small naval force. The officers on whom devolved the duty of resenting the wrongs of their fellow-countrymen and demanding redress, proceeded to Rangoon, the governor of which place had been a chief actor in the outrages complained of; but so far from them meeting with any signs of regret, that they were treated with indignity and contempt, and compelled to retire without accomplishing anything beyond blockading the ports. Negotiations followed; nothing was demanded of the Burmese beyond a very moderate compensation for the injuries inflicted on the masters of two British vessels, an apology for the insults offered by the governor of Rangoon to the representatives of the British government, and the re-establishment at least the appearance of friendly relations by the reception of a British agent by the Burmese government. But the obduracy of King Pagan, who had succeeded his father in 1846, led to the refusal of atonement for past wrongs, of any expression of regret for the display of gratuitous insolence, and of any concession on the part of the British government to the desire to maintain friendship for the future. The result of the Burmese war was the first shot being fired in 1852. As in the former, though success was varying, the British finally triumphed, and the chief towns in the lower part of the Burmese kingdom fell to them in succession. The Pegu, the capital of that portion which, after having been captured, had again passed into the hands of the enemy, was captured and retained, and the whole province of Pegu was proclaimed of the governor-general, Lord Dalhousie, to be annexed to the British dominions on the 20th of January 1852. No treaty was obtained or insisted upon, the British government being content with the tacit acquiescence of King Pagan without such documents; but its resolution to redress the wrongs of its subjects by any active demonstration of hostility by him followed by retribution. At the same time a revolution broke out which resulted in the dethronement of King Pagan's dethronement. His tyrannical and barbarous rule had made him obnoxious at home as well as abroad, and many of his actions recall the worst passages of the reign of the later Roman emperors. The Mindon prince, who was apprehensive for his own safety, made him prisoner in 1853, and was himself crowned king of Burma at the end of the year. The new monarch, known as King Mindon, showed himself sufficiently arrogant in his dealings with European powers, but was wise enough to keep free from any approach towards hostility. The loss of Pegu was the price of bitter regret, and he absolutely refused to give it up by a formal treaty. In the beginning of 1855 a mission of compliment to Lord Dalhousie, the governor-general, in the summer of the same year Major (afterwards Phayre, *de facto* governor of the new province of Pegu) appointed envoy to the Burmese court. He was accompanied by Captain (afterwards Sir Henry) Yule as secretary, and by a geologist, and his mission added largely to

our knowledge of the state of the country; but in its main object of obtaining a treaty it was unsuccessful. It was not till 1862 that the king at length yielded, and his relations with Britain were placed on a definite diplomatic basis.

In that year the province of British Burma, the present Lower Burma, was formed, with Sir Arthur Phayre as chief commissioner. In 1867 a treaty was concluded at Mandalay providing for the free intercourse of trade and the establishment of regular diplomatic relations. King Mindon died in 1878, and was succeeded by his son King Thibaw. Early in 1879 he excited much horror by executing a number of the members of the Burmese royal family, and relations became much strained. The British resident was withdrawn in October 1879. The government of the country rapidly became bad. Control over many of the outlying districts was lost, and the elements of disorder on the British frontier were a standing menace to the peace of the country. The Burmese court, in contravention of the express terms of the treaty of 1867, created monopolies to the detriment of the trade of both England and Burma; and while the Indian government was unrepresented at Mandalay, representatives of Italy and France were welcomed, and two separate embassies were sent to Europe for the purpose of contracting new and, if possible, close alliances with sundry European powers. Matters were brought to a crisis towards the close of 1885, when the Burmese government imposed a fine of £230,000 on the Bombay-Burma Trading Corporation, and refused to comply with a suggestion of the Indian government that the cause of complaint should be investigated by an impartial arbitrator. An ultimatum was therefore despatched on the 22nd of October 1885. On the 9th of November a reply was received in Rangoon amounting to an unconditional refusal. The king on the 7th of November issued a proclamation calling upon his subjects to drive the British into the sea. On the 14th of November 1885 the British field force crossed the frontier, and advanced to Mandalay without incurring any serious resistance (see BURMESE WARS). It reached Ava on the 26th of November, and an envoy from the king signified his submission. On the 28th of November the British occupied Mandalay, and next day King Thibaw was sent down the river to Rangoon, whence he was afterwards transferred to Ratnagiri on the Bombay coast. Upper Burma was formally annexed on the 1st of January 1886, and the work of restoring the country to order and introducing settled government commenced. This was a more serious task than the overthrow of the Burmese government, and occupied four years. This was in part due to the character of the country, which was characterized as one vast military obstacle, and in part to the disorganization which had been steadily growing during the six years of King Thibaw's reign. By the close of 1889 all the larger bands of marauders were broken up, and since 1890 the country has enjoyed greater freedom from violent crime than the province formerly known as British Burma. By the Upper Burma Village Regulations and the Lower Burma Village Act, the villagers themselves were made responsible for maintaining order in every village, and the system has worked with the greatest success. During the decade 1891-1901 the population increased by 19.8% and cultivation by 53%. With good harvests and good markets the standard of living in Burma has much improved. Large areas of cultivable waste have been brought under cultivation, and the general result has been a contented people. The boundary with Siam was demarcated in 1893, and that with China was completed in 1900.

AUTHORITIES.—Official: Col. Horace Spearman, *British Burma Gazetteer* (2 vols., Rangoon, 1879); Sir J. George Scott, *Upper Burma Gazetteer* (5 vols., Rangoon, 1900-1901). Non-official: Right Rev. Bishop Bigandet, *Life or Legend of Gautama* (3rd ed., London, 1881); G. W. Bird, *Wanderings in Burma* (London, 1897); E. D. Cuming, *In the Shadow of the Pagoda* (London, 1893); *With the Jungle Folk* (London, 1897); Max and Bertha Ferrars, *Burma* (London, 1900); H. Fielding, *The Soul of a People (Buddhism in Burma)* (London, 1898); *Thibaw's Queen* (London, 1899); *A People at School* (1906); Capt. C. J. Forbes, F.S., *Burma* (London, 1878); *Comparative Grammar of the Languages of Farther India* (London, 1881); *Legendary History of Burma and Arakan* (Rangoon, 1882); J. Gordon, *Burma and its Inhabitants* (London, 1876); Mrs E. Hart

Picturesque Burma (London, 1897); Gen. R. Macmahon, *Far Cathay and Farther India* (London, 1892); Rev. F. Mason, D.D., *Burma* (Rangoon, 1866); E. H. Parker, *Burma* (Rangoon, 1892); Sir Arthur Phayre, *History of Burma* (London, 1883); G. C. Rigby, *History of the Operations in Northern Arakan and the Yawdwin Chen Hills* (Rangoon, 1897); Sir J. George Scott, *Burma, As it is, As it was, and As it will be* (London, 1886); Shway Yoe, *The Burman, His Life and Notions* (2nd ed., London, 1896); D. M. Smeaton, *The Karens of Burma* (London, 1887); Sir Henry Yule, *A Mission to Ava* (London, 1858); J. Nisbet, *Burma under British Rule and Before* (London, 1901); V. D. Scott O'Connor, *The Sikkim East* (London, 1904); Talbot Kelly, *Burma* (London, 1905); an exhaustive account of the administration is contained in Dr Alleyne Ireland's *The Province of Burma*, Report prepared on behalf of the university of Chicago (Boston, U.S.A., 2 vols., 1907). (J. G. Sc.)

BURMANN, PIETER (1668-1741), Dutch classical scholar, known as "the Elder," to distinguish him from his nephew, was born at Utrecht. At the age of thirteen he entered the university where he studied under Graevius and Gronovius. He devoted himself particularly to the study of the classical languages, and became unusually proficient in Latin composition. As he was intended for the legal profession, he spent some years in attendance on the law classes. For about a year he studied at Leiden, paying special attention to philosophy and Greek. On his return to Utrecht he took the degree of doctor of laws (March 1688), and after travelling through Switzerland and part of Germany, settled down to the practice of law, without, however, abandoning his classical studies. In December 1691 he was appointed receiver of the tithes which were originally paid to the bishop of Utrecht, and five years later was nominated to the professorship of eloquence and history. To this chair was soon added that of Greek and politics. In 1714 he paid a short visit to Paris and ransacked the libraries. In the following year he was appointed successor to the celebrated Perizonius, who had held the chair of history, Greek language and eloquence at Leiden. He was subsequently appointed professor of history for the United Provinces and chief librarian. His numerous editorial and critical works spread his fame as a scholar throughout Europe, and engaged him in many of the stormy disputes which were then so common among men of letters. Burmann was rather a compiler than a critic; his commentaries show immense learning and accuracy, but are wanting in taste and judgment. He died on the 31st of March 1741.

Burmann edited the following classical authors—Phaedrus (1698); Horace (1699); Valerius Flaccus (1702); Petronius Arbiter (1709); Velleius Paterculus (1719); Quintilian (1720); Justin (1722); Ovid (1727); *Poetae Latini minores* (1731); Suetonius (1736); Lucan (1740). He also published an edition of Buchanan's works, continued Graevius's great work, *Thesaurus Antiquitatum et Historiarum Italiae*, and wrote a treatise *De Vestigaliis populi Romani* (1694) and a short manual of Roman antiquities, *Antiquitatum Romanarum Brevis Descriptio* (1711). His *Sylloge epistolarum a viris illustribus scriptarum* (1725) is of importance for the history of learned men. The list of his works occupies five pages in Saxe's *Onomasticon*. His poems and orations were published after his death. There is an account of his life in the *Gentleman's Magazine* for April (1742) by Dr Samuel Johnson.

BURMANN, PIETER (1714-1778), called by himself "the Younger" (Secundus), Dutch philologist, nephew of the above, was born at Amsterdam on the 13th of October 1714. He was brought up by his uncle in Leiden, and afterwards studied law and philology under C. A. Duker and Arnold von Drakenborch at Utrecht. In 1735 he was appointed professor of eloquence and history at Franeker, with which the chair of poetry was combined in 1741. In the following year he left Franeker for Amsterdam to become professor of history and philology at the Athenaeum. He was subsequently professor of poetry (1744), general librarian (1752), and inspector of the gymnasium (1753). In 1777 he retired, and died on the 24th of June 1778 at Sandhorst, near Amsterdam. He resembled his more famous uncle in the manner and direction of his studies, and in his violent disposition, which involved him in quarrels with contemporaries, notably Saxe and Klots. He was a man of extensive learning, and had a great talent for Latin poetry. His most valuable works are: *Anthologia Veterum Latinorum Epigrammatum et Poematum* (1759-1773); *Aristophanis Comoediae Novem* (1766); *Rhetorica ad Herennium* (1761). He completed the editions of Virgil (1746)

and Claudian (1760), which had been left unfinished by his uncle, and commenced an edition of Propertius, one of his best works, which was only half printed at the time of his death. It was completed by L. van Santen and published in 1780.

BURMESE WARS. Three wars were fought between Burma and the British during the 19th century (see *BURMA: History*), which resulted in the gradual extinction of Burmese independence.

First Burmese War, 1823-26.—On the 23rd of September 1823 an armed party of Burmese attacked a British guard on Shapara, an island close to the Chittagong side, killing and wounding six of the guard. Two Burmese armies, one from Manipur and another from Assam, also entered Cachar, which was under British protection, in January 1824. War with Burma was formally declared on the 5th of March 1824. On the 17th of May a Burmese force invaded Chittagong and drove a mixed sepoy and police detachment from its position at Ramu, but did not follow up its success. The British rulers in India, however, had resolved to carry the war into the enemy's country; an armament, under Commodore Charles Grant and Sir Archibald Campbell, entered the Rangoon river, and anchored off the town on the 10th of May 1824. After a feeble resistance the place, then little more than a large stockaded village, was surrendered, and the troops were landed. The place was entirely deserted by its inhabitants, the provisions were carried off or destroyed, and the invading force took possession of a complete solitude. On the 28th of May Sir A. Campbell ordered an attack on some of the nearest posts, which were all carried after a steadily weakening defence. Another attack was made on the 10th of June on the stockades at the village of Kemmendine. Some of these were battered by artillery from the war vessels in the river, and the shot and shells had such effect on the Burmese that they evacuated them, after a very unequal resistance. It soon, however, became apparent that the expedition had been undertaken with very imperfect knowledge of the country, and without adequate provision. The devastation of the country, which was part of the defensive system of the Burmese, was carried out with unrelenting rigour, and the invaders were soon reduced to great difficulties. The health of the men declined, and their ranks were fearfully thinned. The monarch of Ava sent large reinforcements to his dispirited and beaten army; and early in June an attack was commenced on the British line, but proved unsuccessful. On the 8th the British assaulted. The enemy were beaten at all points; and their strongest stockaded works, battered to pieces by a powerful artillery, were in general abandoned. With the exception of an attack by the prince of Tharrawaddy in the end of August, the enemy allowed the British to remain unmolested during the months of July and August. This interval was employed by Sir A. Campbell in subduing the Burmese provinces of Tavoy and Mergui, and the whole coast of Tenasserim. This was an important conquest, as the country was salubrious and afforded convalescent stations to the sick, who were now so numerous in the British army that there were scarcely 3000 soldiers fit for duty. An expedition was about this time sent against the old Portuguese fort and factory of Syriam, at the mouth of the Pegu river, which was taken; and in October the province of Martaban was reduced under the authority of the British.

The rainy season terminated about the end of October; and the court of Ava, alarmed by the discomfiture of its armies, recalled the veteran legions which were employed in Arakan, under their renowned leader Maha Bandula. Bandula hastened by forced marches to the defence of his country; and by the end of November an army of 60,000 men had surrounded the British position at Rangoon and Kemmendine, for the defence of which Sir Archibald Campbell had only 5000 efficient troops. The enemy in great force made repeated attacks on Kemmendine without success, and on the 7th of December Bandula was defeated in a counter attack made by Sir A. Campbell. The fugitives retired to a strong position on the river, which they again entrenched; and here they were attacked by the British on the 15th, and driven in complete confusion from the field.

Sir Archibald Campbell now resolved to advance on Prome,

about 100 m. higher up the Irrawaddy river. He moved with his force on the 13th of February 1825 in two divisions, one proceeding by land, and the other, under General Willoughby Cotton, destined for the reduction of Danubyu, being embarked on the flotilla. Taking the command of the land force, he continued his advance till the 11th of March, when intelligence reached him of the failure of the attack upon Danubyu. He instantly commenced a retrograde march; on the 27th he effected a junction with General Cotton's force, and on the 2nd of April entered the entrenchments at Danubyu without resistance, Bandula having been killed by the explosion of a bomb. The English general entered Prome on the 25th, and remained there during the rainy season. On the 17th of September an armistice was concluded for one month. In the course of the summer General Joseph Morrison had conquered the province of Arakan; in the north the Burmese were expelled from Assam; and the British had made some progress in Cachar, though their advance was finally impeded by the thick forests and jungle.

The armistice having expired on the 3rd of November, the army of Ava, amounting to 60,000 men, advanced in three divisions against the British position at Prome, which was defended by 3000 Europeans and 2000 native troops. But the British still triumphed, and after several actions, in which the Burmese were the assailants and were partially successful, Sir A. Campbell, on the 1st of December, attacked the different divisions of their army, and successively drove them from all their positions, and dispersed them in every direction. The Burmese retired on Malun, along the course of the Irrawaddy, where they occupied, with 10,000 or 12,000 men, a series of strongly fortified heights and a formidable stockade. On the 26th they sent a flag of truce to the British camp; and negotiations having commenced, peace was proposed to them on the following conditions:—(1) The cession of Arakan, together with the provinces of Mergui, Tavoy and Ye; (2) the renunciation by the Burmese sovereign of all claims upon Assam and the contiguous petty states; (3) the Company to be paid a crore of rupees as an indemnification for the expenses of the war; (4) residents from each court to be allowed, with an escort of fifty men; while it was also stipulated that British ships should no longer be obliged to unship their rudders and land their guns as formerly in the Burmese ports. This treaty was agreed to and signed, but the ratification of the king was still wanting; and it was soon apparent that the Burmese had no intention to sign it, but were preparing to renew the contest. On the 10th of January, accordingly, Sir A. Campbell attacked and carried the enemy's position at Malun. Another offer of peace was here made by the Burmese, but it was found to be insincere; and the fugitive army made at the ancient city of Pagan a final stand in defence of the capital. They were attacked and overthrown on the 9th of February 1826; and the invading force being now within four days' march of Ava, Dr Price, an American missionary, who with other Europeans had been thrown into prison when the war commenced, was sent to the British camp with the treaty known as the treaty of Yandaboo) ratified, the prisoners of war released, and an instalment of 25 lakhs of rupees. The war as thus brought to a successful termination, and the British army evacuated the country.

Second Burmese War, 1852.—On the 15th of March 1852 Lord Dalhousie sent an ultimatum to King Pagan, announcing that hostile operations would be commenced if all his demands were not agreed to by the 1st of April. Meanwhile a force consisting of 8100 troops had been despatched to Rangoon under the command of General H. T. Godwin, C.B., while Commodore Lambert commanded the naval contingent. No reply being given to this letter, the first blow of the Second Burmese War was ruck by the British on the 5th of April 1852, when Martaban was taken. Rangoon town was occupied on the 12th, and the two Dragon pagoda on the 14th, after heavy fighting, when the Burmese army retired northwards. Bassein was seized on the 15th of May, and Pegu was taken on the 3rd of June, after some sharp fighting round the Shwe-maw-daw pagoda. During the rainy season the approval of the East India Company's court of

directors and of the British government was obtained to the annexation of the lower portion of the Irrawaddy Valley, including Prome. Lord Dalhousie visited Rangoon in July and August, and discussed the whole situation with the civil, military and naval authorities. In consequence General Godwin occupied Prome on the 9th of October after but slight resistance. Early in December Lord Dalhousie informed King Pagan that the province of Pegu would henceforth form part of the British dominions, and that if his troops resisted the measure his whole kingdom would be destroyed. The proclamation of annexation was issued on the 20th of January 1853, and thus the Second Burmese War was brought to an end without any treaty being signed.

Third Burmese War, 1855-86.—The imposition of an impossible fine on the Bombay-Burma Trading Company, coupled with the threat of confiscation of all their rights and property in case of non-payment, led to the British ultimatum of the 22nd of October 1855; and by the 9th of November a practical refusal of the terms having been received at Rangoon, the occupation of Mandalay and the dethronement of King Thibaw were determined upon. At this time, beyond the fact that the country was one of dense jungle, and therefore most unfavourable for military operations, little was known of the interior of Upper Burma; but British steamers had for years been running on the great river highway of the Irrawaddy, from Rangoon to Mandalay, and it was obvious that the quickest and most satisfactory method of carrying out the British campaign was an advance by water direct on the capital. Fortunately a large number of light-draught river steamers and barges (or "flats"), belonging to the Irrawaddy Flotilla Company, were available at Rangoon, and the local knowledge of the company's officers of the difficult river navigation was at the disposal of the government. Major-General, afterwards Sir, H. N. D. Prendergast, V.C., K.C.B., R.E., was placed in command of the expedition. As was only to be expected in an enterprise of this description, the navy as well as the army was called in requisition; and as usual the services rendered by the seamen and guns were most important. The total effective of the force was 9034 fighting men, 2810 native followers and 67 guns, and for river service, 24 machine guns. The river fleet which conveyed the troops and stores was composed of a total of no less than 55 steamers, barges, launches, &c.

Thayetmyo was the British post on the river nearest to the frontier, and here, by 14th November, five days after Thibaw's answer had been received, practically the whole expedition was assembled. On the same day General Prendergast received instructions to commence operations. The Burmese king and his country were taken completely by surprise by the unexampled rapidity of the advance. There had been no time for them to collect and organize for the stubborn resistance of which the river and its defences were capable. They had not even been able to block the river by sinking steamers, &c., across it, for, on the very day of the receipt of orders to advance, the armed steamers, the "Irrawaddy" and "Kathleen," engaged the nearest Burmese batteries, and brought out from under their guns the king's steamer and some barges which were lying in readiness for this very purpose. On the 16th the batteries themselves on both banks were taken by a land attack, the enemy being evidently unprepared and making no resistance. On the 17th of November, however, at Minhla, on the right bank of the river, the Burmans in considerable force held successively a barricade, a pagoda and the redoubt of Minhla. The attack was pressed home by a brigade of native infantry on shore, covered by a bombardment from the river, and the enemy were defeated with a loss of 170 killed and 276 prisoners, besides many more drowned in the attempt to escape by the river. The advance was continued next day and the following days, the naval brigade and heavy artillery leading and silencing in succession the enemy's river defences at Nyaungu, Pakokku and Myingyan. On the 26th of November, when the flotilla was approaching the ancient capital of Ava, envoys from King Thibaw met General Prendergast with offers of surrender; and on the 27th, when the ships

were lying off that city and ready to commence hostilities, the order of the king to his troops to lay down their arms was received. There were three strong forts here, full at that moment with thousands of armed Burmans, and though a large number of these filed past and laid down their arms by the king's command, still many more were allowed to disperse with their weapons; and these, in the time that followed, broke up into dacoit or guerrilla bands, which became the scourge of the country and prolonged the war for years. Meanwhile, however, the surrender of the king of Burma was complete; and on the 28th of November, in less than a fortnight from the declaration of war, Mandalay had fallen, and the king himself was a prisoner, while every strong fort and town on the river, and all the king's ordnance (1867 pieces), and thousands of rifles, muskets and arms had been taken. Much valuable and curious "loot" and property was found in the palace and city of Mandalay, which, when sold, realized about 9 lakhs of rupees (£60,000).

From Mandalay, General Prendergast seized Bhamo on the 28th of December. This was a very important move, as it forestalled the Chinese, who were preparing to claim the place. But unfortunately, although the king was dethroned and deported, and the capital and the whole of the river in the hands of the British, the bands of armed soldiery, unaccustomed to conditions other than those of anarchy, rapine and murder, took advantage of the impenetrable cover of their jungles to continue a desultory armed resistance. Reinforcements had to be poured into the country, and it was in this phase of the campaign, lasting several years, that the most difficult and most arduous work fell to the lot of the troops. It was in this jungle warfare that the losses from battle, sickness and privation steadily mounted up; and the troops, both British and native, proved once again their fortitude and courage.

Various expeditions followed one another in rapid succession, penetrating to the remotest corners of the land, and bringing peace and protection to the inhabitants, who, it must be mentioned, suffered at least as much from the dacoits as did the troops. The final, and now completely successful, pacification of the country, under the direction of Sir Frederick (afterwards Earl) Roberts, was only brought about by an extensive system of small protective posts scattered all over the country, and small lightly equipped columns moving out to disperse the enemy whenever a gathering came to a head, or a pretended prince or king appeared.

No account of the Third Burmese War would be complete without a reference to the first, and perhaps for this reason most notable, land advance into the enemy's country. This was carried out in November 1885 from Toungoo, the British frontier post in the east of the country, by a small column of all arms under Colonel W. P. Dicken, 3rd Madras Light Infantry, the first objective being Ningyan. The operations were completely successful, in spite of a good deal of scattered resistance, and the force afterwards moved forward to Yamethin and Hlaingdet. As inland operations developed, the want of mounted troops was badly felt, and several regiments of cavalry were brought over from India, while mounted infantry was raised locally. It was found that without these most useful arms it was generally impossible to follow up and punish the active enemy.

BURN, RICHARD (1709-1785), English legal writer, was born at Winton, Westmorland, in 1709. Educated at Queen's College, Oxford, he entered the Church, and in 1736 became vicar of Orton in Westmorland. He was a justice of the peace for the counties of Westmorland and Cumberland, and devoted himself to the study of law. He was appointed chancellor of the diocese of Carlisle in 1765, an office which he held till his death at Orton on the 12th of November 1785. Burn's *Justice of the Peace and Parish Officer*, first published in 1755, was for many years the standard authority on the law relating to justices of the peace. It has passed through innumerable editions. His *Ecclesiastical Law* (1760), a work of much research, was the foundation upon which were built many modern commentaries on ecclesiastical law. The best edition is that by R. Phillimore (4 vols., 1842).

Burn also wrote *Digest of the Militia Laws* (1760), and *A New Law Dictionary* (2 vols., 1792).

BURNABY, FREDERICK GUSTAVUS (1842-1885), English traveller and soldier, was born on the 3rd of March 1842, at Bedford, the son of a clergyman. Educated at Harrow and in Germany, he entered the Royal Horse Guards in 1859. Finding no chance for active service, his spirit of adventure sought outlets in balloon-ascents and in travels through Spain and Russia. In the summer of 1874 he accompanied the Carlist forces as correspondent of *The Times*, but before the end of the war he was transferred to Africa to report on Gordon's expedition to the Sudan. This took Burnaby as far as Khartum. Returning to England in March 1875, he matured his plans for a journey on horseback to Khiva through Russian Asia, which had just been closed to travellers. His accomplishment of this task, in the winter of 1875-1876, described in his book *A Ride to Khiva*, brought him immediate fame. His next leave of absence was spent in another adventurous journey on horseback, through Asia Minor, from Scutari to Erzerum, with the object of observing the Russian frontier, an account of which he afterwards published. In the Russo-Turkish War of 1877, Burnaby (who soon afterwards became lieutenant-colonel) acted as travelling agent to the Stafford House (Red Cross) Committee, but had to return to England before the campaign was over. At this point began his active interest in politics, and in 1880 he unsuccessfully contested a seat at Birmingham in the Tory-Democrat interest. In 1881 he crossed the Channel in a balloon. Having been disappointed in his hope of seeing active service in the Egyptian campaign of 1882, he participated in the Suakin campaign of 1884 without official leave, and was wounded at El Teb when acting as an intelligence officer under General Valentine Baker. This did not deter him from a similar course when a fresh expedition started up the Nile. He was given a post by Lord Wolseley, and met his death in the hand-to-hand fighting of the battle of Abu Klea (17th January 1885).

BURNAND, SIR FRANCIS COWLEY (1836-), English humorist, was born in London on the 29th of November 1836. His father was a London stockbroker, of French-Swiss origin; his mother Emma Cowley, a direct descendant of Hannah Cowley (1743-1809), the English poet and dramatist. He was educated at Eton and Cambridge, and originally studied first for the Anglican, then for the Roman Catholic Church; but eventually took to the law and was called to the bar. From his earliest days, however, the stage had attracted him—he founded the Amateur Dramatic Club at Cambridge,—and finally he abandoned the church and the law, first for the stage and subsequently for dramatic authorship. His first great dramatic success was made with the burlesque *Black-Eyed Susan*, and he wrote a large number of other burlesques, comedies and farces. One of his early burlesques came under the favourable notice of Mark Lemon, then editor of *Punch*, and Burnand, who was already writing for the comic paper *Fuss*, became in 1862 a regular contributor to *Punch*. In 1880 he was appointed editor of *Punch*, and only retired from that position in 1906. In 1902 he was knighted. His literary reputation as a humorist depends, apart from his long association with *Punch*, on his well-known book *Happy Thoughts*, originally published in *Punch* in 1863-1864 and frequently reprinted.

See *Recollections and Reminiscences*, by Sir F. C. Burnand (London, 1904).

BURNE-JONES, SIR EDWARD BURNE, Bart. (1833-1895), English painter and designer, was born on the 28th of August 1833 at Birmingham. His father was a Welsh descent, and the idealism of his nature and art has been attributed to this Celtic strain. An only son, he was educated at King Edward's school, Birmingham, and destined for the Church. He retained through life an interest in classical studies, but it was the mythology of the classics which fascinated him. He went into residence as a scholar at Exeter College, Oxford, in January 1853. On the same day William Morris entered the same college, having also the intention of taking orders. The two were thrown together, and grew close friends. Their similar tastes and enthusiasms were

actually stimulated. Burne-Jones resumed his early love of rawing and designing. With Morris he read *Modern Painters* and the *Monte d'Arthur*. He studied the Italian pictures in the University galleries, and Dürer's engravings; but his keenest enthusiasm was kindled by the sight of two works by a living man, Rossetti. One of these was a woodcut in Allingham's poems, "The Maids of Elfinmere"; the other was the water-colour Dante drawing an Angel," then belonging to Mr Coombe, of the Clarendon Press, and now in the University collection. Having found his true vocation, Burne-Jones, like his friend Morris, determined to relinquish his thoughts of the Church and become an artist. Rossetti, although not yet seen by him, as his chosen master; and early in 1856 he had the happiness, in London, of meeting him. At Easter he left college without taking a degree. This was his own decision, not due (as often stated) to Rossetti's persuasion; but on settling in London, where Morris soon joined him at 17 Red Lion Square, he began to work under Rossetti's friendly instruction and encouraging guidance.

As Burne-Jones once said, he "found himself at five-and-twenty what he ought to have been at fifteen." He had had no regular training as a draughtsman, and lacked the confidence of science. But his extraordinary faculty of invention as a signer was already ripening; his mind, rich in knowledge of classical story and medieval romance, teemed with pictorial objects; and he set himself to complete his equipment by solitary labour, witnessed by innumerable drawings. The works of this first period are all more or less tinged by the influence of Rossetti; but they are already differentiated from the elder artist's style by their more facile though less intensely felt elaboration of imaginative detail. Many are pen-and-ink drawings on vellum, exquisitely finished, of which the "Waxen Page" is one of the earliest and best examples; it is dated 1856. Although subject, medium and manner derive from Rossetti's inspiration, it is not the hand of a pupil merely, but a potential master. This was recognized by Rossetti himself, who before long avowed that he had nothing more to teach him. Burne-Jones's first sketch in oils dates from this same year, 1856; and during 1857 he made for Bradford College the first work that was to be an immense series of cartoons for stained glass. In 1858 he decorated a cabinet with the "Prioress's Tale" from *Chaucer*, his first direct illustration of the work of a poet whom he specially loved and who inspired him with endless subjects. His early, therefore, we see the artist busy in all the various ways in which he was to labour.

In the autumn of 1857 Burne-Jones joined in Rossetti's ill-considered scheme to decorate the walls of the Oxford Union. None of the painters had mastered the technique of fresco, and their attempts had begun to peel from the walls before they were completed. In 1859 Burne-Jones made his first journey to Italy. He saw Florence, Pisa, Siena, Venice and other places, and began to have found the gentle and romantic Siennese more attractive than any other school. Rossetti's influence still persisted; and its impress is visible, more strongly perhaps than before, in the two water-colours "Sideria von Bork" and "Lara von Bork," painted in 1860. These little masterpieces are a directness of execution rare with the artist. In powerful characterization, combined with a decorative motive, they rival Rossetti at his best. In June of this year Burne-Jones was married to Miss Georgiana Macdonald, two of whose sisters were the wives of Sir E. Poynter and Mr J. L. Kipling, and they settled in Bloomsbury. Five years later he moved to Kensington Square, and shortly afterwards to the Grange, Fulham, an old house with a garden, where he resided till his death. In 1862 the artist and his wife accompanied Ruskin to Italy, visiting Milan and Florence.

In 1864 he was elected an associate of the Society of Painters in Water-Colours, and exhibited, among other works, "The Merciful Knight," the first picture which fully revealed his individual personality as an artist. The next six years saw a series of fine water-colours at the same gallery; but in 1870, owing to a misunderstanding, Burne-Jones resigned his membership in 1874 *

of the society. He was re-elected in 1886. During the next seven years, 1870-1877, only two works of the painter's were exhibited. These were two water-colours, shown at the Dudley Gallery in 1873, one of them being the beautiful "Love among the Ruins," destroyed twenty years later by a cleaner who supposed it to be an oil painting, but afterwards reproduced in oils by the painter. This silent period was, however, one of unremitting production. Hitherto Burne-Jones had worked almost entirely in water-colours. He now began a number of large pictures in oils, working at them in turn, and having always several on hand. The "Briar Rose" series, "Laus Veneris," the "Golden Stairs," the "Pygmalion" series, and "The Mirror of Venus" are among the works planned and completed, or carried far towards completion, during these years. At last, in May 1877, the day of recognition came, with the opening of the first exhibition of the Grosvenor Gallery, when the "Days of Creation," the "Beguiling of Merlin," and the "Mirror of Venus" were all shown. Burne-Jones followed up the signal success of these pictures with "Laus Veneris," the "Chant d'Amour," "Pan and Psyche," and other works, exhibited in 1878. Most of these pictures are painted in gay and brilliant colours. A change is noticeable next year, 1879, in the "Annunciation" and in the four pictures called "Pygmalion and the Image"; the former of these, one of the simplest and most perfect of the artist's works, is subdued and sober; in the latter a scheme of soft and delicate tints was attempted, not with entire success. A similar temperance of colours marks the "Golden Stairs," first exhibited in 1880. In 1884, following the almost sombre "Wheel of Fortune" of the preceding year, appeared "King Cophetua and the Beggar Maid," in which Burne-Jones once more indulged his love of gorgeous colour, refined by the period of self-restraint. This masterpiece is now in the National collection. He next turned to two important sets of pictures, "The Briar Rose" and "The Story of Perseus," though these were not completed for some years to come. In 1886, having been elected A.R.A. the previous year, he exhibited (for the only time) at the Royal Academy "The Depths of the Sea," a mermaid carrying down with her a youth whom she has unconsciously drowned in the impetuosity of her love. This picture adds to the habitual haunting charm a tragic irony of conception and a felicity of execution which give it a place apart among Burne-Jones's works. He resigned his Associateship in 1893. One of the "Perseus" series was exhibited in 1887, two more in 1888, with "The Brazen Tower," inspired by the same legend. In 1890 the four pictures of "The Briar Rose" were exhibited by themselves, and won the widest admiration. The huge tempera picture, "The Star of Bethlehem," painted for the corporation of Birmingham, was exhibited in 1891. A long illness for some time checked the painter's activity, which, when resumed, was much occupied with decorative schemes. An exhibition of his work was held at the New Gallery in the winter of 1892-1893. To this period belong several of his comparatively few portraits. In 1894 Burne-Jones was made a baronet. Ill-health again interrupted the progress of his works, chief among which was the vast "Arthur in Avalon." In 1898 he had an attack of influenza, and had apparently recovered, when he was again taken suddenly ill, and died on the 17th of June. In the following winter a second exhibition of his works was held at the New Gallery, and an exhibition of his drawings (including some of the charmingly humorous sketches made for children) at the Burlington Fine Arts Club.

His son and successor in the baronetcy, Sir Philip Burne-Jones (b. 1861), also became well known as an artist. The only daughter, Margaret, married Mr J. W. Mackail.

Burne-Jones's influence has been exercised far less in painting than in the wide field of decorative design. Here it has been enormous. His first designs for stained glass, 1857-1861, were made for Messrs Powell, but after 1861 he worked exclusively for Morris & Co. Windows executed from his cartoons are to be found all over England; others exist in churches abroad. For the American Church in Rome he designed a number of mosaics. Reliefs in metal, tiles, gesso-work, decorations for

pianos and organs, and cartoons for tapestry represent his manifold activity. In all works, however, which were only designed and not carried out by him, a decided loss of delicacy is to be noted. The colouring of the tapestries (of which the "Adoration of the Magi" at Exeter College is the best-known) is more brilliant than successful. The range and fertility of Burne-Jones as a decorative inventor can be perhaps most conveniently studied in the sketch-book, 1885-1895, which he bequeathed to the British Museum. The artist's influence on book-illustration must also be recorded. In early years he made a few drawings on wood for Dalziel's Bible and for *Good Words*; but his later work for the Kelmscott Press, founded by Morris in 1891, is that by which he is best remembered. Besides several illustrations to other Kelmscott books, he made eighty-seven designs for the *Chaucer* of 1897.

Burne-Jones's aim in art is best given in some of his own words, written to a friend: "I mean by a picture a beautiful, romantic dream of something that never was, never will be—in a light better than any light that ever shone—in a land no one can define or remember, only desire—and the forms divinely beautiful—and then I wake up, with the waking of Brynhild." No artist was ever more true to his aim. Ideals resolutely pursued are apt to provoke the resentment of the world, and Burne-Jones encountered, endured and conquered an extraordinary amount of angry criticism. In so far as this was directed against the lack of realism in his pictures, it was beside the point. The earth, the sky, the rocks, the trees, the men and women of Burne-Jones are not those of this world; but they are themselves a world, consistent with itself, and having therefore its own reality. Charged with the beauty and with the strangeness of dreams, it has nothing of a dream's incoherence. Yet it is a dreamer always whose nature penetrates these works, a nature out of sympathy with struggle and strenuous action. Burne-Jones's men and women are dreamers too. It was this which, more than anything else, estranged him from the age into which he was born. But he had an inbred "revolt from fact" which would have estranged him from the actualities of any age. That criticism seems to be more justified which has found in him a lack of such victorious energy and mastery over his materials as would have enabled him to carry out his conceptions in their original intensity. Representing the same kind of tendency as distinguished his French contemporary, Puvis de Chavannes, he was far less in the main current of art, and his position suffers accordingly. Often compared with Botticelli, he had nothing of the fire and vehemence of the Florentine. Yet, if aloof from strenuous action, Burne-Jones was singularly strenuous in production. His industry was inexhaustible, and needed to be, if it was to keep pace with the constant pressure of his ideas. Invention, a very rare excellence, was his pre-eminent gift. Whatever faults his paintings may have, they have always the fundamental virtue of design; they are always pictures. His fame might rest on his purely decorative work. But his designs were informed with a mind of romantic temper, apt in the discovery of beautiful subjects, and impassioned with a delight in pure and variegated colour. These splendid gifts were directed in a critical and fortunate moment by the genius of Rossetti. Hence a career which shows little waste or misdirection of power, and, granted the aim proposed, a rare level of real success.

AUTHORITIES.—In 1904 was published *Memorials of Edward Burne-Jones*, by his widow, two volumes of extreme interest and charm. *The Work of Burne-Jones*, a collection of ninety-one photographs, appeared in 1900.

See also *Catalogue to Burlington Club Exhibition of Drawings by Burne-Jones*, with Introduction by Cosmo Monkhouse (1899); *Sir E. Burne-Jones: a Record and a Review*, by Malcolm Bell (1898); *Sir E. Burne-Jones, his Life and Work*, by Julia Cartwright (Mrs Ady) (1894); *The Life of William Morris*, by J. W. Mackail (1899). (L. B.)

BURNELL, ARTHUR COKE (1840-1882), English Sanskrit scholar, was born at St Briavels, Gloucestershire, in 1840. His father was an official of the East India Company, and in 1860 he himself went out to Madras as a member of the Indian civil service. Here he utilized every available opportunity to acquire or copy Sanskrit manuscripts. In 1870 he presented his collection

of 350 MSS. to the India library. In 1874 he published a *Handbook of South Indian Palaeography*, characterized by Max Müller as "indispensable to every student of Indian literature," and in 1880 issued for the Madras government his greatest work, the *Classified Index to the Sanskrit MSS. in the Palace at Tanjore*. He was also the author of a large number of translations from, and commentaries on, various other Sanskrit manuscripts, being particularly successful in grouping and elucidating the essential principles of Hindu law. In addition to his exhaustive acquaintance with Sanskrit, and the southern India vernaculars, he had some knowledge of Tibetan, Arabic, Kawi, Javanese and Coptic. Burnell originated with Sir Henry Yule the well-known dictionary of Anglo-Indian words and phrases, *Hobson-Jobson*. His constitution, never strong, broke down prematurely through the combined influence of overwork and the Madras climate, and he died at West Stratton, Hampshire, on the 12th of October 1882. A further collection of Sanskrit manuscripts was purchased from his heirs by the India library after his death.

BURNELL, ROBERT (d. 1292), English bishop and chancellor, was born at Acton Burnell in Shropshire, and began his public life probably as a clerk in the royal chancery. He was soon in the service of Edward, the eldest son of King Henry III., and was constantly in attendance on the prince, whose complete confidence he appears to have enjoyed. Having received some ecclesiastical preferments, he acted as one of the regents of the kingdom from the death of Henry III. in November 1272 until August 1274, when the new king, Edward I., returned from Palestine and made him his chancellor. In 1275 Burnell was elected bishop of Bath and Wells, and three years later Edward rejected the attempt which he had made in 1270 to secure the archbishopric of Canterbury for his favourite. The bishop's second failure to obtain this dignity was due, doubtless, to his irregular and unclerical manner of life, a fact which also accounts, in part at least, for the hostility which existed between his victorious rival, Archbishop Peckham, and himself. As the chief adviser of Edward I. during the earlier part of his reign, and moreover as a trained and able lawyer, the bishop took a prominent part in the legislative acts of the "English Justinian," whose activity in this direction coincides practically with Burnell's tenure of the office of chancellor. The bishop also influenced the king's policy with regard to France, Scotland and Wales; was frequently employed on business of the highest moment; and was the royal mouthpiece on several important occasions. In 1283 a council, or, as it is sometimes called, a parliament, met in his house at Acton Burnell, and he was responsible for the settlement of the court of chancery in London. In spite of his numerous engagements, Burnell found time to aggrandize his bishopric, to provide liberally for his nephews and other kinsmen, and to pursue his cherished but futile aim of founding a great family. Licentious and avaricious, he amassed great wealth; and when he died on the 25th of October 1292 he left numerous estates in Shropshire, Worcestershire, Somerset, Kent, Surrey and elsewhere. He was, however, a genial and kind-hearted, a great lawyer and a faithful minister.

See R. W. Exton, *Antiquities of Shropshire* (London, 1854-1860); and E. Foss, *The Judges of England*, vol. iii. (London, 1848-1864)

BURNES, SIR ALEXANDER (1805-1842), British traveller and explorer, was born at Montrose, Scotland, in 1805. While serving in India, in the army of the East India Company, which he had joined in his seventeenth year, he made himself acquainted with Hindustani and Persian, and thus obtained an appointment as interpreter at Surat in 1822. Transferred to Cutch in 1826 as assistant to the political agent, he turned his attention more particularly to the history and geography of north-western India and the adjacent countries, at that time very imperfectly known. His proposal in 1829 to undertake a journey of exploration through the valley of the Indus was not carried out owing to political apprehensions; but in 1831 he was sent to Lahore with a present of horses from King William IV to Maharaja Ranjit Singh and took advantage of the opportunity for extensive investigations. In the following years his travels were extended through Afghanistan across the Hindu Kush to

Bokhara and Persia. The narrative which he published on his visit to England in 1834 added immensely to contemporary knowledge of the countries traversed, and was one of the most popular books of the time. The first edition brought the author the sum of £800, and his services were recognized not only by the Royal Geographical Society of London, but also by that of Paris. Soon after his return to India in 1835 he was appointed to the court of Sind to secure a treaty for the navigation of the Indus; and in 1836 he undertook a political mission to Dost Mahomed at Kabul. He advised Lord Auckland to support Dost Mahomed on the throne of Kabul, but the viceroy preferred to follow the opinion of Sir William Macnaghten and reinstated Shah Shuja, thus leading up to the disasters of the first Afghan War. On the restoration of Shah Shuja in 1839, he became regular political agent at Kabul, and remained there till his assassination in 1841 (on the 2nd of November), during the heat of an insurrection. The calmness with which he continued at his post, long after the imminence of his danger was apparent, gives an heroic colouring to the close of an honourable and devoted life. It came to light in 1861 that some of Burnes' despatches from Kabul in 1839 had been altered, so as to convey opinions opposite to his, but Lord Palmerston refused after such a lapse of time to grant the inquiry demanded in the House of Commons. A narrative of his later labours was published in 1842 under the title of *Cabool*.

See Sir J. W. Kaye, *Lives of Indian Officers* (1889).

BURNET, GILBERT (1643-1715). English bishop and historian, was born in Edinburgh on the 18th of September 1643, of an ancient and distinguished Scottish house. He was the youngest son of Robert Burnet (1592-1661), who at the Restoration became a lord of session with the title of Lord Crimond. Robert Burnet had refused to sign the Scottish Covenant, although the document was drawn up by his brother-in-law, Archibald Johnstone, Lord Warristoun. He therefore found it necessary to retire from his profession, and twice went into exile. He disapproved of the rising of the Scots, but was none the less a severe critic of the government of Charles I. and of the action of the Scottish bishops. This moderate attitude he impressed in his son Gilbert, whose early education he directed. The boy entered Marischal College at the age of nine, and five years after graduated M.A. He then spent a year in the study of feudal and civil law before he resolved to devote himself to theology. He became a probationer for the Scottish ministry in 1661 just before episcopal government was re-established in Scotland. His decision to accept episcopal orders led to difficulties with his family, especially with his mother, who held rigid Presbyterian views. From this time dates his friendship with Robert Leighton (1611-1684), who greatly influenced his religious opinions. Leighton had, during a stay in the Spanish Netherlands, assimilated something of the ascetic and pietistic spirit of Jansenism, and was devoted to the interests of peace in the church. Burnet wisely refused to accept a benefice in the disturbed state of church affairs, but he wrote an audacious letter to Archbishop Sharp asking him to take measures to restore peace. Sharp sent for Burnet, and dismissed his advice without parent resentment. He had already made valuable acquaintances in Edinburgh, and he now visited London, Oxford and Cambridge, and, after a short visit to Edinburgh in 1663, when sought to secure a reprieve for his uncle Warristoun, he proceeded to travel in France and Holland. At Cambridge he was strongly influenced by the philosophical views of Ralph Cudworth and Henry More, who proposed an unusual degree of freedom within the boundaries of the church and the limitations posed by its liturgy and episcopal government; and his intercourse in Holland with foreign divines of different Protestant sects further encouraged his tendency to latitudinarianism. When he returned to England in 1664, he established intimate relations with Sir Robert Moray and with John Maitland, earl afterwards first duke of Lauderdale, both of whom at that time advocated a tolerant policy towards the Scottish covenanters. Burnet became a member of the Royal Society, of which Moray was the first president. On his father's death he had been offered

a living by a relative, Sir Alexander Burnet, and in 1663 the living of Saltoun, East Lothian, had been kept open for him by one of his father's friends. He was not formally inducted at Saltoun until June 1665, although he had served there since October 1664. For the next five years he devoted himself to his parish, where he won the respect of all parties. In 1666 he alienated the Scottish bishops by a bold memorial (printed in vol. ii. of the *Miscellanies* of the Scottish Historical Society), in which he pointed out that they were departing from the custom of the primitive church by their excessive pretensions, and yet his attitude was far too moderate to please the Presbyterians. In 1669 he resigned his parish to become professor of divinity in the university of Glasgow, and in the same year he published an exposition of his ecclesiastical views in his *Modest and Free Conference between a Conformist and a Nonconformist* (by "a lover of peace"). He was Leighton's right hand in the efforts at a compromise between the episcopal and the Presbyterian principle. Meanwhile he had begun to differ from Lauderdale, whose policy after the failure of the scheme of "Accommodation" moved in the direction of absolutism and repression, and during Lauderdale's visit to Scotland in 1672 the divergence rapidly developed into opposition. He warily refused the offer of a Scottish bishopric, and published in 1673 his four "conferences," entitled *Vindication of the Authority, Constitution and Laws of the Church and State of Scotland*, in which he insisted on the duty of passive obedience. It was partly through the influence of Anne (d. 1716), duchess of Hamilton in her own right, that he had been appointed at Glasgow, and he made common cause with the Hamiltons against Lauderdale. The duchess had made over to him the papers of her father and uncle, from which he compiled the *Memoirs of the Lives and Actions of James and William, dukes of Hamilton and Castleherald. In which an Account is given of the Rise and Progress of the Civil Wars of Scotland . . . together with many letters . . . written by King Charles I.* (London, 1677; Univ. Press, Oxford, 1852), a book which was published as the second volume of a *History of the Church of Scotland*, Spottiswood's *History* forming the first. This work established his reputation as an historian. Meanwhile he had clandestinely married in 1671 a cousin of Lauderdale, Lady Margaret Kennedy, daughter of John Kennedy, 6th earl of Cassilis, a lady who had already taken an active part in affairs in Scotland, and was eighteen years older than Burnet. The marriage was kept secret for three years, and Burnet renounced all claim to his wife's fortune.

Lauderdale's ascendancy in Scotland and the failure of the attempts at compromise in Scottish church affairs eventually led Burnet to settle in England. He was favourably received by Charles II. in 1673, when he went up to London to arrange for the publication of the *Hamilton Memoirs*, and he was treated with confidence by the duke of York. On his return to Scotland Lauderdale refused to receive him, and denounced him to Charles II. as one of the chief centres of Scottish discontent. Burnet found it wiser to retire to England on the plea of fulfilling his duties as royal chaplain. Once in London he resigned his professorship (September 1674) at Glasgow; but, although James remained his friend, Charles struck him off the roll of court chaplains in 1674, and it was in opposition to court influence that he was made chaplain to the Rolls Chapel by the master, Sir Harbottle Grimston, and appointed lecturer at St Clement's. He was summoned in April 1675 before a committee of the House of Commons to give evidence against Lauderdale, and disclosed, without reluctance according to his enemies, confidences which had passed between him and the minister. He himself confesses in his autobiography that "it was a great error in me to appear in this matter," and his conduct cost him the patronage of the duke of York. In ecclesiastical matters he threw in his lot with Thomas Tillotson and John Tenison, and at the time of the Revolution had written some eighteen polemics against encroachments of the Roman Catholic Church. At the suggestion of Sir William Jones, the attorney-general, he began his *History of the Reformation in England*, based on original documents.

In the necessary research he received some pecuniary help from Robert Boyle, but he was hindered in the preparation of the first part (1679) through being refused access to the Cotton library, possibly by the influence of Lauderdale. For this volume he received the thanks of parliament, and the second and third volumes appeared in 1681 and 1715. In this work he undertook to refute the statements of Nicholas Sanders, whose *De Origine et progressu schismatis Anglicani libri tres* (Cologne, 1585) was still, in the French translation of Maucairoix, the commonly accepted account of the English reformation. Burnet's contradictions of Sanders must not, however, be accepted without independent investigation. At the time of the Popish Plot in 1678 he displayed some moderation, refusing to believe the charges made against the duke of York, though he chose this time to publish some anti-Roman pamphlets. He tried, at some risk to himself, to save the life of one of the victims, William Staly, and visited William Howard, Viscount Stafford, in the Tower. To the Exclusion Bill he opposed a suggestion of compromise, and it is said that Charles offered him the bishopric of Chichester, "if he would come entirely into his interests." Burnet's reconciliation with the court was short-lived. In January 1680 he addressed to the king a long letter on the subject of his sins; he was known to have received the dangerous confidence of Wilmot, earl of Rochester, in his last illness; and he was even suspected, unjustly, in 1683, of having composed the paper drawn up on the eve of death by William Russell, Lord Russell, whom he attended to the scaffold. On the 5th of November 1684 he preached, at the express wish of his patron Grimston, and against his own desire, the usual anti-Catholic sermon. He was consequently deprived of his appointments by order of the court, and on the accession of James II. retired to Paris. He had already begun the writing of his memoirs, which were to develop into the *History of His Own Time*.

Burnet now travelled in Italy, Germany and Switzerland, finally settling in Holland at the Hague, where he won from the princess of Orange a confidence which proved enduring. He rendered a signal service to William by inducing the princess to offer to leave the whole political power in her husband's hands in the event of their succession to the English crown. A prosecution against him for high treason was now set on foot both in England and in Scotland, and he took the precaution of naturalizing himself as a Dutch subject. Lady Margaret Burnet was dying when he left England, and in Holland he married a Dutch heiress of Scottish descent, Mary Scott. He returned to England with William and Mary, and drew up the English text of their declaration. His earlier views on the doctrine of non-resistance had been sensibly modified by what he saw in France after the revocation of the edict of Nantes and by the course of affairs at home, and in 1688 he published an *Inquiry into the Measures of Submission to the Supreme Authority* in defence of the revolution. He was consecrated to the see of Salisbury on the 31st of March 1689 by a commission of bishops to whom Archbishop Sancroft had delegated his authority, declining personally to perform the office. In his pastoral letter to his clergy urging them to take the oath of allegiance, Burnet grounded the claim of William and Mary on the right of conquest, a view which gave such offence that the pamphlet was burnt by the common hangman three years later. As bishop he proved an excellent administrator, and gave the closest attention to his pastoral duties. He discouraged plurality of livings, and consequent non-residence, established a school of divinity at Salisbury, and spent much time himself in preparing candidates for confirmation, and in the examination of those who wished to enter the priesthood. Four discourses delivered to the clergy of his diocese were printed in 1694. During Queen Mary's lifetime ecclesiastical patronage passed through her hands, but after her death William III. appointed an ecclesiastical commission, on which Burnet was a prominent member, for the disposal of vacant benefices. In 1696 and 1697 he presented memorials to the king suggesting that the first-fruits and tenths raised by the clergy should be devoted to the

augmentation of the poorer livings, and though his suggestions were not immediately accepted, they were carried into effect under Queen Anne by the provision known as Queen Anne's Bounty. His second wife died of smallpox in 1696, and in 1700 Burnet married again, his third wife being Elizabeth (1661-1702), widow of Robert Berkeley and daughter of Sir Richard Blake, a rich and charitable woman, known by her *Method of Devotion*, posthumously published in 1710. In 1699 he was appointed tutor to the royal duke of Gloucester, son of the Princess Anne, an appointment which he accepted somewhat against his will. His influence at court had declined after the death of Queen Mary; William resented his often officious advice, placed little confidence in his discretion, and soon after his accession is even said to have described him as *ein rechter Tartuffe*. Burnet made a weighty speech against the bill (1700-1703) directed against the practice of occasional conformity, and was a consistent exponent of Broad Church principles. He devoted five years' labour to his *Exposition of the Thirty-nine Articles* (1699; ed. J. R. Page, 1837), which was severely criticized by the High Church clergy. But his hopes for a comprehensive scheme which might include nonconformists in the English Church were necessarily destroyed on the accession of Queen Anne. He died on the 17th of March 1715, and was buried in the parish of St James's, Clerkenwell.

Burnet directed in his will that his most important work, the *History of His Own Time*, should appear six years after his death. It was published (2 vols., 1724-1734) by his sons, Gilbert and Thomas, and then not without omissions. It was attacked in 1724 by John Cockburn in *A Specimen of some free and impartial Remarks*. Burnet's book naturally aroused much opposition, and there were persistent rumours that the MS. had been unduly tampered with. He has been freely charged with gross misrepresentation, an accusation to which he laid himself open, for instance, in the account of the birth of James, the Old Pretender. His later intimacy with the Marlboroughs made him very lenient where the duke was concerned. The greatest value of his work naturally lies in his account of transactions of which he had personal knowledge, notably in his relation of the church history of Scotland, of the Popish Plot, of the proceedings at the Hague previous to the expedition of William and Mary, and of the personal relations between the joint sovereigns.

Of his children by his second wife, William (d. 1730) became a colonial governor in America; Gilbert (d. 1726) became prebendary of Salisbury in 1715, and chaplain to George I. in 1718; and Sir Thomas (1694-1753), his literary executor and biographer, became in 1741 judge in the court of common pleas.

BIBLIOGRAPHY.—The chief authorities for Bishop Burnet's life are the autobiography "Rough Draft of my own Life" (ed. H. C. Foxcroft, Oxford, 1902, in the *Supplement to Burnet's History*), the Life by Sir Thomas Burnet in the *History of His Own Time* (Oxford, 1823, vol. vi.), and the *History* itself. A rather severe but detailed and useful criticism is given in L. v. Ranke's *History of England* (Eng. ed., Oxford, 1875), vol. vi. pp. 45-101. Burnet's letters to his friend, George Savile, marquess of Halifax, were published by the Royal Historical Society (*Camden Miscellany*, vol. xi.). The *History of His Own Time* (2 vols. fol., 1724-1734) ran through many editions before it was reprinted at the Clarendon Press (6 vols., 1823, and supplementary volume, 1835) with the suppressed passages of the first volume and notes by the earls of Dartmouth and Hardwicke, with the remarks of Swift. This edition, under the direction of M. J. Routh, was enlarged in a second Oxford edition of 1833. A new edition, based on this, but making use of the Bodleian MS., which differs very considerably from the printed version, was edited by Osmond Airy (Oxford, 1897, &c.). In 1902 (Clarendon Press, Oxford) Miss H. C. Foxcroft edited *A Supplement to Burnet's History of His Own Time*, to which is prefixed an account of the relation between the different versions of the History—the Bodleian MS., the fragmentary Harleian MS. in the British Museum and Sir Thomas Burnet's edition; the book contains the remaining fragments of Burnet's original memoirs, his autobiography, his letters to Admiral Herbert and his private meditations. The chief differences between Burnet's original draft as represented by the Bodleian MS. and the printed history consist in a more lenient view generally of individuals, a modification of the censure levelled at the Anglican clergy, changes obviously dictated by a general variation in his point of view, and a more cautious account of personal matters such as his early relations with Lauderdale. He also cut out much minor detail, and information relating to himself and to members of his family. His

History of the Reformation of the Church of England was edited (Clarendon Press, Oxford, 7 vols., 1865) by N. Pocock.

Besides the works mentioned above may be noticed: *Some Passages of the Life and Death of John, Earl of Rochester* (London, 1680; facsimile reprint, with introduction by Lord Ronald Gower, 1875); *The Life and Death of Sir Matthew Hale, Kt., sometime Lord Chief Justice of his Majesties Court of Kings Bench* (London, 1682), which is included in C. Wordsworth's *Ecclesiastical Biography* (vol. vi., 1818); *The History of the Rights of Princes in disposing of Ecclesiastical Benefices and Church Lands* (London, 1682, 8vo); *The Life of William Bedell, D.D., Bishop of Kilmore in Ireland* (1683), containing the correspondence between Bedell and James Waddesdon of the Holy Inquisition on the subject of the Roman obedience; *Reflections on Mr Varillas's "History of the Resolutions that have happened in Europe in matters of Religion," and more particularly on his Ninth Book, that relates to England* (Amst., 1686), appended to the account of his travels entitled *Some Letters*, which was originally published at Rotterdam (1686); *A Discourse of the Pastoral Care* (1692, 14th ed., 1821); *An Essay on the Memory of the late Queen* (1695); *A Collection of various Tracts and Discourses written in the Years 1677 to 1704* (3 vols., 1704); and *A Collection of Speeches, Prefaces, Letters, with a Description of Geneva and Holland* (1713). Of his shorter religious and polemical works a catalogue is given in vol. vi. of the Clarendon Press edition of his *History*, and in Lowndes's *Bibliographer's Manual*. The following translations deserve to be mentioned:—*Utopia, written in Latin by Sir Thomas More, Chancellor of England; translated into English* (1683); *A Relation of the Death of the Primitive Persecutors, written originally in Latin, by L. C. F. Lactantius; Englished by Gilbert Burnet, D.D., to which he hath made a large preface concerning Persecution* (Amst., 1687).

See also *A Life of Gilbert Burnet, Bishop of Salisbury* (1707), by T. E. S. Clarke and H. C. Foxcroft, with an introduction by C. H. Firth, which contains a chronological list of Burnet's published works. Of Burnet's personal character there are well-known descriptions in chapter vii. of Macaulay's *History of England*, and in W. E. H. Lecky's *History of England in the Eighteenth Century*, vol. i. pp. 80 seq.

BURNET, THOMAS (1635–1715), English divine, was born at Croft in Yorkshire about the year 1635. He was educated at Northallerton, and at Clare Hall, Cambridge. In 1657 he was made fellow of Christ's, and in 1667 senior proctor of the university. By the interest of James, duke of Ormonde, he was chosen master of the Charterhouse in 1685, and took the degree f. D. D. As master he made a noble stand against the illegal attempts to admit Andrew Popham as a pensioner of the house, strenuously opposing an order of the 26th of December 1686, addressed by James II. to the governors dispensing with the statutes for the occasion.

Burnet published his famous *Telluris Theoria Sacra, or Sacred Theory of the Earth*, at London in 1681. This work, containing fanciful theory of the earth's structure,¹ attracted much attention, and he was afterwards encouraged to issue an English translation, which was printed in folio, 1684–1689. Addison commended the author in a Latin ode, but his theory was attacked by John Keill, William Whiston and Erasmus Warren, all of whom he returned answers. His reputation obtained for him an introduction at court by Archbishop Tillotson, whom he succeeded as clerk of the closet to King William. But he suddenly marred his prospects by the publication, in 1692, of a work entitled *Archæologie Philosophicæ: sive Doctrina antiqua de Rerum Originibus*, in which he treated the Mosaic account of the fall of man as an allegory. This excited a great clamour against him; and the king was obliged to remove him from his office at court. Of this book an English translation was published in 1729. Burnet published several other minor works before his death, which took place at the Charterhouse on the 27th of September 1715. Two posthumous works appeared several years after his death—*De Fide et Officiis Christianorum* (1723), and *De Statu Mortuorum et Resurgentium Tractatus* (1723); in which he maintained the doctrine of a middle state, the Millennium, and the limited duration of future punishment. *A Life of Dr Burnet*, by Heathcote, appeared in 1759.

¹ "Which," says Samuel Johnson, "the critic ought to read for elegance, the philosopher for its arguments, and the saint for its piety" (*Lives of English Poets*, vol. i. p. 303).

² Burnet held that at the deluge the earth was crushed like an egg, the internal waters rushing out, and the fragments of shell forming the mountains.

BURNET, known botanically as *Poterium*, a member of the rose family. The plants are perennial herbs with pinnate leaves and small flowers arranged in dense long-stalked heads. Great burnet (*Poterium officinale*) is found in damp meadows; salad burnet (*P. sanguisorba*) is a smaller plant with much smaller flower-heads growing in dry pastures.

BURNETT, FRANCES ELIZA HODGSON (1840–), Anglo-American novelist, whose maiden name was Hodgson, was born in Manchester, England, on the 24th of November 1849; she went to America with her parents, who settled in Knoxville, Tennessee, in 1865. Miss Hodgson soon began to write stories for magazines. In 1873 she married Dr L. M. Burnett of Washington, whom she afterwards (1898) divorced. Her reputation as a novelist was made by her remarkable tale of Lancashire life, *That Lass o' Lowrie's* (1877), and a number of other volumes followed, of which the best were *Through one Administration* (1883) and *A Lady of Quality* (1896). In 1886 she attained a new popularity by her charming story of *Little Lord Fauntleroy*, and this led to other stories of child-life. *Little Lord Fauntleroy* was dramatized (see COPYRIGHT for the legal questions involved) and had a great success on the stage; and other dramas by her were also produced. In 1900 she married a second time, her husband being Mr Stephen Townsend, a surgeon, who (as Will Dennis) had taken to the stage and had collaborated with her in some of her plays.

BURNEY, CHARLES (1726–1814), English musical historian, was born at Shrewsbury on the 12th of April 1726. He received his earlier education at the free school of that city, and was afterwards sent to the public school at Chester. His first music master was Edmund Baker, organist of Chester cathedral, and a pupil of Dr John Blow. Returning to Shrewsbury when about fifteen years old, he continued his musical studies for three years under his half-brother, James Burney, organist of St Mary's church, and was then sent to London as a pupil of the celebrated Dr Arne, with whom he remained three years. Burney wrote some music for Thomson's *Alfred*, which was produced at Drury Lane theatre on the 30th of March 1745. In 1749 he was appointed organist of St Dionis-Backchurch, Fenchurch Street, with a salary of £30 a year; and he was also engaged to take the harpsichord in the "New Concerts" then recently established at the King's Arms, Cornhill. In that year he married Miss Esther Sleepe, who died in 1761; in 1769 he married Mrs Stephen Allen of Lynn. Being threatened with a pulmonary affection he went in 1751 to Lynn in Norfolk, where he was elected organist, with an annual salary of £100, and there he resided for the next nine years. During that time he began to entertain the idea of writing a general history of music. His *Ode for St Cecilia's Day* was performed at Ranelagh Gardens in 1759; and in 1760 he returned to London in good health and with a young family; the eldest child, a girl of eight years of age, surprised the public by her attainments as a harpsichord player. The concertos for the harpsichord which Burney published soon after his return to London were regarded with much admiration. In 1766 he produced, at Drury Lane, a free English version and adaptation of J. J. Rousseau's operetta *Le Devin du village*, under the title of *The Cunning Man*. The university of Oxford conferred upon him, on the 23rd of June 1769, the degrees of Bachelor and Doctor of Music, on which occasion he presided at the performance of his exercise for these degrees. This consisted of an anthem, with an overture, solos, recitatives and choruses, accompanied by instruments, besides a vocal anthem in eight parts, which was not performed. In 1769 he published *An Essay towards a History of Comets*.

Amidst his various professional avocations, Burney never lost sight of his favourite object—his *History of Music*—and therefore resolved to travel abroad for the purpose of collecting materials that could not be found in Great Britain. Accordingly, he left London in June 1770, furnished with numerous letters of introduction, and proceeded to Paris, and thence to Geneva, Turin, Milan, Padua, Venice, Bologna, Florence, Rome and Naples. The results of his observations he published in *The Present State of Music in France and Italy* (1771). Dr Johnson

thought so well of this work that, alluding to his own *Journey to the Western Islands of Scotland*, he said, "I had that clever dog Burney's Musical Tour in my eye." In July 1772 Burney again visited the continent, to collect further materials, and, after his return to London, published his tour under the title of *The Present State of Music in Germany, the Netherlands and United Provinces* (1773). In 1773 he was chosen a fellow of the Royal Society. In 1776 appeared the first volume (in 4to) of his long-projected *History of Music*. In 1782 Burney published his second volume; and in 1789 the third and fourth. Though severely criticised by Forkel in Germany and by the Spanish ex-Jesuit, Requeno, who, in his Italian work *Saggi sul Ristabilimento dell'Arte Armonica de' Greci e Romani Cantori* (Parma, 1798), attacks Burney's account of the ancient Greek music, and calls him *lo scompigliato Burney*, the *History of Music* was generally recognized as possessing great merit. The least satisfactory volume is the fourth, the treatment of Handel and Bach being quite inadequate. Burney's first tour was translated into German by Ebeling, and printed at Hamburg in 1772; and his second tour, translated into German by Bode, was published at Hamburg in 1773. A Dutch translation of his second tour, with notes by J. W. Lustig, organist at Groningen, was published there in 1786. The Dissertation on the Music of the Ancients, in the first volume of Burney's *History*, was translated into German by J. J. Eschenburg, and printed at Leipzig, 1781. Burney derived much aid from the first two volumes of Padre Martini's very learned *Storia della Musica* (Bologna, 1757-1770). One cannot but admire his persevering industry, and his sacrifices of time, money and personal comfort, in collecting and preparing materials for his *History*, and few will be disposed to condemn severely errors and oversights in a work of such extent and difficulty.

In 1774 he had written *A Plan for a Music School*. In 1779 he wrote for the Royal Society an account of the infant Crotch, whose remarkable musical talent excited so much attention at that time. In 1784 he published, with an Italian title-page, the music annually performed in the pope's chapel at Rome during Passion Week. In 1785 he published, for the benefit of the Musical Fund, an account of the first commemoration of Handel in Westminster Abbey in the preceding year, with an excellent life of Handel. In 1796 he published *Memoirs and Letters of Metastasio*. Towards the close of his life Burney was paid £1000 for contributing to Rees's *Cyclopaedia* all the musical articles not belonging to the department of natural philosophy and mathematics. In 1783, through the treasury influence of his friend Edmund Burke, he was appointed organist to the chapel of Chelsea Hospital, and he moved his residence from St Martin's Street, Leicester Square, to live in the hospital for the remainder of his life. He was made a member of the Institute of France, and nominated a correspondent in the class of the fine arts, in the year 1810. From 1806 until his death he enjoyed a pension of £300 granted by Fox. He died at Chelsea College on the 12th of April 1814, and was interred in the burying-ground of the college. A tablet was erected to his memory in Westminster Abbey.

Burney's portrait was painted by Reynolds, and his bust was cut by Nollekens in 1805. He had a wide circle of acquaintance among the distinguished artists and literary men of his day. At one time he thought of writing a life of his friend Dr Samuel Johnson, but he retired before the crowd of biographers who rushed into that field. His character in private as well as in public life appears to have been very amiable and exemplary. Dr Burney's eldest son, James, was a distinguished officer in the royal navy, who died a rear-admiral in 1821; his second son was the Rev. Charles Burney, D.D. (1757-1817), a well-known classical scholar, whose splendid collection of rare books and MSS. was ultimately bought by the nation for the British Museum; and his second daughter was Frances (Madame D'Arbly, q.v.).

The *Diary and Letters of Madame D'Arbly* contain many minute and interesting particulars of her father's public and private life, and of his friends and contemporaries. A life of Burney by Madame D'Arbly appeared in 1832.

Besides the operatic music above mentioned, Burney's known

compositions consist of:—(1) *Six Sonatas for the harpsichord*; (2) *Two Sonatas for the harp or piano, with accompaniments for violin and violoncello*; (3) *Sonatas for two violins and a bass; two sets*; (4) *Six Lessons for the harpsichord*; (5) *Six Duets for two German flutes*; (6) *Three Concertos for the harpsichord*; (7) *Six concert pieces with an introduction and fugue for the organ*; (8) *Six Concertos for the violin, &c., in eight parts*; (9) *Two Sonatas for pianoforte, violin and violoncello*; (10) *A Cantata, &c.*; (11) *Anthems, &c.*; (12) *XII. Canonetti a due voci in Canone, poesia dell' Abate Metastasio.*

BURNHAM BEECHES, a wooded tract of 375 acres in Beckinghamshire, England, acquired in 1879 by the Corporation of the city of London, and preserved for public use. This tract, the remnant of an ancient forest, the more beautiful because of the undulating character of the land, lies west of the road between Slough and Beaconsfield, and 2 m. north of Burnham Beches station on the Great Western railway. The poet Thomas Gray, who stayed frequently at Stoke Poges in the vicinity, is enthusiastic concerning the beauty of the Beeches in a letter to Horace Walpole in 1737. Near the township of Burnham are eight Early English remains of an abbey founded in 1265. Burnham is an urban district with a population (1901) of 3245.

BURNHAM-ON-CROUCH, an urban district in the south-eastern parliamentary division of Essex, England, 43 m. E. by N. from London on a branch of the Great Eastern railway. Pop. (1901) 2919. The church of St Mary is principally late Perpendicular, a good example; it has Decorated portions and a Norman font. There are extensive oyster beds in the Crouch estuary. Burnham lies 6 m. from the North Sea; below it the Crouch is joined on the south side by the Roch, which branches into numerous creeks, and, together with the main estuary, forms Foulness, Wallasea, Potton and other low, flat islands, embanked and protected from incursions of the sea. Burnham is in some repute as a watering-place, and is a favourite yachting station. There is considerable trade in corn and coal, and boat-building is carried on.

BURNING TO DEATH. As a legal punishment for various crimes burning alive was formerly very wide-spread. It was common among the Romans, being given in the XII. Tables as the special penalty for arson. Under the Gothic codes adulterers were so punished, and throughout the middle ages it was the civil penalty for certain heinous crimes, e.g. poisoning, heresy, witchcraft, arson, bestiality and sodomy, and so continued in some cases, nominally at least, till the beginning of the 19th century. In England, under the common law, women condemned for high treason or petty treason (murder of husband, murder of master or mistress, certain offences against the coin, &c.) were burned, this being considered more "decent" than hanging and exposure on a gibbet. In practice the convict was strangled before being burnt. The last woman burnt in England suffered in 1789, the punishment being abolished in 1790.

Burning was not included among the penalties for heresy under the Roman imperial codes; but the burning of heretics by orthodox mobs had long been sanctioned by custom before the edicts of the emperor Frederick II. (1222, 1223) made it the civil-law punishment for heresy. His example was followed in France by Louis IX. in the Establishments of 1270. In England, where the civil law was never recognized, the common law took no cognizance of ecclesiastical offences, and the church courts had no power to condemn to death. There were, indeed, in the 12th and 13th centuries isolated instances of the burning of heretics. William of Newburgh describes the burning of certain foreign secretaries in 1169, and early in the 13th century a deacon was burnt by order of the council of Oxford (Foxe ii. 374; cf. Bracton, *de Corona*, ii. 300), but by what legal sanction is not obvious. The right of the crown to issue writs *de hæretico comburendo*, claimed for it by later jurists, was based on that issued by Henry IV. in 1400 for the burning of William Sawtre, but Sir James Stephen (*Hist. Crim. Law*) points out that this was issued "with the assent of the lords temporal" which seems to prove that the crown had no right under the common law to issue such writs. The burning of heretics was actually made legal in England by the statute *de hæretico comburendo* (1400), passed ten days after the issue of the above writ. This was repealed in 1533, but the Six Articles Act of 1539 revived burning as a penalty

for denying transubstantiation. Under Queen Mary the acts of Henry IV. and Henry V. were revived; they were finally abolished in 1558 on the accession of Elizabeth. Edward VI., Elizabeth and James I., however, burned heretics (illegally as it would appear) under their supposed right of issuing writs for this purpose. The last heretics burnt in England were two Arians, Bartholomew Legate at Smithfield, and Edward Wightman at Lichfield, both in 1610. As for witches, countless numbers were burned in most European countries, though not in England, where they were hanged. In Scotland in Charles II.'s day the law still was that witches were to be "worried at the stake and then burnt"; and a witch was burnt at Dornoch so late as 1708.

BURNLEY, a market town and municipal, county and parliamentary borough of Lancashire, England, at the junction of the rivers Brun and Calder, 213 m. N.N.W. of London and 29 m. N. of Manchester, on the Lancashire and Yorkshire railway and the Leeds & Liverpool Canal. Pop. (1891) 87,016; (1901) 97,043. The church of St Peter dates from the 14th century, but is largely modernized; among a series of memorials of the Towneley family is one to Charles Towneley (d. 1805), who collected the series of antique marbles, terra-cottas, bronzes, coins and gems which are named after him and preserved in the British Museum. In 1902 Towneley Hall and Park were acquired by the corporation, the mansion being adapted to use as a museum and art gallery, and in 1903 a summer exhibition was held here. There are a large number of modern churches and chapels, a handsome town-hall, market hall, museum and art gallery, school of science, municipal technical school, various benevolent institutions, and pleasant public parks and recreation grounds. The principal industries are cotton-weaving, worsted-making, iron-founding, coal-mining, quarrying, brick-burning and the making of sanitary wares. It has been suggested that Burnley may coincide with Brunanburh, the battlefield on which the Saxons conquered the Dano-Celtic force in 937. During the cotton famine consequent upon the American war of 1861-65 it suffered severely, and the operatives were employed on relief works embracing an extensive system of improvements. The parliamentary borough (1867), which returns one member, falls within the Clitheroe division of the county. The county borough was created in 1888. The town was incorporated in 1861. The corporation consists of a mayor, 12 aldermen and 36 councillors. By act of parliament in 1890 Burnley was created a suffragan bishopric of the diocese of Manchester. Area of the municipal borough, 4005 acres.

BURNOUF, EUGÈNE (1801-1852), French orientalist, was born in Paris on the 8th of April 1801. His father, Prof. Jean Louis Burnouf (1775-1844), was a classical scholar of high reputation, and the author, among other works, of an excellent translation of Tacitus (6 vols., 1827-1833). Eugène Burnouf published in 1826 an *Essai sur le Pâli* . . . written in collaboration with Christian Lassen; and in the following year *Observations grammaticales sur quelques passages de l'essai sur le Pâli*. The next great work he undertook was the deciphering of the end manuscripts brought to France by Anquetil du Perron. By his labours a knowledge of the Zend language was first brought to the scientific world of Europe. He caused the *Vendidad Sade*, part of one of the books bearing the name of Zoroaster, to be lithographed with the utmost care from the Zend MS. in the Bibliothèque Nationale, and published it in folio parts, 529-1843. From 1833 to 1835 he published his *Commentaire sur le Yaçna, l'un des livres liturgiques des Parses*; he also published the Sanskrit text and French translation of the *Āgavala Purāna ou histoire poétique de Krishna* in three folio volumes (1840-1847). His last works were *Introduction à l'histoire du Bouddhisme indien* (1844), and a translation of *le Lotus de la bonne loi* (1852). Burnouf died on the 28th of May 1852. He had been for twenty years a member of the Académie des Inscriptions and professor of Sanskrit in the Collège de France. See a notice of Burnouf's works by Barthélemy Saint-Hilaire, prefixed to the second edition (1876) of the *Introd. à l'histoire du bouddhisme indien*; also Naudet, "Notice historique sur M. M. Burnouf, père et fils," in *Mém. de l'Acad. des Inscriptions*, xx. A list of his valuable contributions to the *Journal asiatique*, and of

his MS. writings, is given in the appendix to the *Choix de lettres d'Eugène Burnouf* (1891).

BURNOUS (from the Arab. *burnus*), a long cloak of coarse woollen stuff with a hood, usually white in colour, worn by the Arabs and Berbers throughout North Africa.

BURNS, SIR GEORGE, Bart. (1795-1890), English shipowner, was born in Glasgow on the 10th of December 1795, the son of the Rev. John Burns. In partnership with a brother, James, he began as a Glasgow general merchant about 1818, and in 1824 in conjunction with a Liverpool partner, Hugh Mathie, started a line of small sailing ships which ran between Glasgow and Liverpool. As business increased the vessels were also sailed to Belfast, and steamers afterwards replaced the sailing ships. In 1830 a partnership was entered into with the McIvers of Liverpool, in which George Burns devoted himself specially to the management of the ships. In 1838 with Samuel Cunard, Robert Napier and other capitalists, the partners (McIver and Burns) started the "Cunard" Atlantic line of steamships. They secured the British government's contract for the carrying of the mails to North America. The sailings were begun with four steamers of about 1000 tons each, which made the passage in 15 days at some 8½ knots per hour. George Burns retired from the Glasgow management of the line in 1860. He was made a baronet in 1889, but died on the 2nd of June 1890 at Castle Wemyss, where he had spent the latter years of his life.

John Burns (1829-1901), his eldest son, who succeeded him in the baronetcy, and became head of the Cunard Company, was created a peer, under the title of Baron Inverclyde, in 1897; he was the first to suggest to the government the use of merchant vessels for war purposes. George Arbuthnot Burns (1861-1905) succeeded his father in the peerage, as 2nd Baron Inverclyde, and became chairman of the Cunard Company in 1902. He conducted the negotiations which resulted in the refusal of the Cunard Company to enter the shipping combination, the International Mercantile Marine Company, formed by Messrs J. P. Morgan & Co., and took a leading part in the application of turbine engines to ocean liners.

BURNS, JOHN (1858-), English politician, was born at Vauxhall, London, in October 1858, the second son of Alexander Burns, an engineer, of Ayrshire extraction. He attended a national school in Battersea until he was ten years old, when he was sent to work in Price's candle factory. He worked for a short time as a page-boy, then in some engine works, and at fourteen was apprenticed for seven years to a Millbank engineer. He continued his education at the night-schools, and read extensively, especially the works of Robert Owen, J. S. Mill, Paine and Cobbett. He ascribed his conversion to the principles of socialism to his sense of the insufficiency of the arguments advanced against it by J. S. Mill, but he had learnt socialistic doctrine from a French fellow-workman, Victor Delahaye, who had witnessed the Commune. After working at his trade in various parts of England, and on board ship, he went for a year to the West African coast at the mouth of the Niger as a foreman engineer. His earnings from this undertaking were expended on a six months' tour in France, Germany and Austria for the study of political and economic conditions. He had early begun the practice of outdoor speaking, and his exceptional physical strength and strong voice were invaluable qualifications for a popular agitator. In 1878 he was arrested and locked up for the night for addressing an open-air demonstration on Clapham Common. Two years later he married Charlotte Gale, the daughter of a Battersea shipwright. He was again arrested in 1886 for his share in the West End riots when the windows of the Carlton and other London clubs were broken, but cleared himself at the Old Bailey of the charge of inciting the mob to violence. In November of the next year, however, he was again arrested for resisting the police in their attempt to break up the meeting in Trafalgar Square, and was condemned to six weeks' imprisonment. A speech delivered by him at the Industrial Remuneration Conference of 1884 had attracted considerable attention, and in that year he became a member of the Social Democratic Federation, which put him forward

unsuccessfully in the next year as parliamentary candidate for West Nottingham. His connexion with the Social Democratic Federation was short-lived; but he was an active member of the executive of the Amalgamated Engineers' trade union, and was connected with the trades union congresses until 1895, when, through his influence, a resolution excluding all except wage labourers was passed. He was still working at his trade in Hoe's printing machine works when he became a Progressive member of the first London County Council, being supported by an allowance of £3 a week subscribed by his constituents, the Battersea working men. He introduced in 1892 a motion that all contracts for the County Council should be paid at trade union rates and carried out under trade union conditions, and devoted his efforts in general to a war against monopolies, except those of the state or the municipality. In the same year (1889) in which he became a member of the County Council, he acted with Mr Ben Tillett as the chief leader and organizer of the London dock strike. He entered the House of Commons as member for Battersea in 1892, and was re-elected in 1895, 1900 and 1906. In parliament he became well known as an independent Radical, and he was included in the Liberal cabinet by Sir Henry Campbell-Bannerman in December 1905 as president of the Local Government Board. During the next two years, though much out of favour with his former socialist allies, he earned golden opinions for his administrative policy, and for his refusal to adopt the visionary proposals put forward by the more extreme members of the Labour party for dealing with the "unemployed" question; and in 1908 he retained his office in Mr Asquith's cabinet.

BURNS, ROBERT (1759-1796), Scottish poet, was born on the 25th of January 1759 in a cottage about 2 m. from Ayr. He was the eldest son of a small farmer, William Burness, of Kincardineshire stock, who wrought hard, practised integrity, wished to bring up his children in the fear of God, but had to fight all his days against the winds and tides of adversity. "The poet," said Thomas Carlyle, "was fortunate in his father—a man of thoughtful intense character, as the best of our peasants are, valuing knowledge, possessing some and open-minded for more, of keen insight and devout heart, friendly and fearless: a fully unfolded man seldom found in any rank in society, and worth descending far in society to seek. . . . Had he been ever so little richer, the whole might have issued otherwise. But poverty sunk the whole family even below the reach of our cheap school system, and Burns remained a hard-worked plough-boy."

Through a series of migrations from one unfortunate farm to another; from Alloway (where he was taught to read) to Mt. Oliphant, and then (1777) to Lochles in Tarbolton (where he learnt the rudiments of geometry), the poet remained in the same condition of straitened circumstances. At the age of thirteen he thrashed the corn with his own hands, at fifteen he was the principal labourer. The family kept no servant, and for several years butchers' meat was a thing unknown in the house. "This kind of life," he writes, "the cheerless gloom of a hermit and the unceasing toil of a galley-slave, brought me to my sixteenth year." His naturally robust frame was overtasked, and his nervous constitution received a fatal strain. His shoulders were bowed, he became liable to headaches, palpitations and fits of depressing melancholy. From these hard tasks and his fiery temperament, craving in vain for sympathy in a frigid air, grew the strong temptations on which Burns was largely wrecked,—the thirst for stimulants and the revolt against restraint which soon made headway and passed all bars. In the earlier portions of his career a buoyant humour bore him up; and amid thickcoming shapes of ill he bated no jot of heart or hope. He was cheered by vague stirrings of ambition, which he pathetically compares to the "blind groping of Homer's Cyclops round the walls of his cave." Sent to school at Kirkoswald, he became, for his scant leisure, a great reader—eating at meal-times with a spoon in one hand and a book in the other,—and carrying a few small volumes in his pocket to study in spare moments in the fields. "The collection of songs," he tells us, "was my *sode success*. I pored over them driving my cart or walking to labour,

song by song, verse by verse, carefully noting the true, tender, sublime or fustian." He lingered over the ballads in his cold room by night; by day, whilst whistling at the plough, he invented new forms and was inspired by fresh ideas, "gathering round him the memories and the traditions of his country till they became a mantle and a crown." It was among the furrows of his father's fields that he was inspired with the perpetually quoted wish—

"That I for poor auld Scotland's sake
Some useful plan or book could make,
Or sing a sang at least."

An equally striking illustration of the same feeling is to be found in his summer Sunday's ramble to the Leglan wood,—the fabled haunt of Wallace,—which the poet confesses to have visited "with as much devout enthusiasm as ever pilgrim did the shrine of Loretto." In another reference to the same period he refers to the intense susceptibility to the homeliest aspects of Nature which throughout characterized his genius. "Scarcely any object gave me more—I do not know if I should call it pleasure—but something which exalts and enraptures me—than to walk in the sheltered side of a wood or high plantation in a cloudy winter day and hear the stormy wind howling among the trees and raving over the plain. I listened to the birds, and frequently turned out of my path lest I should disturb their little songs or frighten them to another station." Auroral visions were gliding his horizon as he walked in glory, if not in joy, "behind his plough upon the mountain side"; but the swarm of his many-coloured fancies was again made grey by the *œva curæ* of unsuccessful toils.

Burns had written his first verses of note, "Behind yon hills where Stinchar (afterwards Lugar) flows," when in 1781 he went to Irvine to learn the trade of a flax-dresser. "It was," he says, "an unlucky affair. As we were giving a welcome carousal to the New Year, the shop took fire and burned to ashes; and I was left, like a true poet, without a sixpence." His own heart, too, had unfortunately taken fire. He was poring over mathematics till, in his own phraseology,—still affected in its prose by the classical pedantries caught from Pope by Ramsay,—"the sun entered Virgo, when a charming *fillette*, who lived next door, overset my trigonometry, and set me off at a tangent from the scene of my studies." We need not detail the story, nor the incessant repetitions of it, which marked and sometimes marred his career. The poet was jilted, went through the usual despairs, and resorted to the not unusual sources of consolation. He had found that he was "no enemy to social life," and his mates had discovered that he was the best of boon companions in the lyric feasts, where his eloquence shed a lustre over wild ways of life, and where he was beginning to be distinguished as a champion of the New Lights and a satirist of the Calvinism whose waters he found like those of Marah.

In Robert's 25th year his father died, full of sorrows and apprehensions for the gifted son who wrote for his tomb in Alloway kirkyard, the fine epitaph ending with the characteristic line—

"For even his failings leaned to virtue's side."

For some time longer the poet, with his brother Gilbert, lingered at Lochles, reading agricultural books, miscalculating crops, attending markets, and in a mood of reformation resolving, "in spite of the world, the flesh and the devil, to be a wise man." Affairs, however, went no better with the family; and in 1784 they migrated to Mossiel, where he lived and wrought, during four years, for a return scarce equal to the wage of the commonest labourer in our day. Meanwhile he had become intimate with his future wife, Jean Armour; but the father, a master mason, discountenanced the match, and the girl being disposed to "sigh as a lover," as a daughter to obey, Burns, in 1786, gave up his suit, resolved to seek refuge in exile, and having accepted a situation as book-keeper to a slave estate in Jamaica, had taken his passage in a ship for the West Indies. His old associations seemed to be breaking up, men and fortune aged, and "hungry ruin had him in the wind," when he wrote the lines ending—

Adieu, my native banks of Ayr,"

and addressed to the most famous of the loves, in which he was as prolific as Catullus or Tibullus, the proposal—

"Will ye go to the Indies, my Mary."

He was withheld from his project and, happily or unhappily, the current of his life was turned by the success of his first volume, which was published at Kilmarnock in June 1786. It contained some of his most justly celebrated poems, the results of his scanty leisure at Lochlea and Mossiel; among others "The Two Dogs,"—a graphic idealization of Aesop,—"The Author's Prayer," the "Address to the Deil," "The Vision," and "The Dream," "Halloween," "The Cottar's Saturday Night," the lines "To a Mouse" and "To a Daisy," "Scotch Ink," "Man was made to Mourn," the "Epistle to Davie," and some of his most popular songs. This epitome of a genius marvellous and so varied took his audience by storm. "The entry murmured of him from sea to sea." "With his poems," says Robert Heron, "old and young, grave and gay, learned and ignorant, were alike transported. I was at that time resident in Glasgow, and I can well remember how even plough-boys and servants would have gladly bestowed the wages they earned most hardly, and which they wanted to purchase necessary clothing, if they might but procure the works of Burns." This edition only brought the author £30 direct return, but it induced him to the *literati* of Edinburgh, whither he was called, and where he was welcomed, feasted, admired and prized. He appeared as a portent among the scholars of the new capital and its university, and manifested, according to Lockhart, "in the whole strain of his bearing, his belief in the society of the most eminent men of his nation he was as he was entitled to be, hardly deigning to flatter them by giving a symptom of being flattered."

Walter Scott bears a similar testimony to the dignified dignity and almost exaggerated independence of the poet, this *annus mirabilis* of his success. "As for Burns, *in vidi tantum*, I was a lad of fifteen when he came to Glasgow, but had sense enough to be interested in his poetry, and had given the world to know him. I saw him once at several gentlemen of literary reputation, among whom I remember the celebrated Dugald Stewart. Of course we were silent, looked, and listened. . . . I remember shedding tears over a print representing a soldier lying in the snow, his dog sitting in misery on one side, on the other a widow with a child in her arms. His person was robust, his features rustic, not clownish. . . . His countenance was more alive than it looks in any of the portraits. There was a penetration of shrewdness in his lineaments; the eye indicated the poetic character and temperament. It was of a dark cast, and literally glowed when he spoke with interest. I never saw such another eye in a human face. His conversation expressed perfect self-confidence, and was at least intrusive forwardness. I thought his acquaintance with English poetry was rather limited; and having seen the abilities of Allan Ramsay and of Fergusson, he seemed to me with too much humility as his models. He was educated in Edinburgh, but the efforts made for his relief were chiefly trifling." *Laudator et alget*. Burns went from Glasgow, where he had been posing professors (no hardening the heads of duchesses, to share a bed in the writer's apprentice,—they paid together 3s. a week.

It was in the house of Mr Carfrae, Baxter's Close, that Burns first ascended the "first scale stair on the left hand in going down, he stair." During Burns's life it was reserved for him to recognize his place as a great poet; the more so as the people of the North were satisfied to endorse him as a bard, and brought upon themselves a share of his fame by the friendships contracted during this period. Glencairn and Mrs Dunlop—are among the most permanent in literature; for genuine kindness is not so easily won as one who, whatever his faults, has never been without a certain attitude. . . . But in the bard's city life there was an

unnatural element. He stooped to beg for neither smiles nor favour, but the gnarled country oak is cut up into cabinets in artificial prose and verse. In the letters to Mr Graham, the prologue to Mr Wood, and the epistles to Clarinda, he is dancing minuets with hob-nailed shoes. When, in 1787, the second edition of the *Poems* came out, the proceeds of their sale realized for the author £400. On the strength of this sum he gave himself two long rambles, full of poetic material—one through the border towns into England as far as Newcastle, returning by Dumfries to Mauchline, and another a grand tour through the East Highlands, as far as Inverness, returning by Edinburgh, and so home to Ayrshire.

In 1788 Burns took a new farm at Ellisland on the Nith, settled there, married, lost his little money, and wrote, among other pieces, "Auld Lang Syne" and "Tam o' Shanter." In 1789 he obtained, through the good office of Mr Graham of Fintry, an appointment as excise-officer of the district, worth £50 per annum. In 1791 he removed to a similar post at Dumfries worth £70. In the course of the following year he was asked to contribute to George Thomson's *Select Collection of Original Scottish Airs with Symphonies and Accompaniments for the Pianoforte and Violin: the poetry by Robert Burns*. To this work he contributed about one hundred songs, the best of which are now ringing in the ear of every Scotsman from New Zealand to San Francisco. For these, original and adapted, he received a shawl for his wife, a picture by David Allan representing the "Cottar's Saturday Night," and £51. The poet wrote an indignant letter and never afterwards composed for money. Unfortunately the "Rock of Independence" to which he had proudly retired was but a castle of air, over which the meteors of French political enthusiasm cast a lurid gleam. In the last years of his life, exiled from polite society on account of his revolutionary opinions, he became sourer in temper and plunged more deeply into the dissipations of the lower ranks, among whom he found his only companionship and sole, though shallow, sympathy.

Burns began to feel himself prematurely old. Walking with a friend who proposed to him to join a county ball, he shook his head, saying "that's all over now," and adding a verse of Lady Grizel Baillie's ballad—

"O were we young as we ance hae been,
We sud hae been galloping down on you green,
And linking it ower the lily-white lea,
But were na my heart light I wad dee."

His hand shook; his pulse and appetite failed; his spirits sunk into a uniform gloom. In April 1796 he wrote—"I fear it will be some time before I tune my lyre again. By Babel's streams I have sat and wept. I have only known existence by the pressure of sickness and counted time by the repercussions of pain. I close my eyes in misery and open them without hope. I look on the vernal day and say with poor Fergusson—

"Say wherefore has an all-indulgent heaven
Life to the comfortless and wretched given

On the 4th of July he was seen to be dying. On the 12th he wrote to his cousin for the loan of £10 to save him from passing his last days in jail. On the 21st he was no more. On the 25th, when his last son came into the world, he was buried with local honours, the volunteers of the company to which he belonged firing three volleys over his grave.

It has been said that "Lowland Scotland as a distinct nationality came in with two warriors and went out with two bards. It came in with William Wallace and Robert Bruce and went out with Robert Burns and Walter Scott. The first two made the history, the last two told the story and sung the song." But what in the minstrel's lay was mainly a requiem was in the people's poet also a prophecy. The position of Burns in the progress of British literature may be shortly defined; he was a link between two eras, like Chaucer, the last of the old and the first of the new—the inheritor of the traditions and the music of the past, in some respects the herald of the future.

The volumes of our lyric owe part of their popularity to the fact of their being an epitome of melodies, moods and memories that had belonged for centuries to the national life, the best

inspirations of which have passed into them. But in gathering from his ancestors Burns has exalted their work by asserting a new dignity for their simplest themes. He is the heir of Barbour, distilling the spirit of the old poet's epic into a battle chant, and of Dunbar, reproducing the various humours of a half-sceptical, half-religious philosophy of life. He is the pupil of Ramsay, but he leaves his master, to make a social protest and to lead a literary revolt. *The Gentle Shepherd*, still largely a court pastoral, in which "a man's a man" if born a gentleman, may be contrasted with "The Jolly Beggars"—the one is like a minuté of the ladies of Versailles on the sward of the Swiss village near the Trianon, the other like the march of the maenads with Theroigne de Mericourt. Ramsay adds to the rough tunes and words of the ballads the refinement of the wits who in the "Easy" and "Johnstone" clubs talked over their cups of Prior and Pope, Addison and Gay. Burns inspires them with a fervour that thrills the most wooden of his race. We may clench the contrast by a representative example. This is from Ramsay's version of perhaps the best-known of Scottish songs,—

"Methinks around us on each bough
A thousand Cupids play;
Whilst through the groves I walk with you,
Each object makes me gay.
Since your return—the sun and moon
With brighter beams do shine,
Streams murmur soft notes while they run
As they did lang syne."

Compare the verses in Burns—

"We twa hae run about the braes
And pu'd the gowans fine;
But we've wandered mony a weary foot
Sin auld lang syne.
We twa hae paid' d in the burn,
Frae morning sun till dine:
But seas between us braid hae roar'd
Sin auld lang syne."

Burns as a poet of the inanimate world doubtless derived hints from Thomson of *The Seasons*, but in his power of tuning its manifestation to the moods of the mind he is more properly ranked as a forerunner of Wordsworth. He never follows the fashions of his century, except in his failures—in his efforts at set panegyric or fine letter-writing. His highest work knows nothing of "Damon" or "Musidora." He leaves the atmosphere of drawing-rooms for the ingle or the ale-house or the mountain breeze.

The affectations of his style are insignificant and rare. His prevailing characteristic is an absolute sincerity. A love for the lower forms of social life was his besetting sin; Nature was his healing power. Burns compares himself to an Aeolian harp, strung to every wind of heaven. His genius flows over all living and lifeless things with a sympathy that finds nothing mean or insignificant. An uprooted daisy becomes in his pages an enduring emblem of the fate of artless maid and simple bard. He disturbs a mouse's nest and finds in the "tim'rous beastie" a fellow-mortal doomed like himself to "thole the winter's sleety dribble," and draws his oft-repeated moral. He walks abroad and, in a verse that glints with the light of its own rising sun before the fierce sarcasm of "The Holy Fair," describes the melodies of a "simmer Sunday morn." He loiters by Afton Water and "murmurs by the running brook a music sweeter than his own." He stands by a roofless tower, where "the howlet mourns in her dewy bower," and "sets the wild echoes flying," and adds to a perfect picture of the scene his famous vision of "Libertie." In a single stanza he concentrates the sentiment of many Night Thoughts—

"The pale moon is setting beyond the white wave,
And Time is setting wi' me, O."

For other examples of the same graphic power we may refer to the course of his stream—

"Whiles ow'r a linn the burnie plays
As through the glen it wimpled," &c.,

or to "The Birks of Aberfeldy" or the "spate" in the dialogue of "The Brigs of Ayr." The poet is as much at home in the

presence of this flood as by his "trottin' burn's meander." Familiar with all the seasons he represents the phases of a northern winter with a frequency characteristic of his clime and of his fortunes; her tempests became anthems in his verse, and the sounding woods "raise his thoughts to Him that walketh on the wings of the wind"; full of pity for the shelterless poor, the "ourie cattle," the "silly aheep," and the "helpless birds," he yet reflects that the bitter blast is not "so unkind as man's ingratitude." This constant tendency to ascend above the fair or wild features of outward things, or to penetrate beneath them, to make them symbols, to endow them with a voice to speak for humanity, distinguishes Burns as a descriptive poet from the rest of his countrymen. As a painter he is rivalled by Dunbar and James I., more rarely by Thomson and Ramsay. The "kilt" of Tannahill's finest verse is even more charming. But these writers rest in their art; their main care is for their own genius. The same is true in a minor degree of some of his great English successors. Keats has a palette of richer colours, but he seldom condescends to "human nature's daily food." Shelley floats in a thin air to stars and mountain tops, and vanishes from our gaze like his skylark. Byron, in the midst of his revolutionary fervour, never forgets that he himself belongs to the "caste of Vere de Vere." Wordsworth's placid affection and magnanimity stretch beyond mankind, and, as in "Hart-leap-well" and the "Cuckoo," extend to bird and beast; he moralizes grandly on the vicissitudes of common life, but he does not enter into, because by right of superior virtue he places himself above them. "From the Lyrical Ballads," it has been said, "it does not appear that men eat or drink, marry or are given in marriage." We revere the monitor who, consciously good and great, gives us the dry light of truth, but we love the bard, *maestro delizioso*, who is all fire—fire from heaven and Ayrshire earth mingling in the outburst of passion and of power, which is his poetry and the inheritance of his race. He had certainly neither culture nor philosophy enough to have written the "Ode on the Recollections of Childhood," but to appreciate that ode requires an education. The sympathies of Burns, as broad as Wordsworth's, are more intense; in turning his pages we feel ourselves more decidedly in the presence of one who joys with those who rejoice and mourns with those who mourn. He is never shallow, ever plain, and the expression of his feeling is so terse that it is always memorable. Of the people he speaks more directly for the people than any of our more considerable poets. Chaucer has a perfect hold of the homeliest phases of life, but he wants the lyric element, and the charm of his language has largely faded from untutored ears. Shakespeare, indeed, has at once a loftier vision and a wider grasp; for he sings of "Thebes and Pelops line," of Agincourt and Philippi, as of Falstaff, and Snaug the joiner, and the "meanest flower that blows." But not even Shakespeare has put more thought into poetry which the most prosaic must appreciate than Burns has done. The latter moves in a narrower sphere and wants the strictly dramatic faculty, but its place is partly supplied by the vividness of his narrative. His realization of incident and character is manifested in the sketches in which the manners and prevailing fancies of his countrymen are immortalized in connexion with local scenery. Among those almost every variety of disposition finds its favourite. The quiet households of the kingdom have received a sort of apotheosis in the "Cottar's Saturday Night." It has been objected that the subject does not afford scope for the more daring forms of the author's genius; but had he written no other poem, this heartfelt rendering of a good week's close in a God-fearing home, sincerely devout, and yet relieved from all suspicion of sermonizing by its humorous touches, would have secured a permanent place in literature. It transcends Thomson and Beattie at their best, and will smell sweet like the actions of the just for generations to come.

Lovers of rustic festivity may hold that the poet's greatest performance is his narrative of "Halloween," which for easy vigour, fullness of rollicking life, blended truth and fancy, is unsurpassed in its kind. Campbell, Wilson, Hazlitt, Montgomery, Burns himself, and the majority of his critics, have

reference for "Tam o' Shanter," where the rus element that has played so great a part in work of this part of our island is brought more ward. Few passages of description are finer roaring Doon and Alloway Kirk glimmering aning trees; but the unique excellence of the its variety, and a perfectly original combination d the ludicrous. Like Goethe's *Walpurgis Nacht*, ser contact with real life, it stretches from the rs of Christopher Sly to a world of fantasies it as those of the *Midsummer Night's Dream*, half he severer atmosphere of a sterner clime. The a the lines "Kings may be blest," &c., and those ginning "But pleasures are like poppies spread," perpetual antithesis of the author's thought and t the back of every revelry, he sees the shadow nd, and reads on the wall the writing, *Omnia h equal or greater confidence other judges have rns's masterpiece to be "The Jolly Beggars."* her single production so illustrates his power t is insignificant, glorifying what is mean, and west details by the force of his genius. "The e," says Carlyle, "is a mere cantata, the theme n snatches of a joyous band of vagabonds, while re floating on the gusts of the wind in the autumn ut the whole is compacted, refined and poured d of liquid harmony. It is light, airy and soft of sharp and precise in its details; every face is a he whole a group in clear photography. The ight is drawn aside; in full ruddy gleaming light tterdemalions are seen at their boisterous revel Fate another hour of wassail and good cheer." : is flung a half-humorous, half-savage satire— o-edged sword, at the laws and the law-breakers, which the graceless crew are raised above the level ies, footpads and rogues, and are made to sit ke gods together, careless of mankind," and to an thunders of rebellion against the world.

fig for those by law protected;
Liberty's a glorious feast;
urts for cowards were erected,
Churches built to please the priest."

ixture of drollery and defiance appears in the d "Address to the Deil" which, mainly whimsical, ouches of pathos curiously quaint. "The effect t has been observed, "was never more happily i in the conception of such a being straying in and loitering among trees, or in the familiarity e poet lectures so awful a personage,"—we may e inevitable outbreak at the close—

O would you tak a thought an' men'."

ference to this passage, cannot resist the sugges- lel from Sterne. "He is the father of curses and p, and is cursed and damned already. I am sorry y Uncle Toby."
ill at the hands of those who were not sorry for it, ated with glib complacency every terrible belief a which they had been trained. The most scathing under which head fall many of his minor and ges in his major pieces, are directed against the birth, and what he conceived to be the false pre- on. The apologue of "Death and Dr Hornbook," ion," the song "No churchman am I for to rail the "Address to the Unco Guid," "Holy Willie," "The Holy Fair," with its savage caricature of an er of the time called Moodie, and others of like naturally provoked offence. As regards the poet's rds some phases of Calvinism prevalent during his e remarked that from the days of Dunbar there e of antagonism between Scottish verse and the ms of Scottish theology.

It must be admitted that in protesting against hypocrisy he has occasionally been led beyond the limits prescribed by good taste. He is at times abusive of those who differ from him. This, with other offences against decorum, which here and there disfigure his pages, can only be condoned by an appeal to the general tone of his writing, which is reverential. Burns had a firm faith in a Supreme Being, not as a vague mysterious Power; but as the Arbiter of human life. Amid the vicissitudes of his career he responds to the cottar's summons, "Let us worship God."

"An atheist's laugh's a poor exchange
For Deity offended"

is the moral of all his verse, which treats seriously of religious matters. His prayers in rhyme give him a high place among secular Psalmists.

Like Chaucer, Burns was a great moralist, though a rough one. In the moments of his most intense revolt against conventional prejudice and sanctimonious affectation, he is faithful to the great laws which underlie change, loyal in his veneration for the cardinal virtues—Truth, Justice and Charity,—and consistent in the warnings, to which his experience gives an unhappy force, against transgressions of Temperance. In the "Epistle to a Young Friend," the shrewdest advice is blended with exhortations appealing to the highest motive, that which transcends the calculation of consequences, and bids us walk in the straight path from the feeling of personal honour, and "for the glorious privilege of being independent." Burns, like Dante, "loved well because he hated, hated wickedness that hinders loving," and this feeling, as in the lines—"Dweller in yon dungeon dark," sometimes breaks bounds; but his calmer moods are better represented by the well-known passages in the "Epistle to Davie," in which he preaches acquiescence in our lot, and a cheerful acceptance of our duties in the sphere where we are placed. This *philosophie douce*, never better sung by Horace, is the prevailing refrain of our author's *Songs*. On these there are few words to add to the acclaim of a century. They have passed into the air we breathe; they are so real that they seem things rather than words, or, nearer still, living beings. They have taken all hearts, because they are the breath of his own; not polished cadences, but utterances as direct as laughter or tears. Since Sappho loved and sang, there has been no such national lyricist as Burns. Fine ballads, mostly anonymous, existed in Scotland previous to his time; and shortly before a few authors had produced a few songs equal to some of his best. Such are Alexander Ross's "Wooded and Married," Lowe's "Mary's Dream," "Auld Robin Gray," "The Land o' the Leal" and the two versions of "The Flowers o' the Forest." From these and many of the older pieces in Ramsay's collection, Burns admits to have derived copious suggestions and impulses. He fed on the past literature of his country as Chaucer on the old fields of English thought, and—

"Still the elements o' sang,
In formless jumble, right and wrang,
Went floating in his brain."

But he gave more than he received; he brought forth an hundred-fold; he summed up the stray material of the past, and added so much of his own that one of the most conspicuous features of his lyrical genius is its variety in new paths. Between the first of war songs, composed in a storm on a moor, and the pathos of "Mary in Heaven," he has made every chord in our northern life to vibrate. The distance from "Duncan Gray" to "Auld Lang Syne" is nearly as great as that from Falstaff to Ariel. There is the vehemence of battle, the wail of woe, the march of veterans "red-wat-shod," the smiles of meeting, the tears of parting friends, the gurgle of brown burns, the roar of the wind through pines, the rustle of barley rigs, the thunder on the hill—all Scotland is in his verse. Let who will make her laws, Burns has made the songs, which her emigrants recall "by the long wash of Australasian seas," in which maidens are wooed, by which mothers lull their infants, which return "through open casements unto dying ears"—they are the links, the watchwords, the masonic symbols of the Scots race. (J. N.)

The greater part of Burns's verse was posthumously published, and, as he himself took no care to collect the scattered pieces of occasional verse, different editors have from time to time printed, as his, verses that must be regarded as spurious. *Poems chiefly in the Scottish Dialect*, by Robert Burns (Kilmarnock, 1786), was followed by an enlarged edition printed in Edinburgh in the next year. Other editions of this book were printed—in London (1787), an enlarged edition at Edinburgh (2 vols., 1793) and a reprint of this in 1794. Of a 1790 edition mentioned by Robert Chambers no traces can be found. Poems by Burns appeared originally in *The Caledonian Mercury*, *The Edinburgh Evening Courant*, *The Edinburgh Herald*, *The Edinburgh Advertiser*; the London papers, *Stuart's Star*, *Edinburgh Magazine* (subsequently known as *The Morning Star*), *Scots Magazine*. Many poems, most of which had first appeared elsewhere, were printed in a series of penny chap-books, *Poetry Original and Select* (Braah and Reid, Glasgow), and some appeared separately as broadsides. A series of tracts issued by Stewart and Meikle (Glasgow, 1796-1799) includes some Burns's numbers, *The Jolly Beggars*, *Holy Willie's Prayer* and other poems making their first appearance in this way. The seven numbers of this publication were reissued in January 1800 as *The Poetical Miscellany*. This was followed by Thomas Stewart's *Poems ascribed to Robert Burns* (Glasgow, 1801). Burns's songs appeared chiefly in James Johnson's *Scots Musical Museum* (6 vols., 1787-1803), which he appears after the first volume to have virtually edited, though the two last volumes were published only after his death; and in George Thomson's *Select Collection of Original Scottish Airs* (6 vols., 1793-1841). Only five of the songs done for Thomson appeared during the poet's lifetime, and Thomson's text cannot be regarded with confidence. The *Hastie MSS.* in the British Museum (Addit. MS. 22,307) include 162 songs, many of them in Burns's handwriting; and the Dalhousie MS. at Brechin Castle, contains Burns's correspondence with Thomson. For a full account of the songs see James C. Dick, *The Songs of Robert Burns now first printed with the Melodies for which they were written* (2 vols., 1905).

The items in Mr W. Craibe Angus's *Printed Works of Robert Burns* (1809) number nine hundred and thirty. Only the more important collected editions can be here noticed. Dr Currie was the anonymous editor of the *Works of Robert Burns; with an Account of his Life, and a Criticism on his Writings* . . . (Liverpool, 1800). This was undertaken for the benefit of Burns's family at the desire of his friends, Alexander Cunningham and John Syme. A second and amended edition appeared in 1801, and was followed by others, but Currie's text is neither accurate nor complete. Additional matter appeared in *Reliques of Robert Burns* . . . by R. H. Cromek (London, 1808). In *The Works of Robert Burns, With his Life by Allan Cunningham* (8 vols., London, 1834) there are many additions and much biographical material. *The Works of Robert Burns*, edited by James Hogg and William Motherwell (5 vols., 1834-1836, Glasgow and Edinburgh), contains a life of the poet, by Hogg, and some useful notes by Motherwell attempting to trace the sources of Burns's songs. *The Correspondence between Burns and Clarinda* was edited by W. C. M'Lehose (Edinburgh, 1843). An improved text of the poems was provided in the second "Aldine Edition" of the *Poetical Works* (3 vols., 1839), for which Sir H. Nicolas, the editor, made use of many original MSS. In *The Life and Works of Robert Burns*, edited by Robert Chambers (Edinburgh, 4 vols., 1851-1852; library edition, 1856-1857; new edition, revised by William Wallace, 1896), the poet's works are given in chronological order, interwoven with letters and biography. The text was bowdlerized by Chambers, but the book contained much new and valuable information. Other well-known editions are those of George Gillfillan (2 vols., 1864); of Alexander Smith (Golden Treasury Series, London, 2 vols., 1865); of P. Hatley Waddell (Glasgow, 1867); one published by Messrs Blackie & Son, with Dr Currie's memoir and an essay by Prof. Wilson (1843-1844); of W. Scott Douglas (the Kilmarnock edition, 1876, and the "library" edition, 1877-1879), and of Andrew Lang, assisted by W. A. Craigie (London, 1896). The complete correspondence between Burns and Mrs Dunlop was printed in 1808.

A critical edition of the *Poetry of Robert Burns*, which may be regarded as definitive, and is provided with full notes and variant readings, was prepared by W. E. Henley and T. F. Henderson (4 vols., Edinburgh, 1896-1897; reprinted, 1901), and is generally known as the "Centenary Burns." In vol. iii. the extent of Burns's indebtedness to Scottish folk-song and his methods of adaptation are minutely discussed; vol. iv. contains an essay on "Robert Burns. Life, Genius, Achievement," by W. E. Henley.

The chief original authority for Burns's life is his own letters. The principal "lives" are to be found in the editions just mentioned. His biography has also been written by J. Gibson Lockhart (*Life of Burns*, Edinburgh, 1828); for the "English Men of Letters" series in 1879 by Prof. J. Campbell Shairp; and by Sir Leslie Stephen in the *Dictionary of National Biography* (vol. viii., 1886). Among the more important essays on Burns are those by Thomas Carlyle (*Edinburgh Review*, December 1828); by John Nichol, the writer of the above article (W. Scott Douglas's edition of Burns); by R. L. Stevenson (*Familiar Studies of Men and Books*); by Auguste Angellier (*Robert Burns. La vie et les œuvres*, 2 vols., Paris,

1893); by Lord Rosebery (*Robert Burns: Two Addresses in Edinburgh*, 1896); by J. Logie Robertson (in *In Scottish Fields*, Edin., 1890, and *Furth in Field*, Edin., 1894); and T. F. Henderson (*Robert Burns*, 1904). There is a selected bibliography in chronological order in W. A. Craigie's *Primer of Burns* (1896).

BURNS AND SCALDS. A burn is the effect of dry heat applied to some part of the human body, a scald being the result of moist heat. Clinically there is no distinction between the two, and their classification and treatment are identical. In Dupuytren's classification, now most generally accepted, burns are divided into six classes according to the severest part of the lesion. Burns of the first degree are characterized by severe pain, redness of the skin, a certain amount of swelling that soon passes, and later exfoliation of the skin. Burns of the second degree show vesicles (small blisters) scattered over the inflamed area, and containing a clear, yellowish fluid. Beneath the vesicle the highly sensitive papillae of the skin are exposed. Burns of this degree leave no scar, but often produce a permanent discoloration. In burns of the third degree, there is a partial destruction of the true skin, leaving sloughs of a yellowish or black colour. The pain is at first intense, but passes off on about the second day to return again at the end of a week, when the sloughs separate, exposing the sensitive nerve filaments of the underlying skin. This results in a slightly depressed cicatrix, which happily, however, shows but slight tendency to contraction. Burns of the fourth degree, which follow the prolonged application of any form of intense heat, involve the total destruction of the true skin. The pain is much less severe than in the preceding class, since the nerve endings have been totally destroyed. The results, however, are far more serious, and the healing process takes place only very slowly on account of the destruction of the skin glands. As a result, deep puckered scars are formed, which show great tendency to contract, and where these are situated on face, neck or joints the resulting deformity and loss of function may be extremely serious. In burns of the fifth degree the underlying muscles are more or less destroyed, and in those of the sixth the bones are also charred. Examples of the last two classes are mainly provided by epileptics who fall into a fire during a fit.

The clinical history of a severe burn can be divided into three periods. The first period lasts from 36 to 48 hours, during which time the patient lies in a condition of profound shock, and consequently feels little or no pain. If death results from shock, coma first supervenes, which deepens steadily until the end comes. The second period begins when the effects of shock pass, and continues until the slough separates, this usually taking from seven to fourteen days. Considerable fever is present, and the tendency to every kind of complication is very great. Bronchitis, pneumonia, pleurisy, meningitis, intestinal catarrh, and even ulceration of the duodenum, have all been recorded. Hence both nursing and medical attendance must be very close during this time. It is probable that these complications are all the result of septic infection and absorption, and since the modern antiseptic treatment of burns they have become much less common. The third period is prolonged until recovery takes place. Death may result from septic absorption, or from the wound becoming infected with some organism, as tetanus, erysipelas, &c. The prognosis depends chiefly on the extent of skin involved, death almost invariably resulting when one-third of the total area of the body is affected, however superficially. Of secondary but still grave importance is the position of the burn, that over a serous cavity making the future more doubtful than one on a limb. Also it must be remembered that children very easily succumb to shock.

In treating a patient the condition of shock must be attended to first, since from it arises the primary danger. The sufferer must be wrapped immediately in hot blankets, and brandy given by the mouth or in an enema, while ether can be injected hypodermically. If the pulse is very bad a saline infusion must be administered. The clothes can then be removed and the burnt surfaces thoroughly cleansed with a very mild antiseptic, a weak solution of lysol acting very well. If there are blisters these must be opened and the contained effusion allowed to

escape. Some surgeons leave them at this stage, but others prefer to remove the raised epithelium. When thoroughly cleansed, the wound is irrigated with sterilized saline solution and a dressing subsequently applied. For the more superficial lesions by far the best results are obtained from the application of gauze soaked in picric acid solution and lightly wrung out, being covered with a large antiseptic wool pad and kept in position by a bandage. Picric acid 1½ drams, absolute alcohol 3 oz., and distilled water 40 oz., make a good lotion. All being well, this need only be changed about twice a week. The various kinds of oil once so greatly advocated in treating burns are now largely abandoned since they have no antiseptic properties. The deeper burns can only be attended to by a surgeon, whose aim will be first to bring septic absorption to a minimum, and later to hasten the healing process. Skin grafting has great value after extensive burns, not because it hastens healing, which it probably does not do, but because it has a marked influence in lessening cicatricial contraction. When a limb is hopelessly charred, amputation is the only course.

BURNSIDE, AMBROSE EVERETT (1824-1881), American soldier, was born at Liberty, Indiana, on the 23rd of May 1824, of Scottish pedigree, his American ancestors settling first in South Carolina, and next in the north-west wilderness, where his parents lived in a rude log cabin. He was appointed to the United States military academy through casual favour, and graduated in 1847, when war with Mexico was nearly over. In 1853 he resigned his commission, and from 1853 to 1858 was engaged in the manufacture of firearms at Bristol, R.I. In 1856 he invented a breech-loading rifle. He was employed by the Illinois Central railroad until the Civil War broke out. Then he took command of a Rhode Island regiment of three months militia, on the summons of Governor Sprague, took part in the relief of the national capital, and commanded a brigade in the first battle of Bull Run. On the 6th of August 1861 he was commissioned brigadier-general of volunteers, and placed in charge of the expeditionary force which sailed in January 1862 under sealed orders for the North Carolina coast. The victories of Roanoke Island, Newbern and Fort Macon (February-April) were the chief incidents of a campaign which was favourably contrasted by the people with the work of the main army on the Atlantic coast. He was promoted major-general U.S.V. soon afterwards, and early in July, with his North Carolina troops (IX. army corps), he was transferred to the Virginian theatre of war. Part of his forces fought in the last battles of Pope's campaign in Virginia, and Burnside himself was engaged in the battles of South Mountain and Antietam. At the latter he was in command of McClellan's left wing, but the want of vigour in his attack was unfavourably criticized. His patriotic spirit, modesty and amiable manners, made him highly popular, and upon McClellan's final removal (Nov. 7) from the Army of the Potomac, President Lincoln chose him as successor. The choice was unfortunate. Much as he was liked, no one had ever looked upon him as the equal of McClellan, and it was only with the greatest reluctance that he himself accepted the responsibility, which he had on two previous occasions declined. He sustained a crushing defeat at the battle of Fredericksburg (13 Dec. 1862), and (Jan. 27) gave way to Gen. Hooker, after a tenure of less than three months. Transferred to Cincinnati in March 1863, he caused the arrest and court-martial of Clement L. Vallandigham, lately an opposition member of Congress, for an alleged disloyal speech, and later in the year his measures for the suppression of press criticism aroused much opposition; he helped to crush Morgan's Ohio raid in July; then, moving to relieve the loyalists in East Tennessee, in September entered Knoxville, to which the Confederate general James Longstreet unsuccessfully laid siege. In 1864 Burnside led his old IX. corps under Grant in the Wilderness and Petersburg campaigns. After bearing his part well in the many bloody battles of that time, he was overtaken once more by disaster. The failure of the "Burnside mine" at Petersburg brought about his resignation. A year later he left the service, and in 1866 he became governor of Rhode Island, serving for three terms (1866-1869). From 1875 till his death he was a Republican member

of the United States Congress. He was present with the German headquarters at the siege of Paris in 1870-71. He died at Bristol, Rhode Island, on the 13th of September 1881.

See B. P. Poore, *Life and Public Services of Ambrose E. Burnside* (Providence, 1882); A. Woodbury, *Major-General Burnside and the Ninth Army Corps* (Providence, 1867).

BURNTISLAND, a royal, municipal and police burgh of Fife, Scotland, on the shore of the Firth of Forth, 5½ m. S.W. of Kirkcaldy by the North British railway. Pop. (1891) 4993; (1901) 4846. It is protected from the north wind by the Binn (632 ft.), and in consequence of its excellent situation, its links and sandy beach, it enjoys considerable repute as a summer resort. The chief industries are distilling, fisheries, ship-building and shipping, especially the export of coal and iron. Until the opening of the Forth bridge, its commodious harbour was the northern station of the ferry across the firth from Granton, 5 m. south. The parish church, dating from 1594, is a plain structure, with a squat tower rising in two tiers from the centre of the roof. The public buildings include two hospitals, a town-hall, music hall, library and reading room and science institute. On the rocks forming the western end of the harbour stands Rossend Castle, where the amorous French poet Chastelard repeated the insult to Queen Mary which led to his execution. In 1667 it was ineffectually bombarded by the Dutch. The burgh was originally called Parva Kinghorn and later Wester Kinghorn. The origin and meaning of the present name of the town have always been a matter of conjecture. There seems reason to believe that it refers to the time when the site, or a portion of it, formed an island, as sea-sand is the subsoil even of the oldest quarters. Another derivation is from Gaelic words meaning "the island beyond the bend." With Dysart, Kinghorn and Kirkcaldy, it unites in returning one member to parliament.

BURR, AARON (1756-1836), American political leader, was born at Newark, New Jersey, on the 6th of February 1756. His father, the Rev. Aaron Burr (1715-1757), was the second president (1748-1757) of the College of New Jersey, now Princeton University; his mother was the daughter of Jonathan Edwards, the well-known Calvinist theologian. The son graduated from the College of New Jersey in 1772, and two years later began the study of law in the celebrated law school conducted by his brother-in-law, Tappan Reeve, at Litchfield, Connecticut. Soon after the outbreak of the War of Independence, in 1775, he joined Washington's army in Cambridge, Mass. He accompanied Arnold's expedition into Canada in 1775, and on arriving before Quebec he disguised himself as a Catholic priest and made a dangerous journey of 120 m. through the British lines to notify Montgomery, at Montreal, of Arnold's arrival. He served for a time on the staffs of Washington and Putnam in 1776-77, and by his vigilance in the retreat from Long Island he saved an entire brigade from capture. On becoming lieutenant-colonel in July 1777, he assumed the command of a regiment, and during the winter at Valley Forge guarded the "Gulf," a pass commanding the approach to the camp, and necessarily the first point that would be attacked. In the engagement at Monmouth, on the 28th of June 1778, he commanded one of the brigades in Lord Stirling's division. In January 1779 Burr was assigned to the command of the "lines" of Westchester county, a region between the British post at Kingsbridge and that of the Americans about 15 m. to the north. In this district there was much turbulence and plundering by the lawless elements of both Whigs and Tories and by bands of ill-disciplined soldiers from both armies. Burr established a thorough patrol system, rigorously enforced martial law, and quickly restored order.

He resigned from the army in March 1779, on account of ill-health, renewed the study of law, was admitted to the bar at Albany in 1782, and began to practise in New York city after its evacuation by the British in the following year. In 1782 he married Theodosia Prevost (d. 1794), the widow of a British army officer who had died in the West Indies during the War of Independence. They had one child, a daughter, Theodosia, born in 1783, who became widely known for her beauty and accomplishments, married Joseph Alston of South Carolina

in 1801, and was lost at sea in 1813. Burr was a member of the state assembly (1784-1785), attorney-general of the state (1789-1791), United States senator (1791-1797), and again a member of the assembly (1798-1799 and 1800-1801). As national parties became clearly defined, he associated himself with the Democratic-Republicans. Although he was not the founder of Tammany Hall, he began the construction of the political machine upon which the power of that organization is based. In the election of 1800 he was placed on the Democratic-Republican presidential ticket with Thomas Jefferson, and each received the same number of electoral votes. It was well understood that the party intended that Jefferson should be president and Burr vice-president, but owing to a defect (later remedied) in the Constitution the responsibility for the final choice was thrown upon the House of Representatives. The attempts of a powerful faction among the Federalists to secure the election of Burr failed, partly because of the opposition of Alexander Hamilton and partly, it would seem, because Burr himself would make no efforts to obtain votes in his own favour. On Jefferson's election, Burr of course became vice-president. His fair and judicial manner as president of the Senate, recognized even by his bitterest enemies, helped to foster traditions in regard to that position quite different from those which have become associated with the speakership of the House of Representatives.

Hamilton had opposed Burr's aspirations for the vice-presidency in 1792, and had exerted influence through Washington to prevent his appointment as brigadier-general in 1798, at the time of the threatened war between the United States and France. It was also in a measure his efforts which led to Burr's lack of success in the New York gubernatorial campaign of 1804; moreover the two had long been rivals at the bar. Smarting under defeat and angered by Hamilton's criticisms, Burr sent the challenge which resulted in the famous duel at Weehawken, N.J., on the 11th of July 1804, and the death of Hamilton (*q.v.*) on the following day. After the expiration of his term as vice-president (March 4, 1805), broken in fortune and virtually an exile from New York, where, as in New Jersey, he had been indicted for murder after the duel with Hamilton, Burr visited the South-west and became involved in the so-called conspiracy which has so puzzled the students of that period. The traditional view that he planned a separation of the West from the Union is now discredited. Apart from the question of political morality he could not, as a shrewd politician, have failed to see that the people of that section were too loyal to sanction such a scheme. The objects of his treasonable correspondence with Merry and Yrujo, the British and Spanish ministers at Washington, were, it would seem, to secure money and to conceal his real designs, which were probably to overthrow Spanish power in the South-west, and perhaps to found an imperial dynasty in Mexico. He was arrested in 1807 on the charge of treason, was brought to trial before the United States circuit court at Richmond, Virginia, Chief-Justice Marshall presiding, and he was acquitted, in spite of the fact that the political influence of the national administration was thrown against him. Immediately afterward he was tried on a charge of misdemeanour, and on a technicality was again acquitted. He lived abroad from 1808 to 1812, passing most of his time in England, Scotland, Denmark, Sweden and France; trying to secure aid in the prosecution of his filibustering schemes but meeting with numerous rebuffs, being ordered out of England and Napoleon refusing to receive him. In 1812 he returned to New York and spent the remainder of his life in the practice of law. Burr was unscrupulous, insincere and notoriously immoral, but he was pleasing in his manners, generous to a fault, and was intensely devoted to his wife and daughter. In 1833 he married Eliza B. Jumel (1769-1865), a rich New York widow; the two soon separated, however, owing to Burr's having lost much of her fortune in speculation. He died at Port Richmond, Staten Island, New York, on the 14th of September 1836.

The standard biography is James Parton's *The Life and Times of Aaron Burr* (first edition, 1857; enlarged edition, 2 vols., Boston

and New York, 1898). W. F. McCaleb's *The Aaron Burr Conspiracy* (New York, 1903) is a scholarly defence of the West and incidentally of Burr against the charge of treason, and is the best account of the subject; see also I. Jenkinson, *Aaron Burr* (Richmond, Ind., 1902). For the traditional view of Burr's conspiracy, see Henry Adams's *History of the United States*, vol. iii. (New York, 1899).

BURRIANA, a seaport of eastern Spain, in the province of Castellón de la Plana; on the estuary of the river Sèco, which flows into the Mediterranean Sea. Pop. (1900) 12,962. The harbour of Burriana on the open sea is annually visited by about three hundred small coasting-vessels. Its exports consist chiefly of oranges grown in the surrounding fertile plain, which is irrigated with water from the river Mijares, on the north, and also produces large quantities of grain, oil, wine and melons. Burriana is connected by a light railway with the neighbouring towns of Onda (6595), Almazora (7076), Villarreal (16,068) and Castellón de la Plana (29,904). Its nearest station on the Barcelona-Valencia coast railway is Villarreal.

BURRITT, ELIHU (1810-1879), American philanthropist, known as "the learned blacksmith," was born in New Britain, Conn., on the 8th of December 1810. His father (a farmer and shoemaker), and his grandfather, both of the same name, had served in the Revolutionary army. An elder brother, Elijah, who afterwards published *The Geography of the Heavens* and other text-books, went out into the world while Elihu was still a boy, and after editing a paper in Georgia came back to New Britain and started a school. Elihu, however, had to pick up what knowledge he could get from books at home, where his father's long illness, ending in death, made his services necessary. At sixteen he was apprenticed to a blacksmith, and he made this his trade both there and at Worcester, Mass., where he removed in 1837. He had a passion for reading; from the village library he borrowed book after book, which he studied at his forge or in his spare hours; and he managed to find time for attending his brother's school for a while, and even for pursuing his search for culture among the advantages to be found at New Haven. He mastered Latin, Greek, French, Spanish, Italian and German, and by the age of thirty could read nearly fifty languages. His extraordinary aptitude gradually made him famous. He took to lecturing, and then to an ardent crusade on behalf of universal peace and human brotherhood, which made him travel persistently to various parts of the United States and Europe. In 1848 he organized the Brussels congress of Friends of Peace, which was followed by annual congresses in Paris, Frankfurt, London, Manchester and Edinburgh. He wrote and published voluminously, leaflets, pamphlets and volumes, and started the *Christian Citizen* at Worcester to advocate his humanitarian views. Cheap trans-oceanic postage was an ideal for which he agitated wherever he went. His vigorous philanthropy keeps the name of Elihu Burritt green in the history of the peace movement, apart from the fame of his learning. His countrymen, at universities such as Yale and elsewhere, delighted to do him honour; and he was U.S. consul at Birmingham from 1865 to 1870. He returned to America and died at New Britain on the 9th of March 1879.

See *Life*, by Charles Northend, in the memorial volume (1879); and an article by Ellen Strong Bartlett in the *New England Magazine* (June, 1897).

BURROUGHS, GEORGE (c. 1650-1692), American congregational pastor, graduated at Harvard in 1670, and became the minister of Salem Village (now Danvers) in 1680, a charge which he held till 1683. He lived at Falmouth (now Portland, Maine) until the Indians destroyed it in 1690, when he removed to Wells. In May 1692 during the witchcraft delusion, on the accusation of some personal enemies in his former congregation who had sued him for debt, Burroughs was arrested and charged, among other offences, with "extraordinary Lifting and such feats of strength as could not be done without Diabolical Assistance." Though the jury found no witch-marks on his body he was convicted and executed on Gallows Hill, Salem, on the 19th of August, the only minister who suffered this extreme fate.

BURROUGHS, JOHN (1837—), American poet and writer of natural history, was born in Roxbury, Delaware county, New York on the 3rd of April 1837. In his earlier years he engaged in various pursuits, teaching, journalism, farming and fruit-growing, and for nine years was a clerk in the treasury department at Washington. After publishing in 1867 a volume of *Notes on the Hermit as poet and person* (a subject to which he returned 5 years later in his *Whilman: a Study*), he began in 1871, with *Robin*, a series of books on birds, flowers and rural scenes which has made him the successor of Thoreau as a popular writer on the plants and animals environing human life. His writings showed a more philosophic mood and a greater interest towards literary or meditative allusion than their predecessors, but the general theme and method remained the same. His chief books, in addition to *Wake-Robin, are Birds and Poets* (1877), *Locusts and Wild Honey* (1879), *Signs and Symbols* (1886), and *Ways of Nature* (1905); these are in prose, and he wrote much also in verse, a volume of poems, *Bird Songs*, being published in 1906. *Winter Sunshine* (1875) and *Wet Fields* (1884) are sketches of travel in England and France.

A biographical sketch of Burroughs is prefixed to his *Year in the Woods* (New ed., 1901). A complete uniform edition of his works was issued in 1895, &c. (Riverside edition, Cambridge, Mass.).

RSAR (Med. Lat. *bursarius*), literally a keeper of the *bursa* or purse. The word is now chiefly used of the official, usually a fellow, who administers the finances of a college at university, or of the treasurer of a school or other institution. The term is also applied to the holder of "a bursary," an exhibition at Scottish schools or universities, and also in England a scholarship or exhibition enabling a pupil of an elementary school to continue his education at a secondary school. The term *bursa* (Lat. *bursa*, Gr. *βύρα*, bag of skin) is particularly used of the embroidered purse which is one of the insignia of office of the lord high chancellor of England, and of the pouch which in the Roman Church contains the "corporal" in the service of Mass. The "bursa" is a square case opening at one side and covered and lined with silk or linen; one side shows off the colour of the vestments of the day.

BURSCHENSCHAFT, an association of students at the German universities. It was formed as a result of the German national sentiment awakened by the War of Liberation, its object being to foster patriotism and Christian conduct, as opposed to the secularism and low moral standard of the old *Landmannschaften*. It originated at Jena, under the patronage of the grand-duke of Saxe-Weimar, and rapidly spread, the *Allgemeine Deutsche Burschenschaft* being established in 1818. The loud and idealistic of the *Burschen* excited the fears of the reactionary powers, which culminated after the murder of Kotzebue in 1819 by Karl Sand in 1819, a crime inspired by a secret society among the *Burschen* known as the Blacks (*Schwarzen*). The repressive policy embodied in the Carlsbad Decrees (1819) was therefore directed mainly against the *Burschenschaft*, which none the less survived to take part in the revolutions of 1830. After the *Amende* at Frankfurt in 1833, the association was again repressed, but it lived on until, in 1848, all laws against it were abrogated. The *Burschenschaften* are now purely social and non-political societies. The *Reformburschenschaften*, formed since 1883 on the principle of excluding duelling, are united in the *Allgemeiner deutscher Burschenbund*.

BURSIAN, CONRAD (1830—1883), German philologist and archaeologist, was born at Mutzschen in Saxony, on the 14th of November 1830. On the removal of his parents to Leipzig, he received his early education at the Thomas school, and entered the university in 1847. Here he studied under Moritz Hauptmann and Otto Jahn until 1851, spent six months in Berlin (chiefly attending Böckh's lectures), and completed his university studies at Leipzig (1852). The next three years were devoted to travelling in Belgium, France, Italy and Greece. In 1856 he became *Privat-docent*, and in 1858 extraordinary professor at Leipzig; in 1861 professor of philology and archaeology at Tübingen; in 1864 professor of classical antiquities at Zürich; in 1869 at

Jena, where he was also director of the archaeological museum, in 1874 at Munich, where he remained until his death on the 21st of September 1883. His most important works are: *Geographie von Griechenland* (1862—1872); *Beiträge zur Geschichte der klassischen Studien im Mittelalter* (1873); *Geschichte der klassischen Philologie in Deutschland* (1883); editions of Julius Firmicus Maternus' *De Erroribus Profanarum Religionum* (1856) and of Seneca's *Suasoriae* (1857). The article on Greek Art in Ersch and Gruber's *Encyclopaedia* is by him. Probably the work in connexion with which he is best known is the *Jahresbericht über die Fortschritte der klassischen Altertumswissenschaft* (1873, &c.), of which he was the founder and editor; from 1879 a *Biographisches Jahrbuch für Altertumskunde* was published by way of supplement, an obituary notice of Bursian, with a complete list of his writings, being in the volume for 1884.

BURSLUM, a market town of Staffordshire, England, in the Potteries district, 150 m. N.W. from London, on the North Staffordshire railway and the Grand Trunk Canal. Pop. (1891) 31,999; (1901) 38,766. In the 17th century the town was already famous for its manufacture of pottery. Here Josiah Wedgwood was born in 1730, his family having practised the manufacture in this locality for several generations, while he himself began work independently at the Ivy House pottery in 1759. He is commemorated by the Wedgwood Institute, founded in 1863. It comprises a school of art, free library, museum, picture-gallery and the free school founded in 1704. The exterior is richly and peculiarly ornamented, to show the progress of fictile art. The neighbouring towns of Stoke, Hanley and Longton are connected with Burslem by tramways. Burslem is mentioned in Domesday. Previously to 1885 it formed part of the parliamentary borough of Stoke, but it is now included in that of Hanley. It was included in the municipal borough of Stoke-on-Trent under an act of 1908.

BURTON, SIR FREDERICK WILLIAM (1816—1900), British painter and art connoisseur, the third son of Samuel Burton of Mungret, Co. Limerick, was born in Ireland in 1816. He was educated in Dublin, where his artistic studies were carried on with marked success under the direction of Mr Brocas, an able teacher, who foretold for the lad a distinguished career. That this estimate was not exaggerated was proved by Burton's immediate success in his profession. He was elected an associate of the Royal Hibernian Academy at the age of twenty-one and an academician two years later; and in 1842 he began to exhibit at the Royal Academy. A visit to Germany and Bavaria in 1851 was the first of a long series of wanderings in various parts of Europe, which gave him a profound and intimate knowledge of the works of the Old Masters, and prepared him admirably for the duties that he undertook in 1874 when he was appointed director of the British National Gallery in succession to Sir W. Boxall, R.A. During the twenty years that he held this post he was responsible for many important purchases, among them Leonardo da Vinci's "Virgin of the Rocks," Raphael's "Ansidei Madonna," Holbein's "Ambassadors," Van Dyck's equestrian portrait of Charles I., and the "Admiral Pulido Pareja," by Velasquez; and he added largely to the noted series of Early Italian pictures in the gallery. The number of acquisitions made to the collection during his period of office amounts to not fewer than 500. His own painting, most of which was in water-colour, had more attraction for experts than for the general public. He was elected an associate of the Royal Society of Painters in Water-Colours in 1855, and a full member in the following year. He resigned in 1870, and was re-elected as an honorary member in 1886. A knighthood was conferred on him in 1884, and the degree of LL.D. of Dublin in 1889. In his youth he had strong sympathy with the "Young Ireland Party," and was a close associate with some of its members. He died in Kensington on the 16th of March 1900.

BURTON, JOHN HILL (1809—1881), Scottish historical writer, the son of an officer in the army, was born at Aberdeen on the 22nd of August 1809. After studying at the university of his native city, he removed to Edinburgh, where he qualified for

the Scottish bar and practised as an advocate; but his progress was slow, and he eked out his narrow means by miscellaneous literary work. His *Manual of the Law of Scotland* (1839) brought him into notice; he joined Sir John Bowring in editing the works of Jeremy Bentham, and for a short time was editor of the *Scotsman*, which he committed to the cause of free trade. In 1846 he achieved high reputation by his *Life of David Hume*, based upon extensive and unused MS. material. In 1847 he wrote his biographies of Simon, Lord Lovat, and of Duncan Forbes, and in 1849 prepared for Chambers's Series manuals of political and social economy and of emigration. In the same year he lost his wife, whom he had married in 1844, and never again mixed freely with society, though in 1855 he married again. He devoted himself mainly to literature, contributing largely to the *Scotsman* and *Blackwood*, writing *Narratives from Criminal Trials in Scotland* (1852), *Treatise on the Law of Bankruptcy in Scotland* (1853), and publishing in the latter year the first volume of his *History of Scotland*, which was completed in 1870. A new and improved edition of the work appeared in 1873. Some of the more important of his contributions to *Blackwood* were embodied in two delightful volumes, *The Book Hunter* (1862) and *The Scot Abroad* (1864). He had in 1854 been appointed secretary to the prison board, an office which gave him entire pecuniary independence, and the duties of which he discharged most assiduously, notwithstanding his literary pursuits and the pressure of another important task assigned to him after the completion of his history, the editorship of the *National Scottish Registers*. Two volumes were published under his supervision. His last work, *The History of the Reign of Queen Anne* (1880), is very inferior to his *History of Scotland*. He died on the 10th of August 1881. Burton was pre-eminently a jurist and economist, and may be said to have been guided by accident into the path which led him to celebrity. It was his great good fortune to find abundant unused material for his *Life of Hume*, and to be the first to introduce the principles of historical research into the history of Scotland. All previous attempts had been far below the modern standard in these particulars, and Burton's history will always be memorable as marking an epoch. His chief defects as a historian are want of imagination and an undignified familiarity of style, which, however, at least preserves his history from the dulness by which lack of imagination is usually accompanied. His dryness is associated with a fund of dry humour exceedingly effective in its proper place, as in *The Book Hunter*. As a man he was loyal, affectionate, philanthropic and entirely estimable.

A memoir of Hill Burton by his wife was prefaced to an edition of *The Book Hunter*, which like his other works was published at Edinburgh (1882). (R. G.)

BURTON, SIR RICHARD FRANCIS (1821-1890), British consul, explorer and Orientalist, was born at Barham House, Hertfordshire, on the 19th of March 1821. He came of the Westmorland Burtons of Shap, but his grandfather, the Rev. Edward Burton, settled in Ireland as rector of Tuam, and his father, Lieutenant-Colonel Joseph Netterville Burton, of the 36th Regiment, was an Irishman by birth and character. His mother was descended from the MacGregors, and he was proud of a remote drop of Bourbon blood piously believed to be derived from amorganatic union of the Grand Monarque. There were even those, including some of the Romany themselves, who saw gipsy written in his peculiar eyes as in his character, wild and resentful, essentially vagabond, intolerant of convention and restraint. His irregular education strengthened the inherited bias. A childhood spent in France and Italy, under scarcely any control, fostered the love of untrammelled wandering and a marvellous fluency in continental vernaculars. Such an education so little prepared him for academic proprieties, that when he entered Trinity College, Oxford, in October 1840, a criticism of his military moustache by a fellow-undergraduate was resented by a challenge to a duel, and Burton in various ways distinguished himself by such eccentric behaviour that rustication inevitably ensued. Nor was he much more in his element as a subaltern in the 18th Regiment of Bombay Native Infantry, which he

joined at Baroda in October 1842. Discipline of any sort he abhorred, and the one recommendation of the East India Company's service in his eyes was that it offered opportunities for studying Oriental life and languages. He had begun Arabic without a master at Oxford, and worked in London at Hindustani under Forbes before he went out; in India he laboured indefatigably at the vernaculars, and his reward was an astonishingly rapid proficiency in Gujarati, Marathi, Hindustani, as well as Persian and Arabic. His appointment as an assistant in the Sind survey enabled him to mix with the people, and he frequently passed as a native in the bazaars and deceived his own *swusshi*, to say nothing of his colonel and messmates. His wanderings in Sind were the apprenticeship for the pilgrimage to Mecca, and his seven years in India laid the foundations of his unparalleled familiarity with Eastern life and customs, especially among the lower classes. Besides government reports and contributions to the Asiatic Society, his Indian period produced four books, published after his return home: *Scinde, or the Unhappy Valley* (1851), *Sindh and the Races that Inhabit the Valley of the Indus* (1851), *Goo and the Blue Mountains* (1851), and *Falconry in the Valley of the Indus* (1853). None of these achieved popularity, but the account of Sind is remarkably vivid and faithful.

The pilgrimage to Mecca in 1853 made Burton famous. He had planned it whilst mixing disguised among the Muslims of Sind, and had laboriously prepared for the ordeal by study and practice. No doubt the primary motive was the love of adventure, which was his strongest passion; but along with the wanderer's restlessness marched the zest of exploration, and whilst wandering was in any case a necessity of his existence, he preferred to roam in untrodden ways where mere adventure might be dignified by geographical service. There was a "huge white blot" on the maps of central Arabia where no European had ever been, and Burton's scheme, approved by the Royal Geographical Society, was to extend his pilgrimage to this "empty abode," and remove a discreditable blank from the map. War among the tribes curtailed the design, and his journey went no farther than Medina and Mecca. The exploit of accompanying the Muslim hajj to the holy cities was not unique, nor so dangerous as has been imagined. Several Europeans have accomplished it before and since Burton's visit without serious mishap. Passing himself off as an Indian Pathan covered any peculiarities or defects of speech. The pilgrimage, however, demands an intimate proficiency in a complicated ritual, and a familiarity with the minutiae of Eastern manners and etiquette; and in the case of a stumbling, presence of mind and cool courage may be called into request. There are legends that Burton had to defend his life by taking others'; but he carried no arms, and confessed, rather shamefacedly, that he had never killed anybody at any time. The actual journey was less remarkable than the book in which it was recorded, *The Pilgrimage to Al-Medina and Meccah* (1855). Its vivid descriptions, pungent style, and intensely personal "note" distinguish it from books of its class; its insight into Semitic modes of thought and its picture of Arab manners give it the value of an historical document; its grim humour, keen observation and reckless insobriety of opinion, expressed in peculiar, uncouth but vigorous language make it a curiosity of literature.

Burton's next journey was more hazardous than the pilgrimage, but created no parallel sensation. In 1854 the Indian government accepted his proposal to explore the interior of the Somali country, which formed a subject of official anxiety in its relation to the Red Sea trade. He was assisted by Capt. J. H. Speke and two other young officers, but accomplished the most difficult part of the enterprise alone. This was the journey to Harrar, the Somali capital, which no white man had entered. Burton vanished into the desert, and was not heard of for four months. When he reappeared he had not only been to Harrar, but had talked with the king, stayed ten days there in deadly peril, and ridden back across the desert, almost without food and water, running the gauntlet of the Somali spears all the way. Undeterred by this experience he set out again, but was checked

Irish with the tribes, in which one of his young officers led, Captain Speke was wounded in eleven places, and himself had a javelin thrust through his jaws. His *First Expedition in East Africa* (1856), describing these adventures, is his most exciting and most characteristic books, full of colour, observation and humour.

After serving on the staff of Beatson's Bashi-bazouks at the Crimea, but never getting to the front in the Crimea, Burton returned to Africa in 1856. The foreign office, moved by the Geographical Society, commissioned him to search for sources of the Nile, and, again accompanied by Speke, he explored the lake regions of equatorial Africa. They discovered Tanganyika in February 1858, and Speke, pushing on to the north, discovered the source of the Nile. Burton's illness and acting on indications supplied by Speke led to the separate discovery of Lake Victoria Nyanza. The separate discovery led to a bitter dispute, but Burton's expedition, with its discovery of two lakes, was the incentive to the later explorations of Speke and Grant, Baker, Livingstone and Stanley; and his name is in volume xxxiii. of the *Proceedings of the Royal Geographical Society*, and his *Lake Regions of Equatorial Africa* (1860), are true parents of the multitudinous literature of "darkest Africa." Burton was the first Englishman to enter Mecca, the first to explore Somaliland, the first to discover the great lakes of central Africa. His East African pioneering coincides with which have since become peculiarly interesting to the British Empire; and three years later he was exploring on the west side of Africa, at Dahomey, Benin and the Gold Coast, which is now also entered among the imperial "questions" of the day. Before middle age Burton had compressed into his life, as Lord Derby said, "more of study, more of hardship, and more of successful enterprise and adventure, than would have been needed to fill up the existence of half a dozen ordinary men." The *City of the Saints* (1861) was the fruit of a flying visit to the United States in 1860.

In 1849 his connexion with the Indian army had been finally severed; in 1861 he definitely entered the service of the foreign office as consul at Fernando Po, whence he was sent successively to Santos in Brazil (1865), Damascus (1869), Trieste (1871), holding the last post till his death on the 20th October 1890. Each of these posts produced its corresponding work: Fernando Po led to the publishing of *Wanderings in Africa* (1863), *Abeokuta and the Cameroons* (1863), *A Mission to the King of Dahomé* (1864), and *Wisdom from West Africa* (1865). The *Highlands of the Brazil* (1866) was the result of his years' residence and travelling; and *Letters from the Fields of Paraguay* (1870) relate to a journey across South America to Peru. Damascus suggested *Unexplored Syria* (1872), which might have led to much better work, since no consulate in the Eastern Hemisphere was more congenial to Burton's taste and artistic studies; but he mismanaged his opportunities, got into trouble with the foreign office, and was removed to Trieste, where his Oriental prepossessions and prejudices could do no harm, but where, unfortunately, his Oriental learning was thrown away. He did not, however, abandon his Eastern studies or his Eastern travels. Various fresh journeys or revisitations of familiar places are recorded in his later books, such as *Zanzibar* (1872), *Ima Thule* (1875), *Etruscan Bologna* (1876), *Siind Revisited* (1877), *The Land of Midian* (1879) and *To the Gold Coast for Gold* (1883). None of these had more than a passing interest. Burton lost the charm of style or imagination which gives immortality to a book of travel. He wrote too fast, and took too little pains at the form. His blunt, disconnected sentences and ill-structured chapters were full of information and learning, and contained not a few thrusts for the benefit of government or other people, but they were not "readable." There was something ponderous about his very humour, and his criticism was personal and savage. By far the most celebrated of all his books is his translation of the "Arabian Nights" (*The Thousand Nights and a Night*, 16 vols., privately printed, 1885-1888), which occupied the greater part of his leisure at Trieste. As a monument of his Arabic learning and his encyclopaedic knowledge of the East, this translation was his greatest achievement. It

is open to criticism in many ways; it is not so exact in scholarship, nor so faithful to its avowed text, as might be expected from his reputation; but it reveals a profound acquaintance with the vocabulary and customs of the Muslims, with their classical idiom as well as their vulgarest "Billingsgate," with their philosophy and modes of thought as well as their most secret and most disgusting habits. Burton's "anthropological notes," embracing a wide field of pornography, apart from questions of taste, abound in valuable observations based upon long study of the manners and the writings of the Arabs. The translation itself is often marked by extraordinary resource and felicity in the exact reproduction of the sense of the original; Burton's vocabulary was marvellously extensive, and he had a genius for hitting upon the right word; but his fancy for archaic words and phrases, his habit of coining words, and the harsh and rugged style he affected, detract from the literary quality of the work without in any degree enhancing its fidelity. With grave defects, but sometimes brilliant merits, the translation holds a mirror to its author. He was, as has been well said, an Elizabethan born out of time; in the days of Drake his very faults might have counted to his credit. Of his other works, *Vikram and the Vampire*, *Hindu Tales* (1870), and a history of his favourite arm, *The Book of the Sword*, vol. i. (1884), unfinished, may be mentioned. His translation of *The Lusjads of Camoens* (1880) was followed (1881) by a sketch of the poet's life. Burton had a fellow-feeling for the poet adventurer, and his translation is an extraordinarily happy reproduction of its original. A manuscript translation of the "Scented Garden," from the Arabic, was burnt by his widow, acting in what she believed to be the interests of her husband's reputation. Burton married Isabel Arundell in 1861, and owed much to her courage, sympathy and passionate devotion. Her romantic and exaggerated biography of her husband, with all its faults, is one of the most pathetic monuments which the unselfish love of a woman has ever raised to the memory of her hero. Another monument is the Arab tent of stone and marble which she built for his tomb at Mortlake.

Besides Lady Burton's *Life of Sir Richard F. Burton* (2 vols., 1893, 2nd edition, condensed, edited, with a preface, by W. H. Wilkins, 1898), there are *A Sketch of the Career of R. F. Burton*, by A. B. Richards, Andrew Wilson, and St Clair Baddeley (1886); *The True Life of Captain Sir Richard F. Burton*, by his niece, G. M. Stisted (1896); and a brief sketch by the present writer prefixed to Bohn's edition of the *Pilgrimage to Al-Medinah and Meccah* (1898), from which some sentences have here been by permission reproduced. In 1906 appeared the *Life of Sir Richard Burton*, by Thomas Wright of Olney, in two volumes, an industrious and rather critical work, interesting in particular for the doubts it casts on Burton's originality as an Arabic translator, and emphasizing his indebtedness to Payne's translation (1881) of the *Arabian Nights*. (S. L.-P.)

BURTON, ROBERT (1577-1640), English writer, author of *The Anatomy of Melancholy*, son of a country gentleman, Ralph Burton, was born at Lindley in Leicestershire on the 8th of February 1576-7. He was educated at the free school of Sutton Coldfield and at Nuneaton grammar school; became in 1593 a commoner of Brasenose College, and in 1599 was elected student at Christ Church, where he continued to reside for the rest of his life. The dean and chapter of Christ Church appointed him, in November 1616, vicar of St Thomas in the west suburbs, and about 1630 his patron, Lord Berkeley, presented him to the rectory of Segrave in Leicestershire. He held the two livings "with much ado to his dying day" (says Antony à Wood, the Oxford historian, somewhat mysteriously); and he was buried in the north aisle of Christ Church cathedral, where his elder brother William Burton, author of a *History of Leicestershire*, raised to his memory a monument, with his bust in colour. The epitaph that he had written for himself was carved beneath the bust: *Paucis notus, paucioribus ignotus, hic jacet Democritus Junior, cui vitam dedit et mortem Melancholia*. Some years before his death he had predicted, by the calculation of his nativity, that the approach of his climacteric year (sixty-three) would prove fatal; and the prediction came true, for he died on the 25th of January 1639-40 (some gossip surmising that he had "sent up his soul to heaven through a noose about his neck" to avoid the chagrin of seeing his calculations falsified). His

portrait in Brasenose College shows the face of a scholar, shrewd, contemplative, humorous.

A Latin comedy, *Philosophaster*, originally written by Robert Burton in 1606 and acted at Christ Church in 1617, was long supposed to be lost; but in 1862 it was printed for the Roxburgh Club from a manuscript belonging to the Rev. W. E. Buckley, who edited it with elaborate care and appended a collection of the academical exercises that Burton had contributed to various Oxford miscellanies ("Natalia," "Parentalia," &c.). *Philosophaster* is a vivacious exposure of charlatanism. Desiderius, duke of Osuna, invites learned men from all parts of Europe to repair to the university which he has re-established; and a crowd of shifty adventurers avail themselves of the invitation. There are points of resemblance to *Philosophaster* in Ben Jonson's *Alchemist* and Tomkiss's *Albumazar*, but in the prologue Burton is careful to state that his was the earlier play. (Another manuscript of *Philosophaster*, a presentation copy to William Burton from the author, has since been found in the library of Lord Mostyn.)

In 1621 was issued at Oxford the first edition, a quarto, of *The Anatomy of Melancholy . . . by Democritus Junior*. Later editions, in folio, were published in 1624, 1628, 1632, 1638, 1651, 1652, 1660, 1676. Burton was for ever engaged in revising his treatise. In the third edition (where first appeared the engraved emblematical title-page by C. Le Blond) he declared that he would make no further alterations. But the fourth edition again bore marks of revision; the fifth differed from the fourth; and the sixth edition was posthumously printed from a copy containing his latest corrections.

Not the least interesting part of the *Anatomy* is the long preface, "Democritus to the Reader," in which Burton sets out his reasons for writing the treatise and for assuming the name of Democritus Junior. He had been elected a student of "the most flourishing college of Europe" and he designed to show his gratitude by writing something that should be worthy of that noble society. He had read much; he was neither rich nor poor; living in studious seclusion, he had been a critically observant spectator of the world's affairs. The philosopher Democritus, who was by nature very melancholy, "averse from company in his latter days and much given to solitariness," spent his closing years in the suburbs of Abdera. There Hippocrates once found him studying in his garden, the subject of his study being the causes and cure of "this *atra bilis* or melancholy." Burton would not compare himself with so famous a philosopher, but he aimed at carrying out the design which Democritus had planned and Hippocrates had commended. It is stated that he actually set himself to reproduce the old philosopher's reputed eccentricities of conduct. When he was attacked by a fit of melancholy he would go to the bridge foot at Oxford and shake his sides with laughter to hear the bargemen swearing at one another, just as Democritus used to walk down to the haven at Abdera and pick matter for mirth out of the humours of waterside life.

Burton anticipates the objections of captious critics. He allows that he has "collected this cento out of divers authors" and has borrowed from innumerable books, but he claims that "the composition and method is ours only, and shows a scholar." It had been his original intention to write in Latin, but no publisher would take the risk of issuing in Latin so voluminous a treatise. He humorously apologizes for faults of style on the ground that he had to work single-handed (unlike Origen who was allowed by Ambrosius six or seven amanuenses) and digest his notes as best he might. If any object to his choice of subject, urging that he would be better employed in writing on divinity, his defence is that far too many commentaries, expositions, sermons, &c., are already in existence. Besides, divinity and medicine are closely allied; and, melancholy being both a spiritual and bodily infirmity, the divine and the physician must unite to cure it.

The preface is followed by a tabular synopsis of the First Partition with its several Sections, Members and Subsections. After various preliminary digressions Burton sets himself to

define what Melancholy is and what are its species and kinds. Then he discusses the Causes, supernatural and natural, of the disorder, and afterwards proceeds to set down the Symptoms (which cannot be briefly summarized, "for the Tower of Babel never yielded such confusion of tongues as the Chaos of Melancholy doth of Symptoms"). The Second Partition is devoted to the Cure of Melancholy. As it is of great importance that we should live in good air, a chapter deals with "Air Rectified. With a Digression of the Air." Burton never travelled, but the study of cosmography had been his constant delight; and over sea and land, north, east, west, south—in this enchanting chapter—he sends his vagrant fancy flying. In the disquisition on "Exercise rectified of body and mind" he dwells gleefully on the pleasures of country life, and on the content that scholars find in the pursuit of their favourite studies. Love-Melancholy is the subject of the first Three Sections of the Third Partition, and many are the merry tales with which these pages are seasoned. The Fourth (and concluding) Section treats, in graver mood, of Religious Melancholy; and to the "Cure of Despair" he devotes his deepest meditations.

The Anatomy, widely read in the 17th century, for a time lapsed into obscurity, though even "the wits of Queen Anne's reign and the beginning of George I. were not a little beholden to Robert Burton" (Archbishop Herring). Dr Johnson deeply admired the work; and Sterne laid it heavily under contribution. But the noble and impassioned devotion of Charles Lamb has been the most powerful help towards keeping alive the memory of the "fantastic great old man." Burton's odd turns and quirks of expression, his whimsical and affectate fancies, his kindly sarcasm, his far-fetched conceits, his deep-lying pathos, descended by inheritance of genius to Lamb. The enthusiasm of Burton's admirers will not be chilled by the disparagement of unsympathetic critics (Macaulay and Hallam among them) who have consulted his pages in vain; but through good and evil report he will remain, their well-loved companion to the end.

The best of the modern editions of Burton was published in 1896, 3 vols. 8vo (Bell and Sons), under the editorship of A. R. Shilleto, who identified a large number of the classical quotations and many passages from post-classical authors. Prof. Bensley, of the university of Adelaide, has since contributed to the ninth and tenth series of *Notes and Queries* many valuable notes on the *Anatomy*. Dr Aldis Wright has long been engaged on the preparation of a definitive edition. (A. H. B.)

BURTON, WILLIAM EVANS (1804-1860), English actor and playwright, born in London in September 1804, was the son of William George Burton (1774-1825), a printer and author of *Research into the religions of the Eastern nations as illustrative of the scriptures* (1805). He was educated for the Church, but, having entered his father's business, his success as an amateur actor led him to go upon the stage. After several years in the provinces, he made his first London appearance in 1831. In 1834 he went to America, where he appeared in Philadelphia as Dr Ollapod in *The Poor Gentleman*. He took a prominent place, both as actor and manager, in New York, Philadelphia and Baltimore, the theatre which he leased in New York being renamed Burton's theatre. He had much popular success as Captain Cuttle in John Brougham's dramatization of *Dombey and Son*, and in other low comedy parts in plays from Dickens's novels. Burton was the author of a large number of plays, one of which, *Ellen Wareham* (1833), was produced simultaneously at five London theatres. In Philadelphia he established the *Gentleman's Magazine*, of which Edgar Allan Poe was for some time the editor. He was himself the editor of the *Cambridge Quarterly* and the *Sowenir*, and the author of several books, including a *Cyclopaedia of Wit and Humour* (1857). He collected a library of over 100,000 volumes, especially rich in Shakespeareans, which was dispersed after his death at New York City on the 9th of February 1860.

BURTON-UPON-TRENT, a market town and municipal and county borough in the Burton parliamentary division of Staffordshire and the Southern parliamentary division of Derbyshire, England; lying mainly upon the left bank of the Trent, in Staffordshire. Pop. (1891) 46,047; (1901) 50,386. It is 127 m.

it from London by the London & North-Western and nd railways, and is also served by the Great Northern 1 Staffordshire railways. The Trent is navigable from ear the town downward. The neighbouring country t enough, particularly along the river, but the town uly industrial, and contains no pre-eminent build- : church of St Mary and St Modwen is classic in he 18th century, but embodies some remains of an othic building. Of a Benedictine abbey dedicated e saints there remain a gatehouse and lodge, and a ay. The former abbot's house at Seyney Park is ered building of the 15th century. The free grammar ounded in 1525. A fine bridge over the Trent, unicipal buildings, were provided by Lord Burton. pleasant recreation grounds on the Derbyshire side

the seat of an enormous brewing trade, representing nth of the total amount of this trade in the United It is divided between some twenty firms. The Bass's brewery extend over 500 acres, while Allsopp's upwards of 5000 hands are employed in all, and of railways owned by the firms cross the streets in s on the level, and connect with the lines of the panies. The superiority which is claimed for is attributed to the use of well-water impregnated e of lime derived from the gypseous deposits of the rton is governed by a mayor, 8 aldermen and 24 Area, 4202 acres.

n-Trent (Burton) is first mentioned towards the close tury, when St Modwen, an Irish virgin, is said to have onvent on the Isle of Andresse, opposite Burton. ic, earl of Mercia, founded here a Benedictine abbey, r of 1004 granted to it the town with other large enurton was evidently a mesne borough under the ld the court of the manor and received the profits according to the charter of Henry I. granting sac her privileges and right in the town. Later charters Henry II., by John in 1204 (who also granted an hree days' duration, 29th of October, at the feast of id a weekly market on Thursday), by Henry III. in 'VII. in 1248 (Henry VII. granted a fair at the feast h of October), and by Henry VIII. in 1509. At the ry VIII. founded on the site of the abbey a collegiate d before 1545, when its lands, with all the privileges l in the abbot, were conferred on Sir William Paget, marquess of Anglesey, now holder of the manor. In rporated under a mayor, 8 aldermen, 24 councillors. scene of several engagements in the Civil War, when in clothing and alabaster was practically ruined. hey ale was mentioned as early as 1295, the brewing rparatively of recent development, having begun rty years later it had a market at St Petersburg rts, and in 1796 there were nine brewing firms in the

Molyneux, *History of Burton-on-Trent* (1869); *History, Staffordshire*.

, Dutch *Boeroe* or *Boeloe*), an island of the ies, one of the Molucca Islands belonging to the oboyna, between 3° 4' and 3° 50' S. and 125° 58' Its extreme measurements are 87 m. by 50 m., 3400 sq. m. Its surface is for the most part ough the seaboard district is frequently alluvial n the deposits of the numerous rivers. Of these ajeli, discharging eastward, is in part navigable. vations occur in the west, where the mountain 8530 ft. In the middle of the western part of e large lake of Wakolo, at an altitude of 2200 ft., nce of 37 m. and a depth of about 100 ft. It red a crater lake; but this is not the case. It : junction of the sandstone and slate, where the orn away the former, has accumulated on the : has no affluents and only one outlet, the Wai . The chief geological formations of Buru are near the north coast, and more to the south ne and chalk, deposits of rare occurrence in the far the larger part of the country is covered t and prairie land, but such portions as have

been brought into cultivation are highly fertile. Coffee, rice and a variety of fruits, such as the lemon, orange, banana, pine-apple and coco-nut are readily grown, as well as sago, red-pepper, tobacco and cotton. The only important exports, however, are cajeput oil, a sudorific distilled from the leaves of the *Mala-lenca Cajuputi* or white-wood tree; and timber. The native flora is rich, and teak, ebony and canari trees are especially abundant; the fauna, which is similarly varied, includes the babirusa, which occurs in this island only of the Moluccas. The population is about 15,000. The villages on the sea-coast are inhabited by a Malayan population, and the northern and western portions of the island are occupied by a light-coloured Malay folk akin to the natives of the eastern Celebes. In the interior is found a peculiar race which is held by some to be Papuan. They are described, however, as singularly un-Papuan in physique, being only 5 ft. 2 in. in average height, of a yellow-brown colour, of feeble build, and without the characteristic frizzly hair and prominent nose of the true Papuan. They are completely pagan, live in scattered hamlets, and have come very little in contact with any civilization. Among the maritime population a small number of Chinese, Arabs and other races are also found. The island is divided by the Dutch into two districts. The chief settlement is Kajeli on the east coast. A number of Mahomedan natives here are descended from tribes compelled in 1657 to gather together from the different parts of the island, while all the clove-trees were exterminated in an attempt by the Dutch to centralize the clove trade. Before the arrival of the Dutch the islanders were under the dominion of the sultan of Ternate; and it was their rebellion against him that gave the Europeans the opportunity of effecting their subjugation.

BURUJIRD, a province of Persia, bounded W. by Luristan, N. by Nehavend and Malayir, E. by Irak and S. by Isfahan. It is divided into the following administrative divisions:—(1) town of Burujird with villages in immediate neighbourhood; (2) Silakhor (upper and lower); (3) Japalak (with Sarlek and Burbarud); (4) pomad Bakhtiari. It has a population of about 250,000 or 300,000, and pays a yearly revenue of about £16,000. It is very fertile and produces much wheat, barley, rice and opium. With improved means of transport, which would allow the growers to export, the produce of cereals could easily be trebled. The province is sometimes joined with that of Luristan.

The town Burujird, the capital of the province, is situated in the fertile Silakhor plain on the river Tahji, a tributary of the Dizful river (Ab I Diz), 70 m. by road from Hamadan and 212 m. from Isfahan, in 33° 55' N. and 48° 55' E., and at an elevation of 5315 ft. Pop. about 25,000. It manufactures various cotton stuffs (coarse prints, carpet covers) and felts (principally hats and caps for Lurs and Bakhtiari). It has post and telegraph offices.

BURY, JOHN BAGNELL (1861–), British historian, was born on the 16th of October 1861, and was educated at Trinity College, Dublin, where he was elected to a fellowship in 1885. A fine Greek scholar, he edited Pindar's *Nemean* and *Isthmian Odes*; but he devoted himself chiefly to the study of history, and was chosen professor of modern history at Dublin in 1893, becoming regius professor of Greek in 1898. He resigned both positions in 1902, when he was elected regius professor of modern history in the university of Cambridge. His historical work was mainly concerned with the later Roman empire, and his edition of Gibbon's *Decline and Fall*, with a masterly introduction and valuable notes (1896–1900), is the standard text of this history. He also wrote a *History of Greece to the Death of Alexander the Great* (1900); *History of the Later Roman Empire, 395–800* (1889); *History of the Roman Empire 27 B.C.–180 A.D.* (1893); *Life of St Patrick and his Place in History* (1905), &c. He was elected a fellow of King's College, Cambridge, and received honorary degrees from the universities of Oxford, Edinburgh, Glasgow, Aberdeen and Durham.

BURY, a market-town and municipal, county and parliamentary borough of Lancashire, England, on the river Irwell,

195 m. N.W. by W. from London, and 10½ N. by W. from Manchester, on the Lancashire & Yorkshire railway and the Manchester & Bolton canal. Pop. (1891) 57,212; (1901) 58,029. The church of St Mary is of early foundation, but was rebuilt in 1876. Besides numerous other places of worship, there are a handsome town hall, atheneum and museum, art gallery and public library, various assembly rooms, and several recreation grounds. Kay's free grammar school was founded in 1726; there are also municipal technical schools. The cotton manufacture is the principal industry; there are also calico printing, dyeing and bleaching works, machinery and iron works, woollen manufactures, and coal mines and quarries in the vicinity. Sir Robert Peel was born at Chamber Hall in the neighbourhood, and his father did much for the prosperity of the town by the establishment of extensive print-works. A monument to the statesman stands in the market-place. The parliamentary borough returns one member (since 1832). The county borough was created in 1888. The corporation consists of a mayor, 10 aldermen and 30 councillors. Area, 5,836 acres.

Bury, of which the name is derived from the Anglo-Saxon *burg*, *birig* or *byrig* (town, castle or fortified place), was the site of a Saxon station, and an old English castle stood in Castle Croft close to the town. It was a member of the Honour of Clitheroe and a fee of the royal manor of Tottington, which soon after the Conquest was held by the Lacys. The local family of Bury held lands here during the 13th century, and at least for a short time the manor itself, but before 1347 it passed by marriage to the Pilkingtons of Pilkington, with whom it remained till 1485, when on the attainder of Sir Thomas Pilkington it was granted to the first earl of Derby, whose descendants have since held it. Under a grant made by Edward IV. to Sir Thomas Pilkington, fairs are still held on March 5, May 3, and September 18, and a market was formerly held under the same grant on Thursday, which has, however, been long replaced by a customary market on Saturday. The woollen trade was established here through the agency of Flemish immigrants in Edward III.'s reign, and in Elizabeth's time this industry was of such importance that an alubeger was appointed to measure and stamp the woollen cloth. But although the woollen manufacture is still carried on, the cotton trade has been gradually superseding it since the early part of the 18th century. The family of the Kays, the inventors, belonged to this place, and Robert Peel's print-works were established here in 1770. The cognate trades of bleaching, dyeing and machine-making have been long carried on. A court-leet and view of frank pledge used to be held half-yearly at Easter and Michaelmas, and a court-baron in May. Until 1846 three constables were chosen annually at the court-leet to govern the place, but in that year the inhabitants obtained authority from parliament to appoint twenty-seven commissioners to undertake the local government. A charter of incorporation was granted in 1876. The well-known Bury Co-operative Society was established in 1856. There was a church here at the time of the Domesday Survey, and the earliest mention of a rector is found in the year 1331-1332. One-half of the town is glebe belonging to the rectory.

BURY ST EDMUNDS, a market town and municipal and parliamentary borough of Suffolk, England, on the Lark, an affluent of the Great Ouse; 87 m. N.E. by N. from London by the Great Eastern railway. Pop. (1901) 16,255. It is pleasantly situated on a gentle eminence, in a fertile and richly cultivated district. The tower or church-gate, one of the finest specimens of early Norman architecture in England, and the western gate, a beautiful structure of rich Decorated work, together with ruined walls of considerable extent, are all that remains of the great abbey. St Mary's church, with a beautifully carved roof, was erected in the earlier part of the 15th century, and contains the tomb of Mary Tudor, queen of Louis XII. of France. St James's church is also a fine Perpendicular building, with a modern chancel, and without a tower. All these splendid structures, fronting one of the main streets in succession, form, even without the abbey church, a remarkable memorial of the wealth of the foundation. Behind them lie picturesque gardens which

contain the ruins, the plan of which is difficult to trace though the outlines of some portions, as the chapter-house, have been made clear by excavation. There is a handsome Roman Catholic church of St Edmund. The so-called Moyses Hall (perhaps a Jew's House, of which there is a parallel example at Lincoln) retains transitional Norman work. The free grammar school, founded by Edward VI., has two scholarships at Cambridge, and six exhibitions to each university, and occupies modern buildings. The Church Schools Company has a school. There are large agricultural implement works, and the agricultural trade is important, cattle and corn markets being held. In the vicinity is Ickworth, the seat of the marquess of Bristol, a great mansion of the end of the 18th century. The parliamentary borough, which returns one member, is coextensive with the municipal borough. The town is governed by a mayor, 6 aldermen and 18 councillors. Area, 2,947 acres.

Bury St Edmunds (Beodricesworth, St Edmund's Bury), supposed by some to have been the Villa Faustina of the Romans, was one of the royal towns of the Saxons. Sigebert, king of the East Angles, founded a monastery here about 633, which in 903 became the burial place of King Edmund, who was slain by the Danes about 870, and owed most of its early celebrity to the reputed miracles performed at the shrine of the martyr king. By 925 the fame of St Edmund had spread far and wide, and the name of the town was changed to St Edmund's Bury. Sweyn, in 1020, having destroyed the older monastery and ejected the secular priests, built a Benedictine abbey on its site. In 943 or 945 King Edmund had granted to the abbot and convent jurisdiction over the whole town, free from all secular services, and Canute in 1020 freed it from episcopal control. Edward the Confessor made the abbot lord of the franchise. By various grants from the abbots, the town gradually attained the rank of a borough. Henry III. in 1235 granted to the abbot two annual fairs, one in December (which still survives), the other the great St Matthew's fair, which was abolished by the Fairs Act of 1871. Another fair was granted by Henry IV. in 1405. Elizabeth in 1562 confirmed the charters which former kings had granted to the abbots, and James I. in 1606 granted a charter of incorporation with an annual fair in Easter week and a market. Further charters were granted by him in 1608 and 1614, and by Charles II. in 1668 and 1684. The reversion of the fairs and two markets on Wednesday and Saturday were granted by James I. in fee farm to the corporation. Parliaments were held here in 1272, 1296 and 1446, but the borough was not represented until 1608, when James I. conferred the privilege of sending two members. The Redistribution Act 1885 reduced the representation to one. There was formerly a large woollen trade.

See Richard Yates, *Hist. and Antiq. of the Abbey of St Edmund's Bury* (2nd ed., 1843); H. R. Barker, *History of Bury St Edmunds*.

BUSBECQ, **OGIER GHISLAIN DE** [AUGERUS GISELNIUS? (1522-1592), Flemish writer and traveller, was born at Comines, and educated at the university of Louvain and elsewhere. Having served the emperor Charles V. and his son Philip II. of Spain, he entered the service of the emperor Ferdinand I., who sent him as ambassador to the sultan Sulaiman I. the Magnificent. He returned to Vienna in 1562 to become tutor to the sons of Maximilian II., afterwards emperor, subsequently taking the position of master of the household of Elizabeth, widow of Charles IX., king of France, and daughter of Maximilian. Busbecq was an excellent scholar, a graceful writer and a clever diplomatist. He collected valuable manuscripts, rare coins and curious inscriptions, and introduced various plants into Germany. He died at the castle of Maillot near Rouen on the 28th of October 1592. Busbecq wrote *Itinera Constantinopolitanum et Amasianum* (Antwerp, 1581), a work showing considerable insight into Turkish politics. This was published in Paris in 1589 as *A. G. Busbequii legationis Turcicae epistolae* &c. and has been translated into several languages. He was a frequent visitor to France, and wrote *Epistolae ad Rudolphum II. Imperatorem e Gallia scriptae* (Louvain, 1630), an interesting account of affairs at the French court. His works were published

in 1633 and at Basel in 1740. An English translation was published in 1744.

F. Forster and F. H. B. Daniel, *Life and Letters of Ogier Busbecq* (London, 1881); Viertel, *Busbecks Erlebnisse in* (Göttingen, 1922).

RICHARD (1605-1695), English clergyman, and head Westminster school, was born at Lutton in Lincolnshire. He was educated at the school which he afterwards intended for so long a period, and first signalled by gaining a king's scholarship. From Westminster he went to Christ Church, Oxford, where he graduated in his thirty-third year he had already become rector of the obstinate zeal with which he supported the falling of the Stuarts, and was rewarded for his services with and rectory of Cudworth, with the chapel of Knowle in Somersetshire. Next year he became head master, where his reputation as a teacher soon became himself once boasted that sixteen of the bishops who sat on the bench had been birched with his "little rod." England has on the whole produced so many eminent ministers did under the régime of Busby. Among the names of his pupils may be mentioned South, Dryden, and Bishop Atterbury. He wrote and edited many books for his scholars. His original treatises (the best his Greek and Latin grammars), as well as those translated, have, however, long since fallen into disuse. In 1695, in his ninetieth year, and was buried in Westminster Abbey, where his effigy is still to be seen.

The English name for a military head-dress of fur. The original sense of a "busby wig" came from association with Busby of Westminster; but it is also derived from the phrase "buzs wig." In its first Hungarian form it was a cylindrical fur cap, having a "bag" hanging from the top; the end of this bag was on the right shoulder as a defence against sword-cuts. "Busbies" are of two kinds: (a) the hussar's cap, in shape, with a bag; this is worn by hussars of the Horse Artillery; (b) the rifle busby, a folding cap, in shape somewhat resembling a "Glengarry" which has straight plumes in the front of the head-rod "busby" is also used colloquially to denote a hood or racoon-skin "caps" worn by foot-guards and the full dress feather bonnet of Highland regiments. Busbies were formerly worn by the artillery regiments, but these are now obsolete in the regular army, being worn by some territorial and colonial troops.

JOSEPH HERMANN MORITZ (1821-1890), German geographer, born at Dresden on the 13th of February 1821. He studied at the university of Leipzig in 1841 as a student of theology, and became doctor of philosophy, and from 1847 he was entirely to journalism and literature. In 1851 he came to Berlin, but soon returned disillusioned to Germany, to give an account of his travels. During the next years he resided in the East and wrote books on Egypt, Palestine, and Persia. From 1856 he was employed at Leipzig as one of the most influential German periodicals, and as editor of the *Zeitschrift für Völkerverständnis*, editorship of Gustav Freytag, had become the national party. In 1864 he became closely associated with the Augustenburg party in Schleswig-Holstein, transferred his services to the Prussian government, and was employed in a semi-official capacity in the newly formed Kingdom of Hanover. From 1870 onwards he was a press agent, and was at the chancellor's side during the whole of the campaign of 1870-71. He published the first of his works on Bismarck—a *Biography of Bismarck and his People, during the Wars with France and Prussia*, under the form of extracts from his diary, and a collection of the chancellor's life during the war. His descriptions and the cleverness with which he reported ensured a success, and the work was translated into several languages. This was followed in 1885

by another book, *Unser Reichskanzler*, chiefly dealing with the work in the foreign office in Berlin. Immediately after Bismarck's death Busch published the chancellor's famous petition to the emperor William II. dated the 18th of March 1890, requesting to be relieved of office. This was followed by a pamphlet *Bismarck und sein Werk*; and in 1898 in London and in English, by the famous memoirs entitled *Bismarck: some Secret Pages of his History* (German by Grunow, under title *Tagebuchblätter*), in which were reprinted the whole of the earlier works, but which contains in addition a considerable amount of new matter, passages from the earlier works which had been omitted because of the attacks they contained on people in high position, records of later conversations, and some important letters and documents which had been entrusted to him by Bismarck. Many passages were of such a nature that it could not be safely published in Germany; but in 1899 a far better and more complete German edition was published at Leipzig in three volumes and consisting of three sections. Busch died at Leipzig on the 16th of November 1890.

See Ernst Goetz; in *Biog. Jahrbuch* (1900).

BUSCH, WILHELM (1832-1908), German caricaturist, was born at Wiedensahl in Hanover. After studying at the academies of Düsseldorf, Antwerp and Munich, he joined in 1859 the staff of *Fliegende Blätter*, the leading German comic paper, and was, together with Oberländer, the founder of modern German caricature. His humorous drawings and caricatures are remarkable for the extreme simplicity and expressiveness of his pen-and-ink line, which record with a few rapid acrawls the most complicated contortions of the body and the most transitory movement. His humorous illustrated poems, such as *Max und Moritz*, *Der heilige Antonius von Padua*, *Die Fromme Helena*, *Hans Huchelstein* and *Die Erlebnisse Knopps des Junggesellen*, play, in the German nursery, the same part that Edward Lear's nonsense verses do in England. The types created by him have become household words in his country. He invented the series of comic sketches illustrating a story in scenes without words, which have inspired Caran d'Ache and other leading caricaturists.

BÜSCHING, ANTON FRIEDRICH (1724-1793), German theologian and geographer, was born at Stadthagen in Schaumburg-Lippe, on the 27th of September 1724. In 1748 he was appointed tutor in the family of the count de Llynar, who was then going as ambassador to St Petersburg. On this journey he resolved to devote his life to the improvement of geographical science. Leaving the count's family, he went to reside at Copenhagen, and devoted himself entirely to this new pursuit. In 1752 he published his *Description of the Counties of Schleswig and Holstein*. In 1754 he removed to Göttingen; where in 1757 he was appointed professor of philosophy; but in 1761 he accepted an invitation to the German congregation at St Petersburg. There he organized a school which, under him, soon became one of the most flourishing in the north of Europe, but a disagreement with Marshal Münich led him, in spite of the empress's offers of high advancement, to return to central Europe in 1765. He first went to live at Altona; but next year he was called to superintend the famous "Greyfriars Gymnasium" (*Gymnasium sive Grauen Kloster*), which had been formed at Berlin by Frederick the Great. He died of dropsy on the 28th of May 1793, having by writing and example given a new impulse to education throughout Prussia. While at Göttingen he married the poetess, Christiana Dilthey.

Büsching's works (on geography, history, education and religion) amount to more than a hundred. The first class comprehends those upon which his fame chiefly rests; for although he did not possess the genius of D'Anville, he may be regarded as the creator of modern Statistical Geography. His *magnum opus* is the *Erdebeschreibung*, in seven parts, of which the first four, comprehending Europe, were published in 1754-1761, and have been translated into several languages (e.g. into English with a preface by Murdoch, in six volumes, London, 1762). In 1768 the fifth part was published, being the first volume upon Asia, containing Asiatic Turkey and Arabia. It displays an immense extent of research, and is generally considered as his

masterpiece. Büsching was also the editor of a valuable collection entitled *Magazin für d. neue Historie und Geographie* (23 vols. 4to, 1767-1793); also of *Wochentl. Nachrichten von neuen Landkarten* (Berlin, 1773-1787). His works on education enjoyed great repute. In biography he wrote a number of articles for the above-mentioned *Magazin*, and a valuable collection of *Beiträge zur Lebensgeschichte merkwürdiger Personen* (6 vols., 1783-1789), including an elaborate life of Frederick the Great.

BUSENBAUM (or BUSEMBAUM), HERMANN (1600-1668), Jesuit theologian, was born at Nottelen in Westphalia. He attained fame as a master of casuistry, and out of his lectures to students at Cologne grew his celebrated book *Medulla theologiae moralis, facili ac perspicua methodo resolvens casus conscientiae* (1645). The manual obtained a wide popularity and passed through over two hundred editions before 1776. Pierre Lacroix added considerably to its bulk, and editions in two folio volumes appeared in both Germany (1710-1714) and France (1729). In these sections on murder and especially on regicide were much amplified, and in connexion with Damien's attempt on the life of Louis XV. the book was severely handled by the parlement of Paris. At Toulouse in 1757, though the offending sections were repudiated by the heads of the Jesuit colleges, the *Medulla* was publicly burned, and the episode undoubtedly led the way to the duc de Choiseul's attack on the society. Busenbaum also wrote a book on the ascetic life, *Lilium inter spinas*. He became rector of the Jesuit college at Hildesheim and then at Münster, where he died on the 31st of January 1668, being at the time father-confessor to Bishop Bernard of Galen.

BUSH. (1) (A word common to many European languages, meaning "a wood," cf. the Ger. *Busch*, Fr. *bois*, Ital. *bosco*, and the med. Lat. *boscu*), a shrub or group of shrubs, especially of those plants whose branches grow low and thick. Collectively "the bush" is used in British colonies, particularly in Australasia and South Africa, for the tract of country covered with brushwood not yet cleared for cultivation. From the custom of hanging a bush as a sign outside a tavern comes the proverb "Good wine needs no bush." (2) (From a Teutonic word meaning "a box," cf. the Ger. *Rad-büchse*, a wheel box, and the termination of "blunderbuss" and "arquebus"); the derivation from the Fr. *bouche*, a mouth, is not correct), a lining frequently inserted in the bearings of machinery. When a shaft and the bearing in which it rotates are made of the same metal, the two surfaces are in certain cases apt to "seize" and abrade each other. To prevent this, bushes of some dissimilar metal are employed; thus a shaft of mild steel or wrought iron may be made to run in hard cast steel, cast iron, bronze or Babbitt metal. The last, having a low melting point, may be cast about the shaft for which it is to form a bearing.

BUSHBUCK (*Boschbok*), the South African name of a medium-sized red antelope (q.v.), marked with white lines and spots, belonging to a local race of a widely spread species, *Tragelaphus scriptus*.



Female Bushbuck.

BUSHEL (from the O. Fr. *boissiel*, cf. med. Lat. *busellus*, *busellus*, a little box), a dry measure of capacity, containing 8 gallons or 4 pecks. It has been in use for measuring corn, potatoes, &c., from a very early date; the value varying locally and with the article measured. The "imperial bushel," legally established in Great Britain in 1826, contains 2218.192 cub. in., or 80 lb of distilled water, determined at 62° F., with the barometer at 30 in. Previously, the standard bushel used was known as the "Winchester bushel," so named from the standard being

kept in the town hall at Winchester; it contained 2150.43 cub. in. This standard is the basis of the bushel used in the United States and Canada, but other "bushels" for use in connexion with certain commodities have been legalized in different states.

BUSHIDO (Japanese for "military-knight-ways"), the unwritten code of laws governing the lives of the nobles of Japan, equivalent to the European chivalry. Its maxims have been orally handed down, together with a vast accumulation of traditional etiquette, the result of centuries of feudalism. Its inception is associated with the uprising of feudal institutions under Yoritomo, the first of the Shoguns, late in the 12th century, but bushido in an undeveloped form existed before then. The samurai or nobles of Japan entertained the highest respect for truth. "A bushi has no second word" was one of their mottoes. And their sense of honour was so high as to dictate suicide where it was offended.

See Inazo Nitobe, *Bushido: The Soul of Japan* (1905); also JAPAN. Army.

BUSHIRE, or BANDER BUSHIRE, a town of Persia, on the northern shore of the Persian Gulf, in 26° 59' N., 50° 49' E. The name is pronounced Boosheer, and not Bew-shire, or Bus-hire. Modern Persians write it Bushehr and, yet more incorrectly, Abushehr, and translate it as "father of the city," but it is most probably a contraction of Bokht-ardashir, the name given to the place by the first Sassanian monarch in the 3rd century. In a similar way Riv-ardashir, a few miles south of Bushire, has become Rishire (Reesheer). In the first half of the 18th century, when Bushire was an unimportant fishing village, it was selected by Nadir Shah as the southern port of Persia and dockyard of the navy which he aspired to create in the Persian Gulf, and the British commercial factory of the East India Company, established at Gombur, the modern Bander Abbas, was transferred to it in 1759. At the beginning of the 19th century it had a population of 6000 to 8000, and it is now the most important port in the Persian Gulf, with a population of about 25,000. It used to be under the government of Fars, but is (since about 1892) the seat of the governor of the Persian Gulf ports, who is responsible to the central government, and has under his jurisdiction the principal ports of the Gulf and their dependencies. The town, which is of a triangular form, occupies the northern extremity of a peninsula 11 m. long and 4 broad, and is encircled by the sea on all sides except the south. It is fortified on the land side by a wall with 12 round towers. The houses being mostly built of a white conglomerate stone of shells and coral which forms the peninsula, gives the city when viewed from a distance a clean and handsome appearance, but on closer inspection the streets are found to be very narrow, irregular, ill-paved and filthy. Almost the only decent buildings are the governor's palace, the British residency and the houses of some well-to-do merchants. The sea immediately east of the town has a considerable depth, but its navigation is impeded by sandbanks and a bar north and west of the town, which can be passed only by vessels drawing not more than 9 ft. of water, except at spring tides, when there is a rise of from 8 to 10 ft. Vessels drawing more than 9 ft. must anchor in the roads miles away to the west. The climate is very hot in the summer months and unhealthy. The water is very bad, and that fit for drinking requires to be brought from wells distant 1½ to 3 m. from the city wall.

Bushire carries on a considerable trade, particularly with India, Java and Arabia. Its principal imports are cotton and woollen goods, yarn, metals, sugar, coffee, tea, spices, cashmere shawls, &c., and its principal exports opium, wool, carpets, horses, grain, dyes and gums, tobacco, rosewater, &c. The importance of Bushire has much increased since about 1862. It is now not only the headquarters of the English naval squadron in the Persian Gulf, and the land terminus of the Indo-European telegraph, but it also forms the chief station in the Gulf of the British India Steam Navigation Company, which runs its vessels weekly between Bombay and Basra. Consulates of Great Britain, Germany, France, Russia and Turkey and several European mercantile houses are established at Bushire, and

notwithstanding the drawbacks of bad roads to the interior, insufficient and precarious means of transport, and want of security, the annual value of the Bushire trade since 1890 averaged about £1,500,000 (one-third being for exports, two-thirds for imports), and over two-thirds of this was British. Of the 278,000 tons of shipping which entered the port in 1905, 244,000 were British.

During the war with Persia (1856-57) Bushire surrendered to a British force and remained in British occupation for some months. At Rishire, some miles south of Bushire and near the summer quarters of the British resident and the British telegraph buildings, there are extensive ruins among which bricks with cuneiform inscriptions have been found, showing that the place was a very old Elamite settlement. (A. H. S.)

BUSHMEN, or **BOSJEMANS**, a people of South Africa, so named by the British and Dutch colonists of the Cape. They often call themselves *Soson* [Sing. *Sá*], but this appears to be the Hottentot name. If they have a national name it is *Kwasi*, probably "small man," the title of one group. This *Kwasi* has, however, been translated as the Bushman word for *tablier égyptien* (see below), adopted as the racial name because that malformation is one of their physical characteristics. The Kafirs call them *Abatwa*, the Bechuana *Masarwa* (*Maseroa*). There is little reason to doubt that they constitute the aboriginal element of the population of South Africa, and indications of their former presence have been found as far north at least as the Nyasa and Tanganyika basins. "It would seem," writes Sir H. H. Johnston (*British Central Africa*, p. 52), "as if the earliest known race of man inhabiting what is now British Central Africa was skin to the Bushman-Hottentot type of negro. Rounded stones with a hole through the centre, similar to those which are used by the Bushmen in the south for weighting their digging-sticks (the *graaf stock* of the Boers), have been found at the south end of Lake Tanganyika." The dirty yellow colour of the Bushmen, their slightly slanting eyes and prominent cheek-bones had induced early anthropologists to dwell on their resemblance to the Mongolian races. This similarity has been now recognized as quite superficial. More recently a connexion has been traced between the Bushmen and the Pygmy peoples inhabiting the forests of Central Africa. Though the matter cannot be regarded as definitely settled, the latest researches rather tend to discredit this view. In fact it would appear that the two peoples have little in common save diminutive proportions and a nomadic and predatory form of existence. Owing to the discovery of steatopygous figurines in Egyptian graves, a theory has been advanced that the Egyptians of the early dynasties were of the same primitive pygmy negroid stock as the Bushmen. But this is highly speculative. The physical characteristics of Egyptian skulls have nothing of the Bushman in them. Of the primitive pygmy negroid stock the Hottentots (*g.s.*), once considered the parent family, are now regarded as an offshoot of mixed Bantu-Bushman blood from the main Bushman race.

It seems probable that the Bushmen must be regarded as having extended considerably to the north of the area occupied by them within the memory of white men. Evidence has been produced of the presence of a belated Hottentot or Hottentot-Bushman group as far north as the district between Kilimanjaro and Victoria Nyansa. They were probably driven south by the Bantu tribes, who eventually outflanked them and confined them to the less fertile tracts of country. Before the arrival of Europeans in South Africa the Bushman race appears to have been, what it is so essentially is to-day, a nomadic race living in widely scattered groups. The area in which the Bushmen are now found sporadically may be defined as extending from the inner ranges of the mountains of Cape Colony, through the central Kalahari desert to near Lake Ngami, and thence north-westward to the districts about the Ovambo river north of Damaraland. In short, they have been driven by European and Kafir encroachments into the most barren regions of South Africa. A few remain in the more inaccessible parts of the Drakensberg range about the sources of the Vaal. Only in one or two districts are they found in large numbers, chiefly in Great Bushman Land

towards the Orange river. A regularly planned and wholesale destruction of the Bushmen on the borders of Cape Colony in the earlier years of European occupation reduced their numbers to a great extent; but this cruel hunting of the Bushmen has ceased. In retaliation the Bushmen were long the scourge of the farms on the outer borders of the colony, making raids on the cattle and driving them off in large numbers. On the western side of the deserts they are generally at enmity with the Koranna Hottentots, but on the eastern border of the Kalahari they have to some extent fraternized with the earliest Bechuana migrants. Their language, which exists in several dialects, has in common with Hottentot, but to a greater degree, the peculiar sounds known as "clicks." The Hottentot language is more agglutinative, the Bushman more monosyllabic, the former recognizes a gender in names, the latter does not; the Hottentots form the plural by a suffix, the Bushmen by repetition of the name; the former count up to twenty, the latter can only number two, all above that being "many." F.C.Selous records that Koranna Hottentots were able to converse fluently with the Bushmen of Bechuana Land.

The most striking feature of the Bushman's physique is shortness of stature. Gustav Fritsch in 1863-1866 found the average height of six grown men to be 4 ft. 9 in. Earlier, but less trustworthy, measurements make them still shorter. Among 150 measured by Sir John Barrow during the first British occupation of Cape Colony the tallest man was 4 ft. 9 in., the tallest woman 4 ft. 4 in. The Bushmen living in Bechuana Land measured by Selous in the last quarter of the 19th century were, however, found to be of nearly average height. Few persons were below 5 ft.; 5 ft. 4 in. was common, and individuals of even 6 ft. were not unknown. No great difference in height appears to exist between men and women. Fritsch's average from five Bushman women was one-sixth of an inch more than for the men. The Bushmen, as already stated, are of a dirty yellow colour, and of generally unattractive countenance. The skull is long and low, the cheek-bones large and prominent. The eyes are deeply set and crafty in expression. The nose is small and depressed, the mouth wide with moderately everted lips, and the jaws project. The teeth are not like badly cut ivory, as in Bantu, but regular and of a mother-of-pearl appearance. In general build the Bushman is slim and lean almost to emaciation. Even the children show little of the round outlines of youth. The amount of fat under the skin in both sexes is remarkably small; hence the skin is as dry as leather and falls into strong folds around the stomach and at the joints. The fetor of the skin, so characteristic of the negro, is not found in the Bushman. The hair is weak in growth, in age it becomes grey, but baldness is rare. Bushmen have little body-hair and that of a weak stubby nature, and none of the fine down usual on most skins. On the face there is usually only a scanty moustache. A hollowed back and protruding stomach are frequent characteristics of their figure, but many of them are well proportioned, all being active and capable of enduring great privations and fatigue. Considerable steatopygy often exists among the women, who share with the Hottentot women the extraordinary prolongation of the nymphæe which is often called "the Hottentot apron" or *tablier*. Northward the Bushmen appear to improve both in general condition and in stature, probably owing to a tinge of Bantu blood. The Bushman's clothing is scanty: a triangular piece of skin, passed between the legs and fastened round the waist with a string, is often all that is worn. Many men, however, and nearly all the women, wear the *kaross*, a kind of pelisse of skins sewn together, which is used at night as a wrap. The bodies of both sexes are smeared with a native ointment, *bushu*, which, aided by accretions of dust and dirt, soon forms a coating like a rind. Men and women often wear sandals of hide or plaited bast. They are fond of ornament, and decorate the arms, neck and legs with beads, iron or copper rings, teeth, hoofs, horns and shells, while they stick feathers or hares' tails in the hair. The women sometimes stain their faces with red pigment. They carry tobacco in goats' horns or in the shell of a land tortoise, while boxes of ointment

or amulets are hung round neck or waist. A jackal's tail mounted on a stick serves the double purpose of fan and handkerchief. For dwellings in the plains they have low huts formed of reed mats, or occupy a hole in the earth; in the mountain districts they make a shelter among the rocks by hanging mats on the windward side. Of household utensils they have none, except ostrich eggs, in which they carry water, and occasionally rough pots. For cooking his food the Bushman needs nothing but fire, which he obtains by rubbing hard and soft wood together.

Bushmen do not possess cattle, and have no domestic animals except a few half-wild dogs, nor have they the smallest rudiments of agriculture. Living by hunting, they are thoroughly acquainted with the habits and movements of every kind of wild animal, following the antelope herds in their migrations. Their weapon is a bow made of a stout bough bent into a sharp curve. It is strung with twisted sinew. The arrow, which is neatly made of a reed, the thickness of a finger, is bound with thread to prevent splitting, and notched at the end for the string. At the point is a head of bone, or stone with a quill barb; iron arrow-blades obtained from the Bantu are also found. The arrow is usually 2 to 3 ft. long. The distance at which the Bushman can be sure of hitting is not great, about twenty paces. The arrows are always coated with a gummy poisonous compound which kills even the largest animal in a few hours. The preparation is something of a mystery, but its main ingredients appear to be the milky juice of the *Amaryllis toxicaria*, which is abundant in South Africa, or of the *Euphorbia arborescens*, generally mixed with the venom of snakes or of a large black spider of the genus *Mygale*; or the entrails of a very deadly caterpillar, called *N'gwa* or 'Kaa, are used alone. One authority states that the Bushmen of the western Kalahari use the juice of a chrysalis which they scrape out of the ground. From their use of these poisons the Bushmen are held in great dread by the neighbouring races. They carry, too, a club some 20 in. long with a knob as big as a man's fist. Assegais and knives are rare. No Bushman tribe south of Lake Ngami is said to carry spears. A rude implement, called by the Boers *graaf stock* or digging stick, consisting of a sharpened spike of hard wood over which a stone, ground to a circular form and perforated, is passed and secured by a wedge, forms part of the Bushman equipment. This is used by the women for uprooting the succulent tuberous roots of the several species of creeping plants of the desert, and in digging pitfalls. These perforated stones have a special interest in indicating the former extension of the Bushmen, since they are found, as has been said, far beyond the area now occupied by them. The Bushmen are famous as hunters, and actually run down many kinds of game. Living a life of periodical starvation, they spend days at a time in search of food, upon which when found they feed so gluttonously that it is said five of them will eat a whole zebra in a few hours. They eat practically anything. The meat is but half cooked, and game is often not completely drawn. The Bushman eats raw such insects as lice and ants, the eggs of the latter being regarded as a great delicacy. In hard times they eat lizards, snakes, frogs, worms and caterpillars. Honey they relish, and for vegetables devour bulbs and roots. Like the Hottentot, the Bushman is a great smoker.

The disposition of the Bushman has been much maligned; the cruelty which has been attributed to him is the natural result of equal brutalities practiced upon him by the other natives and the early European settlers. He is a passionate lover of freedom, and, like many other primitive people, lives only for the moment. Unlike the Hottentot he has never willingly become a slave, and will fight to the last for his personal liberty. He has been described as the "anarchist of South Africa." Still, when he becomes a servant, he is usually trustworthy. His courage is remarkable, and Fritsch was told by residents who were well qualified to speak that supported by a dozen Bushmen they would not be afraid of a hundred Kaffirs. The terror inspired by the Bushmen has indeed had an effect in the deforestation of parts of Cape Colony, for the colonists, to guard against stealthy attacks, cut down all the bush far round

their holdings. Mission-work among the Bushmen has been singularly unsuccessful. But in spite of his savage nature, the Bushman is intelligent. He is quick-witted, and has the gift of imitating extraordinarily well the cries of bird and beast. He is musical, too, and makes a rough instrument out of a gourd and one or more strings. He is fond of dancing; besides the ordinary dances are the special dances at certain stages of the moon, &c. One of the most interesting facts about the Bushman is his possession of a remarkable delight in graphic illustration; the rocks of the mountains of Cape Colony and of the Drakensberg and the walls of caves anciently inhabited by them have many examples of Bushman drawings of men, women, children and animals characteristically sketched. Their designs are partly painted on rock, with four colours, white, black, red and yellow ochre, partly engraved in soft sandstone, partly chiselled in hard stone. Rings, crosses and other signs drawn in blue pigment on some of the rocks, and believed to be one or two centuries old, have given rise to the erroneous speculation that these may be remains of a hieroglyphic writing. A discovery of drawings of men and women with antelope heads was made in the recesses of the Drakensberg in 1873 (J. M. Orpen in *Cape Monthly Magazine*, July 1874). A few years later Selous discovered similar rock-paintings in Masboulaland and Mambicaland.

Little is known of the family life of the Bushmen. Marriage is a matter merely of offer and acceptance ratified by a feast. Among some tribes the youth must prove himself an expert hunter. Nothing is known of the laws of inheritance. The avoidance of parents-in-law, so marked among Kaffirs, is found among Bushmen. Murder, adultery, rape and robbery are offences against their code of morals. As among other African tribes the social position of the women is low. They are beasts of burden, carrying the children and the family property on the journeys, and doing all the work at the halting-place. It is their duty also to keep the encampment supplied with water, so matter how far it has to be carried. The Bushman mother is devoted to her children, who, though suckled for a long time, yet are fed within the first few days after birth upon chewed roots and meat, and taught to chew tobacco at a very early age. The child's head is often protected from the sun by a plaited shade of ostrich feathers. There is practically no tribal organization. Individual families at times join together and appoint a chief, but the arrangement is never more than temporary. The Bushmen have no concrete idea of a God, but believe in evil spirits and supernatural interference with man's life. All Bushmen carry amulets, and there are indications of totemism in their refusal to eat certain foods. Thus one group will not eat goat's flesh, though the animal is the commonest in their district. Others reverence antelopes or even the caterpillar *N'gwa*. The Bushman cuts off the joints of the fingers as a sign of mourning and sometimes, it seems, as an act of repentance. Traces of a belief in continued existence after death are seen in the cairns of stone thrown on the graves of chiefs. Evil spirits are supposed to hide beneath these sepulchral mounds, and the Bushman thinks that if he does not throw his stone on the mounds the spirits will twist his neck. The whole family deserts the place where any one has died, after raising a pile of stones. The corpse's head is anointed, then it is smoke-dried and laid in the grave at full length, stones or earth being piled on it. There is a Bushman belief that the sun will rise later if the dead are not buried with their faces to the east. Weapons and other Bushman treasures are buried with the dead, and the hut materials are burnt in the grave.

The Bushmen have many animal myths, and a rich store of beast legends. The most prominent of the animal mythological figures is that of the mantis, around which a great cycle of myths has been formed. He and his wife have many names. Their adopted daughter is the porcupine. In the family history an ichneumon, an elephant, a monkey and an eland all figure. The Bushmen have also solar and lunar myths, and observe and name the stars. Canopus alone has five names. Some of the constellations have figurative names. Thus they call Orion's Belt "three she-tortoises hanging on a stick," and Castor and

Pollux "the cow-elands." The planets, too, have their names and myths, and some idea of the astonishing wealth of this Bushman folklore and oral literature may be formed from the fact that the materials collected by Bleek and preserved in Sir George Grey's library at Cape Town form eighty-four stout MS. volumes of 3600 pages. They comprise myths, fables, legends and even poetry, with tales about the sun and moon, the stars, the crocodile and other animals; legends of peoples who dwelt in the land before the Bushmen arrived from the north; songs, charms, and even prayers, or at least incantations; histories, adventures of men and animals; tribal customs, traditions, superstitions and genealogies. A most curious feature in Bushman folklore is the occurrence of the speeches of various animals, into which the relater of the legend introduces particular "clicks," supposed to be characteristic of the animals in whose mouths they are placed.

See G. W. Stow, *The Native Races of South Africa* (London, 1905); Mark Hutchinson, "Bushman Drawings" in *Jour. Anthropol. Inst.*, 1882, p. 464; Sir H. H. Johnston, *Jour. Anthropol. Inst.*, 1883, p. 463; Dr H. Welcker, *Archiv f. Anthropol.* xvi.; C. Bertin, "The Bushmen and their Language," *Jour. R. Asiat. Soc.* xviii. part i.; Gustav Fritsch, *Die Eingeborenen Südafrikas* (Breslau, 1872); W. H. I. Bleek, *Bushman Folklore* (1875); J. L. P. Erasmus, *The Wild Bushman*, MS. note (1890); F. C. Selous, *African Nature Notes and Reminiscences* (1908), chap. xx.; S. Passarge, *Die Bushmänner der Kalahari* (Berlin, 1907).

BUSHNELL, HORACE (1802-1876), American theologian, was born in the village of Bantam, township of Litchfield, Connecticut, on the 14th of April 1802. He graduated at Yale in 1827, was associate editor of the *New York Journal of Commerce* in 1828-1830, and in 1829 became a tutor at Yale. Here he at first took up the study of law, but in 1831 he entered the theological department of Yale College, and in 1833 was ordained pastor of the North Congregational church in Hartford, Conn., where he remained until 1859, when on account of long-continued ill-health he resigned his pastorate. Thereafter he had no settled charge, but, until his death at Hartford on the 17th of February 1876, he occasionally preached and was diligently employed as an author. While in California in 1856, for the restoration of his health, he took an active interest in the organization, at Oakland, of the college of California (chartered in 1855 and merged in the university of California in 1869), the presidency of which he declined. As a preacher, Dr Bushnell was a man of remarkable power. Not a dramatic orator, he was in high degree original, thoughtful and impressive in the pulpit. His theological position may be said to have been one of qualified revolt against the Calvinistic orthodoxy of his day. He criticized prevailing conceptions of the Trinity, the atonement, conversion, and the relations of the natural and the supernatural. Above all, he broke with the prevalent view which regarded theology as essentially intellectual in its appeal and demonstrable by processes of exact logical deduction. To his thinking its proper basis is to be found in the feelings and intuitions of man's spiritual nature. He had a vast influence upon theology in America, an influence not so much, possibly, in the direction of the modification of specific doctrines as in "the impulse and tendency and general spirit which he imparted to theological thought." Dr Munger's estimate may be accepted, with reservations, as the true one: "He was a theologian as Copernicus was an astronomer; he changed the point of view, and thus not only changed everything, but pointed the way toward unity in theological thought. He was not exact, but he put God and man and the world into a relation that thought can accept while it goes on to state it more fully with ever growing knowledge. Other thinkers were moving in the same direction; he led the movement in New England, and wrought out a great deliverance. It was a work of superb courage. Hardly a theologian in his denomination stood by him, and nearly all pronounced against him." Four of his books were of particular importance: *Christian Nurture* (1847), in which he virtually opposed revivalism and "effectively turned the current of Christian thought toward the young"; *Nature and the Supernatural* (1858), in which he discussed miracles and endeavoured to "lift the

natural into the supernatural" by emphasizing the supernaturalness of man; *The Vicarious Sacrifice* (1866), in which he contended for what has come to be known as the "moral view" of the atonement in distinction from the "governmental" and the "penal" or "satisfaction" theories; and *God in Christ* (1849) (with an introductory "Dissertation on Language as related to Thought"), in which he expressed, it was charged, heretical views as to the Trinity, holding, among other things, that the Godhead is "instrumentally three—three simply as related to our finite apprehension, and the communication of God's incommunicable nature." Attempts, indeed, were made to bring him to trial, but they were unsuccessful, and in 1853 his church unanimously withdrew from the local "consoiation," thus removing any possibility of further action against him. To his critics Bushnell formally replied by writing *Christ in Theology* (1851), in which he employs the important argument that spiritual facts can be expressed only in approximate and poetical language, and concludes that an adequate dogmatic theology cannot exist. That he did not deny the divinity of Christ he proved in *The Character of Jesus, forbidding his possible Classification with Men* (1861). He also published *Sermons for the New Life* (1858); *Christ and his Salvation* (1864); *Work and Play* (1864); *Moral Uses of Dark Things* (1868); *Women's Suffrage, the Reform against Nature* (1869); *Sermons on Living Subjects* (1872); and *Forgiveness and Law* (1874). Dr Bushnell was greatly interested in the civic interests of Hartford, and was the chief agent in procuring the establishment of the public park named in his honour by that city.

An edition of his works, in eleven volumes, appeared in 1876-1881; and a further volume, gathered from his unpublished papers, as *The Spirit in Man: Sermons and Selections*, in 1903. New editions of his *Nature and the Supernatural*, *Sermons for the New Life*, and *Work and Play*, were published the same year. A full bibliography, by Henry Barrett Learned, is appended to his *Spirit in Man*. Consult Mrs M. B. Cheney's *Life and Letters of Horace Bushnell* (New York, 1880; new edition, 1903), and Dr Theodore T. Munger's *Horace Bushnell, Preacher and Theologian* (Boston, 1899); also a series of papers in the *Minutes of the General Association of Connecticut (Bushnell Centenary)* (Hartford, 1902). (W. W. R.)

BUSIRI (Abū 'Abdallāh Muḥammad ibn Sa'īd ul-Būḡirī) (1211-1294), Arabian poet, lived in Egypt, where he wrote under the patronage of Ibn Ḥinna, the vizier. His poems seem to have been wholly on religious subjects. The most famous of these is the so-called "Poem of the Mantle." It is entirely in praise of Mahomet, who cured the poet of paralysis by appearing to him in a dream and wrapping him in a mantle. The poem has little literary value, being an imitation of Ka'b ibn Zuhair's poem in praise of Mahomet, but its history has been unique (cf. I. Goldziher in *Revue de l'histoire des religions*, vol. xxxi. pp. 304 ff.). Even in the poet's lifetime it was regarded as sacred. Up to the present time its verses are used as amulets; it is employed in the lamentations for the dead; it has been frequently edited and made the basis for other poems, and new poems have been made by interpolating four or six lines after each line of the original. It has been published with English translation by Faizullahabai (Bombay, 1893), with French translation by R. Basset (Paris, 1894), with German translation by C. A. Ralfs (Vienna, 1860), and in other languages elsewhere.

For long list of commentaries, &c., cf. C. Brockelmann's *Gesch. der Arab. Litteratur* (Weimar, 1898), vol. i. pp. 264-267. (G. W. T.)

BUSIRIS, in a Greek legend preserved in a fragment of Pherecydes, an Egyptian king, son of Poseidon and Lyssianassa. After Egypt has been afflicted for nine years with famine, Phrasius, a seer of Cyprus, arrived in Egypt and announced that the cessation of the famine would not take place until a foreigner was yearly sacrificed to Zeus or Jupiter. Busiris commenced by sacrificing the prophet, and continued the custom by offering a foreigner on the altar of the god. It is here that Busiris enters into the circle of the myths and *parerga* of Heracles, who had arrived in Egypt from Libya, and was seized and bound ready to be killed and offered at the altar of Zeus in Memphis. Heracles burst the bonds which bound him, and, seizing his club, slew Busiris with his son Amphidamas and his herald Chabes.

This exploit is often represented on vase paintings from the 6th century B.C. and onwards, the Egyptian monarch and his companions being represented as negroes, and the legend is referred to by Herodotus and later writers. Although some of the Greek writers made Busiris an Egyptian king and a successor of Menes, about the sixtieth of the series, and the builder of Thebes, those better informed by the Egyptians rejected him altogether. Various scotical explanations were given of the myth, and the name not found as a king was recognized as that of the tomo of Osiris. Busiris is here probably an earlier and less accurate Graecism than Osiris for the name of the Egyptian god Usiri, like Bubastis, Buto, for the goddesses Ubasti and Uto. Busiris, Bubastis, Buto, more strictly represent Pusiri, Pubasti, Puto, cities sacred to these divinities. All three were situated in the Delta, and would be amongst the first known to the Greeks. All shrines of Osiris were called *P-usiri*, but the principal city of the name was in the centre of the Delta, capital of the 9th (Busirite) nome of Lower Egypt; another one near Memphis (now Abusir) may have helped the formation of the legend in that quarter. The name Busiris in this legend may have been caught up merely at random by the early Greeks, or they may have vaguely connected their legend with the Egyptian myth of the slaying of Osiris (as king of Egypt) by his mighty brother Seth, who was in certain aspects a patron of foreigners. Phrasius, Chalbes and Epaphus (for the grandfather of Busiris) are all explicable as Graecized Egyptian names, but other names in the legend are purely Greek. The sacrifice of foreign prisoners before a god, a regular scene on temple walls, is perhaps only symbolical, at any rate for the later days of Egyptian history, but foreign intruders must often have suffered rude treatment at the hands of the Egyptians, in spite of the generally mild character of the latter.

See H. v. Gartringen, in Pauly-Wissowa, *Realencyclopädie*, for the evidence from the side of classical archaeology. (F. L. G.)

BUSK, GEORGE (1807-1886), British surgeon, zoologist and palaeontologist, son of Robert Busk, merchant of St Petersburg, was born in that city on the 12th of August 1807. He studied surgery in London, at both St Thomas's and St Bartholomew's hospitals, and was an excellent operator. He was appointed assistant-surgeon to the Greenwich hospital in 1832, and served as naval surgeon first in the *Grampus*, and afterwards for many years in the *Dreadnought*; during this period he made important observations on cholera and on scurvy. In 1855 he retired from service and settled in London, where he devoted himself mainly to the study of zoology and palaeontology. As early as 1842 he had assisted in editing the *Microscopical Journal*, and later he edited the *Quarterly Journal of Microscopical Science* (1853-1868) and the *Natural History Review* (1861-1865). From 1856 to 1859 he was Hunterian professor of comparative anatomy and physiology in the Royal College of Surgeons, and he became president of the college in 1871. He was elected F.R.S. in 1850, and was an active member of the Linnean, Geological and other societies, and president of the Anthropological Institute (1873-1874); he received the Royal Society's Royal medal and the Geological Society's Wollaston and Lyell medals. Early in life he became the leading authority on the Polyzoa, and later the vertebrate remains from caverns and river-deposits occupied his attention. He was a patient and cautious investigator, full of knowledge, and unaffectedly simple in character. He died in London on the 10th of August 1886.

BUSKEN-HUET, CONRAD (1826-1886), Dutch literary critic, was born at the Hague on the 28th of December 1826. He was trained for the Church, and, after studying at Geneva and Lausanne, was appointed pastor of the Walloon chapel in Haarlem in 1851. In 1863 conscientious scruples obliged him to resign his charge, and Busken-Huet, after attempting journalism, went out to Java in 1868 as the editor of a newspaper. Before this time, however, he had begun his career as a polemical man of letters, although it was not until 1872 that he was made famous by the first series of his *Literary Fantasies*, a title under which he gradually gathered in successive volumes all that was most durable in his work as a critic. His one novel, *Lidewijde*,

was written under strong French influences. Returning from the East Indies, Busken-Huet settled for the remainder of his life in Paris, where he died in April 1886. For the last quarter of a century he had been the acknowledged dictator in all questions of Dutch literary taste. Perfectly honest, desirous to be sympathetic, widely read, and devoid of all sectarian obstinacy, Busken-Huet introduced into Holland the light and air of Europe. He made it his business to break down the narrow prejudices and the still narrower self-satisfaction of his countrymen, without endangering his influence by a mere effusion of paradox. He was a brilliant writer, who would have been admired in any language, but whose appearance in a literature so stiff and dead as that of Holland in the 'fifties was dazzling enough to produce a sort of awe and stupefaction. The posthumous correspondence of Busken-Huet has been published, and adds to our impression of the vitality and versatility of his mind. (E. G.)

BUSKIN (a word of uncertain origin, existing in many European languages, as Fr. *brusquin*, Ital. *borzacchino*, Dutch *brunckes*, and Span. *borcegas*), a half-boot or high shoe strapped under the ankle, and protecting the shins; especially the thick-soled boot or *colturnus* in the ancient Athenian tragedy, used to increase the stature of the actors, as opposed to the *soccus*, "sock," the light shoe of comedy. The term is thus often used figuratively of a tragic style.

BUSLAEV, FEDOR IVANOVICH (1818-1898), Russian author and philologist, was born on the 13th of April 1818 at Kerensk, where his father was secretary of the district tribunal. He was educated at Penza and Moscow University. At the end of his academical course, 1838, he accompanied the family of Count S. G. Strogonov on a tour through Italy, Germany and France, occupying himself principally with the study of classical antiquities. On his return he was appointed assistant professor of Russian literature at the university of Moscow. A study of Jacob Grimm's great dictionary had already directed the attention of the young professor to the historical development of the Russian language, and the fruit of his studies was the book *On the Teaching of the National Language* (Moscow, 1844 and 1867), which even now has its value. In 1848 he produced his work *On the Influence of Christianity on the Slavonic Language*, which, though subsequently superseded by Franz von Miklosich's *Christliche Terminologie*, is still one of the most striking dissertations on the development of the Slavonic languages. In this work Buslaev proves that long before the age of Cyril and Methodius the Slavonic languages had been subject to Christian influences. In 1855 he published *Palaeographical and Philological Materials for the History of the Slavonic Alphabets*, and in 1858 *Essay towards an Historical Grammar of the Russian Tongue*, which, despite some trivial defects, is still a standard work, abounding with rich material for students, carefully collected from an immense quantity of ancient records and monuments. In close connexion with this work in his *Historical Chrestomathy of the Church-Slavonic and Old Russian Tongues* (Moscow, 1861). Buslaev also interested himself in Russian popular poetry and old Russian art, and the result of his labours is enshrined in *Historical Sketches of Russian Popular Literature and Art* (St Petersburg, 1861), a very valuable collection of articles and monographs, in which the author shows himself a worthy and faithful disciple of Grimm. His *Popular Poetry* (St Petersburg, 1887) is a valuable supplement to the *Sketches*. In 1881 he was appointed professor of Russian literature at Moscow, and three years later published his *Annotated Apocalypse* with an atlas of 400 plates, illustrative of ancient Russian art.

See S. D. Sheremetev, *Memoir of P. I. Buslaev* (Moscow, 1899). (R. N. B.)

BUSS, FRANCES MARY (1827-1894), English schoolmistress, was born in London in 1827, the daughter of the painter-etcher R. W. Buss, one of the original illustrators of *Pickwick*. She was educated at a school in Camden Town, and continued there as a teacher, but soon joined her mother in keeping a school in Kentish Town. In 1848 she was one of the original attendants at lectures at the new Queen's College for Ladies. In 1850 her

school was moved to Camden Street, and under its new name of the North London Collegiate School for Ladies it rapidly increased in numbers and reputation. In 1864 Miss Buss gave evidence before the Schools Inquiry Commission, and in its report her school was singled out for exceptional commendation. Indeed, under her influence, what was then pioneer work of the highest importance had been done to put the education of girls on a proper intellectual footing. Shortly afterwards the Brewers' Company and the Clothworkers' Company provided funds by which the existing North London Collegiate School was rehoused and a Camden School for Girls founded, and both were endowed under a new scheme, Miss Buss continuing to be principal of the former. She and Miss Beale of Cheltenham became famous as the chief leaders in this branch of the reformed educational movement; she played an active part in promoting the success of the Girls' Public Day School Company, encouraging the connexion of the girls' schools with the university standard by examinations, working for the establishment of women's colleges, and improving the training of teachers; and her energetic personality was a potent force among her pupils and colleagues. She died in London on the 24th of December 1894.

BUSSA, a town in the British protectorate of Northern Nigeria, on the west bank of the Niger, in 10° 9' N., 4° 40' E. It is situated just above the rapids which mark the limit of navigability of the Niger by steamer from the sea. Here in 1866 Mungo Park, in his second expedition to trace the course of the Niger, was attacked by the inhabitants, and drowned while endeavouring to escape. During 1894-1898 its possession was disputed by Great Britain and France, the last-named country acknowledging by the convention of June 1898 the British claim, which carried with it the control of the lower Niger. It is now the capital of northern Borgu (see NIGERIA, and BORGU).

BUSSACO (or **BUSACO**), **SERRA DE**, a mountain range on the frontiers of the Aveiro, Coimbra, and Viseu districts of Portugal, formerly included in the province of Beira. The highest point in the range is the Ponta de Bussaco (1795 ft.), which commands a magnificent view over the Serra da Estrela, the Mondego valley and the Atlantic Ocean. Luso (pop. 1661), a village celebrated for its hot mineral springs, is the nearest railway station, on the Guarda-Figueira da Foz line, which skirts the northern slopes of the Serra. Towards the close of the 19th century the Serra de Bussaco became one of the regular halting-places for foreign, and especially for British, tourists, on the overland route between Lisbon and Oporto. Its hotel, built in the Manoellian style—a blend of Moorish and Gothic—encloses the buildings of a secularized Carmelite monastery, founded in 1268. The convent woods, now a royal domain, have long been famous for their cypress, plane, evergreen oak, cork and other forest trees, many of which have stood for centuries and attained an immense size. A bull of Pope Gregory XV. (1623), anathematizing trespassers and forbidding women to approach, is inscribed on a tablet at the main entrance; another bull, of Urban VIII. (1643), threatens with excommunication any person harming the trees. In 1873 a monument was erected, on the southern slopes of the Serra, to commemorate the battle of Bussaco, in which the French, under Marshal Masséna, were defeated by the British and Portuguese, under Lord Wellington, on the 27th of September 1810.

BUSSY, ROGER DE RABUTIN, COMTE DE (1618-1693), commonly known as **BUSSY-RABUTIN**, French memoir-writer, was born on the 13th of April 1618 at Epiry, near Autun. He represented a family of distinction in Burgundy (see **SÉVIGNÉ**, **MADAME DE**), and his father, Léonor de Rabutin, was lieutenant-general of the province of Nivernais. Roger was the third son, but by the death of his elder brothers became the representative of the family. He entered the army when he was only sixteen and fought through several campaigns, succeeding his father in the office of *maître de camp*. He tells us himself that his two ambitions were to become "honnête homme" and to distinguish himself in arms, but the luck was against him. In 1641 he was sent to the Bastille by Richelieu for some months as a punishment for neglect of his duties in his pursuit of gallantry. In 1643 he married a cousin, Gabrielle de Toulouenge, and for

a short time he left the army. But in 1645 he succeeded to his father's position in the Nivernais, and served under Condé in Catalonia. His wife died in 1646, and he became more notorious than ever by an attempt to abduct Madame de Miramion, a rich widow. This affair was with some difficulty settled by a considerable payment on Bussy's part, and he afterwards married Louise de Rouville. When Condé joined the party of the Fronde, Bussy joined him, but a fancied slight on the part of the prince finally decided him for the royal side. He fought with some distinction both in the civil war and on foreign service, and buying the commission of *maître de camp* in 1655, he went to serve under Turenne in Flanders. He served there for several campaigns and distinguished himself at the battle of the Dunes and elsewhere; but he did not get on well with his general, and his quarrelsome disposition, his overweening vanity and his habit of composing libellous *chansons* made him eventually the enemy of most persons of position both in the army and at court. In the year 1659 he fell into disgrace for having taken part in an orgy at Roissy near Paris during Holy Week, which caused great scandal. Bussy was ordered to retire to his estates, and beguiled his enforced leisure by composing, for the amusement of his mistress, Madame de Montglas, his famous *Histoire amoureuse des Gaules*. This book, a series of sketches of the intrigues of the chief ladies of the court, witty enough, but still more ill-natured, circulated freely in manuscript, and had numerous spurious sequels. It was said that Bussy had not spared the reputation of Madame, and the king, angry at the report, was not appeased when Bussy sent him a copy of the book to disprove the scandal. He was sent to the Bastille on the 17th of April 1665, where he remained for more than a year, and he was only liberated on condition of retiring to his estates, where he lived in exile for seventeen years. Bussy felt the disgrace keenly, but still bitterer was the enforced close of his military career. In 1682 he was allowed to revisit the court, but the coldness of his reception there made his provincial exile seem preferable, and he returned to Burgundy, where he died on the 9th of April 1693.

The *Histoire amoureuse* is in its most striking passages adapted from Petronius, and, except in a few portraits, its attractions are chiefly those of the scandalous chronicle. But his *Mémoires*, published after his death, are extremely lively and characteristic, and have all the charm of a historical romance of the adventurous type. His voluminous correspondence yields in variety and interest to few collections of the kind, except that of Madame de Sévigné, who indeed is represented in it to a great extent, and whose letters first appeared in it. The literary and historical student, therefore, owes Bussy some thanks.

The best edition of the *Histoire amoureuse des Gaules* is that of Paul Boiteau in the Bibliothèque Elzévirienne (3 vols., Paris, 1856-1859). The *Mémoires* (2 vols., 1857) and *Correspondance* (6 vols., 1858-1859) were edited by Ludovic Lalanne. Bussy wrote other things, of which the most important, his *Genealogy of the Rabutin Family*, remained in MS. till 1867, while his *Considérations sur la guerre* was first published in Dresden in 1746. He also wrote, for the use of his children, a series of biographies, in which his own life serves a moral purpose.

BUSTARD (corrupted from the Lat. *Avis tarda*, though the application of the epithet¹ is not easily understood), the largest British land-fowl, and the *Otis tarda* of Linnaeus, which formerly frequented the champaign parts of Great Britain from East Lothian to Dorsetshire, but of which the native race is now extirpated. Its existence in the northern locality just named rests upon Sir Robert Sibbald's authority (*circa* 1684), and though Hector Boethius (1526) unmistakably described it as an inhabitant of the Merse, no later writer than the former has adduced any evidence in favour of its Scottish domicile. The last examples of the native race were probably two killed in 1838 near Swaffham, in Norfolk, a district in which for some years previously a few hen-birds of the species, the remnant of a plentiful stock, had maintained their existence, though no cock-bird had latterly been known to bear them company. In Suffolk, where the neighbourhood of Icklingham formed its chief haunt, an

¹ It may be open to doubt whether *tarda* is here an adjective. Several of the medieval naturalists used it as a substantive.

end came to the race in 1832; on the wolds of Yorkshire about 1826, or perhaps a little later; and on those of Lincolnshire about the same time. Of Wiltshire, George Montagu, author of an *Ornithological Dictionary*, writing in 1813, says that none had been seen in their favourite haunts on Salisbury Plain for the last two or three years. In Dorsetshire there is no evidence of an indigenous example having occurred since that date, nor in Hampshire nor Sussex since the opening of the 19th century. From other English counties, as Cambridgeshire, Hertfordshire and Berkshire, it disappeared without note being taken of the event, and the direct cause or causes of its extermination can only be inferred from what, on testimony cited by Henry Stevenson (*Birds of Norfolk*, ii. pp. 1-42), is known to have led to the same result in Norfolk and Suffolk. In the latter the extension of plantations rendered the country unfitted for a bird whose shy nature could not brook the growth of covert that might shelter a foe, and in the former the introduction of improved agricultural implements, notably the corn-drill and the horse-hoe, led to the discovery and generally the destruction of every nest, for the bird's chosen breeding-place was in wide fields—"brecks," as they are locally called—of winter-corn. Since the extirpation of the native race the bustard is known to Great Britain only by occasional wanderers, straying most likely from the open country of Champagne or Saxony, and occurring in one part or another of the United Kingdom some two or three times every three or four years, and chiefly in midwinter.

An adult male will measure nearly 4 ft. from the tip of the bill to the end of the tail, and its wings have an expanse of 8 ft. or more,—its weight varying (possibly through age) from 22 to 32 lb. This last was that of one which was recorded by the younger Naumann, the best biographer of the bird (*Vögel Deutschlands*, vii. p. 12), who, however, stated in 1834 that he was assured of the former existence of examples which had attained the weight of 35 or 38 lb. The female is considerably smaller. Compared with most other birds frequenting open places, the bustard has disproportionately short legs, yet the bulk of its body renders it a conspicuous and stately object, and when on the wing, to which it readily takes, its flight is powerful and sustained. The bill is of moderate length, but, owing to the exceedingly flat head of the bird, appears longer than it really is. The neck, especially of the male in the breeding-season, is thick, and the tail, in the same sex at that time of year, is generally carried in an upright position, being, however, in the paroxysms of courtship turned forwards, while the head and neck are simultaneously reverted along the back, the wings are lowered, and their shorter feathers erected. In this posture, which has been admirably portrayed by Joseph Wolf (*Zool. Sketches*, pl. 45), the bird presents a very strange appearance, for the tail, head and neck are almost buried amid the upstanding feathers before named, and the breast is protruded to a remarkable extent. The bustard is of a pale grey on the neck and white beneath, but the back is beautifully barred with russet and black, while in the male a band of deep tawny-brown—in some examples approaching a claret-colour—descends from either shoulder and forms a broad gorget on the breast. The secondaries and greater wing-coverts are white, contrasting vividly, as the bird flies, with the black primaries. Both sexes have the ear-coverts somewhat elongated—whence doubtless is derived the name *Ovis* (*Gr. óvis*)—and the male is adorned with a tuft of long, white, bristly plumes, springing from each side of the base of the mandible. The food of the bustard consists of almost any of the plants natural to the open country it loves, but in winter it will readily forage on those which are grown by man, and especially coleseed and similar green crops. To this vegetable diet much animal matter is added when occasion offers, and from an earthworm to a field-mouse little that lives and moves seems to come amiss to its appetite.

Though not many birds have had more written about them than the bustard, much is unsettled with regard to its economy. A moot point, which will most likely always remain undecided, is whether the British race was migratory or not, though that such is the habit of the species in most parts of the European

continent is beyond dispute. Equally uncertain as yet is the question whether it is polygamous or not—the evidence being perhaps in favour of its having that nature. But one of the most singular properties of the bird is the presence in some of the fully-grown males of a pouch or gular sac, opening under the tongue. This extraordinary feature, first discovered by James Douglas, a Scottish physician, and made known by Eleazar Albin in 1740, though its existence was hinted by Sir Thomas Browne sixty years before, if not by the emperor Frederick II, has been found wanting in examples that, from the exhibition of all the outward marks of virility, were believed to be thoroughly mature, and as to its function and mode of development judgment had best be suspended, with the understanding that the old supposition of its serving as a receptacle whence the bird might supply itself or its companions with water in dry places must be deemed to be wholly untenable. The structure of this pouch—the existence of which in some examples has been well established—is, however, variable; and though there is reason to believe that in one form or another it is more or less common to several exotic species of the family *Otididae*, it would seem to be as inconstant in its occurrence as in its capacity. As might be expected, this remarkable feature has attracted a good deal of attention (*Journ. für Ornith.*, 1861, p. 153; *Ibis*, 1862, p. 107; 1865, p. 143; *Proc. Zool. Soc.*, 1865, p. 747, 1868, p. 741, 1869, p. 140; 1874, p. 471), and the later researches of A. H. Garrod show that in an example of the Australian bustard (*Ovis australis*) examined by him there was, instead of a pouch or sac, simply a highly dilated oesophagus—the distension of which, at the bird's will, produced much the same appearance and effect as that of the undoubted sac found at times in the *O. tarda*.

The distribution of the bustards is confined to the Old World—the bird so called in the fur-countries of North America, and thus giving its name to a lake, river and cape, being the Canada goose (*Bernicla canadensis*). In the Palearctic region we have the *O. tarda* already mentioned, extending from Spain to Mesopotamia at least, and from Scania to Morocco, as well as a smaller species, *O. tetras*, which often occurs as a straggler in, but was never an inhabitant of, the British Islands. Two species, known indifferently by the name of houbara (derived from the Arabic), frequent the more southern portions of the region, and one of them, *O. macqueni*, though having the more eastern range and reaching India, has several times occurred in north-western Europe, and once even in England. In the east of Siberia the place of *O. tarda* is taken by the nearly-allied, but apparently distinct, *O. dybowskii*, which would seem to occur also in northern China. Africa is the chief stronghold of the family, nearly a score of well-marked species being peculiar to that continent, all of which have been by later systematists separated from the genus *Ovis*. India, too, has three peculiar species, the smaller of which are there known as floricans, and, like some of their African and one of their European cousins, are remarkable for the ornamental plumage they assume at the breeding-season. Neither in Madagascar nor in the Malay Archipelago is there any form of this family, but Australia possesses one large species already named. From Xenophon's days (*Anab.* i. 5) to our own the flesh of bustards has been esteemed as of the highest flavour. The bustard has long been protected by the game-laws in Great Britain, but, as will have been seen, to little purpose. A few attempts have been made to reinstate it as a denizen of this country, but none on any scale that would ensure success. Many of the older authors considered the bustards allied to the ostrich, a most mistaken view, their affinity pointing apparently towards the cranes in one direction and the plovers in another. (A. N.)

BUSTO ARSIZIO, a town of Lombardy, Italy, in the province of Milan, 21 m. N.W. by rail from the town of Milan. Pop. (1901) 19,673. It contains a fine domed church, S. Maria di Piazza, built in 1517 after the designs of Bramante; the picture over the high altar is one of Gaudenzio Ferrari's best works. The church of S. Giovanni Battista is a good baroque edifice of 1677; by it stands a fine 13th-century campanile. Busto Arsizio is an active manufacturing town, the cotton factories being

specially important. It is a railway junction for Novara and Seregno.

BUTADES, of Sicyon, wrongly called **DEBUTADES**, the first Greek modeller in clay. The story is that his daughter, smitten with love for a youth at Corinth where they lived, drew upon her wall the outline of his shadow, and that upon this outline her father modelled a face of the youth in clay, and baked the model along with the clay tiles which it was his trade to make. This model was preserved in Corinth till Mummius sacked that town. This incident led Butades to ornament the ends of roof-tiles with human faces, a practice which is attested by numerous existing examples. He is also said to have invented a mixture of clay and ruddle, or to have introduced the use of a special kind of red clay (Pliny, *Nat. Hist.* xxxv. 12 [43]). The period at which he flourished is unknown, but has been put at about 600 B.C.

BUTCHER, one who slaughters animals, and dresses and prepares the carcass for purposes of food. The word also is applied to one who combines this trade with that of selling the meat, and to one who only sells the meat. The O. Fr. *bochtier* or *bouchier*, modern *boucher*, from which "butcher" is derived, meant originally a killer of goats and a seller of goats' flesh, from the O. Fr. *boe*, a he-goat, cf. Ital. *becchio*, from *becco*, a goat.

BUTE, JOHN STUART, 3RD EARL OF (1713-1792), English prime minister, son of James, 2nd earl, and of Lady Jane Campbell, daughter of the 1st duke of Argyll, was born on the 5th of May 1713, he was educated at Eton and succeeded to the earldom (in the peerage of Scotland; created for his grandfather Sir James Stuart in 1703) on his father's death in 1723. He was elected a representative peer for Scotland in 1737 but not in the following parliaments, and appears not to have spoken a debate. In 1738 he was made a knight of the Thistle, and for several years lived in retirement in Bute, engaged in agricultural and botanical pursuits. From the quiet obscurity for which his talents and character entirely fitted him Bute was forced by a mere accident. He had resided in England since the rebellion of 1745, and in 1747, a downpour of rain having prevented the departure of Frederick, prince of Wales, from the Glamorgan races, Bute was summoned to his tent to make up a 'host party'; he immediately gained the favour of the prince and princess, became the leading personage at their court, and in 1750 was appointed by Frederick a lord of his bedchamber after the latter's death in 1751 his influence in the household increased. To his close intimacy with the princess a guilty character was commonly assigned by contemporary opinion, and their relations formed the subject of numerous popular lampoons, but the scandal was never founded on anything but conjecture and the malice of faction. With the young prince, the future king, Bute's intimacy was equally marked; he became a constant companion and confidant, and used his influence to inspire him with animosity against the Whigs and with the high notions of the sovereign's powers and duties found in Voltaire's *Patriot King* and Blackstone's *Commentaries*. In 1775 he took part in the negotiations between Leicester House and Pitt, directed against the duke of Newcastle, and in 1757 the conferences between the two ministers which led to their taking office together. In 1756, by the special desire of the young prince, he was appointed groom of the stole at Leicester House, in spite of the king's pronounced aversion to him.

On the accession of George III. in 1760, Bute became at once a person of power and importance. He was appointed a privy councillor, groom of the stole and first gentleman of the bedchamber, and though merely an irresponsible confidant, without seat in parliament or in the cabinet, he was in reality prime minister, and the only person trusted with the king's wishes and confidence. George III. and Bute immediately proceeded to accomplish their long-projected plans, the conclusion of the peace with France, the break-up of the Whig monopoly of power, and the supremacy of the monarchy over parliament and parties. Their policy was carried out with consummate skill and caution. Great care was shown not to alienate the Whig leaders in a body, which would have raised up under Pitt's leadership a formidable array of resistance, but advantage was taken of disagreements

between the ministers concerning the war, of personal jealousies, and of the strong reluctance of the old statesmen who had served the crown for generations to identify themselves with active opposition to the king's wishes. They were all discarded singly, and isolated, after violent disagreements, from the rest of the ministers. On the 25th of March 1761 Bute succeeded Lord Holderness as secretary of state for the northern department, and Pitt resigned in October on the refusal of the government to declare war against Spain.

On the 3rd of November Bute appeared in his new capacity as prime minister in the House of Lords, where he had not been seen for twenty years. Though he had succeeded in disarming all organized opposition in parliament, the hostility displayed against him in the nation, arising from his Scottish nationality, his character as favourite, his peace policy and the resignation of the popular hero Pitt, was overwhelming. He was the object of numerous attacks and lampoons. He dared not show himself in the streets without the protection of prize-fighters, while the jack-boot (a pun upon his name) and the petticoat, by which the princess was represented, were continually being burnt by the mob or hanged upon the gallows. On the 9th of November, while proceeding to the Guildhall, he narrowly escaped falling into the hands of the populace, who smashed his coach, and he was treated with studied coldness at the banquet. In January 1762 Bute was compelled to declare war against Spain, though now without the advantages which the earlier decision urged by Pitt could have secured, and he supported the war, but with no zeal and no definite aim beyond the obtaining of a peace at any price and as soon as possible. In May he succeeded the duke of Newcastle as first lord of the treasury, and he was created K.G. after resigning the order of the Thistle. In his blind eagerness for peace he conducted on his own responsibility secret negotiations for peace with France through Viri, the Sardinian minister, and the preliminary treaty was signed on the 3rd of November at Fontainebleau. The king of Prussia had some reason to complain of the sudden desertion of his ally, but there is no evidence whatever to substantiate his accusation that Bute had endeavoured to divert the tsar later from his alliance with Prussia, or that he had treacherously in his negotiations with Vienna held out to that court hopes of territorial compensation in Silesia as the price of the abandonment of France, while the charge brought against Bute in 1765 of having taken bribes to conclude the peace, subsequently after investigation pronounced frivolous by parliament, may safely be ignored. A parliamentary majority was now secured for the minister's policy by bribery and threats, and with the aid of Henry Fox, who deserted his party to become leader of the Commons. The definitive peace of Paris was signed on the 10th of February 1763, and a wholesale proscription of the Whigs was begun, the most insignificant adherents of the fallen party, including widows, menial servants and schoolboys, incurring the minister's mean vengeance. Later, Bute roused further hostility by his deer tax, an ill-advised measure producing only £75,000 a year, imposing special burdens upon the farmers and landed interest in the cider counties, and extremely unpopular because extending the detested system of taxation by excise, regarded as an infringement of the popular liberties. At length, unable to contend any longer against the general and inveterate animosity displayed against him, fearing for the consequences to the monarchy, alarmed at the virulent attacks of the *North Briton*, and suffering from ill-health, Bute resigned office on the 8th of April. "Fifty pounds a year," he declared, "and bread and water were luxury compared with what I suffer." He had, however, before retiring achieved the objects for which he had been entrusted with power.

He still for a short time retained influence with the king, and intended to employ George Grenville (whom he recommended as his successor) as his agent; but the latter insisted on possessing the king's whole confidence, and on the failure of Bute in August 1763 to procure his dismissal and to substitute a ministry led by Pitt and the duke of Bedford, Grenville demanded and obtained Bute's withdrawal from the court. He resigned accordingly the office of privy purse, and took leave of George III.

on the 28th of September. He still corresponded with the king, and returned again to London next year, but in May 1765, after the duke of Cumberland's failure to form an administration, Grenville exacted the promise from the king, which appears to have been kept faithfully, that Bute should have no share and should give no advice whatever in public business, and obtained the dismissal of Bute's brother from his post of lord privy seal in Scotland. Bute continued to visit the princess of Wales, but on the king's arrival always retired by a back staircase.

The remainder of Bute's life has little public interest. He spoke against the government on the American question in February 1766, and in March against the repeal of the Stamp Act. In 1768 and 1774 he was again elected a representative peer for Scotland, but took no further part in politics, and in 1778 refused to have anything to do with the abortive attempt to effect an alliance between himself and Chatham. He travelled in Italy, complained of the malice of his opponents and of the ingratitude of the king, and determined "to retire from the world before it retires from me." He died on the 10th of March 1792 and was buried at Rothesay in Bute.

Though one of the worst of ministers, Bute was by no means the worst of men or the despicable and detestable person represented by the popular imagination. His abilities were inconsiderable, his character weak, and he was qualified neither for the ordinary administration of public business nor for the higher sphere of statesmanship, and was entirely destitute of that experience which sometimes fills the place of natural aptitude. His short administration was one of the most disgraceful and incompetent in English history, originating in an accident, supported only by the will of the sovereign, by gross corruption and intimidation, the precursor of the disintegration of political life and of a whole series of national disasters. Yet Bute had good principles and intentions, was inspired by feelings of sincere affection and loyalty for his sovereign, and his character remains untarnished by the grosser accusations raised by faction. In the circle of his family and intimate friends, away from the great world in which he made so poor a figure, he was greatly esteemed. Samuel Johnson, Lord Mansfield, Lady Hervey, Bishop Warburton join in his praise. For the former, a strong opponent of his administration, he procured a pension of £300 a year. He was exceptionally well read, with a refined taste for books and art, and purchased the famous *Thomason Tracts* now in the British Museum. He was learned in the science of botany, and formed a magnificent collection and a botanic garden at Luton Hoo, where Robert Adam built for him a splendid residence. He engraved privately about 1785 at enormous expense *Botanical Tables containing the Different Families of British Plants*, while *The Tabular Distribution of British Plants* (1787) is also attributed to him. Bute filled the offices of ranger of Richmond Forest, governor of the Charterhouse, chancellor of Marischal College, Aberdeen (1761), trustee of the British Museum (1765), president of the Society of Antiquaries of Scotland (1780) and commissioner of Chelsea hospital.

By his marriage with Mary, daughter of Edward Wortley Montagu of Wortley, Yorkshire, who in 1761 was created Baroness Mount Stuart of Wortley, and through whom he became possessed of the enormous Wortley property, he had, besides six daughters, five sons, the eldest of whom, John, Lord Cardiff (1744-1814), succeeded him as 4th earl and was created a marquess in 1796. John, Lord Mount Stuart (1767-1794), the son and heir of the 1st marquess, died before his father, and consequently in 1814 the Bute titles and estates came to his son John (1793-1848) as 2nd marquess. The latter was succeeded by his only son John Patrick (1847-1900), whose son John (b. 1881) inherited the title in 1900.

BUTE, the most important, though not the largest, of the islands constituting the county of the same name, in the Firth of Clyde, Scotland, about 18 m. S.W. of Greenock and 40 m., by water, from Glasgow. It is bounded on the N. and W. by the lovely Kyles of Bute, the narrow winding strait which separates it from Argyllshire, on the E. by the Firth of Clyde, and on the S. and S.W. by the Sound of Bute, about 6 m. wide, which divides it from Arran. Its area is about 49 sq. m., or

31,161 acres. It lies in a N.W. to S.E. direction, and its greatest length from Buttock Point on the Kyles to Garroch Head on the Firth of Clyde is 15½ m. Owing to indentations its width varies from 1½ m. to 4½ m. There are piers at Kilkchattan, Craigmore, Port Bannatyne and Rothesay, but at Rothesay is practically the harbour for the whole island. Here there is regular communication by railway steamers from Craigmadoran, Prince's Pier (Greenock), Gourcock and Wemyss Bay, and by frequent vessels from the Broomielaw Bridge in Glasgow and other points on the Clyde. Pop. (1891) 11,735, (1901) 12,162.

The principal hills are in the north, where the chief are Kames Hill (911 ft.) and Kilbride Hill (836 ft.). The streams are mostly burns, and there are six lochs. Loch Fad, about 1 m. S. of Rothesay, 2½ m. long by ½ m. wide, was the source of the power used in the Rothesay cotton-spinning mill, which was the first establishment of the kind erected in Scotland. In 1827 on its western shore Edmund Kean built a cottage afterwards occupied by Sheridan Knowles. It now belongs to the marquess of Bute. From Loch Ascog, fully 1 m. long, Rothesay derives its water supply. The other lakes are Loch Quien, Loch Greenan, Dhu Loch and Loch Bull. Glen More in the north and Glen Callum in the south are the only glens of any size. The climate is mild and healthful, fuchias and other plants flowering even in winter, and neither snow nor frost being of long continuance, and less rain falling than in many parts of the western coast. Some two-thirds of the area, mostly in the centre and south, are arable, yielding excellent crops of potatoes for the Glasgow market, oats and turnips, the rest consists of hill pastures and plantations. The fisheries are of considerable value. There is no lack of sandstone, slate and whinstone. Some coal exists, but it is of inferior quality and doubtful quantity. At Kilkchattan a superior clay for bricks and tiles is found, and grey granite susceptible of high polish.

The island is divided geologically into two areas by a fault running from Rothesay Bay in a south-south-west direction by Loch Fad to Scalpsie Bay, which, throughout its course, coincides with a well-marked depression. The tract lying to the north-west of this dislocation is composed of the metamorphic rocks of the Eastern Highlands. The Dunoon phyllites form a narrow belt about a mile and a half broad crossing the island between Kames Bay and Etrivick Bay, while the area to the north is occupied by grits and schists which may be the western prolongations of the Beinn Bheula group. Near Rothesay and along the hill slopes west of Loch Fad there are parallel strips of grits and phyllites. That part of the island lying to the east of this dislocation consists chiefly of Upper Old Red Sandstone strata, dipping generally in a westerly or south-westerly direction. At the extreme south end, between Kilkchattan and Garroch Head, these conglomerates and sandstones are overlaid by a thick corstone or dolomitic limestone marking the upper limit of the formation, which is surmounted by the cement-stones and contemporaneous lavas of Lower Carboniferous age. The bedded volcanic rocks which form a series of ridges trending north-west comprise porphyritic basalts, andesite, and, near Port Luchdach, brownish trachyte. Near the base of the volcanic series intrusive igneous rocks of Carboniferous age appear in the form of sills and bosses, as, for instance, the oval mass of olivine-basalt on Suidhe Hill. Remnants of raised beaches are conspicuous in Bute. One of the well-known localities for arctic shelly clays occurs at Kilkchattan brick-works, where the dark red clay rests on tough boulder-clay and may be regarded as of late glacial age.

As to the origin of the name of Bute, there is some doubt. It has been held to come from *both* (Irish for "a cell"), in allusion to the cell which St Brendan erected in the island in the 6th century; others contend that it is derived from the British words *ey budh* (Gaelic, *ey bhiod*), "the island of corn" (*i.e.* food), in reference to its fertility, notable in contrast with the barrenness of the Western Isles and Highlands. Bute was probably first colonized by the vanguard of Scots who came over from Ireland, and at intervals the Norsemen also secured a footing for longer or shorter periods. In those days the Butemen were also called Brandanes, after the Saint. Attesting the antiquity of the island, "Druidical" monuments, barrows, cairns and cists are numerous, as well as the remains of ancient chapels. In virtue of a charter granted by James IV. in 1506, the numerous small proprietors took the title of "baron," which became hereditary in their families. Now the title is practically extinct, the lands conferring it having with very few exceptions passed

by purchase into the possession of the marquess of Bute, the proprietor of nearly the whole island. His seat, Mount Stuart, about 4½ m. from Rothesay by the shore road, is finely situated on the eastern coast. Port Bannatyné (pop. 1165), 2 m. north by west of Rothesay, is a flourishing watering-place, named after Lord Bannatyné (1743-1833), a judge of the court of session, one of the founders of the Highland and Agricultural Society in 1784. Near to it is Kames Castle, where John Sterling, famous for Carlyle's biography, was born in 1806. Kilchattan, in the south-east of the island, is a favourite summer resort. Another object of interest is St Blane's Chapel, picturesquely situated about ½ m. from Dunagoil Bay. Off the western shore of Bute, ¼ m. from St Ninian's Point, lies the island of Inchmarnock, 2 m. in length and about ½ m. in width.

See J. Wilson, *Account of Rothesay and Bute* (Rothesay, 1848); and J. K. Hewison, *History of Bute* (1894-1895).

BUTE, or **BUTESHIRE**, an insular county in the S.W. of Scotland, consisting of the islands of Bute, from which the county takes its name, Inchmarnock, Great Cumbræ, Little Cumbræ, Arran, Holy Island and Pladda, all lying in the Firth of Clyde, between Argyshire on the E. and Argyllshire on the W and N. The area of the county is 140,307 acres, or rather more than 210 sq. m. Pop. (1891) 18,404; (1901) 18,787 (or 86 to the sq. m.) In 1901 the number of persons who spoke Gaelic alone was 20, if those speaking Gaelic and English 2764. Before the Reform Bill of 1832, Buteshire, alternately with Caithness-shire, sent one member to parliament—Rothesay at the same time sharing a representative with Ayr, Campbeltown, Inveraray and Irvine. Rothesay was then merged in the county, which since then has had a member to itself. Buteshire and Renfrewshire form one sheriffdom, with a sheriff-substitute resident in Rothesay who also sits periodically at Brodick and Millport. The circuit courts are held at Inveraray. The county is under school-board jurisdiction, and there is a secondary school at Rothesay. The county council subsidizes technical education in agriculture at Glasgow and Kilmarnock. The staple crops are oats and potatoes, and cattle, sheep and horses are reared. Seed-growing is an extensive industry, and the fisheries are considerable. The Rothesay fishery district includes all the creeks in Buteshire and a few in Argyll and Dumbarton shires, the Cumbræes being grouped with the Greenock district. The herring fishery begins 1 June, and white fishing is followed at one or other point all the year round. During the season many of the fishermen are employed on the Clyde yachts, Rothesay being a prominent yachting centre. The exports comprise agricultural produce and fish, trade being actively carried on between the county ports of Rothesay, Millport, Brodick and Lamlash and the main-land ports of Glasgow, Greenock, Gourock, Ardrossan and Vemys Bay, with all of which there is regular steamer communication throughout the year.

BUTHEROTUM. (1) An ancient seaport of Illyria, corresponding with the modern Butrinto (q.v.). (2) A town in Attica, mentioned by Pliny the Elder (*Nat. Hist.* iv. 37).

BUTLER, the name of a family famous in the history of Ireland. The great house of the Butlers, alone among the families of the conquerors, rivalled the Geraldines, their neighbours, kinsfolk and mortal foes. Theobald Walter, their ancestor, was not long the first of the invaders. He was the grandson of one Hervey Walter who, in the time of Henry I., held Witheton or Weeton in Amounderness, a small fee of the honour of Lancaster, the manor of Newton in Suffolk, and certain lands in Norfolk. On the great inquest of Lancaster lands that followed a writ of 1172, this Hervey, named as the father of Hervey Walter, is said to have given lands in his fee of Weeton to Orm, son of fagnus, with his daughter Alice in marriage. Hervey Walter, son of this Hervey, advanced his family by matching with faude, daughter of Theobald de Valognes, lord of Parham, whose sister Bertha was wife of Ranulf de Glanville, the great justiciar, "the eye of the king." When Ranulf had founded the Austin Canons priory of Butley, Hervey Walter, his wife's brother-in-law, gave to the house lands in Wingfield for the soul's health of himself and his wife Maude. of Ranulf de Glanville

and Bertha his wife, the charter, still preserved in the Harleian collection, being witnessed by Hervey's younger sons, Hubert Walter, Roger and Hamon. Another son, Bartholomew, witnessed a charter of his brother Hubert, 1190-1193. That these nephews of the justiciar profited early by their kinship is seen in Hubert Walter's foundation charter of the abbey of West Dereham, wherein he speaks of "dominus Ranulphus de Glanvilla et domina Bertha uxor eius, qui nos nutrierunt." Hubert, indeed, becoming one of his uncle's clerks, was so much in his confidence that Gervase of Canterbury speaks of the two as ruling the kingdom together. King Richard, whom he accompanied to the Holy Land, made him bishop of Salisbury and (1193) archbishop of Canterbury. Wary of counsel, subtle of wit," he was the champion of Canterbury and of England, and the news of his death drew the cry from King John that "now, for the first time, am I king in truth."

Between these two great statesmen Theobald Walter, the eldest brother of the archbishop, rose and flourished. Theobald is found in the *Liber Niger* (c. 1166) as holding Amounderness by the service of one knight. In 1185 he went over sea to Waterford with John the king's son, the freight of the harness sent after him being charged in the Pipe Roll. Clad in that harness he led the men of Cork when Dermot MacCarthy, prince of Desmond, was put to the sword, John rewarding his services with lands in Limerick and with the important fief of Arklow in the vale of Avoca, where he made his Irish seat and founded an abbey. Returning to England he accompanied his uncle Ranulf to France, both witnessing a charter delivered by the king at Chinon when near to death. Soon afterwards, Theobald Walter was given by John that hereditary office of butler to the lord of Ireland, which makes a surname for his descendants, styling himself *butler* when he attests John's charter to Dublin on the 15th of May 1192. J. Horace Round has pointed out that he also took a fresh seal, the inscription of which calls him Theobald Walter, Butler of Ireland, and henceforward he is sometimes surnamed Butler (*le Botiller*). When John went abroad in 1192, Theobald was given the charge of Lancaster castle, but in 1194 he was forced to surrender to his brother Hubert, who summoned it in King Richard's name. Making his peace through Hubert's influence, he was sheriff of Lancashire for King Richard, who regranted to him all Amounderness. His fortunes turned with the king's death. The new sovereign, treating his surrender of the castle as treachery, took the shrievalty from him, dispossessed him of Amounderness and sold his cantreds of Limerick land to William de Braose. But the great archbishop soon found means to bring his brother back to favour, and on the 2nd of January 1201-2 Amounderness, by writ of the king, is to be restored to Theobald Walter, *dilecto et fidei nostro*. Within a year or two Theobald left England to end his days upon his Arklow fief, busying himself with religious foundations at Wothney in Limerick, at Arklow and at Nenagh. At Wothney he is said to have been buried shortly before the 12th of February 1205-6, when an entry in the Close Roll is concerned with his widow. This widow, Maude, daughter of Robert le Vavasor of Denton, was given up to her father, who, buying the right of marrying her at a price of 1200 marks and two palfreys, gave her to Fulk fitz-Warine. Theobald, the son and heir of Theobald and Maude, a child of six years old, was likewise taken into the keeping of his grandfather Robert, but letters from the king, dated the 2nd of March 1205-6, told Robert, "as he loved his body," to surrender the heir at once to Gilbert fitz-Reinfrid, the baron of Kendal.

Adding to its possessions by marriages the house advanced itself among the nobility of Ireland. On the 1st of September 1315, its chief, Edmund Walter *alias* Edmund the Butler, for services against the Scottish raiders and Ulster rebels, had a charter of the castle and manors of Carrick, Macgriffyn and Roscrea to hold to him and his heirs *sub nomine et honore comitis de Kerry*. This charter, however, while apparently creating an earldom, failed, as Mr Round has explained, to make his issue earls of Carrick. But James, the son and heir of Edmund, having married in 1327 Eleanor de Bohun, daughter of Humfrey,

earl of Hereford and Essex, high constable of England, by a daughter of Edward I., was created an Irish earl on the 2nd of November 1328, with the title of Ormonde.

From the early years of the 14th century the Ormonde earls, generation by generation, were called to the chief government of Ireland as lords-keeper, lords-lieutenant, deputies or lords-justices, and unlike their hereditary enemies the Geraldines they kept a tradition of loyalty to the English crown and to English custom. Their history is full of warring with the native Irish, and as the sun stood still upon Gibeon, even so, we are told, it rested over the red bog of Athy while James the White Earl was staying the wild O'Mores. More than one of the earls of Ormonde had the name of a scholar, while of the 6th earl, master of every European tongue and ambassador to many courts, Edward IV. is said to have declared that were good breeding and liberal qualities lost to the world they might be found again in John, earl of Ormonde. The earls were often absent from Ireland on errands of war or peace. James, the 5th earl, had the English earldom of Wiltshire given him in 1449 for his Lancastrian zeal. He fought at St Albans in 1455, casting his harness into a chalice as he fled the field, and he led a wing at Wakefield. His stall plate as a knight of the Garter is still in St George's chapel. Defeated with the earl of Pembroke at Mortimer's Cross and taken prisoner after Towton, his fate is uncertain, but rumour said that he was beheaded at Newcastle, and a letter addressed to John Paston about May 1461 sends tidings that "the Erle of Wylchir is hed is sette on London Brige."

To his time belongs a document illustrating a curious tradition of the Butlers. His petition to parliament when he was conveying Buckinghamshire lands to the hospital of St Thomas of Acres in London, recites that he does so "in worship of that glorious martyr St Thomas, sometime archbishop of Canterbury, of whose blood the said earl of Wiltshire, his father and many of his ancestors are lineally descended." But the pedigrees in which genealogists have sought to make this descent definite will not bear investigation. The Wiltshire earldom died with him and the Irish earldom was for a time forfeited, his two brothers, John and Thomas, sharing his attainder. John was restored in blood by Edward IV.; and Thomas, the 7th earl, summoned to the English parliament in 1495 as Lord Rochford, a title taken from a Bohun manor in Essex, saw the statute of attainder annulled by Henry VII.'s first parliament. He died without male issue in 1515. Of his two daughters and co-heirs Anne was married to Sir James St Leger, and Margaret to Sir William Boleyn of Blickling, by whom she was mother of Sir James and Sir Thomas Boleyn. The latter, the father of Anne Boleyn, was created earl of Wiltshire and Ormonde in 1520.

In Ireland the heir male of the Ormonde earls, Sir Piers Butler—"red Piers"—assumed the earldom of Ormonde in 1515 and seized upon the Irish estates. Being a good ally against the rebel Irish, the government temporized with his claim. He was an Irishman born, allied to the wild Irish chieftains by his mother, a daughter of the MacMorrough Kavanagh; the earldom had been long in the male line; all Irish sentiment was against the feudal custom which would take it out of the family, and the two co-heirs were widows of English knights. In 1522, styled "Sir Piers Butler pretending himself to be earl of Ormonde," he was made chief governor of Ireland as lord deputy, and on the 23rd of February 1527/8, following an agreement with the co-heirs of the 7th earl, whereby the earldom of Ormonde was declared to be at the king's disposal, he was created earl of Ossory. But the Irish estates, declared forfeit to the crown in 1536 under the Act of Absentees, were granted to him as "earl of Ossory and Ormonde." Although the Boleyn earl of Ormonde and Wiltshire was still alive, there can be no doubt that Piers Butler had a patent of the Ormonde earldom about the 22nd of February 1537/8, from which date his successors must reckon their peerage. His son and heir, James the Lame, who had been created Viscount Thurles on the 2nd of January 1535/6, obtained an act of parliament in 1543/4 which, confirming the grant to his father of the earldom, gave him the old "pre-eminence" of the ancient earldom of 1328.

Earl James was poisoned at a supper in Ely House in 1546, and Thomas the Black Earl, his son and heir, was brought up at the English court, professing the reformed religion. His sympathies were with the Irish, although he stood staunchly for law and order, and for the great part of his life he was wrestling with rebellion. His lands having been harried by his hereditary enemies the Desmond Geraldines, Elizabeth gave him his revenge by appointing him in 1580 military governor of Munster, with a commission to "banish and vanquish these cankered Desmonds" then in open rebellion. In three months, by his own account, he had put to the sword 46 captains, 800 notorious traitors and 4000 others, and, after four years' fighting, Gerald, earl of Desmond, a price on his head, was taken and killed. Dying in 1614 without lawful issue, Thomas was succeeded by his nephew Walter of Kilkash, who had fought beside him against the Burkes and O'Mores. But Sir Robert Preston, afterwards created earl of Desmond, claimed a great part of the Ormonde lands in right of his wife, the Black Earl's daughter and heir. In spite of the loyal services of Earl Walter, King James supported the claimant, and the earl, refusing to submit to a royal award, was thrown into gaol, where he lay for eight years in great poverty, his rents being cut off. Although liberated in 1625 he was not acknowledged heir to his uncle's estates until 1630. His son, Viscount Thurles, being drowned on a passage to England, a grandson succeeded him.

This grandson, James Butler, is perhaps the most famous of the long line of Ormondes. By his marriage with his cousin Elizabeth Preston, the Ormonde titles were once more united with all the Ormonde estates. A loyal soldier and statesman, he commanded for the king in Ireland, where he was between the two fires of Catholic rebels and Protestant parliamentarians. In Ireland he stayed long enough to proclaim Charles II. in 1649, but defeated at Rathmines, his garrisons broken by Cromwell, he quitted the country at the end of 1650. At the Restoration he was appointed lord-lieutenant, his estates having been restored to him with the addition of the county palatine of Tipperary, taken by James I. from his grandfather. In 1652 he had been created a marquess. The English earldom of Brecknock was added in 1660 and an Irish dukedom of Ormonde in the following year. In 1682 he had a patent for an English dukedom with the same title. Buckingham's intrigues deprived him for seven years of his lord-lieutenancy, and a desperate attempt was made upon his life in 1670, when a company of ruffians dragged him from his coach in St James's Street and sought to hurry him to the gallows at Tyburn. His son's threat that, if harm befell his father he would pistol Buckingham, even if he were behind the king's chair, may have saved him from assassination. At the accession of James II. he was once more taken from active employment, and "Barzillai, crowned with honour and with years" died at his Dorsetshire house in 1688. He had seen his great-great-uncle the Black Earl, who was born in 1532, and a great-grandson was playing beside him a few hours before his death. His brave son Ossory, "the eldest hope with every grace adorned," died eight years before him, and he was succeeded by a grandson James, the second duke of Ormonde, who, a recognized leader of the London Jacobites, was attainted in 1715; his honours and estates being forfeited. The duke lived thirty years in exile, chiefly at Avignon, and died in the rebellion year of 1745 without surviving issue. His younger brother Charles, whom King William had created Lord Butler of Westos in the English peerage and earl of Arran in the Irish, was allowed to purchase the Ormonde estates. On the earl's death without issue in 1758 the estates were enjoyed by a sister, passing in 1760, by settlement of the earl of Arran, to John Butler of Kilkash, descendant of a younger brother of the first duke. John dying six years later was succeeded by Walter Butler, a first cousin, whose son John, heir-male of the line of Ormonde, became earl of Ormonde and Ossory and Viscount Thurles in 1791, the Irish parliament reversing the attainder of 1715. Walter, son and heir of the restored earl, was given an English peerage as Lord Butler of Llanthony (1801) and an Irish marquessate of Ormonde (1816), titles that died with him. This Lord Ormonde in 1810

sold to the crown for the great sum of £216,000 his ancestral right to the prisage of wines in Ireland. For his brother and heir, created Lord Ormonde of Llanthony at the coronation of George IV., the Irish marquessate was revived in 1825 and descended in the direct line.

The earls of Carrick (Ireland 1748), Viscounts Ikerrin (Ireland 1629), claim descent from a brother of the first Ormonde earl, while the viscounts Mountgarret (Ireland 1550) spring from a younger son of Piers, the Red Earl of Ossory. The barony of Caher (Ireland 1543), created for Sir Thomas Butler of Chaier or Caher-down-Eske, a descendant in an illegitimate branch of the Butlers, fell into abeyance among heirs general on the death of the 2nd baron in 1560. It was again created, after the surrender of their rights by the heirs general, in 1583 for Sir Theobald Butler (d. 1596), and became extinct in 1858 on the death of Richard Butler, 13th baron and 2nd viscount Caher, and second earl of Glengall. Buttler von Clonebough, *genannt* Haimhausen, count of the Holy Roman Empire, descends from the 3rd earl of Ormonde, the imperial title having been revived in 1681 in memory of the services of a kinsman, Walter, Count Butler (d. 1634), the dragon officer who carried out the murder of Wallenstein.

See *Lancashire Inquests, 1205-1307*; *Lancashire and Cheshire Record Society*, xlviii.; *Chronicles of Matthew Paris*, Roger of Hoveden, Giraldus Cambrensis, &c.; *Dictionary of National Biography*; *C. E. C.'s Complete Peerage*; *Carte's Ormonde papers*; *Foston Letters*; *Rolls of parliament*; *fine rolls*, *liberate rolls*, *pipe rolls*, &c. (O. B.A.)

BUTLER, ALBAN (1710-1773), English Roman Catholic priest and hagiologist, was born in Northampton on the 24th of October 1710. He was educated at the English college, Douai, where on his ordination to the priesthood he held successively the chairs of philosophy and divinity. He laboured for some time as a missionary priest in Staffordshire, held several positions as tutor to young Roman Catholic noblemen, and was finally appointed president of the English seminary at St Omer, where he remained till his death on the 15th of May 1773. Butler's great work, *The Lives of the Saints*, the result of thirty years' study (4 vols., London, 1756-1759), has passed through many editions and translations (best edition, including valuable notes, Dublin, 12 vols. 1779-1780). It is a popular and commendous reproduction of the *Acta Sanctorum*, exhibiting great industry and research, and is in all respects the best work of its kind in English literature.

See *An Account of the Life of A. B. by C. B.*, i.e. by his nephew Charles Butler (London, 1799); and Joseph Gillow's *Bibliographical Dictionary of English Catholics*, vol. i.

BUTLER, BENJAMIN FRANKLIN (1818-1893), American lawyer, soldier and politician, was born in Deerfield, New Hampshire, on the 5th of November 1818. He graduated at Aterville (now Colby) College in 1838, was admitted to the Massachusetts bar in 1840, began practice at Lowell, Massachusetts, and early attained distinction as a lawyer, particularly in criminal cases. Entering politics as a Democrat, he first attracted general attention by his violent campaign in Lowell advocacy of the passage of a law establishing a ten-hour day for labourers; he was a member of the Massachusetts House of Representatives in 1853, and of the state senate in 1859, and was delegate to the Democratic national conventions from 1848 to 1860. In that of 1860 at Charleston he advocated the nomination of Jefferson Davis and opposed Stephen A. Douglas, and in ensuing campaign he supported Breckinridge.

After the Baltimore riot at the opening of the Civil War, Butler, as a brigadier-general in the state militia, was sent by Governor John A. Andrew, with a force of Massachusetts troops, to open communication between the Union states and the Federal States. By his energetic and careful work Butler achieved his purpose without fighting, and he was soon afterwards made major-general, U.S.V. Whilst in command at Fortress Monroe, declined to return to their owners fugitive slaves who had been within his lines, on the ground that, as labourers for emancipation, &c., they were contraband of war, thus originating the phrase "contraband" as applied to the negroes. In the

conduct of tactical operations Butler was almost uniformly unsuccessful, and his first action at Big Bethel, Va., was a humiliating defeat for the National arms. Later in 1861 he commanded an expeditionary force, which, in conjunction with the navy, took Forts Hatteras and Clark, N.C. In 1862 he commanded the force which occupied New Orleans. In the administration of that city he showed great firmness and severity. New Orleans was unusually healthy and orderly during the Butler regime. Many of his acts, however, gave great offence, particularly the seizure of \$800,000 which had been deposited in the office of the Dutch consul, and an order, issued after some provocation, on May 15th, that if any woman should "insult or show contempt for any officer or soldier of the United States, she shall be regarded and shall be held liable to be treated as a woman of the town plying her avocation." This order provoked protests both in the North and the South, and also abroad, particularly in England and France, and it was doubtless the cause of his removal in December 1862. On the 1st of June he had executed one W. B. Mumford, who had torn down a United States flag placed by Farragut on the United States mint; and for this execution he was denounced (Dec. 1862) by President Davis as "a felon deserving capital punishment," who if captured should be reserved for execution. In the campaign of 1864 he was placed at the head of the Army of the James, which he commanded creditably in several battles. But his mismanagement of the expedition against Fort Fisher, N.C., led to his recall by General Grant in December.

He was a Republican representative in Congress from 1867 to 1879, except in 1875-1877. In Congress he was conspicuous as a Radical Republican in Reconstruction legislation, and was one of the managers selected by the House to conduct the impeachment, before the Senate, of President Johnson, opening the case and taking the most prominent part in it on his side; he exercised a marked influence over President Grant and was regarded as his spokesman in the House, and he was one of the foremost advocates of the payment in "greenbacks" of the government bonds. In 1871 he was a defeated candidate for governor of Massachusetts, and also in 1879 when he ran on the Democratic and Greenback tickets, but in 1882 he was elected by the Democrats who got no other state offices. In 1883 he was defeated on renomination. As presidential nominee of the Greenback and Anti-Monopolist parties, he polled 175,370 votes in 1884, when he had bitterly opposed the nomination by the Democratic party of Grover Cleveland, to defeat whom he tried to "throw" his own votes in Massachusetts and New York to the Republican candidate. His professional income as a lawyer was estimated at \$100,000 per annum shortly before his death at Washington, D.C., on the 11th of January 1893. He was an able but erratic administrator and soldier, and a brilliant lawyer. As a politician he excited bitter opposition, and was charged, apparently with justice, with corruption and venality in conniving at and sharing the profits of illicit trade with the Confederates carried on by his brother at New Orleans and by his brother-in-law in the department of Virginia and North Carolina, while General Butler was in command.

See James Parton, *Butler in New Orleans* (New York, 1863), which, however, deals inadequately with the charges brought against Butler; and *The Autobiography and Personal Reminiscences of Major-General B. F. Butler*; *Butler's Book* (New York, 1893), to be used with caution as regards facts.

BUTLER, CHARLES (1750-1832), British lawyer and miscellaneous writer, was born in London on the 14th of August 1750. He was educated at Douai, and in 1775 entered at Lincoln's Inn. He had considerable practice as a conveyancer, and after the passing of the Roman Catholic Relief Act 1791 was called to the bar. In 1832 he took silk, and was made a bencher of Lincoln's Inn. He died on the 2nd of June in the same year. His literary activity was enormous, and the number of his published works comprises about fifty volumes. The most important of them are the *Reminiscences* (1821-1827); *Horae Biblicae* (1797), which has passed through several editions; *Horae Juridicae Subsecivae* (1804); *Book of the Roman Catholic Church* (1825), which was directed against Southey and excited

some controversy; lives of Erasmus, Grotius, Bossuet, Fénelon. He also edited and completed the *Lives of the Saints* of his uncle, Alban Butler, Fearn's *Essay on Contingent Remainders* and Hargrave's edition of *Coke upon Littleton's Laws of England* (1775).

A complete list of Butler's works is contained in Joseph Gillow's *Bibliographical Dictionary of English Catholics*, vol. i. pp. 357-364.

BUTLER, GEORGE (1774-1853), English schoolmaster and divine, was born in London and educated at Sidney Sussex College, Cambridge, where he afterwards became fellow, in the capacity first of mathematical lecturer, and afterwards of classical tutor. He was elected a public examiner of the university in 1804, and in the following year was one of the select preachers. As head master of Harrow (1805-1829) his all-round knowledge, his tact and his skill as an athlete rendered his administration successful and popular. On his retirement he settled down at Gayton, Northamptonshire, a living which had been presented to him by his college in 1814. In 1836 he became chancellor of the diocese of Peterborough, and in 1842 was appointed dean of Peterborough. His few publications include some notes of Harrow, entitled *Harrow, a Selection of Lists of the School between 1770 and 1828* (Peterborough, 1849).

His eldest son, **GEORGE BUTLER** (1819-1890), was principal of Liverpool College (1866-1882) and canon of Winchester. In 1852 he married Josephine Elizabeth, daughter of John Grey of Dilston. She died on the 30th of December 1906 (see her *Autobiography*, 1909). Mrs Josephine Butler, as she was commonly called afterwards, was a woman of intense moral and spiritual force, who devoted herself to rescue work, and specially to resisting the "state regulation of vice" whether by the C.D. Acts in India or by any system analogous to that of the continent in England.

His youngest son, the Rev. Dr **HENRY MONTAGU BUTLER**, became one of the best-known scholars of his day. Born in 1833, and educated at Harrow and Trinity, Cambridge, he was senior classic in 1855 and was elected a fellow of his college. In 1859 he became head master of Harrow, as his father had been, and only resigned on being made dean of Gloucester in 1885. In 1886 he was elected master of Trinity, Cambridge. His publications include various volumes of sermons, but his reputation rests on his wide scholarship, his remarkable gifts as a public speaker, and his great practical influence both as a headmaster and at Cambridge. He married first (1861), Georgina Elliot, and secondly (1888) Agneta Frances Ramsay (who in 1887 was senior classic at Cambridge), and had five sons and two daughters.

BUTLER, JOSEPH (1692-1752), English divine and philosopher, bishop of Durham, was born at Wantage, in Berkshire, on the 18th of May 1692. His father, a linen-draper of that town, was a Presbyterian, and it was his wish that young Butler should be educated for the ministry in that church. The boy was placed under the care of the Rev. Philip Barton, master of the grammar school at Wantage, and remained there for some years. He was then sent to Samuel Jones's dissenting academy at Gloucester, and afterwards at Tewkesbury, where his most intimate friend was Thomas Secker, who became archbishop of Canterbury.

While at this academy Butler became dissatisfied with the principles of Presbyterianism, and after much deliberation resolved to join the Church of England. About the same time he began to study with care Samuel Clarke's celebrated *Demonstration of the Being and Attributes of God*, which had been published as the Boyle Lectures a few years previously. With great modesty and secrecy Butler, then in his twenty-second year, wrote to the author propounding certain difficulties with regard to the proofs of the unity and omnipresence of the Divine Being. Clarke answered his unknown opponent with a gravity and care that showed his high opinion of the metaphysical acuteness displayed in the objections, and published the correspondence in later editions of the *Demonstration*. Butler acknowledged that Clarke's reply satisfied him on one of the points, and he subsequently gave his adhesion to the other. In one of

his letters we already find the germ of his famous dictum that "probability is the guide of life."

In March 1715 he entered at Oriel College, Oxford, but for some time found it uncongenial and thought of migrating to Cambridge. But he made a close friend in one of the resident fellows, Edward Talbot, son of William Talbot, then bishop of Oxford, and afterwards of Salisbury and Durham. In 1718 he took his degree, was ordained deacon and priest, and on the recommendation of Talbot and Clarke was nominated preacher at the chapel of the Rolls, where he continued till 1726. It was here that he preached his famous *Fifteen Sermons* (1726) including the well-known discourses on human nature. In 1721 he had been given a prebend at Salisbury by Bishop Talbot who on his translation to Durham gave Butler the living of Houghton-le-Skerne in that county, and in 1725 presented him to the wealthy rectory of Stanhope. In 1726 he resigned his priesthood at the Rolls.

For ten years Butler remained in perfect seclusion at Stanhope. He was only remembered in the neighbourhood as a man much loved and respected, who used to ride a black pony very fast, and whose known benevolence was much practised upon by beggars. Archbishop Blackburne, when asked by Queen Caroline whether he was still alive, answered, "He is not dead, madam, but buried." In 1733 he was made chaplain to Lord Chancellor Talbot, elder brother of his dead friend Edward, and in 1736 prebendary of Rochester. In the same year he was appointed clerk of the closet to the queen, and had to take part in the metaphysical conversation parties which she loved to gather round her. He met Berkeley frequently, but in his writings does not refer to him. In 1736 also appeared his great work, *The Analogy of Religion*.

In 1737 Queen Caroline died; on her deathbed she recommended Butler to the favour of her husband. George seemed to think his obligation sufficiently discharged by appointing Butler in 1738 to the bishopric of Bristol, the poorest see in the kingdom. The severe but dignified letter to Walpole, in which Butler accepted the preferment, showed that the slight was felt and resented. Two years later, however, the bishop was presented to the rich deanery of St Paul's, and in 1746 was made clerk of the closet to the king. In 1747 the primacy was offered to Butler, who, it is said, declined it, on the ground that "it was too late for him to try to support a falling church." The story has not the best authority, and though the desponding tone of some of Butler's writings may give it colour, it is not in harmony with the rest of his life, for in 1750 he accepted the see of Durham, vacant by the death of Edward Chandler. His charge to the clergy of the diocese, the only charge of his known to us, is a weighty and valuable address on the importance of external forms in religion. This, together with the fact that over the altar of his private chapel at Bristol he had a cross of white marble, gave rise to an absurd rumour that the bishop had too great a leaning towards Romanism. At Durham he was very charitable, and expended large sums in building and decorating his church and residence. His private expenses were exceedingly small. Shortly after his translation his constitution began to break up, and he died on the 16th of June 1752, at Bath, whither he had removed for his health. He was buried in the cathedral of Bristol, and over his grave a monument was erected in 1834, with an epitaph by Southey. According to his express orders all his MSS. were burned after his death. Bishop Butler was never married. His personal appearance has been sketched in a few lines by Hutchinson:—"He was of a most reverend aspect, his face thin and pale; but there was a divine placidness which inspired veneration, and expressed the most benevolent mind. His white hair hung gracefully on his shoulders, and his whole figure was patriarchal."

Butler was an earnest and deep-thinking Christian, melancholy by temperament, and grieved by what seemed to him the hopelessly irreligious condition of his age. In his view not only the religious life of the nation, but (what he regarded as synonymous) the church itself, was in an almost hopeless state of decay, as we see from his first and only charge to the diocese of Durham and

from many passages in the *Analogy*. And though there was a complete remedy just coming into notice, in the Evangelical revival, it was not of a kind that commended itself to Butler, whose type of mind was opposed to everything that savoured of enthusiasm. He even asked John Wesley, in 1739, to desist from preaching in his diocese of Bristol, and in a memorable interview with the great preacher remarked that any claim to the extraordinary gifts of the Holy Spirit was "a horrid thing, a very horrid thing, sir." Yet Butler was keenly interested in those very miners of Kingswood among whom Wesley preached, and left £500 towards building a church for them. It is a great mistake to suppose that because he took no great part in politics he had no interest in the practical questions of his time, or that he was so immersed in metaphysics as to live in the clouds. His intellect was profound and comprehensive, thoroughly qualified to grapple with the deepest problems of metaphysics, but by natural preference occupying itself mainly with the practical and moral. Man's conduct in life, not his theory of the universe, was what interested him. The *Analogy* was written to counteract the practical mischief which he considered wrought by deists and other freethinkers, and the *Sermons* lay a good deal of stress on everyday Christian duties. His style has frequently been blamed for its obscurity and difficulty, but this is due to two causes: his habit of compressing his arguments into narrow compass, and of always writing with the opposite side of the case in view, so that it has been said of the *Analogy* that it raises more doubts than it solves. One is also often tempted away from the main course of the argument by the care and precision with which Butler formulates small points of detail.

His great work, *The Analogy of Religion, Natural and Revealed, to the Course and Constitution of Nature*, cannot be adequately appreciated unless taken in connexion with the circumstances of the period at which it appeared. It was intended as a defence against the great tide of deistical speculation (see *DEISM*), which in the apprehension of many good men seemed likely to sweep away the restraints of religion and make way for a general reign of licence. Butler did not enter the lists in the ordinary way. Most of the literature evoked by the controversy on either side was devoted to rebutting the attack of some individual opponent. Thus it was Bentley versus Collins, Sherlock versus Woolston, Law versus Tindal. The *Analogy*, on the contrary, did not directly refer to the deists at all, and yet it worked more *à* *vo* *c* with their position than all the other books put together, and remains practically the one surviving landmark of the whole dispute. Its central motive is to prove that all the objections raised against revealed or supernatural religion apply with equal force to the whole constitution of nature, and that the general analogy between the principles of divine government, as set forth by the biblical revelation, and those observable in the course of nature, leads us to the warrantable conclusion that here is one Author of both. Without altogether eschewing Samuel Clarke's *a priori* system, Butler relies mainly on the inductive method, not professing to give an absolute demonstration so much as a probable proof. And everything is brought into closest relation with "that which is the foundation of all our hopes and of all our fears; all our hopes and fears which are of any consideration; I mean a Future Life."

Butler is a typical instance of the English philosophical mind. He will admit no speculative theory of things. To him the universe is no realization of intelligence, which is to be deciphered by human thought: it is a constitution or system, made up of individual facts, rough which we thread our way slowly and inductively. Complete knowledge is impossible; nay, what we call knowledge of any part of the system is inherently imperfect. "We cannot have a thorough knowledge of any part without knowing the whole." So far as experience goes, "to us probability is the very guide of life." Reason certainly is to be accepted; it is our natural light, and the only authority whereby we can judge of things. But it gives no completed system of knowledge and in matters of fact affords only probable conclusions. In this emphatic declaration, that knowledge of the course of nature is merely probable, Butler is at one with Hume, who was a most diligent student of the bishop's works. What can be nearer Hume's celebrated maxim—"Anything may be the use of anything else," than Butler's conclusion, "so that any one

thing whatever may, for aught we know to the contrary, be a necessary condition to any other?"

It is this strong grasp of the imperfect character of our knowledge of nature and of the grounds for its limitation that makes Butler so formidable an opponent to his deistical contemporaries. He will permit no anticipations of nature, no *a priori* construction of experience. "The constitution of nature is as it is," and no system of abstract principles can be allowed to take its place. He is willing with Hume to take the course of experience as the basis of his reasoning, seeing that it is common ground for himself and his antagonists. In one essential respect, however, he goes beyond Hume. The course of nature is for him an unmeaning expression, unless it be referred to some author; and he therefore makes extensive use of the teleological method. This position is assumed throughout the treatise, and as against the deists with justice, for their whole argument rested upon the presupposition of the existence of God, the perfect Ruler of the world.

The premises, then, with which Butler starts are the existence of God, the known course of nature, and the necessary limitation of our knowledge. What does he wish to prove? It is not his intention to prove God's perfect moral government over the world or the truth of religion. His work is in no sense a philosophy of religion. His purpose is entirely defensive; he wishes to answer objections that have been brought against religion, and to examine certain difficulties that have been alleged as insuperable. And this is to be effected in the first place by showing that from the obscurities and inexplicabilities we meet with in nature we may reasonably expect to find similar difficulties in the scheme of religion. If difficulties be found in the course and constitution of nature, whose author is admitted to be God, surely the existence of similar difficulties in the plan of religion can be no valid objection against its truth and divine origin. That this is at least in great part Butler's object is plain from the slightest inspection of his work. It has seemed to many to be an unsatisfactory mode of arguing and but a poor defence of religion; and so much the author is willing to allow. But in the general course of his argument a somewhat wider issue appears. He seeks to show not only that the difficulties in the systems of natural and revealed religion have counterparts in nature, but also that the facts of nature, far from being adverse to the principles of religion, are a distinct ground for inferring their probable truth. He endeavours to show that the balance of probability is entirely in favour of the scheme of religion, that this probability is the natural conclusion from an inspection of nature, and that, as religion is a matter of practice, we are bound to adopt the course of action which is even probably the right one. If, we may imagine him saying, the precepts of religion are entirely analogous in their partial obscurity and apparent difficulty to the ordinary course of nature disclosed to us by experience, then it is credible that these precepts are true; not only can no objections be drawn against them from experience, but the balance of probability is in their favour. This mode of reasoning from what is known of nature to the probable truth of what is contained in religion is the celebrated method of analogy.

Although Butler's work is peculiarly one of those which ought not to be exhibited in outline, for its strength lies in the organic completeness with which the details are wrought into the whole argument, yet a summary of his results will throw more light on the method than any description can.

Keeping clearly in view his premises—the existence of God and the limited nature of knowledge—Butler begins by inquiring into the fundamental pre-requirement of all natural religion—the immortality of the soul. Evidently the stress of the whole question is here. Were man not immortal, religion would be of little value. Now, Butler does not attempt to prove the truth of the doctrine; that proof comes from another quarter. The only questions he asks are—Does experience forbid us to admit immortality as a possibility? Does experience furnish any probable reason for inferring that immortality is a fact? To the first of these a negative, to the second an affirmative answer is returned. All the analogies of our life here lead us to conclude that we shall continue to live after death; and neither from experience nor from the reason of the thing can any argument against the possibility of this be drawn. Immortality, then, is not unreasonable; it is probable. If, he continues, we are to live after death, it is of importance for us to consider on what our future state may depend; for we may be either happy or miserable. Now, whatever speculation may say as to God's purpose being necessarily universal benevolence, experience plainly shows us that our present happiness and misery depend upon our conduct, and are not distributed indiscriminately. Therefore no argument can be brought from experience against the possibility of our future happiness and misery likewise depending upon conduct. The whole analogy of nature is in favour of such a dispensation; it is therefore reasonable or probable. Further, we are not only under a government in which actions considered simply as such are rewarded and punished, but it is known from experience that virtue and vice are followed by their natural consequences—happiness and misery. And though the distribution of these rewards is not perfect, all hindrances are plainly temporary or accidental. It may therefore be concluded that the balance of probability is in favour of God's government in general being a moral scheme, where virtue and vice are respectively rewarded and punished. It need not be objected to the justice of

this arrangement that men are sorely tempted, and may very easily be brought to neglect that on which their future welfare depends, for the very same holds good in nature. Experience shows man to be in a state of trial so far as regards the present; it cannot, therefore, be unreasonable to suppose that we are in a similar state as regards the future. Finally, it can surely never be advanced as an argument against the truth of religion that there are many things in it which we do not comprehend, when experience exhibits to us such a copious stock of incomprehensibilities in the ordinary course and constitution of nature.

It cannot have escaped observation, that in the foregoing course of argument the conclusion is invariably from experience of the present order of things to the reasonableness or probability of some other system—of a future state. The inference in all cases passes beyond the field of experience; that it does so may be and has been advanced as a conclusive objection against it. See for example a passage in Hume, *Works* (ed. 1854), iv. 161-162, cf. p. 160, which says, in short, that no argument from experience can ever carry us beyond experience itself. However well grounded this reasoning may be, it altogether misses the point at which Butler aimed, and is indeed a misconception of the nature of analogical argument. Butler never attempts to *prove* that a future life regulated according to the requirements of ethical law is a reality; he only desires to show that the conception of such a life is not irreconcilable with what we know of the course of nature, and that consequently it is *not unreasonable* to suppose that there is such a life. Hume readily grants this much, though he hints at a formidable difficulty which the plan of the *Analogy* prevented Butler from facing, the proof of the existence of God. Butler seems willing to rest satisfied with his opponents' admission that the being of God is proved by reason, but it would be hard to discover how, upon his own conception of the nature and limits of reason, such a proof could ever be given. It has been said that it is no flaw in Butler's argument that he has left atheism as a possible mode of viewing the universe, because his work was not directed against the atheists. It is, however, in some degree a defect; for his defence of religion against the deists rests on a view of reason which would for ever preclude a demonstrative proof of God's existence.

If, however, his premises be granted, and the narrow issue kept in view, the argument may be admitted as perfectly satisfactory. From what we know of the present order of things, it is not unreasonable to suppose that there will be a future state of rewards and punishments, distributed according to ethical law. When the argument from analogy seems to go beyond this, a peculiar difficulty starts up. Let it be granted that our happiness and misery in this life depend upon our conduct—are, in fact, the rewards and punishments attached by God to certain modes of action, the natural conclusion from analogy would seem to be that our future happiness or the reverse will probably depend upon our actions in the future state. Butler, on the other hand, seeks to show that analogy leads us to believe that our future state will depend upon our present conduct. His argument, that the punishment of an imprudent act often follows after a long interval may be admitted, but does not advance a single step towards the conclusion that imprudent acts will be punished hereafter. So, too, with the attempt to show that from the analogy of the present life we may not unreasonably infer that virtue and vice will receive their respective rewards and punishments hereafter; it may be admitted that virtuous and vicious acts are naturally looked upon as objects of reward or punishment, and treated accordingly, but we may refuse to allow the argument to go further, and to infer a perfect distribution of justice dependent upon our conduct here. Butler could strengthen his argument only by bringing forward prominently the absolute requirements of the ethical consciousness, in which case he would have approximated to Kant's position with regard to this very problem. That he did not do so is, perhaps, due to his strong desire to use only such premises as his adversaries the deists were willing to allow.

As against the deists, however, he may be allowed to have made out his point, that the substantial doctrines of natural religion are not opposed to reason and experience, and may be looked upon as credible. The positive proof of them is to be found in revealed religion, which has disclosed to us not only these truths, but also a further scheme not discoverable by the natural light. Here, again, Butler joins issue with his opponents. Revealed religion had been declared to be nothing but a republication of the truths of natural religion (Matthew Tindal, *Christianity as Old as the Creation*), and all revelation had been objected to as impossible. To show that such objections are invalid, and that a revelation is at least not impossible, Butler makes use mainly of his doctrine of human ignorance. Revelation had been rejected because it lay altogether beyond the sphere of reason and could not therefore be grasped by human intelligence. But the same is true of nature; there are in the ordinary course of things inexplicabilities; indeed we may be said with truth to know nothing, for there is no medium between perfect and completed comprehension of the whole system of things, which we manifestly have not, and mere faith grounded on probability. Is it unreasonable to suppose that in a revealed system there should be the same superiority to our intelligence? If we cannot explain or foretell by reason what the exact course of events in nature will be, is it to be expected that we can do so with regard to the wider

scheme of God's revealed providence? Is it not probable that there will be many things not explicable by us? From our experience of the course of nature it would appear that no argument can be brought against the possibility of a revelation. Further, though it is the province of reason to test this revealed system, and though it be granted that, should it contain anything immoral, it must be rejected, yet a careful examination of the particulars will show that there is no incomprehensibility or difficulty in them which has not a counterpart in nature. The whole scheme of revealed principles is, therefore, not unreasonable, and the analogy of nature and natural religion would lead us to infer its truth. If, finally, it be asked, how a system professing to be revealed can substantiate its claims, the answer is, by means of the historical evidences, such as miracles and fulfilment of prophecy.

It would be unfair to Butler's argument to demand from it answers to problems which had not in his time arisen, and to which, even if they had then existed, the plan of his work would not have extended. Yet it is at least important to ask how far, and in what sense, the *Analogy* can be regarded as a positive and valuable contribution to theology. What that work has done is to prove to the consistent deist that objections can be drawn from reason or experience against natural or revealed religion, and, consequently, that the things objected to are not incredible and may be proved by external evidence. But the deism of the 17th century is a phase of thought that has no living reality now, and the whole aspect of the religious problem has been completely changed. To a generation that has been moulded by the philosophy of Kant and Hegel, by the historical criticism of modern theology, and by all that has been done in the field of comparative religion, the argument of the *Analogy* cannot but appear to lie quite outside the field of controversy. To Butler the Christian religion, and by that he meant the orthodox Church of England system, was a moral scheme revealed by a special act of the divine providence, the truth of which was to be judged by the ordinary canons of evidence. The whole stood or fell on historical grounds. A speculative construction of religion was abhorrent to him, a thing of which he seems to have thought the human mind naturally incapable. The religious consciousness does not receive from him the slightest consideration. The *Analogy*, in fact, has and can have but little influence on the present state of theology; it was not a book for all time, but was limited to the problems of the period at which it appeared.

Throughout the whole of the *Analogy* it is manifest that the interest which lay closest to Butler's heart was the ethical. His whole cast of thinking was practical. The moral nature of man, his conduct in life, is that on account of which alone an inquiry into religion is of importance. The systematic account of this moral nature is to be found in the famous *Sermons preached at the Chapel of the Rolls*, especially in the first three. In these sermons Butler has made substantial contributions to ethical science, and it may be said with confidence, that in their own department nothing superior in value appeared during the long interval between Aristotle and Kant. To both of these great thinkers he has certain analogies. He resembles the first in his method of investigating the end which human nature is intended to realize; he reminds of the other by the consistency with which he upholds the absolute supremacy of moral law.

In his ethics, as in his theology, Butler had constantly in view a certain class of adversaries, consisting partly of the philosophic few, partly of the fashionably educated many, who all participated in one common mode of thinking. The keynote of this tendency had been struck by Hobbes, in whose philosophy man was regarded as a mere selfish sensitive machine, moved solely by pleasures and pains. Cudworth and Clarke had tried to place ethics on a nobler footing, but their speculations were too abstract for Butler and not sufficiently "applicable to the several particular relations and circumstances of life."

His inquiry is based on teleological principles. "Every work, both of nature and art, is a system; and as every particular thing both natural and artificial is for some use or purpose out of or beyond itself, one may add to what has been already brought into the idea of a system its conduciveness to this one or more ends." Ultimately this view of nature, as the sphere of the realization of final causes, rests on a theological basis; but Butler does not introduce prominently into his ethics the specifically theological groundwork, and may be thought willing to ground his principle on experience. The ethical question then is, as with Aristotle, what is the *telos* of man? The answer to this question is to be obtained by an analysis of the facts of human nature, whence, Butler thinks, "it will as fully appear that this our nature, i.e. constitution, is adapted to virtue, as from the idea of a watch it appears that its nature, i.e. constitution or system, is adapted to measure time." Such analysis had been already attempted by Hobbes, and the result he came to was that man naturally is adapted only for a life of selfishness,—his end is the procuring of pleasure and the avoidance of pain. A closer examination, however, shows that this at least is false. The truth of the counter propositions, that man is *per se* benevolent, that the full development of his being is impossible apart from society, becomes manifest on examination of the facts. For while self-love plays a most important part in the human economy, there is no less evidently a natural principle of benevolence. Moreover, among the particular

passions, appetites and desires there are some whose tendency is as clearly towards the general good as that of others is towards the satisfaction of the self. Finally, that principle in man which reflects upon actions and the springs of actions, unmistakably sets the stamp of its approbation upon conduct that tends towards the general good. It is clear, therefore, that from this point of view the sum of practical morals might be given in Butler's own words—"that mankind is a community, that we all stand in a relation to each other, that there is a public end and interest of society, which each particular is obliged to promote." But deeper questions remain.

The threefold division into passions and affections, self-love and benevolence, and conscience, is Butler's celebrated analysis of human nature as found in his first sermon. But by regarding benevolence less as a definite desire for the general good as such than as kind affection for particular individuals, he practically eliminates it as a regulative principle and reduces the authorities in the polity of the soul to two—conscience and self-love.

But the idea of human nature is not completely expressed by saying that it consists of reason and the several passions. "Whoever thinks it worth while to consider this matter thoroughly should begin by stating to himself exactly the ideas of a system, economy or constitution of any particular nature; and he will, I suppose, find that it is one or a whole, made up of several parts, but yet that the several parts, even considered as a whole, do not complete the idea, unless in the notion of a whole you include the relations and respects which these parts have to each other." This fruitful conception of man's ethical nature as an organic unity Butler owes directly to Shaftesbury and indirectly to Aristotle; it is the strength and clearness with which he has grasped it that gives peculiar value to his system.

The special relation among the parts of our nature to which Butler alludes is the subordination of the particular passions to the universal principle of reflection or conscience. This relation is the peculiarity, the *cross*, of man; and when it is said that virtue consists in following nature, we mean that it consists in pursuing the course of conduct dictated by this superior faculty. Man's function is not fulfilled by obeying the passions, or even cool self-love, but by obeying conscience. That conscience has a natural supremacy, that it is superior in kind, is evident from the part it plays in the moral constitution. We judge a man to have acted wrongly, *i. e.* unnaturally, when he allows the gratification of a passion to injure his happiness, *i. e.* when he acts in accordance with passion and against self-love. It would be impossible to pass this judgment if self-love were not regarded as superior in kind to the passions, and this superiority results from the fact that it is the peculiar province of self-love to take a view of the several passions and decide as to their relative importance. But there is in man a faculty which takes into consideration all the springs of action, including self-love, and passes judgment upon them, approving some and condemning others. From its very nature this faculty is supreme in authority, if not in power; it reflects upon all the other active powers, and pronounces absolutely upon their moral quality. Superiority and authority are constituent parts of its very idea. We are under obligation to obey the law revealed in the judgments of this faculty, for it is the law of our nature. And to this a religious sanction may be added, for "consciousness of a rule or guide of action, in creatures capable of considering it as given them by their Maker, not only raises immediately a sense of duty, but also a sense of security in following it, and a sense of danger in deviating from it." Virtue then consists in following the true law of our nature, that is, conscience. Butler, however, is by no means very explicit in his analysis of the functions to be ascribed to conscience. He calls it the Principle of Reflection, the Reflex Principle of Approbation, and assigns to it as its province the motives or propensities to action. It takes a view of these, approves or disapproves, impels to or restrains from action. But at times he uses language that almost compels one to attribute to him the popular view of conscience as passing its judgments with unerring certainty on individual acts. Indeed his theory is weakest exactly at the point where the real difficulty begins. We get from him no satisfactory answer to the inquiry, What course of action is approved by conscience? Every one, he seems to think, knows what virtue is, and a philosophy of ethics is complete if it can be shown that such a course of action harmonizes with human nature. When pressed still further, he points to justice, veracity and the common good as comprehensive ethical ends. His whole view of the moral government led him to look upon human nature and virtue as connected by a sort of pre-established harmony. His ethical principle has in it no possibility of development into a system of actual duties; it has no content. Even on the formal side it is a little difficult to see what part conscience plays. It seems merely to set the stamp of its approbation on certain courses of action to which we are led by the various passions and affections; it has in itself no originating power. How or why it approves of some and not of others is left unexplained. Butler's moral theory, like those of his English contemporaries and successors, is defective from not perceiving that the action of duty can have real significance only when connected with the will or practical reason, and that only in reason which will itself have as a principle capable of development into an ethical system. It has received very small consideration at the hands of German historians of ethics.

AUTHORITIES.—See T. Bartlett, *Memoirs of Butler* (1839). The standard edition of Butler's works is that in 2 vols. (Oxford, 1844). Editions of the *Analogy* are very numerous; that by Bishop William Fitzgerald (1849) contains a valuable Life and Notes. W. Whewell published an edition of the *Three Sermons*, with Introduction. Modern editions of the *Works* are those by W. E. Gladstone (2 vols. with a 3rd vol. of *Studies Subsidiary*, 1896), and J. H. Bernard, (2 vols. in the English Theological Library, 1900). For the history of the religious works contemporary with the *Analogy*, see Lechler, *Gesch. d. Engl. Deismus*; M. Pattison, in *Essays and Reviews*; W. Hunt, *Religious Thought in England*, vols. ii. and iii.; L. Stephen, *English Thought in the 18th Century*; J. H. Overton and F. Relton, *The English Church from the Accession of George I. to the End of the 18th Century*. (R. Ad.; A. J. G.)

BUTLER, NICHOLAS MURRAY (1862—), American educator, was born at Elizabethtown, New Jersey, on the 2nd of April 1862. He graduated at Columbia College in 1882, was a graduate fellow in philosophy there from 1882 to 1884, when he took the degree of Ph. D., and then studied for a year in Paris and Berlin. He was an assistant in philosophy at Columbia in 1885-1886, tutor in 1886-1889, adjunct professor of philosophy, ethics and psychology in 1889-1890, becoming full professor in 1890, and dean of the faculty of philosophy in 1890-1902. From 1887 until 1891 he was the first president of the New York college for the training of teachers (later the Teachers' College of Columbia University), which he had personally planned and organized. In 1891 he founded and afterwards edited the *Educational Review*, an influential educational magazine. He soon came to be looked upon as one of the foremost authorities on educational matters in America, and in 1894 was elected president of the National Educational Association. He was also a member of the New Jersey state board of education from 1887 to 1895, and was president of the Paterson (N.J.) board of education in 1892-1893. In 1901 he succeeded Seth Low as president of Columbia University. Besides editing several series of books, including "The Great Educators" and "The Teachers' Professional Library," he published *The Meaning of Education* (1898), a collection of essays; and two series of addresses, *True and False Democracy* (1907), and *The American as he is* (1908).

BUTLER (OR BOTTLER), SAMUEL (1612-1680), English poet, author of *Hudibras*, son of Samuel Butler, a small farmer, was baptized at Strensham, Worcestershire, on the 8th of February 1612. He was educated at the King's school, Worcester, under Henry Bright, the record of whose zeal as a teacher is preserved by Fuller (*Worthies*, Worcestershire). After leaving school he served a Mr Jeffereys of Earl's Croome, Worcestershire, in the capacity of justice's clerk, and is supposed to have thus gained his knowledge of law and law terms. He also employed himself at Earl's Croome in general study, and particularly in painting, which he is said to have thought of adopting as a profession. It is probable, however, that art has not lost by his change of mind, for, according to one of his editors, in 1774 his pictures "served to stop windows and save the tax; indeed they were not fit for much else." He was then recommended to Elizabeth, countess of Kent. At her home at Wrest, Bedfordshire, he had access to a good library, and there too he met Selden, who sometimes employed him as his secretary. But his third sojourn, with Sir Samuel Luke at Cople Hoo, Bedfordshire, was not only apparently the longest, but also much the most important in its effects on his career and works. We are nowhere informed in what capacity Butler served Sir Samuel Luke, or how he came to reside in the house of a noted Puritan and Parliament man. In the family of this "valiant Mamluke," who, whether he was or was not the original of Hudibras, was certainly a rigid Presbyterian, "a colonel in the army of the Parliament, scoutmaster-general for Bedfordshire and governor of Newport Pagnell," Butler must have had the most abundant opportunities of studying from the life those who were to be the victims of his satire; he is supposed to have taken some hints for his caricature from Sir Henry Rosewell of Ford Abbey, Devonshire. But we know nothing positive of him until the Restoration, when he was appointed secretary to Richard Vaughan, 2nd earl of Carbery, lord president of the principality of Wales, who made him steward of Ludlow Castle, an office which he held from January 1661

to January 1662. About this time he married a rich lady, variously described as a Miss Herbert and as a widow named Morgan. His wife's fortune was afterwards, however, lost.

Early in 1663 *Hudibras: The First Part: written in the Time of the Late Wars*, was published, but this, the first genuine edition, had been preceded in 1662 by an unauthorized one. On the 26th of December Pepys bought it, and though neither then nor afterwards could he see the wit of "so silly an abuse of the Presbyter knight going to the wars," he repeatedly testifies to its extraordinary popularity. A spurious second part appeared within the year. This determined the poet to bring out the second part (licensed on the 7th of November 1663, printed 1664), which if possible exceeded the first in popularity. From this time till 1678, the date of the publication of the third part, we hear nothing certain of Butler. On the publication of *Hudibras* he was sent for by Lord Chancellor Hyde (Clarendon), says Aubrey, and received many promises, none of which was fulfilled. He is said to have received a gift of £300 from Charles II., and to have been secretary to George Villiers, 2nd duke of Buckingham, when the latter was chancellor of the university of Cambridge. Most of his biographers, in their eagerness to prove the ill-treatment which Butler is supposed to have received, disbelieve both these stories, perhaps without sufficient reason. Butler's satire on Buckingham in his *Characters (Remains, 1759)* shows such an intimate knowledge that it is probable the second story is true. Two years after the publication of the third part of *Hudibras* he died, on the 25th of September 1680, and was buried by his friend Longueville, a bencher of the Middle Temple, in the churchyard of St Paul's, Covent Garden. He was, we are told, "of a leonine-coloured hair, sanguine, choleric, middle-sized, strong." A portrait by Lely at Oxford and others elsewhere represent him as somewhat hard-featured.

Of the neglect of Butler by the court something must be said. It must be remembered that the complaints on the subject supposed to have been uttered by the poet all occur in the spurious posthumous works, that men of letters have been at all times but too prone to complain of lack of patronage, that Butler's actual service was rendered when the day was already won, and that the pathetic stories of the poet starving and dying in want are contradicted by the best authority—Charles Longueville, son of the poet's friend—who asserted that Butler, though often disappointed, was never reduced to anything like want or beggary and did not die in any person's debt. But the most significant notes on the subject are Aubrey's,¹ that "he might have had preferments at first, but would not accept any but very good, so at last he had none at all, and died in want"; and the memorandum of the same author, that "satirical wits disoblige whom they converse with, &c., consequently make to themselves many enemies and few friends, and this was his manner and case."

Three monuments have been erected to the poet's memory—the first in Westminster Abbey in 1721, by John Barber, mayor of London, who is spitefully referred to by Pope for daring to connect his name with Butler's. In 1786 a tablet was placed in St Paul's, Covent Garden, by residents of the parish. This was destroyed in 1845. Later, another was set up at Strensham by John Taylor of that place. Perhaps the happiest epitaph on him is one by John Dennis, which calls Butler "a whole species of poets in one."

Hudibras itself, though probably quoted as often as ever, has dropped into the class of books which are more quoted than read. In reading it, it is of the utmost importance to comprehend clearly and to bear constantly in mind the purpose of the author in writing it. This purpose is evidently not artistic but polemic, to show in the most unmistakable characters the villainy and folly of the anti-royalist party. Anything like a regular plot—the absence of which has often been deplored or excused—would have been for this end not merely a superfluity but a mistake, as likely to divert the attention and perhaps even enlist some sympathy for the heroes. Anything like regular character-drawing would have been equally unnecessary and dangerous—

¹ *Letters written by Eminent Persons . . . and Lives of Eminent Men*, by John Aubrey, Esq. (2 vols., 1813).

for to represent anything but monsters, some alleviating strokes must have been introduced. The problem, therefore, was to produce characters just sufficiently unlike lay-figures to excite and maintain a moderate interest, and to set them in motion by dint of a few incidents not absolutely unconnected,—meanwhile to subject the principles and manners of which these characters were the incarnation to ceaseless satire and railery. The triumphant solution of the problem is undeniable, when it has once been enunciated and understood. Upon a canvas thus prepared and outlined, Butler has embroidered a collection of flowers of wit, which only the utmost fertility or imagination could devise, and the utmost patience of industry elaborate. In the union of these two qualities he is certainly without a parallel, and their combination has produced a work which is unique. The poem is of considerable length, extending to more than ten thousand verses, yet Hazlitt hardly exaggerates when he says that "half the lines are got by heart"; indeed a diligent student of later English literature has read great part of *Hudibras* though he may never have opened its pages. The tableaux or situations, though few and simple in construction, are ludicrous enough. The knight and squire setting forth on their journey; the routing of the bear-baiters; the disastrous renewal of the contest; Hudibras and Ralph in the stocks; the lady's release and conditional acceptance of the unlucky knight; the latter's deliberations on the means of eluding his vow; the Skimmington; the visit to Sidrophel, the astrologer; the attempt to cajole the lady, with its woeful consequences; the consultation with the lawyer, and the immortal pair of letters to which this gives rise, complete the argument of the whole poem. But the story is as nothing; throughout we have little really kept before us but the sordid vices of the sectaries, their hypocrisy, their childish ungraciousness, their greed of money and authority, their fast and loose morality, their inordinate pride. The extraordinary felicity of the means taken to place all these things in the most ridiculous light has never been questioned. The doggerel metre, never heavy or coarse, but framed as to be the very voice of mocking laughter, the astounding similes and disparates, the rhymes which seem to chuckle and to sneer of themselves, the wonderful learning with which the abuse of learning is rebuked, the subtlety with which subtle casuistry is set at naught can never be missed. Keys like those of L'Estrange are therefore of little use. It signifies nothing whether Hudibras was Sir Samuel Luke of Bedfordshire or Sir Henry Rosewell of Devonshire, still less whether Ralph's name in the flesh was Robinson or Pendle, least of all that Orsin was perhaps Mr Gosling, or Trulla possibly Miss Spencer. Butler was probably as little indebted to mere copying for his characters as for his ideas and style. These latter are in the highest degree original. The first notion of the book, and only the first notion, Butler undoubtedly received from *Don Quixote*. His obligations to the *Satyre Ménippée* have been noticed by Voltaire, and though English writers have sometimes ignored or questioned them, are not to be doubted. The art, perhaps the most terrible of all the weapons of satire, of making characters without any great violation of probability represent themselves in the most atrocious and despicable light, was never perhaps possessed in perfection except by Pithou and his colleagues and by Butler. Against these great merits some defects must certainly be set. As a whole, the poem is no doubt tedious, if only on account of the very blaze of wit, which at length almost wearies us by its ceaseless demands on our attention. It should, however, be remembered that it was originally issued in parts, and therefore, it may be supposed, intended to be read in parts, for there can be little doubt that the second part was written before the first was published. A more real defect, but one which Butler shares with all his contemporaries, is the tendency to delineate humorous instead of characters, and to draw from the outside rather than from within.

Attempts have been made to trace the manner and versification of *Hudibras* to earlier writers, especially in Cleveland's satires and in the *Musarum Delicias* of Sir John Mennis (Pepys's Minnes) and Dr James Smith (1605-1667). But if it had few

ancestors it had an abundant offspring. A list of twenty-seven direct imitations of *Hudibras* in the course of a century may be found in the Aldine edition (1893). Complete translations of considerable excellence have been made into French (London, 1757 and 1819) by John Townley (1697-1782), a member of the Irish Brigade; and into German by D. W. Soltau (Riga, 1787); specimens of both may be found in R. Bell's edition. Voltaire tried his hand at a compressed version, but not with happy results.

BIBLIOGRAPHY.—Butler's works published during his life include, besides *Hudibras*: *To the Memory of the most renowned Du Vall: A Pindaric Ode* (1671); and a prose pamphlet against the Puritans, *Two Letters, one from J. Audand . . . to W. Prynne, the other Prynne's Answer* (1672). In 1715-1717 three volumes, entitled *Posthumous Works in Prose and Verse . . . with a key to Hudibras by Sir Roger l'Estrange*, were published with great success. Most of the contents, however, are generally rejected as spurious. The poet's papers, now in the British Museum (Addit. MSS. 32,625-6), remained in the hands of his friend William Longueville, and after his death were left untouched until 1759, when Robert Thyer, keeper of the public library at Manchester, edited two volumes of verse and prose under the title of *Genuine Remains in Verse and Prose of Mr Samuel Butler*. This collection contained *The Elephant in the Moon*, a satire on the Royal Society; a series of sketches in prose, *Characters*; and some satirical poems and prose pamphlets. Another edition, *Poetical Remains*, was issued by Thyer in 1827. In 1726 Hogarth executed some illustrations to *Hudibras*, which are among his earliest but not, perhaps, his happiest productions. In 1744 Dr Zachary Grey published an edition of *Hudibras*, with copious and learned annotations; and an additional volume of *Critical and Historical and Explanatory Notes* in 1752. Grey's has formed the basis of all subsequent editions.

Other pieces published separately and ascribed to Butler are: *A Letter from Mercurius Cincicus to Mercurius Rusticus, or London's Confession but not repentance . . .* (1643), represented in vol. iv. of Somers's tracts; *Mala Asinarum, or the unreasonable and insupportable burthen now pressed . . . upon this groaning nation . . .* (1659), included in his posthumous works, which is supposed to have been written by John Prynne, though Wood ascribes it to Butler; *The Acts and monuments of our late parliament . . .* (1659, printed 1710), of which a continuation appeared in 1659; a "character" of Charles I. (1671); *A New Ballad of King Edward and Jane Shore . . .* (1671); *A Congratulatory poem . . . to Sir Joseph Sheldon . . .* (1675); *The Geneva Ballad, or the occasional conformist display'd* (1674); *The Secret history of the Calves head club, complete . . .* (4th edition, 1707); *The Morning's Salvation, or a friendly conference between a parian preacher and a family of his flock* (reprinted, Dublin, 1714). Two tracts of his appear in Somers's tracts, vol. vii.; he contributed to *Ovid's Epistles translated by several hands* (1680); and works by him are included in *Miscellaneous works, written by . . . George Duke of Buckingham . . . also State Poems . . .* (by various hands) (1704); and in *The Grove . . .* (1721), a poetic miscellany, is a "Satyr against Marriage," not found in his works.

The life of Butler was written by an anonymous author, said by William Oldys to be Sir James Astrey, and prefixed to the edition of 1704. The writer professes to supplement and correct the notice given by Anthony à Wood in *Athenae Oxonienses*. Dr Threadneedle Russel Nash, a Worcestershire antiquarian, supplied some additional facts in an edition of 1793. See the Aldine edition of the *Poetical Works of Samuel Butler* (1893), edited by Reginald Brimley Johnson, with complete bibliographical information. There is a good reprint of *Hudibras* (edited by Mr A. R. Waller, 1905) in the *Cambridge Classics*.

BUTLER, SAMUEL (1774-1830), English classical scholar and schoolmaster, and bishop of Lichfield, was born at Kenilworth on the 30th of January 1774. He was educated at Rugby, and in 1792 went to St John's College, Cambridge. Butler's classical career was a brilliant one. He obtained three of Sir William Browne's medals, for the Latin (1792) and Greek (1793, 1794) odes, the medal for the Greek ode in 1792 being won by Samuel Taylor Coleridge. In 1793 Butler was elected to the Craven scholarship, amongst the competitors being John Keate, afterwards headmaster of Eton, and Coleridge. In 1796 he was fourth senior optime and senior chancellor's classical medalist. In 1797 and 1798 he obtained the members' prize for Latin essay. He took the degree of B.A. in 1796, M.A. 1799, and D.D. 1811. In 1797 he was elected a fellow of St John's, and in 1798 became headmaster of Shrewsbury school. In 1802 he was presented to the living of Kenilworth, in 1807 to a prebendal stall in Lichfield cathedral, and in 1822 to the archdeaconry of Derby; all these appointments he held with his headmastership, but in 1836 he was promoted to the bishopric of Lichfield (and Coventry,

which was separated from his diocese in the same year). He died on the 4th of December 1839. It is in connexion with Shrewsbury school that Butler will be chiefly remembered. During his headmastership its reputation greatly increased, and in the standard of its scholarship it stood as high as any other public school in England. His edition of Aeschylus, with the text and notes of Stanley, appeared 1809-1816, and was somewhat severely criticized in the *Edinburgh Review*, but Butler was prevented by his elevation to the episcopate from revising it. He also wrote a *Sketch of Modern and Ancient Geography* (1813, frequently reprinted) for use in schools, and brought out atlases of ancient and modern geography. His large library included a fine collection of Aldine editions and Greek and Latin MSS.; the Aldines were sold by auction, the MSS. purchased by the British Museum.

Butler's life has been written by his grandson, Samuel Butler, author of *Erewhon* (*Life and Letters of Dr Samuel Butler*, 1896); see also Baker's *History of St John's College, Cambridge* (ed. J. E. B. Mayor, 1869); Sandys, *Hist. Class. Schol.* (ed. 1908), vol. iii. p. 398.

BUTLER, SAMUEL (1835-1902), English author, son of the Rev. Thomas Butler, and grandson of the foregoing, was born at Langar, near Bingham, Nottinghamshire, on the 4th of December 1835. He was educated at Shrewsbury school, and at St John's College, Cambridge. He took a high place in the classical tripos of 1858, and was intended for the Church. His opinions, however, prevented his carrying out this intention, and he sailed to New Zealand in the autumn of 1859. He owned a sheep run in the Upper Rangitata district of the province of Canterbury, and in less than five years was able to return home with a moderate competence, most of which was afterwards lost in unlucky investments. The Rangitata district supplied the setting for his romance of *Erewhon, or Over the Range* (1872), satirizing the Darwinian theory and conventional religion. *Erewhon* had a sequel thirty years later (1901) in *Erewhon Revisited*, in which the narrator of the earlier romance, who had escaped from Erewhon in a balloon, finds himself, on revisiting the country after a considerable interval, the object of a topsyturvy cult, to which he gave the name of "Sunchildism." In 1873 he had published a book of similar tendency, *The Fair Haven*, which purported to be a "work in defence of the miraculous element in our Lord's ministry upon earth" by a fictitious J. P. Owen, of whom he wrote a memoir. Butler was a man of great versatility, who pursued his investigations in classical scholarship, in Shakespearian criticism, biology and art with equal independence and originality. On his return from New Zealand he had established himself at Clifford's Inn, and studied painting, exhibiting regularly in the Academy between 1868 and 1876. But with the publication of *Life and Habit* (1877) he began to recognize literature as his life work. The book was followed by three others, attacking Darwinism—*Evolution Old and New, or the Theories of Buffon, Dr Erasmus Darwin and Lamarck as compared with that of Mr C. Darwin* (1879); *Unconscious Memory* (1880), a comparison between the theory of Dr E. Hering and the *Philosophy of the Unconscious* of Dr E. von Hartmann; and *Luck or Cunning* (1886). He had a thorough knowledge of northern Italy and its art. In *Ex Voto* (1888) he introduced many English readers to the art of Tabacchetti and Gaudenzio Ferrari at Varallo. He learnt nearly the whole of the *Iliad* and the *Odyssey* by heart, and translated both poems (1898 and 1900) into colloquial English prose. In his *Autographs of the Odyssey* (1897) he propounded two theories: that the poem was the work of a woman, who drew her own portrait in Nausicaa; and that it was written at Trapani, in Sicily, a proposition which he supported by elaborate investigations on the spot. In another book on the *Shakespearean Sonnets* (1899) he aimed at destroying the explanations of the orthodox commentators.

Butler was also a musician, or, as he called himself, a Handelian, and in imitation of the style of Handel he wrote in collaboration with H. Festing Jones a secular oratorio, *Narcissus* (1888), and had completed his share of another, *Ulysses*, at the time of his death on the 18th of June 1902. His other works include: *Life and Letters* (1896) of Dr Samuel Butler, his

grandfather, headmaster of Shrewsbury school and afterwards bishop of Lichfield; *Alps and Sanctuaries* (1881); and two posthumous works edited by R. A. Streatfeild, *The Way of All Flesh* (1903), a novel; and *Essays on Life, Art and Science* (1904). See *Samuel Butler, Records and Memorials* (1903), by R. A. Streatfeild, a collection printed for private circulation, the most important article included being one by H. Festing Jones originally published in *The Eagle* (Cambridge, December 1902).

BUTLER, WILLIAM ARCHER (1814-1848), Irish historian of philosophy, was born at Annerville, near Clonmel in Ireland, probably in 1814. His father was a Protestant, his mother a Roman Catholic, and he was brought up as a Catholic. As a boy he was imaginative and poetical, and some of his early verses were remarkable. While yet at Clonmel school he became a Protestant. Later he entered Trinity College, Dublin, where he had a brilliant career. He specially devoted himself to literature and metaphysics, and was noted for the beauty of his style. In 1834 he gained the ethical moderatorship, newly instituted by Provost Lloyd, and continued in residence at college. In 1837 he decided to enter the Church, and in the same year he was elected to the professorship of moral philosophy, specially founded for him through Lloyd's exertions. About the same time he was presented to the prebend of Clondahorky, Donegal, and resided there when not called by his professorial duties to Dublin. In 1842 he was promoted to the rectory of Raymochy. He died on the 5th of July 1848. His *Sermons* (2 vols., 1849) were remarkably brilliant and forceful. *The Lectures on the History of Ancient Philosophy*, edited by W. Hepworth Thompson (2 vols., 1856; 2nd ed., 1 vol. 1875), take a high place among the few British works on the history of philosophy. The introductory lectures, and those on the early Greek thinkers, though they evidence wide reading, do not show the complete mastery that is found in Schwegler or Zeller; but the lectures on Plato are of considerable value. Among his other writings were papers in the *Dublin University Magazine* (1834-1837); and "Letters on Development" (in the *Irish Ecclesiastical Journal*, 1845), a reply to Newman's famous *Essay on the Development of Christian Doctrine*.

See *Memoir of W. A. Butler*, prefixed by Rev. J. Woodward to first series of *Sermons*.

BUTLER, SIR WILLIAM FRANCIS (1838-), British soldier, entered the army as an ensign in 1858, becoming captain in 1872 and major in 1874. He took part with distinction in the Red River expedition (1870-71) and the Ashanti operations of 1873-74 under Wolseley, and received the C.B. in 1874. He served with the same general in the Zulu War (brevet lieutenant-colonel), the campaign of Tel-el-Kebir, after which he was made an aide-de-camp to the queen, and the Sudan 1884-85, being employed as colonel on the staff 1885, and brigadier-general 1885-1886. In the latter year he was made a K.C.B. He was colonel on the staff in Egypt 1890-1892, and brigadier-general there until 1892, when he was promoted major-general and stationed at Aldershot, after which he commanded the south-eastern district. In 1898 he succeeded General Goodenough as commander-in-chief in South Africa, with the local rank of lieutenant-general. For a short period (Dec. 1898-Feb. 1899), during the absence of Sir Alfred Milner in England, he acted as high commissioner, and as such and subsequently in his military capacity he expressed views on the subject of the probabilities of war which were not approved by the home government; he was consequently ordered home to command the western district, and held this post until 1905. He also held the Aldershot command for a brief period in 1900-1901. Sir William Butler was promoted lieutenant-general in 1900. He had long been known as a descriptive writer, since his publication of *The Great Lone Land* (1872) and other works, and he was the biographer (1899) of Sir George Colley. He married in 1877 Miss Elizabeth Thompson, an accomplished painter of battle-scenes, notably "The Roll Call" (1874), "Quatre Bras" (1875), "Rorke's Drift" (1881), "The Camel Corps" (1891), and "The Dawn of Waterloo" (1895).

BUTLER, a borough and the county-seat of Butler county, Pennsylvania, U.S.A., on Conoquenessing Creek, about 30 m.

N. of Pittsburg. Pop. (1890) 8734; (1900) 10,853, of whom 928 were foreign-born; (1910 census) 20,728. It is served by the Pennsylvania, the Baltimore & Ohio, the Buffalo, Rochester & Pittsburg, and the Bessemer & Lake Erie railways, and is connected with Pittsburg by two electric lines. It is built on a small hill about 100 ft. above sea-level, and commands extensive views of the surrounding valley. The Butler County hospital (1890) is located here. A fair is held in Butler annually. Oil, natural gas, clay, coal and iron abound in the vicinity, and the borough has various manufactures, including lumber, railway cars (especially of steel), paint, silk, bricks, plate-glass, bottles and oil-well tools. The value of the city's factory products increased from \$1,403,026 in 1900 to \$6,832,007 in 1905, or 386.9%, this being much the greatest rate of increase shown by any city in the state having in 1900 a population of 8000 or more. Butler was selected as the site for the county-seat of the newly-formed county in 1802, was laid out in 1803, and was incorporated in the same year. The county and the borough were named in honour of General Richard Butler, a soldier in the War of Independence and leader of the right wing of General St Clair's army, which was sent against the Indians in 1791 and on the 4th of November was defeated, Butler being killed in the engagement.

BUTLER (through the O. Fr. *boutellier*, from the Late Lat. *buticularius*, *buticula*, a bottle), a domestic servant who superintends the wine-cellar and acts as the chief male servant of a household; among his other duties are the conduct of the service of the table and the custody of the plate. The butler of a royal household was an official of high rank, whose duties, though primarily connected with the supply of wine for the royal table, varied in the different courts in which the office appears. In England, as superintendent of the importation of wine, a duty was payable to him (see **BUTLERAGE AND PRISAGE**); the butlership of Ireland, *Pincerna Hiberniæ*, was given by John, king of England, to Theobald Walter, who added the name of Butler to his own; it then became the surname of his descendants, the earls, dukes and marquesses of Ormonde (see **BUTLER**, family, above).

BUTLERAGE AND PRISAGE. In England there was an ancient right of the crown to purveyance or pre-emption, i.e. the right of buying up provisions and other necessities for the royal household, at a valuation, even without the consent of the owner. Out of this right originated probably that of taking customs, in return for the protection and maintenance of the ports and harbours. One such customs due was that of "prisage," the right of taking one tun of wine from every ship importing from ten to twenty tuns, and two tuns from every ship importing more than twenty tuns. This right of prisage was commuted, by a charter of Edward I. (1302), into a duty of two süllings ca every tun imported by merchant strangers, and termed "butlerage," because paid to the king's butler. Butlerage ceased to be levied in 1809, by the Customs Consolidation Act of that year.

BUTO, the Greek name of the Egyptian goddess Uto (from *W'sy-f*), confused with the name of her city Buto (see **BUS**). She was a cobra-goddess of the marshes, worshipped especially in the city of Buto in the north-west of the Delta, and at another Buto (Hdt. ii. 75) in the north-east of the Delta, now Tell Nebesheh. The former city is placed by Petrie at Tell Fera, a large and important site, but as yet yielding no inscriptions. This western Buto was the capital of the kingdom of Northern Egypt in prehistoric times before the two kingdoms were united; hence the goddess Buto was goddess of Lower Egypt and the North. To correspond to the vulture goddess (Nekhbi) of the south she sometimes is given the form of a vulture; she is also figured in human form. As a serpent she is commonly twined round a papyrus stem, which latter spells her name; and generally she wears the crown of Lower Egypt. The Greeks identified her with Leto; this may be accounted for partly by the resemblance of name, partly by the myth of her having brought up Horus in a floating island, resembling the story of Leto and Apollo on Delos. Perhaps the two myths influenced each other. Herodotus describes the temple and other sacred

places (of the western) Buto, and refers to its festival, and to its oracle, which must have been important though nothing definite is known about it. It is strange that a city whose leading in the most ancient times was fully recognized throughout Egyptian history does not appear in the early lists of nome-capitals. Like Thebes, however (which lay in the 4th nome of Upper Egypt, its early capital being Hermonthis), it eventually became, at a very late date, the capital of a nome, in this case called Phteneto, "the land of (the goddess) Buto." The second Buto (hierogl. *Im-t*) was capital from early times of the 19th nome of Lower Egypt.

See Herodotus ii. 155; *Zeitschr. f. ägyptische Sprache* (1871), 1; K. Sethe in *Pauly-Wissowa, Realencyclopädie*, s.v. "Buto"; D. G. Hogarth, *Journal of Hellenic Studies*, xxiv. 1; W. M. F. Petrie, *Ehnaşa*, p. 36; *Nebeshek and Defenneh*. (F. L. G.)

BUTRINTO, a seaport and fortified town of southern Albania, Turkey, in the vilayet of Iannina; directly opposite the island of Corfu (Corcyra), and on a small stream which issues from Lake Vatzindro or Vivari, into the Bay of Butrinto, an inlet of the Adriatic Sea. Pop. (1900) about 2000. The town, which is situated about 2 m. inland, has a small harbour, and was formerly the seat of an Orthodox bishop. In the neighbourhood are the ruins of the ancient *Buthrotum*, from which the modern town derives its name. The ruins consist of a Roman wall, about a mile in circumference, and some remains of both later and Hellenic work. The legendary founder of the city was Helenus, son of Priam, and Virgil (*Aen.* iii. 201 sq.) tells how Helenus here established a new Trojan kingdom. Hence the names *New Troy* and *New Pergamum*, applied to Buthrotum, and those of *Xanthus* and *Simots*, given to two small streams in the neighbourhood. In the 1st century a.c. Buthrotum became a Roman colony, and derived some importance from its position near Corcyra, and on the main highway between Dyrrachium and Ambracia. Under the Empire, however, it was overshadowed by the development of Dyrrachium and Apollonia. The modern city belonged to the Venetians from the 14th century until 1797. It was then seized by the French, who in 1799 had to yield to the Russians and Turks.

BUTT, ISAAC (1813-1879), Irish lawyer and Nationalist leader, was born at Glenfin, Donegal, in 1813, his father being the Episcopalian rector of Stranorlar. Having won high honours at Trinity, Dublin, he was appointed professor of political economy in 1836. In 1838 he was called to the bar, and not only soon obtained a good practice, but became known as a politician on the Protestant Conservative side, and an opponent of O'Connell. In 1844 he was made a Q.C. He figured in nearly all the important Irish law cases for many years, and was engaged in the defence of Smith O'Brien in 1848, and of the Fenians between 1865 and 1869. In 1852 he was returned to parliament by Youghal as a Liberal-Conservative, and retained this seat till 1865; but his views gradually became more liberal, and he drifted away from his earlier opinions. His career in parliament was marred by his irregular habits, which resulted in pecuniary embarrassment, and between 1865 and 1870 he returned again to his work at the law courts. The result, however, of the disestablishment of the Irish Church was to drive Butt and other Irish Protestants into union with the Nationalists, who had always repudiated the English connexion; and on 10th May 1870, at a large meeting in Dublin, Butt inaugurated the Home Rule movement in a speech demanding an Irish parliament for local affairs. On this platform he was elected in 1871 for Limerick, and found himself at the head of an Irish Home Rule party of fifty-seven members. But it was an ill-assorted union, and Butt soon found that he had little or no control over his more aggressive followers. He had no liking for violent methods or for "obstruction" in parliament; and his leadership gradually became a nullity. His false position undoubtedly assisted in breaking down his health, and he died in Dublin on the 5th of May 1879.

BUTT. (1) (From the Fr. *bolle*, *boute*, Med. Lat. *butta*, a wine vessel), a cask for ale or wine, with a capacity of about two hogheads. (2) (A word common in Teutonic languages, meaning short, or a stump), the thick end of anything, as of a fishing-rod,

a gun, a whip, also the stump of a tree. (3) (From the Fr. *but*, a goal or mark, and *butte*, a target, a rising piece of ground, &c.), a mark for shooting, as in archery, or, in its modern use, a mound or bank in front of which are placed the targets in artillery or musketry practice. This is sometimes called a "stop-butt," its purpose being to secure the ground behind the targets from stray shots. The word is used figuratively of a person or object at which derision or abuse are levelled.

BUTTE, the largest city of Montana, U.S.A., and the county-seat of Silver Bow county. It is situated in the valley of Deer Lodge river, near its head, at an altitude of about 5700 ft. Pop. (1880) 3363; (1890) 10,723; (1900) 30,470, of whom 10,210 were foreign-born, including 2474 Irish, 1518 English-Canadians, and 1505 English; (1910 census) 39,165. It is served by the Great Northern, the Northern Pacific, the Chicago, Milwaukee & Puget Sound, the Butte, Anaconda & Pacific, and the Oregon Short Line railways. Popularly the name "Butte" is applied to an area which embraces the city, Centerville, Walkerville, East Butte, South Butte and Williamsburg. These together form one large and more or less compact city. Butte lies in the centre of the greatest copper-mining district in the world; the surrounding hills are honey-combed with mines, and some mines are in the very heart of the city itself. The best known of the copper mines is the Anaconda. The annual output of copper from the Butte district almost equals that from all the rest of the country together; the annual value of copper, gold and silver aggregates more than \$60,000,000. Although mining and its allied industries of quartz crushing and smelting dominate all other industries in the place, there are also foundries and machine shops, iron-works, tile factories, breweries and extensive planing mills. Electricity, used in the mines particularly, is brought to Butte from Canon Ferry, 75 m. to the N.; from the plant, also on the Missouri river, of the Helena Power Transmission Company, which has a great steel dam 85 ft. high and 630 ft. long across the river, and a 6000-h.p. substation in Butte; and from the plant of the Madison River Power Company, on Madison river 7½ m. S.E. of Norris, whence power is also transmitted to Bozeman and Belgrade, Gallatin county, to Ruby, Madison county, and to the Greene-Campbell mine near Whitehall, Jefferson county. In 1910 Butte had only one large smelter, and the smoke nuisance was thus abated. The city is the seat of the Montana School of Mines (1900), and has a state industrial school, a high school and a public library (rebuilt in 1906 after a fire) with more than 32,000 volumes. The city hall, Federal building and Silver Bow county court house are among the principal buildings. Butte was first settled as a placer mining camp in 1864. It was platted in 1866, its population in 1870 was only 241, and for many years its growth was slow. Prosperity came, however, with the introduction of quartz mining in 1875, and in 1879 a city charter was granted. In the decade from 1890 to 1900 Butte's increase in population was 184.2%.

BUTTE (O Fr *butte*, a hillock or rising ground), a word used in the western states of North America for a flat-topped hill surrounded by a steep escarpment from which a slope descends to the plain. It is sometimes used for "an elevation higher than a hill but not high enough for a mountain." The butte capped by a horizontal platform of hard rock is characteristic of the arid plateau region of the west of North America.

BUTTER (Lat. *buisyrum*, Gr. *βούτυρον*, apparently connected with *βούς*, cow, and *τύπος*, cheese, but, according to the *New English Dictionary*, perhaps of Scythian origin), the fatty portion of the milk of mammalian animals. The milk of all mammals contains such fatty constituents, and butter from the milk of goats, sheep and other animals has been and may be used; but that yielded by cow's milk is the most savoury, and it alone really constitutes the butter of commerce. The milk of the various breeds of cattle varies widely in the proportion of fatty matter it contains; its richness in this respect being greatly influenced by season, nature of food, state of the animals' health and other considerations. Usually the cream is skimmed off the surface of the milk for making butter, but by some the churning is performed on the milk itself without waiting for the

separation of the cream. The operation of churning causes the rupture of the oil sacs, and by the coalescence of the fat so liberated butter is formed. Details regarding churning and the preparation of butter generally will be found under DAIRY AND DAIRY FARMING.

BUTTERCUP, a name applied to several species of the genus *Ranunculus* (q.v.), characterized by their deeply-cut leaves and yellow, broadly cup-shaped flowers.



Plant of *Ranunculus bulbosus*, showing determinate inflorescence.

Ranunculus acris and *R. bulbosus* are erect, hairy meadow plants, the latter having the stem swollen at the base, and distinguished also by the furrowed flower-stalks and the often smaller flowers with reflexed, not spreading, sepals. *R. repens*, common on waste ground, produces long runners by means of which it rapidly covers the ground. The plants are native in the north temperate to arctic zones of the Old World, and have been introduced in America.

BUTTERFIELD, DANIEL (1831-1901), American soldier, was born in Utica, New York. He graduated at Union College in 1849, and when the Civil War broke out he became colonel of the 12th New York militia regiment. On the 14th of May 1861 he was transferred to the regular army as a lieutenant-colonel, and in September he was made a brigadier-general U.S.V. He served in Virginia in 1861 and in the Peninsular campaign of 1862, and was wounded at Gaines' Mill. He took part in the campaign of second Bull Run (August 1862), and in November became major-general U.S.V. and in July 1863 colonel U.S.A. At Fredericksburg he commanded the V. corps, in which he had served since its formation. After General Hooker succeeded Burnside, Butterfield was appointed chief of staff, Army of the Potomac, and in this capacity he served in the Chancellorsville and Gettysburg campaigns. Not being on good terms with General Meade he left the staff, and was soon afterwards sent as chief of staff to Hooker, with the XI. and XII. corps (later combined as the XX.) to Tennessee, and took part in the battle of Chattanooga (1863), and the Atlanta campaign of the following year, when he commanded a division of the XX. corps. His services were recognized by the brevets of brigadier-general and major-general in the regular army. He resigned in 1870, and for the rest of his life was engaged in civil and commercial pursuits. In 1862 he wrote a manual of *Camp and Outpost Duty* (New York, 1862). General Butterfield died at Cold Spring, N.Y., on the 17th of July 1901.

A *Biographical Memorial*, by his widow, was published in 1904.

BUTTERFIELD, WILLIAM (1814-1900), English architect, was born in London, and educated for his profession at Worcester, where he laid the foundations of his knowledge of Gothic architecture. He settled in London and became prominent in connexion with the Cambridge Camden Society, and its work in the improvement of church furniture and art. His first important building was St Augustine's, Canterbury (1845), and his reputation was made by All Saints', Margaret Street, London (1859), followed by St Alban's, Holborn (1863), the new part of Merton College, Oxford (1864), Keble College, Oxford (1875), and many houses and ecclesiastical buildings. He also did much work as a restorer, which has been adversely criticized. He was a keen churchman and intimately associated with the English church revival. He had somewhat original views as to colour in architecture, which led to rather garish results, his view being that any combination of the natural colours of the materials was permissible. His private life was retiring, and he died unmarried on the 23rd of February 1900.

BUTTERFLY AND MOTH (the former from "butter" and "fly," an old term of uncertain origin, possibly from the nature of the excrement, or the yellow colour of some particular species; the latter akin to O. Eng. *mod*, an earth-worm), the common English names applied respectively to the two groups of insects forming the scientific order Lepidoptera (q.v.).

BUTTER-NUT, the product of *Caryocar nuciferum*, a native of tropical South America. The large nuts, known also as saowari or suwarow nuts, are the hard stone of the fruit and contain an oily nutritious seed. The genus *Caryocar* contains ten species, in tropical South America, some of which form large trees affording a very durable wood, useful for shipbuilding.

BUTTERWORT, the popular name of a small insectivorous plant, *Pinguicula vulgaris*, which grows in wet, boggy land. It is a herb with a rosette of fleshy, oblong leaves, 1 to 3 in. long, appressed to the ground, of a pale colour and with a sticky surface. Small insects settle on the leaves and are caught in the viscid excretion. This, like the excretion of the sundew and other insectivorous plants, contains a digestive ferment (or enzyme) which renders the nitrogenous substances of the body of the insect soluble, and capable of absorption by the leaf. In

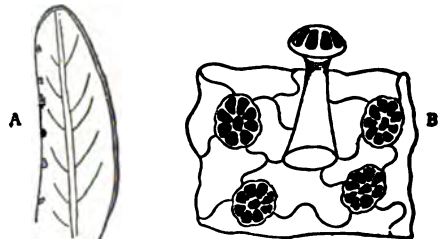

A, leaf of Butterwort (*Pinguicula vulgaris*) with left margin infected over a row of small flies. (After Darwin.) B, glands from surface of leaf by which the sticky liquid is secreted and by means of which the products of digestion are absorbed

this way the plant obtains nitrogenous food by means of its leaves. The leaves bear two sets of glands, the larger borne on usually unicellular pedicels, the smaller almost sessile (fig. B). When a fly is captured, the viscid excretion becomes strongly acid and the naturally incurved margins of the leaf curve still further inwards, rendering contact between the insect and the leaf-surface more complete. The plant is widely distributed in the north temperate zone, extending into the arctic zone.

BUTTERY (from O Fr *boters*, Late Lat. *botaria*, a place where liquor is stored, from *butta*, a cask, a place for storing wine, later, with a confusion with "butter," a pantry or store-room for food, especially, at colleges at Oxford and Cambridge, the place where food other than meat, especially bread and butter, ale and wines, &c., are kept.

BUTTMANN, PHILIPP KARL (1764-1820), German philologist, was born at Frankfort-on-Main in 1764. He was educated in his native town and at the university of Göttingen. In 1789 he obtained an appointment in the library at Berlin, and for some years he edited *Speners Journal*. In 1796 he became professor at the Joachimsthal Gymnasium in Berlin, a post which he held for twelve years. In 1806 he was admitted to the Academy of Sciences, and in 1811 was made secretary of the Historico-Philological Section. He died in 1820. Buttmann's writings gave a great impetus to the scientific study of the Greek language. His *Griechische Grammatik* (1792) went through many editions, and was translated into English. His *Lexilogus*, a valuable study on some words of difficulty occurring principally in the poems of Homer and Hesiod, was published in 1818-1825, and was translated into English. Buttmann's other works were *Ausführliche griechische Sprachlehre* (2 vols., 1810-1817); *Mythologus*, a collection of essays (1818-1820); and editions of some classical authors, the most important being *Demosthenes in Mideiam* (1823) and the continuation of Spalding's *Quintilian*.

BUTTON (Fr. *bouton*, O. Fr. *boton*, apparently from the same root as *bouter*, to push), a small piece of metal or other material which, pushed through a loop or button-hole, serves as a catch between different parts of a garment, &c. The word is also used of other objects which have a projecting knob-like character, e.g. button-mushrooms, the button of an electric bell-push, or the guard at the tip of a fencing foil, or which resemble a button in size and shape, as the button of metal obtained in assaying operations. At first buttons were apparently used for purposes of ornamentation; in *Piers Plowman* (1377) mention is made of a knife with "botones ouergylte," and in Lord Berner's translation of *Froissart's Chronicles* (1525) of a book covered with crimson velvet with "ten botons of syluer and gylte." While this use has continued, especially in connexion with women's dress, they began to be employed as fastenings at least as early as the 15th century. As a term of comparison for something trivial or worthless, the word is found in the 14th century. Buttons of distinctive colour or pattern, or bearing a portrait or motto, are often worn, especially in the United States, as a decoration, or sign of membership of a society or of adherence to a political party; among the most honoured of such buttons are those worn by members of the military order of the Loyal Legion of the United States, organized in 1865 by officers who had fought in the Civil War. Chinese officials wear a button or knob on their hats as a mark of rank, the grade being denoted by its colour and material (see MANDARIN).

Many varieties of buttons are used on clothing, but they may be divided into two main classes according to the arrangement by which they are attached to the garment; in one class they are provided with a shank which may consist of a metal loop or of a tuft of cloth or similar material, while in the other they are pierced with holes through which are passed threads. To these two classes roughly correspond two broad differences in the method of manufacture, according as the buttons are composite and made up of two or more pieces, or are simply shaped disks of a single material; some composite buttons, however, are provided with holes, and simple metal buttons sometimes have metal shanks soldered or riveted on them. From an early period buttons of the former kind were made by needlework with the aid of a mould or former, but about 1807 B. Sanders, a Dane who had been ruined by the bombardment of Copenhagen, introduced an improved method of manufacturing them at Birmingham. His buttons were formed of two disks of metal locked together by having their edges turned back on each other and enclosing a filling of cloth or pasteboard; and by methods of this kind, carried out by elaborate automatic machinery, buttons are readily produced, presenting faces of silk, mohair, brocade or other material required to harmonize with the fabric on which they are used. Sanders's buttons at first had metal shanks, but about 1825 his son invented flexible shanks of canvas or other substance through which the needle could pass freely in any direction. The mechanical manufacture of covered buttons was started in the United States in 1827 by Samuel Williston, of Easthampton, Mass., who in 1834 joined forces with Joel and Josiah Hayden, of Haydenville.

The number of materials that have been used for making buttons is very large—metals such as brass and iron for the cheaper kinds, and for more expensive ones, gold and silver, sometimes ornamented with jewels, filigree work, &c.; ivory, horn, bone and mother-of-pearl or other sacreous products of shell-fish; vegetable ivory and wood; glass, porcelain, paper, celluloid and artificial compositions; and even the casein of milk, and blood. Brass buttons were made at Birmingham in 1680, and in the following century the metal button industry underwent considerable development in that city. Matthew Boulton the elder, about 1745, introduced great improvements in the processes of manufacture, and when his son started the Soho works in 1767 one of the departments was devoted to the production of steel buttons with facets, some of which sold for 140 guineas a gross. Gilt buttons also came into fashion about the same period. In this "Augustan age" of the Birmingham button industry, when there was a large export trade, the profits

of manufacturers who worked on only a modest scale amounted to £3000 and £4000 a year, and workmen earned from £2 to £4 a week. At one time the buttons had each to be fashioned separately by skilled artisans, but gradually the cost of production was lessened by the adoption of mechanical processes, and instead of being turned out singly and engraved or otherwise ornamented by hand, they came to be stamped out in dies which at once shape them and impress them with the desired pattern. Ivory buttons are among the oldest of all. Horn buttons were made at Birmingham at least by 1777; towards the middle of the 19th century Emile Bassot invented a widely-used process for producing them from the hoofs of cattle, which were softened by boiling. Pearl buttons are made from pearl oyster shells obtained from various parts of the world, and after being cut out by tubular drills are shaped and polished by machinery. Buttons of vegetable ivory can be readily dyed. Glass buttons are especially made in Bohemia, as also are those of porcelain, which were invented about 1840 by an Englishman, R. Prosser of Birmingham. In the United States few buttons were made until the beginning of the 19th century, when the manufacture of metal buttons was started at Waterbury, Conn., which is now the centre of that industry. In 1812 Aaron Benedict began to make ivory and horn buttons at the same place. Buttons of vegetable ivory, now one of the most important branches of the American button industry, were first made at Leeds, Mass., in 1859 by an Englishman, A. W. Critchlow, and in 1875 commercial success was attained in the production of composition buttons at Springfield, Mass. Pearl buttons were made on a small scale in 1855, but their manufacture received an enormous impetus in the last decade of the 19th century, when J. F. Boepple began, at Muscatine, Iowa, to utilize the union or "niggerhead" shells found along the Mississippi. By 1905 the annual output of these "fresh-water pearl" buttons had reached 11,405,723 gross, worth \$3,359,167, or 36.6% of the total value of the buttons produced in the United States. In the same year the mother-of-pearl buttons ("ocean pearl buttons") numbered 1,737,830 gross, worth \$1,511,107, and the two kinds together constituted 44% of the number, and 53.9% of the value, of the button manufactures of the United States. (See *U.S.A. Census Reports, 1900, Manufactures*, part iii. pp. 315-327.)

BUTTRESS (from the O. Fr. *bouteres*, that which bears a thrust, from *bouter*, to push, cf. Eng. "butt" and "abutment"), masonry projecting from a wall, provided to give additional strength to the same, and also to resist the thrust of the roof or wall, especially when concentrated at any one point. In Roman architecture the plans of the building, where the vaults were of considerable span and the thrust therefore very great, were so arranged as to provide cross-walls, dividing the aisles, as in the case of the Basilica of Maxentius, and, in the Thermæ of Rome, the subdivisions of the less important halls, so that there were no visible buttresses. In the baths of Diocletian, however, these cross-walls rose to the height of the great vaulted hall, the tepidarium, and their upper portions were decorated with niches and pilasters. In a palace at Shuka in Syria, attributed to the end of the 2nd century A.D., where, in consequence of the absence of timber, it was necessary to cover over the building with slabs of stones, these latter were carried on arches thrown across the great hall, and this necessitated two precautions, viz. the provision of an abutment inside the building, and of buttresses outside, the earliest example in which the feature was frankly accepted. In Byzantine work there were no external buttresses, the plans being arranged to include them in cross-walls or interior abutments. The buttresses of the early Romanesque churches were only pilaster strips employed to break up the wall surface and decorate the exterior. At a slightly later period a greater depth was given to the lower portion of the buttresses, which was then capped with a deep sloping weathering. The introduction of ribbed vaulting, extended to the nave in the 12th century, and the concentration of thrusts on definite points of the structure, rendered the buttress an absolute necessity, and from the first this would seem to have been recognized, and the architectural treatment already given to the Romanesque buttress received

a remarkable development. The buttresses of the early English period have considerable projection with two or three sets-off sloped at an acute angle dividing the stages and crowned by triangular heads; and slender columns ("buttress shafts") are used at the angle. In later work pinnacles and niches are usually employed to decorate the summits of the buttresses, and in the still later Perpendicular work the vertical faces are all richly decorated with panelling.

BUTYL ALCOHOLS, C_4H_9OH . Four isomeric alcohols of this formula are known; two of these are primary, one secondary, and one tertiary (see ALCOHOLS). Normal butyl alcohol, $CH_3(CH_2)_3CH_2OH$, is a colourless liquid, boiling at 116.8° , and formed by reducing normal butyl aldehyde with sodium, or by a peculiar fermentation of glycerin, brought about by a schizomycete. Isobutyl alcohol, $(CH_3)_2CHCH_2OH$, the butyl alcohol of fermentation, is a primary alcohol derived from isobutane. It may be prepared by the general methods, and occurs in fusel oil, especially in potato spirit. It is a liquid, smelling like fusel oil and boiling at 108.4° G. Methyl ethyl carbinol, $CH_3C_2H_4CHOH$, is the secondary alcohol derived from n-butane. It is a strongly smelling liquid, boiling at 99° . Trimethyl carbinol or tertiary butyl alcohol, $(CH_3)_3COH$, is the simplest tertiary alcohol, and was obtained by A. Butlerow in 1864 by acting with zinc methyl on acetyl chloride (see ALCOHOLS). It forms rhombic prisms or plates which melt at 25° and boil at 83° , and has a spiritous smell, resembling that of camphor.

BUTYRIC ACID, $C_4H_8O_2$. Two acids are known corresponding to this formula, *normal butyric acid*, $CH_3CH_2CH_2COOH$, and *isobutyric acid*, $(CH_3)_2CHCOOH$. Normal butyric acid or fermentation-butyric acid is found in butter, as an hexyl ester in the oil of *Heracleum giganteum* and as an octyl ester in parsnip (*Pastinaca sativa*); it has also been noticed in the fluids of the flesh and in perspiration. It may be prepared by the hydrolysis of ethyl acetoacetate, or by passing carbon monoxide over a mixture of sodium acetate and sodium ethylate at 205° C (A. Geuther, *Ann.*, 1880, 202, p. 306), $C_2H_5ONa + CH_3COONa + CO = HCO_2Na + CH_3CH_2CH_2COONa$. It is ordinarily prepared by the fermentation of sugar or starch, brought about by the addition of putrefying cheese, calcium carbonate being added to neutralize the acids formed in the process. A. Fitz (*Ber.*, 1878, 11, p. 52) found that the butyric fermentation of starch is aided by the direct addition of *Bacillus subtilis*. The acid is an oily liquid of unpleasant smell, and solidifies at -19° C.; it boils at 162.3° C., and has a specific gravity of 0.9746 (0° C.). It is easily soluble in water and alcohol, and is thrown out of its aqueous solution by the addition of calcium chloride. Potassium bichromate and sulphuric acid oxidize it to carbon dioxide and acetic acid, while alkaline potassium permanganate oxidizes it to carbon dioxide. The calcium salt, $Ca(C_3H_7O_2)_2 \cdot H_2O$, is less soluble in hot water than in cold.

Isobutyric acid is found in the free state in carobs (*Ceratonia siliqua*) and in the root of *Arnica dulcis*, and as an ethyl ester in croton oil. It may be artificially prepared by the hydrolysis of isopropylcyanide with alkalis, by the oxidation of isopropyl alcohol with potassium bichromate and sulphuric acid (I. Pierre and E. Fuchot, *Ann. de chim. et de phys.*, 1873, [4] 28, p. 366), or by the action of sodium amalgam on methacrylic acid, $CH_2=C(CH_3)COOH$. It is a liquid of somewhat unpleasant smell, boiling at 155.5° C. Its specific gravity is 0.9697 (0°). Heated with chromic acid solution to 140° C., it gives carbon dioxide and acetone. Alkaline potassium permanganate oxidizes it to α -oxyisobutyric acid, $(CH_3)_2C(OH)COOH$, whilst concentrated nitric acid converts it into dinitroisopropane. Its salts are more soluble in water than those of the normal acid.

BUXAR, or BAXAR, a town of India, in the district of Shahabad, Bengal, on the south bank of the Ganges, and on the East Indian railway. Pop. (1901) 13,945. There is a dismantled fort of small size which was important from its commanding the Ganges. A celebrated victory was gained here on the 23rd of October 1764 by the British forces under Major (afterwards Sir Hector) Munro, over the united armies of Shuja-ud-Dowlah and Kasim Ali Khan. The action raged from 9 o'clock till noon, when

the enemy gave way. Pursuit was, however, frustrated by Shuja-ud-Dowlah sacrificing a part of his army to the safety of the remainder. A bridge of boats had been constructed over a stream about 2 m. distant from the field of battle, and this the enemy destroyed before their rear had passed over. Through this act 2000 troops were drowned, or otherwise lost; but destructive as was this proceeding, it was, said Major Munro, "the best piece of generalship Shuja-ud-Dowlah showed that day, because if I had crossed the rivulet with the army, I should either have taken or drowned his whole army in the Kazamassa, and come up with his treasure and jewels, and Kasim Ali Khan's jewels, which I was informed amounted to between two and three millions."

BUXTON, JEDEDIAH (1707-1772), English arithmetician, was born on the 30th of March 1707 at Elmtou, near Chesterfield, in Derbyshire. Although his father was schoolmaster of the parish, and his grandfather had been the vicar, his education had been so neglected that he could not write; and his knowledge, except of numbers, was extremely limited. How he came first to know the relative proportions of numbers, and their progressive denominations, he did not remember; but on such matters his attention was so constantly riveted, that he frequently took no cognizance of external objects, and when he did, it was only with reference to their numbers. He measured the whole lordship of Elmtou, consisting of some thousand acres, simply by striding over it, and gave the area not only in acres, roods and perches, but even in square inches. After this, he reduced them into square hairs'-breadths, reckoning forty-eight to each side of the inch. His memory was so great, that in resolving a question he could leave off and resume the operations again at the same point after the lapse of a week, or even of several months. His perpetual application to figures prevented the smallest acquisition of any other knowledge. His wonderful faculty was tested in 1754 by the Royal Society of London, who acknowledged their satisfaction by presenting him with a handsome gratuity. During his visit to the metropolis he was taken to see the tragedy of *Richard III* performed at Drury Lane theatre, but his whole mind was given to the counting of the words uttered by David Garrick. Similarly, he set himself to count the steps of the dancers; and he declared that the innumerable sounds produced by the musical instruments had perplexed him beyond measure. He died in 1772.

A memoir appeared in the *Gentleman's Magazine* for June 1754, to which, probably through the medium of a Mr Holliday, of Haughton Hall, Nottinghamshire, Buxton had contributed several letters. In this memoir, his age is given as forty-nine, which points to his birth in 1705; the date adopted above is on the authority of Lysons' *Magna Britannia* (Derbyshire).

BUXTON, SIR THOMAS FOWELL (1786-1845), English philanthropist, was born in Essex on the 1st of April 1786, and was educated at Trinity College, Dublin, where, in spite of his early education having been neglected, hard work made him one of the first men of his time, with a high reputation as a speaker. In 1807 he married Hannah Gurney, sister of the celebrated Elizabeth Fry. As his means were not sufficient to support his family, he entered in 1808 the brewery of Truman, Hanbury & Company, of which his uncles, the Hanburys, were partners. He devoted himself to business with characteristic energy, became a partner in 1811, and soon had the whole concern in his hands. In 1816 he brought himself into notice by his speech on behalf of the Spitalfields weavers, and in 1818 he published his able *Inquiry into Prison Discipline*. The same year he was elected M.P. for Weymouth, a borough for which he continued to sit till 1837. In the House of Commons he had a high reputation as an able and straightforward speaker, devoted to philanthropic schemes. Of these plans the most important was that for the abolition of slavery in the British colonies. Buxton devoted his life to this object, and through defeat and opposition, despite the attacks of enemies and the remonstrances of faint-hearted friends, he remained true to it. Not till 1833 was he successful, and even then only partially, for he was compelled to admit into the bill some clauses against which his better judgment had decided. In 1837 he ceased to

sit in the House of Commons. He travelled on the continent in 1839 to recruit his health, which had given way, and took the opportunity of inspecting foreign prisons. He was made a baronet in 1840, and then devoted himself to a plan for ameliorating the condition of the African natives. The failure of the Niger expedition of 1841 was a blow from which he never recovered. He died on the 10th of February 1845.

See *Memoir and Correspondence of Sir T. F. Buxton* (1848), by his third son, Charles Buxton (1823-1871), a well-known philanthropist and member of parliament.

BUXTON, a market town and fashionable health-resort in the High Peak parliamentary division of Derbyshire, England, on the London & North-Western and Midland railways, 36 m. N.W. by N. of Derby. Pop. of urban district (1901) 10,181. It occupies a high position, lying between 1000 and 1150 ft. above sea-level, in an open hollow, surrounded at a distance by hills of considerable elevation, except on the south-east side, where the Wye, which rises about half a mile away, makes its exit. The old town (High Buxton) stands a little above the new, and consists of one wide street, and a considerable market-place with an old cross. The new town is the richer portion. The Crescent is a fine range of buildings in the Doric style, erected by the duke of Devonshire in 1779-1788. It contains hotels, a ball-room, a bank, a library and other establishments, and the surrounding open grounds are laid out in terraces and gardens. The Old Hall hotel at the west end of the Crescent stands on the site of the mansion built in 1572 by the earl of Shrewsbury in the reign of Queen Elizabeth, which was the residence of Mary queen of Scots when she visited the town. The mineral waters of Buxton, which have neither taste nor smell, are among the most noted in England, and are particularly efficacious in cases of rheumatism and gout. There are numerous public and private baths, the most important of which are those in the establishment at the eastern end of the Crescent. The springs supply hot and cold water at a very short distance from each other, flowing at the rate of 60 gallons a minute. The former possesses a uniform temperature of 82° Fahr., and the principal substances in solution are bicarbonate of calcium, bicarbonate of magnesium, chloride of sodium, chloride of magnesium and silica acid. There is also a chalybeate spring known as St Anne's well, situated at the S.W. corner of the Crescent, the water of which when mixed with that of the other springs proves purgative. The Devonshire hospital, formerly known as the Bath Charity, is a benevolent institution, supported by voluntary subscriptions. Every year some thousands of poor patients are treated free of cost; and the hospital was enlarged for their accommodation, a dome being added which is of greater circumference than any other in Europe. In 1804 the duke of Devonshire erected a handsome pump-room at St Anne's well. The Buxton season extends from June to October, and during that period the town is visited by thousands, but it is also popular as a winter resort. The Buxton Gardens are beautifully laid out, with ornamental waters, a fine opera-house, pavilion and concert hall, theatre and reading rooms. Electric lighting has been introduced, and there is an excellent golf course. The Cavendish Terrace forms a fine promenade, and the neighbourhood of the town is rich in objects of interest. Of these the chief are Poole's Hole, a vast stalactite cave, about half a mile distant; Diamond Hill, which owes its name to the quartz crystals which are not uncommon in its rocks; and Chee Tor, a remarkable cliff, on the banks of the Wye, 300 ft. high. Ornaments are manufactured by the inhabitants from alabaster and spar; and excellent lime is burned at the quarries near Poole's Hole. Buxton is an important centre for horse-breeding, and a large horse-fair is held annually. Although the annual rainfall, owing to the situation of the town towards the western flank of the Pennine Hills, is about 49 in., the air is particularly dry owing to the high situation and the rapidity with which waters drain off through the limestone. The climate is bracing and healthy.

The waters were known and used by the Romans, but to a limited extent, and no remains of their baths survive. Roman roads connected the place with Derby, Brough in Edale and

Manchester. Buxton (Bawdestanes, Bue-stanes), formed into a civil parish from Bakewell in 1895, has thus claimed to be considered one of the oldest English spas. It was probably the "Bectune" mentioned in Domesday. After the departure of the Romans the baths seem to have been long neglected, but were again frequented in the 16th century, when the chapel of St Anne was hung round with the crutches of those who were supposed to owe their cure to her healing powers; these interesting relics were destroyed at the Reformation. The baths were visited at least four times by Mary queen of Scots, when a prisoner in charge of George, earl of Shrewsbury, other famous Elizabethan visitors being Lord Burleigh, the earl of Essex, and Robert, earl of Leicester. At the close of the 18th century the duke of Devonshire, lord of the manor (whose ancestor Sir Ralph de Gernons was lord of Bakewell in 1251), spent large sums of money on improvements in the town. In 1781 he began to build the famous Crescent, and since that time Buxton has steadily increased in favour as an inland watering-place. In 1813 a weekly market on Saturday and four annual fairs were granted. These were bought by the local authorities from the duke of Devonshire in 1864.

See Gough's edition of Camden's *Britannia*; Stephen Glover, *History of the County of Derby* (Derby, 1829); W. Bemrose, *Guide to Buxton* (London, 1869).

BUXTORF, or **BUXTORFF**, **JOHANNES** (1564-1629), German Hebrew and Rabbinic scholar, was born at Kamen in Westphalia on the 25th of December 1564. The original form of the name was Bockstrop, or Bortrop, from which was derived the family crest, which bore the figure of a goat (Ger. *Bock*, he-goat). After the death of his father, who was minister of Kamen, Buxtorf studied at Marburg and the newly-founded university of Herborn, at the latter of which C. Olevian (1536-1587) and J. P. Piscator (1546-1625) had been appointed professors of theology. At a later date Piscator received the assistance of Buxtorf in the preparation of his Latin translation of the Old Testament, published at Herborn in 1602-1603. From Herborn Buxtorf went to Heidelberg, and thence to Basel, attracted by the reputation of J. J. Grynaeus and J. G. Hospinian (1515-1575). After a short residence at Basel he studied successively under H. B. Bullinger (1504-1575) at Zürich and Th. Beza at Geneva. On his return to Basel, Grynaeus, desirous that the services of so promising a scholar should be secured to the university, procured him a situation as tutor in the family of Leo Curio, son of Coelius Secundus Curio, well-known for his sufferings on account of the Reformed faith. At the instance of Grynaeus, Buxtorf undertook the duties of the Hebrew chair in the university, and discharged them for two years with such ability that at the end of that time he was unanimously appointed to the vacant office. From this date (1591) to his death in 1629 he remained in Basel, and devoted himself with remarkable zeal to the study of Hebrew and rabbinic literature. He received into his house many learned Jews, that he might discuss his difficulties with them, and he was frequently consulted by Jews themselves on matters relating to their ceremonial law. He seems to have well deserved the title which was conferred upon him of "Master of the Rabbins." His partiality for Jewish society brought him, indeed, on one occasion into trouble with the authorities of the city, the laws against the Jews being very strict. Nevertheless, on the whole, his relations with the city of Basel were friendly. He remained firmly attached to the university which first recognized his merits, and declined two invitations from Leiden and Saumur successively. His correspondence with the most distinguished scholars of the day was very extensive; the library of the university of Basel contains a rich collection of letters, which are valuable for a literary history of the time.

WORKS.—*Manuale Hebraicum et Chaldaicum* (1602; 7th ed., 1658); *Synagoga Judaica* (1603 in German; afterwards translated into Latin in an enlarged form), a valuable repository of information regarding the opinions and ceremonies of the Jews; *Lexicon Hebraicum et Chaldaicum cum brevi Lexico Rabbinico Philosophico* (1607; reprinted at Glasgow, 1824); his great Rabbinical Bible, *Biblia Hebraica cum Parsoph. Chald. et Commentariis Rabbinorum* (2 vols., 1618; 4 vols., 1618-1619), containing, in addition to the Hebrew

text, the Aramaic Paraphrases of Targums, punctuated after the analogy of the Aramaic passages in Ezra and Daniel (a proceeding which has been condemned by Richard Simon and others), and the Commentaries of the more celebrated Rabbis, with various other treatises; *Tiberias, sine Commentariis Masoreticis* (1620; quarto edition, improved and enlarged by J. Buxtorf the younger, 1665), so named from the great school of Jewish criticism which had its seat in the town of Tiberias. It was in this work that Buxtorf controverted the views of Elias Levita regarding the late origin of the Hebrew vowel points, a subject which gave rise to the controversy between Louis Cappel and his son Johannes Buxtorf (*q.v.*). Buxtorf did not live to complete the two works on which his reputation chiefly rests, viz. his great *Lexicon Chaldaicum, Talmudicum, et Rabbinicum*, and the *Concordantiae Bibliorum Hebraicorum*, both of which were edited by his son. They are monuments of untiring labour and industry. The lexicon was republished at Leipzig in 1869 with some additions by Bernard Fischer, and the concordance was assumed by Julius Efrasi as the basis of his great Hebrew concordance, which appeared in 1840.

For additional information regarding his writings see *Athenae Ravennae*, pp. 444-448; articles in Ersch and Gruber's *Encyclopaedie*, and Herzog-Hauck, *Realencyk.*; J. P. Nicron's *Mémoires*, vol. xxxi. pp. 206-215; J. M. Schroech's *Kirchengeschichte*, vol. v. (Post-Reformation period), pp. 72 seq. (Leipzig, 1806); G. W. Meyer's *Geschichte der Schrift-Erklärung*, vol. iii. (Göttingen, 1804); and E. Kautsch, *Johannes Buxtorf der Ältere* (1879).

BUXTORF, or BUXTORFF, JOHANNES (1599-1664), son of the preceding, was born at Basel on the 13th of August 1599, and when still a boy attained considerable proficiency in the classical languages. Entering the university at the age of twelve, he was only sixteen when he obtained his master's degree. He now gave himself up to theological and especially to semitic studies, concentrating later on rabbinical Hebrew, and reading while yet a young man both the Mishna and the Jerusalem and Babylonian Gemaras. These studies he further developed by visits to Heidelberg, Dort (where he made the acquaintance of many of the delegates to the synod of 1619) and Geneva, and in all these places acquired a great reputation. In 1622 he published at Basel a *Lexicon Chaldaicum et Syriacum*, as a companion work to his father's great Rabbinical Bible. He declined the chair of logic at Lausanne, and in 1624 was appointed general deacon of the church at Basel. On the death of his father in 1629, he was unanimously designated his successor in the Hebrew professorship. From this date until his death in 1664 he remained at Basel, declining two offers which were made to him from Groningen and Leiden, to accept the Hebrew chair in these two celebrated schools. In 1647 the governing body of the university founded, specially for him, a third theological professorship, that of "Commonplaces and Controversies," which Buxtorf held for seven years along with the Hebrew chair. When, however, the professorship of the Old Testament became vacant in 1654 by the death of Theodor Zwinger, Buxtorf resigned the chair of theology and accepted that of the Old Testament instead. He was four times married, his three first wives dying shortly after marriage and the fourth predeceasing her husband by seven years. His children died young, with the exception of two boys, the younger of whom, Jakob (1645-1704), became his father's colleague, and then his successor, in the chair of Hebrew. The same distinction fell to the lot of his nephew Johann (1663-1732).

A considerable portion of Buxtorf's public life was spent in controversy regarding disputed points in biblical criticism, in reference to which he had to defend his father's views. The attitude of the Reformed churches at that time, as opposed to the Church of Rome, led them to maintain many opinions in regard to biblical questions which were not only erroneous, but altogether unnecessary for the stability of their position. Having renounced the dogma of an infallible church, it was deemed necessary to maintain as a counterpoise, not only that of an infallible Bible, but, as the necessary foundation of this, of a Bible which had been handed down from the earliest ages without the slightest textual alteration. Even the vowel points and accents were held to have been given by divine inspiration. The Massoretic text of the Old Testament, therefore, as compared either with that of the recently discovered Samaritan Pentateuch, or the Septuagint or of the Vulgate, alone contained the true words of the sacred writers. Although many of the Reformers, as well as learned Jews, had long seen that these

assertions could not be made good, there had been as yet no formal controversy upon the subject. Louis Cappel (*q.v.*) was the first effectually to dispel the illusions which had long prevailed by a work on the modern origin of the vowel points and accents. The elder Buxtorf had counselled him not to publish his work, pointing out the injury which it would do the Protestant cause, but Cappel sent his MS. to Thomas Erpenius of Leiden, the most learned orientalist of his day, by whom it was published in 1624, under the title *Arcanum Punctionis revelatum*, but without the author's name. The elder Buxtorf, though he lived five years after the publication of the work, made no public reply to it, and it was not until 1648 that Buxtorf junior published his *Tractatus de punctorum origine, antiquitate, et authoritate, oppositum Arcano punctionis revelato Ludovici Cappelli*. He tried to prove by copious citations from the rabbinical writers, and by arguments of various kinds, that the points, if not so ancient as the time of Moses, were at least as old as that of Ezra, and thus possessed the authority of divine inspiration. Unfortunately he allowed himself to employ contemptuous epithets towards Cappel, such as "innovator" and "visionary." Cappel speedily prepared a second edition of his work, in which, besides replying to the arguments of his opponent, and fortifying his position with new ones, he retorted his contumelious epithets with interest. Owing to various causes, however, this second edition did not see the light until 1685, when it was published at Amsterdam in the edition of his collected works. Besides this controversy, Buxtorf engaged in three others with the same antagonist, on the subject of the integrity of the Massoretic text of the Old Testament, on the antiquity of the present Hebrew characters, and on the Lord's Supper. In the two former Buxtorf supported the untenable position that the text of the Old Testament had been transmitted to us without any errors or alteration, and that the present square or so-called Chaldee characters were coeval with the original composition of the various books. These views were triumphantly refuted by his great opponent in his *Critica Sacra*, and in his *Diatriba veris et antiquis Hebraicorum literis*.

Besides the works already mentioned in the course of this article, Buxtorf edited the great *Lexicon Chaldaicum, Talmudicum, et Rabbinicum*, on which his father had spent the labour of twenty years, and to the completion of which he himself gave ten years of additional study; and the great Hebrew *Concordance*, which his father had little more than begun. In addition to these, he published new editions of many of his father's works, as well as others of his own, complete lists of which may be seen in the *Athenae Ravennae* and other works enumerated at the close of the preceding article.

BUYING IN, on the English stock exchange, a transaction by which, if a member has sold securities which he fails to deliver on settling day, or any of the succeeding ten days following the settlement, the buyer may give instructions to a stock exchange official to "buy in" the stock required. The official announces the quantity of stock, and the purpose for which he requires it, and whoever sells the stock must be prepared to deliver it immediately. The original seller has to pay the difference between the two prices, if the latter is higher than the original contract price. A similar practice, termed "selling out," prevails when a purchaser fails to take up his securities.

BUYS BALLOTT'S LAW, in meteorology, the name given to a law which may be expressed as follows:—"Stand with your back to the wind; the low-pressure area will be on your left-hand." This rule, the truth of which was first recognized by the American meteorologists J. H. Coffin and W. Ferrel, is a direct consequence of Ferrel's Law (*q.v.*). It is approximately true in the higher latitudes of the Northern Hemisphere, and is reversed in the Southern Hemisphere, but the angle between barometric gradient and wind is not a right angle in low latitudes. The law takes its name from C. H. D. Buys Ballot, a Dutch meteorologist, who published it in the *Comptes rendus*, November 1857.

BUZEU, the capital of the department of Buzeu, Rumania, situated near the right bank of the river Buzeu, between the Carpathian Mountains and the fertile lowlands of south Moldavia and east Walachia. Pop. (1900) 21,561. Buzeu is important as a market for petroleum, timber and grain. It is the meet-

place of railroads from Râmnicu Sarat, Braïla and Ploesci. Amber is found by the riverside, and there are cloth-mills in the city. Buzot is the seat of a bishop, whose cathedral was erected in 1640 by Prince Matthias Bassarab of Walachia, on the site of an older church. In the neighbourhood there are many monasteries. Buzot was formerly called Napuca or Buzograd.

BUZOT, FRANÇOIS NICOLAS LÉONARD (1760-1794), French revolutionist, was born at Evreux on the 1st of March 1760. He studied law, and at the outbreak of the Revolution was an advocate in his native town. In 1789 he was elected deputy to the states-general, and there became known for his advanced opinions. He demanded the nationalization of the possessions of the clergy, and the right of all citizens to carry arms. After the dissolution of the Constituent Assembly, Buzot returned to Evreux, where he was named president of the criminal tribunal. In 1792 he was elected deputy to the Convention, and took his place among the Girondists. He demanded the formation of a national guard from the departments to defend the Convention against the populace of Paris. His proposal was carried, but never put into force; and the Parisians were extremely bitter against him and the Girondists. In the trial of Louis XVI., Buzot voted for death, but with appeal to the people and postponement of sentence. He had a decree of death passed against the *émigrés* who did not return to France, and against anyone who should demand the re-establishment of the monarchy. Proscribed with the Girondists on the 2nd of June 1793, he succeeded in escaping, and took refuge in Normandy, where he contributed to organize a federalist insurrection against the Convention, which was speedily suppressed. Buzot was outlawed, and fled to the neighbourhood of Bordeaux, and committed suicide in the woods of St Emilion on the 18th of June 1794. He was an intelligent and honest man, although he seems to have profited by the sale of the possessions of the clergy, but he had a stubborn, unyielding temperament, was incapable of making concessions, and was dominated by Madame Roland, who imparted to him her hatred of Danton and the Montagnards.

See *Mémoires de Pétion, Barbarous, Buzot*, published by C. A. Daubon (Paris, 1866). For the history of the federalist movement in Normandy, see L. Boivin Champeaux, *Notices pour servir à l'histoire de la Révolution dans le département de l'Eure* (Evreux and Paris, 1884).

BUZZARD, a word derived from the Lat. *Buteo*, through the Fr. *Busard*, and used in a general sense for a large group of diurnal birds-of-prey, which contains, among many others, the species usually known as the common buzzard (*Buteo vulgaris*, Leach), though the English epithet is nowadays hardly applicable. The name buzzard, however, belongs quite as rightfully to the birds called in books "harriers," which form a distinct subfamily of *Falconidae* under the title *Circinae*, and by it one species, the moor-buzzard (*Circus aeruginosus*), is still known in such places as it inhabits. "Puttock" is also another name used in some parts of England, but perhaps is rather a synonym of the kite (*Milvus iclinus*). Though ornithological writers are almost unanimous in distinguishing the buzzards as a group from the eagles, the grounds usually assigned for their separation are but slight, and the diagnostic character that can be best trusted is probably that in the former the bill is decurved from the base, while in the latter it is for about a third of its length straight. The head, too, in buzzards is short and round, while in the eagles it is elongated. In a general way buzzards are smaller than eagles, though there are several exceptions to this statement, and have their plumage more mottled. Furthermore, most if not all of the buzzards, about which anything of the kind is with certainty known, assume their adult dress at the first moult, while the eagles take a longer time to reach maturity. The buzzards are fine-looking birds, but are slow and heavy of flight, so that in the old days of falconry they were regarded with infinite scorn, and hence in common English to call a man "a buzzard" is to denounce him as stupid. Their food consists of small mammals, young birds, reptiles, amphibians and insects—particularly beetles—and thus they never could have been very injurious to the game-preserve, if indeed they were not really

his friends, though they have fallen under his ban; but at the present day they are so scarce that in England their effect, whatever it may be, is inappreciable. Buzzards are found over the whole world with the exception of the Australian region, and have been split into many genera by systematists. In the British Islands are two species, one resident (the *B. vulgaris* already mentioned), and now almost confined to a few wooded districts; the other the rough-legged buzzard (*Archibuteo lagopus*), an irregular winter-visitant, sometimes arriving in large bands from the north of Europe, and readily distinguishable from the former by being feathered down to the toes. The honey-buzzard (*Pernis apivorus*), a summer-visitor from the south, and breeding, or attempting to breed, yearly in the New Forest, does not come into the subfamily *Buteoninae*, but is probably the type of a distinct group, *Perninae*, of which there are other examples in Africa and Asia. In America the name "buzzard" is popularly given to the turkey-buzzard or turkey-vulture (*Cathartes Aura*). (A. N.)

BYELAYA TSERKOV (i.e. White Church), a town of Russia, in the government of Kiev, 32 m. S.S.W. of Vasilkov, on the main road from Kiev to the Crimea, in 49° 47' N. lat. and 30° 7' E. long. Pop. (1860) 12,075; (1897) 20,705. First mentioned in 1155, Byelaya Tserkov was destroyed during the Mongol invasion of the 13th century. In 1550 a castle was built here by the prince of Kiev, and various privileges were bestowed upon the inhabitants. From 1651 the town was subject alternately to Poland and to independent betmans (Cossack chiefs). In 1793 it was united to Russia. There is a trade in beer, cattle and grain, sold at eleven annual fairs, three of which last for ten days each.

BYELEK, a town of Russia, in the government of Tula, and 67 m. S.W. from the city of that name on the left bank of the Oka, in 53° 48' N. lat., and 36° 0' E. long. Pop. (1860) 8063; (1897) 9567. It is first mentioned in 1147. It belonged to Lithuania in the end of the 14th century; and in 1468 it was raised to the rank of a principality, dependent on that country. In the end of the 15th century this principality began to attach itself to the grand-duchy of Moscow; and by Ivan III. it was ultimately united to Russia. It suffered greatly from the Tatars in 1507, 1512, 1530, 1536 and 1544. In 1826 the empress Elizabeth died here on her way from Taganrog to St Petersburg. A public library was founded in 1858 in memory of the poet Zhukovsky, who was born (1782) in a neighbouring village. The industries comprise tallow-boiling, oil-manufacture, tanning, sugar-refining and distilling. There is a trade in grain, hemp oil, cattle and tallow. A fair is held from the 28th of August to the 10th of September every year.

BYELGOROD (i.e. White Town), a town of Russia, in the government of Kursk, 100 m. S.S.E. by rail from the city of that name, in 50° 46' N. lat. and 36° 37' E. long., clustering on a chalk hill on the right bank of the Donets. Pop. (1860) 11,722; (1897) 21,850. In the 17th century it suffered repeatedly from Tatar incursions, against which there was built (from 1633 to 1740) an earthen wall, with twelve forts, extending upwards of 200 m. from the Vorokla to the Don, and called the Byelgorod line. In 1666 an archiepiscopal see was established in the town. There are two cathedral churches, both built in the 16th century, as well as a theological seminary. Candles, leather, soap, lime and bricks are manufactured, and a trade is carried on in grain, cattle, wool, honey, wax and tallow. There are three annual fairs, on the 10th Friday after Easter, the 29th of June and the 15th of August respectively.

BYELOSOTOK (Polish, *Białystok*), a town of West Russia, in the government of and 53 m. by rail S.W. of the city of Grodno, on the main railway line from Moscow to Warsaw, at its junction with the Kiev-Grayevo (Prussian frontier) line. Founded in 1320, it became part of Prussia after the third partition of Poland, but was annexed to Russia in 1807, after the peace of Tilait. Its development dates from 1845, when woollen-mills were built. Since that time it has grown very rapidly, its population being 13,787 in 1857; 56,629 in 1889; and 65,781 in 1901; three-fourths Jews. Its woollen, silk and felt hat factories give occupation to several thousand workers.

BYEZHETSK, a town of Russia, in the government of Tver, and 70 m. N.N.E. of the city of that name, on the right bank of the Mologa, in 57° 46' N. lat. and 36° 43' E. long. Pop. (1860) 5423; (1897) 9090. It is mentioned in the chronicles of 1137. On the fall of Novgorod, to which it had belonged, it was incorporated (1479) with the grand-duchy of Moscow. The town is famous for its scythes and shearing hooks, but makes also axes, nails and other hardware, and trades in grain, linen, hemp and flax.

BY-LAW, or **BYE-LAW** (*by*-being used in the sense of subordinate or secondary, cf. *by*-path), a regulation made by councils, boards, corporations and companies, usually under statutory power, for the preservation of order and good government within some place or jurisdiction. When made under authority of a statute, by-laws must generally, before they come into operation, be submitted to some confirming authority for sanction and approval; when approved, they are as binding as enacted laws. By-laws must be reasonable in themselves; they must not be retrospective nor contrary to the general law of the land. By various statutes powers are given to borough, county and district councils, to make by-laws for various purposes; corporate bodies, also, are empowered by their charters to make by-laws which are binding on their members. Such by-laws must be in harmony with the objects of the society and must not infringe or limit the powers and duties of its officers.

BYLES, MATHER (1706-1788), American clergyman, was born in Boston, Massachusetts, on the 26th of March 1706, descended, on his mother's side, from John Cotton and Richard Mather. He graduated at Harvard in 1725, and in 1733 became pastor of the Hollis Street church (Congregational), Boston. He held a high rank among the clergy of the province and was noted for his scholarly sermons and his ready wit. At the outbreak of the War of Independence he was outspoken in his advocacy of the royal cause, and after the British evacuation of Boston his connexion with his church was dissolved. He remained in Boston, however, and subsequently (1777) was arrested, tried and sentenced to deportation. This sentence was later changed to imprisonment in his own house. He was soon released, but never resumed his pastorate. He died in Boston on the 5th of July 1788. Besides many sermons he published *A Poem on the Death of George I.* (1727) and *Miscellaneous Poems* (1744).

His son, **MATHER BYLES** (1735-1814), graduated at Harvard in 1751, and was a Congregational clergyman at New London, Connecticut, until 1768, when he entered the Established Church, and became rector of Christ church, Boston. Sympathizing with the royal cause, he settled, after the War of Independence, in St Johns, New Brunswick, where he was rector of a church until his death.

BYNG, JOHN (1704-1757), British admiral, was the fourth son of George Byng, Lord Torrington, and entered the navy in 1718. The powerful influence of his father accounts for his rapid rise in the service. He received his first appointment as lieutenant in 1723, and became captain in 1727. His career presents nothing of note till after his promotion as rear-admiral in 1745, and as vice-admiral in 1747. He served on the most comfortable stations, and avoided the more arduous work of the navy. On the approach of the Seven Years' War the island of Minorca was threatened by an attack from Toulon and was actually invaded in 1756. Byng, who was then serving in the Channel with the rank of admiral, which he attained in 1755, was ordered to the Mediterranean to relieve the garrison of Fort St Philip, which was still holding out. The squadron was not very well manned, and Byng was in particular much aggrieved because his marines were landed to make room for the soldiers who were to reinforce the garrison, and he feared that if he met a French squadron after he had lost them he would be dangerously undermanned. His correspondence shows clearly that he left prepared for failure, that he did not believe that the garrison could hold out against the French force landed, and that he was already resolved to come back from Minorca if he found that the task presented any great difficulty. He wrote home to that effect to the ministry from Gibraltar. The governor

of the fortress refused to spare any of his soldiers to increase the relief for Minorca, and Byng sailed on the 8th of May. On the 19th he was off Minorca, and endeavoured to open communications with the fort. Before he could land any of the soldiers, the French squadron appeared. A battle was fought on the following day. Byng, who had gained the weather gauge, bore down on the French fleet of M. de la Galissonnière at an angle, so that his leading ships came into action unsupported by the rest of his line. The French cut the leading ships up, and then slipped away. When the flag captain pointed out to Byng that by standing out of his line he could bring the centre of the enemy to closer action, he declined on the ground that Thomas Mathews had been condemned for so doing. The French, who were equal in number to the English, got away undamaged. After remaining near Minorca for four days without making any further attempt to communicate with the fort or sighting the French, Byng sailed away to Gibraltar leaving Fort St Philip to its fate. The failure caused a savage outburst of wrath in the country. Byng was brought home, tried by court-martial, condemned to death, and shot on the 14th of March 1757 at Portsmouth. The severity of the penalty, aided by a not unjust suspicion that the ministry sought to cover themselves by throwing all the blame on the admiral, led in after time to a reaction in favour of Byng. It became a commonplace to say that he was put to death for an error of judgment. The court had indeed acquitted him of personal cowardice or of disaffection, and only condemned him for not having done his utmost. But it must be remembered that in consequence of many scandals which had taken place in the previous war the Articles of War had been deliberately revised so as to leave no punishment save death for the officer of any rank who did not do his utmost against the enemy either in battle or pursuit. That Byng had not done all he could is undeniable, and he therefore fell under the law. Neither must it be forgotten that in the previous war in 1745 an unhappy young lieutenant, Baker Phillips by name, whose captain had brought his ship into action unprepared, and who, when his superior was killed, surrendered the ship when she could no longer be defended, was shot by sentence of a court-martial. This savage punishment was approved by the higher officers of the navy, who showed great lenity to men of their own rank. The contrast had angered the country, and the Articles of War had been amended precisely in order that there might be one law for all.

The facts of Byng's life are fairly set out in Charnock's *Biogr. N.* vol. iv. pp. 145 to 179. The number of contemporary pamphlets about his case is very great, but they are of no historical value, except as illustrating the state of public opinion. (D. H.)

BYNKERSHOEK, CORNELIUS VAN (1673-1743), Dutch jurist, was born at Middleburg in Zeeland. In the prosecution of his legal studies, and while holding the offices first of member and afterwards of president of the supreme court, he found the common law of his country so defective as to be nearly useless for practical purposes. This abuse he resolved to reform, and took as the basis of a new system the principles of the ancient Roman law. His works are very voluminous. The most important of them are *De Jure legatorum* (1702); *Observationes Juris Romani* (1710), of which a continuation in four books appeared in 1733; the treatise *De Dominio Maris* (1721); and the *Quaestiones Juris Publici* (1737). Complete editions of his works were published after his death; one in folio at Geneva in 1761, and another in two volumes folio at Leiden in 1766.

BYRD, WILLIAM (1543-1623), English musical composer, was probably a member of one of the numerous Lincolnshire families of the name who were to be found at Lincoln, Spalding, Pinchbeck, Moulton and Epworth in the 16th century. According to Wood, he was "bred up to musick under Thomas Tallis." He was appointed organist of Lincoln cathedral about 1563, and on the 14th of September 1568 was married at St Margaret in the Close to Ellen or Julian Birley. On the 22nd of February 1569 he was sworn in as a member of the Chapel Royal, but he does not seem to have left Lincoln immediately. In the Chapel Royal he shared with Tallis the honorary post of organist, and on the 22nd

of January 1575 the two composers obtained a licence for twenty-one years from Elizabeth to print music and music-paper, a monopoly which does not seem to have been at all remunerative. In 1575 Byrd and Tallis published a collection of Latin motets for five and six voices, printed by Thomas Vautrollier. In 1578 Byrd and his family were living at Harlington, Middlesex. As early as 1581 his name occurs among lists of recusants, and though he retained his post in the Chapel Royal he was throughout his life a Catholic. About 1579 he set a three-part song in Thomas Legge's Latin play *Ricardus Tertius*. In 1588 he published *Psalmes, Sonets and Songs of Sadnes and Pietie*, and in the same year contributed two madrigals to Nicolas Yonge's *Musica Transalpina*. In 1589 appeared *Songs of Sundrie Natures*, a second edition of which was issued in 1610. In the same year he published *Liber Primus Sacrarum Cantionum*, a second series of which was brought out in 1591. In 1590 two madrigals by Byrd were included in Thomas Watson's *First Set of Italian Madrigalls Englished*; one of these seems to have been sung before Queen Elizabeth on her visit to Lord Hertford at Elvetham in 1591. In April 1592 Byrd was still living at Harlington, but about 1593 he became possessed of the remainder of a lease of Stondon Place, Essex, a farm of some 200 acres, belonging to William Shelley, who was shortly afterwards convicted of high treason. The property was sequestered, and on the 15th of July 1595 Byrd obtained a crown lease of it for the lives of his eldest son Christopher and his daughters Elizabeth and Rachel. On the death of Shelley his son bought back his estates (in 1604), whereupon his widow attempted to oust Byrd from Stondon Place, on the ground that it formed part of her jointure. Byrd was upheld in his possession of the property by James I. (*Calendar of State Papers, Dom. Series*, James I. add. series, vol. xxxvi.), but Mrs Shelley persevered in her suit, apparently until her death in 1609. In the following year the matter was settled for a time by Byrd's buying Stondon Place in the names of John and Thomas Petre, part of the property being charged with a payment to Byrd of £20 for his life, with remainder to his second son Thomas. Throughout this long suit Byrd, though in possession of property which had been confiscated from a recusant and actually taking part as a member of the Chapel Royal at the coronation of James I., had been excommunicated since 1598, while from 1605 until 1612, and possibly later, he was regularly presented before the archidiaconal court of Essex as a Catholic. In 1603 Easte published a work (no copies of which are known to exist) entitled *Médulla Musicks*. *Sucked out of the scappe of two [of] the most famous Musitionns that ever were in this land, namely Master Wyllyam Byrd . . . and Master Alphonso Ferabosca . . . either of whom having made 40th severall voicles (without contention), showing most rare and intricate skill in 2 partes in one upon the playne song Miserere*. In 1607 appeared two books of *Gradualia*, a second edition of which was issued in 1610. In the following year he published *Psalmes, Songs and Sonnets; some solemne, others joyfull, framed to the life of the Words*. Probably in the same year was issued *Parthenia*, a collection of virginal music, in which Byrd was associated with Bull and Orlando Gibbons. The last work to which he contributed was Sir Thomas Leighton's *Tears or Lamentations of a Sorrowfull Soule* (1614). His death took place on the 4th of July 1623. It is recorded in the *Cheque Book* of the Chapel Royal as that of a "father of musicke." His will, dated the 15th of November 1622, shows that he remained a Catholic until the end of his life, and he expresses a desire that he may die at Stondon and be buried near his wife. From the same document it seems that his latter years had been embittered by a dispute with his eldest son, but that the matter was settled by an agreement with his daughter-in-law Catherine, to whom he left his property at Stondon, charged with the payment of £20 to his second son Thomas and £10 to his daughter Rachel, with remainder to his grandson Thomas and his second son of the same name. In 1635 the estate again came before the court of chancery, on the ground that the annuities had not been paid. The property seems about 1637 to have been let to one John Leigh, and in 1652 was held by a member of the Petre family. The committee for

compounding with delinquents at that date allowed Thomas Byrd the annuity of £20 bequeathed by his father. Byrd's arms, as entered in the Visitation of Essex of 1634 *ex sigillo* were three stags' heads cabossed, a canton ermine. His children were (1) Christopher, who married Catherine, daughter of Thomas Moore of Bamborough, and had a son, Thomas, living at Stondon in 1634; (2) Thomas; (3) Elizabeth, who married successively John Jackson and—Burdett; (4) Rachel, married (1)—Hook, by whom she had two children, William and Catherine, married to Michael Walton; in 1634 Rachel Hook had married (2) Edward Biggs; (5) Mary, married (1) Henry Hawksworth, by whom she had four sons, William, Henry, George and John; (2) Thomas Falconbridge. Anne Byrd, who is mentioned in the proceedings *Shelley v. Byrd* (*Exchequer Decrees*, 7 James I., series ii. vol. vii. fol. 294 and 328), was probably a fourth daughter who died young.

Besides the works already mentioned Byrd was the composer of three masses, for three, four and five voices respectively, which seem to have been published with some privacy about 1588. There exists a second edition (also undated) of the four-part mass; all three have recently appeared in modern editions, and increase Byrd's claim to rank as the greatest English composer of his age. In addition to his published works, a large amount still remains in MS., comprising nearly every kind of composition. The Fitzwilliam *Virginal Book* contains a long series of interesting pieces for the virginal, and more still remains unpublished in Lady Neville's *Virginal Book* and other contemporary collections. His industry was enormous, and though his work is unequal and the licences he allowed can hardly be defended on strict grounds, his Latin church music and his instrumental compositions entitle him to high rank among his contemporaries. As a madrigalist he was inferior to Morley, Wilbye and Gibbons, though even in this branch of his art he often displays great charm and individuality. (W. B. S.)

BYROM, JOHN (1692–1763), English poet, writer of hymns and inventor of a system of shorthand, was born at Kersal Cell, near Manchester, on the 29th of February 1692, the younger son of a prosperous merchant. He was educated at Merchant Taylors school, and at Trinity College, Cambridge, of which he became a fellow in 1714. His first poem, "Colin to Phoebe," a pastoral, appeared in the *Spectator*, No. 603. The heroine is said to have been Dr Bentley's daughter, Joanna, the mother of Richard Cumberland, the dramatist. After leaving the university Byrom went abroad, ostensibly to study medicine, but he never practised and possibly his errand was really political, for he was an adherent of the Pretender. He was elected a member of the Royal Society in 1724. On his return to London he married his cousin in 1721, and to support himself taught a new method of shorthand of his own invention, till he succeeded (1740) to his father's estate on the death of his elder brother. His diary gives interesting portraits and letters of the many great men of his time whom he knew intimately. He died on the 26th of September 1763. A collection of his poems was published in 1773, and he is included in Alexander Chalmers's *English Poets*. His system of shorthand was not published until after his death, when it was printed as *The Universal English Shorthand; or the way of writing English in the most easy, concise, regular and beautiful manner, applicable to any other language, but particularly adjusted to our own* (Manchester, 1767).

The Private Journal and Literary Remains of John Byrom, related by Richard Parkinson, D.D., was published by the Chetham Society (1854–1857).

BYRON, GEORGE GORDON BYRON, 6TH BARON (1788–1824), English poet, was born in London at 16 Holles Street, Cavendish Square, on the 22nd of January 1788. The Byrons were of Norman stock, but the founder of the family was Sir John Byron, who entered into possession of the priory and lands of Newstead in the county of Nottingham in 1540. From him it descended (but with a bar-sinister) to a great-grandson, John (1st Baron) Byron (g.s.), a Cavalier general, who was raised to the peerage in 1643. The first Lord Byron died childless, and was succeeded by his brother Richard, the great-grandfather of William, the 5th lord, who outlived son and grandson, and was

succeeded by his great-nephew, the poet. Admiral the Hon. John Byron (q.v.) was the poet's grandfather. His eldest son, Captain John Byron, the poet's father, was a libertine by choice and in an eminent degree. He caused to be divorced, and married (1779) as his first wife, the marchioness of Carmarthen (born Amelia D'Arcey), Baroness Conyers in her own right. One child of the marriage survived, the Hon. Augusta Byron (1783-1851), the poet's half-sister, who, in 1807, married her first cousin, Colonel George Leigh. His second marriage to Catherine Gordon (b. 1765) of Gight in Aberdeenshire took place at Bath on the 13th of May 1785. He is said to have squandered the fortunes of both wives. It is certain that Gight was sold to pay his debts (1786), and that the sole provision for his wife was a settlement of £3000. It was an unhappy marriage. There was an attempt at living together in France, and, when this failed, Mrs Byron returned to Scotland. On her way thither she gave birth to a son, christened George Gordon after his maternal grandfather, who was descended from Sir William Gordon of Gight, grandson of James I. of Scotland. After a while her husband rejoined her, but went back to France and died at Valenciennes on the 2nd of August 1791. His wife was not a bad woman, but she was not a good mother. Vain and capricious, passionate and self-indulgent, she mismanaged her son from his infancy, now provoking him by her foolish fondness, and now exciting his contempt by her paroxysms of impotent rage. She neither looked nor spoke like a gentlewoman; but in the conduct of her affairs she was praiseworthy. She hated and avoided debt, and when relief came (a civil list pension of £300 a year) she spent most of it upon her son. Fairly well educated, she was not without a taste for books, and her letters are sensible and to the point. But the violence of her temper was abnormal. Her father committed suicide, and it is possible that she inherited a tendency to mental derangement. If Byron owed anything to his parents it was a plea for pardon.

The poet's first years were spent in lodgings at Aberdeen. From 1794 to 1798 he attended the grammar school, "threading all classes" till he reached the fourth. It was a good beginning, a solid foundation, enabling him from the first to keep a hand over his talents and to turn them to a set purpose. He was lame from his birth. His right leg and foot, possibly both feet, were contracted by infantile paralysis, and, to strengthen his muscles, his mother sent him in the summers of 1796, 1797 to a farm house on Deaside. He walked with difficulty, but he wandered at will, soothed and inspired by the grandeur of the scenery. To his Scottish upbringing he owed his love of mountains, his love and knowledge of the Bible, and too much Calvinism for faith or unfaith in Christianity. The death of his great-uncle (May 10, 1798) placed him in possession of the title and estates. Early in the autumn Mrs Byron travelled south with her son and his nurse, and for a time made her home at Newstead Abbey. Byron was old enough to know what had befallen him. "It was a change from a shabby Scotch flat to a palace," a half-ruined palace, indeed, but his very own. It was a proud moment, but in a few weeks he was once more in lodgings. The shrunken leg did not improve, and acting on bad advice his mother entrusted him to the care of a quack named Lavender, truss-maker to the general hospital at Nottingham. His nurse who was in charge of him maltreated him, and the quack tortured him to no purpose. At his own request he read Virgil and Cicero with a tutor.

In August 1799 he was sent to a preparatory school at Dulwich. The master, Dr Glennie, perceived that the boy liked reading for its own sake and gave him the free run of his library. He read a set of the *British Poets* from beginning to end more than once. This, too, was an initiation and a preparation. He remained at Dulwich till April 1801, when, on his mother's intervention, he was sent to Harrow. His school days, 1801-1805, were fruitful in two respects. He learned enough Latin and Greek to make him a classic, if not a classical scholar, and he made friends with his equals and superiors. He learned something of his own worth and of the worth of others. "My school-friendships," he says, "were with me passions." Two of his closest friends died young, and from Lord Clare, whom he loved best of all, he was separated

by chance and circumstance. He was an odd mixture, now lying dreaming on his favourite tombstone in the churchyard, now the ring-leader in whatever mischief was afoot. He was a "record" swimmer, and, in spite of his lameness, enough of a cricketer to play for his school at Lord's, and yet he found time to read and master standard works of history and biography, and to acquire more general knowledge than boys and masters put together.

In the midsummer of 1803, when he was in his sixteenth year, he fell in love, once for all, with his distant relative, Mary Anne Chaworth, a "minor heiress" of the hall and park of Annesley which marches with Newstead. Two years his senior, she was already engaged to a neighbouring squire. There were meetings half-way between Newstead and Annesley, of which she thought little and he only too much. What was sport to the girl was death to the boy, and when at length he realized the "hopelessness of his attachment," he was "thrown out," as he said, "alone, on a wide, wide sea." She is the subject of at least five of his early poems, including the pathetic stanzas, "Hills of Annesley," and there are allusions to his love story in *Childe Harold* (c. 1.1.1.), and in "The Dream" (1816).

Byron went into residence at Trinity College, Cambridge, in October 1805. Cambridge did him no good. "The place is the devil," he said, and according to his own showing he did homage to the *genius loci*. But whatever he did or failed to do, he made friends who were worthy of his choice. Among them were the scholar-dandy Scrope Berdmore Davies, Francis Hodgson, who died provost of Eton, and, best friend of all, John Cam Hobhouse (afterwards Lord Brougham). And there was another friend, a chorister named Edleston, a "humble youth" for whom he formed a romantic attachment. He died whilst Byron was still abroad (May 1811), but not unwept nor unsung, if, as there is little doubt, the mysterious Thyra poems of 1811, 1812 refer to his death. During the vacation of 1806, and in 1807 which was one "long vacation," he took to his pen, and wrote, printed and published most of his "Juvenile Poems." His first venture was a thin quarto of sixty-six pages, printed by S. and J. Ridge of Newark. The "advertisement" is dated the 23rd of December 1806, but before that date he had begun to prepare a second collection for the press. One poem ("To Mary") contained at least one stanza which was frankly indecent, and yielding to advice he gave orders that the entire issue should be thrown into the fire. Early in January 1807 an expurgated collection entitled *Poems on Various Occasions* was ready for private distribution. Encouraged by two critics, Henry Mackenzie and Lord Woodhouselee, he determined to recast this second issue and publish it under his own name. *Hours of Idleness*, "by George Gordon Lord Byron, a minor," was published in June 1807. The fourth and last issue of *Juvenilia*, entitled *Poems, Original and Translated*, was published in March 1808.

Hours of Idleness enjoyed a brief triumph. The *Critical* and other reviews were "very indulgent," but the *Edinburgh Review* for January 1808 contained an article, not, as Byron believed, by Jeffrey, but by Brougham, which put, or tried to put, the author and "his poetry" to open shame. The sole result was that it supplied fresh material and a new title for some rhyming couplets on "British Bards" which he had begun to write. A satire on Jeffrey, the editor, and Lord Holland, the patron of the *Edinburgh Review*, was slipped into the middle of "British Bards," and the poem rechristened *English Bards and Scotch Reviewers* (published the 1st of March 1809).

In April 1808, whilst he was still "a minor," Byron entered upon his inheritance. Hitherto the less ruinous portions of the abbey had been occupied by a tenant, Lord Grey de Ruthven. The banqueting hall, the grand drawing-room, and other parts of the monastic building were uninhabitable, but by incurring fresh debts, two sets of apartments were refurbished for Byron and for his mother. Dismantled and ruinous, it was still a splendid inheritance. In line with the front of the abbey is the west front of the priory church, with its hollow arch, once a "mighty window," its vacant niches, its delicate Gothic mouldings. The abbey buildings enclose a grassy quadrangle

overlooked by two-storeyed cloisters. On the eastern side are the state apartments occupied by kings and queens not as guests, but by feudal right. In the park, which is part of Sherwood Forest, there is a chain of lakes—the largest, the north-west, Byron's "lucid lake." A waterfall or "cascade" issues from the lake, in full view of the room where Byron slept. The possession of this lordly and historic domain was an inspiration in itself. It was an ideal home for one who was to be hailed as the spirit or genius of romance.

On the 13th of March 1809, he took his seat in the House of Lords. He had determined, as soon as he was of age, to travel in the East, but before he sought "another zone" he invited Hobhouse and three others to a house-warming. One of the party, C. S. Matthews, describes a day at Newstead. Host and guests lay in bed till one. "The afternoon was passed in various diversions, fencing, single-stick . . . riding, cricket, sailing on the lake." They dined at eight, and after the cloth was removed handed round "a human skull filled with Burgundy." After dinner they "buffooned about the house" in a set of monkish dresses. They went to bed some time between one and three in the morning. Moore thinks that the picture of these festivities is "pregnant in character," and argues that there were limits to the misbehaviour of the "wassailers." The story, as told in *Childe Harold* (c. 1. s. v.-ix.), need not be taken too seriously. Byron was angry because Lord De La Warr did not wish him good-bye, and visited his displeasure on friends and "lemans" alike. May and June were devoted to the preparation of an enlarged edition of his satire. At length, accompanied by Hobhouse and a small staff of retainers, he set out on his travels. He sailed from Falmouth on the 2nd of July and reached Lisbon on the 7th of July 1809. The first two cantos of *Childe Harold's Pilgrimage* contain a record of the principal events of his first year of absence.

The first canto describes Lisbon, Cintra, the ride through Portugal and Spain to Seville and thence to Cadiz. He is moved by the grandeur of the scenery, but laments the helplessness of the people and their impending fate. Talavera was fought and won whilst he was in Spain, but he is convinced that the "Scourge of the World" will prevail, and that Britain, "the fond ally," will display her blundering heroism in vain. Being against the government, he is against the war. History has falsified his politics, but his descriptions of places and scenes, of "Morena's dusky height," of Cadiz and the bull-fight, retain their freshness and their warmth.

Byron sailed from Gibraltar on the 16th of August, and spent a month at Malta making love to Mrs Spencer Smith (the "Fair Florencia" of c. 12. s. xxix.-xxxiii.). He anchored off Prevesa on the 28th of September. The second canto records a journey on horseback through Albania, then almost a *terra incognita*, as far as Tepeleni, where he was entertained by Ali Pacha (October 20th), a yachting tour along the shores of the Ambracian Gulf (November 8-23), a journey by land from Larnaki to Athens. (December 15-25), and excursions in Attica, Sunium and Marathon (January 13-25, 1810).

Of the tour in Asia Minor, a visit to Ephesus (March 15, 1810), an excursion in the Troad (April 13), and the famous swim across the Hellespont (May 3), the record is to be sought elsewhere. The stanzas on Constantinople (lxvii.-lxxxii.), where Byron and Hobhouse stayed for two months, though written at the time and on the spot, were not included in the poem till 1814. They are, probably, part of a projected third canto. On the 14th of July Hobhouse set sail for England and Byron returned to Athens.

Of Byron's second year of residence in the East little is known beyond the bare facts that he was travelling in the Morea during August and September, that early in October he was at Patras, having just recovered from a severe attack of malarial fever, and that by the 14th of November he had returned to Athens and taken up his quarters at the Franciscan convent. Of his movements during the next five months there is no record, but of his studies and pursuits there is substantial evidence. He learnt Romaine, he compiled the notes to the second canto of *Childe Harold*. He wrote (March 12) *Hints from Horace* (published

1831), an imitation or loose translation of the *Epistola ad Pisones* (Art of Poetry), and (March 17) *The Curse of Minerva* (published 1815), a skit on Lord Elgin's deportation of the metopes and frieze of the Parthenon.

He left Athens in April, passed some weeks at Malta, and landed at Portsmouth (c. July 20). Arrived in London his first step was to consult his literary adviser, R. C. Dallas, with regard to the publication of *Hints from Horace*. Of *Childe Harold* he said nothing, but after some hesitation produced the MS. from a "small trunk," and, presenting him with the copyright, commissioned Dallas to offer it to a publisher. Rejected by Miller of Albemarle Street, who published for Lord Elgin, it was finally accepted by Murray of Fleet Street, who undertook to share the profits of an edition with Dallas.

Meanwhile Mrs Byron died suddenly from a stroke of apoplexy. Byron set off at once for Newstead, but did not find his mother alive. He had but little affection for her while she lived, but her death touched him to the quick. "I had but one friend," he exclaimed, "and she is gone." Another loss awaited him. Whilst his mother lay dead in his house, he heard that his friend Matthews had been drowned in the Cam. Edleston and Wingfield had died in May, but the news had reached him on landing. There were troubles on every side. On the 11th of October he wrote the "Epistle to a Friend" ("Oh, banish care," &c.) and the lines "To Thyra," which, with other elegies, were appended to the second edition of *Childe Harold* (April 17, 1812). It was this cry of desolation, this open profession of melancholy, which at first excited the interest of contemporaries, and has since been decried as morbid and unreal. No one who has read his letters can doubt the sincerity of his grief, but it is no less true that he measured and appraised its literary significance. He could and did turn it to account.

Towards the close of the year he made friends with Moore. Some lines in *English Bards*, &c. (ii. 466-467), taunting Moore with fighting a duel with Jeffrey with "leadless pistol" had led to a challenge, and it was not till Byron returned to England that explanations ensued, and that the challenge was withdrawn. As a poet Byron outgrew Moore, giving back more than he had received, but the friendship which sprang up between them still serves Byron in good stead. Moore's *Life of Byron* (1830) is no doubt a picture of the man at his best, but it is a genuine likeness. At the end of October Byron moved to London and took up his quarters at 8 St James's Street. On the 27th of February 1812 he made his first speech in the House of Lords on a bill which made the wilful destruction of certain newly invented stocking-frames a capital offence, speaking in defence of the riotous "hands" who feared that their numbers would be diminished by improved machinery. It was a brilliant speech and won the praise of Burdett and Lord Holland. He made two other speeches during the same session, but thenceforth pride or laziness kept him silent. *Childe Harold* (4to) was published on Tuesday, the 10th of March 1812. "The effect," says Moore, "was . . . electric, his fame . . . seemed to spring, like the palace of a fairy king, in a night." A fifth edition (8vo) was issued on the 5th of December 1812. Just turned twenty-four he "found himself famous," a great poet, a rising statesman. Society, which in spite of his rank had neglected him, was now at his feet. But he could not keep what he had won. It was not only "villainous company," as he put it, which was to prove his "spoil," but the opportunity for intrigue. The excitement and absorption of one reigning passion after another destroyed his peace of mind and put him out of conceit with himself. His first affair of any moment was with Lady Caroline Lamb, the wife of William Lamb, better known as Lord Melbourne, a delicate, golden-haired sprite, who threw herself in his way, and afterwards, when she was shaken off, involved him in her own disgrace. To her succeeded Lady Oxford, who was double his own age, and Lady Frances Wedderburn Webster, the "Ginevra" of his sonnets, the "Medora" of *The Corsair*.

His "way of life" was inconsistent with an official career, but there was no slackening of his poetical energies. In February 1813 he published *The Walks* (anonymously), he wrote and

published *The Giaour* (published June 5, 1813) and *The Bride of Abydos* (published November 29, 1813), and he wrote *The Corsair* (published February 1, 1814). *The Turkish Tales* were even more popular than *Childe Harold*. Murray sold 10,000 copies of *The Corsair* on the day of publication. Byron was at pains to make his accessories correct. He prided himself on the accuracy of his "costume." He was under no delusion as to the ethical or artistic value of these experiments on "public patience."

In the summer of 1813 a new and potent influence came into his life. Mrs Leigh, whose home was at Newmarket, came up to London on a visit. After a long interval the brother and sister met, and whether there is or is not any foundation for the dark story obscurely hinted at in Byron's lifetime, and afterwards made public property by Mrs Beecher Stowe (*Macmillan's Magazine*, 1869, pp. 377-396), there is no question as to the depth and sincerity of his love for his "one relative,"—that her well-being was more to him than his own. Byron passed the "seasons" of 1813, 1814 in London. His manner of life we know from his journals. Socially he was on the crest of the wave. He was a welcome guest at the great Whig houses, at Lady Melbourne's, at Lady Jersey's, at Holland House. Sheridan and Moore, Rogers and Campbell, were his intimates and companions. He was a member of the Alfred, of Watier's, of the Cocoa Tree, and half a dozen clubs besides. After the publication of *The Corsair* he had promised an interval of silence, but the abdication of Napoleon evoked "An Ode," &c., in his dishonour (April 16); *Lara*, a Tale, an informal sequel to *The Corsair*, was published anonymously on August 6, 1814.

Newstead had been put up for sale, but pending the completion of the contract was still in his possession. During his last visit but one, whilst his sister was his guest, he became engaged to Miss Anna Isabella Milbanke (b. May 17, 1792; d. May 16, 1860), the only daughter of Sir Ralph Milbanke, Bart., and the Hon. Judith (born Noel), daughter of Lord Wentworth. She was an heiress, and in succession to a peerage in her own right (becoming Baroness Wentworth in 1856). She was a pretty girl of "a perfect figure," highly educated, a mathematician, and, by courtesy, a poetess. She had rejected Byron's first offer, but, believing that her cruelty had broken his heart and that he was an altered man, she was now determined on marriage. High-principled, but self-willed and opinionated, she believed that she held her future in her own hands. On her side there was ambition touched with fancy—on his, a wish to be married and some hope perhaps of finding an escape from himself. The marriage took place at Seaham in Durham on the 2nd of January 1815. Bride and bridegroom spent three months in paying visits, and at the end of March settled at 13 Piccadilly Terrace, London.

Byron was a member of the committee of management of Drury Lane theatre, and devoted much of his time to his professional duties. He wrote but little poetry. *Hebrew Melodies* (published April 1815), begun at Seaham in October 1814, were finished and given to the musical composer, Isaac Nathan, for publication. *The Siege of Corinth* and *Parisina* (published February 7, 1816) were got ready for the press. On the 10th of December Lady Byron gave birth to a daughter christened Augusta Ada. To judge from his letters, for the first weeks or months of his marriage things went smoothly. His wife's impression was that Byron "had avowedly begun his revenge from the first." It is certain that before the child was born his conduct was so harsh, so violent, and so eccentric, that she believed, or tried to persuade herself, that he was mad.

On the 15th of January 1816 Lady Byron left London for her father's house, claimed his protection, and after some hesitation and consultation with her legal advisers demanded a separation from her husband. It is a matter of common knowledge that in 1869 Mrs Beecher Stowe affirmed that Lady Byron expressly told her that Byron was guilty of incest with his half-sister, Mrs Leigh; also that in 1905 the second Lord Lovelace (Lord Byron's grandson) printed a work entitled *Asarte* which was designed to uphold and to prove the truth of this charge. It is a fact that neither Lady Byron nor her advisers

supported their demand by this or any other charge of misconduct, but it is also a fact that Lord Byron yielded to the demand reluctantly, under pressure and for large pecuniary considerations. It is a fact that Lady Byron's letters to Mrs Leigh before and after the separation are inconsistent with a knowledge or suspicion of guilt on the part of her sister-in-law, but it is also a fact (see *Asarte*, pp. 142-145) that she signed a document (dated March 14, 1816) to the effect that any renewal of intercourse did not involve and must not be construed as a withdrawal of the charge. It cannot be doubted that Lady Byron's conviction that her husband's relations with his half-sister before his marriage had been of an immoral character was a factor in her demand for a separation, but whether there were other and what issues, and whether Lady Byron's conviction was founded on fact, are questions which have not been finally answered. Lady Byron's charge, as reported by Mrs Beecher Stowe and upheld by the 2nd earl of Lovelace, is "non-proven." Mr Robert Edgcomb, in *Byron: the Last Phase* (1909), insists that Mary Chaworth was the real object of Byron's passion, and that Mrs Leigh was only shielding her.

The separation of Lord and Lady Byron was the talk of the town. Two poems entitled "Fare Thee Well" and "A Sketch," which Byron had written and printed for private circulation, were published by *The Champion* on Sunday, April 14. The other London papers one by one followed suit. The poems, more especially "A Sketch," were provocative of criticism. There was a balance of opinion, but politics turned the scale. Byron had recently published some pro-Gallican stanzas, "On the 'Star of the Legion of Honour,'" in the *Examiner* (April 7), and it was felt by many that private dishonour was the outcome of public disloyalty. The Whigs defended Byron as best they could, but his own world, with one or two exceptions, ostracized him. The "excommunicating voice of society," as Moore put it, was loud and insistent. The articles of separation were signed on or about the 18th of April, and on Sunday, the 25th of April, Byron sailed from Dover for Ostend. The "Lines on Churchill's Grave" were written whilst he was waiting for a favourable wind. His route lay through the Low Countries, and by the Rhine to Switzerland. On his way he halted at Brussels and visited the field of Waterloo. He reached Geneva on the 25th of May, where he met by appointment at Dejean's Hôtel d'Angleterre, Shelley, Mary Godwin and Claire (or "Claire") Clairmont. The meeting was probably at the instance of Claire, who had recently become, and aspired to remain, Byron's mistress. On the 10th of June Byron moved to the Villa Diodati on the southern shore of the lake. Shelley and his party had already settled at an adjoining villa, the Campagne Montalègre. The friends were constantly together. On the 23rd of June Byron and Shelley started for a yachting tour round the lake. They visited the castle of Chillon on the 26th of June, and, being detained by weather at the Hôtel de l'Ancre, Ouchy, Byron finished (June 27-29) the third canto of *Childe Harold* (published November 18), and began the *Prisoner of Chillon* (published December 5, 1816). These and other poems of July-September 1816, e.g. "The Dream" and the first two acts of *Manfred* (published June 16, 1817), betray the influence of Shelley, and through him of Wordsworth, both in thought and style. Byron knew that Wordsworth had power, but was against his theories, and resented his criticism of Pope and Dryden. Shelley was a believer and a disciple, and converted Byron to the Wordsworthian creed. Moreover he was an inspiration in himself. Intimacy with Shelley left Byron a greater poet than he was before. Byron passed the summer at the Villa Diodati, where he also wrote the *Monody on the Death of Sheridan*, published September 9, 1816. The second half of September was spent and devoted to "an excursion in the mountains." His journal (September 18-29), which was written for and sent to Mrs Leigh, is a great prose poem, the source of the word pictures of Alpine scenery in *Manfred*. His old friend Hobhouse was with him and he enjoyed himself, but at the close he confesses that he could not lose his "own wretched identity" in the "majesty and the power and the glory" of nature. Remorse was scotched, not

killed. On the 6th of October Byron and Hobhouse started via Milan and Verona for Venice, which was reached early in November. For the next three years Byron lived in or near Venice—at first, 1816-1817, in apartments in the Fresseria, and after January 1818 in the central block of the Mocenigo palace. Venice appealed both to his higher and his lower nature. He set himself to study her history, to understand her constitution, to learn her language. The sights and scenes with which Shakespeare and Otway, Schiller's *Ghostseer*, and Madame de Staël's *Corinne* had made him familiar, were before his eyes, not dreams but realities. He would "repeople" her with her own past, and "stamp her image" on the creations of his pen. But he had no one to live for but himself, and that self he gave over to a reprobate mind. He planned and pursued a life of deliberate profligacy. Of two of his amours we learn enough or too much from his letters to Murray and to Moore—the first with his landlord's wife, Marianna Segati, the second with Margarita Coggi (the "Fornarina"), a Venetian of the lower class, who amused him with her savagery and her wit. But, if Shelley may be trusted, there was a limit to his candour. There is abundant humour, but there is an economy of detail in his pornographic chronicle. He could not touch pitch without being defiled. But to do him justice he was never idle. He kept his brains at work, and for this reason, perhaps, he seems for a time to have recovered his spirits and sinned with a good courage. His song of carnival, "So we'll go no more a-roving," is a hymn of triumph. About the middle of April he set out for Rome. His first halt was at Ferrara, which inspired the "Lament of Tasso" (published July 17, 1817). He passed through Florence, where he saw "the Venus" (of Medici) in the Uffizi Gallery, by reedy Thrasymene and Terni's "matchless cataract" to "Rome the Wonderful." At Rome, with Hobhouse as companion and guide, he stayed three weeks. He returned to Venice on the 28th of May, but shortly removed to a villa at Mira on the Brenta, some 7 m. inland. A month later (June 26) when memory had selected and reduced to order the first impressions of his tour, he began to work them up into a fourth canto of *Childe Harold*. A first draft of 126 stanzas was finished by the 29th of July; the 60 additional stanzas which made up the canto as it stands were written up to material suggested by or supplied by Hobhouse, "who put his researches" at Byron's disposal and wrote the learned and elaborate notes which are appended to the poem. Among the books which Murray sent out to Venice was a copy of Hookham Frere's *Whistlecraft*. Byron took the hint and produced *Beppo*, a *Venetian Story* (published anonymously on the 28th of February 1818). He attributes his choice of the mock heroic *ottava-rima* to Frere's example, but he was certainly familiar with Casti's *Novelle*, and, according to Stendhal, with the poetry of Buratti. The success of *Beppo* and a growing sense that "the excellent manner of *Whistlecraft*" was the manner for him, led him to study Frere's masters and models, Berni and Pulci. An accident had led to a great discovery.

The fourth canto of *Childe Harold* was published on the 28th of April 1818. Nearly three months went by before Murray wrote to him, and he began to think that his new poem was a failure. Meanwhile he completed an "Ode on Venice," in which he laments her apathy and decay, and contrasts the tyranny of the Old World with the new birth of freedom in America. In September he began *Don Juan*. His own account of the inception of his last and greatest work is characteristic but misleading. He says (September 9) that his new poem is to be in the style of *Beppo*, and is "meant to be a little quietly facetious about everything." A year later (August 12, 1819), he says that he neither has nor had a plan—but that "he had or has materials." By materials he means books, such as Dalzell's *Shipwrecks and Disasters by Sea*, or de Castelnau's *Histoire de la nouvelle Russie*, &c., which might be regarded as poetry in the rough. The dedication to Robert Southey (not published till 1833) is a prologue to the play. The "Lakers" had given samples of their poetry, their politics and their morals, and now it was his turn to speak and to speak out. He too would write "An Excursion."

He doubted that *Don Juan* might be "too free for these modest days." It was too free for the public, for his publisher, even for his mistress; and the "building up of the drama," as Shelley puts it, was a slow and gradual process. Cantos I, II, were published (4to) on the 15th of July 1819; Cantos III, IV, V, finished in November 1820, were not published till the 8th of August 1821. Cantos VI, XVII, written between June 1822 and March 1823, were published at intervals between the 15th of July 1823 and the 26th of March 1824. Canto XVII was begun in May 1823, but was never finished. A fragment of fourteen stanzas, found in his room at Missolonghi, was first published in 1903.

He did not put all his materials into *Don Juan*. "Mazeppa, a tale of the Russian Ukraine," based on a passage in Voltaire's *Charles XII.*, was finished by the 30th of September 1818 and published with "An Ode" (on Venice) on the 28th of June 1819. In the spring of 1819 Byron met in Venice, and formed a connexion with, an Italian lady of rank, Teresa (born Gamba), wife of the Cavaliere Guiccioli. She was young and beautiful, well-read and accomplished. Married at sixteen to a man nearly four times her age, she fell in love with Byron at first sight, soon became and for nearly four years remained his mistress. A good and true wife to him in all but name, she won from Byron ample devotion and a prolonged constancy. Her volume of *Recollections* (*Lord Byron jugé par les témoins de sa vie*, 1869), taken for what it is worth, is testimony in Byron's favour. The countess left Venice for Ravenna at the end of April; within a month she sent for Byron, and on the 10th of June he arrived at Ravenna and took rooms in the Strada di Porto Sisi. The house (now No. 295) is close to Dante's tomb, and to gratify the countess and pass the time he wrote the "Prophecy of Dante" (published April 21, 1821). According to the preface the poem was a metrical experiment, an exercise in *terza rima*; but it had a deeper significance. It was "intended for the Italians." Its purport was revolutionary. In the fourth canto of *Childe Harold*, already translated into Italian, he had attacked the powers, and "Albion most of all" for her betrayal of Venice, and knowing that his word had weight he appeals to the country of his adoption to strike a blow for freedom—to "unite." It is difficult to realize the force or extent of Byron's influence on continental opinion. His own countrymen admired his poetry, but abhorred and laughed at his politics. Abroad he was the prophet and champion of liberty. His hatred of tyranny—his defence of the oppressed—was a word spoken in season when there were few to speak but many to listen. It brought consolation and encouragement, and it was not spoken in vain. It must, however, be borne in mind that Byron was more of a king-hater than a people-lover. He was against the oppressors, but he disliked and despised the oppressed. He was aristocrat by conviction as well as birth, and if he espoused a popular cause it was *de haut en bas*. His connexion with the Gambas brought him into touch with the revolutionary movement, and thenceforth he was under the espionage of the Austrian embassy at Rome. He was suspected and "shadowed," but he was left alone.

Early in September Byron returned to La Mira, bringing the countess with him. A month later he was surprised by a visit from Moore, who was on his way to Rome. Byron installed Moore in the Mocenigo palace and visited him daily. Before the final parting (October 11) Byron placed in Moore's hands the MS. of his *Life and Adventures* brought down to the close of 1816. Moore, as Byron suggested, pledged the MS. to Murray for 2000 guineas, to be Moore's property if redeemed in Byron's lifetime, but if not, to be forfeit to Murray at Byron's death. On the 17th of May 1824, with Murray's assent and goodwill, the MS. was burned in the drawing-room of 50 Albemarle Street. Neither Murray nor Moore lost their money. The Longmans lent Moore a sufficient sum to repay Murray, and were themselves repaid out of the receipts of Moore's *Life of Byron*. Byron told Moore that the memoranda were not "confessions," that they were "the truth but not the whole truth." This, no doubt, was the truth, and the whole truth. Whatever they may or may

not have contained, they did not explain the cause or causes of the separation from his wife.¹

At the close of 1819 Byron finally left Venice and settled at Ravenna in his own apartments in the Palazzo Guiccioli. His relations with the countess were put on a regular footing, and he was received in society as her *cavaliere servente*. At Ravenna his literary activity was greater than ever. His translation of the first canto of Pulci's *Morganie Maggiore* (published in the *Liberal*, No. IV., July 30, 1832), a laborious and scholarly achievement, was the work of the first two months of the year. From April to July he was at work on the composition of *Marino Faliero, Doge of Venice*, a tragedy in five acts (published April 21, 1821). The plot turns on an episode in Venetian history known as *La Congiura*, the alliance between the doge and the populace to overthrow the state. Byron spared no pains in preparing his materials. In so far as he is unhistorical, he errs in company with Sanudo and early Venetian chronicles. Moved by the example of Alfieri he strove to reform the British drama by "a severer approach to the rules." He would read his countrymen a "moral lesson" on the dramatic propriety of observing the three unities. It was an heroic attempt to reassert classical ideals in a romantic age, but it was "a week too late"; Byron's "regular dramas" are admirably conceived and finely worded, but they are cold and lifeless.

Eighteen additional sheets of the *Memoirs* and a fifth canto of *Don Juan* were the pastime of the autumn, and in January 1821 Byron began to work on his second "historical drama," *Sardanapalus*. But politics intervened, and little progress was made. He had been elected *capo* of the "Americani," a branch of the Carbonari, and his time was taken up with buying and storing arms and ammunition, and consultations with leading conspirators. "The poetry of politics" and poetry on paper did not go together. Meanwhile he would try his hand on prose. A controversy had arisen between Bowles and Campbell with regard to the merits of Pope. Byron rushed into the fray. To avenge and exalt Pope, to decry the "Lakers," and to lay down his own canons of art, Byron addressed two letters to . . . * . . . (i.e. John Murray), entitled "Strictures on the Life and Writings of Pope." The first was published in 1821, the second in 1835.

The revolution in Italy came to nothing, and by the 28th of May, Byron had finished his work on *Sardanapalus*. The *Two Foscari*, a third historical drama, was begun on the 12th of June and finished on the 9th of July. On the same day he began *Cain, a Mystery*. *Cain* was an attempt to dramatize the Old Testament; Lucifer's apology for himself and his arraignment of the Creator startled and shocked the orthodox. Theologically the offence lay in its detachment. *Cain* was not irreverent or blasphemous, but it treated accepted dogmas as open questions. *Cain* was published in the same volume with the *Two Foscari* and *Sardanapalus*, December 19, 1821. The "Blues," a skit upon literary coteries and their patronesses, was written in August. It was first published in *The Liberal*, No. III., April 26, 1823. When *Cain* was finished Byron turned from grave to gay, from serious to humorous theology. Southey had thought fit to eulogize George III. in hexameter verse. He called his funeral ode a "Vision of Judgment." In the preface there was an obvious reference to Byron. The "Satanic School" of poetry was attributed to "men of diseased hearts and depraved imaginations." Byron's revenge was complete. In his "Vision of Judgment" (published in *The Liberal*, No. I., October 15, 1822) the tables are turned. The laureate is brought before the hosts of heaven and rejected by devils and angels alike. In October Byron wrote *Heaven and Earth, a Mystery* (*The Liberal*, No. II., January 1, 1823), a lyrical drama based on the legend of the "Watchers," or fallen angels of the Book of Enoch. The countess and her family had been expelled from Ravenna in

July, but Byron still lingered on in his apartments in the Palazzo Guiccioli. At length (October 28) he set out for Pisa. On the road he met his old friend, Lord Clare, and spent a few minutes in his company. Rogers, whom he met at Bologna, was his fellow-traveller as far as Florence. At Pisa he rejoined the countess, who had taken on his behalf the Villa Lanfranchi on the Arno. At Ravenna Byron had lived amongst Italians. At Pisa he was surrounded by a knot of his own countrymen, friends and acquaintances of the Shelleys. Among them were E. J. Trevelyan, Thomas Medwin, author of the well-known *Conversations of Lord Byron* (1824), and Edward Elliker Williams. His first work at Pisa was to dramatize Miss Lee's *Kruisner, or the German's Tale*. He had written a first act in 1815, but as the MS. was mislaid he made a fresh adaptation of the story which he rechristened *Werner, or the Inheritance*. It was finished on the 20th of January and published on the 13rd of November 1822. *Werner* is in parts *Kruisner* cut up into loose blank verse, but it contains lines and passages of great and original merit. Alone of Byron's plays it took hold of the stage. Macready's "Werner" was a famous impersonation.

In the spring of 1822 a heavy and unlooked-for sorrow befell Byron. Allegra, his natural daughter by Claire Clairmont, died at the convent of Bagna Cavallo on the 20th of April 1822. She was in her sixth year, an interesting and attractive child, and he had hoped that her companionship would have atoned for his enforced separation from Ada. She is buried in a nameless grave at the entrance of Harrow church. Soon after the death of Allegra, Byron wrote the last of his eight plays, *The Deformed Transformed* (published by John Hunt, February 20, 1824). The "sources" are Goethe's *Faust*, *The Three Brothers*, a novel by Joshua Pickersgill, and various chronicles of the sack of Rome in 1527. The theme or *motif* is the interaction of personality and individuality. Remonstrances on the part of publisher and critic induced him to turn journalist. The control of a newspaper or periodical would enable him to publish what and as he pleased. With this object in view he entered into a kind of literary partnership with Leigh Hunt, and undertook to transport him, his wife and six children to Pisa, and to lodge them in the Villa Lanfranchi. The outcome of this arrangement was *The Liberal—Verse and Prose from the South*. Four numbers were issued between October 1822 and June 1823. *The Liberal* did not succeed financially, and the joint ménage was a lamentable failure. *Correspondence of Byron and some of his Contemporaries* (1828) was Hunt's revenge for the slights and indignities which he suffered in Byron's service. Yachting was one of the chief amusements of the English colony at Pisa. A schooner, the "Bolivar," was built for Byron, and a smaller boat, the "Don Juan" re-named "Ariel," for Shelley. Hunt arrived at Pisa on the 1st of July. On the 8th of July Shelley, who had remained in Pisa on Hunt's account, started for a sail with his friend Williams and a lad named Vivian. The "Ariel" was wrecked in the Gulf of Spezia and Shelley and his companions were drowned. On the 16th of August Byron and Hunt witnessed the "burning of Shelley" on the seashore near Via Reggia. Byron told Moore that "all of Shelley was consumed but the heart." Whilst the fire was burning Byron swam out to the "Bolivar" and back to the shore. The hot sun and the violent exercise brought on one of those many fevers which weakened his constitution and shortened his life.

The Austrian government would not allow the Gambas or the countess Guiccioli to remain in Pisa. As a half measure Byron took a villa for them at Montenero near Leghorn, but as the authorities were still dissatisfied they removed to Genoa. Byron and Leigh Hunt left Pisa on the last day of September. On reaching Genoa Byron took up his quarters with the Gambas at the Casa Saluzzo, "a fine old palazzo with an extensive view over the bay," and Hunt and his party at the Casa Negroso with Mrs Shelley. Life at Genoa was uneventful. Of Hunt and Mrs Shelley he saw as little as possible, and though his still unpublished poems were at the service of *The Liberal*, he did little or nothing to further its success. Each number was badly received. Byron had some reason to fear that his popularity

¹ An anonymous work entitled *The Life, Writings, &c. of . . . Lord Byron* (3 vols., 1825) purports to give "Recollections of the Lately Destroyed Manuscript." To judge by internal evidence (see "The Wedding Day," &c. ii. 278-284) there is some measure of truth in this assertion, but the work as a whole is untrustworthy.

was on the wane, and though he had broken with Murray and was offering *Don Juan* (cantos vi.-xii.) to John Hunt, the publisher of *The Liberal*, he meditated a "run down to Naples" and a recommencement of *Childe Harold*. There was a limit to his defiance of the "world's rebuke." Home politics and the congress of Verona (November-December 1822) suggested a satire entitled "The Age of Bronze" (published April 1, 1823). It is, as he said, "stilted," and cries out for notes, but it embodies some of his finest and most vigorous work as a satirist. By the middle of February (1823) he had completed *The Island; or Christian and his Comrades* (published June 26, 1823). The sources are Bligh's *Narrative of the Mutiny of the Bounty*, and Mariner's *Account of the Tonga Islands*. Satire and tale are a reversion to his earlier method. The execution of *The Island* is hurried and unequal, but there is a deep and tender note in the love-story and the recital of the "feasts and loves and wars" of the islanders. The poetic faculty has been "softened into feeling" by the experience of life.

When *The Island* was finished, Byron went on with *Don Juan*. Early in March the news reached him that he had been elected a member of the Greek Committee, a small body of influential Liberals who had taken up the cause of the liberation of Greece. Byron at once offered money and advice, and after some hesitation on the score of health, determined "to go to Greece." His first step was to sell the "Bolivar" to Lord Blessington, and to purchase the "Hercules," a collier-built tug of 120 tons. On the 23rd of July the "Hercules" sailed from Leghorn and anchored off Cephalonia on the 3rd of August. The party on board consisted of Byron, Pietro Gamba, Trelawny, Hamilton Browne and six or seven servants. The next four months were spent at Cephalonia, at first on board the "Hercules," in the harbour of Argostoli and afterwards at Metaxata. The object of this delay was to ascertain the real state of affairs in Greece. The revolutionary Greeks were split up into parties, not to say factions, and there were several leaders. It was a question to which leader he would attach himself. At length a message reached him which inspired him with confidence. He received a summons from Prince Alexander Mavrocordato, a man of birth and education, urging him to come at once to Missolonghi, and enclosing a request from the legislative body "to co-operate with Mavrocordato in the organization of western Greece." Byron felt that he could act with a "clear conscience" in putting himself at the disposal of a man whom he regarded as the authorized leader and champion of the Greeks. He sailed from Argostoli on the 29th of December 1823, and after an adventurous voyage landed at Missolonghi on the 5th of January 1824. He met with a royal reception. Byron may have sought, but he did not find, "a soldier's grave." During his three months' residence at Missolonghi he accomplished little and he endured much. He advanced large sums of money for the payment of the troops, for repair and construction of fortifications, for the provision of medical appliances. He brought opposing parties into line, and served as a link between Odysseus, the democratic leader of the insurgents, and the "prince" Mavrocordato. He was eager to take the field, but he never got the chance. A revolt in the Morea, and the repeated disaffection of his Suliot guard prevented him from undertaking the capture of Epacto, an exploit which he had reserved for his own leadership. He was beset with difficulties, but at length events began to move. On the 18th of March he received an invitation from Odysseus and other chiefs to attend a conference at Salona, and by the same messenger an offer from the government to appoint him "governor-general of the enfranchised parts of Greece." He promised to attend the conference but did not pledge himself to the immediate acceptance of office. But to Salona he never came. "Roads and rivers were impassable," and the conference was inevitably postponed.

His health had given way, but he does not seem to have realized that his life was in danger. On the 15th of February he was struck down by an epileptic fit, which left him speechless though not motionless. He recovered sufficiently to conduct his business as usual, and to drill the troops. But he suffered from zizziness in the head and spasms in the chest, and a few days later

he was seized with a second though slighter convulsion. These attacks may have hastened but they did not cause his death. For the first week of April the weather confined him to the house, but on the 9th a letter from his sister raised his spirits and tempted him to ride out with Gamba. It came on to rain, and though he was drenched to the skin he insisted on dismounting and returning in an open boat to the quay in front of his house. Two hours later he was seized with acute and violent rheumatic pains. On the 11th he rode out once more through the olive groves, attended by his escort of Suliot guards, but for the last time. Whether he had got his deathblow, or whether copious blood-letting made recovery impossible, he gradually grew worse, and on the ninth day of his illness fell into a comatose sleep. It was reported that in his delirium he had called out, half in English, half in Italian, "Forward—forward—courage! follow my example—don't be afraid!" and that he tried to send a last message to his sister and to his wife. He died at six o'clock in the evening of the 19th of April 1824, aged thirty-six years and three months. The Greeks were heartbroken. Mavrocordato gave orders that thirty-seven minute-guns should be fired at daylight and decreed a general mourning of twenty-one days. His body was embalmed and lay in state. On the 25th of May his remains, all but the heart, which is buried at Missolonghi, were sent back to England, and were finally laid beneath the chancel of the village church of Hucknall-Torkard on the 16th of July 1824. The authorities would not sanction burial in Westminster Abbey, and there is neither bust nor statue of Lord Byron in Poets' Corner.

The title passed to his first cousin as 7th baron, from whom the subsequent barons were descended. The poet's daughter Ada (d. 1852) predeceased her mother, but the barony of Wentworth went to her heirs. She was the first wife of Baron King, who in 1838 was created 1st earl of Lovelace, and had two sons (of whom the younger, b. 1839, d. 1906, was 2nd earl of Lovelace) and a daughter, Lady Anne, who married Wilfrid S. Blunt (q.v.). On the death of the 2nd earl the barony of Wentworth went to his daughter and only child, and the earldom of Lovelace to his half-brother by the 1st earl's second wife.

Great men are seldom misjudged. The world passes sentence on them, and there is no appeal. Byron's contemporaries judged him by the tone and temper of his works, by his own confessions or self-revelations in prose and verse, by the facts of his life as reported in the newspapers, by the talk of the town. His letters, his journals, the testimony of a dozen memorialists are at the disposal of the modern biographer. Moore thinks that Byron's character was obliterated by his versatility, his mobility, that he was carried away by his imagination, and became the thing he wished to be, or conceived himself as becoming. But his nature was not chameleon-like. Self-will was the very pulse of the machine. Pride ruled his years. All through his life, as child and youth and man, his one aim and endeavour was the subjection of other people's wishes to his own. He would subject even fate if he could. He has two main objects in view, *glory*, in the French rather than the English use of the word, and passion. It is hard to say which was the strongest or the dearest, but, on the whole, within his "littler life" passion prevailed. Other inclinations he could master. Poetry was often but not always an exaltation and a relief. He could fulfil his tasks in "hours of gloom." If he had not been a great poet he would have gained credit as a painstaking and laborious man of letters. His habitual temperance was the outcome of a stern resolve. He had no scruples, but he kept his body in subjection as a means to an end. In his youth Byron was a cautious spendthrift. Even when he was "cursedly dipped" he knew what he was about; and afterwards, when his income was sufficient for his requirements, he kept a hold on his purse. He loved display, and as he admitted, spent money on women, but he checked his accounts and made both ends meet. On the other hand, the "gift of continency" he did not possess, or trouble himself to acquire. He was, to use his own phrase, "passionate of body," and his desires were stronger than his will. There are points of Byron's character with regard to which opinion is divided. Candid he certainly was to the verge of brutality, but was he sincere? Was

he as melancholy as his poetry implies? Did he pose as pessimist or misanthropist, or did he speak out of the bitterness of his soul? It stands to reason that Byron knew that his sorrow and his despair would excite public interest, and that he was not ashamed to exhibit "the pageant of a bleeding heart." But it does not follow that he was a hypocrite. His quarrel with mankind, his anger against fate, were perfectly genuine. His outcry is, in fact, the anguish of a baffled will. Byron was too self-conscious, too much interested in himself, to take any pleasures in imaginary woes, or to credit himself with imaginary vices.

Whether he told the whole truth is another matter. He was naturally a truthful man and his friends lived in dread of unguarded disclosures, but his communications were not so free as they seemed. There was a string to the end of the kite. Byron was kindly and generous by nature. He took pleasure in helping necessitous authors, men and women, not at all *en grand seigneur*, or without counting the cost, but because he knew what poverty meant, and a fellow-feeling made him kind. Even in Venice he set aside a fixed sum for charitable purposes. It was to his credit that neither libertinism nor disgrace nor remorse withered at its root this herb of grace. Cynical speeches with regard to friends and friendship, often quoted to his disadvantage, need not be taken too literally. Byron talked for effect, and in accordance with the whim of the moment. His acts do not correspond with his words. Byron rejected and repudiated both Protestant and Catholic orthodoxy, but like the Athenians he was "exceedingly religious." He could not, he did not wish to, detach himself from a belief in an Invisible Power. "A fearful looking for of judgment" haunted him to the last.

There is an increasing tendency on the part of modern critics to cast a doubt on Byron's sanity. It is true that he inherited bad blood on both sides of his family, that he was of a neurotic temperament, that at one time he maddened himself with drink, but there is no evidence that his brain was actually diseased. Speaking figuratively, he may have been "half mad," but, if so, it was a derangement of the will, not of the mind. He was responsible for his actions, and they rise up in judgment against him. He put indulgence before duty. He made a byword of his marriage and brought lifelong sorrow on his wife. If, as Goethe said, he was "the greatest talent" of the 19th century, he associated that talent with scandal and reproach. But he was born with certain noble qualities which did not fail him at his worst. He was courageous, he was kind, and he loved truth rather than lies. He was a worker and a fighter. He hated tyranny, and was prepared to sacrifice money and ease and life in the cause of popular freedom. If the issue of his call to arms was greater and other than he designed or foresaw, it was a generous instinct which impelled him to begin the struggle.

With regard to the criticism of his works, Byron's personality has always confused the issue. Politics, religion, morality, have confused, and still confuse, the issue. The question for the modern critic is, of what permanent value is Byron's poetry? What did he achieve for art, for the intellect, for the spirit, and in what degree does he still give pleasure to readers of average intelligence? It cannot be denied that he stands out from other poets of his century as a great creative artist, that his canvas is crowded with new and original images, additions to already existing types of poetic workmanship. It has been said that Byron could only represent himself under various disguises, that Childe Harold and The Corsair, Lara and Manfred and Don Juan, are variants of a single personality, the egotist who is at war with his fellows, the generous but nefarious sentimentalist who sins and suffers and yet is to be pitied for his suffering. None the less, with whatever limitations as artist or moralist, he invented characters and types of characters real enough and distinct enough to leave their mark on society as well as on literature. These masks or replicas of his own personality were formative of thought, and were powerful agents in the evolution of sentiment and opinion. In language which was intelligible and persuasive, under shapes and forms which were suggestive and inspiring, Byron delivered a message of liberation. There was a double motive at work in his energies as a poet. He wrote, as he said, because "his

mind was full" of his own loves, his own griefs, but also to register a protest against some external tyranny of law or faith or custom. His own countrymen owe Byron another debt. His poems were a liberal education in the manners and customs of "the gorgeous East," in the scenery, the art, the history and politics of Italy and Greece. He widened the horizon of his contemporaries, bringing within their ken wonders and beauties hitherto unknown or unfamiliar, and in so doing he heightened and cultivated, he "touched with emotion," the unlettered and unimaginative many, that "reading public" which despised or eluded the refinements and subtleties of less popular writers.

To the student of literature the first half of the 19th century is the age of Byron. He has failed to retain his influence over English readers. The knowledge, the culture of which he was the immediate channel, were speedily available through other sources. The politics of the Revolution neither interested nor affected the Liberalism or Radicalism of the middle classes. It was not only the loftier and wholesomer poetry of Wordsworth and of Tennyson which averted enthusiasm from Byron, not only moral earnestness and religious revival but the optimism and the materialism of commercial prosperity. As time went on, a severer and more intelligent criticism was brought to bear on his handiwork as a poet. It was pointed out that his constructions were loose and ambiguous, that his grammar was faulty, that his rhythm was inharmonious, and it was argued that these defects and blemishes were outward and visible signs of a lack of fineness in the man's spiritual texture; that below the sentiment and behind the rhetoric the thoughts and ideas were mean and commonplace. There was a suspicion of artifice, a questioning of the passion as genuine. Poetry came to be regarded more and more as a source of spiritual comfort, if not a religious exercise, yet, in some sort, a substitute for religion. There was little or nothing in Byron's poetry which fulfilled this want. He had no message for seekers after truth. Matthew Arnold, in his preface to *The Poetry of Byron*, prophesied that "when the year 1900 is turned, and our nation comes to recount the poetic glories in the century which has then just ended, her first names with her will be those of Byron and Wordsworth."

That prophecy still waits fulfilment, but without doubt there has been a reconsideration of Byron's place in literature, and he stands higher than he did, say, in 1875. His quarrel with orthodoxy neither alarms nor provokes the modern reader. Cynical or flippant turns of speech, which distressed and outraged his contemporaries, are taken as they were meant, for witty or humorous by-play. He is regarded as the herald and champion of *resolot*. He is praised for his "sincerity and strength," for his single-mindedness, his directness, his audacity. A dispassionate criticism recognizes the force and splendour of his rhetoric. The "purple patches" have stood the wear and tear of time. Byron may have mismanaged the Spenserian stanza, may have written up to or anticipated the guide-book, but the spectacle of the bull-fight at Cadiz is "for ever warm," the "sound of revelry" on the eve of Waterloo still echoes in our ears, and Marathon and Venice, Greece and Italy, still rise up before us, "as from the stroke of an enchanter's wand." It was, however, in another vein that Byron achieved his final triumph. In *Don Juan* he set himself to depict life as a whole. The style is often misnamed the mock-heroic. It might be more accurately described as humorous-realistic. His "plan was to have no plan" in the sense of synopsis or argument, but in the person of his hero to "unpack his heart," to avenge himself on his enemies, personal or political, to suggest an apology for himself and to disclose a criticism and philosophy of life. As a satirist in the widest sense of the word, as an analyser of human nature, he comes, at whatever distance, after and yet next to Shakespeare. It is a test of the greatness of *Don Juan* that its reputation has slowly increased and that, in spite of its supposed immoral tendency, in spite of occasional grossness and voluptuousness, it has come to be recognized as Byron's masterpiece. *Don Juan* will be read for its own sake, for its beauty, its humour, its faithfulness. It is a "hymn to the earth," but it is a human sequence to "its own music chaunted."



Interior of the Holy Wisdom (S. Sophia), Constantinople.
Sixth century, the dome was rebuilt in the tenth century. The metal balustrades, pulpits, and the large discs are Turkish.



S. Vitale, Ravenna.
Sixth century.



Capitals of Columns.
S. Mark, Venice.
Eleventh century.



S. Apollinari, Ravenna.
Sixth century.



Small Medieval Cathedral, Athens.

Photo, Emery Walker.

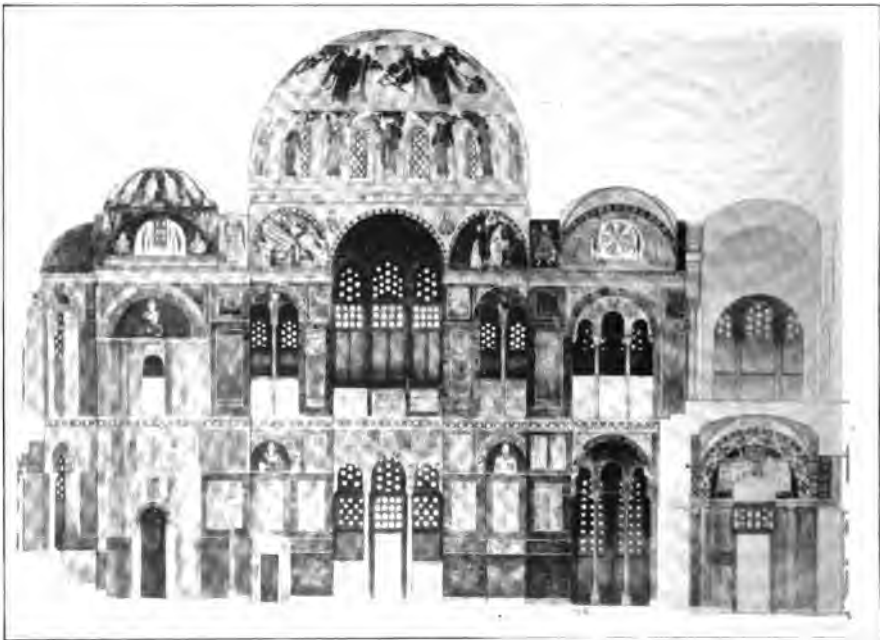

From a Drawing by Sidney Burnley.

Interior of St Luke's, Near Delphi.

Showing a typical scheme of internal decoration. The lower parts of the walls are covered with marble, and the upper surfaces and vaults with mosaics and paintings. Eleventh century.

In his own lifetime Byron stood higher on the continent of Europe than in England or even in America. His works as they came out were translated into French, into German, into Italian, into Russian, and the stream of translation has never ceased to flow. The *Bride of Abydos* has been translated into ten *Cais* into nine languages. Of *Manfred* there is one Bohemian translation, two Danish, two Dutch, two French, nine German, three Hungarian, three Italian, two Polish, one Romaine, one Rumanian, four Russian and three Spanish translations. The dictum or verdict of Goethe that "the English may think of Byron as they please, but this is certain that they show no poet who is to be compared with him" was and is the keynote of continental European criticism. A survey of European literature is a testimony to the universality of his influence. Victor Hugo, Lamartine, Delavigne, Alfred de Musset, in France; Börne, Müller and Heine in Germany; the Italian poets Leopardi and Giusti; Pushkin and Lermontov among the Russians; Michiewicz and Slowacki among the Poles—more or less, as eulogists or imitators or disciples—were of the following of Byron. This fact is beyond dispute, that after the first outburst of popularity he has touched and swayed other nations rather than his own. The part he played or seemed to play in revolutionary politics endeared him to those who were struggling to be free. He stood for freedom of thought and of life. He made himself the mouth-piece of an impassioned and welcome protest against the hypocrisy and arrogance of his order and his race. He lived on the continent and was known to many men in many cities. It has been argued that foreigners are insensible to his defects as a writer, and that this may account for an astonishing and perplexing preference. The cause is rather to be sought in the quality of his art. It was as the creator of new types, "forms more real than living man," that Byron appealed to the artistic sense and to the imagination of Latin, Teuton or Slav. That "he taught us little" of the things of the spirit, that he knew no cure for the sickness of the soul, were considerations which lay outside the province of literary criticism. "It is a mark," says Goethe (*Aus meinem Leben: Dichtung und Wahrheit*, 1876, iii. 125), "of true poetry, that as a secular gospel it knows how to free us from the earthly burdens which press upon us, by inward serenity, by outward charm." Now of this "secular gospel" the redemption from "real woes" by the exhibition of imaginary glory, and imaginary delights, Byron was both prophet and evangelist.

Byron was 5 ft. 8 in. in height, and strongly built; only with difficulty and varying success did he prevent himself from growing fat. At five-and-thirty he was extremely thin. He was "very slightly lame," but he was painfully conscious of his deformity and walked as little and as seldom as he could. He had a small head covered and fringed with dark brown or auburn curls. His forehead was high and narrow, of a marble whiteness. His eyes were of a light grey colour, clear and luminous. His nose was straight and well-shaped, but "from being a little too thick, it looked better in profile than in front face." Moore says that it was in "the mouth and chin that the great beauty as well as expression of his fine countenance lay." The upper lip was of a Grecian shortness and the corners descending. His complexion was pale and colourless. Scott speaks of "his beautiful pale face—like a spirit's good or evil." Charles Matthews said that "he was the only man to whom he could apply the word beautiful." Coleridge said that "if you had seen him you could scarce disbelieve him . . . his eyes the open portals of the sun—things of light and for light." He was likened to "the god of the Vatican," the Apollo Belvidere.

The best-known portraits are: (1) Byron at the age of seven by Kay of Edinburgh; (2) a drawing of Lord Byron at Cambridge by Gilchrist (1808); (3) a portrait in oils by George Sanders (1809); (4) a miniature by Sanders (1812); (5) a portrait in oils by Richard Westall, R.A. (1813); (6) a portrait in oils (Byron in Albanian dress) by Thomas Phillips, R.A. (1813); (7) a portrait in oils by Phillips (1813); (8-9) a sketch for a miniature, and a miniature by James Holmes (1815); (10) a sketch by George Henry Harlow (1818); (11) a portrait in oils by Vincenzo Camuccini (in the Vatican) c. 1822; (12) a portrait

in oils by W. H. West (1822); (13) a sketch by Count D'Oraay (1823). Busts were taken by Bertel Thorwaldsen (1817) and by Lorenzo Bartolini (1822). The statue (1820) in the library of Trinity College, Cambridge, is by Thorwaldsen after the bust taken in 1817.

AUTHORITIES.—The best editions of Lord Byron's poetical works are: (1) *The Works of Lord Byron with his Letters and Journals and his Life*, by Thomas Moore (17 vols., London, John Murray, 1812, 1833); (2) *The Works of Lord Byron* (1 vol., 1837, reissued, 1838-1892); (3) *The Poetical Works of Lord Byron* (6 vols., 1855); (4) *The Works of Lord Byron*, new, revised and enlarged edition, *Letters and Journals*, edited by G. E. Prothero, 6 vols., *Poetry*, edited by E. H. Coleridge (7 vols., 1898-1903); (5) *The Poetical Works of Lord Byron*, with memoir by E. H. Coleridge (1 vol., 1905).

The principal biographies, critical notices, memoirs, &c., are:—*Journey through Albania . . . with Lord Byron*, by J. C. Hobhouse (1812; reprinted in 2 vols., 1813 and 1855); *Memoirs of the Life and Writings of . . . Lord Byron* [by Dr John Watkins] (1822); *Letters on the Character and Poetical Genius of Lord Byron*, by Sir E. Brydges, Bart. (1824); *Correspondence of Lord Byron with a Friend* (3 vols., Paris, 1824); *Recollections of the Life of Lord Byron*, by R. C. Dallas (1824); *Journal of the Conversations of Lord Byron*, by Capt. T. Medwin (1824); *Last Days of Lord Byron*, by W. Parry (1824); *Narrative of a Second Visit to Greece*, by E. Blaquiere (1825); *A Narrative of Lord Byron's Last Journey to Greece*, by Count Gamba (1825); *The Life, Writings, Opinions and Times of Lord Byron* (3 vols., 1825); *The Spirit of the Age*, by W. Hazlitt (1825); *Memoir of the Life and Writings of Lord Byron*, by George Clinton (1826); *Correspondence of Byron and some of his Contemporaries*, by J. H. Leigh Hunt (2 vols., 1828); *Letters and Journals of Lord Byron*, with *Notices of his Life*, by Thomas Moore (2 vols., 1830); *The Life of Lord Byron*, by J. Galt (1830); *Conversations on Religion with Lord Byron*, by J. Kennedy (1830); *Conversations of Lord Byron with the Countess of Blessington* (1834); *Critical and Historical Essays*, by T. B. Macaulay, i. 311-352 (1843); *Lord Byron jugé-par les témoins de sa vie* (1869); *My Recollections of Lord Byron*, by the Countess Guiccioli (1869); *Lady Byron Vindicated, A History of the Byron Controversy*, by H. Beecher Stowe (1870); *Lord Byron, a Biography*, by Karl Elze (1872); *Kunst und Aelterthum, Goethe's Sämmtliche Werke* (1874), vol. xiii. p. 641; *Memoir of the Rev. F. Hodgson* (2 vols., 1878); *The Real Lord Byron*, by J. C. Jeaffreson (2 vols., 1883); *A Selection*, &c., by A. C. Swinburne (1885); *Records of Shelley, Byron and the Author*, by E. J. Trelawny (1887); *Memoirs of John Murray*, by S. Smiles (2 vols., 1891); *Poetry of Byron*, chosen and arranged by Matthew Arnold (preface) (1892); *The Siege of Corinth*, edited by E. Kolbing (1893); *Prisoner of Chillon and other Poems*, edited by E. Kolbing (1896); *The Works of Lord Byron*, edited by W. Henley, vol. I. (1897); *A Brandl's Goethes Verhältnis zu Byron*, *Goethe Jahrbuch*, zwanzigster Band (1899); *Main Currents in Nineteenth Century Literature*, by C. Brandis (6 vols., 1901-1905), translated from *Hauptströmungen der Literatur des neunzehnten Jahrhunderts*, 4 Bde. (Berlin 1872-1876); *Chambers's Cyclopaedia of English Literature*, vol. iii. (1903) art. "Byron," by T. Watts Dunton; *Studies in Poetry and Criticism*, by J. Churton Collins (1905); *Lord Byron, sein Leben*, &c., by Richard Ackermann; *Byron*, 3 vols., in the *Biblioteka velikikh pisatelei pod redaktsiei*, edited by A. S. Vengesoza (St Petersburg, 1906); a variorum translation; *Byron et le romantisme français*, by Edmond Estève (1907). (E. H. C.)

BYRON, HENRY JAMES (1834-1884), English playwright, son of Henry Byron, at one time British consul at Port-au-Prince, was born in Manchester in January 1834. He entered the Middle Temple as a student in 1858, with the intention of devoting his time to play-writing. He soon ceased to make any pretence of legal study, and joined a provincial company as an actor. In this line he never made any real success; and, though he continued to act for years, chiefly in his own plays, he had neither originality nor charm. Meanwhile he wrote assiduously, and few men have produced so many pieces of so diverse a nature. He was the first editor of the weekly comic paper, *Fun*, and started the short-lived *Comic Trials*. His first successes were in burlesque; but in 1865 he joined Miss Marie Wilton (afterwards Lady Bancroft) in the management of the Prince of Wales's theatre, near Tottenham Court Road. Here several of his pieces, comedies and extravaganzas were produced with success; but, upon his severing the partnership two years later, and starting management on his own account in the provinces, he was financially unfortunate. The commercial success of his life was secured with *Our Boys*, which was played at the Vaudeville from January 1875 till April 1879—a then unprecedented "run." *The Upper Crust*, another of his successes, gave a congenial opportunity to Mr J. L. Toole for one of his

inimitably broad character-sketches. During the last few years of his life Byron was in frail health; he died in Clapham on the 11th of April 1884. H. J. Byron was the author of some of the most popular stage pieces of his day. Yet his extravaganzas have no wit but that of violence; his rhyming couplets are without polish, and decorated only by forced and often pointless puns. His sentiment had T. W. Robertson's insipidity without its freshness, and restored an element of vulgarity which his predecessor had laboured to eradicate from theatrical tradition. He could draw a "Cockney" character with some fidelity, but his *dramatis personae* were usually mere puppets for the utterance of his jests. Byron was also the author of a novel, *Paid in Full* (1865), which appeared originally in *Temple Bar*. In his social relations he had many friends, among whom he was justly popular for geniality and imperturbable good temper.

BYRON, JOHN BYRON, 1st Baron (c. 1600-1652), English cavalier, was the eldest son of Sir John Byron (d. 1625), a member of an old Lancashire family which had settled at Newcastle, near Nottingham. During the third decade of the 17th century Byron was member of parliament for the town and afterwards for the county of Nottingham; and having been knighted and gained some military experience he was an enthusiastic partisan of Charles I. during his struggle with the parliament. In December 1641 the king made him lieutenant of the Tower of London, but in consequence of the persistent demand of the House of Commons he was removed from this position at his own request early in 1642. At the opening of the Civil War Byron joined Charles at York. He was present at the skirmish at Powick Bridge; he commanded his own regiment of horse at Edgehill and at Roundway Down, where he was largely responsible for the royalist victory; and at the first battle of Newbury Falkland placed himself under his orders. In October 1643 he was created Baron Byron of Rochdale, and was soon serving the king in Cheshire, where the soldiers sent over from Ireland augmented his forces. His defeat at Nantwich, however, in January 1644, compelled him to retire into Chester, and he was made governor of this city by Prince Rupert. At Marston Moor, as previously at Edgehill, Byron's rashness gave a great advantage to the enemy; then after fighting in Lancashire and North Wales he returned to Chester, which he held for about twenty weeks in spite of the king's defeat at Naseby and the general hopelessness of the royal cause. Having obtained favourable terms he surrendered the city in February 1646. Byron took some slight part in the second Civil War, and was one of the seven persons excepted by parliament from all pardon in 1648. But he had already left England, and he lived abroad in attendance on the royal family until his death in Paris in August 1652. Although twice married Byron left no children, and his title descended to his brother Richard (1605-1679), who had been governor of Newark. Byron's five other brothers served Charles I. during the Civil War, and one authority says that the seven Byrons were all present at Edgehill.

BYRON, HON. JOHN (1723-1786), British vice-admiral, second son of the 4th Lord Byron, and grandfather of the poet, was born on the 8th of November 1723. While still very young, he accompanied Anson in his voyage of discovery round the world. During many successive years he saw a great deal of hard service, and so constantly had he to contend, on his various expeditions, with adverse gales and dangerous storms, that he was nicknamed by the sailors, "Foul-weather Jack." It is to this that Lord Byron alludes in his *Epistle to Augusta*:-

"A strange doom is thy father's son's, and past
Recalling as it lies beyond redress,
Reversed for him our grand sire's fate of yore,
He had no rest at sea, nor I on shore."

Among his other expeditions was that to Louisburg in 1760, where he was sent in command of a squadron to destroy the fortifications. And in 1764 in the "Dolphin" he went for a prolonged cruise in the South Seas. In 1768 he published a *Narrative* of some of his early adventures with Anson, which was to some extent utilized by his grandson in *Don Juan*. In 1769 he was appointed governor of Newfoundland. In 1775 he

attained his flag rank, and in 1778 became a vice-admiral. In the same year he was despatched with a fleet to watch the movements of the Count d'Estaing, and in July 1779 fought an indecisive engagement with him off Grenada. He soon after returned to England, retiring into private life, and died on the 10th of April 1786.

BYSTRÖM, JOHAN NIKLAS (1783-1848), Swedish sculptor, was born on the 18th of December 1783 at Filipstad. At the age of twenty he went to Stockholm and studied for three years under Sergel. In 1809 he gained the academy prize, and in the following year visited Rome. He sent home a beautiful work, "The Reclining Bacchante," in half life size, which raised him at once to the first rank among Swedish sculptors. On his return to Stockholm in 1816 he presented the crown prince with a colossal statue of himself, and was entrusted with several important works. Although he was appointed professor of sculpture at the academy, he soon returned to Italy, and with the exception of the years from 1838 to 1844 continued to reside there. He died at Rome in 1848. Among Byström's numerous productions the best are his representations of the female form, such as "Hebe," "Pandora," "Juno suckling Hercules," and the "Girl entering the Bath." His colossal statues of the Swedish kings are also much admired.

BYTOWNITE, a rock-forming mineral belonging to the plagioclase (g.p.) series of the feldspars. The name was originally given (1835) by T. Thomson, to a greenish-white felspathic mineral found in a boulder near Bytown (now the city of Ottawa) in Ontario, but this material was later shown on microscopical examination to be a mixture. The name was afterwards applied by G. Tschermak to those plagioclase feldspars which lie between labradorite and anorthite; and this has been generally adopted by petrologists. In chemical composition and in optical and other physical characters it is thus much nearer to the anorthite end of the series than to albite. Like labradorite and anorthite, it is a common constituent of basic igneous rocks, such as gabbro and basalt. Isolated crystals of bytownite bounded by well-defined faces are unknown. (L. J. S.)

BYWATER, INGRAM (1840-), English classical scholar, was born in London on the 27th of June 1840. He was educated at University and King's College schools, and at Queen's College, Oxford. He obtained a first class in Moderations (1860) and in the final classical schools (1862), and became fellow of Exeter (1863), reader in Greek (1883), regius professor of Greek (1893-1908), and student of Christ Church. He received honorary degrees from various universities, and was elected corresponding member of the Prussian Academy of Sciences. He is chiefly known for his editions of Greek philosophical works: *Herodoti Ephesii Reliquiae* (1877); *Prisciani Lydi quae extant* (edited for the Berlin Academy in the *Supplementum Aristotelicum*, 1886); Aristotle, *Ethica Nicomachea* (1890), *De Arte Poetica* (1898); *Contributions to the Textual Criticism of the Nicomachean Ethics* (1892).

BYZANTINE ART. By "Byzantine art" is meant the art of Constantinople (sometimes called *Byzantium* in the middle ages as in antiquity), and of the Byzantine empire; it represents the form of art which followed the classical, after the transitional interval of the early Christian period. It reached maturity under Justinian (527-565), declined and revived with the fortunes of the empire, and attained a second culmination from the 10th to the 12th centuries. Continuing in existence throughout the later middle ages, it is hardly yet extinct in the lands of the Greek Church. It had enormous influence over the art of Europe and the East during the early middle ages, not only through the distribution of minor works from Constantinople but by the reputation of its architecture and painting. Several buildings in Italy are truly Byzantine. It is difficult to set a time for the origin of the style. When Constantine founded new Rome the art was still classical, although it had even then gathered up many of the elements which were to transform its aspect. Just two hundred years later some of the most characteristic works of this style of art were being produced, such

¹ For Byzantine literature see GREEK LITERATURE: *Byzantine*.

as the churches of St Sergius, the Holy Wisdom (St Sophia), and the Holy Apostles at Constantinople, and San Vitale at Ravenna. We may best set an arbitrary point for the demarcation of the new style midway between these two dates, with the practical separation of the eastern and western empires.

The style may be said to have arisen from the orientalizing of Roman art, and itself largely contributed to the formation of the Saracenic or Mahomedan styles. As Choisy well says, "The history of art in the Roman epoch presents two currents, one with its source in Rome, the other in Hellenic Asia. When Rome fell the Orient returned to itself and to the freedom of exploring new ways. There was now a new form of society, the Christian civilization, and, in art, an original type of architecture, the Byzantine." It has hardly been sufficiently emphasized how closely the art was identified with the outward expression of the Christian church; in fact, the Christian element in late classical art is the chief root of the new style, and it was the moral and intellectual criticism that was brought to bear on the old material, which really marked off Byzantine art from being merely a late form of classic.

Hardly any distinction can be set up in the material contents of the art; it was at least for a period only simplified and sweetened, and it is this freshening which prepared the way for future development. It must be confessed, however, that certain influences darkened the style even before it had reached maturity; chief among these was a gloomy hierarchical splendour, and a ritual rigidity, which to-day we yet refer to, quite properly, as Byzantinism. Choisy sees a distinction in the constructive types of Roman and Byzantine architecture, in that the former covered spaces by concreted vaults built on centres, which approximated to a sort of "monolithic" formation, whereas in the Byzantine style the vaults were built of brick and drawn forward in space without the help of preparatory support. Building in this way, it became of the greatest importance that the vaults should be so arranged as to bring about an equilibrium of thrusts. The distinction holds as between Rome in the 4th century and Constantinople in the 6th, but we are not sufficiently sure that the concreted construction did not depend on merely local circumstances, and it is possible, in other centres of the empire where strong cement was not so readily obtainable, and wood was scarce, that the Byzantine *constructive* method was already known in classical times. Choisy, following Dieulafoy, would derive the Byzantine system of construction from Persia, but this proposition seems to depend on a mistaken chronology of the monuments as shown by Perrot and Chipiez in their *History of Art in Persia*. It seems probable that the erection of brick vaulting was indigenous in Egypt as a building method. Strzygowski, in his recent elaborate examination of the art-types found at the palace of Mashita (Mschatta), a remarkable ruin discovered by Canon Tristram in Moab, of which the most important parts have now been brought to the new Kaiser Friedrich Museum in Berlin, shows that there are Persian ideas intermixed with Byzantine in its decoration, and there are also brick arches of high elliptical form in the structure. He seems disposed to date this work rather in the 5th than in the 6th century, and to see in it an intermediate step between the Byzantine work of the west and a Mesopotamian style, which he postulates as probably having its centre at Seleucia-Ctesiphon. From the examples brought forward by the learned author himself, it is safer as yet to look on the work as in the main Byzantine, with many Egyptian and Syrian elements, and an admixture, as has been said, of Persian ideas in the ornamentation. Egypt was certainly an important centre in the development of the Byzantine style.

The course of the transition to Byzantine, the first mature Christian style, cannot be satisfactorily traced while, guided by Roman archaeologists, we continue to regard Rome as a source of Christian art apart from the rest of the world. Christianity itself was not of Rome, it was an eastern leaven in Roman society. Christian art even in that capital was, we may say, an eastern leaven in Roman art. If we set the year 450 for the beginning of Byzantine art, counting all that went before as

early Christian, we get one thousand years to the Moslem conquest of Constantinople (1453). This millennium is broken into three well-marked periods by the great iconoclastic schism (726-842) and the taking of Constantinople by the Crusaders in 1204. The first we may call the classical epoch of Byzantine art; it includes the mature period under Justinian (the central year of which we may put as 550), from which it declined until the settlement of the quarrel about images, 400 years in all, to say, 850. The second period, to which we may assign the limits 850-1200, is, in the main, one of orientalizing influences, especially in architecture, although in MSS. and paintings there was, at one time, a distinct and successful classical revival. The interregnum had caused almost complete isolation from the West, and inspiration was only to be found either by casting back on its own course, or by borrowing from the East. This period is best represented by the splendid works undertaken by Basil the Macedonian (867-886) and his immediate successors, in the imperial palace, Constantinople. The third period is marked by the return of western influence, of which the chief agency was probably the establishment of Cistercian monasteries. This western influence, although it may be traced here and there, was not sufficient, however, to change the essentially oriental character of the art, which from first to last may be described as Oriental-Christian.

Architecture.—The architecture of our period is treated in some detail in the article ARCHITECTURE; here we can only glance at some broad aspects of its development. As early as the building of Constantine's churches in Palestine there were two chief types of plan in use—the basilican, or axial, type, represented by the basilica at the Holy Sepulchre, and the circular, or central, type, represented by the great octagonal church once at Antioch. Those of the latter type we must suppose were nearly always vaulted, for a central dome would seem to furnish their very *raison d'être*. The central space was sometimes surrounded by a very thick wall, in which deep recesses, to the interior, were formed, as at the noble church of St George, Salonica (5th century?), or by a vaulted aisle, as at Sta Costanza, Rome (4th century); or annexes were thrown out from the central space in such a way as to form a cross, in which these additions helped to counterpoise the central vault, as at the mausoleum of Galla Placidia, Ravenna (5th century). The most famous church of this type was that of the Holy Apostles, Constantinople. Vaults appear to have been early applied to the basilican type of plan; for instance, at St Irene, Constantinople (6th century), the long body of the church is covered by two domes.

At St Sergius, Constantinople, and San Vitale, Ravenna, churches of the central type, the space under the dome was enlarged by having apsidal additions made to the octagon. Finally, at St Sophia (6th century) a combination was made which is perhaps the most remarkable piece of planning ever contrived. A central space of 100 ft. square is increased to 200 ft. in length by adding two hemicycles to it to the east and the west; these are again extended by pushing out three minor apses eastward, and two others, one on either side of a straight extension, to the west. This unbroken area, about 260 ft. long, the larger part of which is over 100 ft. wide, is entirely covered by a system of domical surfaces. Above the conchs of the small apses rise the two great semi-domes which cover the hemicycles, and between these bursts out the vast dome over the central square. On the two sides, to the north and south of the dome, it is supported by vaulted aisles in two storeys which bring the exterior form to a general square. At the Holy Apostles (6th century) five domes were applied to a cruciform plan, that in the midst being the highest. After the 6th century there were no churches built which in any way competed in scale with these great works of Justinian, and the plans more or less tended to approximate to one type. The central area covered by the dome was included in a considerably larger square, of which the four divisions, to the east, west, north and south, were carried up higher in the vaulting and roof system than the four corners, forming in this way a sort of nave

and transepts. Sometimes the central space was square, sometimes octagonal, or at least there were eight piers supporting the dome instead of four, and the "nave" and "transepts" were narrower in proportion. If we draw a square and divide each side into three so that the middle parts are greater than the others, and then divide the area into nine from these points, we approximate to the typical setting out of a plan of this time. Now add three apses on the east side opening from the three divisions, and opposite to the west put a narrow entrance porch running right across the front. Still in front put a square court. The court is the *atrium* and usually has a fountain in the middle under a canopy resting on pillars. The entrance porch is the *narthex*. The central area covered by the dome is the *solea*, the place for the choir of singers. Here also stood the *ambo*. Across the eastern side of the central square was a screen which divided off the *bema*, where the altar was situated, from the body of the church; this screen, bearing images, is the *iconostasis*. The altar was protected by a canopy or *ciborium* resting on pillars. Rows of rising seats around the curve of the apse with the patriarch's throne at the middle eastern point formed the *synthronon*. The two smaller compartments and apses at the sides of the *bema* were sacristies, the *diaconicon* and *prothesis*. The continuous influence from the East is strangely shown in the fashion of decorating external brick walls of churches built about the 12th century, in which bricks roughly carved into form are set up so as to make bands of ornamentation which it is quite clear are imitated from Cufic writing. This fashion was associated with the disposition of the exterior brick and stone work generally into many varieties of pattern, zig-zags, key-patterns, &c.; and, as similar decoration is found in many Persian buildings, it is probable that this custom also was derived from the East. The domes and vaults to the exterior were covered with lead or with tiling of the Roman variety. The window and door frames were of marble. The interior surfaces were adorned all over by mosaics or paintings in the higher parts of the edifice, and below with incrustations of marble slabs, which were frequently of very beautiful varieties, and disposed so that, although in one surface, the colouring formed a series of large panels. The choicer marbles were opened out so that the two surfaces produced by the division formed a symmetrical pattern resembling somewhat the marking of skins of beasts.

Mosaics and Paintings.—The method of depicting designs by bringing together morsels of variously coloured materials is of high antiquity. We are apt to think of a line of distinction between classical and Christian mosaics in that the former were generally of marble and the latter mostly of coloured and gilt glass. But glass mosaics were already in use in the Augustan age, and the use of gilt tesserae goes back to the 1st or 2nd century. The first application of glass to this purpose seems to have been made in Egypt, the great glass-working centre of antiquity, and the gilding of tesserae may with probability be traced to the same source, whence, it is generally agreed, most of the gilt glass vessels, of which so many have been found in the catacombs, were derived. The earliest existing mosaics of a typically Christian character are some to be found at Santa Costanza, Rome (4th century). Other mosaics on the vaults of the same church are of marble and follow a classical tradition. It is probable that we have here the meeting-point of two art-currents, the indigenous and the eastern. In Rome, the great apse-mosaic of S. Pudenziana dates from about A.D. 400. The mausoleum of Galla Placidia, Ravenna, is incrustated within by mosaic work of the 5th century, and most probably the dome mosaics of the church of St George, Salonica, are also of this period. Of the 6th century are many of the magnificent examples still remaining at Ravenna, portions of the original incrustation of St Sophia, Constantinople, those of the basilica at Parenzo, on the Gulf of Istria, and of St Catherine's, Sinai. An interesting mosaic which is probably of this period, and has only recently been described, is at the small church of Keti in Cyprus. This, which may be the only Byzantine mosaic in the British dominions, fills the conch of a tiny apse, but is none the less of great dignity. In the centre is a figure of the Virgin with the

Holy Child in her arms standing between two angels who hold disks marked with the sign X. They are named Michael and Gabriel. Another mosaic of this period brought from Ravenna to Germany two generations ago has been recently almost rediscovered, and set up in the new Museum of Decorative Art in Berlin. In this, a somewhat similar composition fills the conch of the apse, but here it is the Risen Christ who stands between the two archangels. Above, in a broad strip, a frieze of angels blowing trumpets stand on the celestial sea on either hand of the Enthroned Majesty.

Such mosaics flowed out widely over the Christian world from its art centres, as far east as Samà, the capital of Yemen, as far north as Kiev in Russia, and Aachen in Germany, and as far west as Paris, and continued in time for a thousand years without break in the tradition save by the iconoclastic dispute. The finest late example is the well-known "mosaic-church" (the Convent of the Saviour) at Constantinople, a work of the 14th century.

The single figures were from the first, and for the most part, treated with an axial symmetry. Almost all are full front; only occasionally will one, like the announcing angel, be drawn with a three-quarter face. The features are thus kept together on the general map of the face. In the same way the details of a tree will be collected on a simple including form which makes a sort of mat for them. Groups, similarly, are closely gathered up into masses of balanced form, and such masses are arranged with strict regard for general symmetry. "The art," as Bayet says, "in losing something of life and liberty became so much the better fitted for the decoration of great edifices." The technical means were just as much simplified, and only a few frank colours were made sufficient, by skillful juxtaposition, to do all that was required of them. The fine pure blue, or bright gold, backgrounds on which the figures were spaced, as well as the broken surface incidental to the process, created an atmosphere which harmonized all together. At St Sophia there were literally acres of such mosaics, and they seem to have been applied with similar profusion in the imperial palace.

Mosaic was only a more magnificent kind of painting, and painted design followed exactly the same laws; the difference is in the splendour of effect and in the solidity and depth of colour. Paintings, from the first, must have been of more grey and pearly hues. A large side chapel at the mosaic church at Constantinople is painted, and it is difficult to say which is really the more beautiful, the deep splendour of the one, or the tender yet gay colour of the other. The greatest thing in Byzantine art was this picturing of the interiors of entire buildings with a series of mosaics or paintings, filling the wall space, vaults and domes with a connected story. The typical character of the personages and scenes, the elimination of non-essentials, and the continuity of the tradition, brought about an intensity of expression such as may nowhere else be found. It is part of the limited greatness of this side of Byzantine art that there was no room in it for the gaiety and humour of the later medieval schools; all was solemn, epical, cosmic. When such stories are displayed on the golden ground of arches and domes, and related in a connected cycle, the result produces, as it was intended to produce, a sense of the universal and eternal. Beside this great power of co-ordination possessed by Byzantine artists, they created imaginative types of the highest perfection. They clothed Christian ideas with forms so worthy, which have become so diffused, and so intimately one with the history, that we are apt to take them for granted, and not to see in them the superb results of Greek intuition and power of expression. Such a type is the Pantocrator,—the Creator-Redeemer, the Judge inflexible and yet compassionate,—who is depicted at the zenith of all greater domes; such the Virgin with the Holy Child, enthroned or standing in the conchs of apses, all tenderness and dignity, or with arms extended, all solicitude; of her image the *Painter's Guide* directs that it is to be painted with the "complexion the colour of wheat, hair and eyes brown, grand eyebrows, and beautiful eyes, clad in beautiful clothing, humble, beautiful and faultless"; such are the angels with their mighty

wings, splendid impersonations of beneficent power; such are the prophets, doctors, martyrs, saints,—all have been fixed into final types.

We are apt to speak of the rigidity and fixity of Byzantine work, but the method is germane in the strictest sense to the result desired, and we should ask ourselves how far it is possible to represent such a serious and moving drama except by dealing with more or less unchangeable types. It could be no otherwise. This art was not a matter of taste, it was a growth of thought, cast into an historical mould. Again, the artists had an extraordinary power of concentrating and abstracting the great things of a story into a few elements or symbols. For example, the seven days of creation are each figured by some simple detail, such as a tree, or a flight of birds, or symbolically, as seven spirits; the flood by an ark on the waters. What the capabilities of such a method are, where invention is not allowed to wander into variety, but may only add intensity, may, for instance, be seen in representations of the Agony in the Garden. This subject is usually divided into three sections, each consecutive one showing, with the same general scene, greater darkness, an advance up the hill, and the figure of Christ more bowed. Another composition, the "Sleep (death) of the Virgin," is all sweetness and peace, but no less powerful. A remarkable invention is the *etomasia*, a splendid empty throne prepared for the Second Advent. The stories of the Old Testament are put into relation with the Gospel by way of type and anti-type. There are allegories: the anchorite life contrasted with the mad life of the world, the celestial ladder, &c., and fine impersonations, such as night and dawn, mercy and truth, cities and rivers, are frequently found, especially in MS. pictures.

A few general schemes may be briefly summarized. St Sophia has the Pantocrator in the middle of the dome, and four cherubim of colossal size at the four corners; on the walls below were angels, prophets, saints and doctors. On the circle of the apse was enthroned the Virgin. To the right and left, high above the altar, were two archangels holding banners inscribed "Holy, Holy, Holy." These last are also found at Nicaea, and at the monastery of St Luke. The church of the Holy Apostles had the Ascension in the central dome, and below, the Life of Christ. St Sophia, Salonica, also has the Ascension, a composition which is repeated on the central dome of St Mark's, Venice. In the eastern dome of the Venetian church is Christ surrounded by prophets, and, in the western dome, the Descent of the Holy Spirit upon the Apostles. A Pentecost similar to the last occupies the dome over the Bema of St Luke's monastery in Phocis; in the central dome of this church is the Pantocrator, while in a zone below stand, the Virgin to the east, St John Baptist to the west, and the four archangels, Michael, Gabriel, Raphael and Uriel, to the north and south. A better example of grandeur of treatment can hardly be cited than the paintings of the now destroyed dome of the little church of Megale Panagia at Athens, a dome which was only about 12 ft. across. At the centre was Christ enthroned, next came a series of nine semi-circles containing the orders of the angels, seraphim, cherubim, thrones, dominations, virtues, powers, principalities, archangels and angels. Below these came a wide blue belt set with stars and the signs of the zodiac; to the east the sun, to the west the moon. Still below these were the winds, hail and snow; and still lower mountains and trees and the life on the earth, with all of which were interwoven passages from the last three Psalms, forming a Benedicite. After St Mark's, Venice, the completest existing scheme of mosaics is that of the church of St Luke; those of Daphne, Athens, are the most beautiful. A complete series of paintings exists in one of the monastic churches on Mount Athos. The Pantocrator is at the centre of the dome, then comes a zone with the Virgin, St John Baptist and the orders of the angels. Then the prophets between the windows of the dome and the four evangelists in the pendentives. On the rest of the vaults is the life of Christ, ending at the Bema with the Ascension; in the apse is the Virgin above, the Divine Liturgy lower, and the four doctors of the church below. All the walls are painted as well as the vaults. The mosaics overflowed from

the interiors on to the external walls of buildings even in Roman days, and the same practice was continued on churches. The remains of an external mosaic of the 6th century exist on the west façade of the basilica at Parenzo. Christ is there seated amongst the seven candlesticks, and adored by saints. At the basilica at Bethlehem the gable end was appropriately covered with a mosaic of the Nativity, also a work of the age of Justinian. In Rome, St Peter's and other churches had mosaics on the façades; a tradition represented, in a small way, at San Miniato, Florence. At Constantinople, according to Clavigno, the Spanish ambassador who visited that city about 1400, the church of St Mary of the Fountain had its exterior richly worked in gold, azure and other colours; and it seems almost necessary to believe that the bare front of the narthex of St Sophia was intended to be decorated in a similar manner. In Damascus the courtyard of the Great Mosque seems to have been adorned with mosaics; photographs taken before the fire in 1893 show patches on the central gable in some of the spandrels of the side colonnades and on the walls of the isolated octagonal treasury. The mosaics here were of Byzantine workmanship, and their effect, used in such abundance, must have been of great splendour. In Jerusalem the mosque of Omar also had portions of the exterior covered with mosaics. We may imagine that such external decorations of the churches, where a few solemn figures told almost as shadows on the golden background brightly reflecting the sun, must have been even more glorious than the imagery of their interiors.

Painted books were hardly different in their style from the paintings on the walls. Of the MSS. the Cottonian Genesis, now only a collection of charred fragments, was an early example. The great *Natural History* of Dioscorides of Vienna (c. 500) and the Joshua Roll of the Vatican, which have both been lately published in perfect facsimile, are magnificent works. In the former the plants are drawn with an accuracy of observation which was to disappear for a thousand years. The latter shows a series of drawings delicately tinted in pinks and blues. Many of the compositions contain classical survivals, like personified rivers.

In some of the miniatures of the later school of the art the classical revival of the 10th century was especially marked. Still later others show a very definite Persian influence in their ornamentation, where intricate arabesques almost of the style of eastern rugs are found.

The Plastic Art.—If painting under the new conditions entered on a fresh course of power and conquest, if it set itself successfully to provide an imagery for new and intense thought, sculpture, on the other hand, seems to have withered away as it became removed from the classic stock. Already in the pre-Constantinian epoch of classical art sculpture had become strangely dry and powerless, and as time went on the traditions of modelling appear to have been forgotten. Two points of recent criticism may be mentioned here. It has been shown that the porphyry images of warriors at the south-west angle of St Mark's, Venice, are of Egyptian origin and are of late classical tradition. The celebrated bronze St Peter at Rome is now assigned to the 13th century. Not only did statue-making become nearly a lost art, but architectural carvings ceased to be seen as modelled form, and a new system of relief came into use. Ornament, instead of being gathered up into forcible projections relieved against retiring planes, and instead of having its surfaces modulated all over with delicate gradations of shade, was spread over a given space in an even fretwork. Such a highly developed member as the capital, for instance, was thought of first as a simple, solid form, usually more or less the shape of a bowl, and the carving was spread out over the general surface, the background being sunk into sharply defined spaces of shadow, all about the same size. Often the background was so deeply excavated that it ceased to be a plane supporting the relieved parts, but passed wholly into darkness. Strzygowski has given to this process the name of the "deep-dark" ground. A further step was to relieve the upper fretwork of carving from the ground altogether in certain places by cutting away the sustaining portions.

The simplicity, the definition and crisp sharpness of some of the results are entirely delightful. The bluntness and weariness of many of the later modelled Roman forms disappear in the new energy of workmanship which was engaged in exploring a fresh field of beauty. These brightly illuminated lattices of carved ornament seem to hold within them masses of cold shadow. Beautiful as was this method of architectural adornment, it must be allowed that it was, in essence, much more elementary than the school of modelled form. All such carvings were usually brightly coloured and gilt, and it seems probable that the whole was considered rather as a colour arrangement than as sculpture proper.

Plaster work, again, an art on which wonderful skill was lavished in Rome, became under the Byzantines extremely rude. Many good examples of this work exist at San Vitale and Sant' Apollinare in Classe at Ravenna, also at Parenzo, and at St Sophia, Constantinople. Later examples of plaster work of Byzantine tradition are to be found at Cividale, and at Sant' Ambrogio, Milan, where the tympana of the well-known baldachin are of this material, and contain modelled figures.

Coins and medallions of even the best period of Byzantine art prove what a deep abyss separates them from the power over modelled relief shown in classical examples. The sculptural art is best displayed by ivory carvings, although this is more to be attributed to their pictorial quality than to a feeling for modelling.

Metal Work, Ivories and Textiles.—One of the greatest of Byzantine arts is the goldsmith's. This absorbed so much from Persian and Oriental schools as to become semi-barbaric. Under Justinian the transformation from Classical art was almost complete. Some few examples, like a silver dish from Cyprus in the British Museum, show refined restraint; on the other hand, the mosaic portraits of the emperor and Theodora show crowns and jewels of full Oriental style, and the description of the splendid fittings of St Sophia read like an eastern tale. Goldsmith's work was executed on such a scale for the great church as to form parts of the architecture of the interior. The altar was wholly of gold, and its ciborium and the iconostasis were of silver. In the later palace-church, built by Basil the Macedonian, the previous metals were used to such an extent that it is clear, from the description, that the interior was intended to be, as far as possible, like a great jewelled shrine. Gold and silver, we are told, were spread over all the church, not only in the mosaics, but in plating and other applications. The enclosure of the bema, with its columns and entablatures, was of silver gilt, and set with gems and pearls.

The most splendid existing example of goldsmith's work on a large scale is the *Pala d'Oro* of St Mark's, Venice; an assemblage of many panels on which saints and angels are enamelled. The monastic church of St Catherine, Sinai, is entered through a pair of enamelled doors, and several doors inlaid with silver still exist. In these doors the ground was of gilt-bronze; but there is also record of silver doors in the imperial palace at Constantinople. The inlaid doors of St Paul Outside the Walls at Rome were executed in Constantinople by Staurosios, in 1070, and have Greek inscriptions. There are others at Salerno (c. 1080), but the best known are those at St Mark's, Venice. In all these the imagery was delineated in silver on the gilt-bronze ground. The earliest works of this sort are still to be found in Constantinople. The panels of a door at St Sophia bear the monograms of Theophilus and Michael (840). Two other doors in the narthex of the same church, having simpler ornamentation of inlaid silver, are probably as early as the time of Justinian.

The process of enamelling dates from late classical times and Venturi supposes that it was invented in Alexandria. The cloisonné process, characteristic of Byzantine enamels, is thought by Kondakov to be derived from Persia, and to its study he has devoted a splendid volume. One of the finest examples of this cloisonné is the reliquary at Limburg on which the enthroned Christ appears between St Mary and St John in the midst of the twelve apostles. An inscription tells that it was executed for the emperors Constantine and Romanus (948-959).

A reliquary lately added to the J. Pierpont Morgan collection at South Kensington is of the greatest beauty in regard to the colour and clearness of the enamel. The cover, which is only about 4½ by 3 ins., has in the centre a crucifixion with St Mary and St John to the right and left, while around are busts of the apostles. Christ is vested in a tunic. The ground colour is the green of emerald, the rest mostly blue and white. The cloisons are of gold. Two other Byzantine enamels are in the permanent collection at the Victoria and Albert Museum: one is a cross with the crucifixion on a background of the same emerald enamel; the other is a small head of St Paul of remarkably fine workmanship.

Ivory-working was another characteristic Byzantine art, although, like so many others it had its origin in antiquity. One of the earliest ivories of the Byzantine type is the diptych at Monza, showing a princess and a boy, supposed to be Galla Placidia and Valentinian III. This already shows the broad, flattened treatment which seems to mark the ivory work of the East. The majestic archangel of the British Museum, one of the largest panels known, is probably of the 5th century, and almost certainly, as Strzygowski has shown, of Syrian origin. Design and execution are equally fine. The drawing of the body, and the modelling of the drapery, are accomplished and classical. Only the full front pose, the balanced disposition of the large wings, and the intense outlook of the face, give it the Byzantine type.

Ivory, like gold-work and enamel, was pressed into the adornment of architectural works. The ambo erected by Justinian at St Sophia was in part covered by ivory panels set into the marble. The best existing specimen of this kind of work is the celebrated ivory throne at Ravenna. This masterpiece, which resembles a large, high-backed chair, is entirely covered with sculptured ivory, delicate carvings of scriptural subjects and ornament. It is of the 6th century and bears the monogram of Bishop Maximian. It is probably of Egyptian or Syrian origin.

So many fragments of ivories have been discovered in recent explorations in Egypt that it is most likely that Alexandria, a fit centre for receiving the material, was also its centre of distribution. The weaving of patterned silks was known in Europe in the classical age, and they reached great development in the Byzantine era. A fragment, long ago figured by Semper, showing a classical design of a nereid on a sea-horse, is so like the designs found on many ivories discovered in Egypt that we may probably assign it to Alexandria. Such fabrics going back to the 3rd century have been found in Egypt which must have been one of the chief centres for the production of silk as for linen textiles. The Victoria and Albert Museum is particularly rich in early silks. One fine example, having rose-coloured stripes and repeated figures of Samson and the lion, must be of the great period of the 6th century. The description of St Sophia written at that time tells of the altar curtains that they bore woven images of Christ, St Peter and St Paul standing under tabernacles upon a crimson ground, their garments being enriched with gold embroidery. Later the patterns became more barbaric and of great scale, lions trampled across the stuff, and in large circles were displayed eagles, griffins and the like in a fine heraldic style. From the origin of the raw material in China and India and the ease of transport, such figured stuffs gathered up and distributed patterns over both Europe and Asia. The Persian influence is marked. There is, for example, a pattern of a curious dragon having front feet and a peacock's tail. It appears on a silver Persian dish in the Hermitage Museum, it is found on the mixed Byzantine and Persian carvings of the palace of Mashita, and it occurs on several silks of which there are two varieties at the Victoria and Albert Museum, both of which are classed as Byzantine; it is difficult to say of many of these patterns whether they are Sasanian originals or Byzantine adaptations from them.

AUTHORITIES.—A very complete bibliography is given by H. Leclercq, *Manuel d'archéologie chrétienne* (Paris, 1907). The current authorities for all that concerns Byzantine history or art are:—

Byzantinische Zeitschrift . . . (Leipzig, 1892 seq.); *Oriens Christianus* (Rome, 1900 seq.). See also Dom R. P. Cabrol, *Dictionnaire d'archéologie chrétienne*, &c. (Paris, 1902 seq.). The best general introduction is—C. Bayet, *L'Art byzantin* (Paris, 1883, new edition, 1904). See J. Strzygowski, *Oriens oder Rom* (Leipzig, 1901) and other works; Kondakov, *Les Émaux byz.* (1892), and other works; C. Diehl, *Justinien et la civilis. byz.* (Paris, 1901), and other works; G. Millet, *Le Monastère de Daphné*, &c. (Paris, 1899), and other works; L. G. Schlumberger, *L'Épée byz.* &c. (1896 seq.); A. Michel, *Histoire de l'art*, vol. 1. (Paris, 1905); H. Brockhaus, *Die Kunst in den Athos-Klöstern* (Leipzig, 1891); E. Molinier, *Histoire générale des arts*, &c. 1., *Émaux* (Paris, 1896); G. Dalton, *Catalogue of Early Christian Antiquities . . . of the British Museum* (1901); A. van Millingen, *Byzantine Constantinople* (1899); Salzenberg, *Altchristliche Baudenkmäler* &c. (Berlin, 1854); A. Choisy, *L'Art de bâtir chez les Byzantins* (Paris, 1875); Couchand, *Eglises byzantines en Grèce; Ougania, Basilica di S. Marco; Texier et Pullan, L'Architecture* b. 73 (1864); Lethaby and Swinson, *Sancta Sophia, Constantinople* (1894); Schultz and Barnaky, *The Monastery of St Luke*, &c. (1890); L. de Beylié, *L'Habitation byz.* (Paris, 1903). For Syria: M. de Vogüé, *L'Architecture . . . dans la Syrie centrale* (Paris, 1866-1877); H. C. Butler, *Architecture and other Arts*, &c. (New York, 1901). For Egypt: W. E. Crum, *Coptic Monuments* (Cairo, 1902); A. Gayet, *L'Art Copte* (Paris, 1902); A. J. Butler, *Ancient Coptic Churches*. For North Africa: S. Geell, *Les Monuments antiques de l'Algérie* (Paris, 1901). For Italy: A. Venturi, *Storia dell'arte italiana* (Milan, 1901); G. Rivoira, *Le Origini della architettura Lombarda* (Rome, 1901); C. Errard and A. Gayet, *L'Art byzantin*, &c. (Paris, 1903). (W. R. L.)

BYZANTIUM, an ancient Greek city on the shores of the Bosphorus, occupying the most easterly of the seven hills on which modern Constantinople stands. It was said to have been founded by Megarians and Argives under Byzas about 657 B.C., but the original settlement having been destroyed in the reign of Darius Hystaspes by the satrap Otanes, it was recolonized by the Spartan Pausanias, who wrested it from the Medes after the battle of Plataea (479 B.C.)—a circumstance which led several ancient chroniclers to ascribe its foundation to him. Its situation, said to have been fixed by the Delphic oracle, was remarkable for beauty and security. It had complete control over the Euxine grain-trade; the absence of tides and the depth of its harbour rendered its quays accessible to vessels of large burden; while the tunny and other fisheries were so lucrative that the curved inlet near which it stood became known as the Golden Horn. The greatest hindrance to its prosperity was the miscellaneous character of the population, partly Lacedæmonian and partly Athenian, who flocked to it under Pausanias. It was thus a subject of dispute between these states, and was alternately in the possession of each, till it fell into the hands of the Macedonians. From the same cause arose the violent intestine contests which ended in the establishment of a rude and turbulent democracy. About seven years after its second colonization, the Athenian Cimon wrested it from the Lacedæmonians; but in 440 B.C. it returned to its former allegiance. Alcibiades, after a severe blockade (408 B.C.), gained possession of the city through the treachery of the Athenian party; in 405 B.C. it was retaken by Lysander and placed under a Spartan harvest. It was under the Lacedæmonian power when the Ten Thousand, exasperated by the conduct of the governor, made themselves masters of the city, and would have pillaged it had they not been dissuaded by the eloquence of Xenophon. In 390 B.C. Thrasybulus, with the assistance of Heraclides and Archebius, expelled the Lacedæmonian oligarchy, and restored democracy and the Athenian influence.

After having withstood an attempt under Epaminondas to restore it to the Lacedæmonians, Byzantium joined with Rhodes, Chios, Cos, and Mausolus, king of Caria, in throwing off the yoke of Athens, but soon after sought Athenian assistance when Philip of Macedon, having overrun Thrace, advanced against it. The Athenians under Chares suffered a severe defeat from Amyntas, the Macedonian admiral, but in the following year gained a decisive victory under Phocion and compelled Philip to raise the siege. The deliverance of the besieged from a surprise, by means of a flash of light which revealed the advancing masses of the Macedonian army, has rendered this siege memorable. As a memorial of the miraculous interference, the Byzantines erected an altar to Torch-bearing Hecate, and stamped

a crescent on their coins, a device which is retained by the Turks to this day. They also granted the Athenians extraordinary privileges, and erected a monument in honour of the event in a public part of the city.

During the reign of Alexander Byzantium was compelled to acknowledge the Macedonian supremacy; after the decay of the Macedonian power it regained its independence, but suffered from the repeated incursions of the Scythians. The losses which they sustained by land roused the Byzantines to indemnify themselves on the vessels which still crowded the harbour, and the merchantmen which cleared the straits; but this had the effect of provoking a war with the neighbouring naval powers. The exchequer being drained by the payment of 10,000 pieces of gold to buy off the Gauls who had invaded their territories about 279 B.C., and by the imposition of an annual tribute which was ultimately raised to 80 talents, they were compelled to exact a toll on all the ships which passed the Bosphorus—a measure which the Rhodians resented and avenged by a war, wherein the Byzantines were defeated. After the retreat of the Gauls Byzantium rendered considerable services to Rome in the contests with Philip II., Antiochus and Mithradates.

During the first years of its alliance with Rome it held the rank of a free confederate city; but, having sought arbitration on some of its domestic disputes, it was subjected to the imperial jurisdiction, and gradually stripped of its privileges, until reduced to the status of an ordinary Roman colony. In recollection of its former services, the emperor Claudius remitted the heavy tribute which had been imposed on it; but the last remnant of its independence was taken away by Vespasian, who, in answer to a remonstrance from Apollonius of Tyana, taunted the inhabitants with having "forgotten to be free." During the civil wars it espoused the party of Pescennius Niger; and though skillfully defended by the engineer Periscus, it was besieged and taken (A.D. 196) by Severus, who destroyed the city, demolished the famous wall, which was built of massive stones so closely riveted together as to appear one block, put the principal inhabitants to the sword and subjected the remainder to the Perinthians. This overthrow of Byzantium was a great loss to the empire, since it might have served as a protection against the Goths, who afterwards sailed past it into the Mediterranean. Severus afterwards relented, and, rebuilding a large portion of the town, gave it the name of Augusta Antonina. He ornamented the city with baths, and surrounded the hippodrome with porticos; but it was not till the time of Caracalla that it was restored to its former political privileges. It had scarcely begun to recover its former position when, through the capricious resentment of Gallienus, the inhabitants were once more put to the sword and the town was pillaged. From this disaster the inhabitants recovered so far as to be able to give an effectual check to an invasion of the Goths in the reign of Claudius II., and the fortifications were greatly strengthened during the civil wars which followed the abdication of Diocletian. Licinius, after his defeat before Adrianople, retired to Byzantium, where he was besieged by Constantine, and compelled to surrender (A.D. 323-324). To check the inroads of the barbarians on the north of the Black Sea, Diocletian had resolved to transfer his capital to Nicomedia; but Constantine, struck with the advantages which the situation of Byzantium presented, resolved to build a new city there on the site of the old and transfer the seat of government to it. The new capital was inaugurated with special ceremonies, A.D. 330. (See CONSTANTINOPLE.)

The ancient historians invariably note the profligacy of the inhabitants of Byzantium. They are described as an idle, depraved people, spending their time for the most part in loitering about the harbour, or carousing over the fine wine of Maronea. In war they trembled at the sound of a trumpet, in peace they quaked before the shouting of their own demagogues; and during the assault of Philip II. they could only be prevailed on to man the walls by the savour of extempore cook-shops distributed along the ramparts. The modern Greeks attribute the introduction of Christianity into Byzantium to St Andrew; it certainly had some hold there in the time of Severus.

C The third letter in the Latin alphabet and its descendants corresponds in position and in origin to the Greek Gamma (Γ, γ), which in its turn is borrowed from the third symbol of the Phoenician alphabet (Heb. *Gimel*). The earliest Semitic records give its form as **𐤃** or more frequently **𐤃** or **𐤃**. The form **𐤃** is found in the earliest inscriptions of Crete, Attica, Naxos and some other of the Ionic islands. In Argolis and Euboea especially a form with legs of unequal length is found **𐤃**. From this it is easy to pass to the most widely spread Greek form, the ordinary **Γ**. In Corinth, however, and its colony Corcyra, in Ozolian Locris and Elis, a form **𐤃** inclined at a different angle is found. From this form the transition is simple to the rounded **C**, which is generally found in the same localities as the pointed form, but is more widely spread, occurring in Arcadia and on Chalcidian vases of the 6th century B.C., in Rhodes and Megara with their colonies in Sicily. In all these cases the sound represented was a hard G (as in *gig*). The rounded form was probably that taken over by the Romans and with the value of G. This is shown by the permanent abbreviation of the proper names Gaius and Gnaeus by C. and Cn. respectively. On the early inscription discovered in the Roman Forum in 1899 the letter occurs but once, in the form **𐤃** written from right to left. The broad lower end of the symbol is rather an accidental pit in the stone than an attempt at a diacritic mark—the word is *reges*, in all probability the early dative form of *rex*, “king.” It is hard to decide why Latin adopted the *g*-symbol with the value of *k*, a letter which it possessed originally but dropped, except in such stereotyped abbreviations as K. for the proper name *Caeso* and *Kal.* for *Calendas*. There are at least two possibilities: (1) that in Latium *g* and *k* were pronounced almost identically, as, e.g., in the German of Württemberg or in the Celtic dialects, the difference consisting only in the greater energy with which the *k*-sound is produced; (2) that the confusion is graphic, K being sometimes written |C, which was then regarded as two separate symbols. A further peculiarity of the use of C in Latin is in the abbreviation for the district *Subura* in Roma and its adjective *Suburanus*, which appears as SVC. Here C no doubt represents G, but there is no interchange between *g* and *b* in Latin. In other dialects of Italy *b* is found representing an original voiced guttural (*gw*), which, however, is regularly replaced by *v* in Latin. As the district was full of traders, *Subura* may very well be an imported word, but the form with C must either go back to a period before the disappearance of *g* before *v* or must come from some other Italic dialect. The symbol G was a new coinage in the 3rd century B.C. The pronunciation of C throughout the period of classical Latin was that of an unvoiced guttural stop (*k*). In other dialects, however, it had been palatalized to a sibilant before *i*-sounds some time before the Christian era; e.g. in the Umbrian *facia*=Latin *faciat*. In Latin there is no evidence for the interchange of *c* with a sibilant earlier than the 6th century A.D. in south Italy and the 7th century A.D. in Gaul (Lindsay, *Latin Language*, p. 88). This change has, however, taken place in all Romance languages except Sardinian. In Anglo-Saxon *c* was adopted to represent the hard stop. After the Norman conquest many English words were re-spelt under Norman influence. Thus Norman-French spelt its palatalized *c*-sound (= *tsk*) with *ch* as in *cher* and the English palatalized *c* (*tsk*) became *child*, &c. In Provençal from the 10th century, and in the northern dialects of France from the 13th century, this palatalized *c* (in different districts *ts* and *tsk*) became a simple *s*. English also adopted the value of *s* for *c* in the 13th century before *e*, *i* and *y*. In some foreign words like *cicala* the *ch*- (*tsk*) value is given to *c*. In the transliteration of foreign languages also it receives different values, having that of *tsk* in the transliteration of Sanskrit and of *ts* in various Slavonic dialects.

As a numeral C denotes 100. This use is borrowed from Latin, in which the symbol was originally **Ϟ**, a form of the Greek **θ**.

This, like the numeral symbols later identified with L and M, was thus utilized since it was not required as a letter, there being no sound in Latin corresponding to the Greek **θ**. Popular etymology identified the symbol with the initial letter of *centum*, “hundred.” (P. Gl.)

CAB (shortened about 1825 from the Fr. *cabriolet*, derived from *cabriole*, implying a bounding motion), a form of horse-drawn vehicle for passengers either with two (“hansom”) or four wheels (“four-wheeler” or “growler”), introduced into London as the *cabriolet de place*, from Paris in 1820 (see CARRIAGE). Other vehicles plying for hire and driven by mechanical means are included in the definition of the word “cab” in the London Cab and Stage Carriage Act 1907. The term “cab” is also applied to the driver’s or stoker’s shelter on a locomotive-engine.

Cabs, or hackney carriages, as they are called in English acts of parliament, are regulated in the United Kingdom by a variety of statutes. In London the principal acts are the Hackney Carriage Acts of 1831–1853, the Metropolitan Public Carriages Act 1869, the London Cab Act 1896 and the London Cab and Stage Carriage Act 1907. In other large British towns cabs are usually regulated by private acts which incorporate the Town Police Clauses Act 1847, an act which contains provisions more or less similar to the London acts. The act of 1869 defined a hackney carriage as any carriage for the conveyance of passengers which plies for hire within the metropolitan police district and is not a stage coach, i.e. a conveyance in which the passengers are charged separate and distinct fares for their seats. Every cab must be licensed by a licence renewable every year by the home secretary, the licence being issued by the commissioner of police. Every cab before being licensed must be inspected at the police station of the district by the inspector of public carriages, and certified by him to be in a fit condition for public use. The licence costs £2. The number of persons which the cab is licensed to carry must be painted at the back on the outside. It must carry a lighted lamp during the period between one hour after sunset and one hour before sunrise. The cab must be under the charge of a driver having a licence from the home secretary. A driver before obtaining a licence, which costs five shillings per annum, must pass an examination as to his ability to drive and as to his knowledge of the topography of London.

General regulations with regard to fares and hiring may be made from time to time by the home secretary under the London Cab and Stage Carriage Act 1907. The hiring is by distance or by time as the hirer may decide at the beginning of the hiring; if not otherwise expressed the fare is paid according to distance. If a driver is hired by distance he is not compelled to drive more than six miles, and if hired by time he is not compelled to drive for more than one hour. When a cab is hired in London by distance, and discharged within a circle the radius of which is four miles (the centre being taken at Charing Cross), the fare is one shilling for any distance not exceeding two miles, and sixpence for every additional mile or part of a mile. Outside the circle the fare for each mile, or part of a mile, is one shilling. When a cab is hired by time, the fare (inside or outside the circle) is two shillings and sixpence for the first hour, and eightpence for every quarter of an hour afterwards. Extra payment has to be made for luggage (twopence per piece outside), for extra passengers (sixpence each for more than two), and for waiting (eightpence each completed quarter of an hour). If a horse cab is fitted with a taximeter (*vide infra*) the fare for a journey wholly *within* or partly without and partly within the four-mile radius, and not exceeding one mile or a period of ten minutes, is sixpence. For each half mile or six minutes an additional threepence is paid. If the journey is wholly *without* the four-mile radius the fare for the first mile is one shilling, and for each additional quarter of a mile or period of three minutes, threepence is paid. If the cab is one propelled by mechanical means the fare for a journey not

exceeding one mile or a period of ten minutes is eightpence, and for every additional quarter mile or period of 2½ minutes twopence is paid. A driver required to wait may demand a reasonable sum as a deposit and also payment of the sum which he has already earned. The London Cab Act 1896 (by which for the first time legal sanction was given to the word "cab") made an important change in the law in the interest of cab drivers. It renders liable to a penalty on summary conviction any person who (a) hires a cab knowing or having reason to believe that he cannot pay the lawful fare, or with intent to avoid payment; (b) fraudulently endeavours to avoid payment; (c) refuses to pay or refuses to give his address, or gives a false address with intent to deceive. The offences mentioned (generally known as "bilking") may be punished by imprisonment without the option of a fine, and the whole or any part of the fine imposed may be applied in compensation to the driver.

Strictly speaking, it is an offence for a cab to ply for hire when not waiting on an authorized "standing," but cabs passing in the street for this purpose are not deemed to be "plying for hire." These stands for cabs are appointed by the commissioner of police or the home secretary. "Privileged cabs" is the designation given to those cabs which by virtue of a contract between a railway company and a number of cab-owners are alone admitted to ply for hire within a company's station, until they are all engaged, on condition (1) of paying a certain weekly or annual sum, and (2) of guaranteeing to have cabs in attendance at all hours. This system was abolished by the act of 1907, but the home secretary was empowered to suspend or modify the abolition if it should interfere with the proper accommodation of the public.

At one time there was much discussion in England as to the desirability of legalizing on cabs the use of a mechanical fare-recorder such as, under the name of taximeter or taxameter, is in general use on the continent of Europe. It is now universal on hackney carriages propelled by mechanical means, and it has also extended largely to those drawn by animal power. A taximeter consists of a securely closed and sealed metal box containing a mechanism actuated by a flexible shaft connected with the wheel of the vehicle, in the same manner as the speedometer on a motor car. It has, within plain view of the passenger, a number of apertures in which appear figures showing the amount payable at any time. A small lever, with a metal flag, bearing the words "for hire" stands upright upon it when the cab is disengaged. As soon as a passenger enters the cab the lever is depressed by the driver and the recording mechanism starts. At the end of the journey the figures upon the dials show exactly the sum payable for hire; this sum is based on a combination of time and distance.

CABAL (through the Fr. *cabale* from the *Cabbala* or *Kabbalah*, the theosophical interpretation of the Hebrew scriptures), a private organization or party engaged in secret intrigues, and applied also to the intrigues themselves. The word came into common usage in English during the reign of Charles II. to describe the committee of the privy council known as the "Committee for Foreign Affairs," which developed into the cabinet. The invidious meaning attached to the term was stereotyped by the coincidence that the initial letters of the names of the five ministers, Clifford, Arlington, Buckingham, Ashley and Lauderdale, who signed the treaty of alliance with France in 1673, spelled cabal.

CABALLERO, FERNÁN (1796-1877), the pseudonym adopted from the name of a village in the province of Ciudad Real by the Spanish novelist Cecilia Francisca Josefa Böhl de Faber y Arrea. Born at Morges in Switzerland on the 24th of December 1796, she was the daughter of Johan Nikolaus Böhl von Faber, Hamburg merchant, who lived long in Spain, married a native of Cadiz, and is creditably known to students of Spanish literature as the editor of the *Floresta de rimas antiguas castellanas* (1821-25), and the *Teatro español anterior a Lope de Vega* (1832). Educated principally at Hamburg, she visited Spain in 1816, and, fortunately for herself, in 1816 married Antonio Planells y Ardaxi, an infantry captain of bad character. In the following year Planells was killed in action, and in 1822 the young widow

married Francisco Ruiz del Arco, marqués de Arco Hermoso, an officer in one of the Spanish household regiments. Upon the death of Arco Hermoso in 1835, the marquesa found herself in straitened circumstances, and in less than two years she married Antonio Arrón de Ayala, a man considerably her junior. Arrón was appointed consul in Australia, engaged in business enterprises and made money; but unfortunate speculations drove him to commit suicide in 1859. Ten years earlier the name of Fernán Caballero became famous in Spain as the author of *La Gaviota*. The writer had already published in German an anonymous romance, *Sola* (1840), and curiously enough the original draft of *La Gaviota* was written in French. This novel, translated into Spanish by José Joaquín de Mora, appeared as the *Jewelleton of El Heraldo* (1849), and was received with marked favour. Octave, a prominent critic of the day, ratified the popular judgment, and hopefully proclaimed the writer to be a rival of Scott. No other Spanish book of the 19th century has obtained such instant and universal recognition. It was translated into most European languages, and, though it scarcely seems to deserve the intense enthusiasm which it excited, it is the best of its author's works, with the possible exception of *La Familia de Alameda* (which was written, first of all, in German). Less successful attempts are *Lady Virginia* and *Clemencia*; but the short stories entitled *Cuadros de Costumbres* are interesting in matter and form, and *Una en otra* and *Elia ó la España treinta años ha* are excellent specimens of picturesque narration. It would be difficult to maintain that Fernán Caballero was a great literary artist, but it is certain that she was a born teller of stories and that she has a graceful style very suitable to her purpose. She came into Spain at a most happy moment, before the new order had perceptibly disturbed the old, and she brought to bear not alone a fine natural gift of observation, but a freshness of vision, undulled by long familiarity. She combined the advantages of being both a foreigner and a native. In later publications she insisted too emphatically upon the moral lesson, and lost much of her primitive simplicity and charm; but we may believe her statement that, though she occasionally idealized circumstances, she was conscientious in choosing for her themes subjects which had occurred in her own experience. Hence she may be regarded as a pioneer in the realistic field, and this historical fact adds to her positive importance. For many years she was the most popular of Spanish writers, and the sensation caused by her death at Seville on the 7th of April 1877 proved that her naive truthfulness still attracted readers who were interested in records of national customs and manners.

Her *Obras completas* are included in the *Colección de escritores castellanos*: a useful biography by Fernando de Gabriel Ruiz de Apodaca precedes the *Últimas producciones de Fernán Caballero* (Seville, 1878). (J. F.-K.)

CABANEL, ALEXANDRE (1823-1889), French painter, was born at Montpellier, and studied in Paris, gaining the Prix de Rome in 1845. His pictures soon attracted attention, and by his "Birth of Venus" (1863), now in the Luxembourg, he became famous, being elected that year to the Institute. He became the most popular portrait painter of the day, and his pupils included a number of famous artists.

CABANIS, PIERRE JEAN GEORGE (1757-1808), French physiologist, was born at Cosnac (Corrèze) on the 5th of June 1757, and was the son of Jean Baptiste Cabanis (1723-1786), a lawyer and agronomist. Sent at the age of ten to the college of Brives, he showed great aptitude for study, but his independence of spirit was so excessive that he was almost constantly in a state of rebellion against his teachers, and was finally dismissed from the school. He was then taken to Paris by his father and left to carry on his studies at his own discretion for two years. From 1773 to 1775 he travelled in Poland and Germany, and on his return to Paris he devoted himself mainly to poetry. About this time he ventured to send in to the Academy a translation of the passage from Homer proposed for their prize, and, though his attempt passed without notice, he received so much encouragement from his friends that he contemplated translating the whole of the *Iliad*. But at the

desire of his father he relinquished these pleasant literary employments, and resolving to engage in some settled profession selected that of medicine. In 1789 his *Observations sur les hôpitaux* procured him an appointment as administrator of hospitals in Paris, and in 1795 he became professor of hygiene at the medical school of Paris, a post which he exchanged for the chair of legal medicine and the history of medicine in 1799. From inclination and from weak health he never engaged much in practice as a physician, his interests lying in the deeper problems of medical and physiological science. During the last two years of Mirabeau's life he was intimately connected with that extraordinary man, and wrote the four papers on public education which were found among the papers of Mirabeau at his death, and were edited by the real author soon afterwards in 1791. During the illness which terminated his life Mirabeau confided himself entirely to the professional skill of Cabanis. Of the progress of the malady, and the circumstances attending the death of Mirabeau, Cabanis drew up a detailed narrative, intended as a justification of his treatment of the case. Cabanis espoused with enthusiasm the cause of the Revolution. He was a member of the Council of Five Hundred and then of the Conservative senate, and the dissolution of the Directory was the result of a motion which he made to that effect. But his political career was not of long continuance. A foe to tyranny in every shape, he was decidedly hostile to the policy of Bonaparte, and constantly rejected every solicitation to accept a place under his government. He died at Meulan on the 5th of May 1808.

A complete edition of Cabanis's works was begun in 1825, and five volumes were published. His principal work, *Rapports du physique et du moral de l'homme*, consists in part of memoirs, read in 1796 and 1797 to the Institute, and is a sketch of physiological psychology. Psychology is with Cabanis directly linked on to biology, for sensibility, the fundamental fact, is the highest grade of life and the lowest of intelligence. All the intellectual processes are evolved from sensibility, and sensibility itself is a property of the nervous system. The soul is not an entity, but a faculty; thought is the function of the brain. Just as the stomach and intestines receive food and digest it, so the brain receives impressions, digests them, and has as its organic secretion, thought. Alongside of this harsh materialism Cabanis held another principle. He belonged in biology to the vitalistic school of G. E. Stahl, and in the posthumous work, *Lettre sur les causes premières* (1824), the consequences of this opinion became clear. Life is something added to the organism; over and above the universally diffused sensibility there is some living and productive power to which we give the name of Nature. But it is impossible to avoid ascribing to this power both intelligence and will. In us this living power constitutes the ego, which is truly immaterial and immortal. These results Cabanis did not think out of harmony with his earlier theory.

CABARRUS, FRANÇOIS (1752-1810), French adventurer and Spanish financier, was born at Bayonne, where his father was a merchant. Being sent into Spain on business he fell in love with a Spanish lady, and marrying her, settled in Madrid. Here his private business was the manufacture of soap; but he soon began to interest himself in the public questions which were ventilated even at the court of Spain. The enlightenment of the 18th century had penetrated as far as Madrid; the king, Charles III., was favourable to reform; and a circle of men animated by the new spirit were trying to infuse fresh vigour into an enfeebled state. Among these Cabarrus became conspicuous, especially in finance. He originated a bank, and a company to trade with the Philippine Islands; and as one of the council of finance he had planned many reforms in that department of the administration, when Charles III. died (1788), and the reactionary government of Charles IV. arrested every kind of enlightened progress. The men who had taken an active part in reform were suspected and prosecuted. Cabarrus himself was accused of embezzlement and thrown into prison. After a confinement of two years he was released, created a count and employed in many honourable missions; he would even have been sent to Paris as Spanish ambassador, had not the Directory objected to him as being of French birth. Cabarrus took no part in the transactions by which Charles IV. was obliged to abdicate and make way for Joseph, brother of Napoleon, but his French birth and intimate knowledge of Spanish affairs

recommended him to the emperor as the fittest person for the difficult post of minister of finance, which he held at his death. His beautiful daughter Thérèse, under the name of Madame Tallien (afterwards princess of Chimay), played an interesting part in the later stages of the French Revolution.

CABASILAS, NICOLAUS (d. 1371), Byzantine mystic and theological writer. He was on intimate terms with the emperor John VI. Cantacuzene, whom he accompanied in his retirement to a monastery. In 1355 he succeeded his uncle Nilus Cabasilas, like himself a determined opponent of the union of the Greek and Latin churches, as archbishop of Thessalonica. In the Hesychast controversy he took the side of the monks of Athos, but refused to agree to the theory of the uncreated light. His chief work is his *Πρόβλητα ἐν Χριστῷ ἱεραῖς* (ed. fr. of the Greek text, with copious introduction, by W. Gass, 1849; new ed. by M. Heinze, 1899), in which he lays down the principle that union with Christ is effected by the three great mysteries of baptism, confirmation and the eucharist. He also wrote homilies on various subjects, and a speech against usurers, printed with other works in Migne, *Patrologia Graeca*, c. i. A large number of his works is still extant in MS.

See C. Krumbacher, *Geschichte der byzantinischen Litteratur* (1897), and article in Herzog-Hauck, *Realencyclopädie für protestantische Theologie* (1901).

CABATŪAN, a town of the province of Iloilo, Panay, Philippine Islands, on a branch of the Suague river, 15 m. N.W. of Iloilo, the capital. Pop. (1903) 16,497. In 1903, after the census had been taken, the neighbouring town of Maasin, with a population of 8401, was annexed to Cabatŭan. Its climate is healthful. The surrounding country is very fertile and produces large quantities of rice, as well as Indian corn, tobacco, sugar, coffee and a great variety of fruits. The language is Visayan. Cabatŭan was founded in 1732.

CABBAGE. The parent form of the variety of culinary and fodder vegetables included under this head is generally supposed to be the wild or sea cabbage (*Brassica oleracea*), a plant found near the sea coast of various parts of England and continental Europe, although Alphonse de Candolle considered it to be really descended from the two or three allied species which are yet found growing wild on the Mediterranean coast. In any case the cultivated varieties have departed very widely from the original type, and they present very marked and striking dissimilarities among themselves. The wild cabbage is a comparatively insignificant plant, growing from 1 to 2 ft. high, in appearance very similar to the corn mustard or charlock (*Sisymbrium arvensis*), but differing from it in having smooth leaves. The wild plant has fleshy, shining, wavy and lobed leaves (the uppermost being undivided but toothed), large yellow flowers, elongated seed-pod, and seeds with conduplicate cotyledons. Notwithstanding the fact that the cultivated forms differ in habit so widely, it is remarkable that the flower, seed-pods and seeds of the varieties present no appreciable difference.

John Lindley proposed the following classification for the various forms, which includes all yet cultivated: (1) All the leaf-buds active and open, as in wild cabbage and kale or greens. (2) All the leaf-buds active, but forming heads, as in Brussels sprouts; (3) Terminal leaf-bud alone active, forming a head, as in common cabbage, savoy, &c.; (4) Terminal leaf-bud alone active and open, with most of the flowers abortive and succulent, as in cauliflower and broccoli; (5) All the leaf-buds active and open, with most of the flowers abortive and succulent, as in sprouting broccoli. The last variety bears the same relation to common broccoli as Brussels sprouts do to the common cabbage. Of all these forms there are numerous gardeners' varieties, all of which reproduce faithfully enough their parent form by proper and separate cultivation.

Under Lindley's first class, common or Scotch kale or borecole (*Brassica oleracea* var. *acephala* or var. *fimbriata*) includes several varieties which are amongst the hardest of our esculents, and seldom fail to yield a good supply of winter greens. They require well-enriched soil, and sufficient space for full exposure to air; and they should also be sown early, so as to be well

established and hardened before winter. The main crops should be sown about the first week of April, or, in the north, in the third week of March, and a succession a month later. The Buda kale is sown in May, and planted out in September, but a sowing for late spring use may be made in the last week of August and transplanted towards the end of September. To prevent overcrowding, the plants should be transplanted as soon as they are of sufficient size; but if the ground is not ready to receive them a sufficient number should be pricked out in some open spot. In general the more vigorous sorts should be planted in rows 3 ft. and the smaller growers 2 ft. apart, and 18 in. from plant to plant. In these the heads should be first used, only so much of the heart as is fresh and tender being cut out for boiling; side shoots or sprouts are afterwards produced for a long time in succession, and may be used so long as they are tender enough to admit of being gathered by snapping their stalks asunder.

The plant sends up a stout central stem, growing upright to a height of about 2 ft., with close-set, large thick, plain leaves of a light red or purplish hue. The lower leaves are stripped off for use as the plants grow up, and used for the preparation of broth or "Scotch kail," a dish at one time in great repute in the north-eastern districts of Scotland. A very remarkable variety of open-leaved cabbage is cultivated in the Channel Islands under the name of the Jersey or branching cabbage. It grows to a height of 8 ft., but has been known to attain double that altitude. It throws out branches from the central stem, which is sufficiently firm and woody to be fashioned into walking-sticks; and the stems are even used by the islanders as rafters for bearing the thatch on their cottage-roofs. Several varieties are cultivated as ornamental plants on account of their beautifully coloured, frizzled and lacinated leaves.

Brussels sprouts (*Brassica oleracea* var. *bullata gemmifera*) are miniature cabbage-heads, about an inch in diameter, which form in the axils of the leaves. There appears to be no information as to the plant's origin, but, according to Van Mons (1765-1842), physician and chemist, it is mentioned in the year 1213, in the regulations for holding the markets of Belgium, under the name of *spruyten* (sprouts). It is very hardy and productive, and is much esteemed for the table on account of its flavour and its slightly appearance. The seed should be sown about the middle of March, and again in the first or second week in April for succession. Any good garden soil is suitable. For an early crop it may be sown in a warm pit in February, pricked out and hardened in frames, and planted out in a warm situation in April. The main crop may be planted in rows 2 ft. asunder, the plants 18 in. apart. They should be got out early, so as to be well established and come into use before winter. The head may be cut and used after the best of the little rosettes which feather the stem have been gathered; but, if cut too early, it exposes these rosettes, which are the most delicate portion of the produce, to injury, if the weather be severe. The earliest sprouts become fit for use in November, and they continue good, or even improve in quality, till the month of March following; by successive sowings the sprouts are obtained for the greater part of the year.

The third class is chiefly represented by the common or drum-head cabbage, *Brassica oleracea* var. *capitata*, the varieties of which are distinguished by difference in size, form and colour. In Germany it is converted into a popular article of diet under the name of *Sauerkraut* by placing in a tub alternate layers of salt and cabbage. An acid fermentation sets in, which after a few days is complete, when the vessel is tightly covered over and the product kept for use with animal food.

The savoy is a hardy green variety, characterized by its very wrinkled leaves. The Portugal cabbage, or *Corse Tronchuda*, is a variety, the tops of which form an excellent cabbage, while the midribs of the large leaves are cooked like sea-kale.

Cabbages contain a very small percentage of nitrogenous compounds as compared with most other articles of food. Their percentage composition, when cooked, is—water, 97.4; fat, 0.1; carbohydrate, 0.4; mineral matter, 0.1; cellulose, 1.3; nitrogenous matter (only about half being proteid), 0.6. Their food-

value, apart from their anti-scorbutic properties, is therefore practically nil.

The cabbage requires a well-manured and well-wrought loamy soil. It should have abundant water in summer, liquid manure being specially beneficial. Round London, where it is grown in perfection, the ground for it is dug to the depth of two spades or spits, the lower portion being brought up to the action of the weather, and rendered available as food for the plants; while the top-soil, containing the eggs and larvae of many insects, being deeply buried, the plants are less liable to be attacked by the club disease. Farm-yard manure is that most suitable for the cabbage, but artificial manures such as guano, superphosphate of lime or gypsum, together with lime-rubbish, wood-ashes and marl, may, if required, be applied with advantage.

The first sowing of cabbage should be made about the beginning of March; this will be ready for use in July and August, following the autumn-sown crops. Another sowing should be made in the last week of March or first week of April, and will afford a supply from August till November; and a further crop may be made in May to supply young-hearted cabbages in the early part of winter. The autumn sowing, which is the most important, and affords the supply for spring and early summer use, should be made about the last week in August, in warm localities in the south, and about a fortnight earlier in the north; or, to meet fluctuations of climate, it is as well in both cases to anticipate this sowing by another two or three weeks earlier, planting out a portion from each, but the larger number from that sowing which promises best to stand without running to seed.

The cabbages grown late in autumn and in the beginning of winter are denominated coleworts (vulg. collards), from a kindred vegetable no longer cultivated. Two sowings are made, in the middle of June and in July, and the seedlings are planted a foot or 15 in. asunder, the rows being 8 or 10 in. apart. The sorts employed are the Rosette and the Hardy Green.

About London the large sorts, as Enfield Market, are planted for spring cabbages 2 ft. apart each way; but a plant from an earlier sowing is dibbled in between every two in the rows, and an intermediate row a foot apart is put in between the permanent rows, these extra plants being drawn as coleworts in the course of the winter. The smaller sorts of cabbage may be planted 12 in. apart, with 12 or 15 in. between the rows. The large sorts should be planted 2 ft. apart, with 2½ ft. between the rows. The only culture required is to stir the surface with the hoe to destroy the weeds, and to draw up the soil round the stems.

The red cabbage, *Brassica oleracea* var. *capitata rubra*, of which the Red Dutch is the most commonly grown, is much used for pickling. It is sown about the end of July, and again in March or April. The Dwarf Red and Utrecht Red are smaller sorts. The culture is in every respect the same as in the other sorts, but the plants have to stand until they form hard close hearts.

Cauliflower, which is the chief representative of class 4, consists of the inflorescence of the plant modified so as to form a compact succulent white mass or head. The cauliflower (*Brassica oleracea* var. *bobyitis cauliflora*) is said by our old authors to have been introduced from Cyprus, where, as well as on the Mediterranean coasts, it appears to have been cultivated for ages. It is one of the most delicately flavoured of vegetables, the dense cluster formed by its incipient succulent flower-buds being the edible portion.

The sowing for the first or spring crop, to be in use in May and June, should be made from the 15th to the 25th of August for England, and from the 1st to the 15th of August for Scotland. In the neighbourhood of London the growers adhere as nearly as possible to the 21st day. A sowing to produce heads in July and August takes place in February on a slight hotbed. A late spring sowing to produce cauliflowers in September or October or later, should be made early in April and another about the 20th of May.

The cauliflower succeeds best in a rich soil and sheltered position; but, to protect the young plants in winter, they are sometimes pricked out in a warm situation at the foot of a south

wall, and in severe weather covered with hoops and mats. A better method is to plant them thickly under a garden frame, securing them from cold by coverings and giving air in mild weather. For a very early supply, a few scores of plants may be potted and kept under glass during winter and planted out in spring, defended with a hand-glass. Sometimes patches of three or four plants on a south border are sheltered by hand-glasses throughout the winter. It is advantageous to prick out the spring-sown plants into some sheltered place before they are finally transplanted in May. The later crop, the transplanting of which may take place at various times, is treated like early cabbages. After planting, all that is necessary is to hoe the ground and draw up the soil about the stems.

It is found that cauliflowers ready for use in October may be kept in perfection over winter. For this purpose they are lifted carefully with the spade, keeping a ball of earth attached to the roots. Some of the large outside leaves are removed, and any points of leaves that immediately overhang the flower are cut off. They are then placed either in pots or in garden frames, the plants being arranged close together, but without touching. In mild dry weather the glass frames are drawn off, but they are kept on during rainstorms, ventilation being afforded by slightly tilting the frames, and in severe frost they are thickly covered with mats.

Broccoli is merely a variety of cauliflower, differing from the other in the form and colour of its inflorescence and its hardness. The broccoli (*Brassica oleracea* var. *botrytis asparagoides*) succeeds best in loamy soil, somewhat firm in texture. For the autumn broccolis the ground can scarcely be too rich, but the winter and spring sorts on ground of this character are apt to become so succulent and tender that the plants suffer from frost even in sheltered situations, while plants less stimulated by manure and growing in the open field may be nearly all saved, even in severe winters. The main crops of the early sorts for use in autumn should be sown early in May, and planted out while young to prevent them coming too early into flower; in the north they may be sown a fortnight earlier. The later sorts for use during winter and spring should be sown about the middle or end of May, or about ten days earlier in the north. The seed-beds should be made in fresh light soil; and if the season be dry the ground should be well watered before sowing. If the young plants are crowding each other they should be thinned. The ground should not be dug before planting them out, as the firmer it is the better; but a shallow drill may be drawn to mark the lines. The larger-growing sorts may be put in rows 3 ft. apart, and the plants about 2½ ft. apart in the rows, and the smaller-growing ones at from 2 to 2½ ft. between, and 1½ to 2 ft. in the rows. If the ground is not prepared when young plants are ready for removal, they should be transferred to nursery beds and planted at 3 to 4 in. apart, but the earlier they can be got into their permanent places the better.

It is of course the young flower-heads of the plant which are eaten. When these form, they should be shielded from the light by bending or breaking down an inner leaf or two. In some of the sorts the leaves naturally curve over the heads. To prevent injury to the heads by frost in severe winters, the plants should be laid in with their heads sloping towards the north, the soil being thrown back so as to cover their stems; or they may be taken up and laid in closely in deep trenches, so that none of the lower bare portion of the stem may be exposed. Some dry fern may also be laid over the tops. The spring varieties are extremely valuable, as they come at a season when the finer vegetables are scarce. They afford a supply from December to May inclusive.

Broccoli sprouts, the representative of the fifth class, are a form of recent introduction, and consist of flowering sprouts springing from the axils of the leaves. The purple-leaved variety is a very hardy and much-esteemed vegetable.

Kohl-rabi (*Brassica oleracea* var. *caulorapa*) is a peculiar variety of cabbage in which the stem, just above ground, swells into a fleshy turnip-like mass. It is much cultivated in certain districts as a food for stock, for which purpose the drumhead cabbage and the thousand-headed kale are also largely used. Kohl-rabi is

exceedingly hardy, withstanding both severe frosts and drought. It is not much grown in English gardens, though when used young it forms a good substitute for turnips. The seeds should be sown in May and June, and the seedlings should be planted shallowly in well-manured ground, 8 or 10 in. apart, in rows 15 in. asunder, and they should be well watered, so as to induce quick growth.

The varieties of cabbage, like other fresh vegetables, are possessed of anti-scorbutic properties; but unless eaten when very fresh and tender they are difficult of digestion, and have a very decided tendency to produce flatulence.

Although the varieties reproduce by seed with remarkable constancy, occasional departures from the types occur, more especially among the varieties of spring cabbages, cauliflowers and broccolis. The departures, known technically as "rogues," are not as a rule sufficiently numerous to materially affect crops grown for domestic purposes. Rogues appearing among the stocks of seed-growers, however, if allowed to remain, very materially affect the character of particular stocks by the dissemination of strange pollen and by the admixture of their seed. Great care is exercised by seed-growers with reputations to maintain, to eliminate these from among their stock-plants before the flowering period is reached.

Several species of palm, from the fact of yielding large axillary central buds which are cooked as vegetables, are known as cabbage-palms. The principal of these is *Areca oleracea*, but other species, such as the coco-palm, the royal palm (*Oreodaza regia*), *Areca saccharifera* and others yield similar edible leaf-buds.

CABEIRI, in Greek mythology, a group of minor deities, of whose character and worship nothing certain is known. Their chief seats of worship were the islands of Lemnos, Imbros and Samothrace, the coast of Troas, Thessalia and Boeotia. The name appears to be of Phœnician origin, signifying the "great" gods, and the Cabeiri seem to have been deities of the sea who protected sailors and navigation, as such often identified with the Dioscuri, the symbol of their presence being St Elmo's fire. Originally the Cabeiri were two in number, an older identified with Hephaestus (or Dionysus), and a younger identified with Hermes, who in the Samothracian mysteries was called Cadmilus or Casmilus. Their cult at an early date was united with that of Demeter and Kore, with the result that two pairs of Cabeiri appeared, Hephaestus and Demeter, and Cadmilus and Kore. According to Mnaseas¹ (quoted by the scholiast on Apollonius Rhodius i. 917) they were four in number:—Axieros, Axiokersa, Axiokersos, Casmilus. It is there stated that Axieros is Demeter, Axiokersa, Persephone; Axiokersos, Hades; and Casmilus, Hermes. The substitution of Hades for Hephaestus is due to the fact that Hades was regarded as the husband of Persephone. Cabeiri, who is mentioned in the logographers Acusilaus and Pheroclydes as the wife of Hephaestus, is identical with Demeter, who indeed is expressly called *Kaβeipa* in Thebes. Roman antiquarians identified the Cabeiri with the three Capitoline deities or with the Penates. In Lemnos an annual festival of the Cabeiri was held, lasting nine days, during which all the fires were extinguished and fire brought from Delos. From this fact and from the statement of Strabo x. p. 473, that the father of the Cabeiri was Casmilus, a son of Hephaestus, the Cabeiri have been thought to be, like the Corybantes, Curetes and Dactyli, demurs of volcanic fire. But this view is not now generally held in Lemnos they fostered the vine and fruits of the field, and from their connexion with Hermes in Samothrace it would also seem that they promoted the fruitfulness of cattle.

By far the most important seat of their worship was Samothrace. Here, as early as the 5th century B.C., their mysteries, possibly under Athenian influence, attracted great attention, and initiation was looked upon as a general safeguard against all misfortune. But it was in the period after the death of Alexander the Great that their cult reached its height. Demetrius Poliorcetes, Lysimachus and Arsinoë regarded the Cabeiri with especial favour, and initiation was sought, not only by large numbers of pilgrims, but by persons of distinction. Initiation included also an asylum or refuge within the strong walls of Samothrace, for which purpose it was used among others by Arsinoë, who, to show her gratitude, afterwards caused a monument to be erected there, the ruins of which were explored in

¹ A grammarian of Patrae in Achaëa (or Patara, in Lycia), pupil of Eratosthenes (275-195 B.C.), and author of a peripplus and a collection of Delphic oracles.

1874 by an Austrian archaeological expedition. In 1888 interesting details as to the Boeotian cult of the Cabeiri were obtained by the excavations of their temple in the neighbourhood of Thebes, conducted by the German archaeological institute. The two male deities worshipped were Cabeiros and a boy: the Cabeiros resembles Dionysus, being represented on vases as lying on a couch, his head surrounded with a garland of ivy, a drinking cup in his right hand; and accompanied by maenads and satyrs. The boy is probably his cup-bearer. The Cabeiri were held in even greater esteem by the Romans, who regarded themselves as descendants of the Trojans, whose ancestor Dardanus (himself identified in heroic legend with one of the Cabeiri) came from Samothrace. The identification of the three Capitoline deities with the Penates, and of these with the Cabeiri, tended to increase this feeling.

See C. A. Lobeck, *Aglaophamus* (1829); F. G. Welcker, *Die Aeschylische Trilogie und die Kabirenweihe zu Lemnos* (1824); J. P. Rossignol, *Les Métaux dans l'antiquité* (1863), discussing the gods of Samothrace (the Dactyli, the Cabeiri, the Corybantes, the Curetes, and the Telchines) as workers in metal, and the religious origin of metallurgy; O. Rubensohn, *Die Mysterienheiligtümer in Eleusis und Samothrake* (1892); W. H. Roscher, *Lexikon der Mythologie* (s.v. "Megaloi Theoi"); L. Preller, *Griechische Mythologie* (4th ed., appendix); and the article by F. Lenormant in Daremberg and Saglio, *Dictionnaire des Antiquités*.

CABER TOSSING (Gaelic *caber*, a pole or beam), a Scottish athletic exercise which consists in throwing a section of a trunk of a tree, called the "caber," in such a manner that it shall turn over in the air and fall on the ground with its small end pointing in the direction directly opposite to the "tosser." Tossing the caber is usually considered to be a distinctly Scottish sport, although "casting the bar," an exercise evidently similar in character, was popular in England in the 16th century but afterwards died out. The caber is the heavy trunk of a tree from 16 to 20 ft. long. It is often brought upon the field heavier than can be thrown and then cut to suit the contestants, although sometimes cabers of different sizes are kept, each contestant taking his choice. The toss is made after a run, the caber being set up perpendicularly with the heavy end up by assistants on the spot indicated by the tosser, who sets one foot against it, grasps it with both hands, and, as soon as he feels it properly balanced, gives the word to the assistants to let go their hold. He then raises the caber and gets both hands underneath the lower end. "A practised hand, having freed the caber from the ground, and got his hands underneath the end, raises it till the lower end is nearly on a level with his elbows, then advances for several yards, gradually increasing his speed till he is sometimes at a smart run before he gives the toss. Just before doing this he allows the caber to leave his shoulder, and as the heavy top end begins to fall forward, he throws the end he has in his hands upwards with all his strength, and, if successful, after the heavy end strikes the ground the small end continues its upward motion till perpendicular, when it falls forward, and the caber lies in a straight line with the tosser" (W. M. Smith). The winner is he who tosses with the best and easiest style, according to old Highland traditions, and whose caber falls straightest in a direct line from him. In America a style called the Scottish-American prevails at Caledonian games. In this the object is distance alone, the same caber being used by all contestants and the toss being measured from the tosser's foot to the spot where the small end strikes the ground. This style is repudiated in Scotland. Donald Dinnie, born in 1837 and still a champion in 1890, was the best tosser of modern times.

See W. M. Smith, *Athletics and Athletic Sports in Scotland* (Edinburgh, 1891).

CABET, ETIENNE (1788-1856), French communist, was born at Dijon in 1788, the son of a cooper. He chose the profession of advocate, without succeeding in it, but ere long became notable as the persevering apostle of republicanism and communism. He assisted in a secondary way in the revolution of 1830, and obtained the appointment of *procureur-général* in Corsica under the government of Louis Philippe; but was dismissed for his attack upon the conservatism of the government, in his *Histoire de la révolution de 1830*. Elected, notwith-

standing, to the chamber of deputies, he was prosecuted for his bitter criticism of the government, and obliged to go into exile in England in 1834, where he became an ardent disciple of Robert Owen. On the amnesty of 1839 he returned to France, and attracted some notice by the publication of a badly written and fiercely democratic history of the Revolution of 1789 (4 vols., 1840), and of a social romance, *Voyage en Icarie*, in which he set forth his peculiar views. These works met with some success among the radical working-men of Paris. Like Owen, he sought to realize his ideas in practice, and, pressed as well by his friends, he made arrangements for an experiment in communism on American soil. By negotiations in England favoured by Owen, he purchased a considerable tract of land on the Red river, Texas, and drew up an elaborate scheme for the intending colony, community of property being the distinctive principle of the society. Accordingly in 1848 an expedition of 1500 "Icarians" sailed to America; but unexpected difficulties arose and the complaints of the disenfranchised settlers soon reached Europe. Cabet, who had remained in France, had more than one judicial investigation to undergo in consequence, but was honourably acquitted. In 1849 he went out in person to America, but on his arrival, finding that the Mormons had been expelled from their city Nauvoo (q.v.), in Illinois, he transferred his settlement thither. There, with the exception of a journey to France, where he returned to defend himself successfully before the tribunals, he remained, the dictator of his little society. In 1856, however, he withdrew and died the same year at St Louis.

See COMMUNISM. Also Félix Bonnaud, *Cabet et son œuvre, appelé à tous les socialistes* (Paris, 1900); J. Prudhommeaux, *Icarie and its Founder, Etienne Cabet* (Nimes, 1907).

CABIN, a small, roughly built hut or shelter; the term is particularly applied to the thatched mud cottages of the negro slaves of the southern states of the United States of America, or of the poverty-stricken peasantry of Ireland or the crofter districts of Scotland. In a special sense it is used of the small rooms or compartments on board a vessel used for sleeping, eating or other accommodation. The word in its earlier English forms was *cabane* or *caban*, and thus seems to be an adaptation of the French *cabane*; the French have taken *cabine*, for the room on board a ship, from the English. In French and other Romanic languages, in which the word occurs, e.g. Spanish *cabana*, Portuguese *cabana*, the origin is usually found in the Medieval Latin *capanna*. Isidore of Seville (*Origines*, lib. xiv. 12) says:—*Tugurium (hut) parva casula est, quam faciunt sibi custodes vinearum, ad legimen seu quasi legurium. Hoc rustici Capannam vocant, quod unum tantum capit* (see Du Cange, *Glossarium*, s.v. *Capanna*). Others derive from Greek *κάρη*, crib, manger. Skeat considers the English word was taken from the Welsh *caban*, rather than from the French, and that the original source for all the forms was Celtic.

CABINET, a word with various applications which may be traced to two principal meanings, (1) a small private chamber, and (2) an article of furniture containing compartments formed of drawers, shelves, &c. The word is a diminutive of "cabin" and therefore properly means a small hut or shelter. This meaning is now obsolete; the *New English Dictionary* quotes from Leonard Digges's *Siraitioticos* (published with additions by his son Thomas in 1579), "the Lance Knights encamp always in the field very strongly, two or three to a Cabbonet." From the use both of the article of furniture and of a small chamber for the safe-keeping of a collection of valuable prints, pictures, medals or other objects, the word is frequently applied to such a collection or to objects fit for such safe-keeping. The name of *Cabinet du Roi* was given to the collection of prints prepared by the best artists of the 17th century by order of Louis XIV. These were intended to commemorate the chief events of his reign, and also to reproduce the paintings and sculptures and other art treasures contained in the royal palaces. It was begun in 1667 and was placed under the superintendence of Nicholas Clement (1647 or 1651-1712), the royal librarian. The collection was published in 1727. The plates are now in the Louvre. A "cabinet" edition

of a literary work is one of somewhat small size, and bound in such a way as would suit a tasteful collection. The term is applied also to a size of photograph of a larger size than the *carte de visite* but smaller than the "panel." The political use of the term is derived from the private chamber of the sovereign or head of a state in which his advisers met.

Cabinet in Furniture.—The artificer who constructs furniture is still called a "cabinet-maker," although the manufacture of cabinets, properly so called, is now a very occasional part of his work. Cabinets can be divided into a very large number of classes according to their shape, style, period and country of origin; but their usual characteristic is that they are supported upon a stand, and that they contain a series of drawers and pigeon-holes. The name is, however, now given to many pieces of furniture for the safe-keeping or exhibition of valuable objects, which really answer very little to the old conception of a cabinet. The cabinet represented an evolution brought about by the necessities of convenience, and it appealed to so many tastes and needs that it rapidly became universal in the houses of the gentle classes, and in great measure took the impress of the peoples who adopted it. It would appear to have originated in Italy, probably at the very beginning of the 16th century. In its rudimentary form it was little more than an oblong box, with or without feet, small enough to stand upon a table or chair, filled with drawers and closed with doors. In this early form its restricted dimensions permitted of its use only for the safeguard of jewels, precious stones and sometimes money. One of the earliest cabinets of which we have mention belonged to Francis I. of France, and is described as covered with gilt leather, tooled with mauresque work. As the Renaissance became general these early forms gave place to larger, more elaborate and more architectural efforts, until the cabinet became one of the most sumptuous of household adornments. It was natural that the countries which were earliest and most deeply touched by the Renaissance should excel in the designing of these noble and costly pieces of furniture. The cabinets of Italy, France and the Netherlands were especially rich and monumental. Those of Italy and Flanders are often of great magnificence and of real artistic skill, though like all other furniture their style was often grievously debased, and their details incongruous and bizarre. Flanders and Burgundy were, indeed, their lands of adoption, and Antwerp added to its renown as a metropolis of art by developing consummate skill in their manufacture and adornment. The cost and importance of the finer types have ensured the preservation of innumerable examples of all but the very earliest periods; and the student never ceases to be impressed by the extraordinary variety of the work of the 16th and 17th centuries, and very often of the 18th also. The basis of the cabinet has always been wood, carved, polished or inlaid; but lavish use has been made of ivory, tortoise-shell, and those cut and polished precious stones which the Italians call *pietra dura*. In the great Flemish period of the 17th century the doors and drawers of cabinets were often painted with classical or mythological scenes. Many French and Florentine cabinets were also painted. In many classes the drawers and pigeon-holes are enclosed by folding doors, carved or inlaid, and often painted on the inner sides. Perhaps the most favourite type during a great part of the 16th and 17th centuries—a type which grew so common that it became cosmopolitan—was characterized by a conceit which acquired astonishing popularity. When the folding doors are opened there is disclosed in the centre of the cabinet a tiny but palatial interior. Floored with alternate squares of ebony and ivory to imitate a black and white marble pavement, adorned with Corinthian columns or pilasters, and surrounded by mirrors, the effect, if occasionally affected and artificial, is quite as often exquisite. Although cabinets have been produced in England in considerable variety, and sometimes of very elegant and graceful form, the foreign makers on the whole produced the most elaborate and monumental examples. As we have said, Italy and the Netherlands acquired especial distinction in this kind of work. In France, which has always enjoyed a peculiar genius for assimilating modes in furniture, Flemish cabinets were so greatly in demand that Henry IV. determined to establish the industry in his own

dominions. He therefore sent French workmen to the Low Countries to acquire the art of making cabinets, and especially those which were largely constructed of ebony and ivory. Among these workmen were Jean Macé and Pierre Boulle, a member of a family which was destined to acquire something approaching immortality. Many of the Flemish cabinets so called, which were in such high favour in France and also in England, were really *armoires* consisting of two bodies superimposed, whereas the cabinet proper does not reach to the floor. Pillared and fluted, with panelled sides, and front elaborately carved with masks and human figures, these pieces which were most often in oak were exceedingly harmonious and balanced. Long before this, however, France had its own school of makers of cabinets, and some of their carved work was of the most admirable character. At a somewhat later date André Charles Boulle made many pieces to which the name of cabinet has been more or less loosely given. They were usually of massive proportions and of extreme elaboration of marquetry. The North Italian cabinets, and especially those which were made or influenced by the Florentine school, were grandiose and often gloomy. Conceived on a palatial scale, painted or carved, or incrustated with marble and *pietra dura*, they were intended for the adornment of galleries and lofty bare apartments where they were not felt to be overpowering. These North Italian cabinets were often covered with intarsia or marquetry, which by its subdued gaiety retrieved somewhat their heavy stateliness of form. It is, however, often difficult to ascribe a particular fashion of shape or of workmanship to a given country, since the interchange of ideas and the imports of actual pieces caused a rapid assimilation which destroyed frontiers. The close connexion of centuries between Spain and the Netherlands, for instance, led to the production north and south of work that was not definitely characteristic of either. Spain, however, was more closely influenced than the Low Countries, and contains to this day numbers of cabinets which are not easily to be distinguished from the characteristic ebony, ivory and tortoise-shell work of the craftsmen whose skill was so rapidly acquired by the emissaries of Henry IV. The cabinets of southern Germany were much influenced by the models of northern Italy, but retained to a late date some of the characteristics of domestic Gothic work such as elaborately fashioned wrought-iron handles and polished steel hinges. Often, indeed, 17th-century South Germany work is a curious blend of Flemish and Italian ideas executed in oak and Hungarian ash. Such work, however interesting, necessarily lacks simplicity and repose. A curious little detail of Flemish and Italian, and sometimes of French later 17th-century cabinets, is that the interiors of the drawers are often lined with stamped gold or silver paper, or marbled ones somewhat similar to the "end papers" of old books. The great English cabinet-makers of the 18th century were very various in their cabinets, which did not always answer strictly to their name; but as a rule they will not bear comparison with the native work of the preceding century, which was most commonly executed in richly marked walnut, frequently enriched with excellent marquetry of woods. Mahogany was the dominating timber in English furniture from the accession of George II. almost to the time of the Napoleonic wars; but many cabinets were made in lacquer or in the bright-hued foreign woods which did so much to give lightness and grace to the British style. The glass-fronted cabinet for China or glass was in high favour in the Georgian period, and for pieces of that type, for which massiveness would have been inappropriate, satin and tulip woods, and other timbers with a handsome grain taking a high polish were much used. (J. P.-B.)

The Political Cabinet.—Among English political institutions, the "Cabinet" is a conventional but not a legal term employed to describe those members of the privy council who fill the highest executive offices in the state, and by their concerted policy direct the government, and are responsible for all the acts of the crown. The cabinet now always includes the persons filling the following offices, who are therefore called "cabinet ministers," viz.—the first lord of the treasury, the lord chancellor of England, the lord president of the council, the lord privy seal, the five secretaries of state, the chancellor of the exchequer

and the first lord of the admiralty. The chancellor of the duchy of Lancaster, the postmaster-general, the first commissioner of works, the president of the board of trade, the chief secretary for Ireland, the lord chancellor of Ireland, the president of the local government board, the president of the board of agriculture, and the president of the board of education, are usually members of the cabinet, but not necessarily so. A modern cabinet contains from sixteen to twenty members. It used to be said that a large cabinet is an evil; and the increase in its numbers in recent years has often been criticised. But the modern widening of the franchise has tended to give the cabinet the character of an executive committee for the party in power, no less than that of the prime-minister's consultative committee, and to make such a committee representative it is necessary to include the holders of all the more important offices in the administration, who are generally selected as the influential politicians of the party rather than for special aptitude in the work of the departments.

The word "cabinet," or "cabinet council," was originally employed as a term of reproach. Thus Lord Bacon says, in his essay *Of Counsel* (xx.), "The doctrine of Italy and practice of France, in some kings' times, hath introduced cabinet councils—a remedy worse than the disease"; and, again, "As for cabinet councils, it may be their motto *Plenus risuorum sum.*" Lord Clarendon—after stating that, in 1640, when the great Council of Peers was convened by the king at York, the burden of affairs rested principally on Laud, Stafford and Cottington, with five or six others added to them on account of their official position and ability—adds, "These persons made up the committee of state, which was reproachfully after called the *Junctio*, and enviously then in court the *Cabinet Council*." And in the Second Remonstrance in January 1642, parliament complained "of the managing of the great affairs of the realm in *Cabinet Councils* by men unknown and not publicly trusted." But this use of the term, though historically curious, has in truth nothing in common with the modern application of it. It meant, at that time, the employment of a select body of favourites by the king, who were supposed to possess a larger share of his confidence than the privy council at large. Under the Tudors, at least from the later years of Henry VIII. and under the Stuarts, the privy council was the council of state or government. During the Commonwealth it assumed that name.

The Cabinet Council, properly so called, dates from the reign of William III. and from the year 1693, for it was not until some years after the Revolution that the king discovered and adopted the two fundamental principles of a constitutional executive government, namely, that a ministry should consist of statesmen holding the same political principles and identified with each other; and, secondly, that the ministry should stand upon a parliamentary basis, that is, that it must command and retain the majority of votes in the legislature. It was long before these principles were thoroughly worked out and understood, and the perfection to which they have been brought in modern times is the result of time, experience and in part of accident. But the result is that the cabinet council for the time being is the government of Great Britain; that all the powers vested in the sovereign (with one or two exceptions) are practically exercised by the members of this body; that all the members of the cabinet are jointly and severally responsible for all its measures, for if differences of opinion arise their existence is unknown as long as the cabinet lasts—when publicly manifested the cabinet is at an end; and lastly, that the cabinet, being responsible to the sovereign for the conduct of executive business, is also collectively responsible to parliament both for its executive conduct and for its legislative measures, the same men being as members of the cabinet the servants of the crown, and as members of parliament and leaders of the majority responsible to those who support them by their votes and may challenge in debate every one of their actions. In this latter sense the cabinet has sometimes been described as a standing committee of both Houses of Parliament.

One of the consequences of the close connexion of the cabinet with the legislature is that it is desirable to divide the strength

of the ministry between the two Houses of Parliament. Pitt's cabinet of 1783 consisted of himself in the House of Commons and seven peers. But so aristocratic a government would now be impracticable. In Gladstone's cabinet of 1868, eight, and afterwards nine, ministers were in the House of Commons and six in the House of Lords. Great efforts were made to strengthen the ministerial bench in the Commons, and a new principle was introduced, that the representatives of what are called the spending departments—that is, the secretary of state for war and the first lord of the admiralty—should, if possible, be members of the House which votes the supplies. Disraeli followed this precedent but it has since been disregarded. In Sir H. Campbell-Bannerman's cabinet formed in 1905, six ministers were in the House of Lords and thirteen in the House of Commons.

Cabinets are usually convoked by a summons addressed to "His Majesty's confidential servants" by the prime minister; and the ordinary place of meeting is either at the official residence of the first lord of the treasury in Downing Street or at the foreign office, but they may be held anywhere. No secretary or other officer is present at the deliberations of this council. No official record is kept of its proceedings, and it is even considered a breach of ministerial confidence to keep a private record of what passed in the cabinet, inasmuch as such memoranda may fall into other hands. But on some important occasions, as is known from the *Memoirs of Lord Sidmouth*, the *Correspondence of Earl Grey with King William IV.*, and from Sir Robert Peel's *Memoirs*, published by permission of Queen Victoria, cabinet minutes are drawn up and submitted to the sovereign, as the most formal manner in which the advice of the ministry can be tendered to the crown and placed upon record. (See also Sir Algernon West's *Recollections*, 1899.) More commonly, it is the duty of the prime minister to lay the collective opinion of his colleagues before the sovereign, and take his pleasure on public measures and appointments. The sovereign never presides at a cabinet; and at the meetings of the privy council, where the sovereign does preside, the business is purely formal. It has been laid down by some writers as a principle of the British constitution that the sovereign is never present at a discussion between the advisers of the crown; and this is, no doubt, an established fact and practice. But like many other political usages of Great Britain it originated in a happy accident.

King William and Queen Anne always presided at weekly cabinet councils. But when the Hanoverian princes ascended the throne, they knew no English, and were barely able to converse at all with their ministers; for George I. or George II. to take part in, or even to listen to, a debate in council was impossible. When George III. mounted the throne the practice of the independent deliberations of the cabinet was well established, and it has never been departed from.

Upon the resignation or dissolution of a ministry, the sovereign exercises the undoubted prerogative of selecting the person who may be thought by him most fit to form a new cabinet. In several instances the statesmen selected by the crown have found themselves unable to accomplish the task confided to them. But in more favourable cases the minister chosen for this supreme office by the crown has the power of distributing all the political offices of the government as may seem best to himself, subject only to the ultimate approval of the sovereign. The prime minister is therefore in reality the author and constructor of the cabinet; he holds it together; and in the event of his retirement, from whatever cause, the cabinet is really dissolved, even though its members are again united under another head.

AUTHORITIES.—Sir W. Anson, *Law and Custom of the Constitution* (1896); W. Bagehot, *The English Constitution*; M. T. Blauvelt, *The Development of Cabinet Government in England* (New York, 1902); E. Boutmy, *The English Constitution* (trans. I. M. Eaden, 1891); A. Lawrence Lowell, *The Government of England* (1908), part 1.; A. V. Dicey, *Law of the Constitution* (1902); Sir T. Erskine May, *Constitutional History of England* (1863-1865); H. Hallam, *Constitutional History of England*; W. E. Hearn, *The Government of England* (1867); S. Low, *The Governance of England* (1904); W. Stubbs, *Constitutional History of England*; Hannis Taylor, *Origin and Growth of the English Constitution* (Boston, 1889-1900);

A. Todd, *Parliamentary Government in England (1867-1869)*; much valuable information will also be found in such works as W. E. Gladstone's *Gleanings*; the third earl of Malmesbury's *Memoirs of an ex-Minister (1884-1888)*; Greville's *Memoirs*; Sir A. West's *Recollections, 1832-1886 (1889)*, &c.

CABINET NOIR, the name given in France to the office where the letters of suspected persons were opened and read by public officials before being forwarded to their destination. This practice had been in vogue since the establishment of posts, and was frequently used by the ministers of Louis XIII. and Louis XIV.; but it was not until the reign of Louis XV. that a separate office for this purpose was created. This was called the *cabinet des secret des postes*, or more popularly the *cabinet noir*. Although declaimed against at the time of the Revolution, it was used both by the revolutionary leaders and by Napoleon. The *cabinet noir* has now disappeared, but the right to open letters in cases of emergency appears still to be retained by the French government; and a similar right is occasionally exercised in England under the direction of a secretary of state, and, indeed, in all civilized countries. In England this power was frequently employed during the 18th century and was confirmed by the Post Office Act of 1837; its most notorious use being, perhaps, the opening of Mazzini's letters in 1844.

CABLE, GEORGE WASHINGTON (1844-) American author, was born in New Orleans, Louisiana, on the 12th of October 1844. At the age of fourteen he entered a mercantile establishment as a clerk; joined the Confederate army (4th Mississippi Cavalry) at the age of nineteen; at the close of the war engaged in civil engineering, and in newspaper work in New Orleans; and first became known in literature by sketches and stories of old French-American life in that city. These were first published in *Scribner's Monthly*, and were collected in book form in 1879, under the title of *Old Creole Days*. The characteristics of the series—of which the novelette *Madame Delphine (1881)* is virtually a part—are neatness of touch, sympathetic accuracy of description of people and places, and a constant combination of gentle pathos with quiet humour. These shorter tales were followed by the novels *The Grandissimes (1880)*, *Dr Sevier (1883)* and *Bonaventure (1888)*, of which the first dealt with Creole life in Louisiana a hundred years ago, while the second was related to the period of the Civil War of 1861-65. *Dr Sevier*, on the whole, is to be accounted Cable's masterpiece, its character of Narcisse combining nearly all the qualities which have given him his place in American literature as an artist and a social chronicler. In this, as in nearly all of his stories, he makes much use of the soft French-English dialect of Louisiana. He does not confine himself to New Orleans, laying many of his scenes, as in the short story *Belles Demoiselles Plantation*, in the marshy lowlands towards the mouth of the Mississippi. Cable was the leader in the noteworthy literary movement which has influenced nearly all southern writers since the war of 1861—a movement of which the chief importance lay in the determination to portray local scenes, characters and historical episodes with accuracy instead of merely imaginative romanticism, and to interest readers by fidelity and sympathy in the portrayal of things well known to the authors. Other writings by Cable have dealt with various problems of race and politics in the southern states during and after the "reconstruction period" following the Civil War; while in *The Creoles of Louisiana (1884)* he presented a history of that folk from the time of its appearance as a social and military factor. His dispassionate treatment of his theme in this volume and its predecessors gave increasing offence to sensitive Creoles and their sympathizers, and in 1886 Cable removed to Northampton, Massachusetts. At one time he edited a magazine in Northampton, and afterwards conducted the monthly *Current Literature*, published in New York. His *Collected Works* were published in a uniform issue in 5 vols. (New York, 1898). Among his later volumes are *The Cavalier (1901)*, *Bylow Hill (1902)*, and *Kincaid's Battery (1908)*.

CABLE (from Late Lat. *capulum*, a halter, from *capere*, to take hold of), a large rope or chain, used generally with ships, but often employed for other purposes; the term "cable" is also

used by analogy in minor varieties of similar engineering or other attachments, and in the case of "electric cables" for the submarine wires (see TELEGRAPH) by which telegraphic messages are transmitted.¹

The cable by which a ship rides at her anchor is now made of iron; prior to 1811 only hempen cables were supplied to ships of the British navy, a first-rate's complement on the East Indian station being eleven; the largest was 25 in. (equal to 2½ in. iron cable) and weighed 6 tons. In 1811, iron cables were supplied to stationary ships; their superiority over hempen ones was manifest, as they were less liable to foul or to be cut by rocks, or to be injured by enemy's shot. Iron cables are also handier and cleaner, an offensive odour being exhaled from dirty hempen cables, when unbent and stowed inboard. The first patent for iron cables was by Phillip White in 1634; twisted links were suggested in 1813 by Captain Brown (who afterwards, in conjunction with Brown, Lenox & Co., planned the Brighton chain pier in 1823); and studs were introduced in 1816. Hempen cables are not now supplied to ships, having been superseded by steel wire hawsers. The length of a hempen cable is 101 fathoms, and a cable's length, as a standard of measurement, usually placed on charts, is assumed to be 100 fathoms or 600 ft. The sizes, number and lengths of cables supplied to ships of the British navy are given in the official publication, the *Ship's Establishment*; cables for merchant ships are regulated by Lloyd's, and are tested according to the Anchors and Chain Cables Act 1899.

In manufacturing chain cables, the bars are cut to the required length of link, at an angle for forming the welds and, after heating, are bent by machinery to the form of a link and welded by smiths, each link being inserted in the previous one before welding. Cables of less than 1½ in. are welded at the crown, there not being sufficient room for a side weld; experience has shown that the latter method is preferable and it is employed in making larger sized cables. In 1898 steel studs were introduced instead of cast iron ones, the latter having a tendency to work loose, but the practice is not universal. After testing, the licensed tester must place on every five fathoms of cable a distinctive mark which also indicates the testing establishments; the stamp or die employed must be approved by the Board of Trade. The iron used in the construction, also the testing, of mooring chairs and cables for the London Trinity House Corporation are subject to more stringent regulations.

Cables for the British navy and mercantile marine are supplied in 12½ fathom and 15 fathom lengths respectively, connected together by "joining shackles," D (fig. 1). Each length is

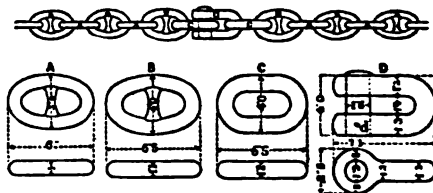

FIG. 1.—Stud-link Chain.

"marked" by pieces of iron wire being twisted round the studs of the links; the wire is placed on the first studs on each side of the first shackle, on the second studs on each side of the second shackle, and so on; thus the number of lengths of cable out is clearly indicated. For instance, if the wire is on the sixth

¹ The word "cable" is a various reading for "camel" in the Biblical phrase, "it is easier for a camel to go through the eye of a needle" of Matt. xix. 24, Mark x. 25, and Luke xviii. 25, mentioned as early as Cyril of Alexandria (5th cent.); and it was adopted by Sir John Cheke and other 16th century and later English writers. The reading *καμήλο* for *καμήλο* is found in several late cursive MSS. Cheyne, in the *Ency. Biblica*, ascribes it to a non-Semitic scribe, and regards *καμήλο* as correct. (See under CAMEL.)

studs on each side of the shackle, it indicates that six lengths or 75 fathoms of cable are out. In joining the lengths together, the round end of the shackle is placed towards the anchor. The end links of each length (C.C.) are made without studs, in order to take the shackle; but as studs increase the strength of a link, in a studless or open link the iron is of greater diameter. The next links (B.B.) have to be enlarged, in order to take the increased size of the links C.C. In the joining shackle (D), the pin is oval, its greater diameter being in the direction of the strain. The pin of a shackle, which attaches the cable to the anchor (called an "anchor shackle," to distinguish it from a joining shackle) projects and is secured by a forelock; but since any projection in a joining shackle would be liable to be injured when the cable is running out or when passing around a capstan, the pins are made as shown at D, and are secured by a small pin d. This small pin is kept from coming out by being made a little short, and lead pellets are driven in at either end to fill up the holes in the shackle, which are made with a groove, so that as the pellets are driven in they expand or dovetail, keeping the small pin in its place.¹

The cables are stowed in chain lockers, the inboard ends being secured by a "slip" (in the mercantile marine the cable is often shackled or lashed to the kelson); the slip prevents the cable's inner end from passing overboard, and also enables the cable to be "slipped," or let go, in case of necessity. In the British navy, swivel pieces are fitted in the first and last lengths of cable, to avoid and, if required, to take out turns in a cable, caused by a ship swinging round when at anchor. With a ship moored with two anchors, the cables are secured to a mooring swivel (fig. 2), which prevents a "foul hawse," i.e. the cables being entwined round each other. When mooring, unmooring, and as may be necessary, cables are temporarily secured by "slips"

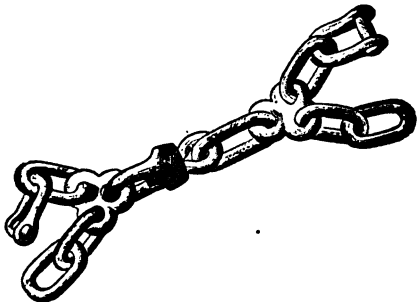

FIG. 2.—Mooring Swivel.

shackled to eye or ring bolts in the deck (see ANCHOR). The cable is hove up by either a capstan or windlass (see CAPSTAN) actuated by steam, electricity or manual power. Ships in the British navy usually ride by the compressor, the cable holder being used for checking the cable running out. When a ship has been given the necessary cable, the cable holder is eased up and the compressor "bowed to"; in a heavy sea, a turn, or if necessary two turns, are taken round the "bits," a strong iron structure placed between the hawse and navel ("deck") pipes. A single turn of cable is often taken round the bits when anchoring in deep water. Small vessels of the mercantile marine ride by turns around the windlass; in larger or more modern vessels fitted with a steam windlass, the friction brakes take the strain, aided when required by the bits, compressor or controller in bad weather. (J. W. D.)

CABLE MOULDING, in architecture, the term given to a convex moulding carved in imitation of a rope or cord, and used to decorate the mouldings of the Romanesque style in England,

¹ The dimensions marked in the figure are those for 1-in. chains, and signify so many diameters of the iron of the common links; thus forming a scale for all sizes.

France and Spain. The word "cabling" by itself indicates a convex circular moulding sunk in the concave fluting of a classic column, and rising about one-third of the height of the shaft.

CABOCHE, SIMON. Simon Lecoustellier, called "Caboché," a skinner of the Paris Boucherie, played an important part in the Parisian riots of 1413. He had relations with John the Fearless, duke of Burgundy, since 1411, and was prominent in the seditious disturbances which broke out in April and May, following on the *États* of February 1413. In April he stirred the people to the point of revolt, and was among the first to enter the hôtel of the dauphin. When the butchers had made themselves masters of Paris, Caboché became bailiff (*huissier d'armes*) and warden of the bridge of Charenton. Upon the publication of the great ordinance of May 26th, he used all his efforts to prevent conciliation between the Burgundians and the Armagnacs. After the fall of the *Cabochien* party on the 4th of August he fled to Burgundy in order to escape from royal justice. Doubtless he returned to Paris in 1418 with the Burgundians.

See Colville, *Les Cabochiens et l'ordonnance de 1413* (Paris, 1888).

CABOT, GEORGE (1751-1823), American political leader, was born in Salem, Massachusetts, on the 16th of December 1751. He studied at Harvard from 1766 to 1768, when he went to sea as a cabin boy. He gradually became a ship-owner and a successful merchant, retiring from business in 1794. Throughout his life he was much interested in politics, and though his temperamental indolence and his aversion for public life often prevented his accepting office, he exercised, as a contributor to the press and through his friendships, a powerful political influence, especially in New England. He was a member of the Massachusetts Constitutional Convention of 1779-1780, of the state senate in 1782-1783, of the convention which in 1788 ratified for Massachusetts the Federal Constitution, and from 1791 to 1796 of the United States Senate, in which, besides serving on various important committees, he became recognized as an authority on economic and commercial matters. Among the bills introduced by him in the Senate was the Fugitive Slave Act of 1793. Upon the establishment of the navy department in 1798, he was appointed and confirmed as its secretary, but he never performed the duties of the office, and was soon replaced by Benjamin Stoddert (1751-1813), actually though not nominally the first secretary of the department. In 1814-1815 Cabot was the president of the Hartford Convention, and as such was then and afterwards acrimoniously attacked by the Republicans throughout the country. He died in Boston on the 18th of April 1823. In politics he was a staunch Federalist, and with Fisher Ames, Timothy Pickering and Theophilus Parsons (all of whom lived in Essex county, Massachusetts) was classed as a member of the "Essex Junto,"—a wing of the party and not a formal organization. A fervent advocate of a strong centralized government, he did much to secure the ratification by Massachusetts of the Federal Constitution, and after the overturn of the Federalist by the Republican party, he wrote (1804): "We are democratic altogether, and I hold democracy in its natural operation to be a government of the worst."

See Henry Cabot Lodge's *Life and Letters of George Cabot* (Boston, 1877).

CABOT, JOHN [GIOVANNI CABOTO] (1450-1498), Italian navigator and discoverer of North America, was born in Genoa, but in 1461 went to live in Venice, of which he became a naturalized citizen in 1476. During one of his trading voyages to the eastern Mediterranean, Cabot paid a visit to Mecca, then the greatest mart in the world for the exchange of the goods of the East for those of the West. On inquiring whence came the spices, perfumes, silks and precious stones bartered there in great quantities, Cabot learned that they were brought by caravan from the north-eastern parts of farther Asia. Being versed in a knowledge of the sphere, it occurred to him that it would be shorter and quicker to bring these goods to Europe straight across the western ocean. First of all, however, a way would have to be found across this ocean from Europe to Asia. Full of this idea, Cabot, about the year 1484, removed with his family to London. His plans were in course of time made known to

the leading merchants of Bristol, from which port an extensive trade was carried on already with Iceland. It was decided that an attempt should be made to reach the island of Brazil or that of the Seven Cities, placed on medieval maps to the west of Ireland, and that these should form the first halting-places on the route to Asia by the west.

To find these islands vessels were despatched from Bristol during several years, but all in vain. No land of any sort could be seen. Affairs were in this state when in the summer of 1493 news reached England that another Genoese, Christopher Columbus, had set sail westward from Spain and had reached the Indies. Cabot and his friends at once determined to forgo further search for the islands and to push straight on to Asia. With this end in view application was made to the king for formal letters patent, which were not issued until March 5, 1496. By these Henry VII. granted to his "well-beloved John Cabot, citizen of Venice, to Lewis, Sebastian and Santius, sons of the said John, full and free authority, leave and power upon their own proper costs and charges, to seek out, discover and finde whatsoever isles, countries, regions or provinces of the heathen and infidels, which before this time have been unknown to all Christians." Merchandise from the countries visited was to be entered at Bristol free of duty, but one-fifth of the net gains was to go to the king.

Armed with these powers Cabot set sail from Bristol on Tuesday the 2nd of May 1497, on board a ship called the "Mathew" manned by eighteen men. Rounding Ireland they headed first north and then west. During several weeks they were forced by variable winds to keep an irregular course, although steadily towards the west. At length, after being fifty-two days at sea, at five o'clock on Saturday morning, June 24, they reached the northern extremity of Cape Breton Island. The royal banner was unfurled, and in solemn form Cabot took possession of the country in the name of King Henry VII. The soil being found fertile and the climate temperate, Cabot was convinced he had reached the north-eastern coast of Asia, whence came the silks and precious stones he had seen at Mecca. Cape North was named Cape Discovery, and as the day was the festival of St John the Baptist, St Paul Island, which lies opposite, was called the island of St John.

Having taken on board wood and water, preparations were made to return home as quickly as possible. Sailing north, Cabot named Cape Ray, St George's Cape, and christened St Pierre and Miquelon, which then with Langley formed three separate islands, the Trinity group. Hereabout they met great schools of cod, quantities of which were caught by the sailors merely by lowering baskets into the water. Cape Race, the last land seen, was named England's Cape.

The return voyage was made without difficulty, since the prevailing winds in the North Atlantic are westerly, and on Sunday, the 6th of August, the "Mathew" dropped anchor once more in Bristol harbour. Cabot hastened to Court, and on Thursday the 10th of August received from the king £10 for having "found the new isle." Cabot reported that 700 leagues beyond Ireland he had reached the country of the Grand Khan. Although both silk and brazil-wood could be obtained there, he intended on his next voyage to follow the coast southward as far as Cipangu or Japan, then placed near the equator. Once Cipangu had been reached London would become a greater centre for spices than Alexandria. Henry VII. was delighted, and besides granting Cabot a pension of £20 promised him in the spring a fleet of ten ships with which to sail to Cipangu.

On the 3rd of February 1498, fresh letters patent were issued, whereby Cabot was empowered to "take at his pleasure VI. englishe shippes and theym convey and lede to the londe and isles of late founde by the seid John." Henry VII. himself also advanced considerable sums of money to various members of the expedition. As success seemed assured, it was expected the returns would be high.

In the spring Cabot visited Lisbon and Seville, to secure the services of men who had sailed along the African coast with

¹ Nothing further is known of Lewis and Santius.

Cam and Diaz or to the Indies with Columbus. At Lisbon he met a certain João Fernandes, called Llavrador, who about the year 1492 appears to have made his way from Iceland to Greenland. Cabot, on learning from Fernandes that part of Asia, as they supposed Greenland to be, lay so near Iceland, determined to return by way of this country. On reaching Bristol he laid his plans accordingly. Early in May the expedition, which consisted of two ships and 300 men, left Bristol. Several vessels in the habit of trading to Iceland accompanied them. Off Ireland a storm forced one of these to return, but the rest of the fleet proceeded on its way along the parallel of 58°. Each day the ships were carried northward by the Gulf Stream. Early in June Cabot reached the east coast of Greenland, and as Fernandes was the first who had told him of this country he named it the Labrador's Land.

In the hope of finding a passage Cabot proceeded northward along the coast. As he advanced, the cold became more intense and the icebergs thicker and larger. It was also noticed that the land trended eastward. As a result on the 11th of June in latitude 67° 30' the crews mutinied and refused to proceed farther in that direction. Cabot had no alternative but to put his ships about and look for a passage towards the south. Rounding Cape Farewell he explored the southern coast of Greenland and then made his way a certain distance up the west coast. Here again his progress was checked by icebergs, whereupon a course was set towards the west. Crossing Davis Strait Cabot reached our modern Baffin Land in 66°. Judging this to be the Asiatic mainland, he set off southward in search of Cipangu. South of Hudson Strait a little bartering was done with the Indians, but these could offer nothing in exchange but furs. Our strait of Belle Isle was mistaken for an ordinary bay, and Newfoundland was regarded by Cabot as the main shore itself. Rounding Cape Race he visited once more the region explored in the previous summer, and then proceeded to follow the coast of our Nova Scotia and New England in search of Cipangu. He made his way as far south as the thirty-eighth parallel, when the absence of all signs of eastern civilization and the low state of his stores forced him to abandon all hope of reaching Cipangu on this voyage. Accordingly the ships were put about and a course set for England, where they arrived safely late in the autumn of 1498. Not long after his return John Cabot died.

His son, SEBASTIAN CABOT (1476-1557),² is not independently heard of until May 1512, when he was paid twenty shillings "for making a carte of Gascoigne and Guyenne," whither he accompanied the English army sent that year by Henry VIII. to aid his father-in-law Ferdinand of Aragon against the French. Since Ferdinand and his daughter Joanna were contemplating the dispatch of an expedition from Santander to explore Newfoundland, Sebastian was questioned about this coast by the king's councillors. As a result Ferdinand summoned him in September 1512 to Logroño, and on the 30th of October appointed him a captain in the navy at a salary of 50,000 maravedis a year. A letter was also written to the Spanish ambassador in England to help Cabot and his family to return to Spain, with the result that in March 1514 he was again back at Court discussing with Ferdinand the proposed expedition to Newfoundland. Preparations were made for him to set sail in March 1516; but the death of the king in January of that year put an end to the undertaking. His services were retained by Charles V., and on the 5th of February 1518 Cabot was named Pilot Major and official examiner of pilots.

In the winter of 1520-1521 Sebastian Cabot returned to England

² The dates are conjectural. Richard Eden (*Decades of the New World*, i. 255) says Sebastian told him that when four years old he was taken by his father to Venice, and returned to England "after certeyne yeares: wherby he was thought to have bin born in Venice"; Stow (*Annals*, under year 1498) styles "Sebastian Caboto, a Genoas sonne, borne in Bristow." Galvano and Herrera also give England the honour of his nativity. See also Nicholls, *Remarkable Life of Sebastian Cabot* (1869), a eulogistic account, with which may be contrasted Henry Harrisse's *John Cabot and his son Sebastian* (1896).

and while there was offered by Wolsey the command of five vessels which Henry VIII. intended to despatch to Newfoundland. Being reproached by a fellow Venetian with having done nothing for his own country, Cabot refused, and on reaching Spain entered into secret negotiations with the Council of Ten at Venice. It was agreed that as soon as an opportunity offered Cabot should come to Venice and lay his plans before the Signiory. The conference of Badajoz took up his time in 1524, and on the 4th of March 1525 he was appointed commander of an expedition fitted out at Seville "to discover the Moluccas, Tarsis, Ophir, Cipango and Cathay."

The three vessels set sail in April, and by June were off the coast of Brazil and on their way to the Straits of Magellan. Near the La Plata river Cabot found three Spaniards who had formed part of De Solis's expedition of 1515. These men gave such glowing accounts of the riches of the country watered by this river that Cabot was at length induced, partly by their descriptions and in part by the casting away of his flag-ship, to forgo the search for Tarsis and Ophir and to enter the La Plata, which was reached in February 1527. All the way up the Parana Cabot found the Indians friendly, but those on the Paraguay proved so hostile that the attempt to reach the mountains, where the gold and silver were procured, had to be given up. On reaching Seville in August 1530, Cabot was condemned to four years' banishment to Oran in Africa, but in June 1533 he was once more reinstated. In his former post of Pilot Major, which he continued to fill until he again removed to England.

As early as 1538 Cabot tried to obtain employment under Henry VIII., and it is possible he was the Sevillian pilot who was brought to London by the king in 1541. Soon after the accession of Edward VI., however, his friends induced the Privy Council to advance money for his removal to England, and on the 5th of January 1549 the king granted him a pension of £166, 13s. 4d. On Charles V. objecting to this proceeding, the Privy Council, on the 21st of April 1550, made answer that since "Cabot of himself refused to go either into Spayne or to the emperour, no reason or equite wolde that he shulde be forced or compelled to go against his will." A fresh application to Queen Mary on the 9th of September 1553 likewise proved of no avail.

On the 26th of June 1550 Cabot received £300 "by waile of the kinges Majesties reward," but it is not clear whether this was for his services in putting down the privileges of the German Merchants of the Steelyard or for founding the company of Merchant Adventurers incorporated on the 18th of December 1551. Of this company Cabot was made governor for life. Three ships were sent out in May 1553 to search for a passage to the East by the north-east. Two of the vessels were caught in the ice near Arzina and the crews frozen to death. Chancellor's vessel alone reached the White Sea, whence her captain made his way overland to Moscow. He returned to England in the summer of 1554 and was the means of opening up a very considerable trade with Russia. Vessels were again despatched to Russia in 1555 and 1556. On the departure of the "Searchthrift" in May 1556, "the good old gentleman Master Cabot gave to the poor most liberal alms, wishing them to pray for the good fortune and prosperous success of the 'Searchthrift'; and then, at the sign of the Christopher, he and his friends banqueted and made them that were in the company good cheer; and for very joy that he had to see the towardness of our intended discovery, he entered into the dance himself among the rest of the young and lusty company." On the arrival of King Philip II. in England Cabot's pension was stopped on the 26th of May 1557, but three days later Mary had it renewed. The date of Cabot's death has not been definitely discovered. It is supposed that he died within the year.

See G. P. Winship, *Cabot Bibliography, with an Introductory Essay on the Careers of the Cabots* (London, 1900); and H. P. Biggar, "The Voyages of the Cabots to North America and Greenland," in *Revue Hispanique*, tome x. pp. 485-593 (Paris, 1903). (H. P. B.)

CABOTAGE, the French term for coasting-trade, a coast-pilotage. It is probably derived from *cabot*, a small boat, with which the name Cabot may be connected; the conjecture that

the word comes from *cabro*, the Spanish for cape, and means "sailing from cape to cape," has little foundation.

CABRA, a town of southern Spain, in the province of Cordova; 28 m. S.E. by S. of Cordova, on the Jaen-Málaga railway. Pop. (1900) 13,127. Cabra is built in a fertile valley between the Sierra de Cabra and the Sierra de Montilla, which together form the watershed between the rivers Cabra and Guadajoz. The town was for several centuries an episcopal see. Its chief buildings are the cathedral, originally a mosque, and the ruined castle, which is the chief among many interesting relics of Moorish rule. The neighbouring fields of clay afford material for the manufacture of bricks and pottery; coarse cloth is woven in the town; and there is a considerable trade in farm produce. Cabra is the Roman *Baebro* or *Aegabro*. It was delivered from the Moors by Ferdinand III. of Castile in 1240, and entrusted to the Order of Calatrava; in 1331 it was recaptured by the Moorish king of Granada; but in the following century it was finally reunited to Christian Spain.

CABRERA, RAMON (1806-1877), Carlist general, was born at Tortosa, province of Tarragona, Spain, on the 27th of December 1806. As his family had in their gift two chaplaincies, young Cabrera was sent to the seminary of Tortosa, where he made himself conspicuous as an unruly pupil, ever mixed up in disturbances and careless in his studies. After he had taken minor orders, the bishop refused to ordain him as a priest, telling him that the Church was not his vocation, and that everything in him showed that he ought to be a soldier. Cabrera followed this advice and took part in Carlist conspiracies on the death of Ferdinand VII. The authorities exiled him and he absconded to Morella to join the forces of the pretender Don Carlos. In a very short time he rose by sheer daring, fanaticism and ferocity to the front rank among the Carlist chiefs who led the bands of Don Carlos in Catalonia, Aragon and Valencia. As a raider he was often successful, and he was many times wounded in the brilliant fights in which he again and again defeated the generals of Queen Isabella. He sullied his victories by acts of cruelty, shooting prisoners of war whose lives he had promised to spare and not respecting the lives and property of non-combatants. The queen's generals seized his mother as a hostage, whereupon Cabrera shot several mayors and officers. General Noguera unfortunately caused the mother of Cabrera to be shot, and the Carlist leader then started upon a policy of reprisals so merciless that the people nicknamed him "The Tiger of the Maetzragro." It will suffice to say that he shot 1110 prisoners of war, 100 officers and many civilians, including the wives of four leading Isabellinos, to avenge his mother. When Marshal Espartero induced the Carlists of the north-western provinces, with Maroto at their head, to submit in accordance with the Convention of Vergara, which secured the recognition of the rank and titles of 1000 Carlist officers, Cabrera held out in Central Spain for nearly a year. Marshals Espartero and O'Donnell, with the bulk of the Isabellino armies, had to conduct a long and bloody campaign against Cabrera before they succeeded in driving him into French territory in July 1840. The government of Louis Philippe kept him in a fortress for some months and then allowed him to go to England, where he quarrelled with the pretender, disapproving of his abdication in favour of the count of Montemolin. In 1848 Cabrera reappeared in the mountains of Catalonia at the head of Carlist bands. These were soon dispersed and he again fled to France. After this last effort he did not take a very active part in the propaganda and subsequent risings of the Carlists, who, however, continued to consult him. He took offence when new men, not a few of them quondam regular officers, became the advisers and lieutenants of Don Carlos in the war which lasted more or less from 1870-1876. Indeed, his long residence in England, his marriage with Miss Richards, and his prolonged absence from Spain had much shaken his devotion to his old cause and belief in its success. In March 1875 Cabrera sprang upon Don Carlos a manifesto in which he called upon the adherents of the pretender to follow his own example and submit to the restored monarchy of Alfonso XII., the son of Queen Isabella, who recognized the rank of captain-general and the title of count of Morella conferred on Cabrera by

the first pretender. Only a very few insignificant Carlists followed Cabrera's example, and Don Carlos issued a proclamation declaring him a traitor and depriving him of all his honours and titles. Cabrera, who was ever afterwards regarded with contempt and execration by the Carlists, died in London on the 24th of May 1877. He did not receive much attention from the majority of his fellow-countrymen, who commonly said that his disloyalty to his old cause had proved more harmful to him than beneficial to the new state of things. A pension which had been granted to his widow was renounced by her in 1899 in aid of the Spanish treasury after the loss of the colonies. (A. E. H.)

CACCINI, GIULIO (1558-1615?), Italian musical composer, also known as Giulio Romano, but to be distinguished from the painter of that name, was born at Rome about 1558, and in 1578 entered the service of the grand duke of Tuscany at Florence. He collaborated with J. Peri in the early attempts at musical drama which were the ancestors of modern opera (*Dafne*, 1594, and *Euridice*, 1600), produced at Florence by the circle of musicians and amateurs which met at the houses of G. Bardi and Corsi. He also published in 1601 *Le nuove musiche*, a collection of songs which is of great importance in the history of singing as well as in that of the transition period of musical composition. He was a lyric composer rather than a dramatist like Peri, and the genuine beauty of his works makes them acceptable even at the present day.

CÁCERES, a province of western Spain, formed in 1833 of districts taken from Estremadura, and bounded on the N. by Salamanca and Ávila, E. by Toledo, S. by Badajoz, and W. by Portugal. Pop. (1900) 362,164; area, 7667 sq. m. Cáceres is the largest of Spanish provinces, after Badajoz, and one of the most thinly peopled, although the number of its inhabitants steadily increases. Except for the mountainous north, where the Sierra de Gata and the Sierra de Grédos mark respectively the boundaries of Salamanca and Ávila, and in the south-east, where there are several lower ranges, almost the entire surface is flat or undulating, with wide tracts of moorland and thin pasture. There is little forest and many districts suffer from drought. The whole province, except the extreme south, belongs to the basin of the river Tagus, which flows from east to west through the central districts, and is joined by several tributaries, notably the Alagon and Tietar, from the north, and the Salor and Almoite from the south. The climate is temperate except in summer, when hot east winds prevail. Fair quantities of grain and olives are raised, but as a stock-breeding province Cáceres ranks second only to Badajoz. In 1900 its flocks and herds numbered more than 1,000,000 head. It is famed for its sheep and pigs, and exports wool, hams and the red sausages called *embutidos*. Its mineral resources are comparatively insignificant. The total number of mines at work in 1903 was only nine; their output consisted of phosphates, with a small amount of zinc and tin. Brandy, leather and cork goods, and coarse woollen stuffs are manufactured in many of the towns, but the backwardness of education, the lack of good roads, and the general poverty retard the development of commerce. The more northerly of the two Madrid-Lisbon railways enters the province on the east; passes south of Plasencia, where it is joined by the railway from Salamanca, on the north; and reaches the Portuguese frontier at Valencia de Alcántara. This line is supplemented by a branch from Arroyo to the city of Cáceres, and thence southwards to Mérida in Badajoz. Here it meets the railways from Seville and Cordova. The principal towns of Cáceres are Cáceres (pop. 1900, 16,933); Alcántara (3248), famous for its Roman bridge; Plasencia (8208); Trujillo (12,512), and Valencia de Alcántara (9417). These are described in separate articles. Arroyo, or Arroyo del Puerco (7094), is an important agricultural market. (See also ESTREMADURA.)

CÁCERES, the capital of the Spanish province of Cáceres, about 20 m. S. of the river Tagus, on the Cáceres-Mérida railway, and on a branch line which meets the more northerly of the two Madrid-Lisbon railways at Arroyo, 10 m. W. Pop. (1900) 16,933. Cáceres occupies a conspicuous eminence on a low ridge running east and west. At the highest point rises the lofty tower

of San Mateo, a fine Gothic church, which overlooks the old town, with its ancient palaces and massive walls, gateways and towers. Many of the palaces, notably those of the provincial legislature, the dukes of Abrantes, and the counts of la Torre, are good examples of medieval domestic architecture. The monastery and college of the Jesuits, formerly one of the finest in Spain, has been secularized and converted into a hospital. In the modern town, built on lower ground beyond the walls, are the law courts, town-hall, schools and the palace of the bishops of Cécilia (pop. 3124), a town on the river Alagon. The industries of Cáceres include the manufacture of cork and leather goods, pottery and cloth. There is also a large trade in grain, oil, live-stock and phosphates from the neighbouring mines. The name of *Cáceres* is probably an adaptation of *Los Alcázares*, from the Moorish *Alcázar*, a tower or castle; but it is frequently connected with the neighbouring *Castra Caecilia* and *Castra Servilia*, two Roman camps on the Mérida-Salamanca road. The town is of Roman origin and probably stands on the site of *Norba Caesariensis*. Several Roman inscriptions, statues and other remains have been discovered.

CACHAR, or **KACHAR**, a district of British India, in the province of Eastern Bengal and Assam. It occupies the upper basin of the Surma or Barak river, and is bounded on three sides by lofty hills. Its area is 3760 sq. m. It is divided naturally between the plain and hills. The scenery is beautiful, the hills rising generally steeply and being clothed with forests, while the plain is relieved of monotony by small isolated undulations and by its rich vegetation. The Surma is the chief river, and its principal tributaries from the north are the Jiri and Jatinga, and from the south the Sonai and Daleswari. The climate is extremely moist. Several extensive fens, notably that of Chaula, which becomes lakes in time of flood, are characteristic of the plain. This is alluvial and bears heavy crops of rice, next to which in importance is tea. The industry connected with the latter crop employs large numbers of the population; manufacturing industries are otherwise slight. The Assam-Bengal railway serves the district, including the capital town of Silchar. The population of the district in 1901 was 455,593, and showed a large increase, owing in great part to immigration from the adjacent district of Sylhet. The plain is the most thickly populated part of the district; in the North Cachar Hills the population is sparse. About 66% of the population are Hindus and 29% Mahomedans. There are three administrative subdivisions of the district: Silchar, Hailakandi and North Cachar. The district takes name from its former rulers of the Kachari tribe, of whom the first to settle here did so early in the 18th century, after being driven out of the Assam valley in 1536, and from the North Cachar Hills in 1706, by the Ahoms. About the close of the 18th century the Burmans threatened to expel the Kachari raja and annex his territory; the British, however, intervened to prevent this, and on the death of the last raja without heir in 1830 they obtained the territory under treaty. A separate principality which had been established in the North Cachar Hills earlier in the century by a servant of the raja, and had been subsequently recognized as such, was taken over by the British in 1854 owing to the misconduct of its rulers. The southern part of the district was raised several times in the 19th century by the turbulent tribe of Lushais.

CACHOEIRA, an important inland town of Bahia, Brazil, on the Paraguassú river, about 48 m. from São Salvador, with which it is connected by river-boats. Pop. (1890) of the city, 12,607; of the municipality, 48,352. The Bahia Central railway starts from this point and extends S. of W. to Machado Portella, 161 m. and N. to Feira de Santa Anna, 28 m. Although badly situated on the lower levels of the river (52 ft. above sea-level) and subject to destructive floods, Cachoeira is one of the most thriving commercial and industrial centres in the state. It exports sugar and tobacco and is noted for its cigar and cotton factories.

CACTUS. This word, applied in the form of *cactus* by the ancient Greeks to some prickly plant, was adopted by Linnaeus as the name of a group of curious succulent or fleshy-stemmed plants, most of them prickly and leafless, some of which produce

beautiful flowers, and are now so popular in our gardens that the name has become familiar. As applied by Linnaeus, the name *Cactus* is almost conterminous with what is now regarded as the natural order *Cactaceae*, which embraces several modern genera. It is one of the few Linnaean generic terms which have been entirely set aside by the names adopted for the modern divisions of the group.

The *Cacti* may be described in general terms as plants having a woody axis, overlaid with thick masses of cellular tissue forming the fleshy stems. These are extremely various in character and form, being globose, cylindrical, columnar or flattened into leafy expansions or thick joint-like divisions, the surface being either ribbed like a melon, or developed into nipple-like protuberances, or variously angular, but in the greater number of the species furnished copiously with tufts of horny spines, some of which are exceedingly keen and powerful. These tufts show the position of buds, of which, however, comparatively few are developed. The stems are in most cases leafless, using the term in a popular sense; the leaves, if present at all, being generally reduced to minute scales. In one genus, however, *Peireskia*, the stems are less succulent, and the leaves, though rather fleshy, are developed in the usual form. The flowers are frequently large and showy, and are generally attractive from their high colouring. In one group, represented by *Cereus*, they consist of a tube, more or less elongated, on the outer surface of which, towards the base, are developed small and at first inconspicuous scales, which gradually



FIG. 1.—Prickly Pear (*Opuntia vulgaris*).

1, Flower reduced; 2, Same in vertical section; 3, Flattened branch much reduced; 4, Horizontal plan of arrangement of flower.

increase in size upwards, and at length become crowded, numerous and petaloid, forming a funnel-shaped blossom, the beauty of which is much enhanced by the multitude of conspicuous stamens which with the pistil occupy the centre. In another group, represented by *Opuntia* (fig. 1), the flowers are rotate, that is to say, the long tube is replaced by a very short one. At the base of the tube, in both groups, the ovary becomes developed into a fleshy (often edible) fruit, that produced by the *Opuntia* being known as the prickly pear or Indian fig.

The principal modern genera are grouped by the differences in the flower-tube just explained. Those with long-tubed flowers comprise the genera *Melocactus*, *Mammillaria*, *Echinocactus*, *Cereus*, *Piloceerus*, *Echinopsis*, *Phyllocactus*, *Epiphyllum*, &c.; while those with short-tubed flowers are *Rhipsalis*, *Opuntia*, *Peireskia*, and one or two of minor importance. *Cactaceae* belong almost entirely to the New World; but some of the *Opuntias* have been so long distributed over certain parts of Europe, especially on the shores of the Mediterranean and the volcanic soil of Italy, that they appear in some places to have taken possession of the soil, and to be distinguished with difficulty from the aboriginal vegetation. The habitats which they affect are the hot, dry regions of tropical America, the aridity of which they are enabled to withstand in consequence of the thickness of their skin and the paucity of evaporating pores or stomata with which they are furnished,—these conditions not permitting the moisture they contain to be carried off too rapidly; the thick

fleshy stems and branches contain a store of water. The succulent fruits are not only edible but agreeable, and in fevers are freely administered as a cooling drink. The Spanish Americans plant the *Opuntias* around their houses, where they serve as impenetrable fences.

Melocactus, the genus of melon-thistle or Turk's-cap cactuses, contains, according to a recent estimate, about 90 species, which inhabit chiefly the West Indies, Mexico and Brazil, a few extending into New Granada. The typical species, *M. communitis*, forms a succulent mass of roundish or ovate form, from 1 ft. to 2 ft. high, the surface divided into numerous furrows like the ribs of a melon, with projecting angles, which are set with a regular series of stellated spines—each bundle consisting of about five larger spines, accompanied by smaller but sharp bristles—and the tip of the plant being surmounted by a cylindrical crown 3 to 5 in. high, composed of reddish-brown, needle-like bristles, closely packed with cottony wool. At the summit of this crown the small rosy-pink flowers are produced, half protruding from the mass of wool, and these are succeeded by small red berries. These strange plants usually grow in rocky places with little or no earth to support them; and it is said that in times of drought the cattle resort to them to allay their thirst, first ripping them up with their horns and tearing off the outer skin, and then devouring the moist succulent parts. The fruit, which has an agreeably acid flavour, is frequently eaten in the West Indies. The *Melocacti* are distinguished by the distinct cephalium or crown which bears the flowers.

Mammillaria.—This genus, which comprises nearly 300 species, mostly Mexican, with a few Brazilian and West Indian, is called nipple cactus, and consists of globular or cylindrical succulent plants, whose surface instead of being cut up into ridges with alternate furrows, as in *Melocactus*, is broken up into teat-like cylindrical or angular tubercles, spirally arranged, and terminating in a radiating tuft of spines which spring from a little woolly cushion. The flowers issue from between the mammillae, towards the upper part of the stem, often disposed in a zone just below the apex, and are either purple, rose-pink, white or yellow, and of moderate size. The spines are variously coloured, white and yellow tints predominating, and from the symmetrical arrangement of the areolae or tufts of spines they are very pretty objects, and are hence frequently kept in drawing-room plant cases. They grow freely in a cool greenhouse.

Echinocactus (fig. 2) is the name given to the genus bearing the popular name of hedgehog cactus. It comprises some 200 species, distributed from the south-west United States to Brazil and Chile. They have the fleshy stems characteristic of the order, these being either globose, oblong or cylindrical, and either ribbed as in *Melocactus*, or broken up into distinct tubercles, and most of them armed with stiff sharp spines, set in little woolly cushions occupying the place of the buds. The flowers, produced near the apex of the plant, are generally large and showy, yellow and rose being the prevailing colours. They are succeeded by succulent fruits, which are exserted, and frequently scaly or spiny, in which respects this genus differs both from *Melocactus* and *Mammillaria*, which have the fruits immersed and smooth. One of the most interesting species is the *E. ingens*, of which some very large plants have been from time to time imported. These large plants have from 40 to 50 ridges, on which the buds and clusters of spines are sunk at intervals, the aggregate number of the spines having been in some cases computed at upwards of 50,000 on a single plant. These spines are used by the Mexicans as toothpicks. The plants are slow growers and must have plenty of sun heat; they require sandy loam with a mixture of sand and bricks finely broken and must be kept dry in winter.

Cereus.—This group bears the common name of torch thistle. It comprises about 100 species, largely Mexican but scattered through South America and the West Indies. The stems are columnar or elongated, some of the latter creeping on the ground or climbing up the trunks of trees, rooting as they grow. *C. giganteus*, the largest and most striking species of the genus, is a native of hot, arid, desert regions of New Mexico, growing there in rocky valleys and on mountain sides, where the tall stems with their erect branches have the appearance of telegraph poles. The stems grow to a height of from 50 ft. to 60 ft., and have a diameter of from 1 ft. to 2 ft., often unbranched, but sometimes furnished with branches



FIG. 2.—*Echinocactus* much reduced; the flowers are several inches in diameter.

which grow out at right angles from the main stem, and then curve upwards and continue their growth parallel to it; these stems have from twelve to twenty ribs, on which at intervals of about an inch are the buds with their thick yellow cushions, from which issue five or six large and numerous smaller spines. The fruits of this plant, which are green oval bodies from 2 to 3 in. long, contain a crimson pulp from which the Pimos and Papagos Indians prepare an excellent preserve; and they also use the ripe fruit as an article of food, gathering it by means of a forked stick attached to a long pole. The *Cereus* include some of our most interesting and beautiful hothouse plants. In the allied genus *Echinocereus*, with 25 to 30 species in North and South America, the stems are short, branched or simple, divided into few or many ridges all armed with sharp, formidable spines. *E. pectinatus* produces a purplish fruit resembling a gooseberry, which is very good eating; and the fleshy part of the stem itself, which is called *cabeza del viego* by the Mexicans, is eaten by them as a vegetable after removing the spines.

PILOCEREUS, the old man cactus, forms a small genus with tallish erect, fleshy, angulate stems, on which, with the tufts of spines, are developed hair-like bodies, which, though rather coarse, bear some resemblance to the hoary locks of an old man. The plants are nearly allied to *Cereus*, differing chiefly in the floriferous portion developing these longer and more attenuated hair-like spines, which surround the base of the flowers and form a dense woolly head or cephalium. The most familiar species is *P. senilis*, a Mexican plant, which though seldom seen more than a foot or two in height in greenhouses, reaches from 20 ft. to 30 ft. in its native country.

ECHINOPSIS is another small group of species, separated by some authors from *Cereus*. They are dwarf, ribbed, globose or cylindrical plants; and the flowers, which are produced from the side instead of the apex of the stem, are large, and in some cases very beautiful, being remarkable for the length of the tube, which is more or less covered with bristly hairs. They are natives of Brazil, Bolivia and Chile.

PHYLLOCACTUS (fig. 3), the Leaf Cactus family, consists of about a dozen species, found in Central and tropical South America.



FIG. 3.—Branch of *Phyllocactus* much reduced; the flowers are 6 in. or more in diameter.

They differ from all the forms already noticed in being shrubby and epiphytal in habit, and in having the branches compressed and dilated so as to resemble thick fleshy leaves, with a strong median axis and rounded woody base. The margins of these leaf-like branches are more or less crenately notched, the notches representing buds, as do the spine-clusters in the spiny genera; and from these crenatures the large showy flowers are produced. As garden plants the *Phyllocacti* are amongst the most ornamental of the whole family, being of easy culture, free blooming and remarkably showy, the colour of the flowers ranging from rich crimson, through rose-pink to creamy white. Cuttings strike readily in spring before growth has commenced; they should be potted in 3-in. or 4-in. pots, well drained, in loamy soil made very porous by the admixture of finely broken crocks and sand, and placed in a temperature of 60°; when these pots are filled with roots they are to be shifted into larger ones, but overpotting must be avoided. During the summer they need considerable heat, all the light possible and plenty of air; in winter a temperature of 45° or 50° will be sufficient, and they must be kept tolerably dry at the root. By the spring they may have larger pots if required and should be kept in a hot and fairly moistened atmosphere; and by the end of June, when they have

made new growth, they may be turned out under a south wall in the full sun, water being given only as required. In autumn they are to be returned to a cool house and wintered in a dry stove. The turning of them outdoors to ripen their growth is the surest way to obtain flowers, but they do not take on a free blooming habit until they have attained some age. They are often called *Epi-phyllicus*, which name is, however, properly restricted to the group next to be mentioned.

EPIPHYLLUM.—This name is now restricted to two or three dwarf branching Brazilian epiphytal plants of extreme beauty, which agree with *Phyllocactus* in having the branches dilated into the form of fleshy leaves, but differ in having them divided into short truncate leaf-like portions, which are articulated, that is to say, provided with a joint by which they separate spontaneously; the margins are crenate or dentate, and the flowers, which are large and showy, magenta or crimson, appear at the apex of the terminal joints. In *E. truncatum* the flowers have a very different aspect from that of other *Cacti*, from the mouth of the tube being oblique and the segments all reflexed at the tip. The short separate pieces of which these plants are made up grow out of each other, so that the branches may be said to resemble leaves joined together endwise.

RHIPSALIS, a genus of about 50 tropical species, mainly in Central and South America, but a few in tropical Africa and Madagascar. It is a very heterogeneous group, being fleshy-stemmed with a woody axis, the branches being angular, winged, flattened or cylindrical, and the flowers small, short-tubed, succeeded by small, round, peashaped berries. *Rhispalis Cassytha*, when seen laden with its white berries, bears some resemblance to a branch of mistletoe. All the species are epiphytal in habit.

OPUNTIA, the prickly pear, or Indian fig cactus, is a large typical group, comprising some 150 species, found in North America, the West Indies, and warmer parts of South America, extending as far as Chile. In aspect they are very distinct from any of the other groups. They are fleshy shrubs, with rounded, woody stems, and numerous succulent branches, composed in most of the species of separate joints or parts, which are much compressed, often elliptic or suborbicular, dotted over in spiral lines with small, fleshy, caducous leaves, in the axils of which are placed the areoles or tufts of barbed or hooked spines of two forms. The flowers are mostly yellow or reddish-yellow, and are succeeded by pear-shaped or egg-shaped fruits, having a broad scar at the top, furnished on their soft, fleshy rind with tufts of small spines. The sweet, juicy fruits of *O. vulgaris* and *O. Tuna* are much eaten under the name of prickly pears, and are greatly esteemed for their cooling properties. Both these species are extensively cultivated for their fruit in Southern Europe, the Canaries and northern Africa; and the fruits are not unfrequently to be seen in Covent Garden Market and in the shops of the leading fruiterers of the metropolis. *O. vulgaris* is hardy in the south of England.

The cochineal insect is nurtured on a species of *Opuntia* (*O. coccinifera*), separated by some authors under the name of *Nopalea*, and sometimes also on *O. Tuna*. Plantations of the nopal and the tuna, which are called *nopaleries*, are established for the purpose of rearing this insect, the *Coccus Cacti*, and these often contain as many as 50,000 plants. The females are placed on the plants about August, and in four months the first crop of cochineal is gathered, two more being produced in the course of the year. The native country of the insect is Mexico, and it is there more or less cultivated; but the greater part of our supply comes from Colombia and the Canary Islands.

PEIRESKIA ACULEATA, or Barbadoes gooseberry, the *Cactu peireskia* of Linnaeus, differs from the rest in having woody stems and leaf-bearing branches, the leaves being somewhat fleshy, but otherwise of the ordinary laminate character. The flowers are subpaniculate, white or yellowish. This species is frequently used as a stock on which to graft other *Cacti*. There are about a dozen species known of this genus, mainly Mexican.

CADALSO VAZQUEZ, JOSÉ (1741-1782), Spanish author, was born at Cadix on the 8th of October 1741. Before completing his twentieth year he had travelled through Italy, Germany, England, France and Portugal, and had studied the literatures of these countries. On his return to Spain he entered the army and rose to the rank of colonel. He was killed at the siege of Gibraltar, on the 27th of February 1782. His first published work was a rhymed tragedy, *Don Sancho Garcia, Conde de Castilla* (1771). In the following year he published his *Eruditos á la Violeta*, a prose satire on superficial knowledge, which was very successful. In 1773 appeared a volume of miscellaneous poems, *Ocios de mi juventud*, and after his death there was found among his MSS. a series of fictitious letters in the style of the *Lettres Persanes*; these were issued in 1793 under the title of *Cartas marruecas*. A good edition of his works appeared at Madrid, in 3 vols. 1823. This is supplemented by the *Obras inéditas* (Paris, 1894) published by R. Fouché-Delboec.

CADAMOSTO (or **CA DA MOSTO**), **ALVISE** (1432-1477), a Venetian explorer, navigator and writer, celebrated for his voyages in the Portuguese service to West Africa. In 1454 he sailed from Venice for Flanders, and, being detained by contrary winds off Cape St Vincent, was enlisted by Prince Henry the Navigator among his explorers, and given command of an expedition which sailed (22nd of March 1455) for the south. Visiting the Madeira group and the Canary Islands (of both which he gives an elaborate account, especially concerned with European colonization and native customs), and coasting the West Sahara (whose tribes, trade and trade-routes he likewise describes in detail), he arrived at the Senegal, whose lower course had already, as he tells us, been explored by the Portuguese 60 m. up. The negro lands and tribes south of the Senegal, and especially the country and people of Budomel, a friendly chief reigning about 50 m. beyond the river, are next treated with equal wealth of interesting detail, and Cadamosto thence proceeded towards the Gambia, which he ascended some distance (here also examining races, manners and customs with minute attention), but found the natives extremely hostile, and so returned direct to Portugal. Cadamosto expressly refers to the chart he kept of this voyage. At the mouth of the Gambia he records an observation of the "Southern Chariot" (Southern Cross). Next year (1456) he went out again under the patronage of Prince Henry. Doubling Cape Blanco he was driven out to sea by contrary winds, and thus made the first known discovery of the Cape Verde Islands. Having explored Boavista and Santiago, and found them uninhabited, he returned to the African mainland, and pushed on to the Gambia, Rio Grande and Geba. Returning thence to Portugal, he seems to have remained there till 1463, when he reappeared at Venice. He died in 1477.

Besides the accounts of his two voyages, Cadamosto left a narrative of Pedro de Cintra's explorations in 1461 (or 1462) to Sierra Leone and beyond Cape Mesurado to El Mina and the Gold Coast; all these relations first appeared in the 1507 Vicenza Collection of Voyages and Travels (*the Paesi nuovamente ritrovati di novo mondo da Alberico Vesputio Florentino*); they have frequently since been reprinted and translated (e.g. Ital. text in 1508, 1512, 1519, 1521, 1550 (Ramusio), &c.; Lat. version, *Itinerarium Portugallensium*, &c., 1508, 1532 (Grynaeus), &c.; Fr. *Sensuy le nouveau monde*, &c., 1516, 1521; German, *Neue unbekante Lande*, &c., 1508). See also C. Schefer, *Relation des voyages ... de Ca da Mosto* (1895); R. H. Major, *Henry the Navigator* (1868), pp. 246-287; C. R. Beazley, *Henry the Navigator* (1895), pp. 261-288; Yule Oldham, *Discovery of the Cape Verde Islands* (1892), esp. pp. 4-15.

It may be noted that Antonio Ugo di Mare (Antoniotto Ususmaria), the Genoise, wrote his famous letter of the 12th of December 1455 (purporting to record a meeting with the last surviving descendant of the Genoise-Indian expedition of 1291, at or near the Gambia), after accompanying Cadamosto to West Africa; see Beazley, *Dawn of Modern Geography* (1892), iii. 416-418.

CADASTRE (a French word from the Late Lat. *capitistrum*, a register of the poll-tax), a register of the real property of a country, with details of the area, the owners and the value. A "cadastral survey" is properly, therefore, one which gives such information as the Domesday Book, but the term is sometimes used loosely of the Ordnance Survey of the United Kingdom (1 = 2500), which is on a sufficiently large a scale to give the area of every field or piece of ground.

CADDIS-FLY and **CADDIS-WORM**, the name given to insects with a superficial resemblance to moths, sometimes referred to the Neuroptera, sometimes to a special order, the Trichoptera, in allusion to the hairy clothing of the body and wings. Apart from this feature the Trichoptera also differ from the typical Neuroptera in the relatively simple, mostly longitudinal neurulation of the wings, the absence or obsolescence of the mandibles and the semi-haustellate nature of the rest of the mouth-parts. Although caddis-flies are sometimes referred to several families, the differences between the groups are of no great importance. Hence the insects may more conveniently be regarded as constituting the single family *Phryganeidae*. The larvae known as caddis-worms are aquatic. The mature females lay their eggs in the water, and the newly-hatched larvae provide themselves with cases made of various particles such as grains of sand, pieces of wood or leaves stuck together with silk secreted from the salivary glands of the insect. These cases differ greatly

in structure and shape. Those of *Phryganea* consist of bits of twigs or leaves cut to a suitable length and laid side by side in a long spirally-coiled band, forming the wall of a subcylindrical cavity. The cavity of the tube of *Helicopsyche*, composed of grains of sand, is itself spirally coiled, so that the case exactly resembles a small snail-shell in shape. One species of *Limnophilus* uses small but entire leaves; another, the shells of the pond-snail *Planorbis*; another, pieces of stick arranged transversely with reference to the long axis of the tube. To admit of the free inflow and outflow of currents of water necessary for respiration, which is effected by means of filamentous abdominal tracheal gills, the two ends of the tube are open. Sometimes the cases are fixed, but more often portable. In the latter case the larva crawls about the bottom of the water or up the stems of plants, with its thickly-chitinized head and legs protruding from the larger orifice, while it maintains a secure hold of the silk lining of the tube by means of a pair of strong hooks at the posterior end of its soft defenceless abdomen. Their food appears for the most part to be of a vegetable nature. Some species, however, are alleged to be carnivorous, and a North American form of the genus *Hydropsyche* is said to spin around the mouth of its burrow a silken net for the capture of small animal organisms living in the water. Before passing into the pupal stage, the larva partially closes the orifice of the tube with silk or pieces of stone loosely spun together and pervious to water. Through this temporary protection the active pupa, which closely resembles the mature insect, subsequently bites a way by means of its strong mandibles, and rising to the surface of the water casts the pupal integument and becomes sexually adult.

The above sketch may be regarded as descriptive of the life-history of a great majority of species of caddis-flies. It is only necessary here to mention one anomalous form, *Eoicocyla pusilla*, in which the mature female is wingless and the larva is terrestrial, living in moss or decayed leaves.

Caddis-flies are universally distributed. Geologically they are known to date back to the Oligocene period, and wings believed to be referable to them have been found in Liasic and Jurassic beds. (R. I. P.)

CADDO, a confederacy of North American Indian tribes which gave its name to the Caddoan stock, represented in the south by the Caddos, Wichita and Kichai, and in the north by the Pawnee and Arikara tribes. The Caddos, now reduced to some 500, settled in western Oklahoma, formerly ranged over the Red River (Louisiana) country, in what is now Arkansas, northern Texas and Oklahoma. The native name of the confederacy is Hasinai, corrupted by the French into Asinai and Ceniz. The Caddoan tribes were mostly agricultural and sedentary, and to-day they are distinguished by their industry and intelligence.

See *Handbook of American Indians* (Washington, 1907).

CADE, JOHN (d. 1450), commonly called JACK CADE, English rebel and leader of the rising of 1450, was probably an Irishman by birth, but the details of his early life are very scanty. He seems to have resided for a time in Sussex, to have fled from the country after committing a murder, and to have served in the French wars. Returning to England, he settled in Kent under the name of Aylmer and married a lady of good position. When the men of Kent rose in rebellion in May 1450, they were led by a man who took the name of Mortimer, and who has generally been regarded as identical with Cade. Mr James Gairdner, however, considers it probable that Cade did not take command of the rebels until after the skirmish at Sevenoaks on the 18th of June. At all events, it was Cade who led the insurgents from Blackheath to Southwark, and under him they made their way into London on the 3rd of July. A part of the populace was doubtless favourable to the rebels, but the opposing party gained strength when Cade and his men began to plunder. Having secured the execution of James Fiennes, Baron Say and Sele, and of William Crowmer, sheriff of Kent, Cade and his followers retired to Southwark, and on the 5th of July, after a fierce struggle on London Bridge, the citizens prevented them from re-entering the city. Cade then met the chancellor, John

Kemp, archbishop of York, and William of Waynesflete, bishop of Winchester, and terms of peace were arranged. Pardons were drawn up, that for the leaders being in the name of Mortimer. Cade, however, retained some of his men, and at this time, or a day or two earlier, broke open the prisons in Southwark and released the prisoners, many of whom joined his band. Having collected some booty, he went to Rochester, made a futile attempt to capture Queenborough castle, and then quarrelled with his followers over some plunder. On the 10th of July a proclamation was issued against him in the name of Cade, and a reward was offered for his apprehension. Escaping into Sussex he was captured at Heathfield on the 12th. During the scuffle he had been severely wounded, and on the day of his capture he died in the cart which was conveying him to London. The body was afterwards beheaded and quartered, and in 1451 Cade was attained.

See Robert Fabyan, *The New Chronicles of England and France*, edited by H. Ellis (London, 1811); William of Worcester, *Annales rerum Anglicarum*, edited by J. Stevenson (London, 1864); *An English Chronicle of the Reigns of Richard II., Henry IV., Henry V. and Henry VI.*, edited by J. S. Davies (London, 1856); *Historical Collections of a Citizen of London*, edited by J. Gairdner (London, 1876); *Three Fifteenth Century Chronicles*, edited by J. Gairdner (London, 1880); J. Gairdner, Introduction to the *Paston Letters* (London, 1904); G. Kriehn, *The English Rising of 1450* (Strassburg, 1892.)

CADENABBIA, a village of Lombardy, Italy, in the province of Como, about 15 m. N.N.E. by steamer from the town of Como. It is situated on the W. shore of the lake of Como, and owing to the great beauty of the scenery and of the vegetation, and its sheltered situation, is a favourite spring and autumn resort. The most famous of its villas is the Villa Carlotta, now the property of the duke of Saxe-Meiningen, which contains marble reliefs by Thorwaldsen, representing the triumph of Alexander, and statues by Canova.

CADENCE (through the Fr. from the Lat. *cadentia*, from *cadere*, to fall), a falling or sinking, especially as applied to rhythmical or musical sounds, as in the "fall" of the voice in speaking, the rhythm or measure of verses, song or dance. In music, the word is used of the closing chords of a musical phrase, which succeed one another in such a way as to produce, first an expectation or suspense, and then an impression of finality, indicating also the key strongly. "Cadenza," the Italian form of the same word, is used of a free flourish in a vocal or instrumental composition, introduced immediately before the close of a movement or at the end of the piece. The object is to display the performer's technique, or to prevent too abrupt a contrast between two movements. Cadenzas are usually left to the improvisation of the performer, but are sometimes written in full by the composer, or by some famous executant, as in the cadenza in Brahms's *Violin Concerto*, written by Joseph Joachim.

CADER IDRIS ("the Seat of Idris"), the second most imposing mountain in North Wales, standing in Merionethshire to the S. of Dolgelly, between the broad estuaries of the Mawddach and the Dovey. It is so called in memory of Idris Gawr, celebrated in the Triads as one of the three "Gwyn Serenyddion," or "Happy Astronomers," of Wales, who is traditionally supposed to have made his observations on this peak. Its loftiest point, known as Pen-y-gader, rises to the height of 2914 ft., and in clear weather commands a magnificent panorama of immense extent. The mountain is everywhere steep and rocky, especially on its southern side, which falls abruptly towards the Lake of Tal-y-llyn. Mention of Cader Idris and its legends is frequent in Welsh literature, old and modern.

CADET (through the Fr. from the Late Lat. *capitellum*, a diminutive of *caput*, head, through the Provençal form *capdet*), the head of an inferior branch of a family, a younger son; particularly a military term for an accepted candidate for a commission in the army or navy, who is undergoing training to become an officer. This latter use of the term arose in France, where it was applied to the younger sons of the noblesse who gained commissioned rank, not by serving in the ranks or by entering the *écoles militaires*, but by becoming attached to corps

without pay but with certain privileges. "Cadet Corps," in the British service, are bodies of boys or youths organized, armed and trained on volunteer military lines. Derived from "cadet," through the Scots form "cadee," comes "caddie," a messenger-boy, and particularly one who carries clubs at golf, and also the slang word "cad," a vulgar, ill-bred person.

CADGER (a word of obscure origin possibly connected with "catch"), a hawk or pedlar, a carrier of farm produce to market. The word in this sense has fallen into disuse, and now is used for a beggar or loafer, one who gets his living in more or less questionable ways.

CADI (*qādi*), a judge in a *maḥkama* or Mahomedan ecclesiastical court, in which decisions are rendered on the basis of the canon law of Islam (*shari'a*). It is a general duty, according to canon law, upon a Moslem community to judge legal disputes on this basis, and it is an individual duty upon the ruler of the community to appoint a cadi to act for the community. According to Shāfi'ite law, such a cadi must be a male, free, adult Moslem, intelligent, of unassailed character, able to see, hear and write, learned in the Koran, the traditions, the Agreement, the differences of the legal schools, acquainted with Arabic grammar and the exegesis of the Koran. He must not sit in a mosque, except under necessity, but in some open, accessible place. He must maintain a strictly impartial attitude of body and mind, accept no presents from the people of his district, and render judgment only when he is in a normal condition mentally and physically. He may not engage in any business. He shall ride to the place where he holds court, greeting the people on both sides. He shall visit the sick and those returned from a journey, and attend funerals. On some of these points the codes differ, and the whole is to be regarded as the ideal qualification, built up theoretically by the canonists.

See MAHOMEDAN LAW; also Juynboll, *De Mohammedaansche Wet* (Leiden, 1903), pp. 287 ff.; Sachau, *Mohammedanisches Recht* (Berlin, 1897), pp. 687 ff. (D. B. MA.)

CADILLAC, a city and the county seat of Wexford county, Michigan, U.S.A., on Lake Cadillac, about 95 m. N. by E. of Grand Rapids and about 85 m. N.W. of Bay City. Pop. (1890) 4461; (1900) 5997, of whom 1676 were foreign-born; (1904) 6893; (1910) 8375. It is served by the Ann Arbor and the Grand Rapids & Indiana railways. Cadillac overlooks picturesque lake scenery, and the good fishing for pike, pickerel and perch in the lake, and for brook trout in streams near by, attracts many visitors. Among the city's chief manufactures are hardwood lumber, iron, tables, crates and woodenware, veneer, flooring and flour. Cadillac was settled in 1871, was incorporated as a village under the name of Clam Lake in 1875, was chartered as a city under its present name (from Antoine de la Mothe Cadillac) in 1877, and was rechartered in 1895.

CADIZ, a town of the province of Negros Occidental, island of Negros, Philippine Islands, on the N. coast, about 53 m. N.N.E. of Bacolod, the capital. Pop. (1903) 16,429. Lumber products are manufactured in the town, and a saw-mill here is said to be the largest in the Philippines.

CADIZ (*Cádiz*), a maritime province in the extreme south of Spain, formed in 1833 of districts taken from the province of Seville; and bounded on the N. by Seville, E. by Málaga, S.E. by the Mediterranean sea, S. by the Straits of Gibraltar, and W. by the Atlantic Ocean. Pop. (1900) 452,659; area 2834 sq. m.; inclusive, in each case, of the town and territory of Ceuta, on the Moroccan coast, which belong, for administrative purposes, to Cadiz. The sea-board of Cadiz possesses several features of exceptional interest. On the Atlantic littoral, the broad Guadalquivir estuary marks the frontier of Seville; farther south, the river Guadalete, which waters the northern districts, falls into the magnificent double bay of Cadiz; farther south again, is Cape Trafalgar, famous for the British naval victory of 1805. Near Trafalgar, the river Barbate issues into the straits of Gibraltar, after receiving several small tributaries, which combine with it to form, near its mouth, the broad and marshy Laguna de la Janda. Punta Marroquí, on the straits, is the southernmost promontory of the European mainland. The

most conspicuous feature of the east coast is Algeciras Bay, overlooked by the rock and fortress of Gibraltar. The river Guadiaro, which drains the eastern highlands, enters the Mediterranean close to the frontier of Málaga. In the interior there is a striking contrast between the comparatively level western half of Cadiz and the very picturesque mountain ranges of the eastern half, which are well wooded and abound in game. The whole region known as the Campo de Gibraltar is of this character; but it is in the north-east that the summits are most closely massed together, and attain their greatest altitudes in the Cerro de San Cristobal (5630 ft.) and the Sierra del Pinar (5413 ft.).

The climate is generally mild and temperate, some parts of the coast only being unhealthy owing to a marshy soil. Severe drought is not unusual, and it was largely this cause, together with want of capital, and the dependence of the peasantry on farming and fishing, that brought about the distress so prevalent early in the 20th century. The manufactures are insignificant compared with the importance of the natural products of the soil, especially wines and olives. Jerez de la Frontera (Xeres) is famous for the manufacture and export of sherry. The fisheries furnish about 2500 tons of fish per annum, one-fifth part of which is salted for export and the rest consumed in Spain. There are no important mines, but a considerable amount of salt is obtained by evaporation of sea-water in pans near Cadiz, San Fernando, Puerto Real and Santa Maria. The railway from Seville passes through Jerez de la Frontera to Cadiz and San Fernando, and another line, from Granada, terminates at Algeciras; but at the beginning of the 20th century, although it was proposed to construct railways from Jerez inland to Grazalema and coastwise from San Fernando to Tarifa, travellers who wished to visit these places were compelled to use the old-fashioned diligence, over indifferent roads, or to go by sea. The principal seaports are, after Cadiz the capital (pop. 1900, 69,382), Algeciras (13,302), La Línea (31,862), Puerto de Santa Maria (20,120), Puerto Real (10,535), the naval station of San Fernando (29,635), San Lucar (23,883) and Tarifa (11,723); the principal inland towns are Arcos de la Frontera (13,926), Chiclana (10,868), Jerez de la Frontera (63,473), Medina Sidonia (11,040), and Véjer de la Frontera (11,298). These are all described in separate articles. Grazalema (5587), Jimena de la Frontera (7549), and San Roque (8569) are less important towns with some trade in leather, cork, wine and farm produce. They all contain many Moorish antiquities, and Grazalema probably represents the Roman *Lacidulermium*. (See also ANDALUSIA.)

CADIZ (in Lat. *Gades*, and formerly called *Cales* by the English), the capital and principal seaport of the Spanish province of Cadiz; on the Bay of Cadiz, an inlet of the Atlantic Ocean, in 36° 27' N. and 6° 12' W., 94 m. by rail S. of Seville. Pop. (1900) 69,382. Cadiz is built on the extremity of a tongue of land, projecting about 5 m. into the sea, in a north-westerly direction from the Isla de Leon. Its noble bay, more than 30 m. in circuit, and almost entirely land-locked by the isthmus and the headlands which lie to the north-east, has principally contributed to its commercial importance. The outer bay stretches from the promontory and town of Rota to the mouth of the river Guadalete; the inner bay, protected by the forts of Matagorda and Puntales, affords generally good anchorage, and contains a harbour formed by a projecting mole, where vessels of small burden may discharge. The entrance to the bays is rendered somewhat dangerous by the low shelving rocks (Cochinos and Las Puercas) which encumber the passage, and by the shifting banks of mud deposited by the Guadalete and the Rio Santi Petri, a broad channel separating the Isla de Leon from the mainland. At the mouth of this channel is the village of Caracca; close beside it is the important naval arsenal of San Fernando (q.v.); and on the isthmus are the defensive works known as the Cortadura, or Fort San Fernando, and the well-frequented sea-bathing establishments.

From its almost insular position Cadiz enjoys a mild and serene climate. The *Medina*, or land-wind, so-called because it blows from the direction of Medina Sidonia, prevails during the winter; the moisture-laden *Virazón*, a westerly sea-breeze,

sets in with the spring. The mean annual temperature is about 64° F., while the mean summer and winter temperatures vary only about 10° above and below this point; but the damp atmosphere is very oppressive in summer, and its unhealthiness is enhanced by the inadequate drainage and the masses of rotting seaweed piled along the shore. The high death-rate, nearly 45 per thousand, is also due to the bad water-supply, the water being either collected in cisterns from the tops of the houses, or brought at great expense from Santa Maria on the opposite coast by an aqueduct nearly 30 m. long. An English company started a waterworks in Cadiz about 1875, but came to grief through the incapacity of the population to appreciate its necessity.

The city, which is 6 or 7 m. in circumference, is surrounded by a wall with five gates, one of which communicates with the isthmus. Seen from a distance off the coast, it presents a magnificent display of snow-white turrets rising majestically from the sea; and for the uniformity and elegance of its buildings, it must certainly be ranked as one of the finest cities of Spain, although, being hemmed in on all sides, its streets and squares are necessarily contracted. Every house annually receives a coating of whitewash, which, when it is new, produces a disagreeable glare. The city is distinguished by its somewhat deceptive air of cleanliness, its quiet streets, where no wheeled traffic passes, and its lavish use of white Italian marble. But the most characteristic feature of Cadiz is the marine promenades, fringing the city all round between the ramparts and the sea, especially that called the *Alameda*, on the eastern side, commanding a view of the shipping in the bay and the ports on the opposite shore. The houses are generally lofty and surmounted by turrets and flat roofs in the Moorish style.

Cadiz is the see of a bishop, who is suffragan to the archbishop of Seville, but its chief conventual and monastic institutions have been suppressed. Of its two cathedrals, one was originally erected by Alphonso X. of Castile (1252-1284), and rebuilt after 1596; the other, begun in 1722, was completed between 1832 and 1838. Under the high altar of the old cathedral rises the only freshwater spring in Cadiz. The chief secular buildings include the Hospicio, or Casa de Misericordia, adorned with a marble portico, and having an interior court with Doric colonnades; the bull-ring, with room for 12,000 spectators; the two theatres, the prison, the custom-house, and the lighthouse of San Sebastian on the western side rising 172 ft. from the rock on which it stands. Besides the Hospicio already mentioned, which sometimes contains 1000 inmates, there are numerous other charitable institutions, such as the women's hospital, the founding institution, the admirable Hospicio de San Juan de Dios for men, and the lunatic asylum. Gratuitous instruction is given to a large number of children, and there are several mathematical and commercial academies, maintained by different commercial corporations, a nautical school, a school of design, a theological seminary and a flourishing medical school. The museum is filled for the most part with Roman and Carthaginian coins and other antiquities; the academy contains a valuable collection of pictures. In the church of Santa Catalina, which formerly belonged to the Capuchin convent, now secularized, there is an unfinished picture of the marriage of St Catherine, by Murillo, who met his death by falling from the scaffold on which he was painting it (3rd of April 1682).

Cadiz no longer ranks among the first marine cities of the world. Its harbour works are insufficient and antiquated, though a scheme for their improvement was adopted in 1903; its communications with the mainland consist of a road and a single line of railway; its inhabitants, apart from foreign residents and a few of the more enterprising merchants, rest contented with such prosperity as a fine natural harbour and an unsurpassed geographical situation cannot fail to confer. Several great shipping lines call here; shipbuilding yards and various factories exist on the mainland; and there is a considerable trade in the exportation of wine, principally sherry from Jerez, salt, olives, figs, canary-seed and ready-made corks; and in the importation of fuel, iron and machinery, building materials, American oak staves for casks, &c. In 1904, 2753 ships of 1,745,588 tons

entered the port. But local trade, though still considerable, remains stationary if it does not actually recede. Its decline, originally due to the Napoleonic wars and the acquisition of independence by many Spanish colonies early in the 19th century, was already recognised, and an attempt made to check it in 1828, when the Spanish government declared Cadiz a free warehousing port; but this valuable privilege was withdrawn in 1832. Among the more modern causes of depression have been the rivalry of Gibraltar and Seville; the decreasing demand for sherry; and the disasters of the Spanish-American war of 1898, which almost ruined local commerce with Cuba and Porto Rico.

History.—Cadiz represents the Sem. *Agadir, Gadir, or Gaddir* ("stronghold") of the Carthaginians, the Gr. *Gadeira*, and the Lat. *Gades*. Tradition ascribes its foundation to Phoenician merchants from Tyre, as early as 1100 B.C.; and in the 7th century it had already become the great mart of the west for amber and tin from the Cassiterides (q.v.). About 501 B.C. it was occupied by the Carthaginians, who made it their base for the conquest of southern Iberia, and in the 3rd century for the equipment of the armaments with which Hannibal undertook to destroy the power of Rome. But the loyalty of Gades, already weakened by trade rivalry with Carthage, gave way after the second Punic War. Its citizens welcomed the victorious Romans, and assisted them in turn to fit out an expedition against Carthage. Thenceforward, its rapidly-growing trade in dried fish and meat, and in all the produce of the fertile Baetis (Guadalquivir) valley, attracted many Greek settlers; while men of learning, such as Pytheas in the 4th century B.C., Polybius and Artemidorus of Ephesus in the 2nd, and Posidonius in the 1st, came to study the ebb and flow of its tides, unparalleled in the Mediterranean. C. Julius Caesar conferred the *civitas* of Rome on all its citizens in 49 B.C.; and, not long after L. Cornelius Balbus Minor built what was called the "New City," constructed the harbour which is now known as Puerto Real, and spanned the strait of Santi Petri with the bridge which unites the Isla de Leon with the mainland, and is now known as the Puente de Zuazo, after Juan Sanchez de Zuazo, who restored it in the 15th century. Under Augustus, when it was the residence of no fewer than 500 *equites*, a total only surpassed in Rome and Padua. Gades was made a *municipium* with the name of *Augusta Urbis Gaditana*, and its citizens ranked next to those of Rome. In the 1st century A.D. it was the birthplace or home of several famous authors, including Lucius Columella, poet and writer on husbandry; but it was more renowned for gaiety and luxury than for learning. Juvenal and Martial write of *Jocosae Gades*, "Cadiz the Joyous," as naturally as the modern Andalusian speaks of *Cádiz la Joyosa*; and throughout the Roman world its cookery and its dancing-girls were famous. In the 5th century, however, the overthrow of Roman dominion in Spain by the Visigoths involved Cadiz in destruction. A few fragments of masonry, submerged under the sea, are almost all that remains of the original city. Moorish rule over the port, which was renamed *Jairat-Kadis*, lasted from 711 until 1262, when Cadiz was captured, rebuilt and reoccupied by Alphonso X. of Castile. Its renewed prosperity dates from the discovery of America in 1492. As the headquarters of the Spanish treasure fleets, it soon recovered its position as the wealthiest port of western Europe, and consequently it was a favourite point of attack for the enemies of Spain. During the 16th century it repelled a series of raids by the Barbary corsairs; in 1587 all the shipping in its harbour was burned by the English squadron under Sir Francis Drake; in 1596 the fleet of the earl of Essex and Lord Charles Howard sacked the city, and destroyed forty merchant vessels and thirteen warships. This disaster necessitated the rebuilding of Cadiz on a new plan. Its recovered wealth tempted the duke of Buckingham to promote the fruitless expedition to Cadiz of 1626; thirty years later Admiral Blake blockaded the harbour in an endeavour to intercept the treasure fleet; and in 1702 another attack was made by the British under Sir George Rooke and the duke of Ormonde. During the 18th century the wealth of Cadiz became greater than ever; from 1720 to 1765, when it enjoyed a monopoly of the trade with Spanish America, the city

annually imported gold and silver to the value of about £5,000,000. With the closing years of the century, however, it entered upon a period of misfortune. From February 1797 to April 1798 it was blockaded by the British fleet, after the battle of Cape St Vincent; and in 1800 it was bombarded by Nelson. In 1808 the citizens captured a French squadron which was imprisoned by the British fleet in the inner bay. From February 1810 until the duke of Wellington raised the siege in August 1812, Cadiz resisted the French forces sent to capture it; and during these two years it served as the capital of all Spain which could escape annexation by Napoleon. Here, too, the Cortes met and promulgated the famous Liberal constitution of March 1812. To secure a renewal of this constitution, the citizens revolted in 1820; the revolution spread throughout Spain; the king, Ferdinand VII., was imprisoned at Cadiz, which again became the seat of the Cortes; and foreign intervention alone checked the movement towards reform. A French army, under the duc d'Angoulême, seized Cadiz in 1823, secured the release of Ferdinand and suppressed Liberalism. In 1868 the city was the centre of the revolution which effected the dethronement of Queen Isabella.

See *Sevilla y Cadiz, sus monumentos y artes, su naturaleza é historia*, an illustrated volume in the series "España," by P. de Madrazo (Barcelona, 1884); *Recuerdos Gaditanos*, a very full history of local affairs, by J. M. León y Domínguez (Cadiz, 1897); *Historia de Cadiz y de su provincia desde los remotos tiempos hasta 1824*, by A. de Castro (Cadiz, 1858); and *Descripción historico-artística de la catedral de Cadiz*, by J. de Urrutia (Cadiz, 1843).

CADMIUM (symbol Cd, atomic weight 112.4 (O=16)), a metallic element, showing a close relationship to zinc, with which it is very frequently associated. It was discovered in 1817 by F. Stromeyer in a sample of zinc carbonate from which a specimen of zinc oxide was obtained, having a yellow colour, although quite free from iron; Stromeyer showing that this coloration was due to the presence of the oxide of a new metal. Simultaneously Hermann, a German chemical manufacturer, discovered the new metal in a specimen of zinc oxide which had been thought to contain arsenic, since it gave a yellow precipitate, in acid solution, on the addition of sulphuretted hydrogen. This supposition was shown to be incorrect, and the nature of the new element was ascertained.

Cadmium does not occur naturally in the uncombined condition, and only one mineral is known which contains it in any appreciable quantity, namely, greenockite, or cadmium sulphide, found at Greenock and at Bisphopton in Scotland, and in Bohemia and Pennsylvania. It is, however, nearly always found associated with zinc blende, and with calamine, although only in small quantities.

The metal is usually obtained from the flue-dust (produced during the first three or four hours working of a zinc distillation) which is collected in the sheet iron cones or adapters of the zinc retorts. This is mixed with small coal, and when redistilled gives an enriched dust, and by repeating the process and distilling from cast iron retorts the metal is obtained. It can be purified by solution in hydrochloric acid and subsequent precipitation by metallic zinc.

Cadmium is a white metal, possessing a bluish tinge, and is capable of taking a high polish; on breaking, it shows a distinct fibrous fracture. By sublimation in a current of hydrogen it can be crystallized in the form of regular octahedra; it is slightly harder than tin, but is softer than zinc, and like tin, emits a crackling sound when bent. It is malleable and can be rolled out into sheets. The specific gravity of the metal is 8.564, this value being slightly increased after hammering; its specific heat is 0.0548 (R. Bunsen), it melts at 310-320° C. and boils between 763-772° C. (T. Carnelley), forming a deep yellow vapour. The cadmium molecule, as shown by determinations of the density of its vapour, is monatomic. The metal unites with the majority of the heavy metals to form alloys; some of these, the so-called fusible alloys, find a useful application from the fact that they possess a low melting-point. It also forms amalgams with mercury, and on this account has been employed in dentistry for the purpose of stopping (or filling)

teeth. The metal is quite permanent in dry air, but in moist air it becomes coated with a superficial layer of the oxide; it burns on heating to redness, forming a brown coloured oxide; and is readily soluble in mineral acids with formation of the corresponding salts. Cadmium vapour decomposes water at a red heat, with liberation of hydrogen, and formation of the oxide of the metal.

Cadmium oxide, CdO, is a brown powder of specific gravity 6.5, which can be prepared by heating the metal in air or in oxygen; or by ignition of the nitrate or carbonate; by heating the metal to a white heat in a current of oxygen it is obtained as a dark red crystalline sublimate. It does not melt at a white heat, and is easily reduced to the metal by heating in a current of hydrogen or with carbon. It is a basic oxide, dissolving readily in acids, with the formation of salts, somewhat analogous to those of zinc.

Cadmium hydroxide, Cd(OH)₂, is obtained as a white precipitate by adding potassium hydroxide to a solution of any soluble cadmium salt. It is decomposed by heat into the oxide and water, and is soluble in ammonia but not in excess of dilute potassium hydroxide; this latter property serves to distinguish it from zinc hydroxide.

The chloride, CdCl₂, bromide, CdBr₂, and iodide, CdI₂, are also known, cadmium iodide being sometimes used in photography, as it is one of the few iodides which are soluble in alcohol. Cadmium chloride and iodide have been shown to behave in an anomalous way in aqueous solution (W. Hittorf, *Pogg. Ann.*, 1859, 106, 513), probably owing to the formation of complex ions; the abnormal behaviour apparently diminishing as the solution becomes more and more dilute, until, at very high dilutions the salts are ionized in the normal manner.

Cadmium sulphate, CdSO₄, is known in several hydrated forms; being deposited, on spontaneous evaporation of a concentrated aqueous solution, in the form of large monosymmetric crystals of composition 3CdSO₄·8H₂O, whilst a boiling saturated solution, to which concentrated sulphuric acid has been added, deposits crystals of composition CdSO₄·H₂O. It is largely used for the purpose of making standard electric cells, such for example as the Weston cell.

Cadmium sulphide, CdS, occurs naturally as greenockite (*q.v.*), and can be artificially prepared by passing sulphuretted hydrogen through acid solutions of soluble cadmium salts, when it is precipitated as a pale yellow amorphous solid. It is used as a pigment (cadmium yellow), for it retains its colour in an atmosphere containing sulphuretted hydrogen; it melts at a white heat, and on cooling solidifies to a lemon-yellow micaceous mass.

Normal cadmium carbonates are unknown, a white precipitate of variable composition being obtained on the addition of solutions of the alkaline carbonates to soluble cadmium salts.

Cadmium nitrate, Cd(NO₃)₂·4H₂O, is a deliquescent salt, which may be obtained by dissolving either the metal, or its oxide or carbonate in dilute nitric acid. It crystallizes in needles and is soluble in alcohol.

Cadmium salts can be recognized by the brown incrustation which is formed when they are heated on charcoal in the oxidizing flame of the blowpipe; and also by the yellow precipitate formed when sulphuretted hydrogen is passed through their acidified solutions. This precipitate is insoluble in cold dilute acids, in ammonium sulphide, and in solutions of the caustic alkalis, a behaviour which distinguishes it from the yellow sulphides of arsenic and tin. Cadmium is estimated quantitatively by conversion into the oxide, being precipitated from boiling solutions by the addition of sodium carbonate, the carbonate thus formed passing into the oxide on ignition. It can also be determined as sulphide, by precipitation with sulphuretted hydrogen, the precipitated sulphide being dried at 100° C. and weighed.

The atomic weight of cadmium was found by O. W. Huntington (*Berichte*, 1882, 15, p. 80), from an analysis of the pure bromide, to be 111.9. H. N. Morse and H. C. Jones (*Amer. Chem. Journ.*, 1892, 14, p. 261) by conversion of cadmium into the oxalate and then into oxide, obtained values ranging from 111.981 to 112.05, whilst W. S. Lorimer and E. F. Smith (*Zeit. für anorg. Chem.*, 1891, 1, p. 364), by the electrolytic reduction of cadmium oxide in potassium cyanide solution, obtained as a mean value 112.055. The atomic weight of cadmium has been revised by G. P. Baxter and M. A. Hines (*Journ. Amer. Chem. Soc.*, 1905, 27, p. 222), by determinations of the ratio of cadmium chloride to silver chloride, and of the amount of silver required to precipitate cadmium chloride. The mean value obtained was 112.469 (*Ag* = 107.93). The mean value 112.467 was obtained by Baxter, Hines and Frevert (*ibid.*, 1906, 28, p. 770) by analysing cadmium bromide.

CADMUS, in Greek legend, son of Agenor, king of Phoenicia and brother of Europa. After his sister had been carried off by Zeus, he was sent out to find her. Unsuccessful in his search, he came in the course of his wanderings to Delphi, where he consulted the oracle. He was ordered to give up his quest and follow a cow which would meet him, and to build a town on the spot

where she should lie down exhausted. The cow met him in Phocis, and guided him to Boeotia, where he founded the city of Thebes. Intending to sacrifice the cow, he sent some of his companions to a neighbouring spring for water. They were slain by a dragon, which was in turn destroyed by Cadmus; and by the instructions of Athena he sown its teeth in the ground, from which there sprang a race of fierce armed men, called Sparti (sown). By throwing a stone among them Cadmus caused them to fall upon each other till only five survived, who assisted him to build the Cadmeia or citadel of Thebes and became the founders of the noblest families of that city (Ovid, *Metam.* iii. 1 ff.; Apollodorus iii. 4, 5). Cadmus, however, because of this bloodshed, had to do penance for eight years. At the expiration of this period the gods gave him to wife Harmonia (*q.v.*), daughter of Ares and Aphrodite, by whom he had a son Polydorus, and four daughters, Ino, Autonoe, Agave and Semele—a family which was overtaken by grievous misfortunes. At the marriage all the gods were present; Harmonia received as bridal gifts a peplos worked by Athena and a necklace made by Hephaestus. Cadmus is said to have finally retired with Harmonia to Illyria, where he became king. After death, he and his wife were changed into snakes, which watched the tomb while their souls were translated to the Elysian fields.

There is little doubt that Cadmus was originally a Boeotian, that is, a Greek hero. In later times the story of a Phoenician immigrant of that name became current, to whom was ascribed the introduction of the alphabet, the invention of agriculture and working in bronze and of civilization generally. But the name itself is Greek rather than Phoenician; and the fact that Hermes was worshipped in Samothrace under the name of Cadmus or Cadmilus seems to show that the Theban Cadmus was originally an ancestral Theban hero corresponding to the Samothracian. The name may mean "order," and be used to characterize one who introduces order and civilization.

The exhaustive article by O. Crusius in W. H. Roscher's *Lexikon der Mythologie* contains a list of modern authorities on the subject of Cadmus; see also O. Gruppe, *De Cadmi Fabula* (1891).

CADMUS OF MILETUS, according to some ancient authorities the oldest of the logographi (*q.v.*). Modern scholars, who accept this view, assign him to about 550 B.C.; others regard him as purely mythical. A confused notice in Suidas mentions three persons of the name: the first, the inventor of the alphabet; the second, the son of Pandion, "according to some" the first prose writer, a little later than Orpheus, author of a history of the *Foundation of Miletus* and of Ionia generally, in four books; the third, the son of Archelaus, of later date, author of a history of Attica in fourteen books, and of some poems of an erotic character. As Dionysius of Halicarnassus (*Judicium de Thucyde*, c. 23) distinctly states that the work current in his time under the name of Cadmus was a forgery, it is most probable that the two first are identical with the Phoenician Cadmus, who, as the reputed inventor of letters, was subsequently transformed into the Milesian and the author of an historical work. In this connexion it should be observed that the old Milesian nobles traced their descent back to the Phoenician or one of his companions. The text of the notice of the third Cadmus of Miletus in Suidas is unsatisfactory; and it is uncertain whether he is to be explained in the same way, or whether he was an historical personage, of whom all further record is lost.

See C. W. Müller, *Frag. Hist. Graec.* ii. 2-4; and O. Crusius in Roscher's *Lexikon der Mythologie* (article "Kadmoa," 90, 91).

CADOGAN, WILLIAM CADOGAN, 1st EARL (1675-1726), British soldier, was the son of Henry Cadogan, a Dublin barrister, and grandson of Major William Cadogan (1601-1661), governor of Trim. The family has been credited with a descent from Cadwgan, the old Welsh prince. Cadogan began his military career as a cornet of horse under William III. at the Boyne, and, with the regiment now known as the 5th (Royal Irish) Lancers, made the campaigns in the Low Countries. In the course of these years he attracted the notice of Marlborough. In 1701 Cadogan was employed by him as a staff officer in the complicated task of concentrating the grand army formed by contingents from

Guards). As quartermaster-general, he fell to his lot to organize the celebrated march of the allies to the Danube, which, as well as the return march with its heavy convoys, he managed with consummate skill. At the Schellenberg he was wounded and his horse shot under him, and at Blenheim he acted as Marlborough's chief of staff. Soon afterwards he was promoted brigadier-general, and in 1705 he led "Cadogan's Horse" at the forcing of the Brabant lines between Wange and Elissem, capturing four standards. He was present at Ramillies, and immediately afterwards was sent to take Antwerp, which he did without difficulty. Becoming major-general in 1706, he continued to perform the numerous duties of chief staff officer, quartermaster-general and colonel of cavalry, besides which he was throughout constantly employed in delicate diplomatic missions. In the course of the campaign of 1707, when leading a foraging expedition, he fell into the hands of the enemy but was soon exchanged. In 1708 he commanded the advanced guard of the army in the operations which culminated in the victory of Oudenarde, and in the same year he was with Webb at the action of Wynecdael. On the 1st of January 1709 he was made lieutenant-general. At the siege of Menin in this year occurred an incident which well illustrates his qualifications as a staff officer and diplomatist. Marlborough, riding with his staff close to the French, suddenly dropped his glove and told Cadogan to pick it up. This seemingly insolent command was carried out at once, and when Marlborough on the return to camp explained that he wished a battery to be erected on the spot, Cadogan informed him that he had already given orders to that effect. He was present at Malplaquet, and after the battle was sent off to form the siege of Mons, at which he was dangerously wounded. At the end of the year he received the appointment of lieutenant of the Tower, but he continued with the army in Flanders to the end of the war. His loyalty to the fallen Marlborough cost him, in 1712, his rank, positions and emoluments under the crown. George I. on his accession, however, reinstated Cadogan, and, amongst other appointments, made him lieutenant of the ordnance. In 1715, as British plenipotentiary, he signed the third Barrier Treaty between Great Britain, Holland and the emperor. His last campaign was the Jacobite insurrection of 1715-1716. At first as Argyle's subordinate (see Coxe, *Memoirs of Marlborough*, cap. cxiv.), and later as commander-in-chief, General Cadogan by his firm, energetic and skillful handling of his task restored quiet and order in Scotland. Up to the death of Marlborough he was continually employed in diplomatic posts of special trust, and in 1718 he was made Earl Cadogan, Viscount Caversham and Baron Cadogan of Oakley. In 1722 he succeeded his old chief as head of the army and master-general of the ordnance, becoming at the same time colonel of the 1st or Grenadier Guards. He sat in five successive parliaments as member for Woodstock. He died at Kensington in 1726, leaving two daughters, one of whom married the second duke of Richmond and the other the second son of William earl of Portland.

Readers of *Esmond* will have formed a very unfavourable estimate of Cadogan, and it should be remembered that Thackeray's hero was the friend and supporter of the opposition and General Webb. As a soldier, Cadogan was one of the best staff officers in the annals of the British army, and in command of detachments, and also as a commander-in-chief, he showed himself to be an able, careful and withal dashing leader.

He was succeeded, by special remainder, in the barony by his brother, General Charles Cadogan (1691-1776), who married the daughter of Sir Hans Sloane, thus beginning the association of the family with Chelsea, and died in 1776, being succeeded in turn by his son Charles Sloane (1728-1807), who in the year 1800 was created Viscount Chelsea and Earl Cadogan. His descendant George Henry, 5th Earl Cadogan (b. 1840), was lord privy seal from 1886 to 1892, and lord-lieutenant of Ireland from 1895 to 1902.

1793 he organized a rebellion in the Morbihan against the revolutionary government. It was quickly suppressed and he thereupon joined the army of the revolted Vendéans, taking part in the battles of Le Mans and of Savenay in December 1793. Returning to Morbihan, he was arrested, and imprisoned at Brest. He succeeded, however, in escaping, and began again the struggle against the Revolution. In spite of the defeat of his party, and of the fact that he was forced several times to take refuge in England, Cadoudal did not cease both to wage war and to conspire in favour of the royalist pretenders. He refused to come to any understanding with the government, although offers were made to him by Bonaparte, who admired his skill and his obstinate energy. From 1800 it was impossible for Cadoudal to continue to wage open war, so he took altogether to plotting. He was indirectly concerned in the attempt made by Saint Régent in the rue Sainte Nicaise on the life of the First Consul, in December 1800, and fled to England again. In 1803 he returned to France to undertake a new attempt against Bonaparte. Though watched for by the police, he succeeded in eluding them for six months, but was at length arrested. Found guilty and condemned to death, he refused to ask for pardon and was executed in Paris on the 10th of June 1804, along with eleven of his companions. He is often called simply Georges.

See *Procès de Georges, Moreau et Pichegru* (Paris, 1804, 8 vols 8vo); the *Mémoires* of Bourrienne, of Hyde de Neuville and of Rohu; Lenotre, *Tournebut* (on the arrest); Lejean, *Biographie bretonne*; and the bibliography to the article *Vendée*.

CADRE (Fr. for a frame, from the Lat. *quadrum*, a square), a framework or skeleton, particularly the permanent establishment of a military corps, regiment, &c. which can be expanded on emergency.

CADUCEUS (the Lat. adaptation of the Doric Gr. *καδούκειον*, Attic *καδουκίον*, a herald's wand), the staff used by the messengers of the gods, and especially by Hermes as conductor of the souls of the dead to the world below. The caduceus of Hermes, which was given him by Apollo in exchange for the lyre, was a magic wand which exercised influence over the living and the dead, bestowed wealth and prosperity and turned everything it touched into gold. In its oldest form it was a rod ending in two prongs twined into a knot (probably an olive branch with two shoots, adorned with ribbons or garlands), for which, later, two serpents, with heads meeting at the top, were substituted. The mythologists explained this by the story of Hermes finding two serpents thus knotted together while fighting; he separated them with his wand, which, crowned by the serpents, became the symbol of the settlement of quarrels (Thucydides i. 53; Macrobius, *Sat.* i. 19; Hyginus, *Poet. Astron.* ii. 7). A pair of wings was sometimes attached to the top of the staff, in token of the speed of Hermes as a messenger. In historical times the caduceus was the attribute of Hermes as the god of commerce and peace, and among the Greeks it was the distinctive mark of heralds and ambassadors, whose persons it rendered inviolable. The caduceus itself was not used by the Romans, but the derivative *caduceator* occurs in the sense of a peace commissioner.

See L. Preller, "Der Hermesstab" in *Philologus*, i. (1846); O. A. Hoffmann, *Hermes und Kerykeion* (1890), who argues that Hermes is a male lunar divinity and his staff the special attribute of Aphrodite-Astarte.

CADUCOUS (Lat. *caducus*), a botanical term for "falling early," as the sepals of a poppy, before the petals expand.

CAECILIA. This name was given by Linnaeus to the blind, or nearly blind, worm-like Batrachians which were formerly associated with the snakes and are now classed as an order under the names of *Apoda*, *Peromela* or *Gymnophiona*. The type of the genus *Caecilia* is *Caecilia tentaculata*, a moderately slender species, not unlike a huge earth-worm, growing to 2 ft. in length with a diameter of three-quarters of an inch. It is one of the largest species of the order. Other species of the same genus are very slender in form, as for instance *Caecilia gracilis*.

which with a length of $2\frac{1}{2}$ ft. has a diameter of only a quarter of an inch. One of the most remarkable characters of the genus *Caecilia*, which it shares with about two-thirds of the known genera of the order, is the presence of thin, cycloid, imbricate scales imbedded in the skin, a character only to be detected by raising the epidermis near the dermal folds, which more or less completely encircle the body. This feature, unique among living Batrachians, is probably directly inherited from the scaly *Stegocephalia*, a view which is further strengthened by the similarity of structure of these scales in both groups, which the histological investigations of H. Credner have revealed. The skull is well ossified and contains a greater number of bones than occur in any other living Batrachian. There is therefore strong reason for tracing the Caecilians directly from the *Stegocephalia*, as was the view of T. H. Huxley and of R. Wiedersheim, since supported by H. Gadow and by J. S. Kingsley. E. D. Cope had advocated the abolition of the order Apoda and the incorporation of the Caecilians among the Urodela or Caudata in the vicinity of the Amphiumidae, of which he regarded them as further degraded descendants; and this opinion, which was supported by very feeble and partly erroneous arguments, has unfortunately received the support of the two great authorities, P. and F. Sarasin, to whom we are indebted for our first information on the breeding habits and development of these Batrachians.

The knowledge of species of Caecilians has made rapid progress, and we are now acquainted with about fifty, which are referred to twenty-one genera. The principal characters on which these genera are founded reside in the presence or absence of scales, the presence or absence of eyes, the presence of one or of two series of teeth in the lower jaw, the structure of the tentacle (representing the so-called "balancers" of Urodele larvae) on the side of the snout, and the presence or absence of a vacancy between the parietal and squamosal bones of the skull. Of these twenty-one genera six are peculiar to tropical Africa, one to the Seychelles, four to south-eastern Asia, eight to Central and South America, one occurs in both continental Africa and the Seychelles, and one is common to Africa and South America.

These Batrachians are found in damp situations, usually in soft mud. The complete development of *Ichthyophis glutinosus* has been observed in Ceylon by P. and F. Sarasin. The eggs, forming a rosary-like string, are very large, and deposited in a burrow near the water. The female protects them by coiling herself round the egg-mass, which the young do not leave till after the loss of the very large external gills (one on each side); they then lead an aquatic life, and are provided with an opening, or spiraculum, on each side of the neck. In these larvae the head is fish-like, provided with much-developed labial lobes, with the eyes much more distinct than in the perfect animal; the tail, which is quite rudimentary in all Caecilians, is very distinct, strongly compressed, and bordered above and beneath by a dermal fold.

In *Hypogeophis*, a Caecilian from the Seychelles studied by A. Brauer, the development resembles that of *Ichthyophis*, but there is no aquatic larval stage. The young leaves the egg in the perfect condition, and at once leads a terrestrial life like its parents. In accordance with this abbreviated development, the caudal membranous crest does not exist, and the branchial aperture closes as soon as the external gills disappear.

In the South American *Typhlonectes*, and in the *Dermophis* from the Island of St Thomé, West Africa, the young are brought forth alive, in the former as larvae with external gills, and in the latter in the perfect air-breathing condition.

REFERENCES.—R. Wiedersheim, *Anatomie der Gymnophionen* (Jena, 1879), 4to; G. A. Boulenger, "Synopsis of the Genera and Species," *P.Z.S.*, 1895, p. 401; R. Greeff, "Über Siphonops thomensis," *Sieb. Ges. Naturw.* (Marburg, 1884), p. 15; P. and F. Sarasin, *Naturwissenschaftliche Forschungen auf Ceylon*, ii. (Wiesbaden, 1887-1890), 4to; A. Brauer, "Beiträge zur Kenntnis der Entwicklungsgeschichte und der Anatomie der Gymnophionen," *Zool. Jahrb. Ana.*, x., 1897, p. 389, xii., 1898, p. 477, and xvii., 1904, Suppl. p. 381; E. A. Goldi, "Entwicklung von Siphonops annulatus," *Zool. Jahrb. Syst.*, xii., 1899, p. 170; J. S. Kingsley, "The systematic position of the Caecilians," *Trans. Coll. Stud.*, vii., 1902, p. 323.

(G. A. B.)

CAECILIA, VIA, an ancient highroad of Italy, which diverged from the Via Salaria at the 35th m. from Rome, and ran by Amitemum to the Adriatic coast, passing probably by Hadria. A branch ran to Interamna Praetuttorum (Teramo) and thence probably to the sea at Castrum Novum (Giulianova), a distance of about 151 m. from Rome. It was probably constructed by L. Caecilius Metellus Diadematius (consul in 117 B.C.).

See C. Hülsen in *Notizie degli Scavi* (1896), 87 seq. N. Persichetti in *Römische Mitteilungen* (1898), 193 seq.; (1902), 277 seq.

CAECILIUS, of Calacte (Καλακτῆ) in Sicily, Greek rhetorician, flourished at Rome during the reign of Augustus. Originally called Archagathus, he took the name of Caecilius from his patron, one of the Metelli. According to Suidas, he was by birth a Jew. Next to Dionysius of Halicarnassus, he was the most important critic and rhetorician of the Augustan age. Only fragments are extant of his numerous and important works, among which may be mentioned: *On the Style of the Ten Orators* (including their lives and a critical examination of their works), the basis of the pseudo-Plutarchian treatise of the same name, in which Caecilius is frequently referred to; *On the Sublime*, attacked by (?) Longinus in his essay on the same subject (see L. Martens, *De Libello Περὶ ὑψους*, 1877); *History of the Servile Wars*, or slave risings in Sicily, the local interest of which would naturally appeal to the author; *On Rhetoric and Rhetorical Figures*; an *Alphabetical Selection of Phrases*, intended to serve as a guide to the acquirement of a pure Attic style—the first example of an Atticist lexicon, mentioned by Suidas in the preface to his lexicon as one of his authorities; *Against the Phrygians*, probably an attack on the florid style of the Asiatic school of rhetoric.

The fragments have been collected and edited by T. Burckhardt (1863), and E. Ofenloch (1907); some in C. W. Müller, *Fragmenta Historicorum Graecorum*, iii.; C. Burman's *Jahresbericht . . . der klassischen Altertumswissenschaft*, xxiii. (1896), contains full notices of recent works on Caecilius, by C. Hammer; F. Blass, *Griechische Beredsamkeit von Alexander bis auf Augustus* (1865), treats of Dionysius of Halicarnassus and Caecilius together; see also J. Brzoska in Pauly-Wisowa, *Realencyclopädie* (1897).

CAECILIUS STATIUS, or **STATIUS CAECILIUS**, Roman comic poet, contemporary and intimate friend of Ennius, died in 168 (or 166) B.C. He was born in the territory of the Insubrian Gauls, and was probably taken as a prisoner to Rome (c. 200), during the great Gallic war. Originally a slave, he assumed the name of Caecilius from his patron, probably one of the Metelli. He supported himself by adapting Greek plays for the Roman stage from the new comedy writers, especially Menander. If the statement in the life of Terence by Suetonius is correct and the reading sound, Caecilius's judgment was so esteemed that he was ordered to hear Terence's *Andria* (exhibited 166 B.C.) read and to pronounce an opinion upon it. After several failures Caecilius gained a high reputation. Volcacius Sedigitus, the dramatic critic, places him first amongst the comic poets; Varro credits him with pathos and skill in the construction of his plots; Horace (*Epistles*, ii. 1. 50) contrasts his dignity with the art of Terence. Quintilian (*Instit. Orat.*, x. 1. 99) speaks somewhat disparagingly of him, and Cicero, although he admits with some hesitation that Caecilius may have been the chief of the comic poets (*De Optimo Genere Oratorum*, 1), considers him inferior to Terence in style and Latinity (*Ad Alt.* vii. 3), as was only natural, considering his foreign extraction. The fact that his plays could be referred to by name alone without any indication of the author (Cicero, *De Finibus*, ii. 7) is sufficient proof of their widespread popularity. Caecilius holds a place between Plautus and Terence in his treatment of the Greek originals; he did not, like Plautus, confound things Greek and Roman, nor, like Terence, eliminate everything that could not be romanized.

The fragments of his plays are chiefly preserved in Aulus Gellius, who cites several passages from the *Plocium* (necklace) together with the original Greek of Menander. The translation which is diffuse and by no means close, fails to reproduce the spirit of the original. Fragments in Ribbeck, *Scenicae Romanorum Poets Fragmenta* (1896); see also W. S. Teuffel, *Caecilius Statius*, 4c. (1858); Mommsen, *Hist. of Rome* (Eng. tr.), bk. iii. ch. 14; F. Skutsch in Pauly-Wisowa, *Realencyclopädie* (1897).

CAECINA, the name of a distinguished Etruscan family of Volterrae. Graves have been discovered belonging to the family, whose name is still preserved in the river and hamlet of Cecina.

AULUS CAECINA, son of Aulus Caecina who was defended by Cicero (69 B.C.) in a speech still extant, took the side of Pompey in the civil wars, and published a violent tirade against Caesar, for which he was banished. He recanted in a work called *Querelae*, and by the intercession of his friends, above all, of Cicero, obtained pardon from Caesar. Caecina was regarded as an important authority on the Etruscan system of divination (*Etrusca Disciplina*), which he endeavoured to place on a scientific footing by harmonizing its theories with the doctrines of the Stoics. Considerable fragments of his work (dealing with lightning) are to be found in Seneca (*Naturales Quaestiones*, ii. 31-49). Caecina was on intimate terms with Cicero, who speaks of him as a gifted and eloquent man and was no doubt considerably indebted to him in his own treatise *De Divinatione*. Some of their correspondence is preserved in Cicero's letters (*Ad Fam.* vi. 5-8; see also ix. and xiii. 66).

AULUS CAECINA ALIENUS, Roman general, was quaestor of Baetica in Spain (A.D. 68). On the death of Nero, he attached himself to Galba, who appointed him to the command of a legion in upper Germany. Having been prosecuted for embezzling public money, Caecina went over to Vitellius, who sent him with a large army into Italy. Caecina crossed the Alps, but was defeated near Cremona by Suetonius Paulinus, the chief general of Otho. Subsequently, in conjunction with Fabius Valens, Caecina defeated Otho at the decisive battle of Bedriacum (Betracium). The incapacity of Vitellius tempted Vespasian to take up arms against him. Caecina, who had been entrusted with the repression of the revolt, turned traitor, and tried to persuade his army to go over to Vespasian, but was thrown into chains by the soldiers. After the overthrow of Vitellius, he was released, and taken into favour by the new emperor. But he could not remain loyal to any one. In 79 he was implicated in a conspiracy against Vespasian, and was put to death by order of Titus. Caecina is described by Tacitus as a man of handsome presence and boundless ambition, a gifted orator and a great favourite with the soldiers.

Tacitus, *Historiae*, i. 53, 61, 67-70, ii. 20-25, 41-44, iii. 13; Dio Cassius lrv. 10-14, lxxvi. 16; Plutarch, *Otho*, 7; Suetonius, *Titus*, 6; Zonaras xi. 17.

CÆDMON, the earliest English Christian poet. His story, and even his very name, are known to us only from Bæda (*Hist. Eccl.* iv. 24). He was, according to Bæda (see BÆDA), a herdsman, who received a divine call to poetry by means of a dream. One night, having quitted a festive company because, from want of skill, he could not comply with the demand made of each guest in turn to sing to the harp, he sought his bed and fell asleep. He dreamed that there appeared to him a stranger, who addressed him by his name, and commanded him to sing of "the beginning of created things." He pleaded inability, but the stranger insisted, and he was compelled to obey. He found himself uttering "verses which he had never heard." Of Cædmun's song Bæda gives a prose paraphrase, which may be literally rendered as follows:—"Now must we praise the author of the heavenly kingdom, the Creator's power and counsel, the deeds of the Father of glory: how He, the eternal God, was the author of all marvels—He, who first gave to the sons of men the heaven for a roof, and then, Almighty Guardian of mankind, created the earth." Bæda explains that his version represents the sense only, not the arrangement of the words, because no poetry, however excellent, can be rendered into another language, without the loss of its beauty of expression. When Cædmun awoke he remembered the verses that he had sung and added to them others. He related his dream to the farm bailiff under whom he worked, and was conducted by him to the neighbouring monastery at Streaneshalch (now called Whitby). The abbess Hild and her monks recognized that the illiterate herdsman had received a gift from heaven, and, in order to test his powers, proposed to him that he should try to render into verse a portion of sacred history which they explained to him. On

the following morning he returned having fulfilled his task. At the request of the abbess he became an inmate of the monastery. Throughout the remainder of his life his more learned brethren from time to time expounded to him the events of Scripture history and the doctrines of the faith, and all that he heard from them he reproduced in beautiful poetry. "He sang of the creation of the world, of the origin of mankind and of all the history of Genesis, of the exodus of Israel from Egypt and their entrance into the Promised Land, of many other incidents of Scripture history, of the Lord's incarnation, passion, resurrection and ascension, of the coming of the Holy Ghost and the teaching of the apostles. He also made many songs of the terrors of the coming judgment, of the horrors of hell and the sweetness of heaven; and of the mercies and the judgments of God." All his poetry was on sacred themes, and its unvarying aim was to turn men from sin to righteousness and the love of God. Although many amongst the Anglo-Sax had, following his example, essayed to compose religious poetry, none of them, in Bæda's opinion, had approached the excellence of Cædmun's songs.

Bæda's account of Cædmun's deathbed has often been quoted, and is of singular beauty. It is commonly stated that he died in 680, in the same year as the abbess Hild, but for this there is no authority. All that we know of his date is that his dream took place during the period (658-680) in which Hild was abbess of Streaneshalch, and that he must have died some considerable time before Bæda finished his history in 731.

The hymn said to have been composed by Cædmun in his dream is extant in its original language. A copy of it, in the poet's own Northumbrian dialect, and in a handwriting of the 8th century, appears on a blank page of the Moore MS. of Bæda's History; and five other Latin MSS. of Bæda have the poem (but transliterated into a more southern dialect) as a marginal note. In the old English version of Bæda, ascribed to King Alfred, and certainly made by his command if not by himself, it is given in the text. Probably the Latin MS. used by the translator was one that contained this addition. It was formerly maintained by some scholars that the extant Old English verses are not Bæda's original, but a mere retranslation from his Latin prose version. The argument was that they correspond too closely with the Latin; Bæda's words, "hic est sensus, non autem ordo ipse verborum," being taken to mean that he had given, not a literal translation, but only a free paraphrase. But the form of the sentences in Bæda's prose shows a close adherence to the parallelistic structure of Old English verse, and the alliterating words in the poem are in nearly every case the most obvious and almost the inevitable equivalents of those used by Bæda. The sentence quoted above¹ can therefore have been meant only as an apology for the absence of those poetic graces that necessarily disappear in translations into another tongue. Even on the assumption that the existing verses are a retranslation, it would still be certain that they differ very slightly from what the original must have been. It is of course possible to hold that the story of the dream is pure fiction, and that the lines which Bæda translated were not Cædmun's at all. But there is really nothing to justify this extreme of scepticism. As the hymn is said to have been Cædmun's first essay in verse, its lack of poetic merit is rather an argument for its genuineness than against it. Whether Bæda's narrative be historical or not—and it involves nothing either miraculous or essentially improbable—there is no reason to doubt that the nine lines of the Moore MS. are Cædmun's composition.

This poor fragment is all that can with confidence be affirmed to remain of the voluminous works of the man whom Bæda regarded as the greatest of vernacular religious poets. It is true that for two centuries and a half a considerable body of verse has been currently known by his name; but among modern scholars the use of the customary designation is merely a matter of convenience, and does not imply any belief in the correctness of the attribution. The so-called Cædmun poems are contained

¹ It is a significant fact that the Alfridian version, instead of translating this sentence, introduces the verses with the words, "This is the order of the words."

in a MS. written about A.D. 1000, which was given in 1651 by Archbishop Usher to the famous scholar Francis Junius, and is now in the Bodleian library. They consist of paraphrases of parts of Genesis, Exodus and Daniel, and three separate poems, the first on the lamentations of the fallen angels, the second on the "Harrowing of Hell," the resurrection, ascension and second coming of Christ, and the third (a mere fragment) on the temptation. The subjects correspond so well with those of Cædmon's poetry as described by Bæda that it is not surprising that Junius, in his edition, published in 1655, unhesitatingly attributed the poems to him. The ascription was rejected in 1684 by G. Hickes, whose chief argument, based on the character of the language, is now known to be fallacious, as most of the poetry that has come down to us in the West Saxon dialect is certainly of Northumbrian origin. Since, however, we learn from Bæda that already in his time Cædmon had had many imitators, the abstract probability is rather unfavourable than otherwise to the assumption that a collection of poems contained in a late 10th century MS. contains any of his work. Modern criticism has shown conclusively that the poetry of the "Cædmon MS." cannot be all by one author. Some portions of it are plainly the work of a scholar who wrote with his Latin Bible before him. It is possible that some of the rest may be the composition of the Northumbrian herdsman; but in the absence of any authenticated example of the poet's work to serve as a basis of comparison, the internal evidence can afford no ground for an affirmative conclusion. On the other hand, the mere unlikeness of any particular passage to the nine lines of the *Hymn* is obviously no reason for denying that it may have been by the same author.

The *Genesis* contains a long passage (ll. 235-851) on the fall of the angels and the temptation of our first parents, which differs markedly in style and metre from the rest. This passage, which begins in the middle of a sentence (two leaves of the MS. having been lost) is one of the finest in all Old English poetry. In 1877 Professor E. Sievers argued, on linguistic grounds, that it was a translation, with some original insertions, from a lost poem in Old Saxon, probably by the author of the *Heliland*. Sievers's conclusions were brilliantly confirmed in 1894 by the discovery in the Vatican library of a MS. containing 62 lines of the *Heliland* and three fragments of an old Saxon poem on the story of Genesis. The first of these fragments includes the original of 28 lines of the interpolated passage of the Old English *Genesis*. The Old Saxon Biblical poetry belongs to the middle of the 9th century; the Old English translation of a portion of it is consequently later than this.

As the *Genesis* begins with a line identical in meaning, though not in wording, with the opening of Cædmon's *Hymn*, we may perhaps infer that the writer knew and used Cædmon's genuine poems. Some of the more poetical passages may possibly echo Cædmon's expressions; but when, after treating of the creation of the angels and the revolt of Lucifer, the paraphrast comes to the Biblical part of the story, he follows the sacred text with servile fidelity, omitting no detail, however prosaic. The ages of the antediluvian patriarchs, for instance, are accurately rendered into verse. In all probability the *Genesis* is of Northumbrian origin. The names assigned to the wives of Noah and his three sons (Phercoba, Olla, Olliana, Olliuani¹) have been traced to an Irish source, and this fact seems to point to the influence of the Irish missionaries in Northumbria.

The *Exodus* is a fine poem, strangely unlike anything else in Old English literature. It is full of martial spirit, yet makes no use of the phrases of the heathen epic, which Cynewulf and other Christian poets were accustomed to borrow freely, often with little appropriateness. The condensation of the style and the peculiar vocabulary make the *Exodus* somewhat obscure in many places. It is probably of southern origin, and can hardly be supposed to be even an imitation of Cædmon.

The *Daniel* is often unjustly depreciated. It is not a great

poem but the narration is lucid and interesting. The author has borrowed some 70 lines from the beginning of a poetical rendering of the Prayer of Azarias and the Song of the Three Children, of which there is a copy in the Exeter Book. The borrowed portion ends with verse 3 of the canticle, the remainder of which follows in a version for the most part independent, though containing here and there a line from *Azarias*. Except in inserting the prayer and the *Benedicite*, the paraphrast draws only from the canonical part of the book of Daniel. The poem is obviously the work of a scholar, though the Bible is the only source used.

The three other poems, designated as "Book II" in the Junius MS., are characterized by considerable imaginative power and vigour of expression, but they show an absence of literary culture and are somewhat rambling, full of repetitions and generally lacking in finish. They abound in passages of fervid religious exhortation. On the whole, both their merits and their defects are such as we should expect to find in the work of the poet celebrated by Bæda, and it seems possible, though hardly more than possible, that we have in these pieces a comparatively little altered specimen of Cædmon's compositions.

Of poems not included in the Junius MS., the *Dream of the Rood* (see CYNWULF) is the only one that has with any plausibility been ascribed to Cædmon. It was affirmed by Professor G. Stephens that the Ruthwell Cross, on which a portion of the poem is inscribed in runes, bore on its top-stone the name "Cædmon";² but, according to Professor W. Victor, the traces of runes that are still visible exclude all possibility of this reading. The poem is certainly Northumbrian and earlier than the date of Cynewulf. It would be impossible to prove that Cædmon was not the author, though the production of such a work by the herdsman of Streanshalch would certainly deserve to rank among the miracles of genius.

Certain similarities between passages in *Paradise Lost* and parts of the translation from Old Saxon interpolated in the Old English *Genesis* have given occasion to the suggestion that some scholar may have talked to Milton about the poetry published by Junius in 1655, and that the poet may thus have gained some hints which he used in his great work. The parallels, however, though very interesting, are only such as might be expected to occur between two poets of kindred genius working on what was essentially the same body of traditional material.

The name Cædmon (in the MSS. of the Old English version of Bæda written *Cædmon*, *Cædmann*) is not explicable by means of Old English; the statement that it means "boatman" is founded on the corrupt gloss *liburnam*, *cael*, where *cael* is an editorial misreading for *caol*. It is most probably the British *Cadman*, intermediate between the Old Celtic *Catmanus* and the modern Welsh *Cadfan*. Possibly the poet may have been of British descent, though the inference is not certain, as British names may sometimes have been given to English children. The name Caedwalla or Ceadwalla was borne by a British king mentioned by Bæda and by a king of the West Saxons. The initial element *Caed*—or *Cead* (probably adopted from British names in which it represents *cau*, war) appears combined with an Old English terminal element in the name *Caedbaed* (cp., however, the Irish name Cathbad), and hypocoristic forms of names containing it were borne by the English saints Cadda (commonly known as St Chad) and his brother Cedd, called *Ceadwealla* in one MS. of the *Old English Martyrology*. A Cædmon witnesses a Buckinghamshire charter of about A.D. 948.

The older editions of the so-called "Cædmon's Paraphrase" by F. Junius (1655); B. Thorpe (1832), with an English translation; K. W. Bouterwek (1851-1854); C. W. M. Grein in his *Bibliothek der angelsächsischen Poesie* (1857) are superseded, so far as the text is concerned, by R. Wülker's re-edition of Grein's *Bibliothek*, Bd. ii. (1895). This work contains also the texts of the *Hymn* and the *Dream of the Rood*. The pictorial illustrations of the Junius MS. were published in 1833 by Sir H. Ellis.

¹ Stephens read the inscription on the top-stone as *Cædmon wa sawepo*, which he rendered "Cædmon made me." But these words are mere jargon, not belonging to any known or possible Old English dialect.

² The invention of these names was perhaps suggested by *Pericope Oolae et Ooliba*, which may have been a current title for the 23rd chapter of Ezekiel.

CAELIA, the name of two ancient cities in Italy. (1) In Apulia (mod. *Ceglie di Bari*) on the Via Traiana, 5 m. S. of Barium. Coins found here bearing the inscription *Kaivlvav* prove that it was once an independent town. Discoveries of ruins and tombs have also been made. (2) In Calabria (mod. *Ceglie Messapica*) 25 m. W. of Brundisium, and 991 ft. above sea-level. It was in early times a place of some importance, as is indicated by the remains of a prehistoric *enceinte* and by the discovery of several Messapian inscriptions.

See Ch. Hülsen in Pauly-Wissowa, *Realencyclopädie*, iii. 1252.

CAEN, a city of north-western France, capital of the département of Calvados, 7½ m. from the English Channel and 149 m. W.N.W. of Paris on the Western railway to Cherbourg. Pop. (1906) 36,247. It is situated in the valley and on the left bank of the Orne, the right bank of which is occupied by the suburb of Vaucelles with the station of the Western railway. To the south-west of Caen, the Orne is joined by the Odon, arms of which water the "Prairie," a fine plain on which a well-known race-course is laid out. Its wide streets, of which the most important is the rue St Jean, shady boulevards, and public gardens enhance the attraction which the town derives from an abundance of fine churches and old houses. Hardly any remains of its once extensive ramparts and towers are now to be seen; but the castle, founded by William the Conqueror and completed by Henry I., is still employed as barracks, though in a greatly altered condition. St Pierre, the most beautiful church in Caen, stands at the northern extremity of the rue St Jean, in the centre of the town. In the main, its architecture is Gothic, but the choir and the apsidal chapels, with their elaborate interior and exterior decoration, are of Renaissance workmanship. The graceful tower, which rises beside the southern portal to a height of 255 ft., belongs to the early 14th century. The church of St Étienne, or l'Abbaye-aux-Hommes, in the west of the town, is an important specimen of Romanesque architecture, dating from about 1070, when it was founded by William the Conqueror. It is unfortunately hemmed in by other buildings, so that a comprehensive view of it is not to be obtained. The whole building, and especially the west façade, which is flanked by two towers with lofty spires, is characterized by its simplicity. The choir, which is one of the earliest examples of the Norman Gothic style, dates from the early 13th century. In 1562 the Protestants did great damage to the building, which was skillfully restored in the early 17th century. A marble slab marks the former resting-place of William the Conqueror. The abbey-buildings were rebuilt in the 17th and 18th centuries, and now shelter the lycée. Matilda, wife of the Conqueror, was the foundress of the church of La Trinité or l'Abbaye-aux-Dames, which is of the same date as St Étienne. Two square unfinished towers flank the western entrance, and another rises above the transept. Queen Matilda is interred in the choir, and a fine crypt beneath it contains the remains of former abbesses. The buildings of the nunnery, reconstructed in the early 18th century, now serve as a hospital. Other interesting old churches are those of St Sauveur, St Michel de Vaucelles, St Jean, St Gilles, Notre-Dame de la Gloriette, St Étienne le Vieux and St Nicolas, the last two now secularized. Caen possesses many old timber houses and stone mansions, in one of which, the hôtel d'Ecoville (c. 1530), the exchange and the tribunal of commerce are established. The hôtel de Than, also of the 16th century, is remarkable for its graceful dormer-windows. The Maison des Gens d'Armes (15th century), in the eastern outskirts of the town, has a massive tower adorned with medallions and surmounted by two figures of armed men. The monuments at Caen include one to the natives of Calvados killed in 1870 and 1871 and one to the lawyer J. C. F. Demolombe, together with statues of Louis XIV, Élie de Beaumont, Pierre Simon, marquis de Laplace, D. F. E. Auber and François de Malherbe, the two last natives of the town. Caen is the seat of a court of appeal, of a court of assizes and of a prefect. It is the centre of an academy and has a university with faculties of law, science and letters and a preparatory school of medicine and pharmacy; there are also a lycée, training colleges, schools of art and music, and two large

hospitals. The other chief public institutions are tribunals of first instance and commerce, an exchange, a chamber of commerce and a branch of the Bank of France. The hôtel-de-ville contains the library, with more than 100,000 volumes and the art museum with a fine collection of paintings. The town is the seat of several learned societies including the Société des Antiquaires, which has a rich museum of antiquities. Caen, despite a diversity of manufactures, is commercial rather than industrial. Its trade is due to its position in the agricultural and horse-breeding district known as the "Campagne de Caen" and to its proximity to the iron mines of the Orne valley, and to manufacturing towns such as Falaise, Le Mans, &c. In the south-east of the town there is a floating basin lined with quays and connected with the Orne and with the canal which debouches into the sea at Ouistreham 9 m. to the N.N.E. The port, which also includes a portion of the river-bed, communicates with Havre and Newhaven by a regular line of steamers; it has a considerable fishing population. In 1905 the number of vessels entered was 563 with a tonnage of 190,190. English coal is foremost among the imports, which also include timber and grain, while iron ore, Caen stone,¹ butter and eggs and fruit are among the exports. Important horse and cattle fairs are held in the town. The industries of Caen include timber-sawing, metal-founding and machine-construction, cloth-weaving, lace-making, the manufacture of leather and gloves, and of oil from the colza grown in the district, furniture and other wooden goods and chemical products.

Though Caen is not a town of great antiquity, the date of its foundation is unknown. It existed as early as the 9th century, and when, in 912, Neustria was ceded to the Normans by Charles the Simple, it was a large and important place. Under the dukes of Normandy, and particularly under William the Conqueror, it rapidly increased. It became the capital of lower Normandy, and in 1346 was besieged and taken by Edward III. of England. It was again taken by the English in 1417, and was retained by them till 1450, when it capitulated to the French. The university was founded in 1436 by Henry VI. of England. During the Wars of Religion, Caen embraced the reform; in the succeeding century its prosperity was shattered by the revocation of the edict of Nantes (1685). In 1793 the city was the focus of the Girondist movement against the Convention.

See G. Mancel et C. Woinez, *Hist. de la ville de Caen et de ses progrès* (Caen, 1836); B. Pont, *Hist. de la ville de Caen, ses origines* (Caen, 1866); E. de R. de Beaurepaire, *Caen illustré: son histoire, ses monuments* (Caen, 1896).

CAEPIO, QUINTUS SERVILIUS, Roman general, consul 106 B.C. During his year of office, he brought forward a law by which the jurymen were again to be chosen from the senators instead of the equites (Tacitus, *Ann.* xii. 60). As governor of Gallia Narbonensis, he plundered the temple of the Celtic Apollo at Tolosa (Toulouse), which had joined the Cimbri. In 105, Caepio suffered a crushing defeat from the Cimbri at Arausio (Orange) on the Rhone, which was looked upon as a punishment for his sacrilege; hence the proverb *Arausio Tolosanum habet*, of an act involving disastrous consequences. In the same year he was deprived of his proconsulship and his property confiscated; subsequently (the chronology is obscure, see Mommsen, *History of Rome*, bk. iv. ch. 5) he was expelled from the senate, accused by the tribune Norbanus of embezzlement and misconduct during the war, condemned and imprisoned. He either died during his confinement or escaped to Silyria.

Livy, *Epit.* 67; Valerius Maximus iv. 7. 3; Justin xxxii. 3; Aulus Gellius iii. 9.

CAERE (mod. *Cerveteri*, i.e. *Caere vetus*, see below), an ancient city of Etruria about 5 m. from the sea coast and about 20 m. N.W. of Rome, direct from which it was reached by branch roads from the Via Aurelia and Via Clodia. Ancient writers tell us that its original Pelasgian name was Agylla, and that the Etruscans took it and called it Caere (when this occurred is not known),

¹ A limestone well adapted for building. It was well known in the 15th and 16th centuries, at which period many English churches were built of it.

but the former name lasted on into later times as well as Caere. It was one of the twelve cities of Etruria, and its trade, through its port Pyrgos (*q.v.*), was of considerable importance. It fought with Rome in the time of Tarquinius Priscus and Servius Tullius, and subsequently became the refuge of the expelled Tarquins. After the invasion of the Gauls in 390 B.C., the vestal virgins and the sacred objects in their custody were conveyed to Caere for safety, and from this fact some ancient authorities derive the word *caerimonia*, ceremony. A treaty was made between Rome and Caere in the same year. In 353, however, Caere took up arms against Rome out of friendship for Tarquinius, but was defeated, and it is probably at this time that it became partially incorporated with the Roman state, as a community whose members enjoyed only a restricted form of Roman citizenship, without the right to a vote, and which was, further, without internal autonomy. The status is known as the *ius Caeritium*, and Caere was the first of a class of such municipalities (Th. Mommsen, *Römische Staatsrecht*, iii. 583). In the First Punic War, Caere furnished Rome with corn and provisions, but otherwise, up till the end of the Republic, we only hear of prodigies being observed at Caere and reported at Rome, the Etruscans being especially expert in augural lore. By the time of Augustus its population had actually fallen behind that of the *Aquae Caeretanæ* (the sulphur springs now known as the *Bagni del Sasso*, about 5 m. W.), but under either Augustus or Tiberius its prosperity was to a certain extent restored, and inscriptions speak of its municipal officials (the chief of them called *dictator*) and its town council, which had the title of *senatus*. In the middle ages, however, it sank in importance, and early in the 13th century, a part of the inhabitants founded *Caere novum* (mod. *Ceri*) 3 m. to the east.

The town lay on a hill of tufa, running from N.E. to S.W., isolated except on the N.E., and about 300 ft. above sea-level. The modern town, at the western extremity, probably occupies the site of the acropolis. The line of the city walls, of rectangular blocks of tufa, can be traced, and there seem to have been eight gates in the circuit, which was about 4 m. in length. There are no remains of buildings of importance, except the theatre, in which many inscriptions and statues of emperors were found. The necropolis in the hill to the north-west, known as the *Banditaccia*, is important. The tomb chambers are either hewn in the rock or covered by mounds. One of the former class was the family tomb of the Tarchna-Tarquinius, perhaps descended from the Roman kings; others are interesting from their architectural and decorative details. One especially, the *Grotta dei Bassirilievi*, has interesting reliefs cut in the rock and painted, while the walls of another were decorated with painted tiles of terracotta. The most important tomb of all, the *Regolini-Galassi* tomb (taking its name from its discoverers), which lies S.W. of the ancient city, is a narrow rock-hewn chamber about 60 ft. long, lined with masonry, the sides converging to form the roof. The objects found in it (a chariot, a bed, silver goblets with reliefs, rich gold ornaments, &c.) are now in the Etruscan Museum at the Vatican: they are attributed to about the middle of the 7th century B.C. At a short distance from the modern town on the west, thousands of votive terracottas were found in 1886, some representing divinities, others parts of the human body (*Notizie degli Scavi*, 1886, 38). They must have belonged to some temple.

See G. Dennis, *Cities and Cemeteries of Etruria*, i. 226 seq.; C. Hülsen in Pauly-Wissowa, *Realencyclopädie*, iii. 1281. (T. As.)

CAERLEON, an ancient village in the southern parliamentary division of Monmouthshire, England, on the right (west) bank of the Uak, 3 m. N.E. of Newport. Pop. (1901) 1411. Its claim to notice rests on its Roman and British associations. As *Ica Silurum*, it was one of the three great legionary fortresses of Roman Britain, established either about A.D. 50 (Tacitus, *Annals*, xii. 32), or perhaps, as coin-finds suggest, about A.D. 74-78 in the governorship of Julius Frontinus, and in either case intended to coerce the wild Silures. It was garrisoned by the *Legio II. Augusta* from its foundation till near the end of the Roman rule in Britain. Though never seriously excavated, it

contains plentiful visible traces of its Roman period—part of the ramparts, the site of an amphitheatre, and many inscriptions, sculptured stones, &c., in the local museum. No civil life or municipality seems, however, to have grown up outside its walls, as at York (*Eboracum*). Like Chester (see *DEVA*), it remained purely military, and the common notion that it was the seat of a Christian bishopric in the 4th century is unproved and improbable. Its later history is obscure. We do not know when the legion was finally withdrawn, nor what succeeded. But Welsh legend has made the site very famous with tales of Arthur (revived by Tennyson in his *Idylls*), of Christian martyrs, Aaron and Julius, and of an archbishopric held by St Dubric and shifted to St David's in the 6th century. Most of these traditions date from Geoffrey of Monmouth (about 1130-1140), and must not be taken for history. The ruins of Caerleon attracted notice in the 12th and following centuries, and gave plain cause for legend-making. There is better, but still slender, reason for the belief that it was here, and not at Chester, that five kings of the Cymry rowed Edgar in a barge as a sign of his sovereignty (A.D. 973). The name Caerleon seems to be derived from the Latin *Castra legionum*, but it is not peculiar to Caerleon-on-Uak, being often used of Chester and occasionally of Leicester and one or two other places. (F. J. H.)

CAERPHILLY, a market town of Glamorganshire, Wales, 15½ m. from London by rail *via* Cardiff, 7 m. from Cardiff, 12 m. from Newport and 6 m. from Pontypridd. The origin of the name is unknown. It was formerly in the ancient parish of Eglwysilan, but from that and *Beowas* (Mon.) an ecclesiastical parish was formed in 1850, while the whole of the parishes of Eglwysilan and Llanfabon, with a total acreage of 14,426, were in 1893 constituted into an urban district; its population in 1901 was 15,385, of which 4343 were in the "town" ward. In 1858 was opened the Rhymney railway from Rhymney to Caerphilly and on to Taff's Well, whence it had running powers over the Taff Vale railway to Cardiff, but in 1871, by means of a tunnel about 2000 yds. long, under Cefn Onn, a direct line was provided from Caerphilly to Cardiff. A branch line, 4 m. long, was opened in 1894 to Senghenydd. The Pontypridd and Newport railway was constructed in 1887, and there is a joint station at Caerphilly for both railways. Some 2 m. eastwards there is a station on the Brecon and Merthyr railway at Bedwas.

The ancient comote of Senghenydd (corresponding to the modern hundred of Caerphilly) comprised the mountainous district extending from the ridge of Cefn Onn on the south to Breconshire on the north, being bounded by the rivers Taff and Rumney on the west and east. Its inhabitants, though nominally subject to the lords of Glamorgan since Fitzhamon's conquest, enjoyed a large measure of independence and often raided the lowlands. To keep these in check, Gilbert de Clare, during the closing years of the reign of Henry III., built the castle of Caerphilly on the southern edge of this district, in a wide plain between the two rivers. It had probably not been completed, though it was already defensible, when Prince Llewelyn ab Griffith, incensed by its construction and claiming its site as his own, laid siege to it in 1271 and refused to retire except on conditions. Subsequently completed and strengthened it became and still remains (in the words of G. T. Clark) "both the earliest and the most complete example in Britain of a concentric castle of the type known as 'Edwardian,' the circle of walls and towers of the outer, inner and middle wards exhibiting the most complete illustration of the most scientific military architecture." The knoll on which it stood was converted almost into an island by the damming up of an adjacent brook, and the whole enclosed area amounted to 30 acres. The great hall (which is 73 ft. by 35 ft. and about 30 ft. high) is a fine example of Decorated architecture. This and other additions are attributed to Hugh le Despenser (1318-1326). Edward II. visited the castle shortly before his capture in 1326. The defence of the castle was committed by Henry IV. to Constance, Lady Despenser, in September 1403, but it was shortly afterwards taken by Owen Glyndwr, to whose mining operations tradition ascribes the leaning position of a large

which was also the case in the time of Leano (1535), who describes it as in a ruinous state. It is still, however, one of the most extensive and imposing ruins of the kind in the kingdom.

The town grew up around the castle but never received a charter or had a governing body. In 1661 the corporation of Cardiff complained of Cardiff's impoverishment by reason of a fair held every three weeks for the previous four years at Caerphilly, though "no Borough." Its markets during the 19th century had been chiefly noted for the Caerphilly cheese sold there. The district was one of the chief centres of the Methodist revival of the 18th century, the first synod of the Calvinistic Methodists being held in 1743 at Watford farm close to the town, from which place George Whitefield was married at Eglwysilan church two years previously. The church of St Martin was built in 1879, and there are Nonconformist chapels. Mining is now the chief industry of the district. (D. L. T.)

CAESALPINUS (CESALPINO), ANDREAS (1510-1603), Italian natural philosopher, was born in Arezzo in Tuscany in 1510. He studied anatomy and medicine at the university of Pisa, where he took his doctor's degree in 1551, and in 1555 became professor of materia medica and director of the botanical garden. Appointed physician to Pope Clement VIII., he removed in 1592 to Rome, where he died on the 23rd of February 1603. Caesalpinus was the most distinguished botanist of his time. His work, *De Plantis libri xvi.* (Florence, 1583), was not only the source from which various subsequent writers, and especially Robert Morison (1620-1683) derived their ideas of botanical arrangement but it was a mine of science to which Linnaeus himself gratefully avowed his obligations. Linnaeus's copy of the book evinces the great assiduity with which he studied it; he laboured throughout to remedy the defect of the want of synonyms, sub-joined his own generic names to nearly every species, and particularly indicated the two remarkable passages where the germination of plants and their sexual distinctions are explained. Caesalpinus was also distinguished as a physiologist, and it has been claimed that he had a clear idea of the circulation of the blood (see HARVEY, WILLIAM). His other works include *Daemonum investigatio peripatetica* (1580), *Quaestionum medicarum libri ii.* (1593), *De Metallis* (1596), and *Quaestionum peripateticarum libri v.* (1571).

CAESAR, GAIUS JULIUS (102-44 B.C.), the great Roman soldier and statesman, was born on the 12th of July 102 B.C.¹

Early years. His family was of patrician rank and traced a legendary descent from Iulus, the founder of Alba

Longa, son of Aeneas and grandson of Venus and Anchises. Caesar made the most of his divine ancestry and built a temple in his forum to Venus Genetrix; but his patrician descent was of little importance in politics and disqualified Caesar from holding the tribunate, an office to which, as a leader of the popular party, he would naturally have aspired. The Julii Caesares, however, had also acquired the new *nobilitas*, which belonged to holders of the great magistracies. Caesar's uncle was consul in 91 B.C., and his father held the praetorship. Most of the family seem to have belonged to the senatorial party (*optimates*); but Caesar himself was from the first a *popularis*. The determining factor is no doubt to be sought in his relationship with C. Marius, the husband of his aunt Julia. Caesar was born in the year of Marius's first great victory over the Teutones, and as he grew up, inspired by the traditions of the great soldier's career, attached himself to his party and its fortunes. Of his education we know scarcely anything. His mother, Aurelia, belonged to a distinguished family, and Tacitus (*Dial. de Orat.* xxviii.) couples her name with that of Cornelia, the mother of the Gracchi, as an example of the Roman matron

¹ In spite of the explicit statements of Suetonius, Plutarch and Appian that Caesar was in his fifty-sixth year at the time of his murder, it is, as Mommsen has shown, practically certain that he was born in 102 B.C., since he held the chief offices of state in regular order, beginning with the aedileship in 65 B.C., and the legal age for this was fixed at 37-38.

said to have been equally learned in Greek and Latin literature, and to have set up in later years a school of rhetoric which was attended by Cicero in his praetorship 66 B.C. It is possible that Caesar may have derived from him his interest in Gaul and its people and his sympathy with the claims of the Romanized Gauls of northern Italy to political rights.

In his sixteenth year (87 B.C.) Caesar lost his father, and assumed the *toga virilis* as the token of manhood. The social war (90-89 B.C.) had been brought to a close by the enfranchisement of Rome's Italian subjects; and the civil war which followed it led, after the departure of Sulla for the East, to the temporary triumph of the *populares*, led by Marius and Cinna, and the indiscriminate massacre of their political opponents, including both of Caesar's uncles. Caesar was at once marked out for high distinction, being created *flamen Dialis* or priest of Jupiter. In the following year (which saw the death of Marius) Caesar, rejecting a proposed marriage with a wealthy capitalist's heiress, sought and obtained the hand of Cornelia, the daughter of Cinna, and thus became further identified with the ruling party. His career was soon after interrupted by the triumphant return of Sulla (82 B.C.), who ordered him to divorce his wife, and on his refusal deprived him of his property and priesthood and was induced to spare his life only by the intercession of his aristocratic relatives and the college of vestal virgins.

Released from his religious obligations, Caesar now (81 B.C.) left Rome for the East and served his first campaign under Minucius Thermus, who was engaged in stamping out the embers of resistance to Roman rule in the province of Asia, and received from him the "civic crown" for saving a fellow-soldier's life at the storm of Mytilene. In 78 B.C. he was serving under Servilius Isauricus against the Cilician pirates when the news of Sulla's death reached him and he at once returned to Rome. Refusing to entangle himself in the abortive and equivocal schemes of Lepidus to subvert the Sullan constitution, Caesar took up the only instrument of political warfare left to the opposition by prosecuting two senatorial governors, Cn. Cornelius Dolabella (in 77 B.C.) and C. Antonius (in 76 B.C.) for extortion in the provinces of Macedonia and Greece, and though he lost both cases, probably convinced the world at large of the corruption of the senatorial tribunals. After these failures Caesar determined to take no active part in politics for a time, and retraced his steps to the East in order to study rhetoric under Molon, at Rhodes. On the journey thither he was caught by pirates, whom he treated with consummate nonchalance while awaiting his ransom, threatening to return and crucify them; when released he lost no time in carrying out his threat. Whilst he was studying at Rhodes the third Mithradatic War broke out, and Caesar at once raised a corps of volunteers and helped to secure the wavering loyalty of the provincials of Asia. When Lucullus assumed the command of the Roman troops in Asia, Caesar returned to Rome, to find that he had been elected to a seat on the college of *pontifices* left vacant by the death of his uncle, C. Aurelius Cotta. He was likewise elected first of the six *tribuni militum a populo*, but we hear nothing of his service in this capacity. Suetonius tells us that he threw himself into the agitation for the restoration of the ancient powers of the tribunate curtailed by Sulla, and that he secured the passing of a law of amnesty in favour of the partisans of Sertorius. He was not, however, destined to compass the downfall of the Sullan régime; the crisis of the Slave War placed the Senate at the mercy of Pompey and Crassus, who in 70 B.C. swept away the safeguards of senatorial ascendancy, restored the initiative in legislation to the tribunes, and replaced the Equestrian order, i.e. the capitalists, in partial possession of the jury-courts. This judicial reform (or rather compromise) was the work of Caesar's uncle, L. Aurelius Cotta. Caesar himself, however, gained no accession of influence. In 69 B.C. he served as quaestor under Antistius Vetus, governor of Hither Spain, and on his way back to Rome (according to Suetonius) promoted a revolutionary agitation

amongst the Transpadanes for the acquisition of full political rights, which had been denied them by Sulla's settlement.

Caesar was now best known as a man of pleasure, celebrated for his debts and his intrigues; in politics he had no force behind him save that of the discredited party of the *populares*, reduced to lending a passive support to Pompey and Crassus. But as soon as the proved incompetence of the senatorial government had brought about the mission

Opposition to the Optimates.

of Pompey to the East with the almost unlimited powers conferred on him by the Gabinian and Manilian laws of 67 and 66 B.C. (see POMPEY), Caesar plunged into a network of political intrigues which it is no longer possible to unravel. In his public acts he lost no opportunity of upholding the democratic tradition. Already in 68 B.C. he had paraded the bust of Marius at his aunt's funeral; in 65 B.C., as curule aedile, he restored the trophies of Marius to their place on the Capitol; in 64 B.C., as president of the murder commission, he brought three of Sulla's executioners to trial, and in 63 B.C. he caused the ancient procedure of trial by popular assembly to be revived against the murderer of Saturninus. By these means, and by the lavishness of his expenditure on public entertainments as aedile, he acquired such popularity with the plebs that he was elected *pontifex maximus* in 63 B.C. against such distinguished rivals as Q. Lutatius Catulus and P. Servilius Isauricus. But all this was on the surface. There can be no doubt that Caesar was cognizant of some at least of the threads of conspiracy which were woven during Pompey's absence in the East. According to one story, the *enfants perdus* of the revolutionary party—Catiline, Autronius and others—designed to assassinate the consuls on the 1st of January 65, and make Crassus dictator, with Caesar as master of the horse. We are also told that a public proposal was made to confer upon him an extraordinary military command in Egypt, not without a legitimate king and nominally under the protection of Rome. An equally abortive attempt to create a counterpoise to Pompey's power was made by the tribune Rullus at the close of 64 B.C. He proposed to create a land commission with very wide powers, which would in effect have been wielded by Caesar and Crassus. The bill was defeated by Cicero, consul in 63 B.C. In the same year the conspiracy associated with the name of Catiline came to a head. The charge of complicity was freely levelled at Caesar, and indeed was hinted at by Cato in the great debate in the senate. But Caesar, for party reasons, was bound to oppose the execution of the conspirators; while Crassus, who shared in the accusation, was the richest man in Rome and the least likely to further anarchist plots. Both, however, doubtless knew as much and as little as suited their convenience of the doings of the left wing of their party, which served to aggravate the embarrassments of the government.

As praetor (62 B.C.) Caesar supported proposals in Pompey's favour which brought him into violent collision with the senate. This was a master-stroke of tactics, as Pompey's return was imminent. Thus when Pompey landed in Italy and disbanded his army he found in Caesar a natural ally. After some delay, said to have been caused by the exigencies of his creditors, which were met by a loan of £200,000 from Crassus, Caesar left Rome for his province of Further Spain, where he was able to retrieve his financial position, and to lay the foundations of a military reputation. He returned to Rome in 60 B.C. to find that the senate had sacrificed the support of the capitalists (which Cicero had worked so hard to secure), and had finally alienated Pompey by refusing to ratify his acts and grant lands to his soldiers. Caesar at once approached both Pompey and Crassus, who alike detested the existing system of government but were personally at variance, and succeeded in persuading them to forget their quarrel and join him in a coalition which should put an end to the rule of the oligarchy. He even made a generous, though unsuccessful, endeavour to enlist the support of Cicero. The so-called First Triumvirate was formed, and constitutional government ceased to exist save in name.

The first prize which fell to Caesar was the consulship, to secure which he forewent the triumph which he had earned in Spain. His colleague was M. Bibulus, who belonged to the

straitest sect of the senatorial oligarchy and, together with his party, placed every form of constitutional obstruction in the path of Caesar's legislation. Caesar, however, overrode all opposition, mustering Pompey's veterans to drive his colleague from the forum. Bibulus became a virtual prisoner in his own house, and Caesar placed himself outside the pale of the free republic. Thus the programme of the coalition was carried through. Pompey was satisfied by the ratification of his acts in Asia, and by the assignment of the Campanian state domains to his veterans, the capitalists (with whose interests Crassus was identified) had their bargain for the farming of the Asiatic revenues cancelled, Ptolemy Auletes received the confirmation of his title to the throne of Egypt (for a consideration amounting to £1,500,000), and a fresh act was passed for preventing extortion by provincial governors.

Coalition with Pompey and Crassus.

It was now all-important for Caesar to secure practical irresponsibility by obtaining a military command. The senate, in virtue of its constitutional prerogative, had assigned as the *provincia* of the consuls of 59 B.C. the supervision of roads and forests in Italy. Caesar secured the passing of a legislative enactment conferring upon himself the government of Cisalpine Gaul and Illyria for five years, and exacted from the terrorized senate the addition of Transalpine Gaul, where, as he well knew, a storm was brewing which threatened to sweep away Roman civilization beyond the Alps. The mutual jealousies of the Gallic tribes had enabled German invaders first to gain a foothold on the left bank of the Rhine, and then to obtain a predominant position in Central Gaul. In 60 B.C. the German king Ariovistus had defeated the Aedui, who were allies of Rome, and had wrested from the Sequani a large portion of their territory. Caesar must have seen that the Germans were preparing to dispute with Rome the mastery of Gaul; but it was necessary to gain time, and in 59 B.C. Ariovistus was inscribed on the roll of the friends of the Roman people. In 58 B.C. the Helvetii, a Celtic people inhabiting Switzerland, determined to migrate for the shores of the Atlantic and demanded a passage through Roman territory. According to Caesar's statement they numbered 368,000, and it was necessary at all hazards to save the Roman province from the invasion. Caesar had but one legion beyond the Alps. With this he marched to Geneva, destroyed the bridge over the Rhone, fortified the left bank of the river, and forced the Helvetii to follow the right bank. Hastening back to Italy he withdrew his three remaining legions from Aquileia, raised two more, and, crossing the Alps by forced marches, arrived in the neighbourhood of Lyons to find that three-fourths of the Helvetii had already crossed the Saône, marching westward. He destroyed their rearguard, the Tigurini, as it was about to cross, transported his army across the river in twenty-four hours, pursued the Helvetii in a northerly direction, and utterly defeated them at Bibracte (Mont Beuvray). Of the survivors a few were settled amongst the Aedui; the rest were sent back to Switzerland lest it should fall into German hands.

Gaul wars.

The Gallic chiefs now appealed to Caesar to deliver them from the actual or threatened tyranny of Ariovistus. He at once demanded a conference, which Ariovistus refused, and on hearing that fresh swarms were crossing the Rhine, marched with all haste to Vesontio (Besançon) and thence by way of Belfort into the plain of Alsace, where he gained a decisive victory over the Germans, of whom only a few (including Ariovistus) reached the right bank of the Rhine in safety. These successes roused natural alarm in the minds of the Belgae—a confederacy of tribes in the north-west of Gaul, whose civilization was less advanced than that of the Celtae of the centre—and in the spring of 57 B.C. Caesar determined to anticipate the offensive movement which they were understood to be preparing and marched northwards into the territory of the Remi (about Reims), who alone amongst their neighbours were friendly to Rome. He successfully checked the advance of the enemy at the passage of the Aiane (between Laon and Reims) and their ill-organized force melted away as he advanced. But the Nervii; and their neighbours further to the north-west, remained to be dealt with, and were

crushed only after a desperate struggle on the banks of the Sambre, in which Caesar was forced to expose his person in the *melle*. Finally, the Aduatuci (near Namur) were compelled to submit, and were punished for their subsequent treachery by being sold wholesale into slavery. In the meantime Caesar's lieutenant, P. Crassus, received the submission of the tribes of the north-east, so that by the close of the campaign almost the whole of Gaul—except the Aquitani in the south-west—acknowledged Roman suzerainty.

In 56 B.C., however, the Veneti of Brittany threw off the yoke and detained two of Crassus's officers as hostages. Caesar, who had been hastily summoned from Illyricum, crossed the Loire and invaded Brittany, but found that he could make no headway without destroying the powerful fleet of high, flat-bottomed boats like floating castles possessed by the Veneti. A fleet was hastily constructed in the estuary of the Loire, and placed under the command of Decimus Brutus. The decisive engagement was fought (probably) in the Gulf of Morbihan and the Romans gained the victory by cutting down the enemy's rigging with sickles attached to poles. As a punishment for their treachery, Caesar put to death the senate of the Veneti and sold their people into slavery. Meanwhile Sabinus was victorious on the northern coasts, and Crassus subdued the Aquitani. At the close of the season Caesar raided the territories of the Morini and Menapii in the extreme north-west.

In 55 B.C. certain German tribes, the Usipetes and Tencteri, crossed the lower Rhine, and invaded the modern Flanders.

Caesar at once marched to meet them, and, on the pretext that they had violated a truce, seized their leaders who had come to parley with him, and then surprised and practically destroyed their host. His enemies in Rome accused him of treachery, and Cato even proposed that he should be handed over to the Germans. Caesar meanwhile constructed his famous bridge over the Rhine in ten days, and made a demonstration of force on the right bank. In the remaining weeks of the summer he made his first expedition to Britain, and this was followed by a second crossing in 54 B.C. On the first occasion Caesar took with him only two legions, and effected little beyond a landing on the coast of Kent. The second expedition consisted of five legions and 2000 cavalry, and set out from the Portus Itius (Boulogne or Wissant; see T. Rice Holmes, *Ancient Britain and the Invasions of Julius Caesar*, 1907, later views in *Classical Review*, May 1909, and H. S. Jones, in *Eng. Hist. Rev.* xxiv., 1909, p. 115). Caesar now penetrated into Middlesex and crossed the Thames, but the British prince Cassivellaunus with his war-chariots harassed the Roman columns, and Caesar was compelled to return to Gaul after imposing a tribute which was never paid.

The next two years witnessed the final struggle of the Gauls for freedom. Just before the second crossing to Britain, Dumnorix, an Aeduan chief, had been detected in treasonable intrigues, and killed in an attempt to escape from Caesar's camp. At the close of the campaign Caesar distributed his legions over a somewhat wide extent of territory. Two of their camps were treacherously attacked. At Aduatua (near Aix-la-Chapelle) a newly-raised legion was cut to pieces by the Eburones under Ambiorix, while Quintus Cicero was besieged in the neighbourhood of Namur and only just relieved in time by Caesar, who was obliged to winter in Gaul in order to check the spread of the rebellion. Indutiomarus, indeed, chief of the Treveri (about Trèves), revolted and attacked Labienus, but was defeated and killed. The campaign of 53 B.C. was marked by a second crossing of the Rhine and by the destruction of the Eburones, whose leader Ambiorix, however, escaped. In the autumn Caesar held a conference at Durocor-torium (Reims), and Acco, a chief of the Senones, was convicted of treason and flogged to death.

Early in 52 B.C. some Roman traders were massacred at Cenabum (Orléans), and, on hearing the news, the Arverni revolted under Vercingetorix and were quickly joined by other tribes, especially the Bituriges, whose capital was Avaricum (Bourges). Caesar hastened back from Italy, slipped past

Vercingetorix and reached Agedincum (Sens), the headquarters of his legions. Vercingetorix saw that Caesar could not be met in open battle, and determined to concentrate his forces in a few strong positions. Caesar first besieged and took Avaricum, whose occupants were massacred, and then invested Gergovia (near the Puy-de-Dôme), the capital of the Arverni, but suffered a severe repulse and was forced to raise the siege. Hearing that the Roman province was threatened, he marched westward, defeated Vercingetorix near Dijon and shut him up in Alesia (Mont-Auxois), which he surrounded with lines of circumvallation. An attempt at relief by Vercassivellaunus was defeated after a desperate struggle and Vercingetorix surrendered. The struggle was over except for some isolated operations in 51 B.C., ending with the siege and capture of Uxellodunum (Puy d'Issoulin), whose defenders had their hands cut off. Caesar now reduced Gaul to the form of a province, fixing the tribute at 40,000,000 sesterces (£350,000), and dealing liberally with the conquered tribes, whose cantons were not broken up.

In the meantime his own position was becoming critical. In 56 B.C., at the conference of Luca (Lucca), Caesar, Pompey and Crassus had renewed their agreement, and Caesar's command in Gaul, which would have expired on the 1st of March 54 B.C., was renewed, probably for five years, i.e. to the 1st of March 49 B.C., and it was enacted

that the question of his successor should not be discussed until the 1st of March 50 B.C., by which time the provincial commands for 49 B.C. would have been assigned, so that Caesar would retain *imperium*, and thus immunity from persecution, until the end of 49 B.C. He was to be elected consul for 48 B.C., and, as the law prescribed a personal canvass, he was by special enactment dispensed from its provisions. But in 54 B.C. Julia, the daughter of Caesar and wife of Pompey, died, and in 53 B.C. Crassus was killed at Carrhae. Pompey now drifted apart from Caesar and became the champion of the senate. In 52 B.C. he passed a fresh law *de jure magistratum* which cut away the ground beneath Caesar's feet by making it possible to provide a successor to the Gallic provinces before the close of 49 B.C., which meant that Caesar would become for some months a private person, and thus liable to be called to account for his unconstitutional acts. Caesar had no resource left but uncompromising obstruction, which he sustained by enormous bribes. His representative in 50 B.C., the tribune C. Scribonius Curio, served him well, and induced the lukewarm majority of the senate to refrain from extreme measures, insisting that Pompey, as well as Caesar, should resign the *imperium*. But all attempts at negotiation failed, and in January 49 B.C., martial law having been proclaimed on the proposal of the consuls, the tribunes Antony and Cassius fled to Caesar, who crossed the Rubicon (the frontier of Italy) with a single legion, exclaiming "*Alas jacta est.*"

Pompey's available force consisted in two legions stationed in Campania, and eight, commanded by his lieutenants, Afranius and Petreius, in Spain; both sides levied troops in Italy. Caesar was soon joined by two legions from Gaul and marched rapidly down the Adriatic coast, overtaking Pompey at Brundisium (Brindisi), but failing to prevent him from embarking with his troops for the East, where the prestige of his name was greatest. Hereupon Caesar (it is said) exclaimed "I am going to Spain to fight an army without a general, and thence to the East to fight a general without an army." He carried out the first part of this programme with marvellous rapidity. He reached Herda (Lerida) on the 23rd of June and, after extricating his army from a perilous situation, outmanoeuvred Pompey's lieutenants and received their submission on the 2nd of August. Returning to Rome, he held the dictatorship for eleven days, was elected consul for 48 B.C., and set sail for Epirus at Brundisium on the 4th of January. He attempted to invest Pompey's lines at Dyrrhachium (Durazzo), though his opponent's force was double that of his own, and was defeated with considerable loss. He now marched eastwards, in order if possible to intercept the reinforcements which Pompey's father-in-law, Scipio, was bringing up; but Pompey

Break-up
of the
Coalition.

The Civil
War.

was able to effect a junction with this force and descended into the plain of Thessaly, where at the battle of Pharsalus he was decisively defeated and fled to Egypt, pursued by Caesar, who learnt of his rival's murder on landing at Alexandria. Here he remained for nine months, fascinated (if the story be true) by Cleopatra, and almost lost his life in an *emende*. In June 47 B.C. he proceeded to the East and Asia Minor, where he "came, saw and conquered" Pharnaces, son of Mithradates the Great, at Zela. Returning to Italy, he quelled a mutiny of the legions (including the faithful Tenth) in Campania, and crossed to Africa, where a republican army of fourteen legions under Scipio was cut to pieces at Thapsus (6th of April 46 B.C.). Here most of the republican leaders were killed and Cato committed suicide. On the 26th to 29th July Caesar celebrated a fourfold triumph and received the dictatorship for ten years. In November, however, he was obliged to sail for Spain, where the sons of Pompey still held out. On the 17th of March 45 B.C. they were crushed at Munda. Caesar returned to Rome in September, and six months later (15th of March 44 B.C.) was murdered in the senate house at the foot of Pompey's statue.

It was remarked by Seneca that amongst the murderers of Caesar were to be found more of his friends than of his enemies.

We can account for this only by emphasizing the fact that the form of Caesar's government became as time went on more undisguised in its absolutism, while the honours conferred upon him seemed designed to raise him above the rest of humanity. It is explained elsewhere (see *ROME: History, Ancient*) that Caesar's power was exercised under the form of the dictatorship. In the first instance (autumn of 49 B.C.) this was conferred upon him as the only solution of the constitutional deadlock created by the flight of the magistrates and senate, in order that elections (including that of Caesar himself to the consulship) might be held in due course. For this there were republican precedents. In 48 B.C. he was created dictator for the second time, probably with constituent powers and for an undefined period, according to the dangerous and unpopular precedent of Sulla. In May 46 B.C. a third dictatorship was conferred on Caesar, this time for ten years and apparently as a yearly office, so that he became Dictator IV. in May 45 B.C. Finally, before the 15th of February 44 B.C., this was exchanged for a life-dictatorship. Not only was this a contradiction in terms, since the dictatorship was by tradition a makeshift justified only when the state had to be carried through a serious crisis, but it involved military rule in Italy and the permanent suspension of the constitutional guarantees, such as *intercessio* and *provocatio*, by which the liberties of Romans were protected. That Caesar held the *imperium* which he enjoyed as dictator to be distinct in kind from that of the republican magistrates he indicated by placing the term *imperator* at the head of his titles.¹ Besides the dictatorship, Caesar held the consulship in each year of his reign except 47 B.C. (when no curule magistrates were elected save for the last three months of the year); and he was moreover invested by special enactments with a number of other privileges and powers; of these the most important was the *tribunicia potestas*, which we may believe to have been free from the limits of place (*i.e.* Rome) and collegiality. Thus, too, he was granted the sole right of making peace and war, and of disposing of the funds in the treasury of the state.² Save for the title of dictator, which undoubtedly carried unpopular associations and was formally abolished on the proposal of Antony after Caesar's death, this cumulation of powers has little to distinguish it from the Principate of Augustus; and the assumption of the perpetual dictatorship would hardly by itself suffice to account for the murder of Caesar. But there are signs that in the last six months of his life he aspired not only to a monarchy in name as well as in fact, but also to a divinity which Romans should

¹ Suetonius, *Jul.* 76, errs in stating that he used the title *imperator* as a *praenomen*.

² The statement of Dio and Suetonius, that a general *cura legum et morum* was conferred on Caesar in 46 B.C., is rejected by Mommsen. It is possible that it may have some foundation in the terms of the law establishing his third dictatorship.

acknowledge as well as Greeks, Orientals and barbarians. His statue was set up beside those of the seven kings of Rome, and he adopted the throne of gold, the sceptre of ivory and the embroidered robe which tradition ascribed to them. He allowed his supporters to suggest the offer of the regal title by putting in circulation an oracle according to which it was destined for a king of Rome to subdue the Parthians, and when at the Lupercalia (15th February 44 B.C.) Antony set the diadem on his head he rejected the offer half-heartedly on account of the groans of the people. His image was carried in the *pompa circensis* amongst those of the immortal gods, and his statue set up in the temple of Quirinus with the inscription "To the Unconquerable God." A college of Luperci, with the surname Juliani, was instituted in his honour and *flamines* were created as priests of his godhead. This was intolerable to the aristocratic republicans, to whom it seemed becoming that victorious commanders should accept divine honours at the hands of Greeks and Asiatics, but unparadoxical that Romans should offer the same worship to a Roman.

Thus Caesar's work remained unfinished, and this must be borne in mind in considering his record of legislative and administrative reform. Some account of this is given elsewhere (see *ROME: History, Ancient*), but it may be well to single out from the list of his measures (some of which, such as the restoration of exiles and the children of proscribed persons, were dictated by political expediency, while others, such as his financial proposals for the relief of debtors, and the steps which he took to restore Italian agriculture, were of the nature of palliatives) those which have a permanent significance as indicating his grasp of imperial problems. The Social War had brought to the inhabitants of Italy as far as the Po the privileges of Roman citizenship; it remained to extend this gift to the Transpadane Italians, to establish a uniform system of local administration and to devise representative institutions by which at least some voice in the government of Rome might be permitted to her new citizens. This last conception lay beyond the horizon of Caesar, as of all ancient statesmen, but his first act on gaining control of Italy was to enfranchise the Transpadanes, whose claims he had consistently advocated, and in 45 B.C. he passed the *Lex Julia Municipalis*, an act of which considerable fragments are inscribed on two bronze tables found at Heraclea near Tarentum.³ This law deals *inter alia* with the police and the sanitary arrangements of the city of Rome, and hence it has been argued by Mommsen that it was Caesar's intention to reduce Rome to the level of a municipal town. But it is not likely that such is the case. Caesar made no far-reaching modifications in the government of the city, such as were afterwards carried out by Augustus, and the presence in the *Lex Julia Municipalis* of the clauses referred to is an example of the common process of "tacking" (legislation *per saturam*, as it was called by the Romans). The law deals with the constitution of the local senates, for whose members qualifications of age (30 years) and military service are laid down, while persons who have suffered conviction for various specified offences, or who are insolvent, or who carry on discreditable or immoral trades are excluded. It also provides that the local magistrates shall take a census of the citizens at the same time as the census takes place in Rome, and send the registers to Rome within sixty days. The existing fragments tell us little as to the decentralization of the functions of government, but from the *Lex Rubria*, which applies to the Transpadane districts enfranchised by Caesar (it must be remembered that Cisalpine Gaul remained nominally a province until 42 B.C.) we gather that considerable powers of independent jurisdiction were reserved to the municipal magistrates. But Caesar was not content with framing a uniform system of local government

³ Since the discovery of a fragmentary municipal charter at Tarentum (see *ROME*), dating from a period shortly after the Social War, doubts have been cast on the identification of the tables of Heraclea with Caesar's municipal statute. It has been questioned whether Caesar passed such a law, since the *Lex Julia Municipalis* mentioned in an inscription of Patavium (Padua) may have been a local charter. See Legras, *La Table latine d'Heraclea* (Paris, 1907).

Legis-
lative
reforms.

or veterans in Campania under the *Lex Julia Agraria*, and had even then laid down rules for the foundation of such communities. As dictator he planted numerous colonies both in the eastern and western provinces, notably at Corinth and Carthage. Mommsen interprets this policy as signifying that "the rule of the urban community of Rome over the shores of the Mediterranean was at an end," and says that the first act of the "new Mediterranean state" was "to atone for the two greatest outrages which that urban community had perpetrated on civilization." Thus, however, cannot be admitted. The sites of Caesar's colonies were selected for their commercial value, and that the citizens of Rome should cease to be rulers of the Mediterranean basin could never have entered into Caesar's mind. The colonists were in many cases veterans who had served under Caesar, in others members of the city proletariat. We possess the charter of the colony planted at Urso in southern Spain under the name of *Colonia Julia Genetiva Urbanorum*. Of the two latter titles, the first is derived from the name of Venus Genetrix, the ancestress of the Julian house, the second indicates that the colonists were drawn from the *plebs urbana*. Accordingly, we find that free birth is not, as in Italy, a necessary qualification for municipal office. By such foundations Caesar began the extension to the provinces of that Roman civilisation which the republic had carried to the bounds of the Italian peninsula. Lack of time alone prevented him from carrying into effect such projects as the piercing of the Isthmus of Corinth, whose object was to promote trade and intercourse throughout the Roman dominions, and we are told that at the time of his death he was contemplating the extension of the empire to its natural frontiers, and was about to engage in a war with Parthia with the object of carrying Roman arms to the Euphrates. Above all, he was determined that the empire should be governed in the true sense of the word and no longer exploited by its rulers, and he kept a strict control over the *legati*, who, under the form of military subordination, were responsible to him for the administration of their provinces.

Caesar's writings are treated under LATIN LITERATURE. It is sufficient here to say that of those preserved to us the seven books *Commentarii de bello Gallico* appear to have been written in 51 B.C. and carry the narrative of the Gallic campaigns down to the close of the previous year (the eighth book, written by A. Hirtius, is a supplement relating the events of 51-50 B.C.), while the three books *De bello civili* record the struggle between Caesar and Pompey (49-48 B.C.). Their veracity was impeached in ancient times by Asinius Pollio and has often been called in question by modern critics. The *Gallie War*, though its publication was doubtless timed to impress on the mind of the Roman people the great services rendered by Caesar to Rome, stands the test of criticism as far as it is possible to apply it, and the accuracy of its narrative has never been seriously shaken. The *Civil War*, especially in its opening chapters is, however, not altogether free from traces of misrepresentation. With respect to the first moves made in the struggle, and the negotiations for peace at the outset of hostilities, Caesar's account sometimes conflicts with the testimony of Cicero's correspondence or implies movements which cannot be reconciled with geographical facts. We have but few fragments of Caesar's other works, whether political pamphlets such as the *Anticato*, grammatical treatises (*De Analogia*) or poems. All authorities agree in describing him as a consummate orator. Cicero (*Brut.* 22) wrote: *de Caesare ita judico, illum omnium fere oratorum Latine loqui elegantissima*, while Quintilian (x. 1. 114) says that had he practised at the bar he would have been the only serious rival of Cicero.

The verdict of historians on Caesar has always been coloured by their political sympathies. All have recognised his commanding genius, and few have failed to do justice to his personal charm and magnanimity, which almost won the heart of Cicero, who rarely appeared in vain to his clemency.

or veterans in Campania under the *Lex Julia Agraria*, and had even then laid down rules for the foundation of such communities. As dictator he planted numerous colonies both in the eastern and western provinces, notably at Corinth and Carthage. Mommsen interprets this policy as signifying that "the rule of the urban community of Rome over the shores of the Mediterranean was at an end," and says that the first act of the "new Mediterranean state" was "to atone for the two greatest outrages which that urban community had perpetrated on civilization." Thus, however, cannot be admitted. The sites of Caesar's colonies were selected for their commercial value, and that the citizens of Rome should cease to be rulers of the Mediterranean basin could never have entered into Caesar's mind. The colonists were in many cases veterans who had served under Caesar, in others members of the city proletariat. We possess the charter of the colony planted at Urso in southern Spain under the name of *Colonia Julia Genetiva Urbanorum*. Of the two latter titles, the first is derived from the name of Venus Genetrix, the ancestress of the Julian house, the second indicates that the colonists were drawn from the *plebs urbana*. Accordingly, we find that free birth is not, as in Italy, a necessary qualification for municipal office. By such foundations Caesar began the extension to the provinces of that Roman civilisation which the republic had carried to the bounds of the Italian peninsula. Lack of time alone prevented him from carrying into effect such projects as the piercing of the Isthmus of Corinth, whose object was to promote trade and intercourse throughout the Roman dominions, and we are told that at the time of his death he was contemplating the extension of the empire to its natural frontiers, and was about to engage in a war with Parthia with the object of carrying Roman arms to the Euphrates. Above all, he was determined that the empire should be governed in the true sense of the word and no longer exploited by its rulers, and he kept a strict control over the *legati*, who, under the form of military subordination, were responsible to him for the administration of their provinces.

CAESAR'S WRITINGS.—The principal ancient authorities for the life of Caesar are his own *Commentaries*, the biographies of Plutarch and Suetonius, letters and speeches of Cicero, the *Gallics* of Sallust, the *Pharsalia* of Lucan, and the histories of Appian, Dio Cassius and Velleius Paterculus (that of Livy exists only in the *Ephemeris*). Amongst modern works may be named the exhaustive repertory of fact contained in Drumann, *Geschichte Roms*, vol. iii. (new ed. by Groebe, 1906, pp. 125-820), and the brilliant but partial panegyric of Th. Mommsen in his *History of Rome* (Eng. trans., vol. iv., esp. p. 450 ff.). J. A. Froude's *Caesar: a Sketch* (2nd ed., 1896) is equally biased and much less critical. W. Warde Fowler's *Julius Caesar* (1892) gives a favourable account (see also his *Social Life at Rome*, 1909). On the other side see especially A. Holm, *History of Greece* (Eng. trans., vol. iv. p. 582 ff.), J. L. Strachan Davidson, *Cicero* (1894), p. 345 ff., and the introductory Lectures in Prof. Tyrrell's edition of the *Correspondence of Cicero*, particularly "Cicero's case against Caesar," vol. v. p. 13 ff. Vol. ii. of G. Ferrero's *Greatness and Decline of Rome* (Eng. trans., 1907) is largely devoted to Caesar, but must be used with caution. The Gallic campaigns have been treated by Napoleon III., *Histoire de Jules César* (1855-1866), which is valuable as giving the result of excavations, and in English by T. Rice Holmes, *Caesar's Conquest of Gaul* (1901), in which references to earlier literature will be found. A later account is that of G. Veith, *Geschichte der Feldzüge C. Julius Caesars* (1900). For maps see A. von Kampe, *For the Civil War* see Colind Stoffel (the collaborator of Napoleon III.), *Histoire de Jules César: guerre civile* (1887). There is an interesting article, "The Likenesses of Julius Caesar," by J. C. Ropes, in *Scribner's Magazine*, Feb. 1887, with 18 plates. (H. S. J.)

Medieval Legends.

In the middle ages the story of Caesar did not undergo such extraordinary transformations as befell the history of Alexander the Great and the Theban legend. Lucan was regularly read in medieval schools, and the general facts of Caesar's life were too well known. He was generally, by a curious error, regarded as the first emperor of Rome, and representing as he did in the popular mind the glory of Rome, by an easy transition he became a pillar of the Church. Thus, in a French pseudo-historical romance, *Les Faits des Romains* (c. 1223), he receives the honour of a bishopric. His name was not usually associated with the marvellous, and the *trouvères* of *Huon de Bordeaux* outstepped the usual sober tradition when he made Oberon the son of Julius Caesar and Morgan la Fay. About 1240 Jehan de Tain composed a prose *Hystoire de Julius Cesar* (ed. F. Settegast, Halle, 1881) based on the *Pharsalia* of Lucan, and the *commentaries* of Caesar (on the Civil War) and his continuators (on the Alexandrine, African and Spanish wars). The author gives a romantic description of the meeting with Cleopatra, with an interpolated dissertation on *amour courtois* as understood by the *trouvères*.

¹ Brunetto Latini, *Treisor*: "Et ainsi Julius Cesar fu li premiers empereres des Romains."

The *Hystore* was turned into verse (alexandrines) by Jacot de Forest (latter part of the 13th century) under the title of *Roman de Julius César*. A prose compilation by an unknown author, *Les Foits des Romains* (c. 1225), has little resemblance to the last two works, although mainly derived from the same sources. It was originally intended to contain a history of the twelve Caesars, but concluded with the murder of the dictator, and in some MSS. bears the title of *Li liwes de César*. Its popularity is proved by the numerous MSS. in which it is preserved and by three separate translations into Italian. A *Mistaire de Julius César* is said to have been represented at Amboise in 1500 before Louis XII.

See A. Graf, *Roma nella memoria e nella immaginazione del medio evo*, i. ch. 8 (1882-1883); P. Meyer in *Romania*, xiv. (Paris, 1885), where the *Foits des Romains* is analysed at length; A. Duval in *Histoire littéraire de la France*, xix. (1838); L. Constant in *Petit de Julleville's Hist. de la langue et de la litt. française*, i. (1896); H. Wesemann, *Die Caesarfabeln des Mittelalters* (Löwenberg, 1879). (M. Ba.)

CAESAR, SIR JULIUS (1557-1558-1636), English judge, descended by the female line from the dukes de' Cesarini in Italy, was born near Tottenham in Middlesex. He was educated at Magdalen Hall, Oxford, and afterwards studied at the university of Paris, where in the year 1581 he was made a doctor of the civil law. Two years later he was admitted to the same degree at Oxford, and also became doctor of the canon law. He held many high offices during the reigns of Elizabeth and James I., including a judgeship of the admiralty court (1584), a mastership in chancery (1588), a mastership of the court of requests (1595), chancellor and under treasurer of the exchequer (1606). He was knighted by King James in 1603, and in 1614 was appointed master of the rolls, an office which he held till his death on the 18th of April 1636. He was so remarkable for his bounty and charity to all persons of worth that it was said of him that he seemed to be the almoner-general of the nation. His manuscripts, many of which are now in the British Museum, were sold by auction in 1757 for upwards of £500.

See E. Lodge, *Life of Sir Julius Caesar* (1810); Wood, *Facts Occasioned*, ed. Bliss; Foss, *Lives of the Judges*.

CAESAREA MAZACA (mod. *Kaisariëh*), chief town of a sanjak in the Angora vilayet of Asia Minor. Mazaca, the residence of the kings of Cappadocia, later called *Eusebea* (perhaps after Ariarathes Eusebes), and named *Caesarea* probably by Claudius, stood on a low spur on the north side of Erjies Dagh (*M. Argaeus*). The site, now called *Eski-sheh*, shows only a few traces of the old town. It was taken by Tigranes and destroyed by the Persian king Shapur (Sapor) I. after his defeat of Valerian in A.D. 260. At this time it is stated to have contained 400,000 inhabitants. In the 4th century Basil, when bishop, established an ecclesiastical centre on the plain, about 1 m. to the north-east, and this gradually supplanted the old town. A portion of Basil's new city was surrounded with strong walls and turned into a fortress by Justinian; and within the walls, rebuilt in the 13th and 16th centuries, lies the greater part of Kaisariëh, altitude 3500 ft. The town was captured by the Seljuk sultan, Alp Arslan, 1064, and by the Mongols, 1243, before passing to the Osmanli Turks. Its geographical situation has made it a place of commercial importance throughout history. It lay on the ancient trade route from Sinope to the Euphrates, on the Persian "Royal Road" from Sardis to Susa, and on the great Roman highway from Ephesus to the East. It is still the most important trade centre in eastern Asia Minor. The town is noted for its fruit, especially its vines; and it exports tissues, carpets, hides, yellow berries and dried fruit. Kaisariëh is the headquarters of the American mission in Cappadocia, which has several churches and schools for boys and girls and does splendid medical work. It is the seat of a Greek bishop, an Armenian archbishop and a Roman Catholic bishop, and there is a Jesuit school. On the 30th of November 1895 there was a massacre of Armenians, in which several Gregorian priests and Protestant pastors lost their lives. Pop., according to Cuinet, 71,000 (of whom 26,000 are Christians). Sir C. Wilson gave it as 50,000 (23,000 Christians). (C. W. W.; J. G. C. A.)

CAESAREAN SECTION, in obstetrics (*q.v.*) the operation for removal of a foetus from the uterus by an abdominal incision, so called from a legend of its employment at the birth of Julius Caesar. This procedure has been practised on the dead mother since very early times; in fact it was prescribed by Roman law that every woman dying in advanced pregnancy should be so treated; and in 1608 the senate of Venice enacted that any practitioner who failed to perform this operation on a pregnant woman supposed to be dead, laid himself open to very heavy penalties. But the first recorded instance of its being performed on a living woman occurred about 1500, when a Swiss pig-gelder operated on his own wife. From this time onwards it was tried in many ways and under many conditions, but almost invariably with the same result, the death of the mother. Even as recently as the first half of the 19th century the recorded mortality is over 50%. Thus it is no surprise that craniotomy—in which the life of the child is sacrificed to save that of the mother—was almost invariably preferred. As the use of antiseptics was not then understood, and as it was customary to return the uterus to the body cavity without suturing the incision, the immediate cause of death was either septicæmia or hæmorrhage. But in 1882 Säger published his method of suturing the uterus—that of employing two series of sutures, one deep, the other superficial. This method of procedure was immediately adopted by many obstetricians, and it has proved so satisfactory that it is still in use to-day. This, and the increasing knowledge of aseptic technique, has brought the mortality from this operation to less than 3% for the mother and about 5% for the child; and every year it is being advised more freely for a larger number of morbid conditions, and with increasingly favourable results. Craniotomy, *i.e.* crushing the head of the foetus to reduce its size, is now very rarely performed on the living child, but symphysiotomy, *i.e.* the division of the symphysis pubis to produce a temporary enlargement of the pelvis, or caesarean section, is advocated in its place. Of these two operations, symphysiotomy is steadily being replaced by caesarean section.

This operation is now advised for (1) extreme degrees of pelvic contraction, (2) any malformation or tumour of the uterus, cervix or vagina, which would render the birth of the child through the natural passages impossible, (3) maternal complications, as eclampsia and concealed accidental hæmorrhage, and (4) at the death of the mother for the purpose of saving the child.

CAESAREA PALAESTINA, a town built by Herod about 25-13 B.C., on the sea-coast of Palestine, 30 m. N. of Joppa, on the site of a place previously called *Terris Stratonis*. Remains of all the principal buildings erected by Herod existed down to the end of the 19th century; the ruins were much injured by a colony of Bosnians established here in 1884. These buildings are a temple, dedicated to Caesar; a theatre; a hippodrome; two aqueducts; a boundary wall; and, chief of all, a gigantic mole, 200 ft. wide, built of stones 50 ft. long, in 20 fathoms of water, protecting the harbour on the south and west. The harbour measures 180 yds. across. The massacre of Jews at this place led to the Jewish rebellion and to the Roman war. Vespasian made it a colony and called it Flavia; the old name, however, persisted, and still survives as *Kaisariëh*. Eusebius was archbishop here (A.D. 315-318). It was captured by the Moslems in 638 and by the Crusaders in 1102, by Saladin in 1187, recaptured by the Crusaders in 1191, and finally lost by them in 1265, since when till its recent settlement it has lain in ruins. Remains of the mediæval town are also visible, consisting of the walls (one-tenth the area of the Roman city), the castle, the cathedral (now covered by modern houses), and a church. (R. A. S. M.)

CAESAREA PHILIPPI, the name of a town 95 m. N. of Jerusalem, 35 m. S.W. from Damascus, 1150 ft. above the sea, on the south base of Hermon, and at an important source of the Jordan. It does not certainly appear in the Old Testament history, though identifications with Baal-Gad and (less certainly) with Laish (Dan) have been proposed. It was certainly a place of great sanctity from very early times, and, when foreign

religious influences intruded upon Palestine, the cult of its local *numen* gave place to the worship of Pan, to whom was dedicated the cave in which the copious spring feeding the Jordan arises. It was long known as *Panium* or *Panius*, a name that has survived in the modern *Bānīs*. When Herod the Great received the territory from Augustus, 20 B.C., he erected here a temple in honour of his patron; but the re-foundation of the town is due to his son, Philip the Tetrarch, who here erected a city which he named *Caesarea* in honour of Tiberius, adding *Philippi* to immortalize his own name and to distinguish his city from the similarly-named city founded by his father on the sea-coast. Here Christ gave His charge to Peter (Matt. xvi. 13). Many Greek inscriptions have been found here, some referring to the shrine. Agrippa II. changed the name to *Neronias*, but this name endured but a short while. Titus here exhibited gladiatorial shows to celebrate the capture of Jerusalem. The Crusaders took the city in 1130, and lost it to the Moslems in 1165. *Bānīs* is a poor village inhabited by about 350 Moslems; all round it are gardens of fruit-trees. It is well watered and fertile. There are not many remains of the Roman city above ground. The Crusaders' castle of Subeibeh, one of the finest in Palestine, occupies the summit of a conical hill above the village (R. A. S. M.).

CAESIUM (symbol Cs, atomic weight 132.9), one of the alkali metals. Its name is derived from the Lat. *caesius*, sky-blue, from two bright blue lines of its spectrum. It is of historical importance, since it was the first metal to be discovered by the aid of the spectroscope (R. Bunsen, *Berlin Acad. Ber.*, 1860), although caesium salts had undoubtedly been examined before, but had been mistaken for potassium salts (see C. F. Plattner, *Pog. Ann.*, 1846, p. 443, on the analysis of pollux and the subsequent work of F. Pisani, *Comptes Rendus*, 1864, 58, p. 714). Caesium is found in the mineral springs of Frankenhäusen, Montecatini, di Val di Nievole, Tuscany, and Wheai Clifford near Redruth, Cornwall (W. A. Miller, *Chem. News*, 1864, 10, p. 181), and, associated with rubidium, at Dürkheim; it is also found in lepidolite, leucite, petalite, triphylite and in the carnallite from Stassfurt. The separation of caesium from the minerals which contain it is an exceedingly difficult and laborious process. According to R. Bunsen, the best source of rubidium and caesium salts is the residue left after extraction of lithium salts from lepidolite. This residue consists of sodium, potassium and lithium chlorides, with small quantities of caesium and rubidium chlorides. The caesium and rubidium are separated from this by repeated fractional crystallization of their double platinum chlorides, which are much less soluble in water than those of the other alkali metals (R. Bunsen, *Ann.*, 1862, 122, p. 347, 1863, 125, p. 367). The platino-chlorides are reduced by hydrogen, and the caesium and rubidium chlorides extracted by water. See also A. Schrötter (*Jour. prak. Chem.*, 1864, 93, p. 2075) and W. Heintz (*Journ. prak. Chem.*, 1862, 87, p. 310). W. Feit and K. Kubierschky (*Chem. Zeit.*, 1892, 16, p. 335) separate rubidium and caesium from the other alkali metals by converting them into double chlorides with stannic chloride, whilst J. Redtenbacher (*Jour. prak. Chem.*, 1865, 94, p. 442) separates them from potassium by conversion into alums, which C. Setterberg (*Ann.*, 1882, 211, p. 100) has shown are very slightly soluble in a solution of potash alum. In order to separate caesium from rubidium, use is made of the different solubilities of their various salts. The bitartrates $RbHC_2H_3O_6$ and $CaHC_2H_3O_6$ have been employed, as have also the alums (see above). The double chloride of caesium and antimony $3CsCl \cdot 2SbCl_5$ (R. Godfrey, *Ber.*, 1874, 7, p. 375. *Ann.*, 1876, 181, p. 176) has been used, the corresponding compound not being formed by rubidium. The metal has been obtained by electrolysis of a mixture of caesium and barium cyanides (C. Setterberg, *Ann.*, 1882, 211, p. 100) and by heating the hydroxide with magnesium or aluminium (N. Beketoff, *Chem. Centralblatt*, 1889, 2, p. 245). L. Hackspill (*Comptes Rendus*, 1905, 141, p. 101) finds that metallic caesium can be obtained more readily by heating the chloride with metallic calcium. A special V-shaped tube is used in the operation, and the reaction commences between 400° C. and 500° C.

It is a silvery white metal which burns on heating in air. It melts at 26° to 27° C. and has a specific gravity of 1.88 (15°C.).

The atomic weight of caesium has been determined by the analysis of its chloride and bromide. Richards and Archibald (*Zeit. anorg. Chem.*, 1903, 34, p. 353) obtained 132.879 (O = 16).

Caesium hydroxide, $Cs(OH)_2$, obtained by the decomposition of the sulphate with barium water, is a greyish-white deliquescent solid, which melts at a red heat and absorbs carbon dioxide rapidly. It readily dissolves in water, with evolution of much heat. *Caesium chloride*, $CsCl$, is obtained by the direct action of chlorine on caesium, or by solution of the hydroxide in hydrochloric acid. It forms small cubes which melt at a red heat and volatilize readily. It deliquesces in moist air. Many double chlorides are known, and may be prepared by mixing solutions of the two components in the requisite proportions. The *bromide*, $CsBr$, and *iodide*, CsI , resemble the corresponding potassium salts. Many trihaloid salts of caesium are also known, such as $CsBr_3$, $CsClBr_2$, CsI_2 , $CsBrI_2$, $CsBr_2I$, &c. (H. L. Wells and S. L. Penfield, *Zeit. für anorg. Chem.*, 1892, 1, p. 85). *Caesium sulphate*, Cs_2SO_4 , may be prepared by dissolving the hydroxide or carbonate in sulphuric acid. It crystallizes in short hard prisms, which are readily soluble in water but insoluble in alcohol. It combines with many metallic sulphates (silver, zinc, cobalt, nickel, &c.) to form double sulphates of the type $Cs_2SO_4 \cdot RSO_4 \cdot 6H_2O$. It also forms a caesium-alum $Cs_2SO_4 \cdot Al_2(SO_4)_3 \cdot 24H_2O$. *Caesium nitrate*, $CsNO_3$, is obtained by dissolving the carbonate in nitric acid, and crystallizes in glittering prisms, which melt readily, and on heating evolve oxygen and leave a residue of caesium nitrite. The carbonate, Cs_2CO_3 , silicofluoride, Ca_2SiF_6 , borate, $Cs_3O \cdot 3B_2O_3$, and the sulphates $Cs_2S_4H_2O$, $Cs_4S_2 \cdot H_2O$, $Cs_3S_2 \cdot H_2O$, Cs_2S , and $Cs_2S_2 \cdot H_2O$ are also known.

Caesium compounds can be readily recognized by the two bright blue lines (of wave length 4555 and 4593) in their flame spectrum, but these are not present in the spark spectrum. The other lines include three in the green, two in the yellow, and two in the orange.

CAESPILOSE (Lat. *caespes*, a sod), a botanical term for "growing in tufts," like many grasses.

CAESTUS, or **CRESTUS** (from Lat. *caedo*, strike), a gauntlet or boxing-glove used by the ancient pugilists. Of this there were several varieties, the simplest and least dangerous being the *meilichae* (μειλικαί), which consisted of strips of raw hide tied round the palm, leaving the fingers bare. With these the athletes in the *palaestrae* were wont to practise, reserving for serious contests the more formidable kinds, such as the *sphaerae* (σφαίραι), which were sewn with small metal balls covered with leather, and the terrible *myrmekes* (μύρμηκες), sometimes called "limb-breakers" (γυνοτόποι), which were studded with heavy nails. The straps (μπαρες) were of different lengths, many reaching to the elbow, in order to protect the forearm when guarding heavy blows (see J. H. Krause, *Gymnastik und Agonistik der Hellenen*, 1841). The *caestus* is to be distinguished from *cestus* (αεστus, from αεστus), an adjective used as a noun in the sense of "girdle," especially the girdle of Aphrodite, which was supposed to have the power of exciting love.

CAESURA (Lat. for "cutting," Gr. ρυφή), in prosody, a rest or pause, usually occurring about the middle of a verse, which is thereby separated into two parts (μέλη, members). In Greek and Latin hexameters the best and most common caesura is the penthemimeral (i.e. after the 5th half-foot):

Μῆνυρ ἀ|λύει, θε|τέ|ε. | Πη|λυρία|δῖος Ἄρ|χι|λύθω
Arma vir|rumque ca|no, Tro|jae qui | primus ab | oris.

Another caesura very common in Homer, but rare in Latin verse, is after the 2nd syllable of the 3rd dactyl:

Ὀῖο|ποιεῖ| τε | κῆρ|ε|ς ἀ|θε| δ' ἔ|τε|κε|λυστε|ρ| βου|λά|ς

On the other hand, the hephthemimeral caesura (i.e. after the 7th half-foot) is common in Latin, but rare in Greek.

Formo|sam reso | nare doce|s Ama|ryllida | silvas.

The "bucolic" caesura, peculiar to Greek (so called because it is chiefly found in writers like Theocritus) occurs after the 4th dactyl:

Ἄδρα μοι | ἔννεπε, | Μοῦσα, το|κλειστόν, | θη μέ|λα | τολλά

In the pentameter verse of the elegiac distich the caesura is always penthemimeral. In the iambic trimeter (consisting of three dactyla or pairs of feet), both in Greek and Latin, the most usual caesura is the penthemimeral; next, the hephthemimeral:

Ἦ ῥα | τα Κῆδ|μον τοῦ | γάλα|ς | με | γράφω
Supplex | et o | ro reg | na per | Proser|pinae.

Verses in which neither of these caesuras occurs are considered faulty. On the other hand, secondary or subsidiary caesuras are found in both Greek and Latin; thus, a trithemimeral (after the 3rd half-foot) is combined with the hepthemimeral, which divides the verse into two unequal parts. A caesura is often called masculine when it falls after a long, feminine when it falls after a short syllable.

The best treatise on Greek and Latin metre for general use is L. Müller, *Die Metrik der Griechen und Römer* (1885); see also the article *Vsaa*.

CAFFEINE, or **TEKINE** (1.3.7 trimethyl 2.6 dioxypurin), $C_8H_{10}N_4O_2$, H_2O , a substance found in the leaves and beans of the coffee tree, in tea, in Paraguay tea, and in small quantities in cocoa and in the kola nut. It may be extracted from tea or coffee by boiling with water, the dissolved tannin precipitated by basic lead acetate, the solution filtered, excess of lead precipitated by sulphuretted hydrogen and the filtered liquid then evaporated to crystallization; or, tea is boiled with water, and the whole then evaporated to a syrup, which is mixed with slaked lime, evaporated to dryness on the water-bath and extracted with chloroform (P. Cazeneuve, *Bull. de la soc. chim. de Paris*, 1876-1877, 27, p. 199). Synthetically it may be prepared by the methylation of silver theobromine and silver theophyllin or by boiling heteroxanthine with methyl iodide and potash. E. Fischer and L. Ach (*Berichte*, 1895, 28, p. 3135) have synthesized it from dimethyl alloxan, whilst W. Traube (*Berichte*, 1900, 33, p. 3435) has obtained it from 1.3 diamethyl 4.5 diamino 2.6 dioxypyrimidine. On the constitution of caffeine see **PURIN** and also E. Fischer (*Annalen*, 1882, 215, p. 253).

Caffeine crystallizes in long silky needles, which are slightly soluble in cold water. It becomes anhydrous at 100° C. and melts at 234° to 235° C. It has a faint bitter taste and gives salts with mineral acids. On oxidation with nitric acid caffeine gives cholesterophane (dimethyl parabanic acid), but if chlorine water be used as the oxidant, then it yields monomethyl urea and dimethyl alloxan (E. Fischer).

CAFFIERI, JACQUES (1678-1755), French worker in metal, the most famous member of a family several of whom distinguished themselves in plastic art, was the fifth son of Philippe Caffieri (1634-1716), a decorative sculptor, who, after serving Pope Alexander VII., entered the service of Louis XIV. in 1660. An elder son of Philippe, François Charles (1667-1721), was associated with him. As a *fondeur ciseleur*, however, the renown of the house centred in Jacques, though it is not always easy to distinguish between his own work and that of his son Philippe (1714-1777). A large proportion of his brilliant achievement as a designer and chaser in bronze and other metals was executed for the crown at Versailles, Fontainebleau, Compiègne, Choisy and La Muette, and the crown, ever in his debt, still owed him money at his death. Jacques and his son Philippe undoubtedly worked together in the "Appartement du Dauphin" at Versailles, and although much of their contribution to the palace has disappeared, the decorations of the marble chimney-piece still remain. They belong to the best type of the Louis XV. style—vigorous and graceful in design, they are executed with splendid skill. It is equally certain that father and son worked together upon the gorgeous bronze case of the famous astronomical clock made by Passement and Dantiaiu for Louis XV. between 1749 and 1753. The form of the case has been much criticized, and even ridiculed, but the severest critics in that particular have been the readiest to laud the boldness and freedom of the motives, the jewel-like finish of the craftsmanship, the magnificent dexterity of the master-hand. The elder Caffieri was, indeed, the most consummate practitioner of the *style rocaille*, which he constantly redeemed from its mannered conventionalism by the ease and mastery with which he treated it. From the studio in which he and his son worked side by side came an amazing amount of work, chiefly in the shape of those gilded bronze mounts which in the end became more insistent than the pieces of furniture which they adorned. Little of his achievement was ordinary; an astonishingly large proportion of it is famous. There is in the Wallace collection (Hertford House, London) a

commode from the hand of Jacques Caffieri in which the brilliance and spontaneity, the sweeping boldness and elegance of line that mark his style at its best, are seen in a perfection hardly exceeded in any other example. Also at Hertford House is the exceptionally fine lustre which was a wedding present from Louis XV. to Louise, Elizabeth of France. After Jacques' death his son Philippe continued to work for the crown, but had many private clients. He made a great cross and six candlesticks for the high altar of Notre Dame, which disappeared in the revolution, but similar work for Bayeux cathedral still exists. A wonderful enamelled toilet set which he executed for the Princess of Asturias has also disappeared. Philippe's style was gradually modified into that which prevailed in the third quarter of the 18th century, since by 1777, when he died, the taste for the magnificent mounts of his early days had passed away. Like his father, he drew large sums from the crown, usually after giving many years' credit, while many other years were needed by his heirs to get in the balance of the royal indebtedness. Philippe's younger brother, Jean Jacques Caffieri (1725-1792), was a sculptor, but was sufficiently adept in the treatment of metals to design the fine *rampe d'escalier* which still adorns the Palais Royal.

CAFTAN, or **KAPTAN** (a Turkish word, also in use in Persia), a tunic or under-dress with long hanging sleeves, tied with a girdle at the waist, worn in the East by persons of both sexes. The caftan was worn by the upper and middle classes in Russia till the time of Peter the Great, when it was generally discarded.

CAGLI, a town and (with Pergola) an episcopal see of the Marches, Italy, in the province of Pesaro and Urbino, 18 m. S. of the latter town by rail, and 830 ft. above sea-level. Pop. (1901) of town, 4628; commune, 12,533. The church of S. Domenico contains a good fresco (Madonna and saints) by Giovanni Santi, the father of Raphael. The citadel of the 15th century, constructed by Francesco di Giorgio Martini of Siena, is on the S.E. of the modern town. Cagli occupies the site of an ancient *vicus* (village) on the Via Flaminia, which seems to have borne the name Cale, 24 m. N. of Helvillum (mod. *Sigillo*) and 18 m. S.W. of Forum Sempronii (mod. *Fossombrone*). Below the town to the north is a single arched bridge of the road, the arch having the span of 38½ ft. (See G. Mochi, *Storia di Cagli*, Cagli, 1878.) About 5 m. to the N.N.W. of Cagli and 2½ m. W. of the Via Flaminia at the mod. *Acqualagna* is the site of an ancient town; the place is now called *piano di Valeria*, and is scattered with ruins. Inscriptions show that this was a Roman *municipium*, perhaps Pitinum Mergens (*Corp. Inscr. Lat. xi.* [Berlin, 1901] p. 876). Three miles north of Acqualagna the Via Flaminia, which is still in use as the modern high-road, traverses the Furlo Pass, a tunnel about 40 yds. long, excavated by Vespasian in A.D. 77, as an inscription at the north end records. There is another tunnel at lower level, which belongs to an earlier date; this seems to have been in use till the construction of the Roman road, which at first ran round the rock on the outside, until Vespasian cut the tunnel. In repairing the modern road just outside the south entrance to the tunnel, a stratum of carbonized corn, beans, &c., and a quantity of burnt wood, stones, tiles, pottery, &c., was found under and above the modern road, for a distance of some 500 yds. This debris must have belonged to the castle of Petra Pertusa, burned by the Lombards in 570 or 571 on their way to Rome. The castle itself is mentioned by Procopius (*Bell. Goth.* ii. 11, iii. 6, iv. 28, 34). Here also was found the inscription of A.D. 295, relating to the measures taken to suppress brigandage in these parts. (See **APENNINES**.) See A. Vernarecci in *Notizie degli Scavi*, 1886, 411 (cf. *ibid.* 227); *Corp. Inscr. Lat.* (Berlin, 1901), Nos. 6106, 6107. (T. As.)

CAGLIARI (anc. *Carales*), the capital of the island of Sardinia, an archiepiscopal see, and the chief town of the province of Cagliari, which embraces the southern half of the island. It is 270 m. W.S.W. of Naples, and 375 m. south of Genoa by sea. Pop. (1900) of town, 48,098; of commune, 53,057. It is finely situated at the northern extremity of the Gulf of Cagliari, in the centre of the south coast of the island. The mediæval town occupies a long narrow hill running N. and S. with precipitous

cliffs on the E. and W. which must have been the ancient acropolis, but the modern town, like the Roman town before it, extends to the slopes of the hill and to the low ground by the sea. On each side of the town are lagoons. That of S. Gilla on the W., which produces fish in abundance, was originally an open bay. That of Molentargius on the E. has large salt-pans. The upper town still retains in part its fortifications, including the two great towers at the two extremities, called the Torre dell' Elefante (S.) and the Torre di S. Pancrazio (N.), both erected by the Pisans, the former in 1307, the latter in 1305. The Torre di S. Pancrazio at the highest point (367 ft. above sea-level) commands a magnificent view. Close to it is the archaeological museum, the most important in the island. To the north of it are the modern citadel and the barracks, and beyond, a public promenade. The narrow streets run from north to south for the whole length of the upper town. On the edge of the cliffs on the E. is the cathedral, built in 1257-1312 by the Pisans, and retaining two of the original transept doors. The pulpit of the same period is also fine: it now stands, divided into two, on each side of the entrance, while the lions which supported it are on the balustrade in front of the cathedral (see E. Brunelli in *L'Arte*, Rome, 1901, 59; D. Scano, *ibid.* 204). Near the sacristy are also some Gothic chapels of the Aragonese period. The church was, however, remodelled in 1676, and the interior is baroque. Two fine silver candelabra, the tabernacle and the altar front are of the 17th century; and the treasury also contains some good silver work. (See D. Scano in *Bollettino d'Arte*, February 1907, p. 14; and E. Brunelli in *L'Arte*, 1907, p. 47.) The crypt contains three ancient sarcophagi. The façade, in the baroque style, was added in 1703. The university, a little farther north, the buildings of which were erected in 1764, has some 240 students. At the south extremity of the hill, on the site of the bastion of south Caterina, a large terrace, the Passeggiata Umberto Primo, has been constructed: it is much in use on summer evenings, and has a splendid view. Below it are covered promenades, and from it steps descend to the lower town, the oldest part of which (the so-called Marina), sloping gradually towards the sea, is probably the nucleus of the Roman *mansio-cipium*, while the quarter of Stampace lies to the west, and beyond it again the suburb of Sant' Avendrace. The northern portion of this, below the castle hill, is the older, while the part near the shore consists mainly of modern buildings of no great interest. To the east of the castle hill and the Marina is the quarter of Villanova, which contains the church of S. Saturnino, a domed church of the 8th century with a choir of the Pisan period. The harbour of Cagliari (along the north side of which runs a promenade called the Via Romo) is a good one, and has a considerable trade, exporting chiefly lead, zinc and other minerals and salt, the total annual value of exports amounting to nearly 1½ million sterling in value. The Campidano of Cagliari, the plain which begins at the north end of the lagoon of S. Gilla, is very fertile and much cultivated, as is also the district to the east round Quarto S. Elena, a village with 8459 inhabitants (1901). The national costumes are rarely now seen in the neighbourhood of Cagliari, except at certain festivals, especially that of S. Efasio (May 1-4) at Pula (see Noza). The methods of cultivation are primitive: the curious water-wheels, made of brushwood with pots tied on to them, and turned by a blindfolded donkey, may be noted. The ox-carts are often made with solid wheels, for greater strength. Prickly pear (*opuntia*) hedges are as frequent as in Sicily. Cagliari is considerably exposed to winds in winter, while in summer it is almost African in climate. The aqueduct was constructed in quite recent times, rain-water having previously given the only supply. The main line of railway runs north to Decimomannu (for Iglesias), Oristano, Macomer and Chivivani (for Golfo degli Aranci and Sassari); while another line (narrow-gauge) runs to Mandas (for Sorgono and Tortoli). There is also a tramway to Quarto S. Elena.

In A.D. 485 the whole of Sardinia was taken by the Vandals from Africa; but in 533 it was retaken by Justinian. In 687 Cagliari rose against the East Roman emperors, under Gialetus, one of the citizens, who made himself king of the whole island,

his three brothers becoming governors of Torres (in the N.W.), Arborea (in the S.W.) and Gallura (in the N.E. of the island). The Saracens devastated it in the 8th century, but were driven out, and the island returned to the rule of kings, until they fell in the 10th century, their place being taken by four "judges" of the four provinces, Cagliari, Torres, Arborea and Gallura. In the 12th century Musatto, a Saracen, established himself in Cagliari, but was driven out with the help of the Pisans and Genoese. The Pisans soon acquired the sovereignty over the whole island with the exception of Arborea, which continued to be independent. In 1297 Boniface VIII. invested the kings of Aragon with Sardinia, and in 1326 they finally drove the Pisans out of Cagliari, and made it the seat of their government. In 1348 the island was devastated by the plague described by Boccaccio. It was not until 1403 that the kings of Aragon were able to conquer the district of Arborea, after the celebrated Eleonora (whose code of laws—the so-called *Carta de Logu*—was famous), offered a heroic resistance. In 1479 the native princes were deprived of all independence. The island remained in the hands of Spain until the peace of Utrecht (1714), by which it was assigned to Austria. In 1720 it was ceded by the latter, in exchange for Sicily, to the duke of Savoy, who assumed the title of king of Sardinia (Cagliari continuing to be the seat of government), and this remained the title of the house of Savoy until 1861. Cagliari was bombarded by the French fleet in 1793, but Napoleon's attempt to take the island failed. (T. As.)

CAGLIOSTRO, ALESSANDRO, COUVR (1743-1795), Italian alchemist and impostor, was born at Palermo on the 8th of June 1743. Giuseppe Balsamo—for such was the "count's" real name—gave early indications of those talents which afterwards gained for him so wide a notoriety. He received the rudiments of his education at the monastery of Caltagirone in Sicily, but was expelled from it for misconduct and disowned by his relations. He now signalized himself by his dissolute life and the ingenuity with which he contrived to perpetrate forgeries and other crimes without exposing himself to the risk of detection. Having at last got into trouble with the authorities he fled from Sicily, and visited in succession Greece, Egypt, Arabia, Persia, Rhodes—where he took lessons in alchemy and the cognate sciences from the Greek Althotas—and Malta. There he presented himself to the grand master of the Maltese order as Count Cagliostro, and carried favour with him as a fellow alchemist, for the grand master's tastes lay in the same direction. From him he obtained introductions to the great houses of Rome and Naples, whither he now hastened. At Rome he married a beautiful but unprincipled woman, Lorenza Feliciani, with whom he travelled, under different names, through many parts of Europe. It is unnecessary to recount the various infamous means which he employed to pay his expenses during these journeys. He visited London and Paris in 1771, selling love-philtres, elixirs of youth, mixtures for making ugly women beautiful, alchemistic powders, &c., and deriving large profits from his trade. After further travels on the continent he returned to London, where he posed as the founder of a new system of freemasonry, and was well received in the best society, being adored by the ladies. He went to Germany and Holland once more, and to Russia, Poland, and then again to Paris, where, in 1785, he was implicated in the affair of the Diamond Necklace (q.v.); and although Cagliostro escaped conviction by the matchless impudence of his defence, he was imprisoned for other reasons in the Bastille. On his liberation he visited England once more, where he succeeded well at first; but was ultimately outwitted by some English lawyers, and confined for a while in the Fleet prison. Leaving England, he travelled through Europe as far as Rome, where he was arrested in 1789. He was tried and condemned to death for being a heretic, but the sentence was commuted to perpetual imprisonment, while his wife was immured in a convent. He died in the fortress prison of San Leo in 1795.

The best account of the life, adventures and character of Giuseppe Balsamo is contained in Carlyle's *Miscellaneous*. Dumas's novel, *Memoirs of a Physician*, is founded on his adventures: see also a

series of papers in the *Dublin University Magazine*, vols. Ixxviii. and Ixxix.: *Mémorial, or Brief for Cagliostro in the Cause of Card. de Rohan*, &c. (Fr.) by P. MacMahon (1786); *Compendio della vita e delle gesta di Giuseppe Balsamo denominato il conte di Cagliostro* (Rome, 1791); Sierke, *Schwärmer und Schwindler im Ende des XVIII. Jahrhunderts* (1875); and the sketch of his life in D. Savigni's *La Coris e la Società Romana nei secoli XVIII. e XIX.* (L. V.) (Florence, 1881).

CAGNIARD DE LA TOUR, CHARLES (1777-1859), French engineer and physicist, was born in Paris on the 31st of March 1777, and after attending the École Polytechnique became one of the *ingénieurs géographiques*. He was made a baron in 1818, and died in Paris on the 5th of July 1859. He was the author of numerous inventions, including the cagniardelle, a blowing machine, which consists essentially of an Archimedean screw set obliquely in a tank of water in such a way that its lower end is completely and its upper end partially immersed, and operated by being rotated in the opposite direction to that required for raising water. In acoustics he invented, about 1819, the improved siren which is known by his name, using it for ascertaining the number of vibrations corresponding to a sound of any particular pitch, and he also made experiments on the mechanism of voice-production. In course of an investigation in 1822-1823 on the effects of heat and pressure on certain liquids he found that for each there was a certain temperature above which it refused to remain liquid but passed into the gaseous state, no matter what the amount of pressure to which it was subjected, and in the case of water he determined this critical temperature, with a remarkable approach to accuracy, to be 362° C. He also studied the nature of yeast and the influence of extreme cold upon its life.

CAGNOLA, LUIGI, MARCHESE (1762-1833), Italian architect, was born on the 9th of June 1762 in Milan. He was sent at the age of fourteen to the Clementine College at Rome, and afterwards studied at the university of Pavia. He was intended for the legal profession, but his passion for architecture was too strong, and after holding some government posts at Milan, he entered as a competitor for the construction of the Porta Orientale. His designs were commended, but were not selected on account of the expense their adoption would have involved. From that time Cagnola devoted himself entirely to architecture. After the death of his father he spent two years in Verona and Venice, studying the architectural structures of these cities. In 1806 he was called upon to erect a triumphal arch for the marriage of Eugène Beauharnais with the princess of Bavaria. The arch was of wood, but was of such beauty that it was resolved to carry it out in marble. The result was the magnificent Arco della Pace in Milan, surpassed in dimensions only by the Arc de l'Étoile at Paris. Among other works executed by Cagnola are the Porta di Marengo at Milan, the campanile at Urgnano, and the chapel of Santa Marcellina in Milan. He died on the 14th of August 1833, five years before the completion of the Arco del Sempione, which he designed for his native city.

CAGOTS, a people found in the Basque provinces, Béarn, Gascony and Brittany. The earliest mention of them is in 1288, when they appear to have been called Christiens or Christianos. In the 16th century they had many names, Cagots, Gahets, Gafets in France; Agotes, Gafos in Spain; and Cacons, Cahets, Caqueux and Caquins in Brittany. During the middle ages they were popularly looked upon as cretins, lepers, heretics and even as cannibals. They were shunned and hated; were allotted separate quarters in towns, called *cagoterics*, and lived in wretched huts in the country distinct from the villages. Excluded from all political and social rights, they were only allowed to enter a church by a special door, and during the service a rail separated them from the other worshippers. Either they were altogether forbidden to partake of the sacrament, or the holy wafer was handed to them on the end of a stick, while a receptacle for holy water was reserved for their exclusive use. They were compelled to wear a distinctive dress, to which, in some places, was attached the foot of a goose or duck (whence they were sometimes called *Canards*). And so pestilential was their touch considered that it was a crime for them to walk the common road barefooted. The

only trades allowed them were those of butcher and carpenter, and their ordinary occupation was wood-cutting. Their language is merely a corrupt form of that spoken around them; but a Teutonic origin seems to be indicated by their fair complexions and blue eyes. Their crania have a normal development; their cheek-bones are high; their noses prominent, with large nostrils; their lips straight; and they are marked by the absence of the auricular lobules.

The origin of the Cagots is undecided. Littré defines them as "a people of the Pyrenees affected with a kind of cretinism." It has been suggested that they were descendants of the Visigoths, and Michael derives the name from *caas* (dog) and *Goth*. But opposed to this etymology is the fact that the word *cagot* is first found in the *for* of Béarn not earlier than 1551. Marcq, in his *Histoire de Béarn*, holds that the word signifies "hunters of the Goths," and that the Cagots are descendants of the Saracens. Others made them descendants of the Albigenses. The old MSS. call them *Chrétians* or *Chrestians*, and from this it has been argued that they were Visigoths who originally lived as Christians among the Gascon pagans. A far more probable explanation of their name "Chrétians" is to be found in the fact that in medieval times all lepers were known as *pauperes Christi*, and that; Goths or not, these Cagots were affected in the middle ages with a particular form of leprosy or a condition resembling it. Thus would arise the confusion between Christians and Cretins. To-day their descendants are not more subject to goitre and cretinism than those dwelling around them, and are recognized by tradition and not by features or physical degeneracy. It was not until the French Revolution that any steps were taken to ameliorate their lot, but to-day they no longer form a class, but have been practically lost sight of in the general peasantry.

See Francisque Michel, *Histoire des races maudites de France et d'Espagne* (Paris, 1846); Abbé Venuit, *Recherches sur les Cahets de Bordeaux* (1754); *Bulletins de la société anthropologique* (1861, 1867, 1868, 1871); *Annales medico-psychologiques* (Jan. 1867); Lagneau, *Questionnaire sur l'éthnologie de la France*; Paul Raymond, *Mœurs béarnaises* (Pau, 1872); V. de Rochas, *Les Parias de France et d'Espagne (Cagots et Bakhtiens)* (Paris, 1877); J. Hack Tuke, *Jour. Anthropological Institute* (vol. ix., 1880).

CAHER (or **CAHR**), a market-town of Co. Tipperary, Ireland, in the south parliamentary division, beautifully situated on the river Suir at the foot of the Galtee Mountains. Pop. (1901) 2058. It stands midway between Clonmel and Tipperary town on the Waterford and Limerick line of the Great Southern and Western railway, 124 m. S.W. from Dublin. It is the centre of a rich agricultural district, and there is some industry in flour-milling. Its name (*calhair*, stone fortress) implies a high antiquity and the site of the castle, picturesquely placed on an island in the river, was occupied from very early times. Here was a fortress-palace of Munster, originally called *Dun-iasgach*, the suffix signifying "abounding in fish." The present castle dates from 1142, being built by O'Connor, lord of Thomond, and is well restored. It was besieged during the wars of 1599 and 1647, and by Cromwell. Among the fine environs of the town the demesne of Caher Park is especially noteworthy. The Mitchelstown stalactite caverns, 10 m. S.W., and the finely-placed Norman castle of Ardinnan, on a precipitous crag 6 m. down the Suir, are other neighbouring features of interest, while the Galtee Mountains, reaching in Galtymore a height of 3055 ft., command admirable prospects.

CAHITA, a group of North American Indians, mainly of the Mayo and Yaqui tribes, found chiefly in Mexico, belonging to the Piman family, and numbering some 40,000.

CAHOKIA, the name of a North American Indian tribe of the Illinois confederacy, and of their mission station, near St. Louis. The "Cahokia mound" there (a model of which is in the Peabody Museum, Cambridge, Mass.) is interesting as the largest pre-historic earth-work in America.

CAHORS, a city of south-western France, capital of the department of Lot, 70 m. N. of Toulouse, on the railway between that city and Limoges. Pop. (1906) 10,047. Cahors stands on the right bank of the river Lot, occupying a rocky peninsula formed by a bend in the stream. It is divided into two portions

by the Boulevard Gambetta, which runs from the Pont Louis Philippe on the south to within a short distance of the fortified wall of the 14th and 15th centuries enclosing the town on the north. To the east lies the old town, with its dark narrow streets and closely-packed houses; west of the Boulevard a newer quarter, with spacious squares and promenades, stretches to the bank of the river. Cahors communicates with the opposite shore by three bridges. One of these, the Pont Valentré to the west of the town, is the finest fortified bridge of the middle ages in France. It is a structure of the early 14th century, restored in the 19th century, and is defended at either end by high machicolated towers, another tower, less elaborate, surmounting the centre pier. The east bridge, the Pont Neuf, also dates from the 14th century. The cathedral of St Étienne stands in the heart of the old town. It dates from the 12th century, but was entirely restored in the 13th century. Its exterior, for the most part severe in appearance, is relieved by some fine sculpture, that of the north portal being especially remarkable. The nave, which is without aisles, is surmounted by two cupolas; its interior is whitewashed and plain in appearance, while the choir is decorated with medieval paintings. Adjoining the church to the south-east there are remains of a cloister built from 1494 to 1500. St Ursisse, the chief of the other ecclesiastical buildings, stands near the cathedral. Dating from the 12th and 13th centuries, it preserves Romanesque capitals recarved in the 14th century. The principal of the civil buildings is the palace of Pope John XXII., built at the beginning of the 14th century; a massive square tower is still standing, but the rest is in ruins. The residence of the seneschals of Quercy, a building of the 14th to the 17th centuries, known as the Logis du Roi, also remains. The chief of the old houses, of which there are many in Cahors, is one of the 15th century, known as the Maison d'Henri IV. Most of the state buildings are modern, with the exception of the prefecture which occupies the old episcopal palace, and the old convent and the Jesuit college in which the Lycée Gambetta is established. The Porte de Diane is a large archway of the Roman period, probably the entrance to the baths. Of the commemorative monuments, the finest is that erected in the Place d'Armes to Gambetta, who was a native of the town. There is also a statue of the poet Clément Marot, born at Cahors in 1496. Cahors is the seat of a bishopric, a prefect and a court of assizes. It has tribunals of first instance and of commerce, a chamber of commerce and a branch of the Bank of France. There are also training colleges, a lycée, a communal college for girls, an ecclesiastical seminary, a library, museum and hospital. The manufacture of farm implements, tanning, wool-spinning, metal-founding, distilling and the preparation of *plû de foie gras* and other delicacies are carried on. Wine, nuts, oil of nuts, tobacco, truffles and plums are leading articles of commerce.

History.—Before the Roman conquest, Cahors, which grew up near the sacred fountain of Divona (now known as the Fontaine des Chartreux), was the capital of the Cadurci. Under the Romans it enjoyed a prosperity partly due to its manufacture of cloth and of mattresses, which were exported even to Rome. The first bishop of Cahors, St Genulfus, appears to have lived in the 3rd century. In the middle ages the town was the capital of Quercy, and its territory until after the Albigensian Crusade was a fief of the counts of Toulouse. The seigniorial rights, including that of coining money, belonged to the bishops. In the 13th century Cahors was a financial centre of much importance owing to its colony of Lombard bankers, and the name *cahorsin* consequently came to signify "banker" or "usurer." At the beginning of the century a commune was organized in the town. Its constant opposition to the bishops drove them, in 1316, to come to an arrangement with the French king, by which the administration of the town was placed almost entirely in the hands of royal officers, king and bishop being co-seigneurs. This arrangement survived till the Revolution. In 1331 Pope John XXII., a native of Cahors, founded there a university, which afterwards numbered Jacques Cujas among its teachers and François Fénelon among its students. It flourished till 1751, when it was united to its rival the university of Toulouse.

During the Hundred Years' War, Cahors, like the rest of Quercy, consistently resisted the English occupation, from which it was relieved in 1428. In the 16th century it belonged to the viscounts of Béarn, but remained Catholic and rose against Henry of Navarre who took it by assault in 1580. On his accession Henry IV. punished the town by depriving it of its privileges as a wine-market; the loss of these was the chief cause of its decline.

CAIATIA (mod. *Caiano*), an ancient city of Campania, on the right bank of the Volturnus, 11 m. N.E. of Capua, on the road between it and Telesia. It was already in the hands of the Romans in 306 B.C., and since in the 3rd century B.C. it issued copper coins with a Latin legend it must have had the *civitas sine suffragio*. In the Social War it rebelled from Rome, and its territory was added to that of Capua by Sulla. In the imperial period, however, we find it once more a *municipium*. Caiatia has remains of Cyclopean walls, and under the Piazza del Mercato is a large Roman cistern, which still provides a good water supply. The episcopal see was founded in A.D. 966. The place is frequently confused with Calatia (q.v.).

CAIETAE PORTUS (mod. *Caeta*), an ancient harbour of *Latinum adiectum*, Italy, in the territory of Formiæ, from which it is 5 m. S.W. The name (originally *Altra*) is generally derived from the nurse of Aeneas. The harbour, owing to its fine anchorage, was much in use, but the place was never a separate town, but always dependent on Formiæ. Livy mentions a temple of Apollo. The coast of the Gulf not only between Caietæ Portus and Formiæ, but E. of the latter also, as far as the modern Monte Scauri, was a favourite summer resort (see FORMIÆ). Cicero may have had villas both at Portus Caietæ and at Formiæ proper, and the emperors certainly possessed property at both places. After the destruction of Formiæ in A.D. 847 it became one of the most important seaports of central Italy (see GARFA). In the town are scanty remains of an amphitheatre and theatre: near the church of La Trinità, higher up, are remains of a large reservoir. There are also traces of an aqueduct. The promontory (548 ft.) is crowned by the tomb of Munatius Plancus, founder of Lugudunum (mod. Lyons), who died after 22 B.C. It is a circular structure of blocks of travertine 160 ft. high and 180 ft. in diameter. Further inland is the so-called tomb of L. Atratinus, about 700 ft. in diameter. Caietæ Portus was no doubt connected with the Via Appia (which passed through Formiæ) by a *devericalium*. There seems also to have been a road running W.N.W. along the precipitous coast to Spelunca (mod. Sperlonga).

See E. Gualdo *Osservazioni critiche sopra la storia della Via Appia di Pratiis*, p. 7 (Naples, 1754). (T. As.)

CAILLIÉ (or **CAILLÉ**), **RENÉ AUGUSTE** (1799-1838), French explorer, was born at Mauzé, Poitou, in 1799, the son of a baker. The reading of *Robinson Crusoe* kindled in him a love of travel and adventure, and at the age of sixteen he made a voyage to Senegal whence he went to Guadeloupe. Returning to Senegal in 1818 he made a journey to Bondou to carry supplies to a British expedition then in that country. Ill with fever he was obliged to go back to France, but in 1824 was again in Senegal with the fixed idea of penetrating to Timbuktu. He spent eight months with the Brakna "Moors" living north of Senegal river, learning Arabic and being taught, as a convert, the laws and customs of Islam. He laid his project of reaching Timbuktu before the governor of Senegal, but receiving no encouragement went to Sierra Leone where the British authorities made him superintendent of an indigo plantation. Having saved £80 he joined a Mandingo caravan going inland. He was dressed as a Mussulman, and gave out that he was an Arab from Egypt who had been carried off by the French to Senegal and was desirous of regaining his own country. Starting from Kakundi near Boké on the Rio Nunez on 19th of April 1827, he travelled east along the hills of Futa Jallon, passing the head streams of the Senegal and crossing the Upper Niger at Kurussa. Still going east he came to the Kong highlands, where at a place called Timé he was detained five months by illness. Resuming his journey

The two places are sufficiently close for the one villa to have borne both names; but Mommsen (*Corp. Inscr. Lat.* 2, Berlin, 1883, p. 603) prefers to differentiate them.

In January 1828 he went north-east and gained the city of Jenné, whence he continued his journey to Timbuktu by water. After spending a fortnight (20th April-4th May) in Timbuktu he joined a caravan crossing the Sahara to Morocco, reaching Fez on the 12th of August. From Tangier he returned to France. He had been preceded at Timbuktu by a British officer, Major Gordon Laing, but Laing had been murdered (1826) on leaving the city and Caillié was the first to accomplish the journey in safety. He was awarded the prize of £400 offered by the Geographical Society of Paris to the first traveller who should gain exact information of Timbuktu, to be compared with that given by Mungo Park. He also received the order of the Legion of Honour, a pension, and other distinctions, and it was at the public expense that his *Journal d'un voyage à Tombouctou et à Jenné dans l'Afrique Centrale*, etc. (edited by E. F. Jomard) was published in three volumes in 1830. Caillié died at Badère in 1838 of a malady contracted during his African travels. For the greater part of his life he spelt his name Caillié, afterwards omitting the second "i."

See Dr Robert Brown's *The Story of Africa*, vol. i. chap. xii. (London, 1892); Goepff and Cordier, *Les Grands Hommes de France, voyageurs: René Caillié* (Paris, 1885); E. F. Jomard, *Notice historique sur la vie et les voyages de R. Caillié* (Paris, 1839). An English version of Caillié's *Journal* was published in London in 1830 in two volumes under the title of *Travels through Central Africa to Timbuktoo, &c.*

CAIN, in the Bible, the eldest son of Adam and Eve (Gen. iv.), was a tiller of the ground, whilst his younger brother, Abel, was a keeper of sheep. Enraged because the Lord accepted Abel's offering, and rejected his own, he slew his brother in the field (see ABEL). For this a curse was pronounced upon him, and he was condemned to be a "fugitive and a wanderer" on the earth, a mark being set upon him "lest any finding him should kill him." He took up his abode in the land of Nod ("wandering") on the east of Eden, where he built a city, which he named after his son Enoch. The narrative presents a number of difficulties, which early commentators sought to solve with more ingenuity than success. But when it is granted that the ancient Hebrews, like other primitive peoples, had their own mythical and traditional figures, the story of Cain becomes less obscure. The mark set upon Cain is usually regarded as some tribal mark or sign analogous to the cattle marks of Bedouin and the related usages in Europe. Such marks had often a religious significance, and denoted that the bearer was a follower of a particular deity. The suggestion has been made that the name Cain is the eponym of the Kenites, and although this clan has a good name almost everywhere in the Old Testament, yet in Num. xxiv. 22 its destruction is foretold, and the Amalekites, of whom they formed a division, are consistently represented as the inveterate enemies of Yahweh and of his people Israel. The story of Cain and Abel, which appears to represent the nomad life as a curse, may be an attempt to explain the origin of an existence which in the eyes of the settled agriculturist was one of continual restlessness, whilst at the same time it endeavours to find a reason for the institution of blood-revenge on the theory that at some remote age a man (or tribe) had killed his brother (or brother tribe). Cain's subsequent founding of a city finds a parallel in the legend of the origin of Rome through the swarms of outlaws and broken men of all kinds whom Romulus attracted thither. The list of Cain's descendants reflects the old view of the beginnings of civilization; it is thrown into the form of a genealogy and is parallel to Gen. v. (see GENESIS). It finds its analogy in the Phœnician account of the origin of different inventions which Eusebius (*Præp. Evang.* i. 10) quotes from Philo of Byblus (Gebal), and probably both go back to a common Babylonian origin.

On this question, see Driver, *Genesis* (Westminster Comm., London, 1904), p. 80 seq.; A. Jeremias, *Alle Test. im Lichte d. Allen Orients* (Leipzig, 1906), pp. 220 seq.; also ENOCH, LAMECH. On the story of Cain, see especially Stade, *Akademische Reden*, pp. 229-273; Ed. Meyer, *Israeliten*, pp. 395 seq.; A. R. Gordon, *Early Trad. Genesis* (Index). Literary criticism (see Cheyne, *Encycl. Bib.* col. 620-628, and 4411-4417) has made it extremely probable that Cain the nomad and outlaw (Gen. iv. 1-16) was originally distinct from Cain the city-builder (vv. 17 seq.). The latter was perhaps regarded as a "smith," cp. v. 22 where Tubal-cain is the "father" of those who

work in bronze (or copper). That the Kenites, too, were a race of metal-workers is quite uncertain, although even at the present day the smiths in Arabia form a distinct nomadic class. Whatever be the meaning of the name, the words put into Eve's mouth (v. 1) probably are not an etymology, but an assonance (Driver). It is noteworthy that Kenan, son of Enoch ("man," Gen. v. 9), appears in Sabæan inscriptions of South Arabia as the name of a tribal-god.

A Gnostic sect of the 2nd century was known by the name of Cainites. They are first mentioned by Irenæus, who connects them with the Valentinians. They believed that Cain derived his existence from the superior power, and Abel from the inferior power, and that in this respect he was the first of a line which included Esau, Korah, the Sodomites and Judas Iscariot. (S. A. C.)

CAINE, THOMAS HENRY HALL (1853-), British novelist and dramatist, was born of mixed Manx and Cumberland parentage at Runcorn, Cheshire, on the 14th of May 1853. He was educated with a view to becoming an architect, but turned to journalism, becoming a leader-writer on the *Liverpool Mercury*. He came up to London at the suggestion of D. G. Rossetti, with whom he had had some correspondence, and lived with the poet for some time before his death. He published a volume of *Recollections of Rossetti* (1882), and also some critical work; but in 1885 he began an extremely successful career as a novelist of a melodramatic type with *The Shadow of a Crime*, followed by *The Son of Hagar* (1886), *The Deemster* (1887), *The Bondman* (1890), *The Scapegoat* (1891), *The Manxman* (1894), *The Christian* (1897), *The Eternal City* (1901), and *The Prodigal Son* (1904). His writings on Manx subjects were acknowledged by his election in 1901 to represent Ramsey in the House of Keys. *The Deemster*, *The Manxman* and *The Christian* had already been produced in dramatic form, when *The Eternal City* was staged with magnificent accessories by Mr Beerbohm Tree in 1902, and in 1905 *The Prodigal Son* had a successful run at Drury Lane.

See C. F. Kenyon, *Hall Caine; The Man and the Novelist* (1901); and the novelist's autobiography, *My Story* (1908).

CA'ING WHALE (*Globicephalus melas*), a large representative of the dolphin tribe frequenting the coasts of Europe, the Atlantic coast of North America, the Cape and New Zealand. From its nearly uniform black colour it is also called the "black-fish." Its maximum length is about 20 ft. These cetaceans are gregarious and inoffensive in disposition and feed chiefly on cuttle-fish. Their sociable character constantly leads to their destruction, as when attacked they instinctively rush together, and blindly follow the leaders of the herd, whence the names pilot-whale and ca'ing (or driving) whale. Many hundreds at a time are thus frequently driven ashore and killed, when a herd enters one of the bays or fords of the Faeroe Islands or north of Scotland. The ca'ing whale of the North Pacific has been distinguished as *G. scammoni*, while one from the Atlantic coast, south of New Jersey, and another from the bay of Bengal, are possibly also distinct. (See CETACEA.)

CAINOZOIC (from the Gr. *kainos*, recent, *ζωή*, life), also written Cenozoic (American), *Kainozoisch*, *Cainozoisch* (German), *Cénozoïque* (Renevier), in geology, the name given to the youngest of the three great eras of geological time, the other two being the Mesozoic and Palæozoic eras. Some authors have employed the term "Neozoic" (*Neozoisch*) with the same significance, others have restricted its application to the Tertiary epoch (*Neozoïque*, De Lapparent). The "Neogene" of Hòrnes (1853) included the Miocene and Pliocene periods; Renevier subsequently modified its form to *Neogénique*. The remaining Tertiary periods were classed as Paléogène by Naumaun in 1866. The word "Neocene" has been used in place of Neozoic, but its employment is open to objection.

Some confusion has been introduced by the use of the term Cainozoic to include, on the one hand, the Tertiary period alone, and on the other hand, to make it include both the Tertiary and the post-Tertiary or Quaternary epochs; and in order that it may bear a relationship to the concepts of time and faunal development similar to those indicated by the terms Mesozoic and Palæozoic it is advisable to restrict its use to the latter alternative. Thus the Cainozoic era would embrace all the geological periods from Eocene to Recent. (See TERTIARY and PLEISTOCENE.)

(J. A. H.)

CAÏQUE (from Turk. *Kaïk*), a light skiff or rowing-boat used by the Turks, having from one to twelve rowers; also a Levantine sailing vessel of considerable size.

ÇA IRA, a song of the French Revolution, with the refrain:—

"*Ah! ça ira, ça ira, ça ira!
Les aristocrates à la lanterne.*"

The words, written by one Ladré, a street singer, were put to an older tune, called "Le Carillon National," and the song rivalled the "Carmagnole" (*q.v.*) during the Terror. It was forbidden by the Directory.

CAIRD, EDWARD (1835-1908), British philosopher and theologian, brother of John Caird (*q.v.*), was born at Greenock on the 22nd of March 1835, and educated at Glasgow University and Balliol College, Oxford. He took a first class in moderations in 1862 and in *Literae humaniores* in 1863, and was Pusey and Ellerton scholar in 1861. From 1864 to 1866 he was fellow and tutor of Merton College. In 1866 he became professor of moral philosophy in the university of Glasgow, and in 1893 succeeded Benjamin Jowett as master of Balliol. With Thomas Hill Green he founded in England a school of orthodox neo-Hegelianism (see *HEGEL, ad fin.*), and through his pupils he exerted a far-reaching influence on English philosophy and theology. Owing to failing health he gave up his lectures in 1904, and in May 1906 resigned his mastership, in which he was succeeded by James Leigh Strachan-Davidson, who had previously for some time, as senior tutor and fellow, borne the chief burden of college administration. Dr Caird received the honorary degree of D.C.L. in 1892; he was made a corresponding member of the French Academy of Moral and Political Science and a fellow of the British Academy. His publications include *Philosophy of Kant* (1878); *Critical Philosophy of Kant* (1880); *Religion and Social Philosophy of Comte* (1885); *Essays on Literature and Philosophy* (1892); *Evolution of Religion* (Gifford Lectures, 1891-1892); *Evolution of Theology in the Greek Philosophers* (1904); and he is represented in this encyclopaedia by the article on **CARTESIANISM**. He died on the 1st of November 1908.

For a criticism of Dr Caird's theology, see A. W. Benn, *English Rationalism in the 19th Century* (London, 1906).

CAIRD, JOHN (1820-1898), Scottish divine and philosopher, was born at Greenock on the 15th of December 1820. In his sixteenth year he entered the office of his father, who was partner and manager of a firm of engineers. Two years later, however, he obtained leave to continue his studies at Glasgow University. After a year of academic life he tried business again, but in 1840 he gave it up finally and returned to college. In 1845 he entered the ministry of the Church of Scotland, and after holding several livings accepted the chair of divinity at Glasgow in 1862. During these years he won a foremost place among the preachers of Scotland. In theology he was a Broad Churchman, seeking always to emphasize the permanent elements in religion, and ignoring technicalities. In 1873 he was appointed vice-chancellor and principal of Glasgow University. He delivered the Gifford Lectures in 1892-1893 and in 1895-1896. His *Introduction to the Philosophy of Religion* (1880) is an attempt to show the essential rationality of religion. It is idealistic in character, being in fact a reproduction of Hegelian teaching in clear and melodious language. His argument for the Being of God is based on the hypothesis that thought—not individual but universal—is the reality of all things, the existence of this Infinite Thought being demonstrated by the limitations of finite thought. Again his Gifford Lectures are devoted to the proof of the truth of Christianity on grounds of right reason alone. Caird wrote also an excellent study of Spinoza, in which he showed the latent Hegelianism of the great Jewish philosopher. He died on the 30th of July 1898.

CAIRN (in Gaelic and Welsh, *Carn*), a heap of stones piled up in a conical form. In modern times cairns are often erected as landmarks. In ancient times they were erected as sepulchral monuments. The *Duan Eivrasnach*, an ancient Irish poem, describes the erection of a family cairn; and the *Senchus Mor*, a collection of ancient Irish laws, prescribes a fine of three three-year-old heifers for "not erecting the tomb of thy chief." Meetings of the tribes were held at them, and the inauguration of a

new chief took place on the cairn of one of his predecessors. It is mentioned in the *Annals of the Four Masters* that, in 1215, the O'Connor was inaugurated on the cairn of Fraech, the son of Fiodhach of the red hair. In medieval times cairns are often referred to as boundary marks, though probably not originally raised for that purpose. In a charter by King Alexander II. (1221), granting the lands of Burgyn to the monks of Kinloss, the boundary is described as passing "from the great oak in Malevin as far as the *Rune Pictorum*," which is explained as "the Carne of the Pecht's fieldia." In Highland districts small cairns used to be erected, even in recent times, at places where the coffin of a distinguished person was "rested" on its way to the churchyard. Memorial cairns are still occasionally erected, as, for instance, the cairn raised in memory of the prince consort at Balmoral, and "Maule's Cairn," in Glensak, erected by the earl of Dalhousie in 1866, in memory of himself and certain friends specified by name in the inscription placed upon it. (See **BARROW**.)

CAIRNES, JOHN ELLIOTT (1825-1875), British political economist, was born at Castle Bellingham, Ireland, in 1825. After leaving school he spent some years in the counting-house of his father, a brewer. His tastes, however, lay altogether in the direction of study, and he was permitted to enter Trinity College, Dublin, where he took the degree of B.A. in 1848, and six years later that of M.A. After passing through the curriculum of arts he engaged in the study of law and was called to the Irish bar. But he felt no very strong inclination for the legal profession, and during some years he occupied himself to a large extent with contributions to the daily press, treating of the social and economical questions that affected Ireland. He devoted most attention to political economy, which he studied with great thoroughness and care. While residing in Dublin he made the acquaintance of Archbishop Whately, who conceived a very high respect for his character and abilities. In 1856 a vacancy occurred in the chair of political economy at Dublin founded by Whately, and Cairnes received the appointment. In accordance with the regulations of the foundation, the lectures of his first year's course were published. The book appeared in 1857 with the title *Character and Logical Method of Political Economy*. It follows up and expands J. S. Mill's treatment in the *Essays on some Unsettled Questions in Political Economy*, and forms an admirable introduction to the study of economics as a science. In it the author's peculiar powers of thought and expression are displayed to the best advantage. Logical exactness, precision of language, and firm grasp of the true nature of economic facts, are the qualities characteristic of this as of all his other works. If the book had done nothing more, it would still have conferred inestimable benefit on political economists by its clear exposition of the true nature and meaning of the ambiguous term "law." To the view of the province and method of political economy expounded in this early work the author always remained true, and several of his later essays, such as those on *Political Economy and Land*, *Political Economy and Laissez-Faire*, are but reiterations of the same doctrine. His next contribution to economical science was a series of articles on the gold question, published partly in *Fraser's Magazine*, in which the probable consequences of the increased supply of gold attendant on the Australian and Californian gold discoveries were analysed with great skill and ability. And a critical article on M. Chevalier's work *On the Probable Fall in the Value of Gold* appeared in the *Edinburgh Review* for July 1860.

In 1861 Cairnes was appointed to the professorship of political economy and jurisprudence in Queen's College, Galway, and in the following year he published his admirable work *The Slave Power*, one of the finest specimens of applied economical philosophy. The inherent disadvantages of the employment of slave labour were exposed with great fitness and ability, and the conclusions arrived at have taken their place among the recognized doctrines of political economy. The opinions expressed by Cairnes as to the probable issue of the war in America were largely verified by the actual course of events, and the appearance of the book had a marked influence on the attitude taken by serious political thinkers in England towards the southern states.

During the remainder of his residence at Galway Professor Cairnes published nothing beyond some fragments and pamphlets mainly upon Irish questions. The most valuable of these papers are the series devoted to the consideration of university education. His health, at no time very good, was still further weakened in 1865 by a fall from his horse. He was ever afterwards incapacitated from active exertion and was constantly liable to have his work interfered with by attacks of illness. In 1866 he was appointed professor of political economy in University College, London. He was compelled to spend the session 1868-1869 in Italy but on his return continued to lecture till 1872. During his last session he conducted a mixed class, ladies being admitted to his lectures. His health soon rendered it impossible for him to discharge his public duties; he resigned his post in 1872, and retired with the honorary title of emeritus professor of political economy. In 1873 his own university conferred on him the degree of LL.D. He died at Blackheath, near London, on the 8th of July 1875.

The last years of his life were spent in the collection and publication of some scattered papers contributed to various reviews and magazines, and in the preparation of his most extensive and important work. The *Political Essays*, published in 1873, comprise all his papers relating to Ireland and its university system, together with some other articles of a somewhat similar nature. The *Essays in Political Economy, Theoretical and Applied*, which appeared in the same year, contain the essays towards a solution of the gold question, brought up to date and tested by comparison with statistics of prices. Among the other articles in the volume the more important are the criticisms on Bastiat and Comte, and the essays on *Political Economy and Land*, and on *Political Economy and Laissez-Faire*, which have been referred to above. In 1874 appeared his largest work, *Some Leading Principles of Political Economy, newly Expounded*, which is beyond doubt a worthy successor to the great treatises of Smith, Malthus, Ricardo and Mill. It does not expound a completed system of political economy; many important doctrines are left untouched; and in general the treatment of problems is not such as would be suited for a systematic manual. The work is essentially a commentary on some of the principal doctrines of the English school of economists, such as value, cost of production, wages, labour and capital, and international values, and is replete with keen criticism and lucid illustration. While in fundamental harmony with Mill, especially as regards the general conception of the science, Cairnes differs from him to a greater or less extent on nearly all the cardinal doctrines, subjects his opinions to a searching examination, and generally succeeds in giving to the truth that is common to both a firmer basis and a more precise statement. The last labour to which he devoted himself was a republication of his first work on the *Logical Method of Political Economy*.

Taken as a whole the works of Cairnes formed the most important contribution to economical science made by the English school since the publication of J. S. Mill's *Principles*. It is not possible to indicate more than generally the special advances in economic doctrine effected by him, but the following points may be noted as establishing for him a claim to a place beside Ricardo and Mill: (1) His exposition of the province and method of political economy. He never suffers it to be forgotten that political economy is a *science*, and consequently that its results are entirely neutral with respect to social facts or systems. It has simply to trace the necessary connexions among the phenomena of wealth and dictates no rules for practice. Further, he is distinctly opposed both to those who would treat political economy as an integral part of social philosophy, and to those who have attempted to express economic facts in quantitative formulæ and to make economy a branch of applied mathematics. According to him political economy is a mixed science, its field being partly mental, partly physical. It may be called a positive science, because its premises are facts, but it is hypothetical in so far as the laws it lays down are only approximately true, i.e. are only valid in the absence of counteracting agencies.

From this view of the nature of the science, it follows at once that the method to be pursued must be that called by Mill the physical or concrete deductive, which starts from certain known causes, investigates their consequences and verifies or tests the result by comparison with facts of experience. It may, perhaps, be thought that Cairnes gives too little attention to the effects of the organism of society on economic facts, and that he is disposed to overlook what Bagehot called the postulates of political economy. (2) His analysis of cost of production in its relation to value. According to Mill, the universal elements in cost of production are the wages of labour and the profits of capital. To this theory Cairnes objects that wages, being remuneration, can in no sense be considered as cost, and could only have come to be regarded as cost in consequence of the whole problem being treated from the point of view of the capitalist, to whom, no doubt, the wages paid represent cost. The real elements of cost of production he looks upon as labour, abstinence and risk, the second of these falling mainly, though not necessarily, upon the capitalist. In this analysis he to a considerable extent follows and improves upon Senior, who had previously defined cost of production as the sum of the labour and abstinence necessary to production. (3) His exposition of the natural or social limit to free competition, and of its bearing on the theory of value. He points out that in any organized society there can hardly be the ready transference of capital from one employment to another, which is the indispensable condition of free competition; while class distinctions render it impossible for labour to transfer itself readily to new occupations. Society may thus be regarded as consisting of a series of non-competing industrial groups, with free competition among the members of any one group or class. Now the only condition under which cost of production will regulate value is perfect competition. It follows that the normal value of commodities—the value which gives to the producers the average and usual remuneration—will depend upon cost of production only when the exchange is confined to the members of one class, among whom there is free competition. In exchange between classes or non-competing industrial groups, the normal value is simply a case of international value, and depends upon reciprocal demand, that is to say, is such as will satisfy the equation of demand. This theory is a substantial contribution to economical science and throws great light upon the general problem of value. At the same time, it may be thought that Cairnes overlooked a point brought forward prominently by Senior, who also had called attention to the bearing of competition on the relation between cost of production and value. The cost to the producer fixes the limit below which the price cannot fall without the supply being affected; but it is the desire of the consumer—i.e. what he is willing to give up rather than be compelled to produce the commodity for himself—that fixes the maximum value of the article. To treat the whole problem of natural or normal value from the point of view of the producer is to give but a one-sided theory of the facts. (4) His defence of the wages fund doctrine. This doctrine, expounded by Mill in his *Principles*, had been relinquished by him, but Cairnes still undertook to defend it. He certainly succeeded in removing from the theory much that had tended to obscure its real meaning and in placing it in its very best aspect. He also showed the sense in which, when treating the problem of wages, we must refer to some fund devoted to the payment of wages, and pointed out the conditions under which the wages fund may increase or decrease. It may be added that his *Leading Principles* contain admirable discussions on trade unions and protection, together with a clear analysis of the difficult theory of international trade and value, in which there is much that is both novel and valuable. The *Logical Method* contains about the best exposition and defence of Ricardo's theory of rent; and the *Essays* contain a very clear and formidable criticism of Bastiat's economic doctrines.

Professor Cairnes's son, CAPTAIN W. E. CAIRNES (1862-1906), was an able writer on military subjects, being author of *An Absent-minded War* (1900), *The Coming Waterloo* (1905), &c.

CAIRNGORM, a yellow or brown variety of quartz, named from Cairngorm or Cairngorum, one of the peaks of the Grampian Mountains in Banffshire, Scotland. According to Mr E. H. Cunningham-Craig, the mineral occurs in crystals lining cavities in highly-inclined veins of a fine-grained granite running through the coarser granite of the main mass. Shallow pits were formerly dug in the kaolinized granite for sake of the cairngorm and the mineral was also found as pebbles in the bed of the river Avon. Cairngorm is a favourite ornamental stone in Scotland, being set in the lids of snuff-mills, in the handles of dirks and in brooches for Highland costume. A rich sherry-yellow colour is much esteemed. Quartz of yellow and brown colour is often known in trade as "false topaz," or simply "topaz." Such quartz is found at many localities in Brazil, Russia and Spain. Much of the yellow quartz used in jewellery is said to be "burnt amethyst"; that is, it was originally amethystine quartz, the colour of which has been modified by heat (see *AKETHYST*). Yellow quartz is sometimes known as citrine; when the quartz presents a pale brown tint it is called "smoky quartz"; and when the brown is so deep that the stone appears almost black it is termed morion. The brown colour has been referred to the presence of titanium.

CAIRNS, HUGH MC CALMONT CAIRNS, 1ST EARL (1819-1885), Irish statesman, and lord chancellor of England, was born at Cultra, Co. Down, Ireland, on the 27th of December 1819. His father, William Cairns, formerly a captain in the 47th regiment, came of a family¹ of Scottish origin, which migrated to Ireland in the time of James I. Hugh Cairns was his second son, and was educated at Belfast academy and at Trinity College, Dublin, graduating with a senior moderatorship in classics in 1838. In 1844 he was called to the bar at the Middle Temple, to which he had migrated from Lincoln's Inn. During his first years at the chancery bar, Cairns showed little promise of the eloquence which afterwards distinguished him. Never a rapid speaker, he was then so slow and diffident, that he feared that this defect might interfere with his legal career. Fortunately he was soon able to rid himself of the idea that he was only fit for practice as a conveyancer. In 1852 he entered parliament as member for Belfast, and his Inn, on his becoming a Q.C. in 1856, made him a bencher.

In 1858 Cairns was appointed solicitor-general, and was knighted, and in May of that year made two of his most brilliant and best-remembered speeches in the House of Commons. In the first, he defended the action of Lord Ellenborough, who, as president of the board of control, had not only censured Lord Canning for a proclamation issued by him as governor-general of India but had made public the despatch in which the censure was conveyed. On the other occasion referred to, Sir Hugh Cairns spoke in opposition to Lord John Russell's amendment to the motion for the second reading of the government Reform Bill, winning the most cordial commendation of Disraeli. Disraeli's appreciation found an opportunity for displaying itself some years later, when in 1868 he invited him to be lord chancellor in the brief Conservative administration which followed Lord Derby's resignation of the leadership of his party. Meanwhile, Cairns had maintained his reputation in many other debates, both when his party was in power and when it was in opposition. In 1866 Lord Derby, returning to office, had made him attorney-general, and in the same year he had availed himself of a vacancy to seek the comparative rest of the court of appeal. While a lord justice he had been offered a peerage, and though at first unable to accept it, he had finally done so on a relative, a member of the wealthy family of McCalmont, providing the means necessary for the endowment of a title.

The appointment of Baron Cairns of Garmoyle as lord chancellor in 1868 involved the superseding of Lord Chelmsford, an act which apparently was carried out by Disraeli with less tact than might have been expected of him. Lord Chelmsford bitterly declared that he had been sent away with less courtesy than if he had been a butler, but the testimony of Lord Malmesbury is strong that the affair was the result of an understanding arrived

¹ See *History of the family of Cairnes or Cairns*, by H. C. Lawlor (1907).

at when Lord Chelmsford took office. Disraeli held office on this occasion for a few months only, and when Lord Derby died in 1869, Lord Cairns became the leader of the Conservative opposition in the House of Lords. He had distinguished himself in the Commons by his resistance to the 'Roman Catholics' Oath Bill brought in in 1865; in the Lords, his efforts on behalf of the Irish Church were equally strenuous. His speech on Gladstone's Suspensory Bill was afterwards published as a pamphlet, but the attitude which he and the peers who followed him had taken up, in insisting on their amendments to the preamble of the bill, was one difficult to maintain, and Lord Cairns made terms with Lord Granville in circumstances which precluded his consulting his party first. He issued a circular to explain his action in taking a course for which many blamed him. Viewed dispassionately, the incident appears to have exhibited his statesmanlike qualities in a marked degree, for he secured concessions which would have been irretrievably lost by continued opposition. Not long after this, Lord Cairns resigned the leadership of his party in the upper house, but he had to resume it in 1870 and took a strong part in opposing the Irish Land Bill in that year. On the Conservatives coming into power in 1874, he again became lord chancellor; in 1878 he was made Viscount Garmoyle and Earl Cairns; and in 1880 his party went out of office. In opposition he did not take as prominent a part as previously, but when Lord Beaconsfield died in 1881, there were some Conservatives who considered that his title to lead the party was better than that of Lord Salisbury. His health, however, never robust, had for many years shown intermittent signs of failing. He had periodically made enforced retirements to the Riviera, and for many years had had a house at Bourne-mouth, and it was here that he died on the 2nd of April 1885.

Cairns was a great lawyer, with an immense grasp of first principles and the power to express them; his judgments taking the form of luminous expositions or treatises upon the law governing the case before him, rather than of controversial discussions of the arguments adduced by counsel or of analysis of his own reasons. Lucidity and logic were the leading characteristics of his speeches in his professional capacity and in the political arena. In an eloquent tribute to his memory in the House of Lords, Lord Chief Justice Coleridge expressed the high opinion of the legal profession upon his merits and upon the severe integrity and single-minded desire to do his duty, which animated him in his selections for the bench. His piety was reflected by that of his great opponent, rival and friend, Lord Selborne. Like Lord Selborne and Lord Hatherley, Cairns found leisure at his busiest for teaching in the Sunday-school, but it is not recorded of them (as of him) that they refused to undertake work at the bar on Saturdays, in order to devote that day to hunting. He used to say that his great incentive to hard work at his profession in early days was his desire to keep hunters, and he retained his keenness as a sportsman as long as he was able to indulge it. Of his personal characteristics, it may be said that he was a spare man, with a Scottish, not an Irish, cast of countenance. He was scrupulously neat in his personal appearance, faultless in bands and necktie, and fond of wearing a flower in his button-hole. His chilly manner, coupled with his somewhat austere religious principles, had no doubt much to do with the fact that he was never a popular man. His friends claimed for him a keen sense of humour, but it was not to be detected by those whose knowledge of him was professional rather than personal. Probably he thought the exhibition of humour incompatible with the dignity of high judicial position. Of his legal attainments there can be no doubt. His influence upon the legislation of the day was largely felt where questions affecting religion and the Church were involved and in matters peculiarly affecting his own profession. His power was felt, as has been said, both when he was in office and when his party was in opposition. He had been chairman of the committee on judicature reform, and although he was not in office when the Judicature Act was passed, all the reforms in the legal procedure of his day owed much to him. He took part, when out of office, in the passing of the Married Women's Property Act, and was directly responsible for the Conveyancing Acts of 1881-1882, and

for the Settled Land Act. Many other statutes in which he was largely concerned might be quoted. His judgments are to be found in the Law Reports and those who wish to consider his oratory should read the speeches above referred to, or that delivered in the House of Lords on the Compensation for Disturbance Bill in 1880, and his memorable criticism of Mr Gladstone's policy in the Transvaal, after Majuba Hill. (See Hansard and *The Times*, 1st of April 1881.) His style of delivery was, as a rule, cold to a marked degree. The term "frozen oratory" has been applied to his speeches, and it has been said of them that they flowed "like water from a glacier. . . . The several stages of his speech are like steps cut in ice, as sharply defined, as smooth and as cold." Lord Cairns married in 1856 Mary Harriet, eldest daughter of John McNeill, of Parkmount, Co. Antrim, by whom he had issue five sons and two daughters. He was succeeded in the earldom by his second but eldest surviving son, Arthur William (1861-1890), who left one daughter, and from whom the title passed to his two next younger brothers in succession, Herbert John, third earl (1863-1905), and Wilfrid Dallas, fourth earl (b. 1864).

AUTHORITIES.—See *The Times*, 3rd and 14th of April 1885; *Law Journal*, *Law Times*, *Solicitors' Journal*, 11th of April 1885; the *Law Magazine*, vol. xi. p. 133; the *Law Quarterly*, vol. i. p. 365; *Earl Russell's Recollections; Memoirs of Lord Malmesbury*; Sir Theodore Martin, *The Life of the Prince Consort*; E. Manson, *Builders of our Law*; J. B. Atlay, *Victorian Chancellors*, vol. ii.

CAIRNS, JOHN (1818-1892), Scottish Presbyterian divine, was born at Ayton Hill, Berwickshire, on the 23rd of August 1818, the son of a shepherd. He went to school at Ayton and Oldcambus, Berwickshire, and was then for three years a herd boy, but kept up his education. In 1834 he entered Edinburgh University, but during 1836 and 1837, owing to financial straits, taught in a school at Ayton. In November 1837 he returned to Edinburgh, where he became the most distinguished student of his time, graduating M.A. in 1841, first in classics and philosophy and bracketed first in mathematics. While at Edinburgh he organized the Metaphysical Society along with A. Campbell Fraser and David Masson. He entered the Presbyterian Secession Hall in 1840, and in 1843 wrote an article in the *Secession Magazine* on the Free Church movement, which aroused the interest of Thomas Chalmers. The years 1843-1844 he spent at Berlin studying German philosophy and theology. He was licensed as preacher on the 3rd of February 1845, and on the 6th of August ordained as minister of Golden Square Church, Berwick-on-Tweed. There his preaching was distinguished by its impressiveness and by a broad and unaffected humanity. He had many "calls" to other churches, but chose to remain at Berwick. In 1857 he was one of the representatives at the meeting of the Evangelical Alliance in Berlin, and in 1858 Edinburgh University conferred on him an honorary D.D. In the following year he declined an invitation to become principal of Edinburgh University. In 1872 he was elected moderator of the United Presbyterian Synod and represented his church in Paris at the first meeting of the Reformed Synod of France. In May 1876, he was appointed joint professor of systematic theology and apologetics with James Harper, principal of the United Presbyterian Theological College, whom he succeeded as principal in 1879. He was an indefatigable worker and speaker, and in order to facilitate his efforts in other countries and other literatures he learnt Arabic, Norse, Danish and Dutch. In 1890 he visited Berlin and Amsterdam to acquaint himself with the ways of younger theologians, especially with the Ritschlians, whose work he appreciated but did not accept as final. On his return he wrote a long article on "Recent Scottish Theology" for the *Presbyterian and Reformed Review*, for which he read over every theological work of note published in Scotland during the preceding half-century. He died on the 12th of March, 1892, at Edinburgh. Among his principal publications are *An Examination of Ferrier's "Knowing and Being," and the Scottish Philosophy*—(a work which gave him the reputation of being an independent Hamiltonian in philosophy); *Memoir of John Brown, D.D.* (1860); *Romanism and Rationalism* (1863); *Outlines of Apologetical Theology* (1867); *The Doctrine of the*

Presbyterian Church (1876); *Unbelief in the 18th Century* (1881); *Doctrinal Principles of the United Presbyterian Church* (Dr Blair's Manual, 1888).

See MacEwen's *Life and Letters of John Cairns* (1895). (D. MN.)

CAIRNS, a seaport of Nares county, Queensland, Australia, 890 m. direct N.N.W. of Brisbane. Pop. (1901) 3557. The town lies parallel with the sea, on the western shore of Trinity Bay, with an excellent harbour, and a long beach, finely timbered. Cairns is the natural outlet for the gold-fields, tin-mines and silver-fields of the district and for the rich copper district of Chillagoe. A government railway, 48 m. long, runs to Mareeba, whence a private company's line continues to Mungana, 100 m. W. There is also a line belonging to a private company connecting Chillagoe with Mareeba. In the vicinity of Cairns are extensive sugar plantations, with sugar mills and refineries; the culture of coffee and tobacco has rapidly extended; bananas, pine-apples and other fruits are exported in considerable quantities and there is a large industry in cedar. The Barron Falls, among the finest in Australia, are near Kuranda, 19 m. from Cairns. Cairns became a municipality in 1885.

CAIRO (Arabic *Misr-al-Kahira*, or simply *Misr*), the capital of modern Egypt and the most populous city in Africa, on the Nile, 12 m. S. of the apex of the Delta, in 30° 3' N. and 31° 21' E. It is 130 m. S.E. of Alexandria, and 148 E. of Suez by rail, though only 84 m. from the last-named port by the overland route across the desert, in use before the opening of the Suez Canal. Cairo occupies a length of 5 m. on the east bank of the Nile, stretching north from the old Roman fortress of Babylon, and covers an area of about 8 sq. m. It is built partly on the alluvial plain of the Nile valley and partly on the rocky slopes of the Mokattam hills, which rise 550 ft. above the town.

The citadel, which is built on a spur of the Mokattam hills, occupies the S.E. angle of the city. The prospect from the ramparts of this fortress is one of striking picturesqueness and beauty. Below lies the city with its ancient walls and lofty towers, its gardens and squares, its palaces and its mosques, with their delicately-carved domes and minarets covered with fantastic tracery, the port of Bulak, the gardens and palace of Shubra, the broad river studded with islands, the valley of the Nile dotted with groups of trees, with the pyramids on the north horizon, and on the east the barren cliffs, backed by a waste of sand. Since the middle of the 19th century the city has more than doubled in size and population. The newer quarters, situated near the river, are laid out in the fashion of French cities, but the eastern parts of the town remain, almost unimpaired, their Oriental aspect, and in scores of narrow, tortuous streets, and busy bazaars it is easy to forget that there has been any change from the Cairo of medieval times. Here the line of fortifications still marks the eastern limits of the city, though on the north large districts have grown up beyond the walls. Neither on the south nor towards the river are there any fortifications left.

Principal Quarters and Modern Buildings.—From the citadel a straight road, the Sharia Mehemet Ali, runs N. to the Ezbekia (Ezbekiyeh) Gardens, which cover over 20 acres, and form the central point of the foreign colony. North and west of the Ezbekia runs the Ismailia canal, and on the W. side of the canal, about half a mile N. of the Gardens, is the Central railway station, approached by a broad road, the Sharia Clot Bey. The Arab city and the quarters of the Copts and Jews lie E. of the two streets named. West of the Ismailia canal lies the Bulak quarter, the port or riverside district. At Bulak are the arsenal, foundry and railway works, a paper manufactory and the government printing press, founded by Mehemet Ali. A little distance S.E. of the Ezbekia is the Place Atabeh, the chief point of intersection of the electric tramways which serve the newer parts of the town. From the Place Atabeh a narrow street, the Muski, leads E. into the heart of the Arab city. Another street leads S.W. to the Nile, at the point where the Kasr en Nil or Great Nile bridge spans the river, leading to Gezira Bulak, an island whereon is a palace, now turned into a hotel, polo, cricket and tennis grounds, and a racecourse. The districts between the bridge, the Ezbekia

and the Ismailia canal, are known as the Ismailia and Twefkia quarters, after the khedives in whose reigns they were laid out. The district immediately south of the bridge is called the Kasr el-Dubara quarter. Abdin Square, which occupies a central position, is connected with Ezbekia Gardens by a straight road. The narrow canal, El Khalig, which branched from the Nile at Old Cairo and traversed the city from S.W. to N.E., was filled up in 1897, and an electric tramway runs along the road thus made. With the filling up of the channel the ancient festival of the cutting of the canal came to an end.

The government offices and other modern public buildings are nearly all in the western half of the city. On the south side of the Ezbekia are the post office, the courts of the International Tribunals, and the opera house. On the east side are the bourse and the Crédit Lyonnais, on the north the buildings of the American mission. On or near the west side of the gardens are most of the large and luxurious hotels which the city contains for the accommodation of Europeans. Facing the river immediately north of the Great Nile bridge are the large barracks, called Kasr-en-Nil, and the new museum of Egyptian antiquities (opened in 1902). South of the bridge are the Ismailia palace (a khedivial residence), the British consulate general, the palace of the khedive's mother, the medical school and the government hospital. Farther removed from the river are the offices of the ministries of public works and of war—a large building surrounded by gardens—and of justice and finance. On the east side of Abdin Square is Abdin palace, an unpretentious building used for official receptions. Adjoining the palace are barracks. N.E. of Abdin Square, in the Sharia Mehemet Ali, is the Arab museum and khedivial library. Near this building are the new courts of the native tribunals. Private houses in these western districts consist chiefly of residential flats, though in the Kasr el-Dubara quarter are many detached residences.

The Oriental City.—The eastern half of Cairo is divided into many quarters. These quarters were formerly closed at night by massive gates. A few of these gates remain. In addition to the Mahomedan quarters, usually called after the trade of the inhabitants or some notable building, there are the Copt or Christian quarter, the Jews' quarter and the old "Frank" quarter. The last is the Muski district where, since the days of Saladin, "Frank" merchants have been permitted to live and trade. Some of the principal European shops are still to be found in this street. The Copt and Jewish quarters lie north of the Muski. The Coptic cathedral, dedicated to St Mark, is a modern building in the basilica style. The oldest Coptic church in Cairo is, probably, the Keniset-el-Adra, or Church of the Virgin, which is stated to preserve the original type of Coptic basilica. The Coptic churches in the city are not, however, of so much interest as those in Old Cairo (see below). In the Copt quarter are also Armenian, Syrian, Maronite, Greek and Roman Catholic churches. In the Copt and Jewish quarters the streets, as in the Arab quarters, are winding and narrow. In them the projecting upper stories of the houses nearly meet. Sebils or public fountains are numerous. These fountains are generally two-storeyed, the lower chamber enclosing a well, the upper room being often used for scholastic purposes. Many of the fountains are fine specimens of Arab architecture. While the houses of the poorer classes are mean and too often dirty, in marked contrast are the houses of the wealthier citizens, built generally in a style of elaborate arabesque, the windows shaded with projecting cornices of graceful woodwork (*mushrebiya*) and ornamented with stained glass. A winding passage leads through the ornamental doorway into the court, in the centre of which is a fountain shaded with palm-trees. The principal apartment is generally paved with marble; in the centre a decorated lantern is suspended over a fountain, while round the sides are richly inlaid cabinets and windows of stained glass; and in a recess is the *divan*, a low, narrow, cushioned seat. The basement storey is generally built of the soft calcareous stone of the neighbouring hills, and the upper storey, which contains the harem, of painted brick. The shops of the merchants are small and open to the street. The greater part of the trade is

done, however, in the bazaars or markets, which are held in large *khans* or storehouses, of two storeys and of considerable size. Access to them is gained from the narrow lanes which usually surround them. The khans often possess fine gateways. The principal bazaar, the Khan-el-Khalil, marks the site of the tombs of the Fatimite caliphs.

The Citadel and the Mosques.—Besides the citadel, the principal edifices in the Arab quarters are the mosques and the ancient gates. The citadel or El-Kala was built by Saladin about 1166, but it has since undergone frequent alteration, and now contains a palace erected by Mehemet Ali, and a mosque of Oriental alabaster (based on the model of the mosques at Constantinople) founded by the same pasha on the site of "Joseph's Hall," so named after the prenomens of Saladin. The dome and the two slender minarets of this mosque form one of the most picturesque features of Cairo, and are visible from a great distance. In the centre is a well called Joseph's Well, sunk in the solid rock to the level of the Nile. There are four other mosques within the citadel walls, the chief being that of Ibn Kalaun, built in A.D. 1317 by Sultan Nasir ibn Kalaun. The dome has fallen in. After having been used as a prison, and, later, as a military storehouse, it has been cleared and its fine colonnades are again visible. The upper parts of the minarets are covered with green tiles. They are furnished with bulbous cupolas. The most magnificent of the city mosques is that of Sultan Hasan, standing in the immediate vicinity of the citadel. It dates from A.D. 1357, and is celebrated for the grandeur of its porch and cornice and the delicate stalactite vaulting which adorns them. The restoration of parts of the mosque which had fallen into decay was begun in 1904. Besides it there is the mosque of Tulun (c. A.D. 879) exhibiting very ancient specimens of the pointed arch; the mosque of Sultan El Hakim (A.D. 1003), the mosque el Azhar (the splendid), which dates from about A.D. 970, and is the seat of a Mahomedan university; and the mosque of Sultan Kalaun, which is attached to the hospital or madhouse (*maristan*) begun by Kalaun in A.D. 1285. The whole forms a large group of buildings, now partially in ruins, in a style resembling the contemporaneous medieval work in Europe, with pointed arches in several orders. Besides the mosque proper there is a second mosque containing the fine mausoleum of Kalaun. Adjacent to the *maristan* on the north is the tomb mosque of al Nasir, completed 1303, with a fine portal. East of the Khan-el-Khalil is the mosque of El Hasanen, which is invested with peculiar sanctity as containing relics of Hosain and Hasan, grandsons of the Prophet. This mosque was rebuilt in the 19th century and is of no architectural importance. In all Cairo contains over 260 mosques, and nearly as many *zawias* or chapels. Of the gates the finest are the Bab-en-Nasr, in the north wall of the city, and the Bab-er-Zawela, the only surviving part of the southern fortifications.

Tombs of the Caliphs and Mamelukes.—Beyond the eastern wall of the city are the splendid mausolea erroneously known to Europeans as the tombs of the caliphs; they really are tombs of the Circassian or Burji Mamelukes, a race extinguished by Mehemet Ali. Their lofty gilt domes and fanciful network or arabesque tracery are partly in ruins, and the mosques attached to them are also partly ruined. The chief tomb mosques are those of Sultan Barkuk, with two domes and two minarets, completed A.D. 1410, and that of Kait Bey (c. 1470), with a slender minaret 135 ft. high. This mosque was carefully restored in 1898. South of the citadel is another group of tomb-mosques known as the tombs of the Mamelukes. They are architecturally of less interest than those of the "caliphs." Southwest of the Mameluke tombs is the much-venerated tomb-mosque of the Imam esh-Shafih or Shaf'i, founder of one of the four orthodox sects of Islam. Near the imam's mosque is a family burial-place built by Mehemet Ali.

Old Cairo: the Fortress of Babylon and the Nilometer.—About a mile south of the city is Masr-el-Atika, called by Europeans Old Cairo. Between Old Cairo and the newer city are large mounds of debris marking the site of Fostat (see below, *History*).

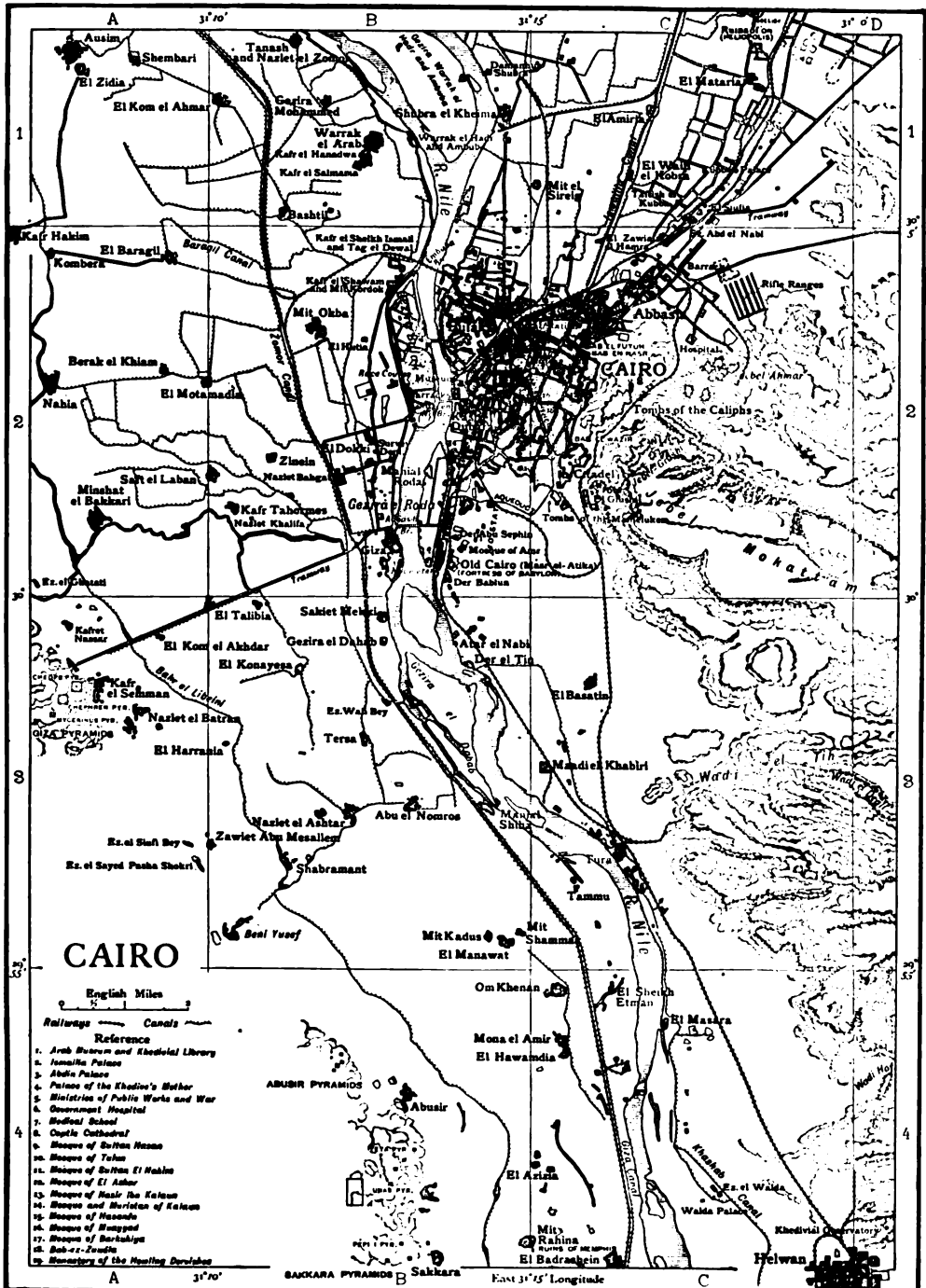

CAIRO

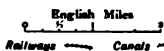

Railways Canals

Reference

1. Arab Museum and Khedivial Library
2. Janalla Palace
3. Abdia Palace
4. Palace of the Khedive's Mother
5. Ministries of Public Works and War
6. Government Hospital
7. Medical School
8. Coptic Cathedral
9. Mosque of Sultan Hassan
10. Mosque of Taha
11. Mosque of Sultan El Mahdi
12. Mosque of El Adina
13. Mosque of Nasir Du Khatun
14. Mosque and Burial of Khatun
15. Mosque of Hassan
16. Mosque of Mansour
17. Mosque of Barkakba
18. Bab el-Zawia
19. Ministry of the Housing Directorate

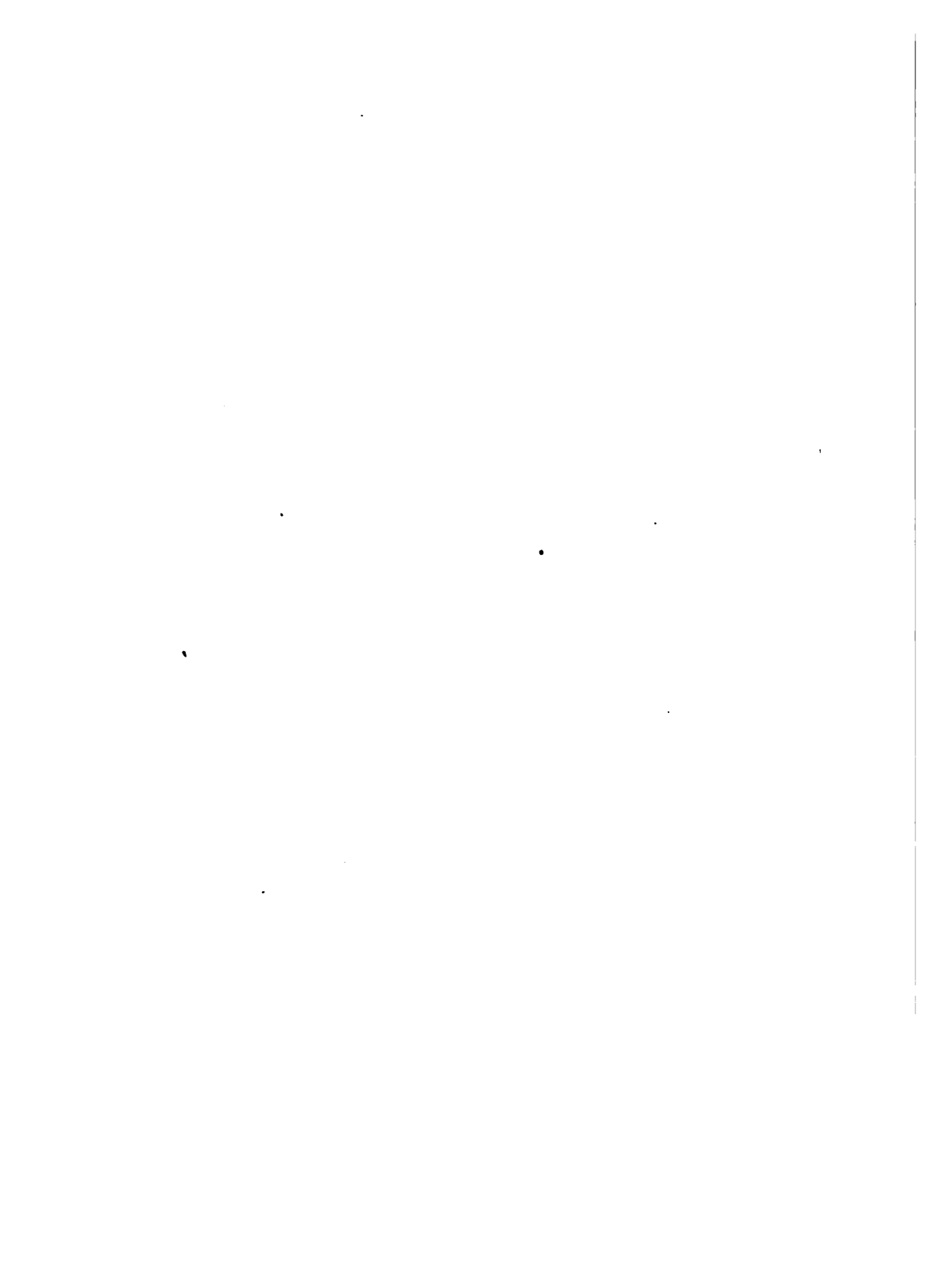

The road to Old Cairo by the river leads past the monastery of the "Howling" Dervishes, and the head of the aqueduct which formerly supplied the citadel with water. Farther to the east is the mosque of Amr, a much-altered building dating from A.D. 643 and containing the tomb of the Arab conqueror of Egypt. Most important of the quarters of Masr-el-Atika is that of Kasr-esh-Shama (Castle of the Candle), built within the outer walls of the Roman fortress of Babylon. Several towers of this fortress remain, and in the south wall is a massive gateway, uncovered in 1901. In the quarter are five Coptic churches, a Greek convent and two churches, and a synagogue. The principal Coptic church is that of Abu Serga (St Sergius). The crypt dates from about the 6th century and is dedicated to Sitt Miriam (the Lady Mary), from a tradition that in the flight into Egypt the Virgin and Child rested at this spot. The upper church is basilican in form, the nave being, as customary in Coptic churches, divided into three sections by wooden screens, which are adorned by carvings in ivory and wood. The wall above the high altar is faced with beautiful mosaics of marbles, blue glass and mother-of-pearl. Of the other churches in Kasr-esh-Shama the most noteworthy is that of El Adra (the Virgin), also called El Moallaka, or The Suspended, being built in one of the towers of the Roman gateway. It contains fine wooden and ivory screens. The pulpit is supported on fifteen columns, which rest on a slab of white marble. The patriarch of the Copts was formerly consecrated in this church. The other buildings in Old Cairo, or among the mounds of rubbish which adjoin it, include several fort-like *ders* or convents. One, south of the Kasr-esh-Shama, is called Der Bablun, thus preserving the name of the ancient fortress. In the Der Abu Sefhin, to the north of Babylon, is a Coptic church of the 10th century, possessing magnificent carved screens, a pulpit with fine mosaics and a semi-circle of marble steps.

Opposite Old Cairo lies the island of Roda, where, according to Arab tradition, Pharaoh's daughter found Moses in the bulrushes. Two bridges, opened in 1908, connect Old Cairo with Roda, and a third bridge joins Roda to Giza on the west bank of the river. Roda Island contains a mosque built by Kait Bey, and at its southern extremity is the Nilometer, by which the Cairenes have for over a thousand years measured the rise of the river. It is a square well with an octagonal pillar marked in cubits in the centre.

Northern and Western Suburbs.—Two miles N.E. of Cairo and on the edge of the desert is the suburb of Abbasia (named after the viceroys Abbas), connected with the city by a continuous line of houses. Abbasia is now largely a military colony, the cavalry barracks being the old palace of Abbas Pasha. In these barracks Arabi Pasha surrendered to the British on the 14th of September 1882, the day after the battle of Tel el-Kebir. Mataria, a village 3 m. farther to the N.E., is the site of the defeat of the Mamelukes by the Turks in 1517, and of the defeat of the Turks by the French under General Kléber in 1800. At Mataria was a sycamore-tree, the successor of a tree which decayed in 1665, venerated as being that beneath which the Holy Family rested on their flight into Egypt. This tree was blown down in July 1906 and its place taken by a cutting made from the tree some years previously. Less than a mile N.E. of Mataria are the scanty remains of the ancient city of On or Heliopolis. The chief monument is an obelisk, about 66 ft. high, erected by Uteserten I. of the XIIth dynasty. A residential suburb, named Heliopolis, containing many fine buildings, was laid out between Mataria and Abbasia during 1905-10.

On the west bank of the Nile, opposite the southern end of Roda Island, is the small town of Giza or Gizeh, a fortified place of considerable importance in the times of the Mamelukes. In the viceregal palace here the museum of Egyptian antiquities was housed for several years (1889-1902). The grounds of this palace have been converted into zoological gardens. A broad, tree-bordered, macadamized road, along which run electric trams, leads S.S.W. across the plain to the Pyramids of Giza, 5 m. distant, built on the edge of the desert.

Helwan.—Fourteen miles S. of Cairo and connected with it by railway is the town of Helwan, built in the desert 3 m. E. of the

Nile, and much frequented by invalids on account of its sulphur baths, which are owned by the Egyptian government. A khedivial astronomical observatory was built here in 1903-1904, to take the place of that at Abbasia, that site being no longer suitable in consequence of the northward extension of the city. The ruins of Memphis are on the E. bank of the Nile opposite Helwan.

Inhabitants.—The inhabitants are of many diverse races, the various nationalities being frequently distinguishable by differences in dress as well as in physiognomy and colour. In the oriental quarters of the city the curious shops, the markets of different trades (the shops of each trade being generally congregated in one street or district), the easy merchant sitting before his shop, the musical and quaint street-cries of the picturesque vendors of fruit, sherbet, water, &c., with the ever-changing and many-coloured throng of passengers, all render the streets a delightful study for the lover of Arab life, nowhere else to be seen in such perfection, or with so fine a background of magnificent buildings. The Cairenes, or native citizens, differ from the fellahin in having a much larger mixture of Arab blood, and are at once keener witted and more conservative than the peasantry. The Arabic spoken by the middle and higher classes is generally inferior in grammatical correctness and pronunciation to that of the Bedouins of Arabia, but is purer than that of Syria or the dialect spoken by the Western Arabs. Besides the Cairenes proper, who are largely engaged in trade or handicrafts, the inhabitants include Arabs, numbers of Nubians and Negroes—mostly labourers or domestics in nominal slavery—and many Levantines, there being considerable colonies of Syrians and Armenians. The higher classes of native society are largely of Turkish or semi-Turkish descent. Of other races the most numerous are Greeks, Italians, British, French and Jews. Bedouins from the desert frequent the bazaars.

At the beginning of the 19th century the population was estimated at about 200,000, made up of 120,000 Moslems, 60,000 Copts, 4000 Jews and 16,000 Greeks, Armenians and "Franks." In 1882 the population had risen to 374,000, in 1897 to 570,062, and in 1907, including Helwan and Mataria, the total population was 654,476, of whom 46,507 were Europeans.

Climate and Health.—In consequence of its insanitary condition, Cairo used to have a heavy death-rate. Since the British occupation in 1882 much has been done to better this state of things, notably by a good water-supply and a proper system of drainage. The death-rate of the native population is about 35 per 1000. The climate of the city is generally healthy, with a mean temperature of about 68° F. Though rain seldom falls, exhalations from the river, especially when the flood has begun to subside, render the districts near the Nile damp during September, October and November, and in winter early morning fogs are not uncommon. The prevalent north wind and the rise of the water tend to keep the air cool in summer.

Commerce.—The commerce of Cairo, of considerable extent and variety, consists mainly in the transit of goods. Gum, ivory, hides, and ostrich feathers from the Sudan, cotton and sugar from Upper Egypt, indigo and shawls from India and Persia, sheep and tobacco from Asiatic Turkey, and European manufactures, such as machinery, hardware, cutlery, glass, and cotton and woollen goods, are the more important articles. The traffic in slaves ceased in 1877. In Bulak are several factories founded by Mehemet Ali for spinning, weaving and printing cotton, and a paper-mill established by the khedive Ismail in 1870. Various kinds of paper are manufactured, and especially a fine quality for use in the government offices. In the Island of Roda there is a sugar-refinery of considerable extent, founded in 1859, and principally managed by Englishmen. Silk goods, saltpetre, gunpowder, leather, &c., are also manufactured. An octroi duty of 9% *ad valorem* formerly levied on all food stuffs entering the city was abolished in 1903. It used to produce about £1,500,000 per annum.

Mahomedan Architecture.—Architecturally considered Cairo is still the most remarkable and characteristic of Arab cities. The edifices raised by the Moorish kings of Spain and the Moslem

in the sea. There are two distinct forms of this type of caisson —

(1) A caisson open at the top, whose sides, when it is sunk in position, emerge above the water-level, and which is either provided with a water-tight bottom or is carried down, by being weighted at the top and having a cutting edge round the bottom, into a water-tight stratum, aided frequently by excavation inside; (2) A bottomless caisson, serving as a sort of diving-bell, in which men can work when compressed air is introduced to keep out the water in proportion to the depth below the water-level, which is gradually carried down to an adequately firm foundation by excavating at the bottom of the caisson, and building up a quay-wall or pier out of water on the top of its roof as it descends. An example of a caisson with a water-tight bottom is furnished by the quays erected alongside the Seine at Rouen, where open-timber caissons were sunk on to bearing-piles down to a depth of 9½ ft. below low-water, the brick and concrete lower portions of the quay-wall being built inside them out of water (see DOCK). At Bilbao, Zeebrugge and Scheveningen harbours, large open metal caissons, built inland, ballasted with concrete, floated out into position, and then sunk and filled with concrete, have been employed for forming very large foundation blocks for the breakwaters (see BREAKWATER). Open iron caissons are frequently employed for enclosing the site of river piers for bridges, where a water-tight stratum can be reached at a moderate depth, into which the caisson can be taken down, so that the water can be pumped out of the enclosure and the foundations laid and the pier carried up in the open air. Thus the two large river piers carrying the high towers, bascules, and machinery of the Tower Bridge, London, were each founded and built within a group of twelve plate-iron caissons open at the top; whilst four of the piers on which the cantilevers of the Forth Bridge rest, were each erected within an open plate-iron caisson fitted at the bottom to the sloping rock, where ordinary cofferdams could not have been adopted.

Where foundations have to be carried down to a considerable depth in water-bearing strata, or through the alluvial bed of a river, to reach a hard stratum, bottomless caissons sunk by excavating under compressed air are employed. The caisson at the bottom, forming the working chamber, is usually provided with a strong roof, round the top of which, when the caisson is floated into a river, plate-iron sides are erected forming an upper open caisson, inside which the pier or quay-wall is built up out of water, on the top of the roof, as the sinking proceeds. Shafts through the roof up to the open air provide access for men and materials to the working chamber, through an air-lock consisting of a small chamber with an air-tight door at each end, enabling locking into and out of the compressed-air portion to be readily effected, on the same principle as a water-lock on a canal. When a sufficiently reliable stratum has been reached, the men leave the working chamber; and it is filled with concrete through the shafts, the bottomless caisson remaining embedded in the work. The foundations for the two river piers of the Brooklyn Suspension Bridge, carried down to the solid rock, 78 and 45 ft. respectively below high-water, by means of bottomless timber caissons with compressed air, were an early instance of this method of carrying out subaqueous foundations; whilst the Antwerp quay-walls, commenced many years ago in the river Scheldt at some distance out from the right bank, and the foundations of six of the piers supporting the cantilevers of the Forth Bridge, carried down to rock between 64 and 89 ft. below high-water, are notable examples of works founded under water within wrought iron bottomless caissons by the aid of compressed air. The foundations of the two piers of the Eiffel Tower adjoining the Seine were carried down through soft water-bearing strata to a depth of 33 ft. by means of wrought iron bottomless caissons sunk by the help of compressed air; and the deep foundations under the sills of the new large Florida lock at Havre (see DOCK) were laid underneath the water logged alluvial strata close to the Seine estuary by similar means. Workmen, after emerging from such caissons, sometimes exhibit symptoms of illness which is known as *caisson disease* (q.v.).

As in the above system, significantly termed by French

engineers *par caisson fermé*, the materials of the bottomless caisson have to be left in the work, a more economical system has been adapted for carrying out similar foundations, at moderate depths, by using movable caissons, which, after the lower portions of the foundations have been laid, are raised by screw-jacks for constructing the next portions. In this way, instead of building the pier or wall on the roof of the caisson, the work is carried out under water in successive stages, by raising the bottomless caisson as the work proceeds; and by this arrangement, the caisson, having completed the subaqueous portion of the structure, is available for work elsewhere. This movable system has been used with advantage for the foundations for some piers of river bridges, some breakwater foundations, and, at the Florida lock, Havre, for founding portions of the side walls.

Closed iron caissons, termed ship-caissons, and sliding or rolling caissons, are generally employed for closing graving-docks, especially the former (so called from their resemblance in shape to a vessel) on account of their simplicity, being readily floated into and out of position; whilst sliding caissons are sometimes used instead of lock-gates at docks, but require a chamber at the side to receive them when drawn back. They possess the advantage, particularly for naval dockyards where heavy weights are transported, of providing in addition a strong movable bridge, thereby dispensing with a swing-bridge across the opening.

The term caisson is sometimes applied to flat air-tight constructions used for raising vessels out of water for cleaning or repairs, by being sunk under them and then floated; but these floating caissons are more commonly known as pontoons, or, when air-chambers are added at the sides, as floating dry-docks. (L. F. V.-H.)

CAISSON DISEASE. In order to exclude the water, the air pressure within a caisson used for subaqueous works must be kept in excess of the pressure due to the superincumbent water; that is, it must be increased by one atmosphere, or 15 lb per sq. in. for every 33½ ft. that the caisson is submerged below the surface. Hence at a depth of 100 ft. a worker in a caisson, or a diver in a diving-dress, must be subjected to a pressure of four atmospheres or 60 lb per sq. in. Exposure to such pressures is apt to be followed by disagreeable and even dangerous physiological effects, which are commonly referred to as caisson disease or compressed air illness. The symptoms are of a very varied character, including pains in the muscles and joints (the "bends"), deafness, embarrassed breathing, vomiting, paralysis ("divers' palsy"), fainting and sometimes even sudden death. At the St Louis bridge, where a pressure was employed equal to 4½ atmospheres, out of 600 workmen, 119 were affected and 14 died. At one time the symptoms were attributed to congestion produced by the mechanical effects of the pressure on the internal organs of the body, but this explanation is seen to be untenable when it is remembered that the pressure is immediately transmitted by the fluids of the body equally to all parts. They do not appear during the time that the pressure is being raised nor so long as it is continued, but only after it has been removed; and the view now generally accepted is that they are due to the rapid effervescence of the gases which are absorbed in the body-fluids during exposure to pressure. Experiment has proved that in animals exposed to compressed air nitrogen is dissolved in the fluids in accordance with Dalton's law, to the extent of roughly 1% for each atmosphere of pressure, and also that when the pressure is suddenly relieved the gas is liberated in bubbles within the body. It is these bubbles that do the mischief. Set free in the spinal cord, for instance, they may give rise to partial paralysis, in the labyrinth of the ear to auditory vertigo, or in the heart to stoppage of the circulation; on the other hand, they may be liberated in positions where they do no harm. But if the pressure is relieved gradually they are not formed, because the gas comes out of solution slowly and is got rid of by the heart and lungs. Paul Bert exposed 24 dogs to pressure of 7.07 atmospheres and "decompressed" them rapidly in 1-4 minutes. The result was that 21 died, while only one showed no symptoms. In one of his cases, in which the apparatus burst while at a pressure of 9½ atmospheres, death was instantaneous and the body was enormously distended, with the right heart full of gas.

was named El-Kähira, that is, "the Victorious," a name corrupted into Cairo. The new city, like that founded by Amr, was originally the camp of the conqueror. This town occupied about a fourth part, the north-eastern, of the present metropolis. By degrees it became greater than El-Fostät, and took from it the name of Misr, or Masr, which is applied to it by the modern Egyptians. With its rise Fostät, which had been little affected by the establishment of Askar and Katai, declined. It continually increased so as to include the site of El-Katai to the south. In A.D. 1176 Cairo was unsuccessfully attacked by the Crusaders; shortly afterwards Saladin built the citadel on the lowest point of the mountains to the east, which immediately overlooked El-Katai, and he partly walled round the towns and large gardens within the space now called Cairo. Under the prosperous rule of the Mameluke sultans this great tract was filled with habitations; a large suburb to the north, the Hosenya, was added; and the town of Bulak was founded. After the Turkish conquest (A.D. 1517) the metropolis decayed, but its limits were the same. In 1798 the city was captured by the French, who were driven out in 1801 by the Turkish and English forces, the city being handed over to the Turks. Mehemet Ali, originally the Turkish viceroy, by his massacre of the Mamelukes in 1811, in a narrow street leading to the citadel, made himself master of the country, and Cairo again became the capital of a virtually independent kingdom. Under Mehemet and his successors all the western part of the city has grown up. The khedive Ismail, in making the straight road from the citadel to the Ezbekia gardens, destroyed many of the finest houses of the old town. In 1882 Cairo was occupied by the British, and British troops continue to garrison the citadel.

BIBLIOGRAPHY.—S. L. Poole, *The Story of Cairo* (London, 1902), a historical and architectural survey of the Nile city; E. Reynolds-Ball, *Cairo: the City of the Caliphs* (Boston, U.S.A., 1897); Priest d'Avannes, *L'Art arabe d'après les monuments du Cairo* (Paris, 1847); P. Ravaisse, *L'Histoire et la topographie du Cairo d'après Makrisi* (Paris, 1887); E. W. Lane, *Cairo Fifty Years Ago* (London, 1896), presents a picture of the city as it was before the era of European "improvements," and gives extracts from the *Khitat* of Maqriazi, written in 1417, the chief original authority on the antiquities of Cairo; Murray's and Baedeker's *Guides*, and A. and C. Black's *Cairo of To-day* (1905), contain much useful and accurate information about Cairo. For the fortress of Babylon and its churches consult A. J. Butler, *Ancient Coptic Churches in Egypt* (Oxford, 1884).

CAIRO, a city and the county-seat of Alexander county, Illinois, U.S.A., in the S. part of the state, at the confluence of the Ohio and Mississippi rivers, 365 m. S. of Chicago. Pop. (1890) 10,324; (1900) 12,566, of whom 5000 were negroes; (1910 census) 14,548. Cairo is served by the Illinois Central, the Mobile & Ohio, the Cleveland, Cincinnati, Chicago & St. Louis, the St. Louis, Iron Mountain & Southern, and the St. Louis South-Western railways, and by river steamboat lines. The city, said to be the "Eden" of Charles Dickens's *Martin Chuzzlewit*, is built on a tongue of land between the rivers, and has suffered many times from inundations, notably in 1858. It is now protected by great levees. A fine railway bridge (1888) spans the Ohio. The city has a large government building, a U.S. marine hospital (1884), and the A. B. Safford memorial library (1882), and is the seat of St. Joseph's Loretto Academy (Roman Catholic, 1864). In one of the squares there is a bronze statue, "The Hower," by G. G. Barnard. In the N. part of the city is St. Mary's park (30 acres). At Mound City (pop. in 1910, 2837), 5 m. N. of Cairo, there is a national cemetery. Lumber and flour are Cairo's principal manufactured products, and the city is an important hardwood and cotton-wood market; the Singer Manufacturing Co. has veneer mills here, and there are large box factories. In 1905 the value of the city's factory products was \$4,381,465, an increase of 40-6% since 1900. Cairo is a shipping-point for the surrounding agricultural country. The city owes its origin to a series of commercial experiments. In 1818 a charter was secured from the legislature of the territory of Illinois incorporating the city and bank of Cairo. The charter was soon forfeited, and the land secured by it reverted to the government. In 1835 a new charter was granted to a second company, and in 1837 the Cairo City & Canal Co. was

formed. By 1842, however, the place was practically abandoned. A successful settlement was made in 1851-1854 under the auspices of the New York Trust Co.; the Illinois Central railway was opened in 1856; and Cairo was chartered as a city in 1857. During the Civil War Cairo was an important strategic point, and was a military centre and depot of supplies of considerable importance for the Federal armies in the west. In 1862 Admiral Andrew H. Foote established at Mound City a naval depot, which was the basis of his operations on the Mississippi.

CAIROLI, BENEDETTO (1825-1880), Italian statesman, was born at Pavia on the 28th of January 1825. From 1848 until the completion of Italian unity in 1870, his whole activity was devoted to the Risorgimento, as Garibaldi's officer, political refugee, anti-Austrian conspirator and deputy to parliament. He commanded a volunteer company under Garibaldi in 1850 and 1860, being wounded slightly at Calatafimi and severely at Palermo in the latter year. In 1866, with the rank of colonel, he assisted Garibaldi in Tirol, in 1867 fought at Mentana, and in 1870 conducted the negotiations with Bismarck, during which the German chancellor is alleged to have promised Italy possession of Rome and of her natural frontiers if the Democratic party could prevent an alliance between Victor Emmanuel and Napoleon. The prestige personally acquired by Benedetto Cairoli was augmented by that of his four brothers, who fell during the wars of Risorgimento, and by the heroic conduct of their mother. His refusal of all compensation or distinction further endeared him to the Italian people. When in 1876 the Left came into power, Cairoli, then a deputy of sixteen years' standing, became parliamentary leader of his party, and, after the fall of Depretis, Nicotera and Crispi, formed his first cabinet in March 1878 with a Francophil and Irredentist policy. After his marriage with the countess Elena Sizzo of Trent, he permitted the Irredentist agitation to carry the country to the verge of a war with Austria. General irritation was caused by his and Count Corti's policy of "clean hands" at the Berlin Congress, where Italy obtained nothing, while Austria-Hungary secured a European mandate to occupy Bosnia and the Herzegovina. A few months later the attempt of Passanante to assassinate King Humbert at Naples (12th of December 1878) caused his downfall, in spite of the courage displayed and the severe wound received by him in protecting the king's person on that occasion. On the 3rd of July 1879 Cairoli returned to power, and in the following November formed with Depretis a coalition ministry, in which he retained the premiership and the foreign office. Confidence in French assurances, and belief that Great Britain would never permit the extension of French influence in North Africa, prevented him from foreseeing the French occupation of Tunis (11th of May 1881). In view of popular indignation he resigned in order to avoid making inopportune declarations to the chamber. Thenceforward he practically disappeared from political life. In 1837 he received the knighthood of the Annunziata, the highest Italian decoration, and on the 8th of August 1880 died while a guest of King Humbert in the royal palace of Capodimonte near Naples. Cairoli was one of the most conspicuous representatives of that type of Italian public men who, having conspired and fought for a generation in the cause of national unity, were despite their valour little fitted for the responsible parliamentary and official positions they subsequently attained; and who by their ignorance of foreign affairs and of internal administration unwittingly impeded the political development of their country.

CAISSON (from the Fr. *caisse*, the variant form "cassoon" being adapted from the Ital. *casone*), a chest or case. When employed as a military term, it denotes an ammunition wagon or chest; in architecture it is the term used for a sunk panel or coffer in a ceiling, or in the soffit of an arch or a vault.

In civil engineering, however, the word has attained a far wider signification, and has been adopted in connexion with a considerable variety of hydraulic works. A caisson in this sense implies a case or enclosure of wood or iron, generally employed for keeping out water during the execution of foundations and other works in water-bearing strata, at the side of or under rivers, and also

with its characteristic fishes, the strata consisting of sandstones, flagstones with thin impure limestones. The rocks of Dunnet Head, which are provisionally classed with the upper Old Red Sandstone, are composed of red and yellow sandstones, marls and mudstones. Hitherto no fossils have been obtained from these beds save some obscure plant-like markings, but they are evidently a continuation southwards of the sandstones of Hoy, which there rest unconformably on the flagstone series of Orkney. This patch of Upper Old Red strata is faulted against the Caithness flagstones to the south. For many years the flagstones have been extensively quarried for pavement purposes, as for instance near Thurso, at Castletown and Achanarras. Two instances of volcanic necks occur in Caithness, one piercing the red sandstones at the Ness of Duncansby and the other the sandstones of Dunnet Head north of Brough. They point to volcanic activity subsequent to the deposition of the John o' Groat's beds and of the Dunnet sandstones. The materials filling these vents consist of agglomerate charged with blocks of diabase, sandstone, flagstone and limestone.

An interesting feature connected with the geology of Caithness is the deposit of shelly boulder clay which is distributed over the low ground, being deepest in the valleys and in the cliffs surrounding the bays on the east coast. Apart from the shell fragments, many of which are striated, the deposit contains blocks foreign to the county, as for instance chalk and chalk-flints, fragments of Jurassic rocks with fossils and pieces of jet. The transport of local boulders shows that the ice must have moved from the south-east towards the north-west, which coincides with the direction indicated by the striae. The Jurassic blocks may have been derived from the strip of rocks of that age on the east coast of Sutherland. The shell fragments, many of which are striated, include arctic, boreal and southern forms, only a small number being characteristic of the littoral zone.

Climate and Agriculture.—The climate is variable, and though the winter storms fall with great severity on the coast, yet owing to proximity to a vast expanse of sea the cold is not intense and snow seldom lies many days continuously. In winter and spring the northern shore is subject to frequent and disastrous gales from the N. and N.W. Only about two-fifths of the arable land is good. In spite of this and the cold, wet and windy climate, progressive landlords and tenants get a considerable part of the acreage of large farms successfully tilled. In 1824 James Traill of Ratter, near Dunnet, recognizing that it was impossible to expect tenants to reclaim and improve the land on a system of short leases, advocated large holdings on long terms, so that farmers might enjoy a substantial return on their capital and labour. Thanks to this policy and the farmers' skill and enterprise, the county has acquired a remarkable reputation for its produce; notably oats and barley, turnips, potatoes and beans. Sheep—chiefly Leicester and Cheviots—of which the wool is in especial request in consequence of its fine quality, cattle, horses and pigs are raised for southern markets.

Other Industries.—The great source of profit to the inhabitants is to be found in the fisheries of cod, ling, lobster and herring. The last is the most important, beginning about the end of July and lasting for six weeks, the centre of operations being at Wick. Besides those more immediately engaged in manning the boats, the fisheries give employment to a large number of coopers, curers, packers and helpers. The salmon fisheries on the coast and at the mouths of rivers are let at high prices. The Thurso is one of the best salmon streams in the north. The flagstone quarries, mostly situated in the Thurso, Olrig and Halkirk districts, are another important source of revenue. Of manufactures there is little beyond tweeds, ropes, agricultural implements, and whisky, and the principal imports consist of coal, wood, manure, flour and lime.

The only railway in the county is the Highland railway, which, from a point some four miles to the south-west of Aultnabreac station, crosses the shire in a rough semicircle, via Halkirk, to Wick, with a branch from Georgemas Junction to Thurso. There is also, however, frequent communication by steamer between

Wick and Thurso and the Orkneys and Shetlands, Aberdeen, Leith and other ports. The deficiency of railway accommodation is partly made good by coach services between different places.

Population and Government.—The population of Caithness in 1891 was 33,177, and in 1901, 33,870, of whom twenty-four persons spoke Gaelic only, and 2876 Gaelic and English. The chief towns are Wick (pop. in 1901, 7911) and Thurso (3723). The county returns one member to parliament. Wick is the only royal burgh and one of the northern group of parliamentary burghs which includes Cromarty, Dingwall, Dornoch, Kirkwall and Tain. Caithness unites with Orkney and Shetland to form a sheriffdom, and there is a resident sheriff-substitute at Wick, who sits also at Thurso and Lybster. The county is under school-board jurisdiction, and there are academies at Wick and Thurso. The county council subsidizes elementary schools and cookery classes and provides apparatus for technical classes.

History.—The early history of Caithness may, to some extent, be traced in the character of its remains and its local nomenclature. Picts' houses, still fairly numerous, Norwegian names and Danish mounds attest that these peoples displaced each other in turn, and the number and strength of the fortified keeps show that its annals include the usual feuds, assaults and reprisals. Circles of standing stones, as at Stemster Loch and Bower, and the ruins of Roman Catholic chapels and places of pilgrimage in almost every district, illustrate the changes which have come over its ecclesiastical condition. The most important remains are those of Bucholie Castle, Girnigo Castle, and the tower of Keiss; and, on the S.E. coast, the castles of Clyth, Swiney, Forse, Laveron, Knockinnon, Berriedale, Achastle and Dunbath, the last of which is romantically situated on a detached stack of sandstone rock. About six miles from Thurso stand the ruins of Braal Castle, the residence of the ancient bishops of Caithness. On the coast of the Pentland Firth, 1½ miles west of Duncansby Head, is the site of John o' Groat's house.

See S. Laing, *Prehistoric Remains of Caithness* (London and Edinburgh, 1866); James T. Calder, *History of Caithness* (2nd edition, Wick); John Horne, *In and About Wick* (Wick); Thomas Sinclair, *Caithness Events* (Wick, 1899); *History of the Clan Gunn* (Wick, 1890); J. Henderson, *Caithness Family History* (Edinburgh, 1884); Harvie-Brown, *Fauna of Caithness* (Edinburgh, 1887); Principal Miller, *Our Scandinavian Forefathers* (Thurso, 1872); Smiles, *Robert Dick, Botanist and Geologist* (London, 1878); H. Morrison, *Guide to Sutherland and Caithness* (Wick, 1883); A. Auld, *Ministers and Men in the Far North* (Edinburgh, 1891).

CAIUS or CAIUS, pope from 283 to 296, was the son of Caius, or of Concordius, a relative of the emperor Diocletian, and became pope on the 17th of December 283. His tomb, with the original epitaph, was discovered in the cemetery of Calixtus and in it the ring with which he used to seal his letters (see Arringhi, *Roma subterr.*, l. iv. c. xlvi. p. 426). He died in 296.

CAIUS [*Anglice* KEES, KEYS, etc.], JOHN (1510–1573), English physician, and second founder of the present Gonville and Caius College, Cambridge, was born at Norwich on the 6th of October 1510. He was admitted a student at what was then Gonville Hall, Cambridge, where he seems to have mainly studied divinity. After graduating in 1533, he visited Italy, where he studied under the celebrated Montanus and Vesalius at Padua; and in 1541 he took his degree in physic at Padua. In 1543 he visited several parts of Italy, Germany and France; and returned to England. He was a physician in London in 1547, and was admitted fellow of the College of Physicians, of which he was for many years president. In 1557, being then physician to Queen Mary, he enlarged the foundation of his old college, changed the name from "Gonville Hall" to "Gonville and Caius College," and endowed it with several considerable estates, adding an entire new court at the expense of £1834. Of this college he accepted the mastership (24th of January 1558/9) on the death of Dr Bacon, and held it till about a month before his death. He was physician to Edward VI., Queen Mary and Queen Elizabeth. He returned to Cambridge from London for a few days in June 1573, about a month before his death, and resigned the mastership to Dr Legge, a tutor at Jesus College. He died at his London House, in St Bartholomew's, on the 29th

of July, 1573, but his body was brought to Cambridge, and buried in the chapel under the well-known monument which he had designed. Dr Caius was a learned, active and benevolent man. In 1557 he erected a monument in St Paul's to the memory of Linacore. In 1564 he obtained a grant for Gonville and Caius College to take the bodies of two malefactors annually for dissection; he was thus an important pioneer in advancing the science of anatomy. He probably devised, and certainly presented, the silver caduceus now in the possession of Caius College as part of its *insignia*; he first gave it to the College of Physicians, and afterwards presented the London College with another.

His works are: *Annals of the College from 1555 to 1573*; translation of several of Galen's works, printed at different times abroad. *Hippocrates de Medicamentis*, first discovered and published by Dr Caius; also *De Ratione Vicius* (Lov. 1556, 8vo). *De Mendicis Methodo* (Basel, 1554; London, 1556, 8vo). *Account of the Sweating Sickness in England* (London, 1556, 1721) (it is entitled *De Ephemera Britannica*). *History of the University of Cambridge* (London, 1568, 8vo; 1574, 4to, in Latin). *De Theriacis Britannicis*; but it is doubtful whether this work was ever printed. *Of some Rare Plants and Animals* (London, 1570). *De Canibus Britannicis* (1570, 1720). *De Pronunciatione Graecae et Latinae Linguae* (London, 1574); *De Libris propriis* (London, 1570). He also wrote numerous other works which were never printed.

For further details see the *Biographical History of Caius College*, an admirable piece of historical work, by Dr John Venn (1897).

CAJAMARCA, or **CAXAMARCA**, a city of northern Peru, capital of a department and province of the same name, 90 m. E. by N. of Pacasmayo, its port on the Pacific coast. Pop. (1906, estimate) of the department, 333,310; of the city, 9000. The city is situated in an elevated valley between the Central and Western Cordilleras, 9400 ft. above sea level, and on the Eriznejas, a small tributary of the Marañon. The streets are wide and cross at right angles; the houses are generally low and built of clay. Among the notable public buildings are the old parish church built at the expense of Charles II. of Spain, the church of San Antonio, a Franciscan monastery, a nunnery, and the remains of the palace of Atahualpa, the Inca ruler whom Pizarro treacherously captured and executed in this place in 1533. The hot sulphur springs of Pultamarca, called the Baños del Inca (Inca's baths) are a short distance east of the city and are still frequented. Cajamarca is an important commercial and manufacturing town, being the distributing centre for a large inland region, and having long-established manufactures of woollen and linen goods, and of metal work, leather, etc. It is the seat of one of the seven superior courts of the republic, and is connected with the coast by telegraph and telephone. A railway has been undertaken from Pacasmayo, on the coast, to Cajamarca, and by 1908 was completed as far as Yonán, 60 m. from its starting-point.

The department of Cajamarca lies between the Western and Central Cordilleras and extends from the frontier of Ecuador S. to about 7° S. lat., having the departments of Piura and Lambayeque on the W. and Amazonas on the E. Its area according to official returns is 12,542 sq. m. The upper Marañon traverses the department from S. to N. The department is an elevated region, well watered with a large number of small streams whose waters eventually find their way through the Amazon into the Atlantic. Many of its productions are of the temperate zone, and considerable attention is given to cattle-raising. Coal is found in the province of Hualgayoc at the southern extremity of the department, which is also one of the rich silver-mining districts of Peru. Next to its capital the most important town of the department is Cajamarquilla, whose population was about 6000 in 1906.

CAJATAMBO, or **CAXATAMBO**, a town and province of the department of Ancachs, Peru, on the western slope of the Andes. Since 1896 the population of the town has been estimated at 6000, but probably it does not exceed 4500. The town is 110 m. N. by E. of Lima, in lat. 9° 53' S., long. 76° 57' W. The principal industries of the province are the raising of cattle and sheep, and the cultivation of cereals. Cochineal is a product of this region. Near the town there are silver mines, in which a part of its population is employed.

CAJETAN (GAETANUS), CARDINAL (1470-1534), was born at Gaeta in the kingdom of Naples. His proper name was Tommaso¹ de Vio, but he adopted that of Cajetan from his birthplace. He entered the order of the Dominicans at the age of sixteen, and ten years later became doctor of theology at Padua, where he was subsequently professor of metaphysics. A public disputation at Ferrara (1494) with Pico della Mirandola gave him a great reputation as a theologian, and in 1508 he became general of his order. For his zeal in defending the papal pretensions against the council of Pisa, in a series of works which were condemned by the Sorbonne and publicly burnt by order of King Louis XII, he obtained the bishopric of Gaeta, and in 1517 Pope Leo X. made him a cardinal and archbishop of Palermo. The year following he went as legate into Germany, to quiet the commotions raised by Luther. It was before him that the Reformer appeared at the diet of Augsburg; and it was he who, in 1519, helped in drawing up the bull of excommunication against Luther. Cajetan was employed in several other negotiations and transactions, being as able in business as in letters. In conjunction with Cardinal Giulio de' Medici in the conclave of 1521-1522, he secured the election of Adrian Dedel, bishop of Tortosa, as Adrian VI. Though as a theologian Cajetan was a scholastic of the older Thomist type, his general position was that of the moderate reformers of the school to which Reginald Pole, archbishop of Canterbury, also belonged; i.e. he desired to retain the best elements of the humanist revival in harmony with Catholic orthodoxy illumined by a revived appreciation of the Augustinian doctrine of justification. Nominated by Clement VII. a member of the committee of cardinals appointed to report on the "Nuremberg Reces," he recommended, in opposition to the majority, certain concessions to the Lutherans, notably the marriage of the clergy as in the Greek Church, and communion in both kinds according to the decision of the council of Basel. In this spirit he wrote commentaries upon portions of Aristotle, and upon the *Summa* of Aquinas, and towards the end of his life made a careful translation of the Old and New Testaments, excepting Solomon's Song, the Prophets and the Revelation of St John. In contrast to the majority of Italian cardinals of his day, Cajetan was a man of austere piety and fervent zeal; and if, from the standpoint of the Dominican idea of the supreme necessity of maintaining ecclesiastical discipline, he defended the extremist claims of the papacy, he also proclaimed that the pope should be "the mirror of God on earth." He died at Rome on the 9th of August 1534.

See "Aktenstücke über das Verhalten der römischen Kurie zur Reformation, 1524-1531," in *Quellen und Forschungen* (Kon. Preuss. Hist. Inst., Rome), vol. iii. p. 1-20; T. M. Lindsay, *History of the Reformation*, vol. i. (Edinburgh, 1906).

CAJUPUT OIL, a volatile oil obtained by distillation from the leaves of the myrtaceous tree *Melaleuca leucadendron*, and probably other species. The trees yielding the oil are found throughout the Indian Archipelago, the Malay Peninsula and over the hotter parts of the Australian continent; but the greater portion of the oil is produced from Celebes Island. The name cajuput is derived from the native *Kayuputi* or white wood. The oil is prepared from leaves collected on a hot dry day, which are macerated in water, and distilled after fermenting for a night. This oil is extremely pungent to the taste, and has the odour of a mixture of turpentine and camphor. It consists mainly of cineol (see TERPENES), from which cajuputene having a hyacinthine odour can be obtained by distillation with phosphorus pentoxide. The drug is a typical volatile oil, and is used internally in doses of $\frac{1}{2}$ to 3 minims, for the same purposes as, say, clove oil. It is frequently employed externally as a counter-irritant.

CAKCHIQUEL, a tribe of Central American Indians of Mayan stock, inhabiting parts of Guatemala. Their name is said to be that of a native tree. At the conquest they were found to be in a much civilized condition.

See D. G. Brinton, *Annals of the Cakchiquels*.

¹ He was christened Giacomo, but afterwards took the name of Tommaso in honour of Thomas Aquinas.

CALABAR (or **Old Calabar**), a seaport of West Africa in the British protectorate of Southern Nigeria, on the left bank of the Calabar river in $4^{\circ} 56' N.$, $8^{\circ} 18' E.$, 5 m. above the point where the river falls into the Calabar estuary of the Gulf of Guinea. Pop. about 15,000. It is the capital of the eastern province of the protectorate, and is in regular steamship and telegraphic communication with Europe. From the beach, where are the business houses and customs office, rise cliffs of moderate elevation, and on the sides or summits of the hills are the principal buildings, such as Government House, the European hospital and the church of the Presbyterian mission. The valley between the hills is occupied by the native quarter, called Duke Town. Here are several fine houses in bungalow style, the residences of the chiefs or wealthy natives. Along the river front runs a tramway connecting Duke Town with Queen Beach, which is higher up and provided with excellent quays accommodation. Among the public institutions are government botanical gardens, primary schools and a high school. Palms, mangos and other trees grow luxuriantly in the gardens and open spaces, and give the town a picturesque setting. The trade is very largely centred in the export of palm oil and palm kernels and the import of cotton goods and spirits, mostly gin. (See NIGERIA for trade returns.)

Calabar was the name given by the Portuguese discoverers of the 15th century to the tribes on this part of the Guinea coast at the time of their arrival, when as yet the present inhabitants were unknown in the district. It was not till the early part of the 18th century that the Efik, owing to civil war with their kindred and the Ibibio, migrated from the neighbourhood of the Niger to the shores of the river Calabar, and established themselves at Ikoritungko or Creek Town, a spot 4 m. higher up the river. To get a better share in the European trade at the mouth of the river a body of colonists migrated further down and built Obutong or Old Town, and shortly afterwards a rival colony established itself at Aqua Akpa or Duke Town, which thus formed the nucleus of the existing town. The native inhabitants are still mainly Efik. They are pure negroes. They have been for several generations the middle men between the white traders on the coast and the inland tribes of the Cross river and Calabar district. Christian missions have been at work among the Efiks since the middle of the 19th century. Many of the natives are well educated, profess Christianity and dress in European fashion. A powerful bond of union among the Efik, and one that gives them considerable influence over other tribes, is the secret society known as the Egbo (*q.v.*). The chiefs of Duke Town and other places in the neighbourhood placed themselves in 1884 under British protection. From that date until 1906 Calabar was the headquarters of the European administration in the Niger delta. In 1906 the seat of government was removed to Lagos.

Until 1904 Calabar was generally, and officially, known as Old Calabar, to distinguish it from New Calabar, the name of a river and port about 100 m. to the east. Since the date mentioned the official style is Calabar simply. Calabar estuary is mainly formed by the Cross river (*q.v.*), but receives also the waters of the Calabar and other streams. The Rio del Rey creek at the eastern end of the estuary marks the boundary between (British) Nigeria and (German) Cameroon. The estuary is 10 to 12 m. broad at its mouth and maintains the same breadth for about 30 m.

CALABAR BEAN, the seed of a leguminous plant, *Physostigma venenosum*, a native of tropical Africa. It derives its scientific name from a curious beak-like appendage at the end of the stigma, in the centre of the flower; this appendage though solid was supposed to be hollow (hence the name from *phōra*, a bladder, and *stigma*). The plant has a climbing habit like the scarlet runner, and attains a height of about 50 ft. with a stem an inch or two in thickness. The seed pods, which contain two or three seeds or beans, are 6 or 7 in. in length; and the beans are about the size of an ordinary horse bean but much thicker, with a deep chocolate-brown colour. They constitute the E-ser-e or ordeal beans of the negroes of Old Calabar, being administered

to persons accused of witchcraft or other crimes. In cases where the poisonous material did its deadly work, it was held at once to indicate and rightly to punish guilt; but when it was rejected by the stomach of the accused, innocence was held to be satisfactorily established. A form of duelling with the seeds is also known among the natives, in which the two opponents divide a bean, each eating one-half; that quantity has been known to kill both adversaries. Although thus highly poisonous, the bean has nothing in external aspect, taste or smell to distinguish it from any harmless leguminous seed, and very disastrous effects have resulted from its being incautiously left in the way of children. The beans were first introduced into England in the year 1840; but the plant was not accurately described till 1861, and its physiological effects were investigated in 1863 by Sir Thomas R. Fraser.

The bean usually contains a little more than 1% of alkaloids. Of these two have been identified, one called *calabarine*, and the other, now a highly important drug, known as *physostigmine*—or occasionally as *eserine*. The British pharmacopoeia contains an alcoholic extract of the bean, intended for internal administration; but the alkaloid is now always employed. This is used as the sulphate, which has the empirical formula of $(C_{12}H_{17}N_3O_2)_2 \cdot H_2SO_4$, plus an unknown number of molecules of water. It occurs in small yellowish crystals, which are turned red by exposure to light or air. They are readily soluble in water or alcohol and possess a bitter taste. The dose is $\frac{1}{16}$ to $\frac{1}{8}$ grain, and should invariably be administered by hypodermic injection. For the use of the oculist, who constantly employs this drug, it is also prepared in *lamellae* for insertion within the conjunctival sac. Each of these contains one-thousandth part of a grain of physostigmine sulphate, a quantity which is perfectly efficient.

Physostigmine has no action on the unbroken skin. When swallowed it rapidly causes a great increase in the salivary secretion, being one of the most powerful *dialogues* known. It has been shown that the action is due to a direct influence on the secreting gland-cells themselves. After a few minutes the salivation is arrested owing to the constricting influence of the drug upon the blood-vessels that supply the glands. There is also felt a sense of constriction in the pharynx, due to the action of the drug on its muscular fibres. A similar stimulation of the non-striated muscle in the alimentary canal results in violent vomiting and purging, if a large dose has been taken. Physostigmine, indeed, stimulates nearly all the non-striated muscles in the body, and this action upon the muscular coats of the arteries, and especially of the arterioles, causes a great rise in blood-pressure shortly after its absorption, which is very rapid. The terminals of the vagus nerve are also stimulated, causing the heart to beat more slowly. Later in its action, the drug depresses the intra-cardiac motor ganglia, causing prolongation of diastole and finally arrest of the heart in dilatation. A large lethal dose kills by this action, but the minimum lethal dose by its combined action on the respiration and the heart. The respiration is at first accelerated by a dose of physostigmine, but is afterwards slowed and ultimately arrested. The initial hastening is due to a stimulation of the vagus terminals in the lung, as it does not occur if these nerves are previously divided. The final arrest is due to paralysis of the respiratory centre in the medulla oblongata, hastened by a quasi-asthmatic contraction of the non-striated muscular tissue in the bronchial tubes, and by a "water-logging" of the lungs due to an increase in the amount of bronchial secretion. It may here be stated that the non-striated muscular tissue of the bladder, the uterus and the spleen is also stimulated, as well as that of the iris (see below). It is only in very large doses that the voluntary muscles are poisoned, there being induced in them a tremor which may simulate ordinary convulsions. The action is a direct one upon the muscular tissue (cf. the case of the gland-cells), since it occurs in an animal whose motor nerves have been paralysed by curare.

Consciousness is entirely unaffected by physostigmine, there being apparently no action on any part of the brain above the medulla oblongata. But the influence of the alkaloid upon the

spinal cord is very marked and characteristic. The reflex functions of the cord are entirely abolished, and it has been experimentally shown that this is due to a direct influence upon the cells in the anterior cornua. It is precisely the reverse of the typical action of strychnine. Near the termination of a fatal case there is a paralysis of the sensory columns of the cord, so that general sensibility is lowered. The alkaloid calabarine is, on the other hand, a stimulant of the motor and reflex functions of the cord, so that only the pure alkaloid physostigmine and not any preparation of Calabar bean itself should be used when it is desired to obtain this action.

Besides the secretions already mentioned as being stimulated, the bile, the tears and the perspiration are increased by the exhibition of this drug.

There remains only to consider its highly important action upon the eye. Whether administered in the form of the official lamella or by subcutaneous injection, physostigmine causes a contraction of the pupil more marked than in the case of any other known drug. That this action is a direct and not a nervous one is shown by the fact that if the eye be suddenly shaded the pupil will dilate a little, showing that the nerves which cause dilatation are still competent after the administration of physostigmine. Besides the *sphincter pupillae*, the fibres of the ciliary muscle are stimulated. There is consequently spasm of accommodation, so that clear vision of distant objects becomes impossible. The intra-ocular tension is markedly lowered. This action, at first sight somewhat obscure, is due to the extreme pupillary contraction which removes the mass of the iris from pressing upon the spaces of Fontana, through which the intra-ocular fluids normally make a very slow escape from the eye into its efferent lymphatics.

There is a marked antagonism in nearly all important particulars between the actions of physostigmine and of atropine. The details of this antagonism, as well as nearly all our knowledge of this valuable drug, we owe to Sir Thomas Fraser, who introduced it into therapeutics.

The clinical uses of physostigmine are based upon the facts of its pharmacology, as above detailed. It has been recommended in cases of chronic constipation, and of want of tone in the muscular wall of the urinary bladder. It has undoubtedly been of value in many cases of tetanus, in which it must be given in maximal doses. (The tetanus antitoxin should invariably be employed as well.) Sir Thomas Fraser differs from nearly all other authorities in regarding the drug as useless in cases of strychnine poisoning, and the question must be left open. There is some doubtful evidence of the value of the alkaloid in chorea. The oculist uses it for at least six purposes. Its stimulant action on the iris and ciliary muscle is employed when they are weak or paralysed. It is used in all cases where one needs to reduce the intra-ocular tension, and for this and other reasons in glaucoma. It is naturally the most efficient agent in relieving the discomfort or intolerable pain of photophobia; and it is the best means of breaking down adhesions of the iris, and of preventing prolapse of the iris after injuries to the cornea. In fact it is hardly possible to over-estimate its value in ophthalmology. The drug has been highly and widely recommended in general paralysis, but there remains grave doubt as to its utility in this disease.

Toxicology.—The symptoms of Calabar bean poisoning have all been stated above. The obvious antidote is atropine, which may often succeed; and the other measures are those usually employed to stimulate the circulation and respiration. Unfortunately the antagonism between physostigmine and atropine is not perfect, and Sir Thomas Fraser has shown that in such cases there comes a time when, if the action of the two drugs be summated, death results sooner than from either alone. Thus atropine will save life after three and a half times the fatal dose of physostigmine has been taken, but will hasten the end if four or more times the fatal dose has been ingested. Thus it would be advisable to use the physiological antidote only when the dose of the poison—assuming estimation to be possible—was known to be comparatively small.

CALABASH (from the Span. *calabasa*, a gourd or pumpkin, possibly derived from the Pers. *khariwasa*, a melon), the shell of a gourd or pumpkin made into a vessel for holding liquids; also a vessel of similar shape made of other materials. It is the name of a tree (*Cracca Cujate*) of tropical America, whose gourd-like fruit is so hard that vessels made of it can be used over a fire many times before being burned.

CALABASH TREE, a native of the West Indies and South America, known botanically as *Cracca Cujate* (natural order, Bignoniaceae). The fruit resembles a gourd, and has a woody rind, which after removal of the pulp forms a calabash.

CALABOZO, or **CALABOSO**, an inland town of Venezuela, once capital of the province of Caracas in the colonial period, and now capital of the state of Guárico. Pop. (1891) 5618. Calabozo is situated in the midst of an extensive llano on the left bank of the Guárico river, 325 ft. above sea-level and 123 m. S.S.W. of Caracas. The plain lies slightly above the level of intersecting rivers and is frequently flooded in the rainy season; in summer the heat is most oppressive, the average temperature being 88° F. The town is regularly laid out with streets crossing at right angles, and possesses several fine old churches, a college and public school. It is also a bishop's see, and a place of considerable commercial importance because of its situation in the midst of a rich cattle-raising country. It is said to have been an Indian town originally, and was made one of the trading stations of the Compañía Guipuzcoana in 1730. However, like most Venezuelan towns, Calabozo made little growth during the 19th century. In 1820 the Spanish forces under Morales were defeated here by the revolutionists under Bolívar and Páez.

CALABRESILLA (sometimes spelt Calabrasella), an Italian card-game ("the little Calabrian game") for three players. All the tens, nines and eights are removed from an ordinary pack; the order of the cards is three, two, ace, king, queen, &c. In scoring the ace counts 3; the three 2; king, queen and knave 1 each. The last trick counts 3. Each separate hand is a whole game. One player plays against the other two, paying to each or receiving from each the difference between the number of points that he and they hold. Each player receives twelve cards, dealt two at a time. The remainder form the stock, which is left face downwards. There are no trumps. The player on the dealer's left declares first: he can either play or pass. The dealer has the last option. If one person announces that he plays, the others combine against him. If all decline to play, the deal passes, the hands being abandoned. The single player may demand any "three" he chooses, giving a card in exchange. If the three demanded is in the stock, no other card may be asked for. If a player hold all the threes, he may demand a two. The single player must take one card from the stock, in exchange for one of his own (which is never exposed) and may take more. He puts out the cards he wishes to exchange face downwards, and selects what he wishes from the stock, which is now exposed; the rejected cards and cards left in the stock form the "discard." The player on the dealer's left then leads. The highest card wins the trick, there being no trumps. Players must follow suit, if they can. The single player and the allies collect all the tricks they win respectively. The winner of the last trick, besides scoring three, adds the discard to his heap. The heaps are then searched for the scoring cards, the scores are compared and the stakes paid. It is important to remember that the value and the order of the cards are not the same, thus the ace, whose value is 3, is only third as a trick-winner; also that it is highly important to win the last trick. Thirty-five is the full score.

CALABRIA, a territorial district of both ancient and modern Italy.

(1) The ancient district consisted of the peninsula at its south-east extremity, between the Adriatic Sea and the Gulf of Tarentum, ending in the Iapygian promontory (Lat. *Promuntorium Salentinum*); the village upon it was called Leuca—Gr. *Aeua*; white, from its colour—and is still named S. Maria di Leuca) and corresponding in the main with the modern province of Lecce, Brundisium and Tarentum being its most north-westerly cities, though the boundary of the latter extends somewhat farther

west. It is a low terrace of limestone, the highest parts of which seldom reach 1500 ft.; the cliffs, though not high, are steep, and it has no rivers of any importance, but despite lack of water it was (and is) remarkably fertile. Strabo mentions its pastures and trees, and its olives, vines and fruit trees (which are still the principal source of prosperity) are frequently spoken of by the ancients. The wool of Tarentum and Brundisium was also famous, and at the former place were considerable dye-works. These two towns acquired importance in very early times owing to the excellence of their harbours. Traces of a prehistoric population of the stone and early bronze age are to be found all over Calabria. Especially noticeable are the menhirs (*pietre fitte*) and the round tower-like *specchie* or *truddi*, which are found near Lecce, Gallipoli and Muro Leccese (and only here in Italy); they correspond to similar monuments, the *perdas fitas* and the *nuraghi*, of Sardinia, and the inter-relation between the two populations which produced them requires careful study. In 272-266 B.C. we find six triumphs recorded in the Roman *fasti* over the Tarentini, Sallentini and Messapii, while the name Calabria does not occur; but after the foundation of a colony at Brundisium in 246-245 B.C., and the final subjection of Tarentum in 209 B.C., Calabria became the general name for the peninsula. The population declined to some extent; Strabo (vi. 281) tells us that in earlier days Calabria had been extremely populous and had had thirteen cities, but that in his time all except Tarentum and Brundisium, which retained their commercial importance, had dwindled down to villages. The Via Appia, prolonged to Brundisium perhaps as early as 190 B.C., passed through Tarentum; the shorter route by Canusium, Barium and Gnathia was only made into a main artery of communication by Trajan (see APPIA, VIA). The only other roads were the two coast roads, the one from Brundisium by Lupiae, the other from Tarentum by Manduria, Neretum, Aletium (with a branch to Callipolis) and Veretum (hence a branch to Leuca), which met at Hydruntum. Augustus joined Calabria to Apulia and the territory of the Hirpini to form the second region of Italy. From the end of the second century we find Calabria for juridical purposes associated either with Apulia or with Lucania and the district of the Bruttii, while Diocletian placed it under one *corrector* with Apulia. The loss of the name Calabria came with the Lombard conquest of this district, when it was transferred to the land of the Bruttii, which the Byzantine empire still held.

(2) The modern Calabria consists of the south extremity of Italy (the "toe of the boot" in the popular simile, while the ancient Calabria, with which the present province of Lecce more or less coincides, is the "heel"), bounded on the N. by the province of Potenza (Basilicata) and on the other three sides by the sea. Area 58,193 sq. m. The north boundary is rather farther north than that of the ancient district of the Bruttii (q.v.). Calabria acquired its present name in the time of the Byzantine supremacy, after the ancient Calabria had fallen into the hands of the Lombards and been lost to the Eastern empire about A.D. 668. The name is first found in the modern sense in Paulus Diaconus's *Historia Langobardorum* (end of the 8th century). It is mainly mountainous; at the northern extremity of the district the mountains still belong to the Apennines proper (the highest point, the Monte Pollino, 7325 ft., is on the boundary between Basilicata and Calabria), but after the plain of Sibari, traversed by the Crati (anc. Crathis, a river 58 m. long, the only considerable one in Calabria), the granite mountains of Calabria proper (though still called Apennines in ordinary usage) begin. They consist of two groups. The first extends as far as the isthmus, about 22 m. wide, formed by the gulfs of S. Eufemia and Squillace; its highest point is the Botte Donato (6330 ft.). It is in modern times generally called the Sila, in contradistinction to the second (southern) group, the Aspromonte (6420 ft.); the ancients on the other hand applied the name Sila to the southern group. The rivers in both parts of the chain are short and unimportant. The mountain districts are in parts covered with forest (though less so than in ancient times), still largely government property, while in much of the rest there is good pasture. The scenery is fine, though the country is hardly

at all visited by travellers. The coast strip is very fertile, and though some parts are almost deserted owing to malaria, others produce wine, olive-oil and fruit (oranges and lemons, figs, &c.) in abundance, the neighbourhood of Reggio being especially fertile. The neighbourhood of Cosenza is also highly cultivated; and at the latter place a school of agriculture has been founded, though the methods used in many parts of Calabria are still primitive. Wheat, rice, cotton, liquorice, saffron and tobacco are also cultivated. The coast fisheries are important, especially in and near the straits of Messina. Commercial organization is, however, wanting. The climate is very hot in summer, while snow lies on the mountain-tops for at least half the year. Earthquakes are frequent and have done great damage; that of the autumn of 1905 was very disastrous (O. Malagodi, *Calabria Desolata*, Rome, 1905), but it was surpassed in its effects by the terrible earthquake of 1908, by which Messina (q.v.) was destroyed, and in Calabria itself Reggio and numerous smaller places ruined. The railway communications are sufficient for the coast districts; there are lines along both the east and west coasts (the latter forms part of the through route by land from Italy to Sicily, ferry-boats traversing the Strait of Messina with the through trains on board) which meet at Reggio di Calabria. They are connected by a branch from Marina di Catanzaro passing through Catanzaro to S. Eufemia; and there is also a line from Sibari up the valley of the Crati to Cosenza and Pietrafita. The interior is otherwise untouched by railways; indeed many of the villages in the interior can only be approached by paths; and this is one of the causes of the economic difficulties of Calabria. Another is the unequal distribution of wealth, there being practically no middle class; a third is the injudicious disforestation which has been carried on without regard to the future. The natural check upon torrents is thus removed, and they sometimes do great damage. The Calabrian costumes are still much worn in the remoter districts: they vary considerably in the different villages. There is, and has been, considerable emigration to America, but many of the emigrants return, forming a slightly higher class, and producing a rise in the rate of payment to cultivators, which has increased the difficulties of the small proprietors. The smallness and large number of the communes, and the consequently large number of the professional classes and officials, are other difficulties, which, noticeable throughout Italy, are especially felt in Calabria. The population of Calabria was 1,439,329 in 1901. The chief towns of the province of Catanzaro were in 1901—Catanzaro (32,005), Nicastro (18,150), Monteleone (13,481), Cotrone (9,545), total of province (1871) 412,226; (1901) 498,791; number of communes, 152; of the province of Cosenza, Cosenza (20,857), Corigliano Calabro (15,379), Rossano (13,354), S. Giovanni in Fiore (13,288), Castrovillari (9945), total of province (1871) 440,468; (1901) 503,329, number of communes, 151; of the province of Reggio, Reggio di Calabria (44,569), Palmi (13,346), Cittanova (11,782), Gioiosa Ionica (11,200), Bagnara Calabria (11,136), Siderno Marina (10,775), Gerace (10,572), Polistena (10,112); number of communes 106; total of province (1871) 353,608; (1901) 437,209. A feature of modern Calabria is the existence of several Albanian colonies, founded in the 15th century by Albanians expelled by the Turks, who still speak their own language, wear their national costume, and worship according to the Greek rite. Similar colonies exist in Sicily, notably at Piana dei Greci near Palermo.

(T. AS.)
CALAFAT, a town of Rumania in the department of Doljju; on the river Danube, opposite the Bulgarian fortress of Vidin. Pop. (1900) 7113. Calafat is an important centre of the grain trade, and is connected by a branch line with the principal Walachian railways, and by a steam ferry with Vidin. It was founded in the 14th century by Genoese colonists, who employed large numbers of workmen (*Calafati*) in repairing ships—which industry gave its name to the place. In 1854 a Russian force was defeated at Calafat by the Turks under Ahmed Pasha, who surprised the enemy's camp.

CALAH (so in the Bible; *Kalah* in the Assyrian inscriptions), an ancient city situated in the angle formed by the Tigris and

the upper Zab, 19 m. S. of Nineveh, and one of the capitals of Assyria. According to the inscriptions, it was built by Shalmaneser I. about 1300 B.C., as a residence city in place of the older Assur. After that it seems to have fallen into decay or been destroyed, but was restored by Assur-nasir-pal, about 880 B.C., and from that time to the overthrow of the Assyrian power it remained a residence city of the Assyrian kings. It shared the fate of Nineveh, was captured and destroyed by the Medes and Babylonians toward the close of the 7th century, and from that time has remained a ruin. The site was discovered by Sir A. H. Layard, in 1845, in the *tel* of Nimrud. Hebrew tradition (in the J narrative, Genesis x. 11, 12) mentions Calah as built by Nimrod. Modern Arabic tradition likewise ascribes the ruins, like those of Birs Nimrud, near Babylon, to Nimrod, because they are the most prominent ruins of that region. Similarly the ancient dike in the river Tigris at this point is ascribed to Nimrod. The ruin mounds of Nimrud consist of an oblong enclosure, formed by the walls of the ancient city, of which fifty-eight towers have been traced on the N. and about fifty on the E. In the S.W. corner of this oblong is an elevated platform in the form of a rectangular parallelogram, some 600 yds. from N. to S. and 400 yds. from E. to W., raised on an average about 40 ft. above the plain, with a lofty cone 140 ft. high in the N.W. corner. This is the remains of the raised platform of unbaked brick, faced with baked bricks and stone, on which stood the principal palaces and temples of the city, the cone at the N.W. representing the *sigawat*, or stage-tower, of the principal temple. Originally on the banks of the Tigris, this platform now stands some distance E. of the river. Here Layard conducted excavations from 1845 to 1847, and again from 1849 to 1851. The means at his disposal were inadequate, his excavations were incomplete and also unscientific in that his prime object was the discovery of inscriptions and museum objects; but he was wonderfully successful in achieving the results at which he aimed, and the numerous statues, monuments, inscribed stones, bronze objects and the like found by him in the ruins of Calah are among the most precious possessions of the British Museum. Excavations were also conducted by Hormuzd Rassam in 1852-1854, and again in 1878, and by George Smith in 1873. But while supplementing in some important respects Layard's excavations, this later work added relatively little to his discoveries whether of objects or of facts. The principal buildings discovered at Calah are:—(a) the North-West palace, south of the *sigawat*, one of the most complete and perfect Assyrian buildings known, about 350 ft. square, consisting of a central court, 129 ft. by 90 ft., surrounded by a number of halls and chambers. This palace was originally constructed by Assur-nasir-pal I. (885-860 B.C.), and restored and reoccupied by Sargon (722-705 B.C.). In it were found the winged lions, now in the British Museum, the fine series of sculptured bas-reliefs glorifying the deeds of Assur-nasir-pal in war and peace, and the large collection of bronze vessels and implements, numbering over 200 pieces; (b) the Central palace, in the interior of the mound, toward its southern end, erected by Shalmaneser II. (860-825 B.C.) and rebuilt by Tiglath-pileser III. (745-727 B.C.). Here were found the famous black obelisk of Shalmaneser, now in the British Museum, in the inscription on which the tribute of Jehu, son of Omri, is mentioned, the great winged bulls, and also a fine series of slabs representing the battles and sieges of Tiglath-pileser; (c) the South-West palace, in the S.W. corner of the platform, an uncompleted building of Esarhaddon (681-668 B.C.), who robbed the North-West and Central palaces, effacing the inscriptions of Tiglath-pileser, to obtain material for his construction; (d) the smaller West palace, between the South-West and the North-West palaces, a construction of Hadad-nirari or Adadnirari III. (812-783 B.C.); (e) the South-East palace, built by Assur-tiliani, after 626 B.C., for his harem, in the S.E. corner of the platform, above the remains of an older similar palace of Shalmaneser; (f) two small temples of Assur-nasir-pal, in connexion with the *sigawat* in the N.W. corner; and (g) a temple called E-Zida, and dedicated to Nebo, near the South-East palace. From the number of colossal figures of Nebo discovered here it

would appear that the cult of Nebo was a favourite one, at least during the later period. The other buildings on the E. side of the platform had been ruined by the post-Assyrian use of the mound for a cemetery, and for tunnels for the storage and concealment of grain. While the ruins of Calah were remarkably rich in monumental material, enamelled bricks, bronze and ivory objects and the like, they yielded few of the inscribed clay tablets found in such great numbers at Nineveh and various Babylonian sites. Not a few of the astrological and omen tablets in the Kuyunjik collection of the British Museum, however, although found at Nineveh, were executed, according to their own testimony, at Calah for the *rab-dup-sarré* or principal librarian during the reigns of Sargon and Sennacherib (716-684 B.C.). From this it would appear that there was at that time at Calah a library or a collection of archives which was later removed to Nineveh. In the prestige of antiquity and religious renown, Calah was inferior to the older capital, Assur, while in population and general importance it was much inferior to the neighbouring Nineveh. There is no proper ground for regarding it, as some Biblical scholars of a former generation did, through a false interpretation of the book of Jonah, as a part or suburb of Nineveh.

See A. H. Layard, *Nineveh and its Remains* (London, 1849); George Smith, *Assyrian Discoveries* (London, 1883); Hormuzd Rassam, *Ashur and the Land of Nimrod* (London and New York, 1897). (J. P. Pz.)

CALAHORRA (anc. *Calagurris*), a city of northern Spain, in the province of Logroño; on the left bank of the river Cidacos, which enters the Ebro 3 m. E., and on the Bilbao-Saragossa railway. Pop. (1900) 9475. Calahorra is built on the slope of a hill overlooking the wide Ebro valley, which supplies its markets with an abundance of grain, wine, oil and flax. Its cathedral, which probably dates from the foundation of the see of Calahorra in the 5th century, was restored in 1485, and subsequently so much altered that little of the original Gothic structure survives. The Casa Santa, annually visited by many thousands of pilgrims on the 31st of August, is said to contain the bodies of the martyrs Emeterius and Celedonius, who were beheaded in the 3rd or 4th century, on the site now occupied by the cathedral. Their heads, according to local legend, were cast into the Ebro, and, after floating out to sea and rounding the Iberian peninsula, are now preserved at Santander.

The chief remains of the Roman Calagurris are the vestiges of an aqueduct and an amphitheatre. Calagurris became famous in 76 B.C., when it was successfully defended against Pompey by the adherents of Sertorius. Four years later it was captured by Pompey's legate, Afranius, after starvation had reduced the garrison to cannibalism. Under Augustus (31 B.C.-A.D. 14) Calagurris received the privileges of Roman citizenship, and at a later date it was given the additional name of *Nassica* to distinguish it from the neighbouring town of *Calagurris Fibularenis*, the exact site of which is uncertain. The rhetorician Quintilian was born at Calagurris Nassica about A.D. 35.

CALAIS, a seaport and manufacturing town of northern France, in the department of Pas-de-Calais, 18 m. E.S.E. of Dover, and 185 m. N. of Paris by the Northern railway. Pop. (1906) 59,623. Calais, formerly a celebrated fortress, is defended by four forts, not of modern construction, by a citadel built in 1560, which overlooks it on the west, and by batteries. The old town stands on an island hemmed in by the canal and the harbour basins, which divide it from the much more extensive manufacturing quarter of St Pierre, enveloping it on the east and south. The demolition of the ramparts of Old Calais was followed by the construction of a new circle of defences, embracing both the old and new quarters, and strengthened by a deep moat. In the centre of the old town is the Place d'Armes, in which stands the former hôtel-de-ville (rebuilt in 1740, restored in 1867), with busts of Eustache de St Pierre, Francis, duke of Guise, and Cardinal Richelieu. The belfry belongs to the 16th and early 17th century. Close by is the Tour du Guet, or watch-tower, used as a lighthouse until 1848. The church of Notre-Dame, built during the English occupancy of Calais, has a

fine high altar of the 17th century; its lofty tower served as a landmark for sailors. A gateway flanked by turrets (14th century) is a relic of the Hôtel de Guise, built as a guild hall for the English woolstaplers, and given to the duke of Guise as a reward for the recapture of Calais. The modern town-hall and a church of the 19th century are the chief buildings of the quarter of St Pierre. Calais has a board of trade-arbitrators, a tribunal and a chamber of commerce, a commercial and industrial school, and a communal college.

The harbour is entered from the roads by way of a channel leading to the outer harbour which communicates with a floating basin 22 acres in extent, on the east, and with the older and less commodious portion of the harbour to the north and west of the old town. The harbour is connected by canals with the river Aa and the navigable waterways of the department.

Calais is the principal port for the continental passenger traffic with England carried on by the South-Eastern & Chatham and the Northern of France railways. The average number of passengers between Dover and Calais for the years 1902-1906 inclusive was 315,012. Trade is chiefly with the United Kingdom. The principal exports are wines, especially champagne, spirits, hay, straw, wool, potatoes, woven goods, fruit, glass-ware, lace and metal-ware. Imports include cotton and silk goods, coal, iron and steel, petroleum, timber, raw wool, cotton yarn and cork. During the five years 1901-1905 the average annual value of exports was £8,388,000 (£6,363,000 in the years 1896-1900), of imports £4,145,000 (£3,759,000 in 1896-1900). In 1905, exclusive of passenger and mail boats, there entered the port 848 vessels of 312,477 tons and cleared 857 of 305,284 tons, these being engaged in the general carrying trade of the port. The main industry of Calais is the manufacture of tulle and lace, for which it is the chief centre in France. Brewing, saw-milling, boat-building, and the manufacture of biscuits, soap and submarine cables are also carried on. Deep-sea and coast fishing for cod, herring and mackerel employ over 1000 of the inhabitants.

Calais was a petty fishing-village, with a natural harbour at the mouth of a stream, till the end of the 10th century. It was first improved by Baldwin IV., count of Flanders, in 997, and afterwards, in 1224, was regularly fortified by Philip Hurepel, count of Boulogne. It was besieged in 1346, after the battle of Crécy, by Edward III. and held out resolutely by the bravery of Jean de Vienne, its governor, till after nearly a year's siege famine forced it to surrender. Its inhabitants were saved from massacre by the devotion of Eustache de St Pierre and six of the chief citizens, who were themselves spared at the prayer of Queen Philippa. The city remained in the hands of the English till 1558, when it was taken by Francis, duke of Guise, at the head of 30,000 men from the ill-provided English garrison, only 800 strong, after a siege of seven days. From this time the *Calaisis* or territory of Calais was known as the *Pays Reconquis*. It was held by the Spaniards from 1595 to 1598, but was restored to France by the treaty of Vervins.

CALAIS, a city and sub-port of entry of Washington county, Maine, U.S.A., on the Saint Croix river, 12 m. from its mouth, opposite Saint Stephens, New Brunswick, with which it is connected by bridges. Pop. (1890) 7200; (1900) 7655 (1908 being foreign-born); (1910) 6116. It is served by the Washington County railway (102.5 m. to Washington Junction, where it connects with the Maine Central railway), and by steamboat lines to Boston, Portland and Saint Johns. In the city limits are the post-offices of Calais, Milltown and Red Beach. The city has a small public library. The valley here is wide and deep, the banks of the river bold and picturesque, and the tide rises and falls about 25 ft. The city has important interests in lumber, besides foundries, machine shops, granite works—there are several granite (notably red granite) quarries in the vicinity—a tannery, and manufactories of shoes and calcined plaster. Big Island, now in the city of Calais, was visited in the winter of 1604-1605 by Pierre du Guast, sieur de Monts. Calais was first settled in 1779, was incorporated as a town in 1809, and was chartered as a city in 1851.

CALAIS and **ZETES** (the Boreadae), in Greek mythology, the winged twin sons of Boreas and Oreithyia. On their arrival with the Argonauts at Salmyleus in Thrace, they liberated their sister Cleopatra, who had been thrown into prison with her two sons by her husband Phineus, the king of the country (Sophocles, *Antigone*, 966; Diod. Sic. iv. 44). According to another story, they delivered Phineus from the Harpies (q.v.), in pursuit of whom they perished (Apollodorus i. 9; iii. 15). Others say that they were slain by Heracles near the island of Tenos, in consequence of a quarrel with Tiphys, the pilot of the Argonauts, or because they refused to wait during the search for Hylas, the favourite of Heracles (Hyginus, *Fab.*, 14. 273; schol. on Apollonius Rhodius i. 1304). They were changed by the gods into winds, and the pillars over their tombs in Tenos were said to wave whenever the wind blew from the north. Like the Harpies, Calais and Zetes are obvious personifications of winds. Legend attributed the foundation of Calais in Campania to Calais (Silvius Italicus viii. 512).

CALAMINE, a mineral species consisting of zinc carbonate, $ZnCO_3$, and forming an important ore of zinc. It is rhombohedral in crystallization and isomorphous with calcite and chalybite. Distinct crystals are somewhat rare; they have the form of the primitive rhombohedron ($\alpha = 72^\circ 20'$), the faces of which are generally curved and rough. Botryoidal and stalactitic masses are more common, or again the mineral may be compact and granular or loose and earthy. As in the other rhombohedral carbonates, the crystals possess perfect cleavages parallel to the faces of the rhombohedron. The hardness is 5; specific gravity, 4.4. The colour of the pure mineral is white; more often it is brownish, sometimes green or blue; a bright-yellow variety containing cadmium has been found in Arkansas, and is known locally as "turkey-fat ore." The pure material contains 52% of zinc, but this is often partly replaced isomorphously by small amounts of iron and manganese, traces of calcium and magnesium, and sometimes by copper or cadmium.

Calamine is found in beds and veins in limestone rocks, and is often associated with galena and blende. It is a product of alteration of blende, having been formed from this by the action of carbonated waters; or in many cases the zinc sulphide may have been first oxidized to sulphate, which in solution acted on the surrounding limestone, producing zinc carbonate. The latter mode of origin is suggested by the frequent occurrence of calamine pseudomorphous after calcite, that is, having the form of calcite crystals. Deposits of calamine have been extensively mined in the limestones of the Mendip Hills, in Derbyshire, and at Alston Moor in Cumberland. It also occurs in large amount in the province of Santander in Spain, in Missouri, and at several other places where zinc ores are mined. The best crystals of the mineral were found many years ago at Chessy near Lyons; these are rhombohedra of a fine apple-green colour. A translucent botryoidal calamine banded with blue and green is found at Laurion in Greece, and has sometimes been cut and polished for small ornaments such as brooches.

The name calamine (German, *Galmes*), from *lapis calaminaris*, a Latin corruption of *cadmia* (*καδμία*), the old name for zinc ores in general (G. Agricola in 1546 derived it from the Latin *calamus*, a reed), was early used indiscriminately for the carbonate and the hydrous silicate of zinc, and even now both species are included by miners under the same term. The two minerals often closely resemble each other in appearance, and can usually only be distinguished by chemical analysis; they were first so distinguished by James Smithson in 1803. F. S. Beudant in 1830 restricted the name calamine to the hydrous silicate and proposed the name "smithsonite" for the carbonate, and these meanings of the terms are now adopted by Dana and many other mineralogists. Unfortunately, however, in England (following Brooke and Miller, 1852) these designations have been reversed, calamine being used for the carbonate and smithsonite for the silicate. This unfortunate confusion is somewhat lessened by the use of the terms zinc-spar and hemimorphite (q.v.) for the carbonate and silicate respectively. (L. J. S.)

CALAMIS, an Athenian sculptor of the first half of the 5th century B.C. He made statues of Apollo the averter of ill, Hermes the ram-bearer, Aphrodite and other deities, as well as part of a chariot group for Hiero, king of Syracuse. His works are praised by ancient critics for delicacy and grace, as opposed to breadth and force. Archaeologists are disposed to regard the bronze charioteer recently found at Delphi as a work of Calamis; but the evidence is not conclusive (see GREEK ART).

CALAMY, EDMUND, known as "the elder" (1600-1666), English Presbyterian divine, was born of Huguenot descent in Walbrook, London, in February 1600, and educated at Pembroke Hall, Cambridge, where his opposition to the Arminian party, then powerful in that society, excluded him from a fellowship. Nicholas Felton, bishop of Ely, however, made him his chaplain, and gave him the living of St Mary, Swaffham Prior, which he held till 1626. He then removed to Bury St Edmunds, where he acted as lecturer for ten years, retiring when his bishop (Wren) insisted on the observance of certain ceremonial articles. In 1636 he was appointed rector (or perhaps only lecturer) of Rochford in Essex, which was so unhealthy that he had soon to leave it, and in 1639 he was elected to the perpetual curacy of St Mary Aldermanbury in London, where he had a large following. Upon the opening of the Long Parliament he distinguished himself in defence of the Presbyterian cause, and had a principal share in writing the conciliatory work known as *Smectynianus*, against Bishop Joseph Hall's presentation of episcopacy. The initials of the names of the several contributors formed the name under which it was published, viz., S. Marshall, E. Calamy, T. Young, M. Newcomen and W. Spurstone. Calamy was an active member in the Westminster assembly of divines, and, refusing to advance to Congregationalism, found in Presbyterianism the middle course which best suited his views of theology and church government. He opposed the execution of Charles I., lived quietly under the Commonwealth, and was assiduous in promoting the king's return; for this he was afterwards offered the bishopric of Coventry and Lichfield, but declined it, it is said, on his wife's persuasion. He was made one of Charles's chaplains, and vainly tried to secure the legal ratification of Charles's declaration of the 25th of October 1660. He was ejected for Nonconformity in 1662, and was so affected by the sight of the devastation caused by the great fire of London that he died shortly afterwards, on the 29th of October 1666. He was buried in the ruins of his church, near the place where the pulpit had stood. His publications are almost entirely sermons. His eldest son (Edmund), known as "the younger," was educated at Cambridge, and was ejected from the rectory of Moreton, Essex, in 1662. He was of a retiring disposition and moderate views, and died in 1685.

CALAMY, EDMUND (1671-1732), English Nonconformist divine, the only son of Edmund Calamy "the younger," was born in London, in the parish of St Mary Aldermanbury, on the 5th of April 1671. He was sent to various schools, including Merchant Taylors', and in 1688 proceeded to the university of Utrecht. While there, he declined an offer of a professor's chair in the university of Edinburgh made to him by the principal, William Carstares, who had gone over on purpose to find suitable men for such posts. After his return to England in 1691 he began to study divinity, and on Baxter's advice went to Oxford, where he was much influenced by Chillingworth. He declined invitations from Andover and Bristol, and accepted one as assistant to Matthew Sylvester at Blackfriars (1692). In June 1694 he was publicly ordained at Annesley's meeting-house in Little St Helen's, and soon afterwards was invited to become assistant to Daniel Williams in Hand Alley, Bishopsgate. In 1702 he was chosen one of the lecturers in Salters' Hall, and in 1703 he succeeded Vincent Alsop as pastor of a large congregation in Westminster. In 1709 Calamy made a tour through Scotland, and had the degree of doctor of divinity conferred on him by the universities of Edinburgh, Aberdeen and Glasgow. Calamy's forty-one publications are mainly sermons, but his fame rests on his nonconformist biographies. His first essay was a table of contents to Baxter's *Narrative* of his life and times, which was

sent to the press in 1696; he made some remarks on the work itself and added to it an index, and, reflecting on the usefulness of the book, he saw the expediency of continuing it, as Baxter's history came no further than the year 1684. Accordingly, he composed an abridgment of it, with an account of many other ministers who were ejected after the restoration of Charles II.; their apology, containing the grounds of their nonconformity and practice as to stated and occasional communion with the Church of England; and a continuation of their history until the year 1691. This work was published in 1702. The most important chapter (ix.) is that which gives a detailed account of the ministers ejected in 1662; it was afterwards published as a distinct volume. He afterwards published a moderate defence of Nonconformity, in three tracts, in answer to some tracts of Benjamin, afterwards Bishop, Hoedly. In 1713 he published a second edition (2 vols.) of his *Abridgment of Baxter's History*, in which, among various additions, there is a continuation of the history through the reigns of William and Anne, down to the passing of the Occasional Bill. At the end is subjoined the reformed liturgy, which was drawn up and presented to the bishops in 1661. In 1718 he wrote a vindication of his grandfather and several other persons against certain reflections cast upon them by Laurence Echard in his *History of England*. In 1719 he published *The Church and the Dissenters Compared as to Persecution*, and in 1728 appeared his *Continuation of the Account of the ejected ministers and teachers*, a volume which is really a series of emendations of the previously published account. He died on the 3rd of June 1732, having been married twice and leaving six of his thirteen children to survive him. Calamy was a kindly man, frankly self-conscious, but very free from jealousy. He was an able diplomatist and generally secured his ends. His great hero was Baxter, of whom he wrote three distinct memoirs. His eldest son Edmund (the fourth) was a Presbyterian minister in London and died 1755; another son (Edmund, the fifth) was a barrister who died in 1816; and this one's son (Edmund, the sixth) died in 1850, his younger brother Michael, the last of the direct Calamy line, surviving till 1876.

CALARASHI (*Călărăși*), the capital of the Jalomitz department, Rumania, situated on the left bank of the Borcea branch of the Danube, amid wide fens, north of which extends the desolate Baragan Steppe. Pop. (1900) 11,024. Calarashi has a considerable transit trade in wheat, linseed, hemp, timber and fish from a broad mere on the west or from the Danube. Small vessels carry cargo to Braila and Galatz, and a branch railway from Calarashi traverses the Steppe from south to north, and meets the main line between Bucharest and Constantza.

CALAS, JEAN (1698-1762), a Protestant merchant at Toulouse, whose legal murder is a celebrated case in French history. His wife was an Englishwoman of French extraction. They had three sons and three daughters. His son Louis had embraced the Roman Catholic faith through the persuasions of a female domestic who had lived thirty years in the family. In October 1761 another son, Antoine, hanged himself in his father's warehouse. The crowd, which collected on so shocking a discovery, took up the idea that he had been strangled by the family to prevent him from changing his religion, and that this was a common practice among Protestants. The officers of justice adopted the popular tale, and were supplied by the mob with what they accepted as conclusive evidence of the fact. The fraternity of White Penitents buried the body with great ceremony, and performed a solemn service for the deceased as a martyr; the Franciscans followed their example; and these formalities led to the popular belief in the guilt of the unhappy family. Being all condemned to the rack in order to extort confession, they appealed to the parlement; but this body, being as weak as the subordinate magistrates, sentenced the father to the torture, ordinary and extraordinary, to be broken alive upon the wheel, and then to be burnt to ashes; which decree was carried into execution on the 6th of March 1762. Pierre Calas, the surviving son, was banished for life; the rest were acquitted. The distracted widow, however, found some friends, and among them Voltaire, who laid her case before the council of state at

Versailles. For three years he worked indefatigably to procure justice, and made the Calas case famous throughout Europe (see *VOLTAIRE*). Finally the king and council unanimously agreed to annul the proceeding of the parlement of Toulouse; Calas was declared to have been innocent, and every imputation of guilt was removed from the family.

See *Causas célèbres*, tome iv.; Raoul Allier, *Voltaire et Calas, une erreur judiciaire au XVIII^e siècle* (Paris, 1898); and biographies of Voltaire.

CALASH (from Fr. *calèche*, derived from Polish *kolaska*, a wheeled carriage), a light carriage with a folding hood; the Canadian calash is two-wheeled and has a seat for the driver on the splash-board. The word is also used for a kind of hood made of silk stretched over hoops, formerly worn by women.

CALASIAO, a town of the province of Pangasinán, Luzon, Philippine Islands, on a branch of the Agno river, about 4 m. S. by E. of Dagupan, the N. terminal of the Manila & Dagupan railway. Pop. (1903) 16,539. In 1903, after the census had been taken, the neighbouring town of Santa Barbara (pop. 10,367) was annexed to Calasiao. It is in the midst of a fertile district and has manufactures of hats and various woven fabrics.

CALASIO, MARIO DI (1550-1620), Italian Minorite friar, was born at a small town in the Abruzzi whence he took his name. Joining the Franciscans at an early age, he devoted himself to Oriental languages and became an authority on Hebrew. Coming to Rome he was appointed by Paul V., whose confessor he was, to the chair of Scripture at Ara Coeli, where he died on the 1st of February 1620. Calasio is known by his *Concordantiae sacrorum Bibliorum hebraicorum*, published in 4 vols. (Rome, 1622), two years after his death, a work which is based on Nathan's *Hebrew Concordance* (Venice, 1533). For forty years Calasio laboured on this work, and he secured the assistance of the greatest scholars of his age. The *Concordance* evinces great care and accuracy. All root-words are treated in alphabetical order and the whole Bible has been collated for every passage containing the word, so as to explain the original idea, which is illustrated from the cognate usages of the Chaldee, Syrian, Rabbinical Hebrew and Arabic. Calasio gives under each Hebrew word the literal Latin translation, and notes any existing differences from the Vulgate and Septuagint readings. An incomplete English translation of the work was published in London by Romaine in 1747. Calasio also wrote a Hebrew grammar, *Canones generales linguae sanctatae* (Rome, 1616), and the *Dictionarium hebraicum* (Rome, 1617).

CALATAFIMI, a town of the province of Trapani, Sicily, 30 m. W.S.W. of Palermo direct (5½ m. by rail). Pop. (1901) 11,426. The name of the town is derived from the Saracenic castle of *Kalat-al-Fimi* (castle of Euphemius), which stands above it. The principal church contains a fine Renaissance reredos in marble. Samuel Butler, the author of *Erewhon*, did much of his work here. The battlefield where Garibaldi won his first victory over the Neapolitans on the 15th of May 1860, lies 2 m. S.W.

CALATAYÚD, a town of central Spain, in the province of Saragossa, at the confluence of the rivers Jalón and Jiloca, and on the Madrid-Saragossa and Calatayúd-Sagunto railways. Pop. (1900) 11,526. Calatayúd consists of a lower town, built on the left bank of the Jalón, and an upper or Moorish town, which contains many dwellings hollowed out of the rock above and inhabited by the poorer classes. Among a number of ecclesiastical buildings, two collegiate churches are especially noteworthy. Santa Maria, originally a mosque, has a lofty octagonal tower and a fine Renaissance doorway, added in 1528; while Santo Sepulcro, built in 1141, and restored in 1613, was long the principal church of the Spanish Knights Templar. In commercial importance Calatayúd ranks second only to Saragossa among the Aragonese towns, for it is the central market of the exceptionally fertile expanse watered by the Jalón and Jiloca. About 2 m. E. are the ruins of the ancient *Bilbilis*, where the poet Martial was born c. A.D. 40. It was celebrated for its breed of horses, its armourers, its gold and its iron; but Martial also mentions its unhealthy climate, due to the icy winds which sweep down from

the heights of Moncayo (7705 ft.) on the north. In the middle ages the ruins were almost destroyed to provide stone for the building of Calatayúd, which was founded by a Moorish amir named Ayub and named *Kalat Ayub*, "Castle of Ayub." Calatayúd was captured by Alphonso I. of Aragon in 1119.

CALATIA, an ancient town of Campania, Italy, 6 m. S.E. of Capua, on the Via Appia, near the point where the Via Popilia branches off from it. It is represented by the church of S. Giacomo alle Galazze. The Via Appia here, as at Capua, abandons its former S.E. direction for a length of 3000 Oscan ft. (1804 English ft.), for which it runs due E. and then resumes its course S.E. There are no ruins, but a considerable quantity of débris; and the pre-Roman necropolis was partially excavated in 1832. Ten shafts lined with slabs of tufa which were there found may have been the approaches to tombs or may have served as wells. The history of Calatia is practically that of its more powerful neighbour Capua, but as it lay near the point where the Via Appia turns east and enters the mountains, it had some strategic importance. In 313 B.C. it was taken by the Samnites and recaptured by the dictator Q. Fabius; the Samnites captured it again in 311, but it must have been retaken at an unknown date. In the 3rd century we find it issuing coins with an Oscan legend, but in 211 B.C. it shared the fate of Capua. In 174 we hear of its walls being repaired by the censors. In 59 B.C. a colony was established here by Caesar.

See Ch. Hülsen in Pauly-Wissowa, *Realencyclopädie*, iii. 1334 (Stuttgart, 1899).

CALAVERAS SKULL, a famous fossil cranium, reported by Professor J. D. Whitney as found (1886) in the undisturbed auriferous gravels of Calaveras county, California. The discovery at once raised the still discussed question of "tertiary man" in the New World. Doubt has been thrown on the genuineness of the find, as the age of the gravels is disputed and the skull is of a type corresponding exactly with that of the present Indian inhabitants of the district. Whitney assigns the fossil to late Tertiary (Pliocene) times, and concludes that "man existed in California previous to the cessation of volcanic activity in the Sierra Nevada, to the epoch of the greatest extension of the glaciers in that region and to the erosion of the present river cañons and valleys, at a time when the animal and vegetable creation differed entirely from what they now are. . . ." The specimen is preserved in the Peabody museum, Cambridge, Mass.

CALBAYOG, a town of the province of Samar, Philippine Islands, on the W. coast at the mouth of the Calbayog river, about 30 m. N.W. of Cathalogan, the capital, in lat. 14° 3' N. Pop. (1903) 15,895. Calbayog has an important export trade in hemp, which is shipped to Manila. Copra is also produced in considerable quantity, and there is fine timber in the vicinity. There are hot springs near the town. The neighbouring valleys of the Gándara and Hippatan rivers are exceedingly fertile, but in 1908 were uncultivated. The climate is very warm, but healthy. The language is Visayan.

CALBE, or **KALBE**, a town of Germany, on the Saale, in Prussian Saxony. It is known as Calbe-an-der-Saale, to distinguish it from the smaller town of Calbe on the Milde in the same province. Pop. (1905) 12,281. It is a railway junction, and among its industries are wool-weaving and the manufacture of cloth, paper, stoves, and bricks. Cucumbers and onions are cultivated, and soft coal is mined in the neighbourhood.

CALCAR (or **KALCKER**), **JOHN DE** (1499-1546), Italian painter, was born at Calcar, in the duchy of Cleves. He was a disciple of Titian at Venice, and perfected himself by studying Raphael. He imitated those masters so closely as to deceive the most skillful critics. Among his various pieces is a Nativity, representing the angels around the infant Christ, which he arranged so that the light emanated wholly from the child. He died at Naples.

CALCEOLARIA, in botany, a genus belonging to the natural order Scrophulariaceae, containing about 150 species of herbaceous or shrubby plants, chiefly natives of the South American Andes of Peru and Chile. The calceolaria of the present day has

been developed into a highly decorative plant, in which the herbaceous habit has preponderated. The plants are now very generally raised annually from seed, which is sown about the end of June in a mixture of loam, leaf-mould and sand, and, being very small, must be only slightly covered. When the plants are large enough to handle they are pricked out an inch or two apart into $\frac{3}{4}$ -inch or 5-inch pots; when a little more advanced they are potted singly. They should be wintered in a greenhouse with a night temperature of about 40° , occupying a shelf near the light. By the end of February they should be moved into 8-inch or 10-inch pots, using a compost of three parts good turfy loam, one part leaf-mould, and one part thoroughly rotten manure, with a fair addition of sand. They need plenty of light and air, but must not be subjected to draughts. When the pots get well filled with roots, they must be liberally supplied with manure water. In all stages of growth the plants are subject to the attacks of the green-fly, for which they must be fumigated.

The so-called shrubby calcolarias used for bedding are increased from cuttings, planted in autumn in cold frames, where they can be wintered, protected from frost by the use of mats and a good layer of litter placed over the glass and round the sides.

CALCHAQUI, a tribe of South American Indians, now extinct, who formerly occupied northern Argentina. Stone and other remains prove them to have reached a high degree of civilization. They offered a vigorous resistance to the first Spanish colonists coming from Chile.

CALCHAS, of Mycenae or Megara, son of Thestor, the most famous soothsayer among the Greeks at the time of the Trojan war. He foretold the duration of the siege of Troy, and, when the fleet was detained by adverse winds at Aulis, he explained the cause and demanded the sacrifice of Iphigenia. When the Greeks were visited with pestilence on account of Chryseis, he disclosed the reasons of Apollo's anger. It was he who suggested that Neoptolemus and Philoctetes should be fetched from Scyros and Lemnos to Troy, and he was one of those who advised the construction of the wooden horse. When the Greeks, on their journey home after the fall of Troy, were overtaken by a storm, Calchas is said to have been thrown ashore at Colophon. According to another story, he foresaw the storm and did not attempt to return by sea. It had been predicted that he should die when he met his superior in divination; and the prophecy was fulfilled in the person of Mopsus, whom Calchas met in the grove of the Clarian Apollo near Colophon. Having been beaten in a trial of soothsaying, Calchas died of chagrin or committed suicide. He had a temple and oracle in Apulia.

Ovid, *Metam.* xii. 18 ff.; Homer, *Iliad* l. 68, ii. 322; Strabo vi. p. 284, xiv. p. 642.

CALCITE, a mineral consisting of naturally occurring calcium carbonate, CaCO_3 , crystallizing in the rhombohedral system. With the exception of quartz, it is the most widely distributed of minerals, whilst in the beautiful development and extraordinary variety of form of its crystals it is surpassed by none. In the massive condition it occurs as large rock-masses (marble, limestone, chalk) which are often of organic origin, being formed of the remains of molluscs, corals, crinoids, &c., the hard parts of which consist largely of calcite.

The name calcite (Lat. *calx*, *calcis*, meaning burnt lime) is of comparatively recent origin, and was first applied, in 1836, to the "barleycorn" pseudomorphs of calcium carbonate after celestite from Sangerhausen in Thuringia; it was not until about 1843 that the name was used in its present sense. The mineral had, however, long been known under the names calcareous spar and calc-spar, and the beautifully transparent variety called Iceland-spar had been much studied. The strong double refraction and perfect cleavages of Iceland-spar were described in detail by Erasmus Bartholinus in 1669 in his book *Experimentia Crystalli Islandici diadematitici*; the study of the same mineral led Christiana Huygens to discover in 1690 the laws of double refraction, and E. L. Malus in 1808 the polarization of light.

An important property of calcite is the great ease with which it may be cleaved in three directions; the three perfect cleavages

are parallel to the faces of the primitive rhombohedron, and the angle between them was determined by W. H. Wollaston in 1812, with the aid of his newly invented reflective goniometer, to be $74^{\circ} 55'$. The cleavage is of great help in distinguishing calcite from other minerals of similar appearance. The hardness of 3 (it is readily scratched with a knife), the specific gravity of 2.72, and the fact that it effervesces briskly in contact with cold dilute acids are also characters of determinative value.

Crystals of calcite are extremely varied in form, but, as a rule, they may be referred to four distinct habits, namely: rhombohedral, prismatic, scalenohedral and tabular. The primitive rhombohedron, r {100} (fig. 1), is comparatively rare except in combination with other forms. A flatter rhombohedron, e {110}, is shown in fig. 2, and a more acute one, f {111}, in fig. 3. These three rhombohedra are related in such a manner that, when in combination, the faces of r truncate the polar edges of f , and the faces of e truncate the edges of r . The crystal of prismatic habit shown in fig. 4 is a combination of the prism m {211} and the rhombohedron e {110}; fig. 5 is a combination of the scalenohedron σ {201} and the rhombohedron r {100}; and the crystal of tabular habit represented in fig. 6 is a combination of the basal pinacoid c {111}, prism m {211}, and rhombohedron e {110}. In these figures only six distinct forms (r, e, f, m, σ, c) are

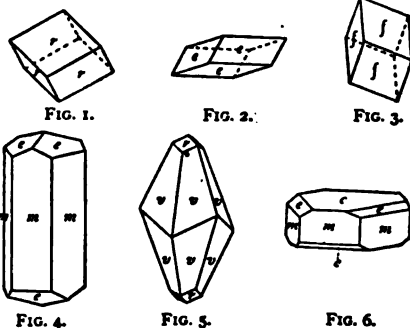

FIGS. 1-6.—Crystals of Calcite.

represented, but more than 400 have been recorded for calcite, whilst the combinations of them are almost endless.

Depending on the habits of the crystals, certain trivial names have been used, such, for example, as dog-tooth-spar for the crystals of scalenohedral habit, so common in the Derbyshire lead mines and limestone caverns; nail-head-spar for crystals terminated by the obtuse rhombohedron e , which are common in the lead mines of Alston Moor in Cumberland; slate-spar (German *Schieferspath*) for crystals of tabular habit, and sometimes as thin as paper; cannon-spar for crystals of prismatic habit terminated by the basal pinacoid c .

Calcite is also remarkable for the variety and perfection of its twinned crystals. Twinned crystals, though not of infrequent occurrence, are, however, far less common than simple (untwinned) crystals. No less than four well-defined twin-laws are to be distinguished:—

i. Twin-plane c (111).—Here there is rotation of one portion with respect to the other through 180° about the principal (trigonal) axis, which is perpendicular to the plane c (111); or the same result may be obtained by reflection across this plane. Fig. 7 shows a prismatic crystal (like fig. 4) twinned in this manner, and fig. 8 represents a twinned scalenohedron σ {201}.

ii. Twin-plane e (110).—The principal axes of the two portions are inclined at an angle of $52^{\circ} 30'$. Repeated twinning on this plane is very common, and the twin-lamellae (fig. 9) to which it gives rise are often to be observed in the grains of calcite of crystalline limestones which have been subjected to pressure. This lamellar twinning is of secondary origin; it may be readily produced artificially by pressure, for example, by pressing a knife into the edge of a cleavage rhombohedron.

iii. Twin-plane γ (100).—Here the principal axes of the two portions are nearly at right angles ($89^\circ 14'$), and one of the directions of cleavage in both portions is parallel to the twin-plane. Fine crystals of prismatic habit twinned according to this law were formerly found in considerable numbers at Wheal Wrey in Cornwall, and of scalenohedral habit at Eyam in Derbyshire and Cleator Moor in Cumberland; those from the last two localities are known as "butterfly twins" or "heart-shaped twins" (fig. 10), according to their shape.

iv. Twin-plane f (111).—The principal axes are here inclined at $53^\circ 46'$. This is the rarest twin-law of calcite.

Calcite when pure, as in the well-known Iceland-spar, is perfectly transparent and colourless. The lustre is vitreous. Owing to the presence of various impurities, the transparency and colour may vary considerably. Crystals are often nearly white or colourless, usually with a slight yellowish tinge. The yellowish colour is in most cases due to the presence of iron, but in some cases it has been proved to be due to organic matter (such as apocrenic acid) derived from the humus overlying the rocks in which the crystals were formed. An opaque calcite of a grass-green colour, occurring as large cleavage masses in central India and known as hislopite, owes its colour to enclosed "green-earth" (glauconite and celadonite). A stalagmitic calcite of a

case of enclosed impurities is presented by the so-called Fontainebleau limestone, which consists of crystals of calcite of an acute rhombohedral form (fig. 3) enclosing 50 to 60% of quartz-sand. Similar crystals, but with the form of an acute hexagonal pyramid, and enclosing 64% of sand, have recently been found in large quantity over a wide area in South Dakota, Nebraska and Wyoming. The case of hislopite, which encloses up to 20% of "green earth," has been noted above.

In addition to the varieties of calcite noted above, some others, depending on the state of aggregation of the material, are distinguished. A finely fibrous form is known as satin-spar ($q.v.$), a name also applied to fibrous gypsum: the most typical example of this is the snow-white material, often with a rosy tinge and a pronounced silky lustre, which occurs in veins in the Carboniferous shales of Alston Moor in Cumberland. Finely scaly varieties with a pearly lustre are known as argentine and aprhite (German *Schönwiespath*); soft, earthy and dull white varieties are agarie mineral, rock-milk, rock-meal, &c.—these form a transition to marls, chalk, &c. Of the granular and compact forms numerous varieties are distinguished (see LUNASTONE and MARBLE). In the form of stalactites calcite is of extremely common occurrence. Each stalactite usually consists of an aggregate of radially arranged crystalline individuals, though sometimes it may consist of a single individual with crystal faces developed at the free end. Onyx-marbles or Oriental alabaster (see ALABASTER) and other stalagmitic deposits also consist of calcite, and so do the allied deposits of travertine, calc-sinter or calc-tufa.

The modes of occurrence of calcite are very varied. It is a common gangue mineral in metalliferous deposits, and in the form of crystals is often associated with ores of lead, iron, copper and silver. It is a common product of alteration in igneous rocks, and frequently occurs as well-developed crystals in association with zeolites lining the amygdaloidal cavities of basaltic and other rocks. Veins and cavities in limestones are usually lined with crystals of calcite. The wide distribution, under various conditions, of crystallized calcite is readily explained by the solubility of calcium carbonate in water containing carbon dioxide, and the ease with which the material is again deposited in the crystallized state when the carbon dioxide is liberated by evaporation. On this also depends the formation of stalactites and calc-sinter.

Localities at which beautifully crystallized specimens of calcite are found are extremely numerous. For beauty of crystals and variety of forms the haematite mines of the Cleator Moor district in west Cumberland and the Furness district in north Lancashire are unsurpassed. The lead mines of Alston in Cumberland and of Derbyshire, and the silver mines of Andreasberg in the Harz and Guanajuato in Mexico have yielded many fine specimens. From the zinc mines of Joplin in Missouri enormous crystals of golden-yellow and amethystine colours have been recently obtained. At all the localities here mentioned the crystals occur with metalliferous ores. In Iceland the mode of occurrence is quite distinct, the mineral being here found in a cavity in basalt.

The quarry, which since the 17th century has supplied the famous Iceland-spar, is in a cavity in basalt, the cavity itself measuring 12 by 5 yds. in area and about 10 ft. in height. It is situated quite close to the farm Helgustadir, about an hour's ride from the trading station of Eakifjörður on Reydar Fjörður, on the east coast of Iceland. This cavity when first found was filled with pure crystallized masses and enormous crystals. The crystals measure up to a yard across, and are rhombohedral or scalenohedral in habit; their faces are usually dull and corroded or coated with stilbite. In recent years much of the material taken out has not been of sufficient transparency for optical purposes, and this, together with the very limited supply, has caused a considerable rise in price. Only very occasionally has calcite from any locality other than Iceland been used for the construction of a Nicol's prism. (L. J. S.)

CALCIUM [symbol Ca, atomic weight 40.0 (0=16)], a metallic chemical element, so named by Sir Humphry Davy from its

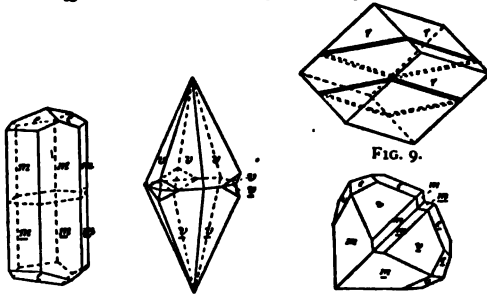

FIG. 7. FIG. 8. FIG. 9.
FIG. 7-10.—Twinned Crystals of Calcite.

beautiful purple colour, from Reichelsdorf in Hesse, is coloured by cobalt.

Optically, calcite is uniaxial with negative bi-refringence, the index of refraction for the ordinary ray being greater than for the extraordinary ray; for sodium-light the former is 1.6583 and the latter 1.4862. The difference, 0.1723, between these two indices gives a measure of the bi-refringence or double refraction.

Although the double refraction of some other minerals is greater than that of calcite (e.g. for cinnabar it is 0.347, and for calomel 0.683), yet this phenomenon can be best demonstrated in calcite, since it is a mineral obtainable in large pieces of perfect transparency. Owing to the strong double refraction and the consequent wide separation of the two polarized rays of light traversing the crystal, an object viewed through a cleavage rhombohedron of Iceland-spar is seen double, hence the name doubly-refracting spar. Iceland-spar is extensively used in the construction of Nicol's prisms for polariscopes, polarizing microscopes and saccharimeters, and of dichroscopes for testing the pleochroism of gem-stones.

Chemically, calcite has the same composition as the orthorhombic aragonite ($q.v.$), these minerals being dimorphous forms of calcium carbonate. Well-crystallized material, such as Iceland-spar, usually consists of perfectly pure calcium carbonate, but at other times the calcium may be isomorphously replaced by small amounts of magnesium, barium, strontium, manganese, zinc or lead. When the elements named are present in large amount we have the varieties dolomitic calcite, baricalcite, strontianocalcite, ferrocalcite, manganocalcite, zincocalcite and plumbocalcite, respectively.

Mechanically enclosed impurities are also frequently present, and it is to these that the colour is often due. A remarkable

occurrence in chalk (Latin *calx*). It does not occur in nature in the free state, but in combination it is widely and abundantly diffused. Thus the sulphate constitutes the minerals anhydrite, alabaster, gypsum, and selenite; the carbonate occurs dissolved in most natural waters and as the minerals chalk, marble, calcite, aragonite; also in the double carbonates such as dolomite, bromilite, barytocalcite; the fluoride as fluorspar; the fluo-phosphate constitutes the mineral apatite; while all the more important mineral silicates contain a proportion of this element.

Extraction.—Calcium oxide or lime has been known from a very remote period, and was for a long time considered to be an elementary or undecomposable earth. This view was questioned in the 18th century, and in 1808 Sir Humphry Davy (*Phil. Trans.*, 1808, p. 303) was able to show that lime was a combination of a metal and oxygen. His attempts at isolating this metal were not completely successful; in fact, metallic calcium remained a laboratory curiosity until the beginning of the 20th century. Davy, inspired by his successful isolation of the metals sodium and potassium by the electrolysis of their hydrates, attempted to decompose a mixture of lime and mercuric oxide by the electric current; an amalgam of calcium was obtained, but the separation of the mercury was so difficult that even Davy himself was not sure as to whether he had obtained pure metallic calcium. Electrolysis of lime or calcium chloride in contact with mercury gave similar results. Bunsen (*Ann.*, 1854, 92, p. 248) was more successful when he electrolysed calcium chloride moistened with hydrochloric acid; and A. Matthiessen (*Jour. Chem. Soc.*, 1856, p. 38) obtained the metal by electrolysing a mixture of fused calcium and sodium chlorides. Henri Moissan obtained the metal of 99% purity by electrolysing calcium iodide at a low red heat, using a nickel cathode and a graphite anode; he also showed that a more convenient process consisted in heating the iodide with an excess of sodium, forming an amalgam of the product, and removing the sodium by means of absolute alcohol (which has but little action on calcium), and the mercury by distillation.

The electrolytic isolation of calcium has been carefully investigated, and this is the method followed for the commercial production of the metal. In 1902 W. Borchers and L. Stockem (*Zeit. für Electrochemie*, 1902, p. 8757) obtained the metal of 90% purity by electrolysing calcium chloride at a temperature of about 780°, using an iron cathode, the anode being the graphite vessel in which the electrolysis was carried out. In the same year, O. Ruff and W. Plato (*Ber.* 1902, 35, p. 3612) employed a mixture of calcium chloride (100 parts) and fluorspar (16.5 parts), which was fused in a porcelain crucible and electrolysed with a carbon anode and an iron cathode. Neither of these processes admitted of commercial application, but by a modification of Ruff and Plato's process, W. Ruthenau and C. Suter have made the metal commercially available. These chemists electrolyse either pure calcium chloride, or a mixture of this salt with fluorspar, in a graphite vessel which serves as the anode. The cathode consists of an iron rod which can be gradually raised. On electrolysis a layer of metallic calcium is formed at the lower end of this rod on the surface of the electrolyte; the rod is gradually raised, the thickness of the layer increases, and ultimately a rod of metallic calcium, forming, as it were, a continuation of the iron cathode, is obtained. This is the form in which calcium is put on the market.

An idea as to the advance made by this method is recorded in the variation in the price of calcium. At the beginning of 1904 it was quoted at 5s. per gram, £250 per kilogram or £110 per pound; about a year later the price was reduced to 21s. per kilogram, or 12s. per kilogram in quantities of 100 kilograms. These quotations apply to Germany; in the United Kingdom the price (1905) varied from 27s. to 30s. per kilogram (12s. to 13s. per lb.).

Properties.—A freshly prepared surface of the metal closely resembles zinc in appearance, but on exposure to the air it rapidly tarnishes, becoming yellowish and ultimately grey or white in colour owing to the formation of a surface layer of calcium hydrate. A faint smell of acetylene may be perceived during the oxidation in moist air; this is probably due to traces of calcium carbide.

It is rapidly acted on by water, especially if means are taken to remove the layer of calcium hydrate formed on the metal; alcohol acts very slowly. In its chemical properties it closely resembles barium and strontium, and to some degree magnesium; these four elements comprise the so-called metals of the "alkaline earths." It combines directly with most elements, including nitrogen; this can be taken advantage of in forming almost a perfect vacuum, the oxygen combining to form the oxide, CaO, and the nitrogen to form the nitride, Ca₃N₂. Several of its physical properties have been determined by K. Arndt (*Ber.*, 1904, 37, p. 4733). The metal as prepared by electrolysis generally contains traces of aluminium and silica. Its specific gravity is 1.54, and after remelting 1.56; after distillation it is 1.52. It melts at about 800°, but sublimes at a lower temperature.

Compounds.—Calcium hydride, obtained by heating electrolytic calcium in a current of hydrogen, appears in commerce under the name hydrolite. Water decomposes it to give hydrogen free from ammonia and acetylene, 1 gram yielding about 100 ccs. of gas (Frats Aymersch, *Abst. J. C. S.*, 1907, p. 460). Calcium forms two oxides—the monoxide, CaO, and the dioxide, CaO₂. The monoxide and its hydrate are more familiarly known as lime (q.v.) and slaked-lime. The dioxide was obtained as the hydrate, CaO₂·8H₂O, by P. Thénard (*Ann. Chim. Phys.*, 1818, 8, p. 213), who precipitated lime-water with hydrogen peroxide. It is permanent when dry; on heating to 130° C. it loses water and gives the anhydrous dioxide as an unstable, pale buff-coloured powder, very sparingly soluble in water. It is used as an antiseptic and oxidizing agent.

Whereas calcium chloride, bromide, and iodide are deliquescent solids, the fluoride is practically insoluble in water; this is a parallelism to the soluble silver fluoride, and the insoluble chloride, bromide and iodide. Calcium fluoride, CaF₂, constitutes the mineral fluor-spar (q.v.), and is prepared artificially as an insoluble white powder by precipitating a solution of calcium chloride with a soluble fluoride. One part dissolves in 26,000 parts of water. Calcium chloride, CaCl₂, occurs in many natural waters, and as a by-product in the manufacture of carbonic acid (carbon dioxide), and potassium chlorate. Aqueous solutions deposit crystals containing 2, 4 or 6 molecules of water. Anhydrous calcium chloride, prepared by heating the hydrate to 200° (preferably in a current of hydrochloric acid gas, which prevents the formation of any oxychloride), is very hygroscopic, and is used as a desiccating agent. It fuses at 723°. It combines with gaseous ammonia and forms crystalline compounds with certain alcohols. The crystallized salt dissolves very readily in water, with a considerable absorption of heat; hence its use in forming "freezing mixtures." A temperature of -53° C. is obtained by mixing 10 parts of the hexahydrate with 7 parts of snow. A saturated solution of calcium chloride contains 325 parts of CaCl₂ to 1000 of water at the boiling point (179.5°). Calcium iodide and bromide are white deliquescent solids and closely resemble the chloride.

Chloride of lime or "bleaching powder" is a calcium chlorohypochlorite or an equimolecular mixture of the chloride and hypochlorite (see ALKALI MANUFACTURE AND BLEACHING).

Calcium carbide, CaC₂, a compound of great industrial importance as a source of acetylene, was first prepared by F. Wöhler. It is now manufactured by heating lime and carbon in the electric furnace (see ACETYLENE). Heated in chlorine or with bromine, it yields carbon and calcium chloride or bromide; at a dull red heat it burns in oxygen, forming calcium carbonate, and it becomes incandescence in sulphur vapour at 500°, forming calcium sulphide and carbon disulphide. Heated in the electric furnace in a current of air, it yields calcium cyanamide (see CYANAMIDE).

Calcium carbonates, CaCO₃, is of exceptionally wide distribution in both the mineral and animal kingdoms. It constitutes the bulk of the chalk deposits and limestone rocks; it forms over one-half of the mineral dolomite and the rock magnesium limestone; it occurs also as the dimorphous minerals aragonite (q.v.) and calcite (q.v.). Tuff (q.v.) and travertine are calcareous deposits found in volcanic districts. Most natural waters contain it dissolved in carbonic acid; this confers "temporary hardness" on the water. The dissipation of the dissolved carbon dioxide results in the formation of "fur" in kettles or boilers, and if the solution is falling, as from the roof of a cave, in the formation of stalactites and stalagmites. In the animal kingdom it occurs as both calcite and aragonite in the tests of the foraminifera, echinoderms, brachiopoda, and mollusca; also in the skeletons of sponges and corals. Calcium carbonate is obtained as a white precipitate, almost insoluble in water (1 part requiring 10,000 of water for solution), by mixing solutions of a carbonate and a calcium salt. Hot or dilute cold solutions deposit minute orthorhombic crystals of aragonite, cold saturated or moderately strong solutions, hexagonal (rhombohedral) crystals of calcite. Aragonite is the least stable form; crystals have been found altered to calcite.

Calcium nitride, Ca₃N₂, is a greyish-yellow powder formed by heating calcium in air or nitrogen; water decomposes it with evolution of ammonia (see H. Moissan, *Compt. Rend.*, 127, p. 497).

Calcium nitrate, Ca(NO₃)₂·4H₂O, is a highly deliquescent salt.

crystallizing in monoclinic prisms, and occurring in various natural waters, as an efflorescence in limestone caverns, and in the neighbourhood of decaying nitrogenous organic matter. Hence its synonymy, "wall-saltpetre," and "lime-saltpetre"; from its disintegrating action on mortar, it is sometimes referred to as "saltpetre rot." The anhydrous nitrate, obtained by heating the crystallized salt, is very phosphorescent, and constitutes "Baldwin's phosphorus." A basic nitrate, $\text{Ca}(\text{NO}_3)_2 \cdot \text{Ca}(\text{OH})_2 \cdot 3\text{H}_2\text{O}$, is obtained by dissolving calcium hydroxide in a solution of the normal nitrate.

Calcium phosphide, Ca_3P_2 , is obtained as a reddish substance by passing phosphorus vapour over strongly heated lime. Water decomposes it with the evolution of spontaneously inflammable hydrogen phosphide; hence its use as a marine signal fire ("Holmes lights"), (see L. Gattermann and W. Haussknecht, *Ber.*, 1890, 23, p. 1176, and H. Moissan, *Compt. Rend.*, 128, p. 787).

Of the calcium orthophosphates, the normal salt, $\text{Ca}_3(\text{PO}_4)_2$, is the most important. It is the principal inorganic constituent of bones, and hence of the "bone-ash" of commerce (see PHOSPHORUS); it occurs with fluorides in the mineral apatite (*q.v.*); and the concretions known as coprolites (*q.v.*) largely consist of this salt. It also constitutes the minerals ornithite, $\text{Ca}_3(\text{PO}_4)_2 \cdot 2\text{H}_2\text{O}$, osteolite and somberite. The mineral brushite, $\text{CaH}_2\text{PO}_4 \cdot 2\text{H}_2\text{O}$, which is isomorphous with the acid arsenate pharmacolite, $\text{CaHAsO}_4 \cdot 2\text{H}_2\text{O}$, is an acid phosphate, and assumes monoclinic forms. The normal salt may be obtained artificially, as a white gelatinous precipitate which shrinks greatly on drying, by mixing solutions of sodium hydrogen phosphate, ammonia, and calcium chloride. Crystals may be obtained by heating di-calcium pyrophosphate, $\text{Ca}_2\text{P}_2\text{O}_7$, with water under pressure. It is insoluble in water; slightly soluble in solutions of carbonic acid and common salt, and readily soluble in concentrated hydrochloric and nitric acid. Of the acid orthophosphates, the mono-calcium salt, $\text{CaH}_2(\text{PO}_4)_2$, may be obtained as crystalline scales, containing one molecule of water, by evaporating a solution of the normal salt in hydrochloric or nitric acid. It dissolves readily in water, the solution having an acid reaction. The artificial manure known as "superphosphate of lime" consists of this salt and calcium sulphate, and is obtained by treating ground bones, coprolites, &c., with sulphuric acid. The di-calcium salt, $\text{Ca}_2\text{H}_2(\text{PO}_4)_2$, occurs in a concretionary form in the ureters and cloaca of the sturgeon, and also in guano. It is obtained as rhombic plates by mixing dilute solutions of calcium chloride and sodium phosphate, and passing carbon dioxide into the liquid. Other phosphates are also known.

Calcium monosulphide, CaS , a white amorphous powder, sparingly soluble in water; is formed by heating the sulphate with charcoal, or by heating lime in a current of sulphuretted hydrogen. It is particularly noteworthy from the phosphorescence which it exhibits when heated, or after exposure to the sun's rays; hence its synonym "Canton's phosphorus," after John Canton (1718-1772), an English natural philosopher. The sulphhydrate or hydrosulphide, $\text{Ca}(\text{SH})_2$, is obtained as colourless, prismatic crystals of the composition $\text{Ca}(\text{SH})_2 \cdot 6\text{H}_2\text{O}$, by passing sulphuretted hydrogen into milk of lime. The strong aqueous solution deposits colourless, four-sided prisms of the hydroxy-hydrosulphide, $\text{Ca}(\text{OH})(\text{SH})$. The disulphide, CaS_2 , and pentasulphide, CaS_5 , are formed when milk of lime is boiled with flowers of sulphur. These sulphides form the basis of Balmain's luminous paint. An oxysulphide, $2\text{CaS} \cdot \text{CaO}$, is sometimes present in "soda-waste," and orange-coloured, acicular crystals of $4\text{CaS} \cdot \text{CaSO}_4 \cdot 18\text{H}_2\text{O}$ occasionally settle out on the long standing of oxidized "soda- or alkali-waste" (see ALKALI MANUFACTURE).

Calcium sulphite, CaSO_3 , a white substance, soluble in water, is prepared by passing sulphur dioxide into milk of lime. This solution with excess of sulphur dioxide yields the "bisulphite of lime" of commerce, which is used in the "chemical" manufacture of wood-pulp for paper making.

Calcium sulphate, CaSO_4 , constitutes the minerals anhydrite (*q.v.*), and, in the hydrated form, selenite, gypsum (*q.v.*), alabaster (*q.v.*), and also the adhesive plaster of Paris (see CEMENT). It occurs dissolved in many natural waters, which it renders "permanently hard." It is obtained as a white crystalline precipitate, sparingly soluble in water (100 parts of water dissolve 24 of the salt at 15° C.), by mixing solutions of a sulphate and a calcium salt; it is more soluble in solutions of common salt and hydrochloric acid, and especially of sodium thiosulphate.

Calcium silicates are exceptionally abundant in the mineral kingdom. Calcium metasilicate, CaSiO_3 , occurs in nature as monoclinic crystals known as tabular spar or wollastonite; it may be prepared artificially from solutions of calcium chloride and sodium silicate. H. Le Chatelier (*Annales des mines*, 1887, p. 345) has obtained artificially the compounds: CaSiO_3 , Ca_2SiO_4 , $\text{Ca}_3\text{Si}_2\text{O}_7$, and $\text{Ca}_4\text{Si}_3\text{O}_{10}$. (See also G. Oddo, *Chemisches Centralblatt*, 1896, 228.) Acid calcium silicates are represented in the mineral kingdom by gyrolite, $\text{H}_2\text{Ca}_3(\text{SiO}_3)_2 \cdot \text{H}_2\text{O}$, a lime zeolite, sometimes regarded as an altered form of apophyllite (*q.v.*), which is itself an acid calcium silicate containing an alkaline fluoride, by okenite, $\text{H}_2\text{Ca}(\text{SiO}_3)_2 \cdot \text{H}_2\text{O}$, and by xonalite $4\text{CaSiO}_3 \cdot \text{H}_2\text{O}$. Calcium silicate is also present in the minerals: olivine, pyroxenes, amphiboles, epidote, feldspars, zeolites, scapolites (*q.v.*).

Detection and Estimation.—Most calcium compounds, especially when moistened with hydrochloric acid, impart an orange-red colour

to a Bunsen flame, which when viewed through green glass appears to be fusch-green; this distinguishes it in the presence of strontium, whose crimson coloration is apt to mask the orange-red calcium flame (when viewed through green glass the strontium flame appears to be a very faint yellow). In the spectroscopic calcium exhibits two intense lines—an orange line (α), (λ 6163), a green line (β), (λ 4239), and a fainter indigo line. Calcium is not precipitated by sulphuretted hydrogen, but falls as the carbonate when an alkaline carbonate is added to a solution. Sulphuric acid gives a white precipitate of calcium sulphate with strong solutions; ammonium oxalate gives calcium oxalate, practically insoluble in water and dilute acetic acid, but readily soluble in nitric or hydrochloric acid. Calcium is generally estimated by precipitation as oxalate which, after drying, is heated and weighed as carbonate or oxide, according to the degree and duration of the heating.

CALCULATING MACHINES. Instruments for the mechanical performance of numerical calculations, have in modern times come into ever-increasing use, not merely for dealing with large masses of figures in banks, insurance offices, &c., but also, as cash registers, for use on the counters of retail shops. They may be classified as follows:—(i.) Addition machines; the first invented by Blaise Pascal (1642). (ii.) Addition machines modified to facilitate multiplication; the first by G. W. Leibnitz (1671). (iii.) True multiplication machines; Léon Bollé (1858), Steiger (1894). (iv.) Difference machines; Johann Helfrich von Müller (1786), Charles Babbage (1822). (v.) Analytical machines; Babbage (1834). The number of distinct machines of the first three kinds is remarkable and is being constantly added to, old machines being improved and new ones invented; Professor R. Mehmke has counted over eighty distinct machines of this type. The fullest published account of the subject is given by Mehmke in the *Encyclopädie der mathematischen Wissenschaften*, article "Numerisches Rechnen," vol. 1, Heft 6 (1901). It contains historical notes and full references. Walther von Dyck's *Catalogue* also contains descriptions of various machines. We shall confine ourselves to explaining the principles of some leading types, without giving an exact description of any particular one.

Practically all calculating machines contain a "counting work," a series of "figure disks" consisting in the original form of horizontal circular disks (fig. 1), on which the figures 0, 1, 2, to 9 are marked. Each disk can turn about its vertical axis, and is covered by a fixed plate with a hole or "window" in it through which one figure can be seen. On turning the disk through one-tenth of a revolution this figure will be changed into the next higher or lower. Such turning may be called a "step," positive if the next higher and negative if the next lower figure appears. Each positive step therefore adds one unit

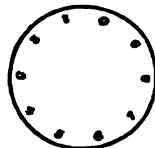

FIG. 1.

to the figure under the window, while two steps add two, and so on. If a series, say six, of such figure disks be placed side by side, their windows lying in a row, then any number of six places can be made to appear, for instance 000733. In order to add 6425 to this number, the disks, counting from right to left, have to be turned 5, 2, 4 and 6 steps respectively. If this is done the sum 00678 will appear. In case the sum of the two figures at any disk is greater than 9, if for instance the last figure to be added is 8 instead of 5, the sum for this disk is 11 and the 1 only will appear. Hence an arrangement for "carrying" has to be introduced. This may be done as follows. The axis of a figure disk contains a wheel with ten teeth. Each figure disk has, besides, one long tooth which when its 0 passes the window turns the next wheel to the left, one tooth forward, and hence the figure disk one step. The actual mechanism is not quite so simple, because the long teeth as described would gear also into the wheel to the right, and besides would interfere with each other. They must therefore be replaced by a somewhat more complicated arrangement, which has been done in various ways not necessary to describe more fully. On the way in which this is done, however, depends to a great extent the durability and trustworthiness of any arithmometer; in fact, it is often its weakest point. If to the series of figure disks arrangements are added for turning each disk through a required number of steps,

we have an addition machine, essentially of Pascal's type. In it each disk had to be turned by hand. This operation has been simplified in various ways by mechanical means. For pure addition machines key-boards have been added, say for each disk nine keys marked 1 to 9. On pressing the key marked 6 the disk turns six steps and so on. These have been introduced by Stettner (1882), Max Mayer (1887), and in the comptometer by Dorr Z. Felt of Chicago. In the comptograph by Felt and also in "Burrough's Registering Accountant" the result is printed.

These machines can be used for multiplication, as repeated addition, but the process is laborious, depending for rapid execution essentially on the skill of the operator.¹ To adapt

Modified addition machines.

an addition machine, as described, to rapid multiplication the turnings of the separate figure disks are replaced by one motion, commonly the turning of a handle. As, however, the different disks have to be turned through different steps, a contrivance has to be inserted which can be "set" in such a way that by one turn of the handle each disk is moved through a number of steps equal to the number of units which is to be added on that disk. This may be done by making each of the figure disks receive on its axis a ten-toothed wheel, called hereafter the A-wheel, which is acted on either directly or indirectly by another wheel (called the B-wheel) in which the number of teeth can be varied from 0 to 9. This variation of the teeth has been effected in different ways. Theoretically the simplest seems to be to have on the B-wheel nine teeth which can be drawn back into the body of the wheel, so that at will any number from 0 to 9 can be made to project. This idea, previously mentioned by Leibnitz, has been realized by Boddner in the "Brunsviga." Another way, also due to Leibnitz, consists in inserting between the axis of the handle bar and the A-wheel a "stepped" cylinder. This may be considered as being made up of ten wheels large enough to contain about twenty teeth each; but most of these teeth are cut away so that these wheels retain in succession 9, 8, . . . , 1, 0 teeth. If these are made as one piece they form a cylinder with teeth of lengths from 9, 8 . . . times the length of a tooth on a single wheel.

In the diagrammatic vertical section of such a machine (fig. 2) FF is a figure disk with a conical wheel A on its axis. In the covering plate HK is the window W. A stepped cylinder is shown at B. The axis Z, which runs along the whole machine, is turned by a handle, and itself turns the cylinder B by aid of conical wheels. Above this cylinder lies an axis EE with square section along which a wheel D can be moved. The same axis carries at E' a pair of conical

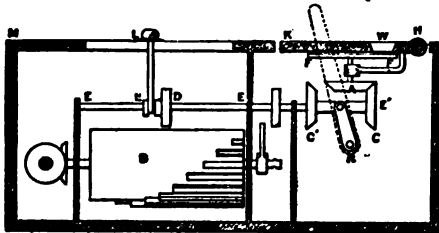

FIG. 2.

wheels C and C', which can also slide on the axis so that either can be made to drive the A-wheel. The covering plate MK has a slot above the axis EE allowing a rod LL' to be moved by aid of a button L, carrying the wheel D with it. Along the slot is a scale of numbers 0, 2, . . . , 9 corresponding with the number of teeth on the cylinder B, with which the wheel D will gear in any given position. A series of such slots is shown in the top middle part of Steiger's machine (fig. 3). Let now the handle driving the axis Z be turned once round, the button being set to 4. Then four teeth of the B-wheel will turn D and with it the A-wheel, and consequently the figure disk will be moved four steps. These steps will be positive or forward if the wheel C gears in A, and consequently four will be added to the figure showing at the window W. But if the wheels C' are moved to the right, C' will gear with A moving backwards, with

¹For a fuller description of the manner in which a mere addition machine can be used for multiplication and division, and even for the extraction of square roots, see an article by C. V. Boys in *Nature*, 11th July 1901.

the result that four is subtracted at the window. This motion of all the wheels C is done simultaneously by the push of a lever which appears at the top plate of the machine, its two positions being marked "addition" and "subtraction." The B-wheels are in fixed positions below the plate MK. Level with this, but separate, is the plate KH with the window. On it the figure disks are mounted.

This plate is hinged at the back at H and can be lifted up, thereby throwing the A-wheels out of gear. When thus raised the figure disk can be set to any figures; at the same time it can slide to and fro so that an A-wheel can be put in gear with any C-wheel forming with it one "element." The number of these varies with the size of the machine. Suppose there are six B-wheels and twelve figure disks. Let these be all set to zero with the exception of the last four to the right, these showing 1 4 3 2, and let these be placed opposite the last B-wheels to the right. If now the buttons belonging to the latter be set to 3 2 5 6, then on turning the B-wheels all once round the latter figures will be added to the former, thus showing 4 6 8 8 at the windows. By aid of the axis Z, this turning of the B-wheels is performed simultaneously by the movement of one handle. We have thus an addition machine. If it be required to multiply a number, say 725, by any number up to six figures, say 357, the buttons are set to the figures 725, the windows all showing zero. The handle is then turned, 725 appears at the windows, and successive turns add this number to the first. Hence seven turns show the product seven times 725. Now the plate with the A-wheels is lifted and moved one step to the right, then lowered, and the handle turned five times, thus adding fifty times 725 to the product obtained. Finally, by moving the plate again, and turning the handle three times, the required product is obtained. If the machine has six B-wheels and twelve disks the product of two six-figure numbers can be obtained. Division is performed by repeated subtraction. The lever regulating the C-wheel is set to subtraction, producing negative steps at the disks. The dividend is set up at the windows and the divisor at the buttons. Each turn of the handle subtracts the divisor once. To count the number of turns of the handle a second set of windows is arranged with number disks below. These have no carrying arrangement, but one is turned one step for each turn of the handle. The machine described is essentially that of Thomas of Colmar, which was the first that came into practical use. Of earlier machines those of Leibnitz, Müller (1782), and Hahn (1809) deserve to be mentioned (see Dyck, *Calculus*). Thomas's machine has had many imitations, both in England and on the Continent, with more or less important alterations. Joseph Edmondson of Halifax has given it a circular form, which has many advantages.

The accuracy and durability of any machine depend to a great extent on the manner in which the carrying mechanism is constructed. Besides, no wheel must be capable of moving in any other way than that required; hence every part must be locked and be released only when required to move. Further, any disk must carry to the next only after the carrying to itself has been completed. If all were to carry at the same time a considerable force would be required to turn the handle, and serious strains would be introduced. It is for this reason that the B-wheels or cylinders have the greater part of the circumference free from teeth. Again, the carrying acts generally as in the machine described, in one sense only, and this solves that the handle be turned always in the same direction. Subtraction therefore cannot be done by turning it in the opposite way, hence the two wheels C and C' are introduced. These are moved all at once by one lever acting on a bar shown at R in section (fig. 2).

In the Brunsviga, the figure disks are all mounted on a common horizontal axis, the figures being placed on the rim. On the side of each disk and rigidly connected with it lies its A-wheel with which it can turn independent of the others. The B-wheels, all fixed on another horizontal axis, gear directly on the A-wheels. By an ingenious contrivance the teeth are made to appear from out of the rim to any desired number. The carrying mechanism, too, is different, and so arranged that the handle can be turned either way, no special setting being required for subtraction or division. It is extremely handy, taking up much less room than the others. Professor Eduard Selling of Würzburg has invented an altogether different machine, which has been made by Max Ort, of Munich. The B-wheels are replaced by lary-tongs. To the joints of these the ends of racks are pinned; and as they are stretched out the racks are moved forward 0 to 9 steps, according to the joints they are pinned to. The racks gear directly in the A-wheels, and the figures are placed on cylinders as in the Brunsviga. The carrying is done continuously by a train of epicycloidal wheels. The working is thus rendered very smooth, without the jerks which the ordinary carrying tooth produces; but the arrangement has the disadvantage that the resulting figures do not appear in a straight line, a figure followed by a 5, for instance, being already carried half a step forward. This is not a serious matter in the hands of a mathematician or an operator using the machine constantly, but it is serious for casual work. Anyhow, it has prevented the machine from being a commercial success, and it is not any longer made. For ease and rapidity of working it surpasses all others. Since the lary-tong allow of an extension equivalent to five turnings of the handle, if the multiplier is 5 or under, one push forward will do the

same as five (or less) turns of the handle, and more than two pushes are never required.

The Steyer-Egls machine is a multiplication machine, of which fig. 3 gives a picture as it appears to the manipulator. The lower part of the figure contains, under the covering plate, a carriage with two rows of windows for the figures marked *f* and *g*. On pressing down the button *W* the carriage can be moved to right or left. Under each window is a figure disk, as in the Thomas machine. The upper part has three

is performed as in the Thomas. The advantage of this machine is the Thomas in saving time is obvious. Multiplying by 517; 20 in the Thomas 16 turns of the handle, but in the Steyer-Egls 3 turns with 3 settings of the lever H. If the lever H is set to have a simple addition machine like the Thomas or the Brunel. The inventors state that the product of two 8-figure numbers is got in 6-7 seconds, the quotient of a 6-figure number by another in the same time, while the square root of 5 places of a 9-figure number requires 18 seconds.

Machines of far greater powers than the arithmometers mentioned have been invented by Babbage and by Scheuss. A description is impossible without the accompanying drawings. The following account will afford some idea of the working of Babbage's difference machine. It consists of a number of striking clocks placed in a row, each with only an hour hand, and with only the striking apparatus retained. Let the hand of the first clock be turned to 12. As it comes opposite a number on the dial the clock strikes that number of times. Let this clock be connected to the second in such a manner that each stroke of the first the hand of the second is moved from one number to the next, but can only strike when the first comes to rest. If the second hand strikes at 5 and the first strikes 3, then of this is done the second will strike 8. If the second will strike 8, the second will act similarly on the third and so on. Let there be four such clocks with hands set to the numbers 6, 6, 6, 6 respectively. Now set the third clock striking 1, this sets the hand of the fourth clock to 1; strike the second (6), this puts the hand of the fourth to 7 and the fourth to 8. Next strike the first (6); this moves the other hands to 12, 19, 27 respectively, and now repeat the action of the first. The hand of the fourth clock will then give in succession the numbers 1, 8, 27, 64, etc., being the cubes of the series numbers. The numbers thus obtained on the last dial will give the differences given by those shown in succession on the dial before it, their differences by the next, and so on till we come to the constant difference on the first dial. A function

$$y = a + bx + cx^2 + dx^3 + ex^4$$

gives, on increasing *x* always by unity, a set of values for which the fourth difference is constant. We can, by an arrangement like the above, with five clocks calculate *y* for *x*=1, 2, 3, ... to any extent. This is the principle of Babbage's difference machine. The clock dials have to be replaced by a series of dials as in the arithmometers described, and an arrangement has to be made to drive the whole by turning one handle by hand or some other power. Imagine further that with the last clock is connected a kind of typewriter which prints the number, or, better, impresses the number in a soft substance from which a stereotype casting can be taken; and we have a machine which, when once set for a given formula like the above, will automatically print, or prepare stereotype plates for the printing of, tables of figures without any copy or typesetting, thus excluding all possibility of errors. Of this "Difference engine," as Babbage called it, a part was finished in 1834, the government having contributed £7,000 towards the cost. This great expense was chiefly due to the want of proper machine tools.

Meanwhile Babbage had conceived the idea of a much more powerful machine, the "analytical engine," intended to perform any series of possible arithmetical operations. Each of these was to be communicated to the machine by aid of cards with holes punched in them into which levers could drop. It was long time before granted that Babbage left complete plans; the committee of the British Association appointed to consider this question considered, however, to the conclusion (*Brit. Assoc. Report*, 1871, pp. 99-101) that no detailed working drawings existed at all; that the drawings left were only diagrams and not nearly sufficient to put into the hands of a draughtsman for making working plans; and "that the present state of the design is not more than a theoretical possibility." A full account of the work done by Babbage in connection with calculating machines, and some of the work published by others in connection therewith, is contained in a work published by his son, General Babbage.

Slide rules are instruments for performing logarithmic calculations mechanically, and are extensively used, especially where only rough approximations are required. They are almost as old as logarithms themselves. Edmund Gunter drew a "logarithmic line" on his "Scales" as follows (fig. 4):—On an *AB* length are set out to scale to represent the common logarithms of the numbers 1, 2, 3, ... 10 and the points thus obtained are marked with these numbers

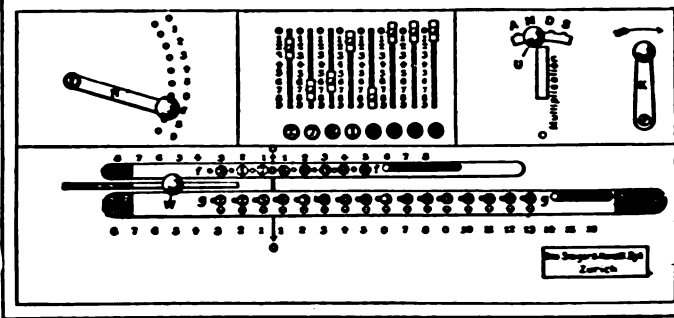

FIG. 3.

sections. The one to the right contains the handle *K* for working the machine, and a button *U* for setting the machine for addition, multiplication, division, or subtraction. In the middle section a number of parallel slots are seen, with indices which can each be set to one of the numbers 0 to 9. Below each slot, and parallel to it, lies a shaft of square section on which a toothed wheel, the *A*-wheel, slides to and fro with the index in the slot. Below these wheels again lie 9 toothed racks at right angles to the slots. By setting the index in any slot the wheel below it comes into gear with one of these racks. On moving the rack, the wheels turn their shafts and the figure disks *g* opposite to them. The dimensions are such that a motion of a rack through 1 cm. turns the figure disk through one "step" or adds 1 to the figure under the window. The racks are moved by an arrangement contained in the section to the left of the slots. There is a vertical plate called the multiplication table block, or more shortly, the *block*. From it project rows of horizontal rods of lengths varying from 0 to 9 centimetres. If one of these rows is brought opposite the row of racks and then pushed forward to the right through 9 cm., each rack will move and add to its figure disk a number of units equal to the number of centimetres of the rod which operates on it. The block has a square face divided into a hundred squares. Looking at its face from the right—i.e. from the side where the racks lie—suppose the horizontal rows of these squares numbered from 0 to 9, beginning at the top, and the columns numbered similarly, the 0 being to the right; then the multiplication table for numbers 0 to 9 can be placed on these squares. The row 7 will therefore contain the numbers 63, 95, ... 7, 0. Instead of these numbers, each square receives two "rods" perpendicular to the plate, which may be called the units-rod and the tens-rod. Instead of the number 63 we have thus a tens-rod 6 cm. and a units-rod 3 cm. long. By aid of a lever *H* the block can be raised or lowered so that any row of the block comes to the level of the racks, the units-rods being opposite the ends of the racks.

The action of the machine will be understood by considering an example. Let it be required to form the product 7 times 385. The indices of three consecutive slots are set to the numbers 3, 8, 5 respectively. Let the windows *g* opposite these slots be called *a*, *b*, *c*. Then to the figures shown at these windows we have to add 21, 56, 35 respectively. This is the same thing as adding first the number 165, formed by the units of each place, and next 2520 corresponding to the tens; or again, as adding first 165, and then moving the carriage one step to the right, and adding 252. The first is done by moving the block with the units-rods opposite the racks forward. The racks are then put out of gear, and together with the block brought back to their normal position; the block is moved sideways to bring the tens-rods opposite the racks, and again moved forward, adding the tens, the carriage having also been moved forward as required. This complicated movement, together with the necessary carrying, is actually performed by one turn of the handle. During the first quarter-turn the block moves forward, the units-rods coming into operation. During the second quarter-turn the carriage is put out of gear, and moved one step to the right while the necessary carrying is performed; at the same time the block and the racks are moved back, and the block is shifted so as to bring the tens-rods opposite the racks. During the next two quarter-turns the process is repeated, the block ultimately returning to its original position. Multiplication by a number with more places

log 1 = 0, the beginning A has the number 1 and B the number 10, hence the unit of length is AB, as $\log 10 = 1$. The same division is repeated from B to C. The distance 1,2 thus represents $\log 2$, 1,3 gives $\log 3$, the distance between 4 and 5 gives $\log 4 - \log 3 = \log \frac{4}{3}$, and so for others. In order to multiply two numbers, say 2 and 3, we have $\log 2 \times 3 = \log 2 + \log 3$. Hence, starting off the distance 1,2 from 3 forward by the aid of a pair

of compasses will give the distance $\log 2 + \log 3$, and will bring us to 6 as the required product. Again, if it is required to find $\frac{1}{7}$, set off the distance between 4 and 5 from 7 backwards, and the required number will be obtained. In the actual scales the spaces between the numbers are subdivided into 10 or even more parts, so that from two to three figures may be read. The numbers 2, 3, . . . in the interval BC give the logarithms of 20 times the same numbers in the interval AB; hence, if the 2 in the latter means 2 or .2, then the 2 in the former means 20 or 200.

Soon after Gunter's publication (1620) of these "logarithmic lines," Edmund Wingate (1672) constructed the slide rule by repeating the logarithmic scale on a tongue or "slide," which could be moved along the first scale, thus avoiding the use of a pair of compasses. A clear idea of this device can be formed if the scale in fig. 4 be copied on the edge of a strip of paper placed against the line A C. If this is now moved to the right till its 1 comes opposite the 2 on the first scale, then the 3 of the second will be opposite 6 on the top scale, this being the product of 2 and 3; and in this position every number on the top scale will be twice that on the lower. For every position of the lower scale the ratio of the numbers on the two scales which coincide will be the same. Therefore multiplications, divisions, and simple proportions can be solved at once.

Dr John Perry added log log scales to the ordinary slide rule in order to facilitate the calculation of a^b or a^{a^b} according to the formula $\log \log a^b = \log \log a + \log b$. These rules are manufactured by A. G. Thornton of Manchester.

Many different forms of slide rules are now on the market. The handiest for general use is the Gravet rule made by Tavernier-Gravet in Paris, according to instructions of the mathematician V. M. A. Mannheim of the Ecole Polytechnique in Paris. It contains at the back of the slide scales for the logarithms of sines and tangents so arranged that they can be worked with the scale on the front. An improved form is now made by Davis and Son of Derby, who engrave the scales on white celluloid instead of on box-wood, thus greatly facilitating the readings. These scales have the distance from one to ten about twice that in fig. 4. Tavernier-Gravet makes them of that size and longer, even $\frac{1}{2}$ metre long. But they then become somewhat unwieldy, though they allow of reading to more figures. To get a handy long scale Professor G. Fuller has constructed a spiral slide rule drawn on a cylinder, which admits of reading to three and four figures. The handiest of all is perhaps the "Calculating Circle" by Boucher, made in the form of a watch. For various purposes special adaptations of the slide rules are met with—for instance, in various exposure meters for photographic purposes. General Strachey introduced slide rules into the Meteorological Office for performing special calculations. At some blast furnaces a slide rule has been used for determining the amount of coke and flux required for any weight of ore. Near the balance a large logarithmic scale is fixed with a slide which has three indices only. A load of ore is put on the scales, and the first index of the slide is put to the number giving the weight, when the second and third point to the weights of coke and flux required.

By placing a number of slides side by side, drawn if need be to different scales of length, more complicated calculations may

be performed. It is then convenient to make the scales circular. A number of rings or disks are mounted side by side on a cylinder, each having on its rim a log-scale. The "Callendar Cable Calculator," invented by Harold Hastings and manufactured by Robert W. Paul, is of this kind. In it a number of disks are mounted on a common shaft, on which each turns freely unless a button is pressed down whereby the disk is clamped to the shaft. Another disk is fixed to the shaft. In front of the disks lies a fixed zero line. Let all disks be set to zero and the shaft be turned, with the first disk clamped, till a desired number appears on the zero line; let then the first disk be released and the second clamped and so on; then the fixed disk will add up all the turnings and thus give the product of the numbers shown on the several disks. If the division on the disks is drawn to different scales, more or less complicated calculations may be rapidly performed. Thus if for some purpose the value of say $a^b \sqrt{c}$ is required for many different values of a, b, c , three movable disks would be needed with divisions drawn to scales of lengths in the proportion 1:3:3. The instrument now on sale contains six movable disks.

Continuous Calculating Machines or Integrators.—In order to measure the length of a curve, such as the road on a map, a wheel is rolled along it. For one revolution of the wheel the path described by its point of contact is equal to the circumference of the wheel. Thus, if a cyclist counts the number of revolutions of his front wheel he can calculate the distance ridden by multiplying that number by the circumference of the wheel. An ordinary cyclometer is nothing but an arrangement for counting these revolutions, but it is graduated in such a manner that it gives at once the distance in miles. On the same principle depend a number of instruments which, under various fancy names, serve to measure the length of any curve; they are in the shape of a small meter chiefly for the use of cyclists. They all have a small wheel which is rolled along the curve to be measured, and this sets a hand in motion which gives the reading on a dial. Their accuracy is not very great, because it is difficult to place the wheel so on the paper that the point of contact lies exactly over a given point; the beginning and end of the readings are therefore badly defined. Besides, it is not easy to guide the wheel along the curve to which it should always lie tangentially. To obviate this defect more complicated curvometers or kartometers have been devised. The handiest seems to be that of G. Coradi. He uses two wheels; the tracing-point, halfway between them, is guided along the curve, the line joining the wheels being kept normal to the curve. This is pretty easily done by eye; a constant deviation of 8° from this direction produces an error of only 1%. The sum of the two readings gives the length. E. Fleischhauer uses three, five or more wheels arranged symmetrically round a tracer whose point is guided along the curve; the planes of the wheels all pass through the tracer, and the wheels can only turn in one direction. The sum of the readings of all the wheels gives approximately the length of the curve, the approximation increasing with the number of the wheels used. It is stated that with three wheels practically useful results can be obtained, although in this case the error, if the instrument is consistently handled so as always to produce the greatest inaccuracy, may be as much as 5%.

Planimeters are instruments for the determination by mechanical means of the area of any figure. A pointer, generally called the "tracer," is guided round the boundary of the figure, and then the area is read off on the recording apparatus of the instrument. The simplest and most useful is Amsler's (fig. 5). It consists of two bars of metal OQ and QT,

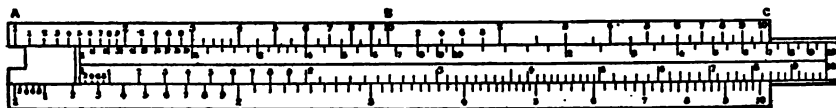

FIG. 4.

Planimeters.

which are hinged together at Q. At O is a needle-point which is driven into the drawing-board, and at T is the tracer. As this is guided round the boundary of the figure a wheel

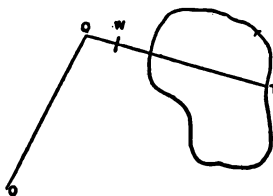

FIG. 5.

Consider the rod QT with the wheel W, without the arm OQ. Let it be placed with the wheel on the paper, and now moved perpendicular to itself from AC to BD (fig. 6). The rod sweeps over, or generates, the area of the rectangle ACDB = lp , where l denotes the length of the rod and p the distance AB through which it has been moved. This distance, as measured by the rolling of the wheel, which acts as a curvimeter, will be called the "roll" of the wheel and be denoted by w . In this case $p = w$, and the area P is given by $P = wl$. Let the circumference of the wheel be divided into say a hundred equal parts s ; then w registers the number of s 's rolled over, and w therefore gives the number of areas ls contained in the rectangle. By suitably selecting the radius of the wheel and the length l , this area ls may be any convenient unit, say a square inch or square centimetre. By changing l the unit will be changed.

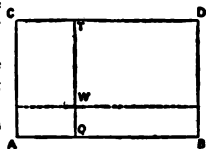

FIG. 6.

Again, suppose the rod to turn (fig. 7) about the end Q, then T will describe an arc of a circle, and the rod will generate an area $\frac{1}{2}l^2\theta$, where θ is the angle AQB through which the rod has turned. The wheel will roll over an arc $c\theta$, where c is the distance of the wheel from Q. The "roll" is now $w = c\theta$; hence the area generated is

$$P = \frac{1}{2} \frac{P}{c} w,$$

and is again determined by w .

FIG. 7.

Next let the rod be moved parallel to itself, but in a direction not perpendicular to itself (fig. 8). The wheel will now not simply roll. Consider a small motion of the rod from QT to Q'T'. This may be resolved into the motion to RR' perpendicular to the rod, whereby the rectangle QTR'R is generated, and the sliding of the rod along itself from RR' to Q'T'. During this second step no area will be generated. During the first step the roll of the wheel will be QR, whilst during the second step there will be no roll at all. The roll of the wheel will therefore measure the area of the rectangle which equals the parallelogram QTT'Q'. If the whole motion of the rod be considered as made up of a very great number of small steps, each resolved as stated, it will be seen that the roll again measures the area generated. But it has to be noticed that now the wheel does not only roll, but also slips, over the paper. This, as will be pointed out later, may introduce an error in the reading.

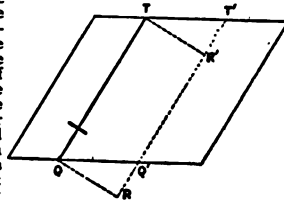

FIG. 8.

We can now investigate the most general motion of the rod. We again resolve the motion into a number of small steps. Let (fig. 9) AB be one position, CD the next after a step so small that the arcs AC and BD over which the ends have passed may be considered as straight lines. The area generated is ABDC. This motion we resolve into a step from AB to CB', parallel to AB and a turning about C from CB' to CD, steps such as have been investigated. During the first, the "roll" will be p the altitude of the parallelogram; during the second will be $c\theta$. Therefore

$$w = p + c\theta.$$

The area generated is $lp + \frac{1}{2}l^2\theta$, or, expressing p in terms of w , $lw + (\frac{1}{2}l^2 - lc)\theta$. For a finite motion we get the area equal to the sum of the areas generated during the different steps. But the wheel will continue rolling, and give the whole roll as the sum of the rolls for the successive steps. Let then w denote the whole roll (in fig. 10), and let a denote the sum of all the small turnings θ ; then the area is

$$P = lw + (\frac{1}{2}l^2 - lc)a. \quad (1)$$

Here a is the angle which the last position of the rod makes with the first. In all applications of the planimeter the rod is brought back to its original position. Then the angle a is either zero, or it is 2π if the rod has been once turned quite round.

Hence in the first case we have

$$P = lw \quad (2a)$$

and w gives the area as in case of a rectangle.

In the other case

$$P = lw + lC \quad (2b)$$

where $C = (\frac{1}{2}l^2 - lc)2\pi$, if the rod has once turned round. The number C will be seen to be always the same, as it depends only on the dimensions of the instrument. Hence now again the area is determined by w if C is known.

Thus it is seen that the area generated by the motion of the rod can be measured by the roll of the wheel; it remains to show how any given area can be generated by the rod. Let the rod move in any manner but return to its original position. Q and T then describe closed curves. Such motion may be called cyclical. Here the theorem holds—If a rod QT performs a cyclical motion, then the area generated equals the difference of the areas enclosed by the paths of T and Q respectively. The truth of this proposition will be seen from a figure. In fig. 11 different positions of the moving rod QT have been marked, and its motion can be easily followed.

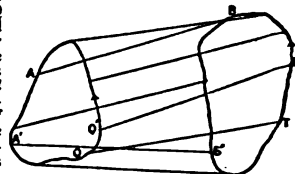

FIG. 11.

It will be seen that every part of the area TT'BB' will be passed over once and always by a forward motion of the rod, whereby the wheel will increase its roll. The area AA'QQ' will also be swept over once, but with a backward roll; it must therefore be counted as negative. The area between the curves is passed over twice, once with a forward and once with a backward roll; it therefore counts once positive and once negative; hence not at all. In more complicated figures it may happen that the area within one of the curves, say TT'BB', is passed over several times, but then it will be passed over once more in the forward direction than in the backward one, and thus the theorem will still hold.

To use Amsler's planimeter, place the pole O on the paper inside the figure to be measured. Then the area generated by QT is that of

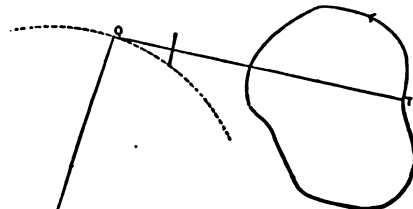

FIG. 12.

the figure, because the point Q moves on an arc of a circle to and fro enclosing no area. At the same time the rod comes back without making a complete rotation. We have therefore in formula (1), $a = 0$, and hence

which is read off. But if the area is too large the pole O may be placed within the area. The rod describes the area between the boundary of the figure and the circle with radius $r = OQ$, whilst the rod turns once completely round, making $a = 2\pi$. The area measured by the wheel is by formula (1), $lw + (\frac{1}{2}l^2 - l^2c)2\pi$. To this the area of the circle πr^2 must be added, so that now

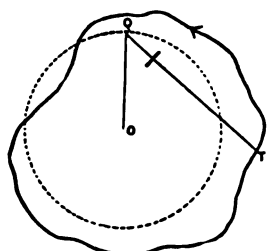

FIG. 13.

$P = lw + (\frac{1}{2}l^2 - l^2c)2\pi + \pi r^2$,
or
 $P = lw + C$,
where $C = (\frac{1}{2}l^2 - l^2c)2\pi + \pi r^2$ is a constant, as it depends on the dimensions of the instrument alone. This constant is given with each instrument.

Amsler's planimeters are made either with a rod QT of fixed length, which gives the area therefore in terms of a fixed unit, say in square inches, or else the rod can be moved in a sleeve to which the arm OQ is hinged (fig. 13). This makes it possible to change the unit lw , which is proportional to l .

In the planimeters described the recording or integrating apparatus is a smooth wheel rolling on the paper or on some other surface. Amsler has described another recorder, viz. a wheel with a sharp edge. This will roll on the paper but not slip. Let the rod QT carry with it an arm CD perpendicular to it. Let there be mounted

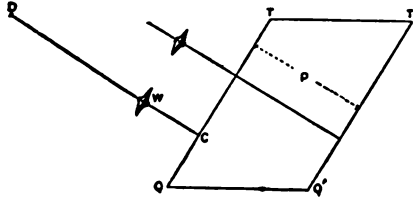

FIG. 14.

on it a wheel W, which can slip along and turn about it. If now QT is moved parallel to itself to QT', then W will roll without slipping parallel to QT, and slip along CD. This amount of slipping will equal the perpendicular distance between QT and QT', and therefore serve to measure the area swept over like the wheel in the machine already described. The turning of the rod will also produce slipping of the wheel, but it will be seen without difficulty that this will cancel during a cyclical motion of the rod, provided the rod does not perform a whole rotation.

The first planimeter was made on the following principles:—A frame FF (fig. 15) can move parallel to OX.

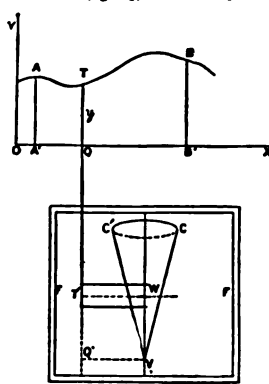

FIG. 15.

on to an amount again proportional to y , its distance from V. Hence the roll of the rod QT. As T is moved from A to B along the curve the roll of the wheel will therefore be proportional to the area AA'B'B. If the curve is closed, and the tracer moved round

it, the roll will measure the area independent of the position of the axis OX, as will be seen by drawing a figure. The cone may with advantage be replaced by a horizontal disk, with its centre at V; this allows of y being negative. It may be noticed at once that the roll of the wheel gives at every moment the area AATQ. It will therefore allow of registering a set of values of $\int y dx$ for any values of x , and thus of tabulating the values of any indefinite integral. In this it differs from Amsler's planimeter. Planimeters of this type were first invented in 1814 by the Bavarian engineer Hermann, who, however, published nothing. They were reinvented by Prof. Tito Gonnella of Florence in 1824, and by the Swiss engineer Oppikofer, and improved by Ernst in Paris, the astronomer Hansen in Gotha, and others (see Henrici, *British Association Report*, 1894). But all were driven out of the field by Amsler's simpler planimeter.

Altogether different from the planimeters described is the hatchet planimeter, invented by Captain Prytz, a Dane, and made by Herr Cornelius Knudson in Copenhagen. It consists of a single rigid piece like fig. 16. The one end T is the tracer, the other Q has a sharp hatchet-like edge. If this is placed with QT on the paper and T is moved along any curve, Q will follow, describing a "curve of pursuit."

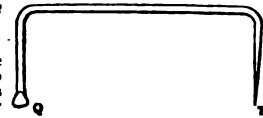

FIG. 16.

In consequence of the sharp edge, Q can only move in the direction of QT, but the whole can turn about Q. Any small step forward can therefore be considered as made up of a motion along QT, together with a turning about Q. The latter motion alone generates an area. If therefore a line OA = QT is turning about a fixed point O, always keeping parallel to QT, it will sweep over an area equal to that generated by the more general motion of QT. Let now (fig. 17) QT be placed on OA, and T be guided round the closed curve in the sense of the arrow. Q will describe a curve OSB. It may be made visible by putting a piece of "copying paper" under the hatchet. When T has returned to A the hatchet has the position BA. A line turning from OA about O kept parallel to QT will describe the circular sector OAC, which is equal in magnitude and sense to AOB. This therefore measures the area generated by the motion of QT. To make this motion cyclical, suppose the hatchet turned about A till Q comes from B to O. Hereby the sector AOB is again described, and again in the positive sense, if it is remembered that it turns about the tracer T fixed at A. The whole area now generated is therefore twice the area of this sector, or equal to OA.OB, where OB is measured along the arc. According to the theorem given above, this area also equals the area of the given curve less the area OSBO. To make this area disappear, a slight modification of the motion of QT is required. Let the tracer T be moved, both from the first position OA and the last BA of the rod, along some straight line AX. Q describes curves OF and BH respectively. Now begin the motion with T at some point K on AX, and move it along this line to A, round the curve and back to R. Q will describe the curve DOSBED, if the motion is again made cyclical by turning QT with T fixed at A. If R is properly selected, the path of Q will cut itself, and parts of the area will be positive, parts negative, as marked in the figure, and may therefore be made to vanish. When this is done the area of the curve will equal twice the area of the sector RDE. It is therefore equal to the arc DE multiplied by the length QT; if the latter equals to in., then 10 times the number of inches contained in the arc DE gives the number of square inches contained within the figure. If the area is not too large, the arc DE may be replaced by the straight line DE.

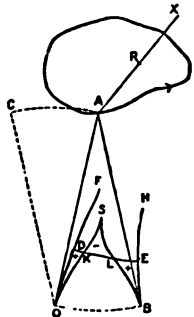

FIG. 17.

To use this simple instrument as a planimeter requires the possibility of selecting the point R. The geometrical theory here given has so far failed to give any rule. In fact, every line through any point in the curve contains such a point. The analytical theory of the inventor, which is very similar to that given by F. W. Hill (*Phil. Mag.* 1894), is too complicated to repeat here. The integrals expressing the area generated by QT have to be expanded in a series. By retaining only the most important terms a result is obtained which comes to this, that if the mass-centre of the area be taken as origin then A may be any point on the curve. This is only approximate. Captain Prytz gives the following instructions:—Take a point R as near as you can guess to the mass-centre, put the tracer T on it, the knife-edge Q outside; make a mark on the paper by pressing the knife-edge into it; guide the tracer from R along a straight line to a point A on the boundary, round the boundary,

and back from A to R; lastly, make again a mark with the knife-edge, and measure the distance l between the marks; then the area is nearly l , where $l=QT$. A nearer approximation is obtained by repeating the operation after turning QT through 180° from the original position, and using the mean of the two values of l thus obtained. The greatest dimension of the area should not exceed $1/2$, otherwise the area must be divided into parts which are determined separately. This condition being fulfilled, the instrument gives very satisfactory results, especially if the figures to be measured, as in the case of indicator diagrams, are much of the same shape, for in this case the operator soon learns where to put the point R.

Integrators serve to evaluate a definite integral $\int_a^b f(x)dx$. If we plot out the curve whose equation is $y=f(x)$, the integral $\int y dx$ between the proper limits represents the area of a figure bounded by the curve, the axis of x , and the ordinates at $x=a$, $x=b$. Hence if the curve is drawn, any planimeter may be used for finding the value of the integral. In this sense planimeters are integrators. In fact, a planimeter may often be used with advantage to solve problems more complicated than the determination of a mere area, by converting the one problem graphically into the other. We give an example:—

Let the problem be to determine for the figure ABC (fig. 18), not only the area, but also the first and second moment with regard to the axis XX . At a distance a draw a line, $C'D'$, parallel to XX . In the figure draw a number of lines parallel to AB . Let CD be one of them. Draw C and D vertically upwards to $C'D'$, join these points to some point O in XX , and mark the points C_1D_1 , where OC' and OD' cut CD . Do this for a sufficient number of lines, and join the points C_1D_1 , thus obtained. This gives a new curve, which may be called the first derived curve. By the same process get a new curve from this, the second derived curve. By aid of a planimeter determine the areas P, P_1, P_2 of these three curves. Then, if \bar{x} is the distance of the mass-centre of the given area from XX ; \bar{x}_1 the same quantity for the first derived figure, and $I=AK^2$ the moment of inertia of the first figure, k its radius of gyration, with regard to XX as axis, the following relations are easily proved:—

$P\bar{x} = aP_1$; $P_1\bar{x}_1 = aP_2$; $I = a^2P_1\bar{x}_1$; $k^2 = \bar{x}\bar{x}_1$, which determine P, \bar{x} and I or k . Amster has constructed an integrator which serves to determine these quantities by guiding a

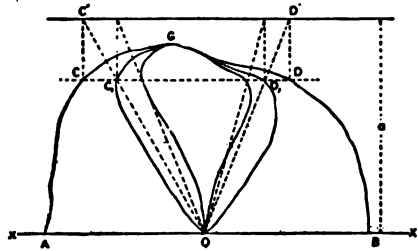

FIG. 19.

carriage which runs on a straight rail (fig. 19). This carries a horizontal disk A, movable about a vertical axis Q. Slightly more than half the circumference is circular with radius $2a$, the other part with

radius $3a$. Against these gear two disks, B and C, with radii c ; their axes are fixed in the carriage. From the disk A extends to the left a rod OT of length l , on which a recording wheel W is mounted. The disks B and C have also recording wheels, W_1 and W_2 , the axis of W_1 being perpendicular, that of W_2 parallel to OT . If now T is guided round a figure F , O will move to and fro in a straight line. This part is therefore a simple planimeter, in which the one end of the arm moves in a straight line instead of in a circular arc. Consequently, the "roll" of W will record the area of the figure. Imagine now that the disks B and C also receive arms of length l from the centres of the disks to points T_1

Amster's Integrator.

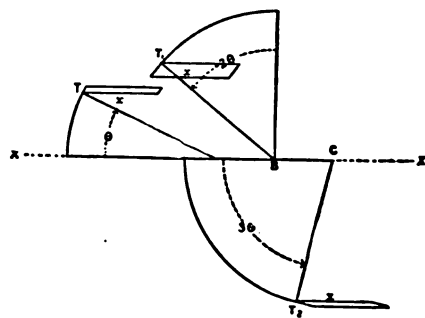

FIG. 20.

tracer once round the boundary of the given figure (see below). Again, it may be required to find the value of an integral $\int y\phi(x)dx$ between given limits where $\phi(x)$ is a simple function like $\sin nx$, and where y is given as the ordinate of a curve. The harmonic analysers described below are examples of instruments for evaluating such integrals.

Amster has modified his planimeter in such a manner that instead of the area it gives the first or second moment of a figure about an axis in its plane. An instrument giving all three quantities simultaneously is known as Amster's integrator or moment-planimeter. It has one tracer, but three recording wheels. It is mounted on a

and T_2 , and in the direction of the axes of the wheels. Then these arms with their wheels will again be planimeters. As T is guided round the given figure F , these points T_1 and T_2 will describe closed curves, F_1 and F_2 , and the "rolls" of W_1 and W_2 will give their areas A_1 and A_2 . Let XX (fig. 20) denote the line, parallel to the rail, on which O moves; then when T lies on this line, the arm BT_1 is perpendicular to XX , and CT_2 parallel to it. If OT is turned through an angle θ , clockwise, BT_1 will turn counter-clockwise through an angle 2θ , and CT_2 through an angle 3θ , also counter-clockwise. If in this position T is moved through a distance x parallel to the axis XX , the points T_1 and T_2 will move parallel to it through an equal distance. If now the first arm is turned through a small angle $d\theta$, moved back through a distance x , and lastly turned back through the angle $d\theta$, the tracer T will have described the boundary of a small strip of area. We divide the given figure into

such strips. Then to every such strip will correspond a strip of equal length x of the figures described by T_1 and T_2 .

The distances of the points, T_1, T_2 , from the axis XX may be called y, y_1, y_2 . They have the values

$$y = l \sin \theta, y_1 = l \cos \theta, y_2 = -l \sin \theta,$$

from which

$$dy = l \cos \theta \cdot d\theta, dy_1 = -l \sin \theta \cdot d\theta, dy_2 = -l \cos \theta \cdot d\theta.$$

The areas of the three strips are respectively $dA = xdy, dA_1 = xdy_1, dA_2 = xdy_2$.

Now dy_1 can be written $dy_1 = -dy \sin \theta \cos \theta = -dy \sin 2\theta$; therefore

$$dA_1 = -4 \sin \theta dA = -4 dy_1 dA;$$

whence

$$A_1 = -4 \int y dA = -4 \bar{y} A,$$

where A is the area of the given figure, and \bar{y} the distance of its mass-centre from the axis XX . But A_1 is the area of the second figure F_1 , which is proportional to the reading of W_1 . Hence we may say

$$A_1 \bar{y} = C_1 w_1,$$

where C_1 is a constant depending on the dimensions of the instrument. The negative sign in the expression for A_1 is got rid of by numbering the wheel W_1 the other way round.

Again

$$dy_2 = -3l \cos \theta \{4 \cos^2 \theta - 3\} d\theta = -3 \{4 \cos^2 \theta - 3\} dy,$$

which gives

$$dA_2 = -\frac{12}{7} y^2 dA + 9dA,$$

and

$$A_2 = -\frac{12}{7} \int y^2 dA + 9A.$$

But the integral gives the moment of inertia I of the area A about the axis XX . As A_2 is proportional to the roll of w_2 , A to that of W , we can write

$$\begin{aligned} I &= Cw - C_2 w_2, \\ A\bar{y} &= C_1 w_1, \\ A &= C_3 w. \end{aligned}$$

If a line be drawn parallel to the axis XX at the distance y , it will pass through the mass-centre of the given figure. If this represents the section of a beam subject to bending, this line gives for a proper choice of XX the neutral fibre. The moment of inertia for it will be $I + Ay^2$. Thus the instrument gives at once all those quantities which are required for calculating the strength of the beam under bending. One chief use of this integrator is for the calculation of the displacement and stability of a ship from the drawings of a number of sections. It will be noticed that the length of the figure in the direction of XX is only limited by the length of the rail.

This integrator is also made in a simplified form without the wheel W_2 . It then gives the area and first moment of any figure.

While an integrator determines the value of a definite integral, hence a mere constant, an integraph gives the value of an indefinite integral, which is a function of x . Analytically if y is a given function $f(x)$ of x and

$$Y = \int y dx \text{ or } Y = \int y dx + \text{const.}$$

the function Y has to be determined from the condition

$$\frac{dY}{dx} = y.$$

Graphically $y=f(x)$ is either given by a curve, or the graph of the equation is drawn: y , therefore, and similarly Y ,

is a length. But $\frac{dY}{dx}$ is in this case a mere number, and cannot equal a length y . Hence we introduce an arbitrary constant length a , the unit to which the integraph draws the curve, and write

$$\frac{dY}{dx} = \frac{y}{a} \text{ and } aY = \int y dx.$$

Now for the Y -curve $\frac{dY}{dx} = \tan \phi$, where ϕ is the angle between the

tangent to the curve, and the axis of x : Our condition therefore becomes,

$$\tan \phi = \frac{y}{a}.$$

This ϕ is easily constructed for any given point on the y -curve:—From the foot B' (fig. 21) of the ordinate $y=B'B$ set off, as in the figure, $B'D=a$, then angle $BDB'=\phi$. Let now DB' with a perpendicular $B'B$ move along the axis of x , whilst B follows the y -curve, then a pen P on $B'B$ will describe the Y -curve provided it moves at every moment in a direction parallel to BD . The object of the integraph is to draw this new curve when the tracer of the instrument is guided along the y -curve.

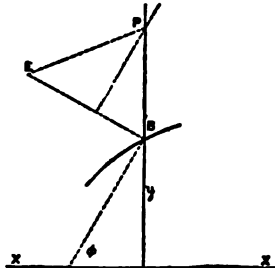

FIG. 21.

The first to describe such instruments was Abdank-Abakanowicz, who in 1889 published a book in which a variety of mechanisms to obtain the object in question are described. Some years later G. Coradi, in Zürich, carried out his ideas. Before this was done, C. V. Boys, without knowing of Abdank-Abakanowicz's work, actually made an integraph which was exhibited at the Physical Society in 1881. Both make use of a sharp edge wheel. Such a wheel will not slip sideways; it will roll forwards along the line in which its plane intersects the plane of the paper, and while rolling will be able to turn gradually about its point of contact. If then the angle between its direction of rolling and the x -axis be always equal to ϕ , the wheel will roll along the Y -curve required. The axis of x is fixed only in direction; shifting it parallel to itself adds a constant to Y , and this gives the arbitrary constant of integration.

In fact, if Y shall vanish for $x=c$, or if

$$Y = \int_c^x y dx,$$

then the axis of x has to be drawn through that point on the y -curve which corresponds to $x=c$.

In Coradi's integraph a rectangular frame $F_1F_2F_3F_4$ (fig. 22)

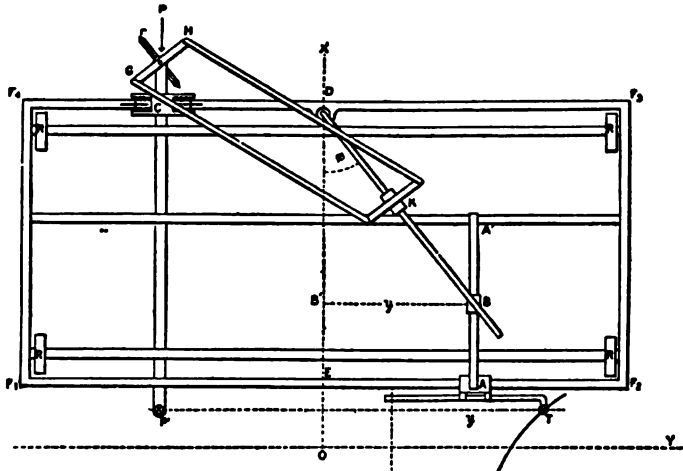

FIG. 22.

rests with four rollers R on the drawing board, and can roll freely in the direction OX , which will be called the axis of the instrument. On the front edge F_1F_2 travels a carriage AA' supported at A' on another rail. A bar DB can turn about D , fixed to the frame in its axis, and slide through a point B fixed in the carriage AA' . Along it a block K can slide. On the back edge F_3F_4 of the frame another carriage C travels. It holds a vertical spindle with the knife-edge wheel at the bottom. At right angles to the plane of the wheel, the spindle has an arm GH , which is kept parallel to a

similar arm attached to K perpendicular to DB. The plane of the knife-edge wheel π is therefore always parallel to DB. If now the point B is made to follow a curve whose y is measured from OX, we have in the triangle BDB', with the angle ϕ at D,

$$\tan \phi = y/a,$$

where $a = DB'$ is the constant base to which the instrument works. The point of contact of the wheel π or any point of the carriage C will therefore always move in a direction making an angle ϕ with the axis of x , whilst it moves in the x -direction through the same distance as the point B on the y -curve—that is to say, it will trace out the integral curve required, and so will any point rigidly connected with the carriage C. A pen P attached to this carriage will therefore draw the integral curve. Instead of moving B along the y -curve, a tracer T fixed to the carriage A is guided along it. For using the instrument the carriage is placed on the drawing-board with the front edge parallel to the axis of y , the carriage A being clamped in the central position with A at E and B at B' on the axis of x . The tracer is then placed on the x -axis of the y -curve and clamped to the carriage, and the instrument is ready for use. As it is convenient to have the integral curve placed directly opposite to the y -curve so that corresponding values of y or Y are drawn on the same line, a pen P' is fixed to C in a line with the tracer.

Boys' integrator was invented during a sleepless night, and during the following days carried out as a working model, which gives highly satisfactory results. It is ingenious in its simplicity, and a direct realization as a mechanism of the principles explained in connexion with fig. 21. The line B'B is represented by the edge of an ordinary T-square sliding against the edge of a drawing-board. The points B and P are connected by two rods BE and EP, jointed at E. At B, E and P are small pulleys of equal diameters. Over these an endless string runs, ensuring that the pulleys at B and P always turn through equal angles. The pulley at B is fixed to a rod

which passes through the point D, which itself is fixed in the T-square. The pulley at P carries the knife-edge wheel. If then B and P are kept on the edge of the T-square, and B is guided along the curve, the wheel at P will roll along the Y-curve, it having been originally set parallel to BD. To give the wheel at P sufficient grip on the paper, a small loaded three-wheeled carriage, the knife-edge wheel P being one of its wheels, is added. If a piece of copying paper is inserted between the wheel P and the drawing paper the Y-curve is drawn very sharply.

Integrators have also been constructed, by aid of which ordinary differential equations, especially linear ones, can be solved, the solution being given as a curve. The first suggestion in this direction was made by Lord Kelvin. So far no really useful instrument has been made, although the ideas seem sufficiently developed to enable a skilful instrument-maker to produce one should there be sufficient demand for it. Sometimes a combination of graphical work with an integrator will serve the purpose. This is the case if the variables are separated, hence if the equation

$$Xdx + Ydy = 0$$

has to be integrated where $X = \rho(x)$, $Y = \phi(y)$ are given as curves. If we write

$$au = \int Xdx, \quad av = \int Ydy,$$

then u as a function of x , and v as a function of y can be graphically found by the integrator. The general solution is then

$$u + v = c$$

with the condition, for the determination for c , that $y = y_0$ for $x = x_0$. This determines $c = u_0 + v_0$, where u_0 and v_0 are known from the graphs of u and v . From this the solution as a curve giving y a function of x can be drawn.—For any x take u from its graph, and find the y for which $v = c - u$, plotting these y against their x gives the curve required.

If a periodic function y of x is given by its graph for one period c , it can, according to the theory of Fourier's Series, be expanded in a series.

Harmonic analysis.

$$y = A_0 + A_1 \cos \theta + A_2 \cos 2\theta + \dots + A_n \cos n\theta + \dots + B_1 \sin \theta + B_2 \sin 2\theta + \dots + B_n \sin n\theta + \dots$$

where $\theta = \frac{2\pi x}{c}$.

The absolute term A_0 equals the mean ordinate of the curve, and can therefore be determined by any planimeter. The other coefficients are

$$A_n = \frac{1}{\pi} \int_0^\pi y \cos n\theta d\theta; \quad B_n = \frac{1}{\pi} \int_0^\pi y \sin n\theta d\theta.$$

A harmonic analyser is an instrument which determines these integrals, and is therefore an integrator. The first instrument of this kind is due to Lord Kelvin (*Proc. Roy. Soc.*, vol. xxiv., 1876). Since then several others have been invented (see Dyck's *Catalogue*; Henrici, *Phil. Mag.*, July 1894; *Phys. Soc.*, 9th March; Sharp, *Phil. Mag.*, July 1894; *Phys. Soc.*, 13th April). In Lord Kelvin's instrument the curve to be analysed is drawn on a cylinder whose circumference equals the period c , and the sine and cosine terms of the integral are introduced by aid of simple harmonic motion. Sommerfeld and Wiechert, of Königsberg, avoid this motion by turning the cylinder about an axis perpendicular to that of the cylinder. Both these machines are large, and practically fixtures in the room where they are used. The first has done good work in the Meteorological Office in London in the analysis of meteorological curves. Quite different and simpler constructions can be used, if the integrals determining A_n and B_n be integrated by parts. This gives

$$\pi A_n = -\frac{1}{n} \int_0^\pi \sin n\theta dy; \quad \pi B_n = \frac{1}{n} \int_0^\pi \cos n\theta dy.$$

An analyser presently to be described, based on these forms, has been constructed by Coradi in Zürich (1894). Lastly, a most powerful analyser has been invented by Michelson and Stratton (U.S.A.) (*Phil. Mag.*, 1898), which will also be described.

The Henrici-Coradi analyser has to add up the values of $dy \cdot \sin n\theta$ and $dy \cdot \cos n\theta$. But these are the components of dy in two directions perpendicular to each other, of which one makes an angle $n\theta$ with the axis of x or of θ . This decomposition can be performed by Amshler's registering wheels. Let two of these be mounted, perpendicular to each other, in one horizontal frame which can be

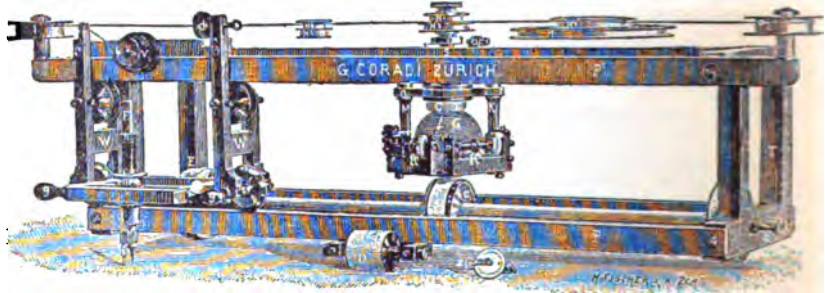

FIG. 23.

turned about a vertical axis, the wheels resting on the paper on which the curve is drawn. When the tracer is placed on the curve at the point $\theta = 0$ the one axis is parallel to the axis of θ . As the tracer follows the curve the frame is made to turn through an angle $n\theta$. At the same time the frame moves with the tracer in the direction of y . For a small motion the two wheels will then register just the components required, and during the continued motion of the tracer along the curve the wheels will add these components, and thus give the values of nA_n and nB_n . The factors $1/n$ and $-1/n$ are taken account of in the graduation of the wheels. The readings have then to be divided by n to give the coefficients required. Coradi's realization of this idea will be understood from fig. 23. The frame PP' of the instrument rests on three rollers E, E', and D. The first two drive an axis with a disk C on it. It is placed parallel to the axis of x of the curve. The tracer is attached to a carriage WW which runs on the rail P. As it follows the curve this carriage moves through a distance x whilst the whole instrument runs forward through a distance y . The wheel C turns through an angle proportional, during each small motion, to dy . On it rests a glass sphere which will therefore also turn about its horizontal axis proportionally, to dy . The registering frame is suspended by aid of a spindle S, having a disk H. It is turned by aid of a wire connected with the carriage WW, and turns n times round as the tracer describes the whole length of the curve. The registering wheels R, R' rest against the glass sphere and give the values nA_n and nB_n . The value of n can be altered by changing the disk H into one of different diameter. It is also possible to mount on the same frame a number of spindles with registering wheels and glass spheres, each of the latter resting on a separate disk C. As many as five have been introduced. One guiding of the tracer over the curve gives then at once the ten coefficients A_n and B_n for $n = 1$ to 5.

All the calculating machines and integrators considered so far have been kinematic. We have now to describe a most remarkable instrument based on the equilibrium of a rigid body under the action of springs. The body itself for rigidity's sake is made a hollow

cylinder H, shown in fig. 24 in end view. It can turn about its axis, being supported on knife-edges O. To it springs are attached at the prolongation of a horizontal diameter; to the left a series of n small springs s , all alike, side by side at equal intervals at a distance a from the axis of the knife-edges; to the right a single spring S at distance b . These springs are supposed to follow Hooke's law. If the elongation beyond the natural length of a spring is λ , the force asserted by it is $p = k\lambda$. Let for the position of equilibrium l, L be respectively the elongation of a small and the large spring, k, K their constants, then

$$nkl\lambda = KLb.$$

The position now obtained will be called the *normal* one. Now let the top ends C of the small springs be raised through distances y_1, y_2, \dots, y_n . Then the body H will turn; B will move down through a distance s and A up through a distance $\frac{a}{b}s$. The new forces thus introduced will be in equilibrium if

$$ak \left(zy - n \frac{a}{b} s \right) = bKx.$$

Or

$$s = \frac{zy}{\frac{a}{b} + \frac{b}{a} \frac{K}{k}} = \frac{zy}{n \left(\frac{a}{b} + \frac{b}{a} \right)}.$$

This shows that the displacement s of B is proportional to the sum of the displacements y of the tops of the small springs. The arrangement can therefore be used for the addition of a number of displacements. The instrument made has eighty small springs, and the authors state that from the experience gained there is no impossibility of increasing their number even to a thousand. The displacement s , which necessarily must be small, can be enlarged by aid of a lever OT'. To regulate the displacements y of the points C (fig. 24) each spring is attached to a lever EC, fulcrum E. To this again a long rod FG is fixed by aid of a joint at F. The lower end of this rod rests on another lever GP, fulcrum N, at a changeable distance $y'' = NG$ from N. The elongation y of any spring s can thus be produced by a motion of P. If P be raised through a distance y' , then the displacement y of C will be proportional to $y'y''$; it is, say, equal to $\mu y'y''$ where μ is the same for all springs. Now

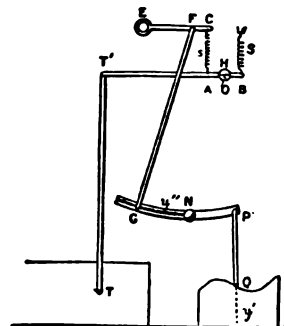

FIG. 24.

let the points G, and with it the springs s , the levers, &c., be numbered C_0, C_1, C_2, \dots . There will be a zero-position for the points P all in a straight horizontal line. When in this position the points C will also be in a line, and this we take as axis of x . On it the points C_0, C_1, C_2, \dots follow at equal distances, say each equal to h . The point C_0 lies at the distance hk which gives the x of this point. Suppose now that the rods FG are all set at unit distance NG from N, and that the points P be raised so as to form points in a continuous curve $y' = \phi(x)$, then the points C will lie in a curve $y = \mu\phi(x)$. The area of this curve is

$$\mu \int \phi(x) dx.$$

Approximately this equals $\Sigma hy = h\Sigma y$. Hence we have

$$\int \phi(x) dx = \frac{h}{\mu} \Sigma y = \frac{h}{\mu} s,$$

where s is the displacement of the point B which can be measured. The curve $y' = \phi(x)$ may be supposed cut out as a templet. By putting this under the points P the area of the curve is thus determined—the instrument is a simple integrator.

The integral can be made more general by varying the distances $NG = y''$. These can be set to form another curve $y'' = f(x)$. We have now $y = \mu y' y'' = \mu f(x) \phi(x)$, and get as before

$$\int f(x) \phi(x) dx = \frac{h}{\mu} \Sigma y.$$

These integrals are obtained by the addition of ordinates, and therefore by an approximate method. But the ordinates are numerous, there being 79 of them, and the results are in consequence very accurate. The displacement s of B is small, but it can be magnified by taking the reading of a point T' on the lever AB. The actual reading is done at point T connected with T' by a long vertical rod. At T either a scale can be placed or a drawing-board, on which a pen at T marks the displacement.

If the points G are set so that the distances NG on the different levers are proportional to the terms of a numerical series

$$n_0 + n_1 + n_2 + \dots$$

and if all P be moved through the same distance, then s will be proportional to the sum of this series up to 80 terms. We get an *Addition Machine*.

The use of the machine can, however, be still further extended. Let a templet with a curve $y' = \phi(x)$ be set under each point P at right angles to the axis of x hence parallel to the plane of the figure. Let these templets form sections of a continuous surface, then each section parallel to the axis of x will form a curve like the old $y' = \phi(x)$, but with a variable parameter ξ , or $y' = \phi(\xi, x)$. For each value of ξ the displacement of T will give the integral

$$Y = \int f(x) \phi(\xi, x) dx = F(\xi), \dots (1)$$

where Y equals the displacement of T to some scale dependent on the constants of the instrument.

If the whole block of templets be now pushed under the points P and if the drawing-board be moved at the same rate, then the pen T will draw the curve $Y = F(\xi)$. The instrument now is an *integral* giving the value of a definite integral as function of a *variable parameter*.

Having thus shown how the lever with its springs can be made to serve a variety of purposes, we return to the description of the actual instrument constructed. The machine serves first of all to set up a series of harmonic motions or to draw the curve

$$Y = a_1 \cos x + a_2 \cos 2x + a_3 \cos 3x + \dots (2)$$

The motion of the points P_1, P_2, \dots is here made harmonic by aid of a series of excentric disks arranged so that for one revolution of the first the other disks complete 2, 3, ... revolutions. They are all driven by one handle. These disks take the place of the templets described before. The distances NG are made equal to the amplitudes a_1, a_2, a_3, \dots . The drawing-board, moved forward by the turning of the handle, now receives a curve of which (2) is the equation. If all excentrics are turned through a right angle a sine-series can be added up.

It is a remarkable fact that the same machine can be used as a harmonic analyser of a given curve. Let the curve to be analysed be set off along the levers NG so that in the old notation it is

$$y' = f(x),$$

whilst the curves $y' = \phi(x)$ are replaced by the excentrics, hence ξ being the angle θ through which the first excentric is turned, so that $y'' = \cos h\theta$. But $hk = x$ and $nh = \pi$, n being the number of springs s , and π taking the place of c . This makes

$$h\theta = \frac{\pi}{n} \theta x.$$

Hence our instrument draws a curve which gives the integral (1) in the form

$$y = \frac{2}{\pi} \int_0^{\pi} f(x) \cos \left(\frac{\pi}{n} \theta x \right) dx$$

as a function of θ . But this integral becomes the coefficient a_n in the cosine expansion if we make

$$\theta n/x = m \text{ or } \theta = m\pi/x.$$

The ordinates of the curve at the values $\theta = \pi/n, 2\pi/n, \dots$ give therefore all coefficients up to $m = 80$. The curve shows at a glance which and how many of the coefficients are of importance.

The instrument is described in *Phil. Mag.*, vol. xlv., 1808. A number of curves drawn by it are given, and also examples of the analysis of curves for which the coefficients a_n are known. These indicate that a remarkable accuracy is obtained. (O. H.)

CALCUTTA, the capital of British India and also of the province of Bengal. It is situated in $22^\circ 34' N.$ and $88^\circ 24' E.$, on the left or east bank of the Hugli, about 80 m. from the sea. Including its suburbs it covers an area of 27,267 acres, and contains a population (1901) of 949,144. Calcutta and Bombay have long contested the position of the premier city of India in population and trade; but during the decade 1801-1901 the prevalence of plague in Bombay gave a considerable advantage to Calcutta, which was comparatively free from that disease. Calcutta lies only some 20 ft. above sea-level, and extends about 6 m. along the Hugli, and is bounded elsewhere by the Circular Canal and the Salt Lakes, and by suburbs which form separate municipalities. Fort William stands in its centre.

Public Buildings.—Though Calcutta was called by Macaulay "the city of palaces," its modern public buildings cannot compare with those of Bombay. Its chief glory is the Maidan or park, which is large enough to embrace the area of Fort William and a racecourse. Many monuments find a place on the Maidan, among them being modern equestrian statues of Lord Roberts and Lord Lansdowne, which face one another on each side of the Red Road, where the rank and

fashion of Calcutta take their evening drive. In the north-eastern corner of the Maidan the Indian memorial to Queen Victoria, consisting of a marble hall, with a statue and historical relics, was opened by the prince of Wales in January 1906. The government acquired Metcalfe Hall, in order to convert it into a public library and reading-room worthy of the capital of India; and also the country-house of Warren Hastings at Alipur, for the entertainment of Indian princes. Lord Curzon restored, at his own cost, the monument which formerly commemorated the massacre of the Black Hole, and a tablet let into the wall of the general post office indicates the position of the Black Hole in the north-east bastion of Fort William, now occupied by the roadway. Government House, which is situated near the Maidan and Eden Gardens, is the residence of the viceroy; it was built by Lord Wellesley in 1799, and is a fine pile situated in grounds covering six acres, and modelled upon Kedleston Hall in Derbyshire, one of the Adam buildings. Belvedere House, the official residence of the lieutenant-governor of Bengal, is situated close to the botanical gardens in Alipur, the southern suburb of Calcutta. Facing the Maidan for a couple of miles is the Chowringhee, one of the famous streets of the world, once a row of palatial residences, but now given up almost entirely to hotels, clubs and shops.

Commerce.—Calcutta owes its commercial prosperity to the fact that it is situated near the mouth of the two great river systems of the Ganges and Brahmaputra. It thus receives the produce of these fertile river valleys, while the rivers afford a cheaper mode of conveyance than any railway. In addition Calcutta is situated midway between Europe and the Far East and thus forms a meeting-place for the commerce and peoples of the Eastern and Western worlds. The port of Calcutta is one of the busiest in the world, and the banks of the Hugli rival the port of London in their show of shipping. The total number of arrivals and departures during 1904-1905 was 3027 vessels with an average tonnage of 3734. But though the city is such a busy commercial centre, most of its industries are carried on outside municipal limits. Howrah, on the opposite side of the Hugli, is the terminus of three great railway systems, and also the headquarters of the jute industry and other large factories. It is connected with Calcutta by an immense floating bridge, 1530 ft. in length, which was constructed in 1874. Other railways have their terminus at Sealdah, an eastern suburb. The docks lie outside Calcutta, at Kidderpur, on the south; and at Alipur are the zoological gardens, the residence of the lieutenant-governor of Bengal, cantonments for a native infantry regiment, the central gaol and a government reformatory. The port of Calcutta stretches about 10 m. along the river. It is under the control of a port trust, whose jurisdiction extends to the mouth of the Hugli and also over the floating bridge. New docks were opened in 1892, which cost upwards of two millions sterling. The figures for the sea-borne trade of Calcutta are included in those of Bengal. Its inland trade is carried on by country boat, inland steamer, rail and road, and amounted in 1904-1905 to about four and three-quarter millions sterling. More than half the total is carried by the East Indian railway, which serves the United Provinces. Country boats hold their own against inland steamers, especially in imports.

Municipality.—The municipal government of Calcutta was reconstituted by an act of the Bengal legislature, passed in 1899. Previously, the governing body consisted of seventy-five commissioners, of whom fifty were elected. Under the new system modelled upon that of the Bombay municipality, this body, styled the corporation, remains comparatively unaltered; but a large portion of their powers is transferred to a general committee, composed of twelve members, of whom one-third are elected by the corporation, one-third by certain public bodies and one-third are nominated by the government. At the same time, the authority of the chairman, as supreme executive officer, is considerably strengthened. The two most important works undertaken by the old municipality were the provision of a supply of filtered water and the construction of a main drainage system. The water-supply is derived from the river

Hugli, about 16 m. above Calcutta, where there are large pumping-stations and settling-tanks. The drainage-system consists of underground sewers, which are discharged by a pumping-station into a natural depression to the eastward, called the Salt Lake. Refuse is also removed to the Salt Lake by means of a municipal railway.

Education.—The Calcutta University was constituted in 1857, as an examining body, on the model of the university of London. The chief educational institutions are the Government Presidency College; three aided missionary colleges, and four unaided native colleges; the Sanskrit College and the Mahomedan Madrasah; the government medical college, the government engineering college at Sibpur, on the opposite bank of the Hugli, the government school of art, high schools for boys, the Bethune College and high schools for girls.

Population.—The population of Calcutta in 1710 was estimated at 12,000, from which figure it rose to about 117,000 in 1752. In the census of 1831 it was 187,000, in 1839 it had become 229,000 and in 1901, 949,144. Thus in the century between 1801 and 1901 it increased sixfold, while during the same period London only increased fivefold. Out of the total population of town and suburbs in 1901, 615,000 were Hindus, 286,000 Mahomedans and 38,000 Christians.

Climate and Health.—The climate of the city was originally very unhealthy, but it has improved greatly of recent years with modern sanitation and drainage. The climate is hot and damp, but has a pleasant cold season from November to March. April, May and June are hot; and the monsoon months from June to October are distinguished by damp heat and malaria. The mean annual temperature is 79° F., with a range from 85° in the hot season and 83° in the rains to 72° in the cool season, a mean maximum of 102° in May and a mean minimum of 48° in January. Calcutta has been comparatively fortunate in escaping the plague. The disease manifested itself in a sporadic form in April 1898, but disappeared by September of that year. Many of the Marwari traders fled the city, and some trouble was experienced in shortage of labour in the factories and at the docks. The plague returned in 1899 and caused a heavy mortality during the early months of the following year; but the population was not demoralized, nor was trade interfered with. A yet more serious outbreak occurred in the early months of 1901, the number of deaths being 7884. For three following years the totals were (1902-1903) 7284; (1903-1904) 8223; and (1904-1905) 4689; but these numbers compared very favourably with the condition of Bombay at the same time.

History.—The history of Calcutta practically dates from the 24th of August 1690, when it was founded by Job Charnock (q.v.) of the English East India Company. In 1596 it had obtained a brief entry as a rent-paying village in the survey of Bengal executed by command of the emperor Akbar. But it was not till ninety years later that it emerged into history. In 1686 the English merchants at Hugli under Charnock's leadership, finding themselves compelled to quit their factory in consequence of a rupture with the Mogul authorities, retreated about 26 m. down the river to Sutanati, a village on the banks of the Hugli, now within the boundaries of Calcutta. They occupied Sutanati temporarily in December 1686, again in November 1687 and permanently on the 24th of August 1690. It was thus only at the third attempt that Charnock was able to obtain the future capital of India for his centre and the subsequent prosperity of Calcutta is due entirely to his tenacity of purpose. The new settlement soon extended itself along the river bank to the then village of Kalikata, and by degrees the cluster of neighbouring hamlets grew into the present town. In 1696 the English built the original Fort William by permission of the nawab, and in 1698 they formally purchased the three villages of Sutanati, Kalikata and Govindpur from Prince Azim, son of the emperor Aurangzeb.

The site thus chosen had an excellent anchorage and was defended by the river from the Mahrattas, who barred the districts on the other side. The fort, subsequently rebuilt on the Vauban principle, and a moat, designed to form a semicircle

round the town, and to be connected at both ends with the river, but never completed, combined with the natural position of Calcutta to render it one of the safest places for trade in India during the expiring struggles of the Mogul empire. It grew up without any fixed plan, and with little regard to the sanitary arrangements required for a town. Some parts of it lay below high-water mark on the Hugli, and its low level throughout rendered its drainage a most difficult problem. Until far on in the 18th century the malarial jungle and paddy fields closely hemmed in the European mansions; the vast plain (*maidan*), now covered with gardens and promenades, was then a swamp during three months of each year; the spacious quadrangle known as Wellington Square was built upon a filthy creek. A legend relates how one-fourth of the European inhabitants perished in twelve months, and during seventy years the mortality was so great that the name of Calcutta, derived from the village of Kalikata, was identified by mariners with Golgotha, the place of a skull.

The chief event in the history of Calcutta is the sack of the town, and the capture of Fort William in 1756, by Suraj-ud-Dowlah, the nawab of Bengal. The majority of the English officials took ship and fled to the mouth of the Hugli river. The Europeans, under John Zephaniah Holwell, who remained were compelled, after a short resistance, to surrender themselves to the mercies of the young prince. The prisoners, numbering 146 persons, were forced into the guard-room, a chamber measuring only 18 ft. by 14 ft. 10 in., with but two small windows, where they were left for the night. It was the 20th of June; the heat was intense; and next morning only 23 were taken out alive, among them Holwell, who left an account of the awful sufferings endured in the "Black Hole." The site of the Black Hole is now covered with a black marble slab, and the incident is commemorated by a monument erected by Lord Curzon in 1902. The Mahomedans retained possession of Calcutta for about seven months, and during this brief period the name of the town was changed in official documents to Alinagar. In January 1757 the expedition despatched from Madras, under the command of Admiral Watson and Colonel Clive, regained possession of the city. They found many of the houses of the English residents demolished and others damaged by fire. The old church of St John lay in ruins. The native portion of the town had also suffered much. Everything of value had been swept away, except the merchandise of the Company within the fort, which had been reserved for the nawab. The battle of Plassey was fought on the 23rd of June 1757, exactly twelve months after the capture of Calcutta. Mir Jafar, the nominee of the English, was created nawab of Bengal, and by the treaty which raised him to this position he agreed to make restitution to the Calcutta merchants for their losses. The English received £500,000, the Hindus and Mahomedans £200,000, and the Armenians £70,000. By another clause in this treaty the Company was permitted to establish a mint, the visible sign in India of territorial sovereignty, and the first coin, still bearing the name of the Delhi emperor, was issued on the 10th of August 1757. The restitution money was divided among the sufferers by a committee of the most respectable inhabitants. Commerce rapidly revived and the ruined city was rebuilt. Modern Calcutta dates from 1757. The old fort was abandoned, and its site devoted to the custom-house and other government offices. A new fort, the present Fort William, was begun by Clive a short distance lower down the river, and is thus the second of that name. It was not finished till 1773, and is said to have cost two millions sterling. At this time also the *maidan*, the park of Calcutta, was formed; and the healthiness of its position induced the European inhabitants gradually to shift their dwellings eastward, and to occupy what is now the Chowringhee quarter.

Up to 1707, when Calcutta was first declared a presidency, it had been dependent upon the older English settlement at Madras. From 1707 to 1773 the presidencies were maintained on a footing of equality; but in the latter year the act of parliament was passed, which provided that the presidency of Bengal should exercise a control over the other possessions of the

Company; that the chief of that presidency should be styled governor-general; and that a supreme court of judicature should be established at Calcutta. In the previous year, 1772, Warren Hastings had taken under the immediate management of the Company's servants the general administration of Bengal, which had hitherto been left in the hands of the old Mahomedan officials, and had removed the treasury from Murshidabad to Calcutta. The latter town thus became the capital of Bengal and the seat of the supreme government in India. In 1834 the governor-general of Bengal was created governor-general of India, and was permitted to appoint a deputy-governor to manage the affairs of Lower Bengal during his occasional absence. It was not until 1854 that a separate head was appointed for Bengal, who, under the style of lieutenant-governor, exercises the same powers in civil matters as those vested in the governors in council of Madras or Bombay, although subject to closer supervision by the supreme government. Calcutta is thus at present the seat both of the supreme and the local government, each with an independent set of offices. (See BENGAL.)

See A. K. Ray, *A Short History of Calcutta* (Indian Census, 1901); H. B. Hyde, *Farochial Annals of Bengal* (1901); K. Blechynden, *Calcutta Past and Present* (1905); H. E. Busted, *Echoes from Old Calcutta* (1897); G. W. Forrest, *Cities of India* (1903); C. R. Wilson, *Early Annals of the English in Bengal* (1895); and *Old Fort William in Bengal* (1906); *Imperial Gazetteer of India* (Oxford, 1908), s.v. "Calcutta."

CALDANI, LEOPOLDO MARCO ANTONIO (1725-1813), Italian anatomist and physician, was born at Bologna in 1725. After studying under G. B. Morgagni at Padua, he began to teach practical medicine at Bologna, but in consequence of the intrigues of which he was the object he returned to Padua, where in 1771 he succeeded Morgagni in the chair of anatomy. He continued to lecture until 1805 and died at Padua in 1813. His works include *Institutiones pathologicae* (1772), *Institutiones physiologicae* (1773) and *Icones anatomicae* (1801-1813).

His brother, **PETRONIO MARIA CALDANI** (1735-1808), was professor of mathematics at Bologna, and was described by J. le R. D'Alembert as the "first geometer and algebraist of Italy."

CALDECOTT, RANDOLPH (1846-1886), English artist and illustrator, was born at Chester on the 22nd of March 1846. From 1861 to 1872 he was a bank clerk, first at Whitchurch in Shropshire, afterwards at Manchester; but devoted all his spare time to the cultivation of a remarkable artistic faculty. In 1872 he migrated to London, became a student at the Slade School and finally adopted the artist's profession. He gained immediately a wide reputation as a prolific and original illustrator, gifted with a genial; humorous faculty, and he succeeded also, though in less degree, as a painter and sculptor. His health gave way in 1876, and after prolonged suffering he died in Florida on the 12th of February 1886. His chief book illustrations are as follows:—*Old Christmas* (1876) and *Bracebridge Hall* (1877), both by Washington Irving; *North Italian Folk* (1877), by Mrs Comyns Carr; *The Hare Mountains* (1883); *Bretton Folk* (1879), by Henry Blackburn; picture-books (*John Gilpin*, *The House that Jack Built*, and other children's favourites) from 1878 onwards; *Some Aesop's Fables with Modern Instances*, &c. (1883). He held a roving commission for the *Graphic*, and was an occasional contributor to *Punch*. He was a member of the Royal Institute of Painters in Water-colours.

See Henry Blackburn, *Randolph Caldecott, Personal Memoir of his Early Life* (London, 1886).

CALDER, SIR ROBERT, Bart. (1745-1818), British admiral, was born at Elgin, in Scotland, on the 2nd of July 1745 (o.s.). He belonged to a very ancient family of Morayshire, and was the second son of Sir Thomas Calder of Muirton. He was educated at the grammar school of Elgin, and at the age of fourteen entered the British navy as midshipman. In 1766 he was serving as lieutenant of the "Essex," under Captain the Hon. George Faulkner, in the West Indies. Promotion came slowly, and it was not till 1782 that he attained the rank of post-captain. He acquitted himself honourably in the various services to which he was called, but for a long time had no opportunity

of distinguishing himself. In 1796 he was named captain of the fleet by Sir John Jervis, and took part in the great battle off Cape St Vincent (February 14, 1797). He was selected as bearer of the despatches announcing the victory, and on that occasion was knighted by George III. He also received the thanks of parliament, and in the following year was created a baronet. In 1799 he became rear-admiral, and in 1801 he was despatched with a small squadron in pursuit of a French force, under Admiral Gantheaume, conveying supplies to the French in Egypt. In this pursuit he was not successful, and returning home at the peace he struck his flag. When the war again broke out he was recalled to service, was promoted vice-admiral in 1804, and was employed in the following year in the blockade of the ports of Ferrol and Corunna, in which (amongst other ports) ships were preparing for the invasion of England by Napoleon I. He held his position with a force greatly inferior to that of the enemy, and refused to be enticed out to sea. On its becoming known that the first movement directed by Napoleon was the raising of the blockade of Ferrol, Rear-Admiral Stirling was ordered to join Sir R. Calder and cruise with him to intercept the fleets of France and Spain on their passage to Brest. The approach of the enemy was concealed by a fog, but on the 22nd of July 1805 their fleet came in sight. It still outnumbered the British force; but Sir Robert entered into action. After a combat of four hours, during which he captured two Spanish ships, he gave orders to discontinue the action. He offered battle again on the two following days, but the challenge was not accepted. The French admiral Villeneuve, however, did not pursue his voyage, but took refuge in Ferrol. In the judgment of Napoleon, his scheme of invasion was baffled by this day's action; but much indignation was felt in England at the failure of Calder to win a complete victory. In consequence of the strong feeling against him at home he demanded a court-martial. This was held on the 23rd of December, and resulted in a severe reprimand of the vice-admiral for not having done his utmost to renew the engagement, at the same time acquitting him of both cowardice and disaffection. False expectations had been raised in England by the mutilation of his despatches, and of this he indignantly complained in his defence. The tide of feeling, however, turned again; and in 1815, by way of public testimony to his services, and of acquittal of the charge made against him, he was appointed commander of Portsmouth. He died at Holt, near Bishop's Waltham, in Hampshire, on the 31st of August 1818.

See *Naval Chronicle*, xvii.; James, *Naval History*, iii. 356-379 (1866).

CALDER, an ancient district of Midlothian, Scotland. It has been divided into the parishes of Mid-Calder (pop. in 1901 3132) and West Calder (pop. 8092), East-Calder belonging to the parish of Kirknewton (pop. 3221). The whole locality owes much of its commercial importance and prosperity to the enormous development of the mineral oil industry. Coal-mining is also extensively pursued, sandstone and limestone are worked, and paper-mills flourish. Mid-Calder, a town on the Almond (pop. 703), has an ancient church, and John Spottiswood (1510-1585), the Scottish reformer, was for many years minister. His sons—John, archbishop of St Andrews, and James (1567-1645), bishop of Clogher—were both born at Mid-Calder. West-Calder is situated on Breich Water, an affluent of the Almond, 1½ m. S.W. of Edinburgh by the Caledonian railway, and is the chief centre of the district. Pop. (1901) 2652. At Addiewell, about 1½ m. S.W., the manufacture of ammonia, naphtha, paraffin oil and candles is carried on, the village practically dating from 1866, and having in 1901 a population of 1591. The Highland and Agricultural Society have an experimental farm at Pumpherton (pop. 1462). The district contains several tumuli, old ruined castles and a Roman camp in fair preservation.

CALDERÓN, RODRIGO (d. 1621), COUNT OF OLIVA AND MARQUES DE LAS SIETE IGLESIAS, Spanish favourite and adventurer, was born at Antwerp. His father, Francisco Calderón, a member of a family ennobled by Charles V., was a captain

in the army who became afterwards *comendador mayor* of Aragon, presumably by the help of his son. The mother was a Fleming, said by Calderón to have been a lady by birth and called by him María Sandelín. She is said by others to have been first the mistress and then the wife of Francisco Calderón. Rodrigo is said to have been born out of wedlock. In 1598 he entered the service of the duke of Lerma as secretary. The accession of Philip III. in that year made Lerma, who had unbought influence over the king, master of Spain. Calderón, who was active and unscrupulous, made himself the trusted agent of Lerma. In the general scramble for wealth among the worthless intriguers who governed in the name of Philip III., Calderón was conspicuous for greed, audacity and insolence. He was created count of Oliva, a knight of Santiago, *comendador* of Ocaña in the order, secretary to the king (*secretario de cámara*), was loaded with plunder, and made an advantageous marriage with Ines de Vargas. As an insolent upstart he was peculiarly odious to the enemies of Lerma. Two religious persons, Juana de Santá Maria, a Franciscan, and Mariana de San José, prioress of La Encarnación, worked on the queen Margarita, by whose influence Calderón was removed from the secretaryship in 1611. He, however, retained the favour of Lerma, an indolent man to whom Calderón's activity was indispensable. In 1612 he was sent on a special mission to Flanders, and on his return was made marqués de las Siete Iglesias in 1614. When the queen Margarita died in that year in childbirth, Calderón was accused of having used witchcraft against her. Soon after it became generally known that he had ordered the murder of one Francisco de Juaras. When Lerma was driven from court in 1618 by the intrigues of his own son, the duke of Uceda, and the king's confessor, the Dominican Alaga, Calderón was seized upon as an expiatory victim to satisfy public clamour. He was arrested, despoiled, and on the 7th of January 1620 was savagely tortured to make him confess to the several charges of murder and witchcraft brought against him. Calderón confessed to the murder of Juaras, saying that the man was a pander, and adding that he gave the particular reason by word of mouth since it was more fit to be spoken than written. He steadfastly denied all the other charges of murder and the witchcraft. Some hope of pardon seems to have remained in his mind till he heard the bells tolling for Philip III. in March 1621. "He is dead, and I too am dead" was his resigned comment. One of the first measures of the new reign was to order his execution. Calderón met his fate firmly and with a show of piety on the 21st of October 1621, and this bearing, together with his broken and prematurely aged appearance, turned public sentiment in his favour. The magnificent devotion of his wife helped materially to placate the hatred he had aroused. Lord Lytton made Rodrigo Calderón the hero of his story *Calderon the Courtier*.

See Modesta de la Fuente, *Historia General España* (Madrid, 1850-1867), vol. xv. pp. 452 et seq.; Quevedo, *Obras* (Madrid, 1791), vol. x.—*Grandes Anales de Quince Dias*. A curious contemporary French pamphlet on him, *Histoire admirable et décisive pilotable advenue en la personne d'un favori de la Cour d'Espagne*, is reprinted by M. E. Fournier in *Variétés historiques* (Paris, 1855), vol. I. (D. H.)

CALDERÓN DE LA BARCA, PEDRO (1600-1681), Spanish dramatist and poet, was born at Madrid on the 17th of January 1600. His mother, who was of Flemish descent, died in 1610; his father, who was secretary to the treasury, died in 1615. Calderón was educated at the Jesuit College in Madrid with a view to taking orders and accepting a family living; abandoning this project, he studied law at Salamanca, and competed with success at the literary fêtes held in honour of St Isidore at Madrid (1620-1622). According to his biographer, Vera Tassis, Calderón served with the Spanish army in Italy and Flanders between 1625 and 1635; but this statement is contradicted by numerous legal documents which prove that Calderón resided at Madrid during these years. Early in 1629 his brother Diego was stabbed by an actor who took sanctuary in the convent of the Trinitarian nuns; Calderón and his friends broke into the cloister and attempted to seize the offender. This violation was denounced by the fashionable preacher, Hortensio Félix Paravicino (q.v.), in a sermon preached before Philip IV.;

Calderón retorted by introducing into *El Príncipe constante* a mocking reference (afterwards cancelled) to Paravicino's gongoristic verbiage, and was committed to prison. He was soon released, grew rapidly in reputation as a playwright, and, on the death of Lope de Vega in 1635, was recognized as the foremost Spanish dramatist of the age. A volume of his plays, edited by his brother José in 1636, contains such celebrated and diverse productions as *La Vida es sueño*, *El Purgatorio de San Patricio*, *La Desciende de la cruz*, *La Dama duende* and *Peor está que estaba*. In 1636-1637 he was made a knight of the order of Santiago by Philip IV., who had already commissioned from him a series of spectacular plays for the royal theatre in the Buen Retiro. Calderón was almost as popular with the general public as Lope de Vega had been in his zenith; he was, moreover, in high favour at court, but this royal patronage did not help to develop the finer elements of his genius. On the 28th of May 1640 he joined a company of mounted cuirassiers recently raised by Olivares, took part in the Catalanian campaign, and distinguished himself by his gallantry at Tarragona, his health failing, he retired from the army in November 1642, and three years later was awarded a special military pension in recognition of his services in the field. The history of his life during the next few years is obscure. He appears to have been profoundly affected by the death of his mistress—the mother of his son Pedro José—about the year 1648-1649, his long connexion with the theatre had led him into temptations, but it had not diminished his instinctive spirit of devotion, and he now sought consolation in religion. He became a tertiary of the order of St Francis in 1650, and finally reverted to his original intention of joining the priesthood. He was ordained in 1651, was presented to a living in the parish of San Salvador at Madrid, and, according to his statement made a year or two later, determined to give up writing for the stage. He did not adhere to this resolution after his preferment to a prebend at Toledo in 1653, though he confined himself as much as possible to the composition of *autos sacramentales*—allegorical pieces in which the mystery of the Eucharist was illustrated dramatically, and which were performed with great pomp on the feast of Corpus Christi and during the weeks immediately ensuing. In 1662 two of Calderón's *autos*—*Las órdenes militares* and *Misericordia real Babilonia*—were the subjects of an inquiry by the Inquisition; the former was censured, the manuscript copies were confiscated, and the condemnation was not rescinded till 1671. Calderón was appointed honorary chaplain to Philip IV. in 1663, and the royal favour was continued to him in the next reign. In his eighty-first year he wrote his last secular play, *Hado y Divisa de Leonido y Marfisa*, in honour of Charles II.'s marriage to Marie-Louise de Bourbon. Notwithstanding his position at court and his universal popularity throughout Spain, his closing years seem to have been passed in poverty. He died on the 25th of May 1681.

Like most Spanish dramatists, Calderón wrote too much and too speedily, and he was too often content to recast the productions of his predecessors. His *Saber del mal y del bien* is an adaptation of Lope de Vega's play, *Las Mudanzas de la fortuna y sucesos de Don Beltrán de Aragón*; his *Seba confusa* is also adapted from a play of Lope's which bears the same title; his *Encanto sin encanto* derives from Tirso de Molina's *Amar por señas*, and, to take an extreme instance, the second act of his *Cabellos de Abalón* is transferred almost bodily from the third act of Tirso's *Venganza de Tamar*. It would be easy to add other examples of Calderón's lax methods, but it is simple justice to point out that he committed no offence against the prevailing code of literary morality. Many of his contemporaries plagiarized with equal audacity, but with far less success. Sometimes, as in *El Alcalde de Zalamea*, the bold procedure is completely justified by the result; in this case by his individual treatment he transforms one of Lope de Vega's rapid improvisations into a finished masterpiece. It was not given to him to initiate a great dramatic movement; he came at the end of a literary revolution, was compelled to accept the conventions which Lope de Vega had imposed on the Spanish stage, and he accepted them all the more readily since they were peculiarly

suitable to the display of his splendid and varied gifts. Not a master of observation nor an expert in invention, he showed an unexampled skill in contriving ingenious variants on existing themes; he had a keen dramatic sense, an unrivalled dexterity in manipulating the mechanical resources of the stage, and in addition to these minor indispensable talents he was endowed with a lofty philosophic imagination and a wealth of poetic diction. Naturally, he had the defects of his great qualities; his ingenuity is apt to degenerate into futile embellishment; his employment of theatrical devices is the subject of his own good-humoured satire in *No hay burlas con el amor*; his philosophic intellect is more interested in theological mysteries than in human passions; and the delicate beauty of his style is tinged with a wilful preciosity. Excelling Lope de Vega at many points, Calderón falls below his great predecessor in the delineation of character. Yet in almost every department of dramatic art Calderón has obtained a series of triumphs. In the symbolic drama he is best represented by *El Príncipe constante*, by *El Mágico prodigioso* (familiar to English readers in Shelley's free translation), and by *La Vida es sueño*, perhaps the most profound and original of his works. His tragedies are more remarkable for their acting qualities than for their convincing truth, and the fact that in *La Niña de Gomas Arias* he interpolates an entire act borrowed from Velez de Guevara's play of the same title seems to indicate that this kind of composition awakened no great interest in him; but in *El Médico de su honra* and *El Mayor monstruo los celos* the theme of jealousy is handled with sombre power, while *El Alcalde de Zalamea* is one of the greatest tragedies in Spanish literature. Calderón is seen to much less advantage in the spectacular plays—*dramas de tramoya*—which he wrote at the command of Philip IV.; the dramatist is subordinated to the stage-carpenter, but the graceful fancy of the poet preserves even such a mediocre piece as *Los Tres Mayores prodigios* (which won him his knighthood) from complete oblivion. A greater opportunity is afforded in the more animated *comedias palociegas*, or melodramatic pieces destined to be played before courtly audiences in the royal palace: *La Banda y la flor* and *El Galán fantasma* are charming illustrations of Calderón's genial conception and refined artistry. His historical plays (*La Gran Cenobia*, *Las armas de la hermosura*, &c.) are the weakest of all his formal dramatic productions; *El Golfo de lo sirenas* and *La Párpura de lo rosa* are typical *sarsueles*, to be judged by the standard of operatic libretti, and the *entremeses* are lacking in the lively humour which should characterize these dramatic interludes. On the other hand, Calderón's faculty of ingenious stagecraft is seen at its best in his "cloak-and-sword" plays (*comedias de capa y espada*) which are invaluable pictures of contemporary society. They are conventional, no doubt, in the sense that all representations of a specially artificial society must be conventional; but they are true to life, and are still as interesting as when they first appeared. In this kind *No siempre lo peor es cierto*, *La Dama duende*, *Una casa con dos puertas mala es de guardar* and *Guardado del agua mansa* are almost unsurpassed. But it is as a writer of *autos sacramentales* that Calderón defies rivalry; his intense devotion, his subtle intelligence, his sublime lyricism all combine to produce such marvels of allegorical poetry as *La Cena del rey Baltasar*, *La Vitis del Señor* and *La Serpiente de metal*. The *autos* lingered on in Spain till 1765, but they may be said to have died with Calderón, for his successors merely imitated him with a tedious fidelity. Almost alone among Spanish poets, Calderón had the good fortune to be printed in a fairly correct and readable edition (1682-1691), thanks to the enlightened zeal of his admirer, Juan de Vera Tassis y Villaroel, and owing to this happy accident he came to be regarded generally as the first of Spanish dramatists. The publication of the plays of Lope de Vega and of Tirso de Molina has affected the critical estimate of Calderón's work; he is seen to be inferior to Lope de Vega in creative power, and inferior to Tirso de Molina in variety of conception. But, setting aside the extravagances of his admirers, he is admittedly an exquisite poet, an expert in the dramatic form, and a typical representative of the

devout, chivalrous, patriotic and artificial society in which he moved.

BIBLIOGRAPHY.—H. Breymann, *Calderon-Studien* (München and Berlin, 1905), i. Teil, contains a fairly exhaustive list of editions, translations and arrangements; *Autos sacramentales* (Madrid, 1759-1760, 6 vols.), edited by Juan Fernandez de Apontes; *Comedias* (Madrid, 1848-1850, 4 vols.), edited by Juan Eugenio Hartzenbusch; Max Krenkel, *Klassische Bühnendichtungen der Spanier*, containing *La Vida es sueño, El magico prodigioso* and *El Alcalde de Zalamea* (Leipzig, 1881-1887, 3 vols.); *Teatro selecto* (Madrid, 1884, 4 vols.), edited by M. Menéndez y Pelayo; *El Magico prodigioso* (Heilbronn, 1877), edited by Alfred Morel-Fatio; *Select Plays of Calderón* (London, 1888), edited by Norman MacColl; F. W. V. Schmidt, *Die Schauspiele Calderón's* (Erlfeld, 1857); E. Günthner, *Calderón und seine Werke* (Freiburg i. B., 1888, 2 vols.); Felipe Picoatoste y Rodríguez, *Biografía de Don Pedro Calderón de la Barca en Homageo a Calderón* (Madrid, 1881); Antonio Sánchez Moguel, *Memorias acerca de "El Magico prodigioso"* (Madrid, 1881); M. Menéndez y Pelayo, *Calderón y su teatro* (Madrid, 1881); Ernest Martinenche, *La Comedia española en Francia de Hardy à Racine* (Paris, 1900). (J. F.-K.)

CALDERWOOD, DAVID (1575-1650), Scottish divine and historian, was born in 1575. He was educated at Edinburgh, where he took the degree of M.A. in 1593. About 1604 he became minister of Crailing, near Jedburgh, where he became conspicuous for his resolute opposition to the introduction of Episcopacy. In 1617, while James was in Scotland, a Remonstrance, which had been drawn up by the Presbyterian clergy, was placed in Calderwood's hands. He was summoned to St Andrews and examined before the king, but neither threats nor promises could make him deliver up the roll of signatures to the Remonstrance. He was deprived of his charge, committed to prison at St Andrews and afterwards removed to Edinburgh. The privy council ordered him to be banished from the kingdom for refusing to acknowledge the sentence of the High Commission. He lingered in Scotland, publishing a few tracts, till the 27th of August 1619, when he sailed for Holland. During his residence in Holland he published his *Altare Damascenum*. Calderwood appears to have returned to Scotland in 1624, and he was soon afterwards appointed minister of Pencaitland, in the county of Haddington. He continued to take an active part in the affairs of the church, and introduced in 1649 the practice, now confirmed by long usage, of dissenting from the decision of the Assembly, and requiring the protest to be entered in the record. His last years were devoted to the preparation of a *History of the Church of Scotland*. In 1648 the General Assembly urged him to complete the work he had designed, and voted him a yearly pension of £800. He left behind him a historical work of great extent and of great value as a storehouse of authentic materials for history. An abridgment, which appears to have been prepared by himself, was published after his death. An excellent edition of the complete work was published by the Wodrow Society, 8 vols., 1842-1849. The manuscript, which belonged to General Calderwood Durham, was presented to the British Museum. Calderwood died at Jedburgh on the 29th of October 1650.

CALDERWOOD, HENRY (1830-1897), Scottish philosopher and divine, was born at Peebles on the 10th of May 1830. He was educated at the Royal High school, and later at the university of Edinburgh. He studied for the ministry of the United Presbyterian Church, and in 1856 was ordained pastor of the Greyfriars church, Glasgow. He also examined in mental philosophy for the university of Glasgow from 1861 to 1864, and from 1866 conducted the moral philosophy classes at that university, until in 1868 he became professor of moral philosophy at Edinburgh. He was made LL.D. of Glasgow in 1865. He died on the 19th of November 1897. His first and most famous work was *The Philosophy of the Infinite* (1854), in which he attacked the statement of Sir William Hamilton that we can have no knowledge of the Infinite. Calderwood maintained that such knowledge, though imperfect, is real and ever-increasing; that Faith implies Knowledge. His moral philosophy is in direct antagonism to Hegelian doctrine, and endeavours to substantiate the doctrine of divine sanction. Beside the data of experience, the mind has pure activity of its own whereby it apprehends the fundamental

realities of life and combat. He wrote in addition *A Handbook of Moral Philosophy, On the Relations of Mind and Brain, Science and Religion, The Evolution of Man's Place in Nature*. Among his religious works the best-known is his *Parables of Our Lord*, and just before his death he finished a *Life of David Hume* in the "Famous Scots" series. His interests were not confined to religious and intellectual matters; as the first chairman of the Edinburgh school board, he worked hard to bring the Education Act into working order. He published a well-known treatise on education. In the cause of philanthropy and temperance he was indefatigable. In politics he was at first a Liberal, but became a Liberal Unionist at the time of the Home Rule Bill.

A biography of Calderwood was published in 1906 by his son W. C. Calderwood and the Rev. David Woodside, with a special chapter on his philosophy by Professor A. S. Pringle-Pattison.

CALEB (Heb. אֶלֶב, "dog"), in the Bible, one of the spies sent by Moses from Kadeah in South Palestine to spy out the land of Canaan. For his courage and confidence he alone was rewarded by the promise that he and his seed should obtain a possession in it (Num. xiii. seq.). The later tradition includes Joshua, the hero of the conquest of the land. Subsequently Caleb settled in Kirjath-Arba (Hebron), but the account of the occupation is variously recorded. Thus (a) Caleb by himself drove out the Anakites, giants of Hebron, and promised to give his daughter Achsah to the hero who could take Kirjath-Sepher (Debir). This was accomplished by Othniel, the brother of Caleb (Josh. xv. 14-19). Both are "sons" of Kenaz, and Kenaz is an Edomite clan (Gen. xxxvi. 11, 15, 42). Elsewhere (b) Caleb the Kenazite reminds Joshua of the promise at Kadeah; he asks that he may have the "mountain whereof Yahweh spake," and hopes to drive out the giants from its midst. Joshua blesses him and thus Hebron becomes the inheritance of Caleb (Josh. xiv. 6-15). Further (c) the capture of Hebron and Debir is ascribed to Judah who gives them to Caleb (Judg. i. 10 seq. 20); and finally (d) these cities are taken by Joshua himself in the course of a great and successful campaign against South Canaan (Josh. x. 36-39). Primarily the clan Caleb was settled in the south of Judah but formed an independent unit (1 Sam. xrv., xxx. 14). Its seat was at Carmel, and Abigail, the wife of the Calebite Nabal, was taken by David after her husband's death. Not until later are the small divisions of the south united under the name Judah, and this result is reflected in the genealogies where the brothers Caleb and Jerahmeel are called "sons of Hebron" (the name typifies nomadic life) and become descendants of JUDAH.

Similarly in Num. xiii. 6, xxxiv. 19 (post-exilic), Caleb becomes the representative of the tribe of Judah, and also in e (above) Caleb's enterprise was later regarded as the work of the tribe with which it became incorporated. b and d are explained in accordance with the aim of the book to ascribe to the initiation or the achievements of one man the conquest of the whole of Canaan (see JOSHUA). The mount or hill-country in b appears to be that which the Israelites unsuccessfully attempted to take (Num. xiv. 41-45), but according to another old fragment Hormah was the scene of a victory (Num. xxi. 1-3), and it seems probable that Caleb, at least, was supposed to have pushed his way northward to Hebron. (See JERAMEEL, KENITES, SIMSON.)

The genealogical lists place the earliest seats of Caleb in the south of Judah (1 Chron. ii. 42 seq.; Hebron, Maon, etc.). Another list numbers the more northerly towns of Kirjath-jearim, Bethlehem, etc., and adds the "families of the scribes," and the Kenazites (ii. 50 seq.). This second move is characteristically expressed by the statements that Caleb's first wife was Ashbah ("abandoned," desert region)—Jerib ("tent curtains") appears to have been another—and that after the death of Heseon he united with Ephrath (p. 22; Bethlehem). On the details to 1 Chron. ii. iv., see further, J. Wellhausen, *De Gent. et Famil. Judaearum* (1869); S. Cook, *Critical Notes on O. T. History*, Index, s.v.; E. Meyer, *Israelitica*, pp. 400 sqq.; and the commentaries on Chronicles (2s.). (S. A. C.)

CALEDON (1) a town of the Cape Province, 81 m. by rail E.S.E. of Cape Town. Pop. (1904) 3508. The town is 15 m. N. of the sea at Walker Bay and is built on a spur of the Zwartberg, 800 ft. high. The streets are lined with blue gums and oaks. From the early day of Dutch settlement at the Cape Caledon has been noted for the curative value of its mineral springs, which yield 150,000 gallons daily. There are seven springs, six with a natural temperature of 120° F., the seventh

being cold. The district is rich in flowering heaths and everlasting flowers. The name Caledon was given to the town and district in honour of the 2nd earl of Caledon, governor of the Cape 1807-1811. (2) A river of South Africa, tributary to the Orange (q.v.), also named after Lord Caledon.

CALEDONIA, the Roman name of North Britain, still used especially in poetry for Scotland. It occurs first in the poet Lucan (A.D. 64), and then often in Roman literature. There were (1) a district Caledonia, of which the southern border must have been on or near the isthmus between the Clyde and the Forth, (2) a Caledonian Forest (possibly in Perthshire), and (3) a tribe of Caledones or Calidones, named by the geographer Ptolemy as living within boundaries which are now unascertainable. The Romans first invaded Caledonia under Agricola (about A.D. 83). They then fortified the Forth and Clyde Isthmus with a line of forts, two of which, those at Camelon and Barhill, have been identified and excavated, penetrated into Perthshire, and fought the decisive battle of the war (according to Tacitus) on the slopes of Mons Graupius.¹ The site—quite as hotly contested among antiquaries as between Roman and Caledonian—may have been near the Roman encampment of Inchtuthill (in the policies of Delvine, 10 m. N. of Perth near the union of Tay and Isla), which is the most northerly of the ascertained Roman encampments in Scotland and seems to belong to the age of Agricola. Tacitus represents the result as a victory. The home government, whether averse to expensive conquests of barren hills, or afraid of a victorious general, abruptly recalled Agricola, and his northern conquests—all beyond the Tweed, if not all beyond Cheviot—were abandoned. The next advance followed more than fifty years later. About A.D. 140 the district up to the Firth of Forth was definitely annexed, and a rampart with forts along it, the Wall of Antoninus Pius, was drawn from sea to sea (see *BRITAIN: ROMAN*; and *GRAHAM'S DYKE*). At the same time the Roman forts at Ardoch, north of Dunblane, Carpow near Abernethy, and perhaps one or two more, were occupied. But the conquest was stubbornly disputed, and after several risings, the land north of Cheviot seems to have been lost about A.D. 180-185. About A.D. 208 the emperor Septimius Severus carried out an extensive punitive expedition against the northern tribes, but while it is doubtful how far he penetrated, it is certain that after his death the Roman writ never again ran north of Cheviot. Rome is said, indeed, to have recovered the whole land up to the Wall of Pius in A.D. 368 and to have established there a province, *Valentia*. A province with that name was certainly organized somewhere. But its site and extent is quite uncertain and its duration was exceedingly brief. Throughout, Scotland remained substantially untouched by Roman influences, and its Celtic art, though perhaps influenced by Irish, remained free from Mediterranean infusion. Even in the south of Scotland, where Rome ruled for half a century (A.D. 142-180), the occupation was military and produced no civilizing effects. Of the actual condition of the land during the period of Roman rule in Britain, we have yet to learn the details by excavation. The curious carvings and ramparts, at Burghhead on the coast of Elgin, and the underground stone houses locally called "weehems" in which Roman fragments have been found, may represent the native forms of dwelling, &c., and some of the "Late Celtic" metal-work may belong to this age. But of the political divisions, the boundaries and capitals of the tribes, and the like, we know nothing. Ptolemy gives a list of tribe and place-names. But hardly one can be identified with any approach to certainty, except in the extreme south. Nor has any certainty been reached about the ethnological problems of the population, the Aryan or non-Aryan character of the Picts and the like. That the Caledonians, like the later Scots, sometimes sought their fortunes in the south, is proved by a curious tablet of about A.D. 220, found at Colchester, dedicated to an unknown equivalent of Mars, Medocius, by one "Lossio Veda, nepos [= kin of] Vepogeni, Caledo." The name Caledonia is said to survive in

the second syllable of Dunkeld and in the mountain name Schiehallion (Sith-chailinn).

AUTHORITIES.—Tacitus, *Agricola*; Hist. Augusta, *Vita Severi*; Dio lxxvi.; F. Haverfield, *The Antonine Wall Report* (Glasgow, 1899), pp. 154-168; J. Rhys, *Celtic Britain* (ed. 3). On Burghhead, see H. W. Young, *Proc. of Scottish Antiq. xxv., xxvii.*; J. Macdonald, *Trans. Glasgow Arch. Society*. The Roman remains of Scotland are described in Rob. Stuart's *Caled. Romana* (Edinburgh, 1852), the volumes of the Scottish Antiq. Society, the *Corpus Inscriptionum Latinarum*, vol. vii., and elsewhere. (F. J. H.)

CALEDONIAN CANAL. The chain of fresh-water lakes—Lochs Ness, Oich and Lochy—which stretch along the line of the Great Glen of Scotland in a S.W. direction from Inverness early suggested the idea of connecting the east and west coasts of Scotland by a canal which would save ships about 400 m. of coasting voyage round the north of Great Britain through the stormy Pentland Firth. In 1773 James Watt was employed by the government to make a survey for such a canal, which again was the subject of an official report by Thomas Telford in 1801. In 1803 an act of parliament was passed authorizing the construction of the canal, which was begun forthwith under Telford's direction, and traffic was started in 1822. From the northern entrance on Beaully Firth to the southern, near Fort William, the total length is about 60 m., that of the artificial portion being about 22 m. The number of locks is 28, and their standard dimensions are:—length 160 ft., breadth 38 ft., water-depth 13 ft. Their lift is in general about 8 ft., but some of them are for regulating purposes only. A flight of 8 at Corpach, with a total lift of 64 ft., is known as "Neptune's Staircase." The navigation is vested in and managed by the commissioners of the Caledonian Canal, of whom the speaker of the House of Commons is *ex officio* chairman. Usually the income is between £7000 and £8000 annually, and exceeds the expenditure by a few hundred pounds; but the commissioners are not entitled to make a profit, and the credit balances, though sometimes allowed to accumulate, must be expended on renewals and improvements of the canal. They have not, however, always proved sufficient for their purposes, and parliament is occasionally called upon to make special grants. In the commissioners is also vested the Crinan Canal, which extends from Ardrishaig on Loch Gilp to Crinan on Loch Crinan. This canal was made by a company incorporated by act of parliament in 1793, and was opened for traffic in 1801. At various times it received grants of public money, and ultimately in respect of these it passed into the hands of the government. In 1848 it was vested by parliament in the commissioners of the Caledonian Canal (who had in fact administered it for many years previously); the act contained a proviso that the company might take back the undertaking on repayment of the debt within 20 years, but the power was not exercised. The length of the canal is 9 m., and it saves vessels sailing from the Clyde a distance of about 85 m. as compared with the alternative route round the Mull of Kintyre. Its highest reach is 64 ft. above sea level, and its locks, 15 in number, are 96 ft. long, by 24 ft. wide, the depth of water being such as to admit vessels up to a draught of 9 ft. The revenue is over £6000 a year, and there is usually a small credit balance which, as with the Caledonian Canal, must be applied to the purposes of the undertaking.

CALENBERG, or **KALENBERG**, the name of a district, including the town of Hanover, which was formerly part of the duchy of Brunswick. It received its name from a castle near Schulenberg, and is traversed by the rivers Weser and Leine, its area being about 1050 sq. m. The district was given to various cadets of the ruling house of Brunswick, one of these being Ernest Augustus, afterwards elector of Hanover, and the ancestor of the Hanoverian kings of Great Britain and Ireland.

CALENDAR, so called from the Roman Calends or Kalends, a method of distributing time into certain periods adapted to the purposes of civil life, as hours, days, weeks, months, years, &c.

Of all the periods marked out by the motions of the celestial bodies, the most conspicuous, and the most intimately connected with the affairs of mankind, are the *solar day*, which is

¹ This, not *Grampius*, is the proper spelling, though *Grampius* was at one time commonly accepted and indeed gave rise to the modern name *Grampian*.

distinguished by the diurnal revolution of the earth and the alternation of light and darkness, and the *solar year*, which completes the circle of the seasons. But in the early ages of the world, when mankind were chiefly engaged in rural occupations, the phases of the moon must have been objects of great attention and interest,—hence the *month*, and the practice adopted by many nations of reckoning time by the motions of the moon, as well as the still more general practice of combining lunar with solar periods. The solar day, the solar year, and the lunar month, or lunation, may therefore be called the *natural* divisions of time. All others, as the hour, the week, and the civil month, though of the most ancient and general use, are only arbitrary and conventional.

Day.—The subdivision of the day (*q.s.*) into twenty-four parts, or hours, has prevailed since the remotest ages, though different nations have not agreed either with respect to the epoch of its commencement or the manner of distributing the hours. Europeans in general, like the ancient Egyptians, place the commencement of the civil day at midnight, and reckon twelve morning hours from midnight to midday, and twelve evening hours from midday to midnight. Astronomers, after the example of Ptolemy, regard the day as commencing with the sun's culmination, or noon, and find it most convenient for the purposes of computation to reckon through the whole twenty-four hours. Hipparchus reckoned the twenty-four hours from midnight to midnight. Some nations, as the ancient Chaldeans and the modern Greeks, have chosen sunrise for the commencement of the day, others, again, as the Italians and Bohemians, suppose it to commence at sunset. In all these cases the beginning of the day varies with the seasons at all places not under the equator. In the early ages of Rome, and even down to the middle of the 5th century after the foundation of the city, no other divisions of the day were known than sunrise, sunset, and midday, which was marked by the arrival of the sun between the Rostra and a place called Græcostasis, where ambassadors from Greece and other countries used to stand. The Greeks divided the natural day and night into twelve equal parts each, and the hours thus formed were denominated *temporary hours*, from their varying in length according to the seasons of the year. The hours of the day and night were of course only equal at the time of the equinoxes. The whole period of day and night they called *ἡμέρας*.

Week.—The week is a period of seven days, having no reference whatever to the celestial motions,—a circumstance to which it owes its unalterable uniformity. Although it did not enter into the calendar of the Greeks, and was not introduced at Rome till after the reign of Theodosius, it has been employed from time immemorial in almost all eastern countries; and as it forms neither an aliquot part of the year nor of the lunar month, those who reject the Mosaic recital will be at a loss, as Delambre remarks, to assign it to an origin having much semblance of probability. It might have been suggested by the phases of the moon, or by the number of the planets known in ancient times, an origin which is rendered more probable from the names universally given to the different days of which it is composed. In the Egyptian astronomy, the order of the planets, beginning with the most remote, is Saturn, Jupiter, Mars, the Sun, Venus, Mercury, the Moon. Now, the day being divided into twenty-four hours, each hour was consecrated to a particular planet, namely, one to Saturn, the following to Jupiter, the third to Mars, and so on according to the above order; and the day received the name of the planet which presided over its first hour. If, then, the first hour of a day was consecrated to Saturn, that planet would also have the 8th, the 15th, and the 22nd hour; the 23rd would fall to Jupiter, the 24th to Mars, and the 25th, or the first hour of the second day, would belong to the Sun. In like manner the first hour of the 3rd day would fall to the Moon, the first of the 4th day to Mars, of the 5th to Mercury, of the 6th to Jupiter, and of the 7th to Venus. The cycle being completed, the first hour of the 8th day would return to Saturn, and all the others succeed in the same order. According to Dio Cassius, the Egyptian week commenced with Saturday. On

their flight from Egypt, the Jews, from hatred to their ancient oppressors, made Saturday the last day of the week.

The English names of the days are derived from the Saxon. The ancient Saxons had borrowed the week from some Eastern nation, and substituted the names of their own divinities for those of the gods of Greece. In legislative and justiciary acts the Latin names are still retained.

Latin.	English.	Saxon.
Dies Solis.	Sunday.	Sun's day.
Dies Lunæ.	Monday.	Moon's day.
Dies Martis.	Tuesday.	Tiw's day.
Dies Mercurii.	Wednesday.	Woden's day.
Dies Jovis.	Thursday.	Thor's day.
Dies Veneris.	Friday.	Frigg's day.
Dies Saturni.	Saturday.	Seterne's day.

Month.—Long before the exact length of the year was determined, it must have been perceived that the synodic revolution of the moon is accomplished in about 29½ days. Twelve lunations, therefore, form a period of 354 days, which differs only by about 11½ days from the solar year. From this circumstance has arisen the practice, perhaps universal, of dividing the year into twelve months. But in the course of a few years the accumulated difference between the solar year and twelve lunar months would become considerable, and have the effect of transporting the commencement of the year to a different season. The difficulties that arose in attempting to avoid this inconvenience induced some nations to abandon the moon altogether, and regulate their year by the course of the sun. The month, however, being a convenient period of time, has retained its place in the calendars of all nations; but, instead of denoting a synodic revolution of the moon, it is usually employed to denote an arbitrary number of days approaching to the twelfth part of a solar year.

Among the ancient Egyptians the month consisted of thirty days invariably, and in order to complete the year, five days were added at the end, called supplementary days. They made use of no intercalation, and by losing a fourth of a day every year, the commencement of the year went back one day in every period of four years, and consequently made a revolution of the seasons in 1461 years. Hence 1461 Egyptian years are equal to 1460 Julian years of 365½ days each. This year is called *sepsc*, by reason of its commencing sometimes at one season of the year, and sometimes at another.

The Greeks divided the month into three decades, or periods of ten days,—a practice which was imitated by the French in their unsuccessful attempt to introduce a new calendar at the period of the Revolution. This division offers two advantages: the first is, that the period is an exact measure of the month of thirty days; and the second is, that the number of the day of the decade is connected with and suggests the number of the day of the month. For example, the 5th of the decade must necessarily be the 5th, the 15th, or the 25th of the month; so that when the day of the decade is known, that of the month can scarcely be mistaken. In reckoning by weeks, it is necessary to keep in mind the day of the week on which each month begins.

The Romans employed a division of the month and a method of reckoning the days which appear not a little extraordinary, and must, in practice, have been exceedingly inconvenient. As frequent allusion is made by classical writers to this embarrassing method of computation, which is carefully retained in the ecclesiastical calendar, we here give a table showing the correspondence of the Roman months with those of modern Europe.

Instead of distinguishing the days by the ordinal numbers first, second, third, &c., the Romans counted *backwards* from three fixed epochs, namely, the *Calends*, the *Nones*, and the *Ides*. The *Calends* (or *Kalends*) were invariably the first day of the month, and were so denominated because it had been an ancient custom of the pontiffs to call the people together on that day, to apprise them of the festivals, or days that were to be kept sacred during the month. The *Ides* (from an obsolete verb *idivare*, to divide) were at the middle of the month, either the 13th or the 15th day; and the *Nones* were the sixth day before the

Ides, counting inclusively. From these three terms the days received their denomination in the following manner:—Those which were comprised between the Calends and the Nones were called the *days before the Nones*; those between the Nones and the Ides were called the *days before the Ides*; and, lastly, all the days after the Ides to the end of the month were called the *days before the Calends* of the succeeding month. In the months of March, May, July and October, the Ides fell on the 15th day, and the Nones consequently on the 7th; so that each of these months had six days named from the Nones. In all the other months the Ides were on the 13th and the Nones on the 5th; consequently there were only four days named from the Nones. Every month had eight days named from the Ides. The number of days receiving their denomination from the Calends depended on the number of days in the month and the day on which the Ides fell. For example, if the month contained 31 days and the Ides fell on the 13th, as was the case in January, August and December, there would remain 18 days after the

Days of the Month.	March. May. July. October.	January. August. December.	April. June. September. November.	February.
1	Calendae.	Calendae.	Calendae.	Calendae.
2	6	4	4	4
3	5	3	3	3
4	4	Prid. Nonas.	Prid. Nonas.	Prid. Nonas.
5	3	Nonae.	Nonae.	Nonae.
6	Prid. Nonas.	8	8	8
7	Nonae.	7	7	7
8	8	6	6	6
9	7	5	5	5
10	6	4	4	4
11	5	3	3	3
12	4	Prid. Idus.	Prid. Idus.	Prid. Idus.
13	3	Idus.	Idus.	Idus.
14	Prid. Idus.	19	18	16
15	Idus.	18	17	15
16	17	17	16	14
17	16	16	15	13
18	15	15	14	12
19	14	14	13	11
20	13	13	12	10
21	12	12	11	9
22	11	11	10	8
23	10	10	9	7
24	9	9	8	6
25	8	8	7	5
26	7	7	6	4
27	6	6	5	3
28	5	5	4	Prid. Cal.
29	4	4	3	Mart.
30	3	3	2	
31	Prid. Calen.	Prid. Calen.	Prid. Calen.	

Ides, which, added to the first of the following month, made 19 days of Calends. In January, therefore, the 14th day of the month was called the *nineteenth before the Calends of February* (counting inclusively), the 15th was the 18th before the Calends and so on to the 30th, which was called the third before the Calend (*tertio Calendas*), the last being the second of the Calends, or the day before the Calends (*pridie Calendas*).

YEAR.—The year is either astronomical or civil. The solar astronomical year is the period of time in which the earth performs a revolution in its orbit about the sun, or passes from any point of the ecliptic to the same point again; and consists of 365 days 5 hours 48 min. and 46 sec. of mean solar time. The civil year is that which is employed in chronology, and varies among different nations, both in respect of the season at which it commences and of its subdivisions. When regard is had to the sun's motion alone, the regulation of the year, and the distribution of the days into months, may be effected without much trouble; but the difficulty is greatly increased when it is sought to reconcile solar and lunar periods, or to make the subdivisions of the year depend on the moon, and at the same time to preserve the correspondence between the whole year and the seasons.

Of the Solar Year.—In the arrangement of the civil year, two objects are sought to be accomplished,—first, the equable

distribution of the days among twelve months; and secondly, the preservation of the beginning of the year at the same distance from the solstices or equinoxes. Now, as the year consists of 365 days and a fraction, and 365 is a number not divisible by 12, it is impossible that the months can all be of the same length and at the same time include all the days of the year. By reason also of the fractional excess of the length of the year above 365 days, it likewise happens that the years cannot all contain the same number of days if the epoch of their commencement remains fixed; for the day and the civil year must necessarily be considered as beginning at the same instant; and therefore the extra hours cannot be included in the year till they have accumulated to a whole day. As soon as this has taken place, an additional day must be given to the year.

The civil calendar of all European countries has been borrowed from that of the Romans. Romulus is said to have divided the year into ten months only, including in all 304 days, and it is not very well known how the remaining days were disposed of. The ancient Roman year commenced with March, as is indicated by the names September, October, November, December, which the last four months still retain. July and August, likewise, were anciently denominated Quintilis and Sextilis, their present appellations having been bestowed in compliment to Julius Caesar and Augustus. In the reign of Numa two months were added to the year, January at the beginning and February at the end; and this arrangement continued till the year 452 B.C., when the Decemvirs changed the order of the months, and placed February after January. The months now consisted of twenty-nine and thirty days alternately, to correspond with the synodic revolution of the moon, so that the year contained 354 days; but a day was added to make the number odd, which was considered more fortunate, and the year therefore consisted of 355 days. This differed from the solar year by ten whole days and a fraction; but, to restore the coincidence, Numa ordered an additional or intercalary month to be inserted every second year between the 23rd and 24th of February, consisting of twenty-two and twenty-three days alternately, so that four years contained 1465 days, and the mean length of the year was consequently 366½ days. The additional month was called *Mercedivus* or *Mercedonius*, from *merces*, wages, probably because the wages of workmen and domestics were usually paid at this season of the year. According to the above arrangement, the year was too long by one day, which rendered another correction necessary. As the error amounted to twenty-four days in as many years, it was ordered that every third period of eight years, instead of containing four intercalary months, amounting in all to ninety days, should contain only three of those months, consisting of twenty-two days each. The mean length of the year was thus reduced to 365½ days; but it is not certain at what time the octennial periods, borrowed from the Greeks, were introduced into the Roman calendar, or whether they were at any time strictly followed. It does not even appear that the length of the intercalary month was regulated by any certain principle, for a discretionary power was left with the pontiffs, to whom the care of the calendar was committed, to intercalate more or fewer days according as the year was found to differ more or less from the celestial motions. This power was quickly abused to serve political objects, and the calendar consequently thrown into confusion. By giving a greater or less number of days to the intercalary month, the pontiffs were enabled to prolong the term of a magistracy or hasten the annual elections; and so little care had been taken to regulate the year, that, at the time of Julius Caesar, the civil equinox differed from the astronomical by three months, so that the winter months were carried back into autumn and the autumnal into summer.

In order to put an end to the disorders arising from the negligence or ignorance of the pontiffs, Caesar abolished the use of the lunar year and the intercalary month, and regulated the civil year entirely by the sun. With the advice and assistance of Sosigenes, he fixed the mean length of the year at 365½ days, and decreed that every fourth year should have 366 days, the

other years having each 365. In order to restore the vernal equinox to the 25th of March, the place it occupied in the time of Numa, he ordered two extraordinary months to be inserted between November and December in the current year, the first to consist of thirty-three, and the second of thirty-four days. The intercalary month of twenty-three days fell into the year of course, so that the ancient year of 355 days received an augmentation of ninety days; and the year on that occasion contained in all 445 days. This was called the last year of confusion. The first Julian year commenced with the 1st of January of the 46th before the birth of Christ, and the 708th from the foundation of the city.

In the distribution of the days through the several months, Caesar adopted a simpler and more commodious arrangement than that which has since prevailed. He had ordered that the first, third, fifth, seventh, ninth and eleventh months, that is January, March, May, July, September and November, should have each thirty-one days, and the other months thirty, excepting February, which in common years should have only twenty-nine, but every fourth year thirty days. This order was interrupted to gratify the vanity of Augustus, by giving the month bearing his name as many days as July, which was named after the first Caesar. A day was accordingly taken from February and given to August; and in order that three months of thirty-one days might not come together, September and November were reduced to thirty days, and thirty-one given to October and December. For so frivolous a reason was the regulation of Caesar abandoned, and a capricious arrangement introduced, which it requires some attention to remember.

The additional day which occurred every fourth year was given to February, as being the shortest month, and was inserted in the calendar between the 24th and 25th day. February having then twenty-nine days, the 25th was the 6th of the calends of March, *sexto calendas*; the preceding, which was the additional or intercalary day, was called *bis-sexto calendas*,—hence the term *bissexstille*, which is still employed to distinguish the year of 366 days. The English denomination of *leap-year* would have been more appropriate if that year had differed from common years in defect, and contained only 364 days. In the modern calendar the intercalary day is still added to February, not, however, between the 24th and 25th, but as the 29th.

The regulations of Caesar were not at first sufficiently understood; and the pontiffs, by intercalating every third year instead of every fourth, at the end of thirty-six years had intercalated twelve times, instead of nine. This mistake having been discovered, Augustus ordered that all the years from the thirty-seventh of the era to the forty-eighth inclusive should be common years, by which means the intercalations were reduced to the proper number of twelve in forty-eight years. No account is taken of this blunder in chronology; and it is tacitly supposed that the calendar has been correctly followed from its commencement.

Although the Julian method of intercalation is perhaps the most convenient that could be adopted, yet, as it supposes the year too long by 11 minutes 14 seconds, it could not without correction very long answer the purpose for which it was devised, namely, that of preserving always the same interval of time between the commencement of the year and the equinox. Sosigenes could scarcely fail to know that this year was too long; for it had been shown long before, by the observations of Hipparchus, that the excess of 365½ days above a true solar year would amount to a day in 300 years. The real error is indeed more than double of this, and amounts to a day in 128 years, but in the time of Caesar the length of the year was an astronomical element not very well determined. In the course of a few centuries, however, the equinox sensibly retrograded towards the beginning of the year. When the Julian calendar was introduced, the equinox fell on the 25th of March. At the time of the council of Nice, which was held in 325, it fell on the 21st; and when the reformation of the calendar was made in 1582, it had retrograded to the 11th. In order to restore the equinox to its former place, Pope Gregory XIII. directed ten days to be

suppressed in the calendar; and as the error of the Julian intercalation was now found to amount to three days in 400 years, he ordered the intercalations to be omitted on all the centenary years excepting those which are multiples of 400. According to the Gregorian rule of intercalation, therefore, every year of which the number is divisible by four without a remainder is a leap year, excepting the centenary years, which are only leap years when divisible by four after omitting the two ciphers. Thus 1600 was a leap year, but 1700, 1800 and 1900 are common years; 2000 will be a leap year, and so on.

As the Gregorian method of intercalation has been adopted in all Christian countries, Russia excepted, it becomes interesting to examine with what degrees of accuracy it reconciles the civil with the solar year. According to the best determinations of modern astronomy (Le Verrier's *Solar Tables*, Paris, 1858, p. 102), the mean geocentric motion of the sun in longitude, from the mean equinox during a Julian year of 365.25 days, the same being brought up to the present date, is $360^{\circ} + 27^{\circ}.685$. Thus the mean length of the solar year is found to be $\frac{360^{\circ}}{360^{\circ} + 27^{\circ}.685} \times 365.25 = 365.2422$ days, or 365 days 5 hours 48 min. 46 sec. Now the Gregorian rule gives 97 intercalations in 400 years; 400 years therefore contain $365 \times 400 + 97$, that is, 146,097 days; and consequently one year contains 365.2425 days, or 365 days 5 hours 49 min. 12 sec. This exceeds the true solar year by 26 seconds, which amount to a day in 3373 years. It is perhaps unnecessary to make any formal provision against an error which can only happen after so long a period of time; but as 3373 differs little from 4000, it has been proposed to correct the Gregorian rule by making the year 4000 and all its multiples common years. With this correction the rule of intercalation is as follows:—

Every year the number of which is divisible by 4 is a leap year, excepting the last year of each century, which is a leap year only when the number of the century is divisible by 4; but 4000, and its multiples, 8000, 12,000, 16,000, &c. are common years. Thus the uniformity of the intercalation, by continuing to depend on the number four, is preserved, and by adopting the last correction the commencement of the year would not vary more than a day from its present place in two hundred centuries.

In order to discover whether the coincidence of the civil and solar year could not be restored in shorter periods by a different method of intercalation, we may proceed as follows:—The fraction 0.2422, which expresses the excess of the solar year above a whole number of days, being converted into a continued fraction, becomes

$$\frac{1}{4 + \frac{1}{7 + \frac{1}{1 + \frac{1}{3 + \frac{1}{4 + \frac{1}{1 + \text{&c.}}}}}}}$$

which gives the series of approximating fractions,

$$\frac{1}{4}, \frac{7}{29}, \frac{8}{33}, \frac{31}{128}, \frac{132}{545}, \frac{163}{673}, \text{&c.}$$

The first of these, $\frac{1}{4}$, gives the Julian intercalation of one day in four years, and is considerably too great. It supposes the year to contain 365 days 6 hours.

The second, $\frac{7}{29}$, gives seven intercalary days in twenty-nine years, and errs in defect, as it supposes a year of 365 days 5 hours 47 min. 35 sec.

The third, $\frac{8}{33}$, gives eight intercalations in thirty-three years or seven successive intercalations at the end of four years respectively, and the eighth at the end of five years. This supposes the year to contain 365 days 5 hours 49 min. 545 sec.

The fourth fraction, $\frac{31}{128} = \frac{24 + 7}{97 + 29} = \frac{3 \times 8 + 7}{3 \times 33 + 29}$, combines three periods of thirty-three years with one of twenty-nine, and would consequently be very convenient in application. It supposes the year to consist of 365 days 5 hours 48 min. 45 sec., and is practically exact.

The fraction $\frac{8}{33}$ offers a convenient and very accurate method of intercalation. It implies a year differing in excess from the true year only by 19.45 sec., while the Gregorian year is too long by 26 sec. It produces a much nearer coincidence between the civil and solar years than the Gregorian method; and, by reason of its shortness of period, confines the evagations of the mean equinox from the true within much narrower limits. It has been stated by Scaliger, Weidler, Montucla, and others, that the modern Persians actually follow this method, and intercalate eight days in thirty-three

years. The statement has, however, been contested on good authority; and it seems proved (see Delambre, *Astronomie Moderne*, tom. i. p. 81) that the Persian intercalation combines the two periods $\frac{7}{29}$ and $\frac{8}{33}$. If they follow the combination $\frac{7+3 \times 8}{29+3 \times 33} = \frac{31}{128}$, their determination of the length of the tropical year has been extremely exact. The discovery of the period of thirty-three years is ascribed to Omar Khayyam, one of the eight astronomers appointed by Jellal ud-Din Malik Shah, sultan of Khorasan, to reform or construct a calendar, about the year 1079 of our era.

If the commencement of the year, instead of being retained at the same place in the seasons by a uniform method of intercalation, were made to depend on astronomical phenomena, the intercalations would succeed each other in an irregular manner, sometimes after four years and sometimes after five; and it would occasionally, though rarely indeed, happen, that it would be impossible to determine the day on which the year ought to begin. In the calendar, for example, which was attempted to be introduced in France in 1793, the beginning of the year was fixed at midnight preceding the day in which the true autumnal equinox falls. But supposing the instant of the sun's entering into the sign Libra to be very near midnight, the small errors of the solar tables might render it doubtful to which day the equinox really belonged; and it would be in vain to have recourse to observation to obviate the difficulty. It is therefore infinitely more commodious to determine the commencement of the year by a fixed rule of intercalation; and of the various methods which might be employed, no one, perhaps is on the whole more easy of application, or better adapted for the purpose of computation, than the Gregorian now in use. But a system of 31 intercalations in 128 years would be by far the most perfect as regards mathematical accuracy. Its adoption upon our present Gregorian calendar would only require the suppression of the usual bissextile once in every 128 years, and there would be no necessity for any further correction, as the error is so insignificant that it would not amount to a day in 100,000 years.

Of the Lunar Year and Luni-solar Periods.—The lunar year, consisting of twelve lunar months, contains only 354 days; its commencement consequently anticipates that of the solar year by eleven days, and passes through the whole circle of the seasons in about thirty-four lunar years. It is therefore so obviously ill-adapted to the computation of time, that, excepting the modern Jews and Mahomedans, almost all nations who have regulated their months by the moon have employed some method of intercalation by means of which the beginning of the year is retained at nearly the same fixed place in the seasons.

In the early ages of Greece the year was regulated entirely by the moon. Solon divided the year into twelve months, consisting alternately of twenty-nine and thirty days, the former of which were called *deficient* months, and the latter *full* months. The lunar year, therefore, contained 354 days, falling short of the exact time of twelve lunations by about 8-8 hours. The first expedient adopted to reconcile the lunar and solar years seems to have been the addition of a month of thirty days to every second year. Two lunar years would thus contain 25 months, or 738 days, while two solar years, of 365½ days each, contain 730½ days. The difference of 7½ days was still too great to escape observation; it was accordingly proposed by Cleostratus of Tenedos, who flourished shortly after the time of Thales, to omit the biennial intercalation every eighth year. In fact, the 7½ days by which two lunar years exceeded two solar years, amounted to thirty days, or a full month, in eight years. By inserting, therefore, three additional months instead of four in every period of eight years, the coincidence between the solar and lunar year would have been exactly restored if the latter had contained only 354 days, inasmuch as the period contains $354 \times 8 + 3 \times 30 = 2922$ days, corresponding with eight solar years of 365½ days each. But the true time of 99 lunations is 2923-528 days, which exceeds the above period by 1-528 days, or thirty-six hours and a few minutes. At the end of two periods, or sixteen years, the excess is three days, and at the end of 160 years, thirty days. It was therefore proposed to employ a period of 160 years, in which one of the intercalary months should be omitted; but as this period was too long to be of any practical use, it was never generally adopted. The common practice was to make occasional corrections as they became necessary, in order to preserve the relation between the octennial period and the state of the heavens; but these corrections being left to the care of incompetent persons, the calendar soon fell into great

disorder, and no certain rule was followed till a new division of the year was proposed by Meton and Euctemon, which was immediately adopted in all the states and dependencies of Greece.

The mean motion of the moon in longitude, from the mean equinox, during a Julian year of 365-25 days (according to Hansen's *Tables de la Lune*, London, 1857, pages 15, 16) is, at the present date, $13 \times 360^\circ + 477644'' \cdot 409$; that of the sun being $360^\circ + 27'' \cdot 685$. Thus the corresponding relative mean geocentric motion of the moon from the sun is $12 \times 360^\circ + 477616'' \cdot 724$; and the duration of the mean synodic revolution of the moon, or lunar month, is therefore $\frac{360^\circ}{12 \times 360^\circ + 477616'' \cdot 724} \times 365 \cdot 25 = 29 \cdot 530588$ days, or 29 days, 12 hours, 44 min. 2-8 sec.

The *Metonic Cycle*, which may be regarded as the *chef-d'œuvre* of ancient astronomy, is a period of nineteen solar years, after which the new moons again happen on the same days of the year. In nineteen solar years there are 235 lunations, a number which, on being divided by nineteen, gives twelve lunations for each year, with seven of a remainder, to be distributed among the years of the period. The period of Meton, therefore, consisted of twelve years containing twelve months each, and seven years containing thirteen months each; and these last formed the third, fifth, eighth, eleventh, thirteenth, sixteenth, and nineteenth years of the cycle. As it had now been discovered that the exact length of the lunation is a little more than twenty-nine and a half days, it became necessary to abandon the alternate succession of full and deficient months; and, in order to preserve a more accurate correspondence between the civil month and the lunation, Meton divided the cycle into 125 full months of thirty days, and 110 deficient months of twenty-nine days each. The number of days in the period was therefore 6940. In order to distribute the deficient months through the period in the most equable manner, the whole period may be regarded as consisting of 235 full months of thirty days, or of 7050 days, from which 110 days are to be deducted. This gives one day to be suppressed in sixty-four; so that if we suppose the months to contain each thirty days, and then omit every sixty-fourth day in reckoning from the beginning of the period, those months in which the omission takes place will, of course, be the deficient months.

The number of days in the period being known, it is easy to ascertain its accuracy both in respect of the solar and lunar motions. The exact length of nineteen solar years is $19 \times 365 \cdot 2422 = 6939 \cdot 6018$ days, or 6939 days 14 hours 26-592 minutes; hence the period, which is exactly 6940 days, exceeds nineteen revolutions of the sun by nine and a half hours nearly. On the other hand, the exact time of a synodic revolution of the moon is 29-530588 days; 235 lunations, therefore, contain $235 \times 29 \cdot 530588 = 6939 \cdot 68818$ days, or 6939 days 16 hours 31 minutes, so that the period exceeds 235 lunations by only seven and a half hours.

After the Metonic cycle had been in use about a century, a correction was proposed by Calippus. At the end of four cycles, or seventy-six years, the accumulation of the seven and a half hours of difference between the cycle and 235 lunations amounts to thirty hours, or one whole day and six hours. Calippus, therefore, proposed to quadruple the period of Meton, and deduct one day at the end of that time by changing one of the full months into a deficient month. The period of Calippus, therefore, consisted of three Metonic cycles of 6940 days each, and a period of 6939 days; and its error in respect of the moon, consequently, amounted only to six hours, or to one day in 304 years. This period exceeds seventy-six true solar years by fourteen hours and a quarter nearly, but coincides exactly with seventy-six Julian years; and in the time of Calippus the length of the solar year was almost universally supposed to be exactly 365½ days. The Calippic period is frequently referred to as a date by Ptolemy.

Ecclesiastical Calendar.—The ecclesiastical calendar, which is adopted in all the Catholic, and most of the Protestant countries of Europe, is luni-solar, being regulated partly by the solar, and partly by the lunar year,—a circumstance which gives rise to the

distinction between the movable and immovable feasts. So early as the 2nd century of our era, great disputes had arisen among the Christians respecting the proper time of celebrating Easter, which governs all the other movable feasts. The Jews celebrated their passover on the 14th day of the first month, that is to say, the lunar month of which the fourteenth day either falls on, or next follows, the day of the vernal equinox. Most Christian sects agreed that Easter should be celebrated on a Sunday. Others followed the example of the Jews, and adhered to the 14th of the moon; but these, as usually happened to the minority, were accounted heretics, and received the appellation of Quartodecimans. In order to terminate dissensions, which produced both scandal and schism in the church, the council of Nicaea, which was held in the year 325, ordained that the celebration of Easter should thenceforth always take place on the Sunday which immediately follows the full moon that happens upon, or next after, the day of the vernal equinox. Should the 14th of the moon, which is regarded as the day of full moon, happen on a Sunday, the celebration of Easter was deferred to the Sunday following, in order to avoid concurrence with the Jews and the above-mentioned heretics. The observance of this rule renders it necessary to reconcile three periods which have no common measure, namely, the week, the lunar month, and the solar year; and as this can only be done approximately, and within certain limits, the determination of Easter is an affair of considerable nicety and complication. It is to be regretted that the reverend fathers who formed the council of Nicaea did not abandon the moon altogether, and appoint the first or second Sunday of April for the celebration of the Easter festival. The ecclesiastical calendar would in that case have possessed all the simplicity and uniformity of the civil calendar, which only requires the adjustment of the civil to the solar year; but they were probably not sufficiently versed in astronomy to be aware of the practical difficulties which their regulation had to encounter.

Dominical Letter.—The first problem which the construction of the calendar presents is to connect the week with the year, or to find the day of the week corresponding to a given day of any year of the era. As the number of days in the week and the number in the year are prime to one another, two successive years cannot begin with the same day; for if a common year begins, for example, with Sunday, the following year will begin with Monday, and if a leap year begins with Sunday, the year following will begin with Tuesday. For the sake of greater generality, the days of the week are denoted by the first seven letters of the alphabet, A, B, C, D, E, F, G, which are placed in the calendar beside the days of the year, so that A stands opposite the first day of January, B opposite the second, and so on to G, which stands opposite the seventh; after which A returns to the eighth, and so on through the 365 days of the year. Now if one of the days of the week, Sunday for example, is represented by E, Monday will be represented by F, Tuesday by G, Wednesday by A, and so on; and every Sunday through the year will have the same character E, every Monday F, and so with regard to the rest. The letter which denotes Sunday is called the *Dominical Letter*, or the *Sunday Letter*; and when the dominical letter of the year is known, the letters which respectively correspond to the other days of the week become known at the same time.

Solar Cycle.—In the Julian calendar the dominical letters are readily found by means of a short cycle, in which they recur in the same order without interruption. The number of years in the intercalary period being four, and the days of the week being seven, their product is $4 \times 7 = 28$; twenty-eight years is therefore a period which includes all the possible combinations of the days of the week with the commencement of the year. This period is called the *Solar Cycle*, or the *Cycle of the Sun*, and restores the first day of the year to the same day of the week. At the end of the cycle the dominical letters return again in the same order on the same days of the month; hence a table of dominical letters, constructed for twenty-eight years, will serve to show the dominical letter of any given year from the com-

mencement of the era to the Reformation. The cycle, though probably not invented before the time of the council of Nicaea, is regarded as having commenced nine years before the era, so that the year *one* was the tenth of the solar cycle. To find the year of the cycle, we have therefore the following rule:—Add nine to the date, divide the sum by twenty-eight; the quotient is the number of cycles elapsed, and the remainder is the year of the cycle. Should there be no remainder, the proposed year is the twenty-eighth or last of the cycle. This rule is conveniently expressed

by the formula $\left(\frac{x+9}{28}\right)r$, in which x denotes the date, and the symbol r denotes that the remainder, which arises from the division of $x+9$ by 28, is the number required. Thus, for 1840, we have $\frac{1840+9}{28} = 66\frac{1}{7}$; therefore $\left(\frac{1840+9}{28}\right)r = 1$, and the year

1840 is the first of the solar cycle. In order to make use of the solar cycle in finding the dominical letter, it is necessary to know that the first year of the Christian era began with Saturday. The dominical letter of that year, which was the tenth of the cycle, was consequently B. The following year, or the 11th of the cycle, the letter was A; then G. The fourth year was bissextile, and the dominical letters were F, E; the following year D, and so on. In this manner it is easy to find the dominical letter belonging to each of the twenty-eight years of the cycle. But at the end of a century the order is interrupted in the Gregorian calendar by the secular suppression of the leap year; hence the cycle can only be employed during a century. In the reformed calendar the intercalary period is four hundred years, which number being multiplied by seven, gives two thousand eight hundred years as the interval in which the coincidence is restored between the days of the year and the days of the week. This long period, however, may be reduced to four hundred years; for since the dominical letter goes back five places every four years, its variation in four hundred years, in the Julian calendar, was five hundred places, which is equivalent to only three places (for five hundred divided by seven leaves three); but the Gregorian calendar suppresses exactly three intercalations in four hundred years, so that after four hundred years the dominical letters must again return in the same order.

Hence the following table of dominical letters for four hundred years will serve to show the dominical letter of any year in the Gregorian calendar for ever. It contains four columns of letters, each column serving for a century. In order to find the column from which the letter in any given case is to be taken, strike off the last two figures of the date, divide the preceding figures by four, and the remainder will indicate the column. The symbol X, employed in the formula at the top of the column, denotes the number of centuries, that is, the figures remaining after the last two have been struck off. For example, required the dominical letter of the year 1839? In this case $X = 18$, therefore $\left(\frac{X}{4}\right)r = 2$; and in the second column of letters, opposite 39, in the table we find F, which is the letter of the proposed year.

It deserves to be remarked, that as the dominical letter of the first year of the era was B, the first column of the following table will give the dominical letter of every year from the commencement of the era to the Reformation. For this purpose divide the date by 28, and the letter opposite the remainder, in the first column of figures, is the dominical letter of the year. For example, supposing the date to be 1148. On dividing by 28, the remainder is 0, or 28; and opposite 28, in the first column of letters, we find D, C, the dominical letters of the year 1148.

Lunar Cycle and Golden Number.—In connecting the lunar month with the solar year, the framers of the ecclesiastical calendar adopted the period of Meton, or lunar cycle, which they supposed to be exact. A different arrangement has, however, been followed with respect to the distribution of the months. The lunations are supposed to consist of twenty-nine and thirty days alternately, or the lunar year of 354 days; and in order to make up nineteen solar years, six embolismic or intercalary months, of thirty days each, are introduced in the course of the cycle, and one of twenty-nine days is added at the

end. This gives $19 \times 354 + 6 \times 30 + 19 = 6935$ days, to be distributed among 235 lunar months. But every leap year one day must be added to the lunar month in which the 29th of February is included. Now if leap year happens on the first, second or third year of the period, there will be five leap years in the period, but only four when the first leap year falls on the fourth. In the former case the number of days in the period becomes 6940 and in the latter 6939. The mean length of the cycle is

TABLE I.—*Domical Letters.*

Years of the Century.	$(\frac{x}{4})_r = 1$	$(\frac{x}{4})_r = 2$	$(\frac{x}{4})_r = 3$	$(\frac{x}{4})_r = 0$
0	C	E	G	B, A
1 29 57 85	B	D	F	G
2 30 58 86	A	C	E	F
3 31 59 87	G	B	D	E
4 32 60 88	F, E	A, G	C, B	D, C
5 33 61 89	D	F	A	B
6 34 62 90	C	E	G	A
7 35 63 91	B	D	F	G
8 36 64 92	A, G	C, B	E, D	F, E
9 37 65 93	F	A	C	D
10 38 66 94	E	G	B	C
11 39 67 95	D	F	A	B
12 40 68 96	C, B	E, D	G, F	A, G
13 41 69 97	A	C	E	F
14 42 70 98	G	B	D	E
15 43 71 99	F	A	C	D
16 44 72	E, D	G, F	B, A	C, B
17 45 73	C	E	G	A
18 46 74	B	D	F	G
19 47 75	A	C	E	F
20 48 76	G, F	B, A	D, C	E, D
21 49 77	E	G	A	C
22 50 78	D	F	B	B
23 51 79	C	E	A	A
24 52 80	B, A	D, C	F, E	G, F
25 53 81	G	B	D	E
26 54 82	F	A	C	D
27 55 83	E	G	B	C
28 56 84	D, C	F, E	A, G	B, A

TABLE II.—*The Day of the Week.*

Month.		Domical Letter.									
Jan.	Oct.	A	B	C	D	E	F	G			
Feb.	Mar.	D	E	F	G	A	B	C			
April	July	G	A	B	C	D	E	F			
May		B	C	D	E	F	G	A			
June		E	F	G	A	B	C	D			
August		C	D	E	F	G	A	B			
Sept.	Dec.	F	G	A	B	C	D	E			
1	8	15	22	29	Sun.	Sat.	Frid.	Thur.	Wed.	Tues.	Mon.
2	9	16	23	30	Mon.	Sun.	Sat.	Frid.	Thur.	Wed.	Tues.
3	10	17	24	31	Tues.	Mon.	Sun.	Sat.	Frid.	Thur.	Wed.
4	11	18	25		Wed.	Tues.	Mon.	Sun.	Sat.	Frid.	Thur.
5	12	19	26		Thur.	Wed.	Tues.	Mon.	Sun.	Sat.	Frid.
6	13	20	27		Frid.	Thur.	Wed.	Tues.	Mon.	Sun.	Sat.
7	14	21	28		Sat.	Frid.	Thur.	Wed.	Tues.	Mon.	Sun.

therefore 6939½ days, agreeing exactly with nineteen Julian years.

By means of the lunar cycle the new moons of the calendar were indicated before the Reformation. As the cycle restores these phenomena to the same days of the civil month, they will fall on the same days in any two years which occupy the same place in the cycle; consequently a table of the moon's phases for 19 years will serve for any year whatever when we know its number in the cycle. This number is called the *Golden Number*, either because

it was so termed by the Greeks, or because it was usual to mark it with red letters in the calendar. The Golden Numbers were introduced into the calendar about the year 530, but disposed as they would have been if they had been inserted at the time of the council of Nicaea. The cycle is supposed to commence with the year in which the new moon falls on the 1st of January, which took place the year preceding the commencement of our era. Hence, to find the Golden Number N, for any year x, we have $N = (\frac{x+1}{19})_r$, which gives the following rule: *Add 1 to the date, divide the sum by 19; the quotient is the number of cycles elapsed, and the remainder is the Golden Number.* When the remainder is 0, the proposed year is of course the last or 19th of the cycle. It ought to be remarked that the new moons, determined in this manner, may differ from the astronomical new moons sometimes as much as two days. The reason is that the sum of the solar and lunar inequalities, which are compensated in the whole period, may amount in certain cases to 10°, and thereby cause the new moon to arrive on the second day before or after its mean time.

Dionysian Period.—The cycle of the sun brings back the days of the month to the same day of the week; the lunar cycle restores the new moons to the same day of the month; therefore $28 \times 19 = 532$ years, includes all the variations in respect of the new moons and the domical letters, and is consequently a period after which the new moons again occur on the same day of the month and the same day of the week. This is called the *Dionysian* or *Great Paschal Period*, from its having been employed by Dionysius Exiguus, familiarly styled "Denys the Little," in determining Easter Sunday. It was, however, first proposed by Victorius of Aquitain, who had been appointed by Pope Hilary to revise and correct the church calendar. Hence it is also called the *Victorian Period*. It continued in use till the Gregorian reformation.

Cycle of Indiction.—Besides the solar and lunar cycles, there is a third of 15 years, called the cycle of indiction, frequently employed in the computations of chronologists. This period is not astronomical, like the two former, but has reference to certain judicial acts which took place at stated epochs under the Greek emperors. Its commencement is referred to the 1st of January of the year 313 of the common era. By extending it backwards, it will be found that the first of the era was the fourth of the cycle of indiction. The number of any year in this cycle

will therefore be given by the formula $(\frac{x+3}{15})_r$, that is to say, *add 3 to the date, divide the sum by 15, and the remainder is the year of the indiction.* When the remainder is 0, the proposed year is the fifteenth of the cycle.

Julian Period.—The Julian period, proposed by the celebrated Joseph Scaliger as an universal measure of chronology, is formed by taking the continued product of the three cycles of the sun, of the moon, and of the indiction, and is consequently $28 \times 19 \times 15 = 7980$ years. In the course of this long period no two years can be expressed by the same numbers in all the three cycles. Hence, when the number of any proposed year in each of the cycles is known, its number in the Julian period can be determined by the resolution of a very simple problem of the indeterminate analysis. It is unnecessary, however, in the present case to exhibit the general solution of

the problem, because when the number in the period corresponding to any one year in the era has been ascertained, it is easy to establish the correspondence for all other years, without having again recourse to the direct solution of the problem. We shall therefore find the number of the Julian period corresponding to the first of our era.

We have already seen that the year 1 of the era had 10 for its number in the solar cycle, 2 in the lunar cycle, and 4 in the cycle of indiction; the question is therefore to find a number such, that

when it is divided by the three numbers 28, 19, and 15 respectively the three remainders shall be 10, 2, and 4.

Let x , y , and z be the three quotients of the divisions; the number sought will then be expressed by $28x+10$, by $19y+2$, or by $15z+4$. Hence the two equations

$$28x+10=19y+2=15z+4.$$

To solve the equations $28x+10=19y+2$, or $y=x+\frac{9x+8}{19}$, let $m=\frac{9x+8}{19}$, we have then $z=2m+\frac{m-8}{9}$.

Let $\frac{m-8}{9}=m'$; then $m=9m'+8$; hence

$$x=18m'+16+m'=19m'+16.....(1).$$

Again, since $28x+10=15z+4$, we have

$$15z=28x+6, \text{ or } z=2x+\frac{2x-6}{15}.$$

Let $\frac{2x-6}{15}=n$; then $2x=15n+6$, and $x=7n+3+\frac{n}{2}$.

Let $\frac{n}{2}=n'$; then $n=2n'$; consequently

$$x=14n'+3+n'=15n'+3.....(2).$$

Equating the above two values of x , we have

$$15n'+3=19m'+16; \text{ whence } n'=m'+\frac{4m'+13}{15}.$$

Let $\frac{4m'+13}{15}=p$; we have then

$$4m'=15p-13, \text{ and } m'=4p-\frac{p+13}{4}.$$

Let $\frac{p+13}{4}=p'$; then $p=4p'-13$;

$$\text{whence } m'=16p'-52-p'=15p'-52.$$

Now in this equation p' may be any number whatever, provided $15p'$ exceed 52. The smallest value of p' (which is the one here wanted) is therefore 4; for $15 \times 4 = 60$. Assuming therefore $p' = 4$, we have $m' = 60 - 52 = 8$; and consequently, since $x = 19m' + 16$, $x = 19 \times 8 + 16 = 168$. The number required is consequently $28 \times 168 + 10 = 4714$.

Having found the number 4714 for the first of the era, the correspondence of the years of the era and of the period is as follows:—

Era,	1,	2,	3,...	x ,
Period,	4714,	4715,	4716,...	4713+ x ;

from which it is evident, that if we take P to represent the year of the Julian period, and x the corresponding year of the Christian era, we shall have

$$P = 4713 + x, \text{ and } x = P - 4713.$$

With regard to the numeration of the years previous to the commencement of the era, the practice is not uniform. Chronologists, in general, reckon the year preceding the first of the era -1 , the next preceding -2 , and so on. In this case

Era,	-1,	-2,	-3,...	$-x$,
Period,	4713,	4712,	4711,...	4714- x ;

whence

$$P = 4714 - x, \text{ and } x = 4714 - P.$$

But astronomers, in order to preserve the uniformity of computation, make the series of years proceed without interruption, and reckon the year preceding the first of the era 0. Thus

Era,	0,	-1,	-2,...	$-x$,
Period,	4713,	4712,	4711,...	4713- x ;

therefore, in this case

$$P = 4713 - x, \text{ and } x = 4713 - P.$$

Reformation of the Calendar.—The ancient church calendar was founded on two suppositions, both erroneous, namely, that the year contains 365½ days, and that 235 lunations are exactly equal to nineteen solar years. It could not therefore long continue to preserve its correspondence with the seasons, or to indicate the days of the new moons with the same accuracy. About the year 730 the venerable Bede had already perceived the anticipation of the equinoxes, and remarked that these phenomena then took place about three days earlier than at the time of the council of Nicaea. Five centuries after the time of Bede, the divergence of the true equinox from the 21st of March, which now amounted to seven or eight days, was pointed out by Johannes de Sacro Bosco (John Holywood, *f.* 1230) in his *De Anni Ratione*; and by Roger Bacon, in a treatise *De Reformatione Calendarii*, which, though never published, was transmitted to the pope. These works were probably little regarded at the time; but as the errors of the calendar went on increasing, and the true length of the year, in consequence of the progress of astronomy, became better known, the project of a reformation was again revived in the 15th century; and in 1474 Pope Sixtus IV. invited Regiomontanus,

the most celebrated astronomer of the age, to Rome, to superintend the reconstruction of the calendar. The premature death of Regiomontanus caused the design to be suspended for the time; but in the following century numerous memoirs appeared on the subject, among the authors of which were Stöffler, Albert Pighius, Johann Schöner, Lucas Gauricus, and other mathematicians of celebrity. At length Pope Gregory XIII. perceiving that the measure was likely to confer a great *décal* on his pontificate, undertook the long-desired reformation; and having found the governments of the principal Catholic states ready to adopt his views, he issued a brief in the month of March 1582, in which he abolished the use of the ancient calendar, and substituted that which has since been received in almost all Christian countries under the name of the *Gregorian Calendar* or *New Style*. The author of the system adopted by Gregory was Aloysius Lilius, or Luigi Lilio Ghiraldi, a learned astronomer and physician of Naples, who died, however, before its introduction; but the individual who most contributed to give the ecclesiastical calendar its present form, and who was charged with all the calculations necessary for its verification, was Clavius, by whom it was completely developed and explained in a great folio treatise of 800 pages, published in 1603, the title of which is given at the end of this article.

It has already been mentioned that the error of the Julian year was corrected in the Gregorian calendar by the suppression of three intercalations in 400 years. In order to restore the beginning of the year to the same place in the seasons that it had occupied at the time of the council of Nicaea, Gregory directed the day following the feast of St Francis, that is to say the 5th of October, to be reckoned the 15th of that month. By this regulation the vernal equinox which then happened on the 11th of March was restored to the 21st. From 1582 to 1700 the difference between the old and new style continued to be ten days; but 1700 being a leap year in the Julian calendar, and a common year in the Gregorian, the difference of the styles during the 18th century was eleven days. The year 1800 was also common in the new calendar, and, consequently, the difference in the 19th century was twelve days. From 1900 to 2100 inclusive it is thirteen days.

The restoration of the equinox to its former place in the year and the correction of the intercalary period, were attended with no difficulty; but Lilius had also to adapt the lunar year to the new rule of intercalation. The lunar cycle contained 6939 days 18 hours, whereas the exact time of 235 lunations, as we have already seen, is $235 \times 29.530888 = 6939$ days 16 hours 31 minutes. The difference, which is 1 hour 29 minutes, amounts to a day in 308 years, so that at the end of this time the new moons occur one day earlier than they are indicated by the golden numbers. During the 1257 years that elapsed between the council of Nicaea and the Reformation, the error had accumulated to four days, so that the new moons which were marked in the calendar as happening, for example, on the 5th of the month, actually fell on the 1st. It would have been easy to correct this error by placing the golden numbers four lines higher in the new calendar; and the suppression of the ten days had already rendered it necessary to place them ten lines lower, and to carry those which belonged, for example, to the 5th and 6th of the month, to the 15th and 16th. But, supposing this correction to have been made, it would have again become necessary, at the end of 308 years, to advance them one line higher, in consequence of the accumulation of the error of the cycle to a whole day. On the other hand, as the golden numbers were only adapted to the Julian calendar, every omission of the centenary intercalation would require them to be placed one line lower, opposite the 6th, for example, instead of the 5th of the month; so that, generally speaking, the places of the golden numbers would have to be changed every century. On this account Lilius thought fit to reject the golden numbers from the calendar, and supply their place by another set of numbers called *Epacts*, the use of which we shall now proceed to explain.

Epacts.—Epact is a word of Greek origin, employed in the calendar to signify the moon's age at the beginning of the year.

The common solar year containing 365 days, and the lunar year only 354 days, the difference is eleven; whence, if a new moon fall on the 1st of January in any year, the moon will be eleven days old on the first day of the following year, and twenty-two days on the first of the third year. The numbers eleven and twenty-two are therefore the epacts of those years respectively. Another addition of eleven gives thirty-three for the epact of the fourth year; but in consequence of the insertion of the intercalary month in each third year of the lunar cycle, this epact is reduced to three. In like manner the epacts of all the following years of the cycle are obtained by successively adding eleven to the epact of the former year, and rejecting thirty as often as the sum exceeds that number. They are therefore connected with the golden numbers by the formula $\left(\frac{11n}{30}\right)$, in which n is any whole number; and for a whole lunar cycle (supposing the first epact to be 11), they are as follows:—11, 22, 3, 14, 25, 6, 17, 28, 9, 20, 1, 12, 23, 4, 15, 26, 7, 18, 29. But the order is interrupted at the end of the cycle; for the epact of the following year, found in the same manner, would be $29+11=40$ or 10, whereas it ought again to be 11 to correspond with the moon's age and the golden number 1. The reason of this is, that the intercalary month, inserted at the end of the cycle, contains only twenty-nine days instead of thirty; whence, after 11 has been added to the epact of the year corresponding to the golden number 10, we must reject twenty-nine instead of thirty, in order to have the epact of the succeeding year; or, which comes to the same thing, we must add twelve to the epact of the last year of the cycle, and then reject thirty as before.

This method of forming the epacts might have been continued indefinitely if the Julian intercalation had been followed without correction, and the cycle been perfectly exact; but as neither of these suppositions is true, two equations or corrections must be applied, one depending on the error of the Julian year, which is called the solar equation; the other on the error of the lunar cycle, which is called the lunar equation. The solar equation occurs three times in 400 years, namely, in every secular year which is not a leap year; for in this case the omission of the intercalary day causes the new moons to arrive one day later in all the following months, so that the moon's age at the end of the month is one day less than it would have been if the intercalation had been made, and the epacts must accordingly be all diminished by unity. Thus the epacts 11, 22, 3, 14, &c., become 10, 21, 2, 13, &c. On the other hand, when the time by which the new moons anticipate the lunar cycle amounts to a whole day, which, as we have seen, it does in 308 years, the new moons will arrive one day earlier, and the epacts must consequently be increased by unity. Thus the epacts 11, 22, 3, 14, &c., in consequence of the lunar equation, become 12, 23, 4, 15, &c. In order to preserve the uniformity of the calendar, the epacts are changed only at the commencement of a century; the correction of the error of the lunar cycle is therefore made at the end of 300 years. In the Gregorian calendar this error is assumed to amount to one day in 312½ years or eight days in 2500 years, an assumption which requires the line of epacts to be changed seven times successively at the end of each period of 300 years, and once at the end of 400 years; and, from the manner in which the epacts were disposed at the Reformation, it was found most correct to suppose one of the periods of 2500 years to terminate with the year 1800.

The years in which the solar equation occurs, counting from the Reformation, are 1700, 1800, 1900, 2100, 2200, 2300, 2500, &c. Those in which the lunar equation occurs are 1800, 2100, 2400, 2700, 3000, 3300, 3600, 3900, after which, 4300, 4600 and so on. When the solar equation occurs, the epacts are diminished by unity; when the lunar equation occurs, the epacts are augmented by unity; and when both equations occur together, as in 1800, 2100, 2700, &c., they compensate each other, and the epacts are not changed.

In consequence of the solar and lunar equations, it is evident that the epact or moon's age at the beginning of the year, must,

in the course of centuries, have all different values from one to thirty inclusive, corresponding to the days in a full lunar month. Hence, for the construction of a perpetual calendar, there must be thirty different sets or lines of epacts. These are exhibited in the subjoined table (Table III.) called the *Extended Table of Epacts*, which is constructed in the following manner. The series of golden numbers is written in a line at the top of the table, and under each golden number is a column of thirty epacts, arranged in the order of the natural numbers, beginning at the bottom and proceeding to the top of the column. The first column, under the golden number 1, contains the epacts, 1, 2, 3, 4, &c., to 30 or 0. The second column, corresponding to the following year in the lunar cycle, must have all its epacts augmented by 11; the lowest number, therefore, in the column is 12, then 13, 14, 15 and so on. The third column corresponding to the golden number 3, has for its first epact $12+11=23$; and in the same manner all the nineteen columns of the table are formed. Each of the thirty lines of epacts is designated by a letter of the alphabet, which serves as its index or argument. The order of the letters, like that of the numbers, is from the bottom of the column upwards.

In the tables of the church calendar the epacts are usually printed in Roman numerals, excepting the last, which is designated by an asterisk (*), used as an indefinite symbol to denote 30 or 0, and 25, which in the last eight columns is expressed in Arabic characters, for a reason that will immediately be explained. In the table here given, this distinction is made by means of an accent placed over the last figure.

At the Reformation the epacts were given by the line D. The year 1600 was a leap year; the intercalation accordingly took place as usual, and there was no interruption in the order of the epacts; the line D was employed till 1700. In that year the omission of the intercalary day rendered it necessary to diminish the epacts by unity, or to pass to the line C. In 1800 the solar equation again occurred, in consequence of which it was necessary to descend one line to have the epacts diminished by unity; but in this year the lunar equation also occurred, the anticipation of the new moons having amounted to a day; the new moons accordingly happened a day earlier, which rendered it necessary to take the epacts in the next higher line. There was, consequently, no alteration; the two equations destroyed each other. The line of epacts belonging to the present century is therefore C. In 1900 the solar equation occurs, after which the line is B. The year 2000 is a leap year, and there is no alteration. In 2100 the equations again occur together and destroy each other, so that the line B will serve three centuries, from 1900 to 2200. From that year to 2300 the line will be A. In this manner the line of epacts belonging to any given century is easily found, and the method of proceeding is obvious. When the solar equation occurs alone, the line of epacts is changed to the next lower in the table; when the lunar equation occurs alone, the line is changed to the next higher; when both equations occur together, no change takes place. In order that it may be perceived at once to what centuries the different lines of epacts respectively belong, they have been placed in a column on the left hand side of the table on next page.

The use of the epacts is to show the days of the new moons, and consequently the moon's age on any day of the year. For this purpose they are placed in the calendar (Table IV.) along with the days of the month and dominical letters, in a retrograde order, so that the asterisk stands beside the 1st of January, 29 beside the 2nd, 28 beside the 3rd and so on to 1, which corresponds to the 30th. After this comes the asterisk, which corresponds to the 31st of January, then 29, which belongs to the 1st of February, and so on to the end of the year. The reason of this distribution is evident. If the last lunation of any year ends, for example, on the 2nd of December, the new moon falls on the 3rd; and the moon's age on the 31st, or at the end of the year, is twenty-nine days. The epact of the following year is therefore twenty-nine. Now that lunation having commenced on the 3rd of December, and consisting of thirty days, will end on the 1st of January. The 2nd of January is therefore the day

of the new moon, which is indicated by the epact twenty-nine. In like manner, if the new moon fell on the 4th of December, the epact of the following year would be twenty-eight, which, to indicate the day of next new moon, must correspond to the 3rd of January.

When the epact of the year is known, the days on which the new moons occur throughout the whole year are shown by Table IV., which is called the *Gregorian Calendar of Epacts*. For example, the golden number of the year 1832 is $(\frac{1832+1}{19})_r = 9$, and the epact, as found in Table III., is twenty-eight. This epact occurs at the 3rd of January, the 2nd of February, the 3rd of March, the 2nd of April, the 1st of May, &c., and these days are consequently the days of the ecclesiastical new moons in 1832. The astronomical new moons generally take place one or two days, sometimes even three days, earlier than those of the calendar.

There are some artifices employed in the construction of this table, to which it is necessary to pay attention. The thirty

placed in the calendar beside 26. When 25 and 26 occur in the same line of epacts, the 25 is not accented, and in the calendar stands beside 24. The lines of epacts in which 24 and 25 both occur, are those which are marked by one of the eight letters *b, c, k, m, r, B, E, N*, in all of which 25' stands in a column corresponding to a golden number higher than 11. There are also eight lines in which 25 and 26 occur, namely, *c, f, l, p, s, C, F, P*. In the other 14 lines, 25 either does not occur at all, or it occurs in a line in which neither 24 nor 26 is found. From this it appears that if the golden number of the year exceeds 11, the epact 25, in six months of the year, must correspond to the same day in the calendar as 26; but if the golden number does not exceed 11, that epact must correspond to the same day as 24. Hence the reason for distinguishing 25 and 25'. In using the calendar, if the epact of the year is 25, and the golden number not above 11, take 25; but if the golden number exceeds 11, take 25'.

Another peculiarity requires explanation. The epact 19' (also distinguished by an accent or different character) is placed

TABLE III.—*Extended Table of Epacts.*

Years.			Index.	Golden Numbers.																			
				1	2	3	4	5	6	7	8	9	10	11	12	13	14	15	16	17	18	19	
1700	1800	8700	C	*	11	22	3	14	25	6	17	28	9	20	1	12	23	4	15	26	7	18	
1900	2000	2100	B	29	10	21	2	13	24	5	16	27	8	17	*	11	22	3	14	25'	6	17	
2200	2400	A	28	9	20	1	12	23	4	15	26	7	19	29	10	21	2	13	24	5	16	15	
2300	2500	u	27	8	19	*	11	22	3	14	25	6	17	28	9	20	1	12	23	4	15	10	
2600	2700	2800	t	26	7	18	29	10	21	2	13	24	5	16	27	8	19	*	11	22	3	14	
2900	3000	r	s	25	6	17	28	9	20	1	12	23	4	15	26	7	18	29	10	21	2	13	
3100	3200	3300	a	24	5	16	27	8	19	*	11	22	3	14	25'	6	17	28	9	20	1	12	
3400	3600	q	p	23	4	15	26	7	18	29	10	21	2	13	24	5	16	27	8	19	*	11	
3500	3700	q	p	22	3	14	25	6	17	28	9	20	1	12	23	4	15	26	7	18	29	10	
3800	3900	4000	n	21	2	13	24	5	16	27	8	19	*	11	22	3	14	25'	6	17	28	10	
4200	4300	4400	m	l	20	1	12	23	4	15	26	7	18	29	10	21	2	13	24	5	16	27	8
4500	4600	k	i	19	*	11	22	3	14	25	6	17	28	9	20	1	12	23	4	15	26	7	7
4700	4800	4900	k	i	18	29	10	21	2	13	24	5	16	27	8	19	*	11	22	3	14	25'	6
5000	4800	4900	i	17	28	9	20	1	12	23	4	15	26	7	18	29	10	21	2	13	24	5	5
5000	5200	h	h	16	27	8	19	*	11	22	3	14	25	6	17	28	9	20	1	12	23	4	4
5100	5300	e	g	15	26	7	18	29	10	21	2	13	24	5	16	27	8	19	*	11	22	3	3
5400	5500	5600	e	14	25	6	17	28	9	20	1	12	23	4	15	26	7	18	29	10	21	2	2
5700	5800	i	e	13	24	5	16	27	8	19	*	11	22	3	14	25'	6	17	28	9	20	1	1
5900	6000	6100	d	12	23	4	15	26	7	18	29	10	21	2	13	24	5	16	27	8	19	*	11
6200	6400	c	d	11	22	3	14	25	6	17	28	9	20	1	12	23	4	15	26	7	18	29	29
6300	6500	b	a	10	21	2	13	24	5	16	27	8	19	*	11	22	3	14	25'	6	17	28	28
6600	6800	a	p	9	20	1	12	23	4	15	26	7	18	29	10	21	2	13	24	5	16	27	27
6700	6900	a	p	8	19	*	11	22	3	14	25	6	17	28	9	20	1	12	23	4	15	26	26
7000	7100	7200	N	M	7	18	29	10	21	2	13	24	5	16	27	8	19	*	11	22	3	14	25'
7300	7400	M	N	6	17	28	9	20	1	12	23	4	15	26	7	18	29	10	21	2	13	24	24
7500	7600	7700	H	G	5	16	27	8	19	*	11	22	3	14	25	6	17	28	9	20	1	12	23
7800	8000	F	F	4	15	26	7	18	29	10	21	2	13	24	5	16	27	8	19	*	11	22	
7900	8100	F	E	3	14	25	6	17	28	9	20	1	12	23	4	15	26	7	18	29	10	21	21
8200	8300	8400	E	D	2	13	24	5	16	27	8	19	*	11	22	3	14	25'	6	17	28	9	20
1500	1600	8500	D	E	1	12	23	4	15	26	7	18	29	10	21	2	13	24	5	16	27	8	19

epacts correspond to the thirty days of a full lunar month; but the lunar months consist of twenty-nine and thirty days alternately, therefore in six months of the year the thirty epacts must correspond only to twenty-nine days. For this reason the epacts twenty-five and twenty-four are placed together, so as to belong only to one day in the months of February, April, June, August, September and November, and in the same months another 25', distinguished by an accent, or by being printed in a different character, is placed beside 26, and belongs to the same day. The reason for doubling the 25 was to prevent the new moons from being indicated in the calendar as happening twice on the same day in the course of the lunar cycle, a thing which actually cannot take place. For example, if we observe the line B in Table III., we shall see that it contains both the epacts twenty-four and twenty-five, so that if these correspond to the same day of the month, two new moons would be indicated as happening on that day within nineteen years. Now the three epacts 24, 25, 26, can never occur in the same line; therefore in those lines in which 24 and 25 occur, the 25 is accented, and

in the same line with 20 at the 31st of December. It is, however, only used in those years in which the epact 19 occurs with the golden number 19. When the golden number is 19, that is to say, in the last year of the lunar cycle, the supplementary month contains only 29 days. Hence, if in that year the epact should be 19, a new moon would fall on the 2nd of December, and the lunation would terminate on the 30th, so that the next new moon would arrive on the 31st. The epact of the year, therefore, or 19, must stand beside that day, whereas, according to the regular order, the epact corresponding to the 31st of December is 20; and this is the reason for the distinction.

As an example of the use of the preceding tables, suppose it were required to determine the moon's age on the 10th of April 1832. In 1832 the golden number is $(\frac{1832+1}{19})_r = 9$, and the line of epacts belonging to the century is C. In Table III. under 9, and in the line C, we find the epact 28. In the calendar, Table IV., look for April, and the epact 28 is found opposite the second day. The 2nd of April is therefore the first day of the moon,

and the 10th is consequently the ninth day of the moon. Again, suppose it were required to find the moon's age on the 2nd of December in the year 1916. In this case the golden number is $\left(\frac{1916+1}{19}\right)_r = 17$, and in Table III., opposite to 1900, the line of epacts is B. Under 17, in line B, the epact is 25'. In the calendar this epact first occurs before the 2nd of December at the 26th of November. The 26th of November is consequently the first day of the moon, and the 2nd of December is therefore the seventh day.

Easter.—The next, and indeed the principal use of the calendar, is to find Easter, which, according to the traditional regulation of the council of Nice, must be determined from the following conditions:—1st, Easter must be celebrated on a Sunday; 2nd, this Sunday must follow the 14th day of the paschal moon, so that if the 14th of the paschal moon falls on a Sunday then Easter must be celebrated on the Sunday following; 3rd, the paschal

in this case the 18th of April is Sunday, then Easter must be celebrated on the following Sunday, or the 25th of April. Hence Easter Sunday cannot happen earlier than the 22nd of March, or later than the 25th of April.

Hence we derive the following rule for finding Easter Sunday from the tables:—1st, Find the golden number, and, from Table III., the epact of the proposed year. 2nd, Find in the calendar (Table IV.) the first day after the 7th of March which corresponds to the epact of the year; this will be the first day of the paschal moon. 3rd, Reckon thirteen days after that of the first of the moon, the following will be the 14th of the moon or the day of the full paschal moon. 4th, Find from Table I. the dominical letter of the year, and observe in the calendar the first day, after the fourteenth of the moon, which corresponds to the dominical letter; this will be Easter Sunday.

Example.—Required the day on which Easter Sunday falls in the year 1840? 1st, For this year the golden number is

TABLE IV.—Gregorian Calendar.

Days.	Jan.		Feb.		March.		April.		May.		June.		July.		August.		Sept.		October.		Nov.		Dec.			
	E	L	E	L	E	L	E	L	E	L	E	L	E	L	E	L	E	L	E	L	E	L	E	L		
1																										
2	29	A	29	D	*	D	29	G	28	B	27	E	26	G	25	24	C	23	22	21	A	20	D	19	F	
3	28	B	28	E		E	28	A	27	C	26	F	25	F	24	D	23	D	22	21	B	20	E	19	G	
4	27	C	27	F		F	27	B	26	D	25	E	24	E	23	E	22	E	21	20	C	19	F	18	A	
5	26	D	25	G	26	G	25	C	24	F	23	F	22	F	21	F	20	F	19	18	D	17	G	16	B	
6	25	F	23	B	25	B	23	E	22	G	21	G	20	G	19	G	18	G	17	16	F	15	E	14	D	
7	24	G	22	C	24	C	22	F	21	A	20	A	19	A	18	A	17	A	16	15	E	14	D	13	C	
8	23	A	21	D	23	D	21	G	20	B	19	B	18	B	17	B	16	B	15	14	D	13	C	12	B	
9	22	B	20	E	22	E	20	A	19	C	18	C	17	C	16	C	15	C	14	13	E	12	D	11	A	
10	21	C	19	F	21	F	19	B	18	D	17	D	16	D	15	D	14	D	13	12	F	11	E	10	C	
11	20	D	18	G	20	G	18	C	17	E	16	E	15	E	14	E	13	E	12	11	G	10	F	9	B	
12	19	E	17	A	19	A	17	D	16	F	15	F	14	F	13	F	12	F	11	10	A	9	D	8	E	
13	18	F	16	B	18	B	16	E	15	G	14	G	13	G	12	G	11	G	10	9	B	8	E	7	C	
14	17	G	15	C	17	C	15	F	14	A	13	A	12	A	11	A	10	A	9	8	C	7	B	6	D	
15	16	A	14	D	16	D	14	F	13	B	12	B	11	B	10	B	9	B	8	7	A	6	C	5	E	
16	15	B	13	E	15	E	13	A	12	C	11	C	10	C	9	C	8	C	7	6	B	5	D	4	F	
17	14	C	12	F	14	F	12	B	11	D	10	D	9	D	8	D	7	D	6	5	C	4	E	3	A	
18	13	D	11	G	13	G	11	C	10	E	9	E	8	E	7	E	6	E	5	4	D	3	F	2	B	
19	12	E	10	A	12	A	10	D	9	F	8	F	7	F	6	F	5	F	4	3	E	2	G	1	C	
20	11	F	9	B	11	B	9	E	8	G	7	G	6	G	5	G	4	G	3	2	F	1	D	*	A	
21	10	G	8	C	10	C	8	F	7	A	6	A	5	A	4	A	3	A	2	1	G	*	E		F	
22	9	A	7	D	9	D	7	G	6	B	5	B	4	B	3	B	2	B	1	*	A	29	28	27	G	
23	8	B	6	E	8	E	6	A	5	C	4	C	3	C	2	C	1	C	29	28	B	27	26	25	A	
24	7	C	5	F	7	F	5	B	4	D	3	D	2	D	1	D	29	28	27	26	C	25	24	23	B	
25	6	D	4	G	6	G	4	C	3	E	2	E	1	E	29	28	27	26	25	24	D	23	22	21	A	
26	5	E	3	A	5	A	3	D	2	F	1	F	29	28	27	26	25	24	23	22	E	21	20	19	C	
27	4	F	2	B	4	B	2	E	1	G		G	29	28	27	26	25	24	23	22	F	21	20	19	B	
28	3	G	1	C	3	C	1	F		A		A	29	28	27	26	25	24	23	22	G	21	20	19	A	
29	2	A		D	2	D		G	29				29	28	27	26	25	24	23	22	A	21	20	19	C	
30	1	B		E	1	E		A					29	28	27	26	25	24	23	22	B	21	20	19	B	
31	*	C		F	*	F		B	28	D			25	26	B	24	E			22	C			19	20	A

moon is that of which the 14th day falls on or next follows the day of the vernal equinox; 4th the equinox is fixed invariably in the calendar on the 21st of March. Sometimes a misunderstanding has arisen from not observing that this regulation is to be construed according to the tabular full moon as determined from the epact, and not by the true full moon, which, in general, occurs one or two days earlier.

From these conditions it follows that the paschal full moon, or the 14th of the paschal moon, cannot happen before the 21st of March, and that Easter in consequence cannot happen before the 22nd of March. If the 14th of the moon falls on the 21st, the new moon must fall on the 8th; for 21-13=8; and the paschal new moon cannot happen before the 8th; for suppose the new moon to fall on the 7th, then the full moon would arrive on the 20th, or the day before the equinox. The following moon would be the paschal moon. But the fourteenth of this moon falls at the latest on the 18th of April, or 29 days after the 20th of March; for by reason of the double epact that occurs at the 4th and 5th of April, this lunation has only 29 days. Now, if

$\left(\frac{1840+1}{19}\right)_r = 17$, and the epact (Table III. line C) is 26. 2nd, After the 7th of March the epact 26 first occurs in Table III. at the 4th of April, which, therefore, is the day of the new moon. 3rd, Since the new moon falls on the 4th, the full moon is on the 17th (4+13=17). 4th, The dominical letters of 1840 are E, D (Table L), of which D must be taken, as E belongs only to January and February. After the 17th of April D first occurs in the calendar (Table IV.) at the 19th. Therefore, in 1840, Easter Sunday falls on the 19th of April. The operation is in all cases much facilitated by means of the table on next page.

Such is the very complicated and artificial, though highly ingenious method, invented by Lilius, for the determination of Easter and the other movable feasts. Its principal, though perhaps least obvious advantage, consists in its being entirely independent of astronomical tables, or indeed of any celestial phenomena whatever; so that all chances of disagreement arising from the inevitable errors of tables, or the uncertainty of observation, are avoided, and Easter determined without the

possibility of mistake. But this advantage is only procured by the sacrifice of some accuracy; for notwithstanding the cumbersome apparatus employed, the conditions of the problem are not always exactly satisfied, nor is it possible that they can be always satisfied by any similar method of proceeding. The equinox is fixed on the 21st of March, though the sun enters Aries generally on the 20th of that month, sometimes even on the 19th. It is accordingly quite possible that a full moon may arrive after the true equinox, and yet precede the 21st of March. This, therefore, would not be the paschal moon of the calendar, though it undoubtedly ought to be so if the intention of the council of Nice were rigidly followed. The new moons indicated by the epacts also differ from the astronomical new moons, and even from the mean new moons, in general by one or two days. In imitation of the Jews, who counted the time of the new moon, not from the moment of the actual phase, but from the time the moon first became visible after the conjunction, the fourteenth day of the moon is regarded as the full moon: but the moon is in opposition generally on the 16th day; therefore, when the new moons of the

must therefore be diminished by the number of units in $\frac{x}{4}$, or by $(\frac{x}{4})_w$ (this notation being used to denote the quotient, in a whole number, that arises from dividing x by 4). Hence in the Julian calendar the dominical letter is given by the equation

$$L = 7m + 3 - x - (\frac{x}{4})_w$$

This equation gives the dominical letter of any year from the commencement of the era to the Reformation. In order to adapt it to the Gregorian calendar, we must first add the 10 days that were left out of the year 1582; in the second place we must add one day for every century that has elapsed since 1600, in consequence of the secular suppression of the intercalary day; and lastly we must deduct the units contained in a fourth of the same number, because every fourth centesimal year is still a leap year. Denoting, therefore, the number of the century (or the date after the two right-hand digits have been struck out) by c , the value of L must be increased by $10 + (c-16) - (\frac{c-16}{4})_w$. We have then

$$L = 7m + 3 - x - (\frac{x}{4})_w + 10 + (c-16) - (\frac{c-16}{4})_w$$

that is, since $3+10=13$ or 6 (the 7 days being rejected, as they do not affect the value of L),

$$L = 7m + 6 - x - (\frac{x}{4})_w + (c-16) - (\frac{c-16}{4})_w$$

This formula is perfectly general, and easily calculated.

As an example, let us take the year 1839. In this case,

$$x = 1839, (\frac{x}{4})_w = (\frac{1839}{4})_w = 459, c = 18, c-16 = 2,$$

$$\text{and } (\frac{c-16}{4})_w = 0. \text{ Hence}$$

$$L = 7m + 6 - 1839 - 459 + 2 - 0$$

$$L = 7m - 2290 = 7 \times 328 - 2290$$

$$L = 6 = \text{letter F.}$$

The year therefore begins with Tuesday. It will be remembered that in a leap year there are always two dominical letters, one of which is employed till the 29th of February, and the other till the end of the year. In this case, as the formula supposes the intercalation already made, the resulting letter is that which applies after the 29th of February. Before the intercalation the dominical letter had retrograded one place less. Thus for 1840 the formula gives D; during the first two months, therefore, the dominical letter is E.

In order to investigate a formula for the epact, let us make

E = the true epact of the given year;

J = the Julian epact, that is to say, the number the epact would have been if the Julian year had been still in use and the lunar cycle had been exact;

S = the correction depending on the solar year;

M = the correction depending on the lunar cycle;

then the equation of the epact will be

$$E = J + S + M;$$

so that E will be known when the numbers J , S , and M are determined.

The epact J depends on the golden number N , and must be determined from the fact that in 1582, the first year of the reformed calendar, N was 6, and J 26. For the following years, then, the golden numbers and epacts are as follows:

$$1583, N = 7, \quad \left\{ \begin{array}{l} = 26 + 11 - 30 = 7; \\ 1584, N = 8, \quad \left\{ \begin{array}{l} = 7 + 11 = 18; \\ 1585, N = 9, \quad \left\{ \begin{array}{l} = 18 + 11 = 29; \\ 1586, N = 10, \quad \left\{ \begin{array}{l} = 29 + 11 - 30 = 10; \end{array} \right. \end{array} \right. \end{array} \right.$$

and, therefore, in general $J = (\frac{26+11(N-6)}{30})_w$. But the numerator of this fraction becomes by reduction $11N-40$ or $11N-10$ (the 30 being rejected, as the remainder only is sought) = $N+10(N-1)$; therefore, ultimately,

$$J = (\frac{N+10(N-1)}{30})_w$$

On account of the solar equation S , the epact J must be diminished by unity every centesimal year, excepting always the fourth.

After x centuries, therefore, it must be diminished by $x - (\frac{x}{4})_w$. Now, as 1600 was a leap year, the first correction of the Julian intercalation took place in 1700; hence, taking c to denote the number of the century as before, the correction becomes $(c-16) - (\frac{c-16}{4})_w$ which

TABLE V.—Perpetual Table, showing Easter.

Epact.	Dominical Letter.						
	For Leap Years use the SECOND Letter.						
	A	B	C	D	E	F	G
0	Apr. 16	Apr. 17	Apr. 18	Apr. 19	Apr. 20	Apr. 14	Apr. 15
1	" 16	" 17	" 18	" 19	" 13	" 14	" 15
2	" 16	" 17	" 18	" 12	" 13	" 14	" 15
3	" 16	" 17	" 11	" 12	" 13	" 14	" 15
4	" 16	" 10	" 11	" 12	" 13	" 14	" 15
5	" 9	" 10	" 11	" 12	" 13	" 14	" 15
6	" 9	" 10	" 11	" 12	" 13	" 14	" 8
7	" 9	" 10	" 11	" 12	" 13	" 7	" 8
8	" 9	" 10	" 11	" 12	" 6	" 7	" 8
9	" 9	" 10	" 11	" 5	" 6	" 7	" 8
10	" 9	" 10	" 4	" 5	" 6	" 7	" 8
11	" 9	" 3	" 4	" 5	" 6	" 7	" 8
12	" 2	" 3	" 4	" 5	" 6	" 7	" 8
13	" 2	" 3	" 4	" 5	" 6	" 7	" 1
14	" 2	" 3	" 4	" 5	" 6	Mar. 31	" 1
15	" 2	" 3	" 4	" 5	Mar. 30	" 31	" 1
16	" 2	" 3	" 4	Mar. 29	" 30	" 31	" 1
17	" 2	" 3	Mar. 28	" 29	" 30	" 31	" 1
18	" 2	Mar. 27	" 28	" 29	" 30	" 31	" 1
19	Mar. 26	" 27	" 28	" 29	" 30	" 31	" 1
20	" 26	" 27	" 28	" 29	" 30	" 31	Mar. 25
21	" 26	" 27	" 28	" 29	" 30	" 24	" 25
22	" 26	" 27	" 28	" 29	" 23	" 24	" 25
23	" 26	" 27	" 28	" 22	" 23	" 24	" 25
24	Apr. 23	Apr. 24	Apr. 25	Apr. 19	Apr. 20	Apr. 21	Apr. 22
25	" 23	" 24	" 25	" 19	" 20	" 21	" 22
26	" 23	" 24	" 18	" 19	" 20	" 21	" 22
27	" 23	" 17	" 18	" 19	" 20	" 21	" 22
28	" 16	" 17	" 18	" 19	" 20	" 21	" 22
29	" 16	" 17	" 18	" 19	" 20	" 21	" 15

calendar nearly concur with the true new moons, the full moons are considerably in error. The epacts are also placed so as to indicate the full moons generally one or two days after the true full moons; but this was done purposely, to avoid the chance of concurring with the Jewish passover, which the framers of the calendar seem to have considered a greater evil than that of celebrating Easter a week too late.

We will now show in what manner this whole apparatus of methods and tables may be dispensed with, and the Gregorian calendar reduced to a few simple formulæ of easy computation.

And, first, to find the dominical letter. Let L denote the number of the dominical letter of any given year of the era. Then, since every year which is not a leap year ends with the same day as that with which it began, the dominical letter of the following year must be $L-1$, retrograding one letter every common year. After x years, therefore, the number of the letter will be $L-x$. But as L can never exceed 7, the number x will always exceed L after the first seven years of the era. In order, therefore, to render the subtraction possible, L must be increased by some multiple of 7, as $7m$, and the formula then becomes $7m+L-x$. In the year preceding the first of the era, the dominical letter was C; for that year, therefore, we have $L=3$; consequently for any succeeding year x , $L=7m+3-x$, the years being all supposed to consist of 365 days. But every fourth year is a leap year, and the effect of the intercalation is to throw the dominical letter one place farther back. The above expression

must be deducted from J. We have therefore

$$S = -(c-176) + \left(\frac{c-16}{4}\right)w$$

With regard to the lunar equation M, we have already stated that in the Gregorian calendar the epacts are increased by unity at the end of every period of 300 years seven times successively, and then the increase takes place once at the end of 400 years. This gives eight to be added in a period of twenty-five centuries, and $\frac{8x}{25}$ in x

centuries. But $\frac{8x}{25} = \frac{1}{3}\left(x - \frac{x}{25}\right)$. Now, from the manner in which the intercalation is directed to be made (namely, seven times successively at the end of 300 years, and once at the end of 400), it is evident that the fraction $\frac{x}{25}$ must amount to unity when the number of centuries amounts to twenty-four. In like manner, when the number of centuries is $24+25=49$, we must have $\frac{x}{25}=2$; when the number of centuries is $24+2 \times 25=74$, then $\frac{x}{25}=3$; and, generally, when the number of centuries is $24+n \times 25$, then $\frac{x}{25}=n+1$. Now this is a condition which will evidently be expressed in general by the formula $n = \left(\frac{x+1}{25}\right)w$. Hence the correction of the epact, or the number of days to be intercalated after x centuries reckoned from the commencement of one of the periods of twenty-five

centuries, is $\left\{x - \frac{(x+1)}{25}w\right\}$. The last period of twenty-five centuries terminated with 1800; therefore, in any succeeding year, if c be the number of the century, we shall have $x=c-18$ and $x+1=c-17$. Let $\left(\frac{c-17}{25}\right)w = a$, then for all years after 1800 the value of M will be given by the formula $\left(\frac{c-18-a}{3}\right)w$; therefore, counting from the beginning of the calendar in 1582,

$$M = \left\{\frac{c-18-a}{3}\right\}w$$

By the substitution of these values of J, S and M, the equation of the epact becomes

$$E = \left(\frac{N+10(N-1)}{30}\right)r - (c-16) + \left(\frac{c-16}{4}\right)w + \left(\frac{c-18-a}{3}\right)w$$

It may be remarked, that as $a = \left(\frac{c-17}{25}\right)w$, the value of a will be 0 till $c-17=25$ or $c=42$; therefore, till the year 4200, a may be neglected in the computation. Had the anticipation of the new moons been taken, as it ought to have been, at one day in 308 years instead of 312½, the lunar equation would have occurred only twelve times in 3700 years, or eleven times successively at the end of 300 years, and then at the end of 400. In strict accuracy, therefore, a ought to have no value till $c-17=37$, or $c=54$, that is to say, till the year 5400. The above formula for the epact is given by Delambre (*Hist. de l'astronomie moderne*, t. i. p. 9); it may be exhibited under a variety of forms, but the above is perhaps the best adapted for calculation. Another had previously been given by Gauss, but inaccurately, inasmuch as the correction depending on a was omitted.

Having determined the epact of the year, it only remains to find Easter Sunday from the conditions already laid down. Let P = the number of days from the 21st of March to the 15th of the paschal moon, which is the first day on which Easter Sunday can fall;

p = the number of days from the 21st of March to Easter Sunday;

L = the number of the dominical letter of the year;

l = letter belonging to the day on which the 15th of the moon falls: then, since Easter is the Sunday following the 14th of the moon, we have

$$p = P + (L - l),$$

which is commonly called the number of direction.

The value of L is always given by the formula for the dominical letter, and P and l are easily deduced from the epact, as will appear from the following considerations.

When P = 1 the full moon is on the 21st of March, and the new moon on the 8th (21-13=8), therefore the moon's age on the 1st of March (which is the same as on the 1st of January) is twenty-three days; the epact of the year is consequently twenty-three. When P = 2 the new moon falls on the ninth, and the epact is consequently twenty-two; and, in general, when P becomes 1+x, E becomes 23-x; therefore P+E = 1+x+23-x=24, and P=24-E. In like manner, when P=1, l=D=4; for D is the dominical letter of the calendar belonging to the 22nd of March. But it is evident that when l is increased by unity, that is to say, when the full moon falls a day later, the epact of the year is diminished by unity; therefore, in general, when l = 4+x, E = 23-x, whence l+E = 27 and

l = 27-E. But P can never be less than 1 nor l less than 4, and in both cases E = 23. When, therefore, E is greater than 23, we must add 30 in order that P and l may have positive values in the formula P = 24-E and l = 27-E. Hence there are two cases.

$$\text{When } < 24, \begin{cases} P = 24 - E, \\ l = 27 - E, \text{ or } \left(\frac{27-E}{7}\right)r \end{cases}$$

$$\text{When } E > 23, \begin{cases} P = 54 - E, \\ l = 57 - E, \text{ or } \left(\frac{57-E}{7}\right)r \end{cases}$$

By substituting one or other of these values of P and l, according as the case may be, in the formula $p = P + (L - l)$, we shall have p, or the number of days from the 21st of March to Easter Sunday. It will be remarked, that as L-l cannot either be 0 or negative, we must add 7 to L as often as may be necessary, in order that L-l may be a positive whole number.

By means of the formulae which we have now given for the dominical letter, the golden number and the epact, Easter Sunday may be computed for any year after the Reformation, without the assistance of any tables whatever. As an example, suppose it were required to compute Easter for the year 1840. By substituting this number in the formula for the dominical letter, we have $x = 1840$,

$$\begin{aligned} c-16 &= 2, \left(\frac{c-16}{4}\right)w = 0, \text{ therefore} \\ L &= 7m + 6 - 1840 - 460 + 2 \\ &= 7m - 2292 \\ &= 7 \times 328 - 2292 = 2296 - 2292 = 4 \\ L &= 4 = \text{letter D} \dots \dots \dots (1). \end{aligned}$$

For the golden number we have $N = \left(\frac{1840+1}{19}\right)r$; therefore

$$N = 17 \dots \dots \dots (2).$$

For the epact we have

$$\left(\frac{N+10(N-1)}{30}\right)r = \left(\frac{17+160}{30}\right)r = \left(\frac{177}{30}\right)r = 27;$$

likewise $c-16 = 18 - 16 = 2$, $\frac{c-16}{3} = 1, a = 0$; therefore

$$E = 27 - 2 + 1 = 26 \dots \dots \dots (3).$$

Now since E > 23, we have for P and l,

$$\begin{aligned} P &= 54 - E = 54 - 26 = 28, \\ l &= \left(\frac{57-E}{7}\right)r = \left(\frac{57-26}{7}\right)r = \left(\frac{31}{7}\right)r = 3; \end{aligned}$$

consequently, since $p = P + (L - l)$, $p = 28 + (4 - 3) = 29$; that is to say, Easter happens twenty-nine days after the 21st of March, or on the 19th April, the same result as was before found from the tables.

The principal church feasts depending on Easter, and the times of their celebration are as follows:—

Septuagesima Sunday } is } 9 weeks } before
First Sunday in Lent } } 6 weeks } Easter.
Ash Wednesday } } 46 days }
Rogation Sunday } } 5 weeks }
Ascension day or Holy Thursday } } 39 days } after
Pentecost or Whitsunday } } 7 weeks } Easter.
Trinity Sunday } } 8 weeks }

The Gregorian calendar was introduced into Spain, Portugal and part of Italy the same day as at Rome. In France it was received in the same year in the month of December, and by the Catholic states of Germany the year following. In the Protestant states of Germany the Julian calendar was adhered to till the year 1700, when it was decreed by the diet of Regensburg that the new style and the Gregorian correction of the intercalation should be adopted. Instead, however, of employing the golden numbers and epacts for the determination of Easter and the movable feasts, it was resolved that the equinox and the paschal moon should be found by astronomical computation from the Rudolphine tables. But this method, though at first view it may appear more accurate, was soon found to be attended with numerous inconveniences, and was at length in 1774 abandoned at the instance of Frederick II., king of Prussia. In Denmark and Sweden the reformed calendar was received about the same time as in the Protestant states of Germany. It is remarkable that Russia still adheres to the Julian reckoning.

In Great Britain the alteration of the style was for a long time successfully opposed by popular prejudice. The inconvenience, however, of using a different date from that employed by the greater part of Europe in matters of history and chronology began to be generally felt; and at length the Calendar (New

Style) Act 1750 was passed for the adoption of the new style in all public and legal transactions. The difference of the two styles, which then amounted to eleven days, was removed by ordering the day following the 2nd of September of the year 1752 to be accounted the 14th of that month; and in order to preserve uniformity in future, the Gregorian rule of intercalation respecting the secular years was adopted. At the same time, the commencement of the legal year was changed from the 25th of March to the 1st of January. In Scotland, January 1st was adopted for New Year's Day from 1600, according to an act of the privy council in December 1590. This fact is of importance with reference to the date of legal deeds executed in Scotland between that period and 1751, when the change was effected in England. With respect to the movable feasts, Easter is determined by the rule laid down by the council of Nice; but instead of employing the new moons and epacts, the golden numbers are prefixed to the days of the full moons. In those years in which the line of epacts is changed in the Gregorian calendar, the golden numbers are removed to different days, and of course a new table is required whenever the solar or lunar equation occurs. The golden numbers have been placed so that Easter may fall on the same day as in the Gregorian calendar. The calendar of the church of England is therefore from century to century the same in form as the old Roman calendar, excepting that the golden numbers indicate the full moons instead of the new moons.

Hebrew Calendar.—In the construction of the Jewish calendar numerous details require attention. The calendar is dated from the Creation, which is considered to have taken place 3760 years and 3 months before the commencement of the Christian era. The year is luni-solar, and, according as it is ordinary or embolismic, consists of twelve or thirteen lunar months, each of which has 29 or 30 days. Thus the duration of the ordinary year is 354 days, and that of the embolismic is 384 days. In either case, it is sometimes made a day more, and sometimes a day less, in order that certain festivals may fall on proper days of the week for their due observance. The distribution of the embolismic years, in each cycle of 19 years, is determined according to the following rule:—

The number of the Hebrew year (Y) which has its commencement in a Gregorian year (x) is obtained by the addition of 3761 years; that is, $Y = x + 3761$. Divide the Hebrew year by 19; then the quotient is the number of the last completed cycle, and the remainder is the year of the current cycle. If the remainder be 3, 6, 8, 11, 14, 17 or 19 (o), the year is embolismic, if any other number, it is ordinary. Or, otherwise, if we find the remainder

$$R = \left(\frac{2Y+1}{19} \right),$$

the year is embolismic when $R < 7$.

The calendar is constructed on the assumptions that the mean lunation is 29 days 12 hours 44 min. $3\frac{1}{2}$ sec., and that the year commences on, or immediately after, the new moon following the autumnal equinox. The mean solar year is also assumed to be 365 days 5 hours 55 min. $25\frac{1}{4}$ sec., so that a cycle of nineteen of such years, containing 6930 days 16 hours 33 min. $3\frac{1}{2}$ sec., is the exact measure of 235 of the assumed lunations. The year 5606 was the first of a cycle, and the mean new moon, appertaining to the 1st of Tisri for that year, was 1845, October 1, 15 hours 42 min. $43\frac{1}{2}$ sec., as computed by Lindo, and adopting the civil mode of reckoning from the previous midnight. The times of all future new moons may consequently be deduced by successively adding 29 days 12 hours 44 min. $3\frac{1}{2}$ sec. to this date.

To compute the times of the new moons which determine the commencement of successive years, it must be observed that in passing from an ordinary year the new moon of the following year is deduced by subtracting the interval that twelve lunations fall short of the corresponding Gregorian year of 365 or 366 days; and that, in passing from an embolismic year, it is to be found by adding the excess of thirteen lunations over the Gregorian year. Thus to deduce the new moon of Tisri, for the year

immediately following any given year (Y), when Y is

$$\left\{ \begin{array}{l} \text{ordinary, subtract } \left(\frac{10}{11} \right) \text{ days 15 hours 11 min. 20 sec.} \\ \text{embolismic, add } \left(\frac{18}{17} \right) \text{ days 21 hours 32 min. 43} \frac{1}{2} \text{ sec.} \end{array} \right.$$

the second-mentioned number of days being used, in each case, whenever the following or new Gregorian year is bissextile.

Hence, knowing which of the years are embolismic, from their ordinal position in the cycle, according to the rule before stated, the times of the commencement of successive years may be thus carried on indefinitely without any difficulty. But some slight adjustments will occasionally be needed for the reasons before assigned, viz. to avoid certain festivals falling on incompatible days of the week. Whenever the computed conjunction falls on a Sunday, Wednesday or Friday, the new year is in such case to be fixed on the day after. It will also be requisite to attend to the following conditions:—

If the computed new moon be after 18 hours, the following day is to be taken, and if that happen to be Sunday, Wednesday or Friday, it must be further postponed one day. If, for an ordinary year, the new moon falls on a Tuesday, as late as 9 hours 11 min. 20 sec., it is not to be observed thereon; and as it may not be held on a Wednesday, it is in such case to be postponed to Thursday. If, for a year immediately following an embolismic year, the computed new moon is on Monday, as late as 15 hours 30 min. 52 sec., the new year is to be fixed on Tuesday.

After the dates of commencement of the successive Hebrew years are finally adjusted, conformably with the foregoing directions, an estimation of the consecutive intervals, by taking the differences, will show the duration and character of the years that respectively intervene. According to the number of days thus found to be comprised in the different years, the days of the several months are distributed as in Table VI.

The signs + and - are respectively annexed to Heshvan and Kislef to indicate that the former of these months may sometimes require to have one day more, and the latter sometimes one day less, than the number of days shown in the table—the result, in every case, being at once determined by the total number of days that the year may happen to contain. An ordinary year may comprise 353, 354 or 355 days; and an embolismic year 383, 384 or 385 days. In these cases respectively the year is said to be imperfect, common or perfect. The intercalary month, Veadar, is introduced in embolismic years in order that Passover, the 15th day of Nisan, may be kept at its proper season, which is the full moon of the vernal equinox, or that which takes place after the sun has entered the sign Aries. It always precedes the following new year by 163 days, or 23 weeks and 2 days, and Pentecost always precedes the new year by 113 days, or 16 weeks and 1 day.

TABLE VI.—Hebrew Months.

Hebrew Month.	Ordinary Year.	Embolismic Year.
Tisri	30	30
Heshvan	29+	29+
Kislef	30-	30-
Tebet	29	29
Sebat	30	30
Adar	29	30
(Veadar)	(-)	(29)
Nisan	30	30
Yiar	29	29
Sivan	30	30
Tamuz	29	29
Ab	30	30
Elul	29	29
Total	354	384

The Gregorian epact being the age of the moon on Tebet at the beginning of the Gregorian year, it represents the day of Tebet which corresponds to January 1; and thus the approximate date of Tisri 1, the commencement of the Hebrew year, may be otherwise deduced by subtracting the epact from

Sept. 24 } after an ordinary }
 Oct. 24 } embolismic } Hebrew year.

The result so obtained would in general be more accurate than the Jewish calculation, from which it may differ a day, as fractions of a day do not enter alike in these computations. Such difference may also in part be accounted for by the fact that the assumed duration of the solar year is 6 min. 39 $\frac{1}{2}$ sec. In excess of the true astronomical value, which will cause the dates of commencement of future Jewish years, so calculated, to advance forward from the equinox a day in error in 216 years. The lunations are estimated with much greater precision.

The following table is extracted from Woolhouse's *Measures, Weights and Monies of all Nations*—

TABLE VII.—Hebrew Years.

Jewish Year.	Number of Days.	Commencement (1st of Tisri).	Jewish Year.	Number of Days.	Commencement (1st of Tisri).
5606	354	Thur. 2 Oct. 1845	5673	385	Thur. 12 Sept. 1912
07	355	Mon. 21 Sept. 1846	74	354	Thur. 2 Oct. 1913
08	383	Sat. 11 Sept. 1847	75	353	Mon. 21 Sept. 1914
09	354	Thur. 28 Sept. 1848	76	385	Thur. 9 Sept. 1915
10	355	Mon. 17 Sept. 1849	77	354	Thur. 28 Sept. 1916
11	385	Sat. 7 Sept. 1850	78	355	Mon. 17 Sept. 1917
12	353	Sat. 27 Sept. 1851	79	383	Sat. 7 Sept. 1918
13	384	Tues. 14 Sept. 1852	80	354	Thur. 25 Sept. 1919
14	355	Mon. 3 Oct. 1853	81	385	Mon. 13 Sept. 1920
15	355	Sat. 23 Sept. 1854			
16	383	Thur. 13 Sept. 1855	5682	355	Mon. 3 Oct. 1921
17	354	Tues. 30 Sept. 1856	83	353	Sat. 23 Sept. 1922
18	355	Sat. 19 Sept. 1857	84	384	Tues. 11 Sept. 1923
19	385	Thur. 9 Sept. 1858	85	355	Mon. 29 Sept. 1924
20	354	Thur. 29 Sept. 1859	86	355	Sat. 19 Sept. 1925
21	353	Mon. 17 Sept. 1860	87	383	Thur. 9 Sept. 1926
22	385	Thur. 5 Sept. 1861	88	354	Thur. 27 Sept. 1927
23	354	Thur. 25 Sept. 1862	89	385	Sat. 15 Sept. 1928
24	383	Mon. 14 Sept. 1863	90	353	Sat. 5 Oct. 1929
			91	354	Tues. 23 Sept. 1930
5625	355	Sat. 1 Oct. 1864	92	385	Sat. 12 Sept. 1931
26	354	Thur. 21 Sept. 1865	93	354	Sat. 1 Oct. 1932
27	385	Mon. 10 Sept. 1866	94	384	Mon. 21 Sept. 1933
28	353	Mon. 30 Sept. 1867	95	353	Mon. 10 Sept. 1934
29	354	Thur. 17 Sept. 1868	96	355	Sat. 28 Sept. 1935
30	385	Mon. 6 Sept. 1869	97	354	Thur. 17 Sept. 1936
31	355	Mon. 26 Sept. 1870	98	385	Mon. 6 Sept. 1937
32	383	Sat. 16 Sept. 1871	99	353	Mon. 26 Sept. 1938
33	354	Thur. 3 Oct. 1872	5700	385	Thur. 14 Sept. 1939
34	355	Mon. 22 Sept. 1873			
35	383	Sat. 12 Sept. 1874	5701	354	Thur. 3 Oct. 1940
36	355	Thur. 30 Sept. 1875	02	385	Mon. 29 Sept. 1941
37	354	Tues. 19 Sept. 1876	03	383	Sat. 12 Sept. 1942
38	385	Sat. 8 Sept. 1877	04	354	Thur. 30 Sept. 1943
39	355	Sat. 28 Sept. 1878	05	355	Mon. 18 Sept. 1944
40	354	Thur. 18 Sept. 1879	06	383	Sat. 8 Sept. 1945
41	383	Mon. 6 Sept. 1880	07	354	Thur. 26 Sept. 1946
42	355	Sat. 24 Sept. 1881	08	385	Mon. 15 Sept. 1947
43	383	Thur. 14 Sept. 1882	09	355	Mon. 4 Oct. 1948
			10	353	Tues. 12 Sept. 1950
5644	354	Tues. 2 Oct. 1883	11	384	Mon. 1 Oct. 1951
45	355	Sat. 20 Sept. 1884	12	355	Sat. 20 Sept. 1952
46	385	Thur. 10 Sept. 1885	13	383	Thur. 10 Sept. 1953
47	354	Thur. 30 Sept. 1886	14	355	Tues. 28 Sept. 1954
48	353	Mon. 19 Sept. 1887	15	355	Sat. 17 Sept. 1955
49	385	Thur. 6 Sept. 1888	16	385	Thur. 6 Sept. 1956
50	354	Thur. 26 Sept. 1889	17	354	Thur. 26 Sept. 1957
51	383	Mon. 15 Sept. 1890	18	383	Mon. 15 Sept. 1958
52	355	Sat. 3 Oct. 1891	19	355	
53	354	Sat. 22 Sept. 1892	5720	355	Sat. 3 Oct. 1959
54	385	Mon. 11 Sept. 1893	20	384	Mon. 22 Sept. 1960
55	353	Mon. 1 Oct. 1894	21	383	Thur. 11 Sept. 1961
56	355	Thur. 19 Sept. 1895	22	355	Sat. 29 Sept. 1962
57	384	Tues. 8 Sept. 1896	23	354	Thur. 19 Sept. 1963
58	355	Thur. 27 Sept. 1897	24	354	Mon. 7 Sept. 1964
59	353	Sat. 17 Sept. 1898	25	385	Mon. 27 Sept. 1965
60	384	Tues. 5 Sept. 1899	26	353	Thur. 15 Sept. 1966
61	355	Mon. 24 Sept. 1900	27	385	Thur. 5 Oct. 1967
62	383	Sat. 14 Sept. 1901	28	354	Sat. 23 Sept. 1968
			29	355	Sat. 13 Sept. 1969
5663	355	Thur. 2 Oct. 1902	30	383	Mon. 1 Oct. 1970
64	354	Tues. 22 Sept. 1903	31	354	Thur. 20 Sept. 1971
65	385	Sat. 10 Sept. 1904	32	383	Sat. 9 Sept. 1972
66	355	Sat. 30 Sept. 1905	33	383	Sat. 27 Sept. 1973
67	384	Thur. 20 Sept. 1906	34	355	Tues. 17 Sept. 1974
68	383	Mon. 9 Sept. 1907	35	354	Sat. 6 Sept. 1975
69	355	Thur. 26 Sept. 1908	36	385	Sat. 25 Sept. 1976
70	383	Thur. 16 Sept. 1909	37	353	Tues. 13 Sept. 1977
71	354	Tues. 4 Oct. 1910	38	384	
72	355	Sat. 23 Sept. 1911			

TABLE VII.—Hebrew Years (continued).

Jewish Year.	Number of Days.	Commencement (1st of Tisri).	Jewish Year.	Number of Days.	Commencement (1st of Tisri).
5739	355	Mon. 2 Oct. 1978	5786	354	Tues. 23 Sept. 2025
40	355	Sat. 21 Sept. 1979	87	385	Sat. 12 Sept. 2026
41	383	Thur. 11 Sept. 1980	88	355	Sat. 2 Oct. 2027
42	354	Tues. 29 Sept. 1981	89	354	Thur. 21 Sept. 2028
43	355	Sat. 18 Sept. 1982	90	383	Mon. 10 Sept. 2029
44	385	Thur. 8 Sept. 1983	91	355	Sat. 28 Sept. 2030
45	354	Thur. 27 Sept. 1984	92	354	Mon. 18 Sept. 2031
46	383	Mon. 16 Sept. 1985	93	383	Thur. 26 Sept. 2032
47	355	Sat. 4 Oct. 1986	94	355	Sat. 16 Sept. 2033
48	354	Thur. 24 Sept. 1987	95	385	Thur. 14 Sept. 2034
49	383	Mon. 12 Sept. 1988			
50	355	Sat. 30 Sept. 1989	5796	354	Thur. 4 Oct. 2035
51	354	Mon. 20 Sept. 1990	97	353	Mon. 22 Sept. 2036
52	385	Mon. 9 Sept. 1991	98	385	Thur. 10 Sept. 2037
53	353	Mon. 28 Sept. 1992	99	354	Thur. 30 Sept. 2038
54	355	Thur. 16 Sept. 1993	5800	355	Mon. 19 Sept. 2039
55	384	Tues. 6 Sept. 1994	01	383	Sat. 8 Sept. 2040
56	355	Sat. 25 Sept. 1995	02	354	Thur. 26 Sept. 2041
57	383	Mon. 14 Sept. 1996	03	385	Mon. 15 Sept. 2042
			04	353	Mon. 5 Oct. 2043
			05	355	Thur. 22 Sept. 2044
5758	354	Thur. 2 Oct. 1997	06	384	Tues. 12 Sept. 2045
59	355	Mon. 21 Sept. 1998	07	355	Mon. 1 Oct. 2046
60	385	Sat. 11 Sept. 1999	08	385	Tues. 8 Sept. 2047
61	353	Sat. 30 Sept. 2000	09	353	Sat. 8 Sept. 2048
62	354	Tues. 18 Sept. 2001	10	355	Mon. 27 Sept. 2049
63	385	Sat. 7 Sept. 2002	11	385	Sat. 17 Sept. 2050
64	355	Sat. 27 Sept. 2003	12	353	Thur. 7 Sept. 2051
65	383	Thur. 16 Sept. 2004	13	354	Tues. 24 Sept. 2052
66	354	Tues. 4 Oct. 2005	14	385	Thur. 13 Sept. 2053
67	355	Sat. 23 Sept. 2006			
68	383	Thur. 13 Sept. 2007	5815	355	Sat. 3 Oct. 2054
69	354	Tues. 30 Sept. 2008	16	354	Thur. 23 Sept. 2055
70	355	Sat. 19 Sept. 2009	17	383	Mon. 11 Sept. 2056
71	385	Thur. 8 Sept. 2010	18	355	Sat. 29 Sept. 2057
72	354	Thur. 29 Sept. 2011	19	354	Thur. 19 Sept. 2058
73	353	Thur. 17 Sept. 2012	20	383	Mon. 8 Sept. 2059
74	385	Thur. 5 Sept. 2013	21	385	Sat. 25 Sept. 2060
75	354	Thur. 25 Sept. 2014	22	355	Thur. 15 Sept. 2061
76	385	Mon. 14 Sept. 2015	23	384	Thur. 5 Oct. 2062
			24	355	Mon. 11 Sept. 2063
5777	353	Mon. 3 Oct. 2016	25	384	Thur. 11 Oct. 2064
78	354	Thur. 21 Sept. 2017	26	355	Mon. 20 Sept. 2066
79	385	Mon. 10 Sept. 2018	27	383	Mon. 10 Sept. 2067
80	355	Mon. 30 Sept. 2019	28	355	Thur. 27 Sept. 2068
81	353	Sat. 19 Sept. 2020	29	354	Mon. 16 Sept. 2069
82	384	Tues. 7 Sept. 2021	30	355	Thur. 6 Sept. 2070
83	355	Sat. 26 Sept. 2022	31	383	Sat. 24 Sept. 2071
84	383	Sat. 16 Sept. 2023	32	355	Thur. 13 Sept. 2072
85	355	Thur. 3 Oct. 2024	33	384	

Mahomedan Calendar.—The Mahomedan era, or era of the Hegira, used in Turkey, Persia, Arabia, &c., is dated from the first day of the month preceding the flight of Mahomet from Mecca to Medina, i.e. Thursday the 15th of July A.D. 622, and it commenced on the day following. The years of the Hegira are purely lunar, and always consist of twelve lunar months, commencing with the approximate new moon, without any intercalation to keep them to the same season with respect to the sun, so that they retrograde through all the seasons in about 32 $\frac{1}{2}$ years. They are also partitioned into cycles of 30 years, 19 of which are common years of 354 days each, and the other 11 are intercalary years having an additional day appended to the last month. The mean length of the year is therefore 354 $\frac{1}{3}$ days, or 354 days 8 hours 48 min., which divided by 12 gives 29 $\frac{1}{2}$ days, or 29 days 12 hours 44 min., as the time of a mean lunation, and this differs from the astronomical mean lunation by only 2-8 seconds. This small error will only amount to a day in about 2400 years.

To find if a year is intercalary or common, divide it by 30; the quotient will be the number of completed cycles and the remainder will be the year of the current cycle; if this last be one of the numbers 2, 5, 7, 10, 13, 16, 18, 21, 24, 26, 29, the year is intercalary and consists of 355 days; if it be any other number, the year is ordinary.

Or if Y denote the number of the Mahomedan year, and $R = \frac{(11Y+14)}{30}$, the year is intercalary when $R < 11$.

Also the number of intercalary years from the year 1 up to the year Y inclusive = $\left(\frac{11Y+14}{30}\right)_w$; and the same up to the year $Y-1 = \left(\frac{11Y+3}{30}\right)_w$.

To find the day of the week on which any year of the Hegira begins, we observe that the year 1 began on a Friday, and that after every common year of 354 days, or 50 weeks and 4 days, the day of the week must necessarily become postponed 4 days, besides the additional day of each intercalary year.

Hence if $w=1$ | 2 | 3 | 4 | 5 | 6 | 7 indicate Sun. | Mon. | Tues. | Wed. | Thur. | Frid. | Sat. the day of the week on which the year Y commences will be

$$w = 2 + 4\left(\frac{Y}{7}\right)_r + \left(\frac{11Y+3}{30}\right)_w \text{ (rejecting sevens).}$$

But, $30\left(\frac{11Y+3}{30}\right)_w + \left(\frac{11Y+3}{30}\right)_r = 11Y+3$

gives $120\left(\frac{11Y+3}{30}\right)_w = 12+44Y-4\left(\frac{11Y+3}{30}\right)_r$

or $\left(\frac{11Y+3}{30}\right)_w = 5+2Y+3\left(\frac{11Y+3}{30}\right)_r$ (rejecting sevens).

So that

$$w = 6\left(\frac{Y}{7}\right)_r + 3\left(\frac{11Y+3}{30}\right)_r \text{ (rejecting sevens),}$$

the values of which obviously circulate in a period of 7 times 30 or 210 years.

Let C denote the number of completed cycles, and y the year of the cycle; then $Y=30C+y$, and

$$w = 5\left(\frac{C}{7}\right)_r + 6\left(\frac{y}{7}\right)_r + 3\left(\frac{11Y+3}{30}\right)_r \text{ (rejecting sevens).}$$

From this formula the following table has been constructed:—

TABLE VIII.

Year of the Current Cycle (y).		Number of the Period of Seven Cycles = $\left(\frac{C}{7}\right)_r$						
		0	1	2	3	4	5	6
0	8	Mon.	Sat.	Thur.	Tues.	Sun.	Frid.	Wed.
1	9	Frid.	Wed.	Mon.	Sat.	Thur.	Tues.	Sun.
2	10	Tues.	Sun.	Frid.	Wed.	Mon.	Sat.	Thur.
3	11	Sun.	Frid.	Wed.	Mon.	Sat.	Thur.	Tues.
4	12	Thur.	Tues.	Sun.	Frid.	Wed.	Mon.	Sat.
5	13	Mon.	Sat.	Thur.	Tues.	Sun.	Frid.	Wed.
6	14	Sat.	Thur.	Tues.	Sun.	Frid.	Wed.	Mon.
7	15	Wed.	Mon.	Sat.	Thur.	Tues.	Sun.	Frid.
	16	Sun.	Frid.	Wed.	Mon.	Sat.	Thur.	Tues.
	17	25	26	27	28	29	30	
	*18	*19	*20	*21	*22	*23	*24	

To find from this table the day of the week on which any year of the Hegira commences, the rule to be observed will be as follows:—

Rule.—Divide the year of the Hegira by 30; the quotient is the number of cycles, and the remainder is the year of the current cycle. Next divide the number of cycles by 7, and the second remainder will be the Number of the Period, which being found at the top of the table, and the year of the cycle on the left hand, the required day of the week is immediately shown.

The intercalary years of the cycle are distinguished by an asterisk. For the computation of the Christian date, the ratio of a mean year of the Hegira to a solar year is

$$\frac{\text{Year of Hegira}}{\text{Mean solar year}} = \frac{354\frac{1}{2}}{365.2422} = 0.970224.$$

The year 1 began 16 July 622, Old Style, or 19 July 622, according to the New or Gregorian Style. Now the day of the year answering to the 19th of July is 200, which, in parts of the solar year, is 0.5476, and the number of years elapsed = $Y-1$. Therefore, as the intercalary days are distributed with considerable regularity in both calendars, the date of commencement of the year Y expressed in Gregorian years is

$$0.970224(Y-1) + 622.5476, \text{ or } 0.970224Y + 621.5774.$$

This formula gives the following rule for calculating the date of the commencement of any year of the Hegira, according to the Gregorian or New Style.

Rule.—Multiply 970224 by the year of the Hegira, cut off six decimals from the product, and add 621.5774. The sum will be the year of the Christian era, and the day of the year will be found by multiplying the decimal figures by 365.

The result may sometimes differ a day from the truth, as the intercalary days do not occur simultaneously; but as the day of the week can always be accurately obtained from the foregoing table, the result can be readily adjusted.

Example.—Required the date on which the year 1362 of the Hegira begins.

970224
1362
1940448
5821344
2910672
970224
1321.445088
621.5774
1943.0225
365
1125
1390
675
8.2125

Thus the date is the 8th day, or the 8th of January, of the year 1943. To find, as a test, the accurate day of the week, the proposed year of the Hegira, divided by 30, gives 45 cycles, and remainder 12, the year of the current cycle.

Also 45, divided by 7, leaves a remainder 3 for the number of the period.

Therefore, referring to 3 at the top of the table, and 12 on the left, the required day is Friday.

The tables, page 571, show that 8th January 1943 is a Friday, therefore the date is exact.

For any other date of the Mahomedan year it is only requisite to know the names of the consecutive months, and the number of days in each; these are—

Muharram	30	Shaaban	29
Saphar	29	Ramadin	29
Rabia I.	30	Shawall (Shawwal)	29
Rabia II.	29	Dulkaada (Dhu'l Qa'da)	30
Jomada I.	30	Dulheggia (Dhu'l Hijja)	29
Jomada II.	29	and in intercalary	
Rajab	30	years	30

The ninth month, Ramadan, is the month of Abstinence observed by the Moslems.

The Moslem calendar may evidently be carried on indefinitely by successive addition, observing only to allow for the additional day that occurs in the bissextile and intercalary years; but for any remote date the computation according to the preceding rules will be most efficient, and such computation may be usefully employed as a check on the accuracy of any considerable extension of the calendar by induction alone.

The following table, taken from Woolhouse's *Measures, Weights and Monies of all Nations*, shows the dates of commencement of Mahomedan years from 1845 up to 2047, or from the 43rd to the 49th cycle inclusive, which form the whole of the seventh period of seven cycles. Throughout the next period of seven cycles, and all other like periods, the days of the week will recur in exactly the same order. All the tables of this kind previously published, which extend beyond the year 1900 of the Christian era, are erroneous, not excepting the celebrated French work, *L'Art de vérifier les dates*, so justly regarded as the greatest authority in chronological matters. The errors have probably arisen from a continued excess of 10 in the discrimination of the intercalary years.

TABLE IX.—Mahomedan Years.

43rd Cycle.			
Year of Hegira.	Commencement (ist of Muharram).	Year of Hegira.	Commencement (ist of Muharram).
1261	Frid. 10 Jan. 1845	1273	Mon. 1 Sept. 1856
1262*	Tues. 30 Dec. 1845	1274	Sat. 28 Aug. 1857
1263	Sun. 20 Dec. 1846	1275	Wed. 11 Aug. 1858
1264	Thur. 9 Dec. 1847	1276*	Frid. 31 July 1859
1265*	Mon. 27 Nov. 1848	1277*	Sun. 20 July 1860
1266	Sat. 17 Nov. 1849	1278*	Tues. 9 July 1861
1267*	Wed. 6 Nov. 1850	1279	Sun. 29 June 1862
1268	Mon. 27 Oct. 1851	1280	Thur. 18 June 1863
1269	Frid. 15 Oct. 1852	1281*	Mon. 6 June 1864
1270*	Tues. 4 Oct. 1853	1282	Sat. 27 May 1865
1271	Sun. 24 Sept. 1854	1283	Wed. 16 May 1866
1272	Thur. 13 Sept. 1855	1284*	Sun. 5 May 1867

43rd Cycle—continued.		46th Cycle—continued	
Year of Hegira.	Commencement (1st of Muharram).	Year of Hegira.	Commencement (1st of Muharram).
1285	Frid. 24 April 1868	1362	8 Jan. 1943
1286	Tues. 13 April 1869	1363	Tues. 28 Dec. 1943
1287	Sun. 3 April 1870	1364	Sun. 17 Dec. 1944
1288	Thur. 23 Mar. 1871	1365	Thur. 6 Dec. 1945
1289	Mon. 11 Mar. 1872	1366	Mon. 25 Nov. 1946
1290	Sat. 1 Mar. 1873	1367	Sat. 15 Nov. 1947
		1368	Wed. 3 Nov. 1948
		1369	Mon. 24 Oct. 1949
		1370	Frid. 13 Oct. 1950
1291	Wed. 18 Feb. 1874	1371	Tues. 2 Oct. 1951
1292	Sun. 7 Feb. 1875	1372	Sun. 21 Sept. 1952
1293	Frid. 28 Jan. 1876	1373	Thur. 10 Sept. 1953
1294	Tues. 16 Jan. 1877	1374	Mon. 30 Aug. 1954
1295	Sat. 5 Jan. 1878	1375	Sat. 20 Aug. 1955
1296	Thur. 26 Dec. 1878	1376	Wed. 8 Aug. 1956
1297	Mon. 15 Dec. 1879	1377	Mon. 29 July 1957
1298	Sat. 4 Dec. 1880	1378	Frid. 18 July 1958
1299	Wed. 23 Nov. 1881	1379	Tues. 7 July 1959
1300	Sun. 12 Nov. 1882	1380	Sun. 26 June 1960
1301	Frid. 2 Nov. 1883		
1302	Tues. 21 Oct. 1884		
1303	Sat. 10 Oct. 1885		
1304	Thur. 30 Sept. 1886	1381	Thur. 15 June 1961
1305	Mon. 19 Sept. 1887	1382	Mon. 4 June 1962
1306	Frid. 7 Sept. 1888	1383	Sat. 25 May 1963
1307	Wed. 28 Aug. 1889	1384	Wed. 13 May 1964
1308	Sun. 17 Aug. 1890	1385	Sun. 2 May 1965
1309	Frid. 7 Aug. 1891	1386	Frid. 22 April 1966
1310	Tues. 26 July 1892	1387	Tues. 11 April 1967
1311	Sat. 15 July 1893	1388	Sun. 31 Mar. 1968
1312	Thur. 5 July 1894	1389	Thur. 20 Mar. 1969
1313	Mon. 24 June 1895	1390	Mon. 9 Mar. 1970
1314	Frid. 12 June 1896	1391	Sat. 27 Feb. 1971
1315	Wed. 2 June 1897	1392	Wed. 16 Feb. 1972
1316	Sun. 22 May 1898	1393	Sun. 4 Feb. 1973
1317	Frid. 12 May 1899	1394	Frid. 25 Jan. 1974
1318	Tues. 1 May 1900	1395	Tues. 14 Jan. 1975
1319	Sat. 20 April 1901	1396	Sat. 3 Jan. 1976
1320	Thur. 10 April 1902	1397	Thur. 23 Dec. 1976
		1398	Mon. 12 Dec. 1977
		1399	Sat. 2 Dec. 1978
		1400	Wed. 21 Nov. 1979
1321	Mon. 30 Mar. 1903	1401	Sun. 9 Nov. 1980
1322	Frid. 18 Mar. 1904	1402	Frid. 30 Oct. 1981
1323	Wed. 8 Mar. 1905	1403	Tues. 19 Oct. 1982
1324	Sun. 25 Feb. 1906	1404	Sat. 8 Oct. 1983
1325	Thur. 14 Feb. 1907	1405	Thur. 27 Sept. 1984
1326	Tues. 4 Feb. 1908	1406	Mon. 16 Sept. 1985
1327	Sat. 23 Jan. 1909	1407	Sat. 6 Sept. 1986
1328	Thur. 13 Jan. 1910	1408	Wed. 26 Aug. 1987
1329	Mon. 2 Jan. 1911	1409	Sun. 14 Aug. 1988
1330	Frid. 22 Dec. 1911	1410	Frid. 4 Aug. 1989
1331	Wed. 11 Dec. 1912		
1332	Sun. 30 Nov. 1913		
1333	Thur. 19 Nov. 1914		
1334	Tues. 9 Nov. 1915		
1335	Sat. 28 Oct. 1916	1411	Tues. 24 July 1990
1336	Wed. 17 Oct. 1917	1412	Sat. 13 July 1991
1337	Mon. 7 Oct. 1918	1413	Thur. 2 July 1992
1338	Frid. 26 Sept. 1919	1414	Mon. 21 June 1993
1339	Wed. 15 Sept. 1920	1415	Frid. 10 June 1994
1340	Sun. 4 Sept. 1921	1416	Wed. 31 May 1995
1341	Thur. 24 Aug. 1922	1417	Sun. 19 May 1996
1342	Tues. 14 Aug. 1923	1418	Frid. 9 May 1997
1343	Sat. 2 Aug. 1924	1419	Tues. 28 April 1998
1344	Wed. 22 July 1925	1420	Sat. 17 April 1999
1345	Mon. 12 July 1926	1421	Thur. 6 April 2000
1346	Frid. 1 July 1927	1422	Mon. 26 Mar. 2001
1347	Wed. 20 June 1928	1423	Frid. 15 Mar. 2002
1348	Sun. 9 June 1929	1424	Wed. 5 Mar. 2003
1349	Thur. 29 May 1930	1425	Sun. 22 Feb. 2004
1350	Tues. 19 May 1931	1426	Thur. 10 Feb. 2005
		1427	Sun. 31 Jan. 2006
		1428	Sat. 20 Jan. 2007
		1429	Thur. 10 Jan. 2008
1351	Sat. 7 May 1932	1430	Mon. 29 Dec. 2008
1352	Wed. 26 April 1933	1431	Sat. 18 Dec. 2009
1353	Mon. 16 April 1934	1432	Wed. 8 Dec. 2010
1354	Frid. 5 April 1935	1433	Sun. 27 Nov. 2011
1355	Tues. 24 Mar. 1936	1434	Thur. 15 Nov. 2012
1356	Sun. 14 Mar. 1937	1435	Tues. 5 Nov. 2013
1357	Thur. 3 Mar. 1938	1436	Sat. 25 Oct. 2014
1358	Mon. 21 Feb. 1939	1437	Thur. 15 Oct. 2015
1359	Sat. 10 Feb. 1940	1438	Mon. 3 Oct. 2016
1360	Wed. 29 Jan. 1941	1439	Frid. 22 Sept. 2017
1361	Mon. 19 Jan. 1942	1440	Wed. 12 Sept. 2018

49th Cycle.			
Year of Hegira.	Commencement (1st of Muharram).	Year of Hegira.	Commencement (1st of Muharram).
1441	Sun. 1 Sept. 2019	1456	Tues. 21 Mar. 2034
1442	Sun. 10 Aug. 2020	1457	Sun. 11 Mar. 2035
1443	Tues. 10 Aug. 2021	1458	Thur. 28 Feb. 2036
1444	Sat. 30 July 2022	1459	Tues. 17 Feb. 2037
1445	Wed. 19 July 2023	1460	Sat. 6 Feb. 2038
1446	Mon. 8 July 2024	1461	Wed. 26 Jan. 2039
1447	Frid. 27 June 2025	1462	Mon. 16 Jan. 2040
1448	Wed. 17 June 2026	1463	Frid. 4 Jan. 2041
1449	Sun. 6 June 2027	1464	Tues. 24 Dec. 2041
1450	Thur. 25 May 2028	1465	Sun. 14 Dec. 2042
1451	Tues. 15 May 2029	1466	Thur. 3 Dec. 2043
1452	Sat. 4 May 2030	1467	Tues. 22 Nov. 2044
1453	Wed. 23 April 2031	1468	Sat. 11 Nov. 2045
1454	Mon. 12 April 2032	1469	Wed. 31 Oct. 2046
1455	Frid. 1 April 2033	1470	Mon. 21 Oct. 2047

TABLE X.—Principal Days of the Hebrew Calendar.

Tisri	1, New Year, Feast of Trumpets.
"	3 ¹ , Fast of Guedaliah.
"	10, Fast of Expiation.
"	15, Feast of Tabernacles.
"	21, Last Day of the Festival.
"	22, Feast of the 8th Day.
"	23, Rejoicing of the Law.
Kislev	25, Dedication of the Temple.
Tebet	10, Fast, Siege of Jerusalem.
Adar	13 ¹ , Fast of Esther, } In embolismic
"	14, Purim, } years. Veadar.
Nisan	15, Passover.
Sivan	6, Pentecost.
Tamuz	17 ¹ , Fast, Taking of Jerusalem.
Ab	9 ¹ , Fast, Destruction of the Temple.

TABLE XI.—Principal Days of the Mahommedan Calendar.

Muharram	1, New Year.
"	10, Ashura.
Rabia I.	11, Birth of Mahomet.
Jomada I.	20, Taking of Constantinople.
Rajab	15, Day of Victory.
"	20, Exaltation of Mahomet.
Shaaban	15, Borak's Night.
Shawwal	1, 2, 3, Kutshuk Bairam.
Dulheggia	10, Qurban Bairam.

TABLE XII.—Epochs, Eras, and Periods.

Name.	Christian Date of Commencement.	Name	Christian Date of Commencement.
Grecian Munda-		Sidonian era	Oct. 110 B.C.
dane era	1 Sep. 5598 B.C.	Caesarean era	
Civil era of Constantinople	1 Sep. 5508 ..	of Antioch	1 Sep. 48 ..
Alexandrian era	29 Aug. 5502 ..	Julian year	1 Jan. 45 ..
Ecclesiastical era of Antioch	1 Sep. 5492 ..	Spanish era	1 Jan. 38 ..
Julian Period	1 Jan. 4713 ..	Actian era	1 Jan. 30 ..
Mundane era	Oct. 4008 ..	Augustan era	14 Feb. 27 ..
Jewish Munda-		Vulgar Christian era	
dane era	Oct. 3761 ..	Sidonian era	1 Jan. 1 A.D.
Era of Abraham	1 Oct. 2015 ..	of Diocletian	17 Sep. 284 ..
Era of the Olympiads	1 July 776 ..	Era of Ascension	
Roman era	24 April 753 ..	era	12 Nov. 295 ..
Era of Nabonassar	26 Feb. 747 ..	Era of the Armenians	7 July 552 ..
Metonic Cycle	15 July 432 ..	Mahommedan era of the Hegira	16 July 622 ..
Grecian or Syro-Macedonian era	1 Sep. 312 ..	Persian era of Yezdegird	16 June 632 ..
Tyrian era	19 Oct. 125 ..		

For the Revolutionary Calendar see FRENCH REVOLUTION *ad fin.*
 The principal works on the calendar are the following—Clavius, *Romani Calendarii a Gregorio XIII. P.M. restituti Explicatio* (Rome, 1603); *L'Art de sçavoir les dates*; Lalande, *Astronomie*, tome ii.; *Traité de la sphère et du calendrier*, par M. Revard (Paris, 1816); Delambre, *Traité de l'astronomie théorique et pratique*, tome iii.; *Histoire de l'astronomie moderne; Methodus technica brevis, perfacilis, ac perpetua construendi Calendarium Ecclesiasticum, Stylo tam novo quam vetere, pro cunctis Christianis Europae populis, &c.*, auctore Paulo Tittel (Göttingen, 1816); *Formole analitiche per*

¹ If Saturday, substitute Sunday immediately following.
² If Saturday, substitute Thursday immediately preceding.

CALENDER, (1) (Fr. *calendro*, from the Med. Lat. *Calendro*, a corruption of the Latinized form of the Gr. *κἀλῆρος*, a cylinder), a machine consisting of two or more rollers or cylinders in close contact with each other, and often heated, through which are passed cotton, calico and other fabrics, for the purpose of having a finished smooth surface given to them; the process flattens the fibres, removes inequalities, and also gives a glaze to the surface. It is similarly employed in paper manufacture (q.v.). (2) (From the Arabic *qalandar*), an order of dervishes, who separated from the Baktashite order in the 14th century; they were vowed to perpetual travelling. Other forms of the name by which they are known are Kalenderis, Kalenderites, and Qalandarites (see *DERVISH*).

CALENUS, QUINTUS FUFIVS, Roman general. As tribune of the people in 61 B.C., he was chiefly instrumental in securing the acquittal of the notorious Publius Clodius when charged with having profaned the mysteries of Bona Dea (Cicero, *Ad. Au.* i. 16). In 59 Calenus was praetor, and brought forward a law that the senators, knights, and tribuni aerarii, who composed the judices, should vote separately, so that it might be known how they gave their votes (Dio Cassius xxxviii. 8). He fought in Gaul (51) and Spain (49) under Caesar, who, after he had crossed over to Greece (48), sent Calenus from Epirus to bring over the rest of the troops from Italy. On the passage to Italy, most of the ships were captured by Bibulus and Calenus himself escaped with difficulty. In 47 he was raised to the consulship through the influence of Caesar. After the death of the dictator, he joined Antony, whose legions he afterwards commanded in the north of Italy. He died in 41, while stationed with his army at the foot of the Alps, just as he was on the point of marching against Octavianus.

Caesar, *B.G.* viii. 39; *B.C.* i. 87, iii. 26; *Cic. Philippicas*, viii. 4.

CALEPINO, AMBROGIO (1435-1511), Italian lexicographer, born at Bergamo in 1435, was descended of an old family of Calepio, whence he took his name. Becoming an Augustinian monk, he devoted his whole life to the composition of a polyglott dictionary, first printed at Reggio in 1502. This gigantic work was afterwards augmented by Passerat and others. The most complete edition, published at Basel in 1590, comprises no fewer than eleven languages. The best edition is that published at Padua in seven languages in 1772. Calepino died blind in 1511.

CALES (mod. *Calvi*), an ancient city of Campania, belonging originally to the Aurunci, on the Via Latina, 8 m. N.N.W. of Casilinum. It was taken by the Romans in 335 B.C., and, a colony with Latin rights of 2500 citizens having been established there, it was for a long time the centre of the Roman dominion in Campania, and the seat of the quaestor for southern Italy even down to the days of Tacitus.¹ It was an important base in the war against Hannibal, and at last refused further contributions for the war. Before 184 more settlers were sent there. After the Social War it became a *municipium*. The fertility of its territory and its manufacture of black glazed pottery, which was even exported to Etruria, made it prosperous. At the end of the 3rd century it appears as a colony, and in the 5th century it became an episcopal see, which (jointly with Teano since 1818) it still is, though it is now a mere village. The cathedral, of the 12th century, has a carved portal and three apses decorated with small arches and pilasters, and contains a fine pulpit and episcopal throne in marble mosaic. Near it are two grottos

¹ To the period after 335 belong numerous silver and bronze coins with the legend *Caleno*.

quity, especially of an amphitheatre and theatre, of a supposed temple, and other edifices. A number of tombs belonging to the Roman necropolis were discovered in 1883.

See C. Hülsen in Pauly-Wissowa, *Realencyclopädie*, iii. 1351 (T. As.) (Stuttgart, 1899).

CALF. (1) (A word common in various forms to Teutonic languages, cf. German *Kalb*, and Dutch *kalf*), the young of the family of *Bovidae*, and particularly of the domestic cow, also of the elephant, and of marine mammals, as the whale and seal. The word is applied to a small island close to a larger one, like a calf close to its mother's side, as in the "Calf of Man," and to a mass of ice detached from an iceberg. (2) (Of unknown origin, possibly connected with the Celtic *calpa*, a leg), the fleshy hinder part of the leg, between the knee and the ankle.

CALF, THE GOLDEN, a molten image made by the Israelites when Moses had ascended the Mount of Yahweh to receive the Law (Ex. xxxii.). Alarmed at his lengthy absence the people clamoured for "gods" to lead them, and at the instigation of Aaron, they brought their jewelry and made the calf out of it. This was celebrated by a sacred festival, and it was only through the intervention of Moses that the people were saved from the wrath of Yahweh (cp. Deut. ix. 19 sqq.). Nevertheless 3000 of them fell at the hands of the Levites who, in answer to the summons of Moses, declared themselves on the side of Yahweh. The origin of this particular form of worship can scarcely be sought in Egypt; the Apis which was worshipped there was a live bull, and image-worship was common among the Canaanites in connexion with the cult of Baal and Astarte (q.v.). In early Israel it was considered natural to worship Yahweh by means of images (cp. the story of Gideon, Judg. viii. 24 sqq.), and even to Moses himself was attributed the bronze-serpent whose cult at Jerusalem was destroyed in the time of Hezekiah (2 Kings xviii. 4, Num. xxi. 4-9). The condemnation which later writers, particularly those imbued with the spirit of the Deuteronomic reformation, pass upon all image-worship, is in harmony with the judgment upon Jeroboam for his innovations at Bethel and Dan (1 Kings xii. 28 sqq., xvi. 26, &c.). But neither Elijah nor Elisha raised a voice against the cult; then, as later, in the time of Amos, it was nominally Yahweh-worship, and Hosea is the first to regard it as the fundamental cause of Israel's misery. See further, W. R. Smith, *Prophets of Israel*, pp. 175 sqq.; Kennedy, *Hastings' Dict. Bib.* i. 342; and HEBREW RELIGION (S. A. C.)

CALGARY, the oldest city in the province of Alberta. Pop. (1901) 4091; (1907) 21,112. It is situated in 114° 15' W., and 51° 44' N., on the Bow river, which flows with its crystal waters from the pass in the Rocky Mountains, by which the main line of the Canadian Pacific railway crosses the Rocky Mountains. The pass proper—Kananaskis—penetrates the mountains beginning 40 m. west of Calgary, and the well-known watering-place, Banff, lies 81 m. west of it, in the Canadian national park. The streets are wide and laid out on a rectangular system. The buildings are largely of stone, the building stone used being the brown Laramie sandstone found in the valley of the Bow river in the neighbourhood of the city. Calgary is an important point on the Canadian Pacific railway, which has a general superintendent resident here. It is an important centre of wholesale dealers, and also of industrial establishments. Calgary is near the site of Fort La Jonquière founded by the French in 1752. Old Bow fort was a trading post for many years though now in ruins. The present city was created by the building of the Canadian Pacific railway about 1883.

END OF FOURTH VOLUME

PRINTED BY R. E. DONNELLEY & SONS COMPANY, CHICAGO.
BONDERS, T. E. J. F. TAPLEY COMPANY, NEW YORK,
AND R. E. DONNELLEY & SONS COMPANY, CHICAGO.

7214 011



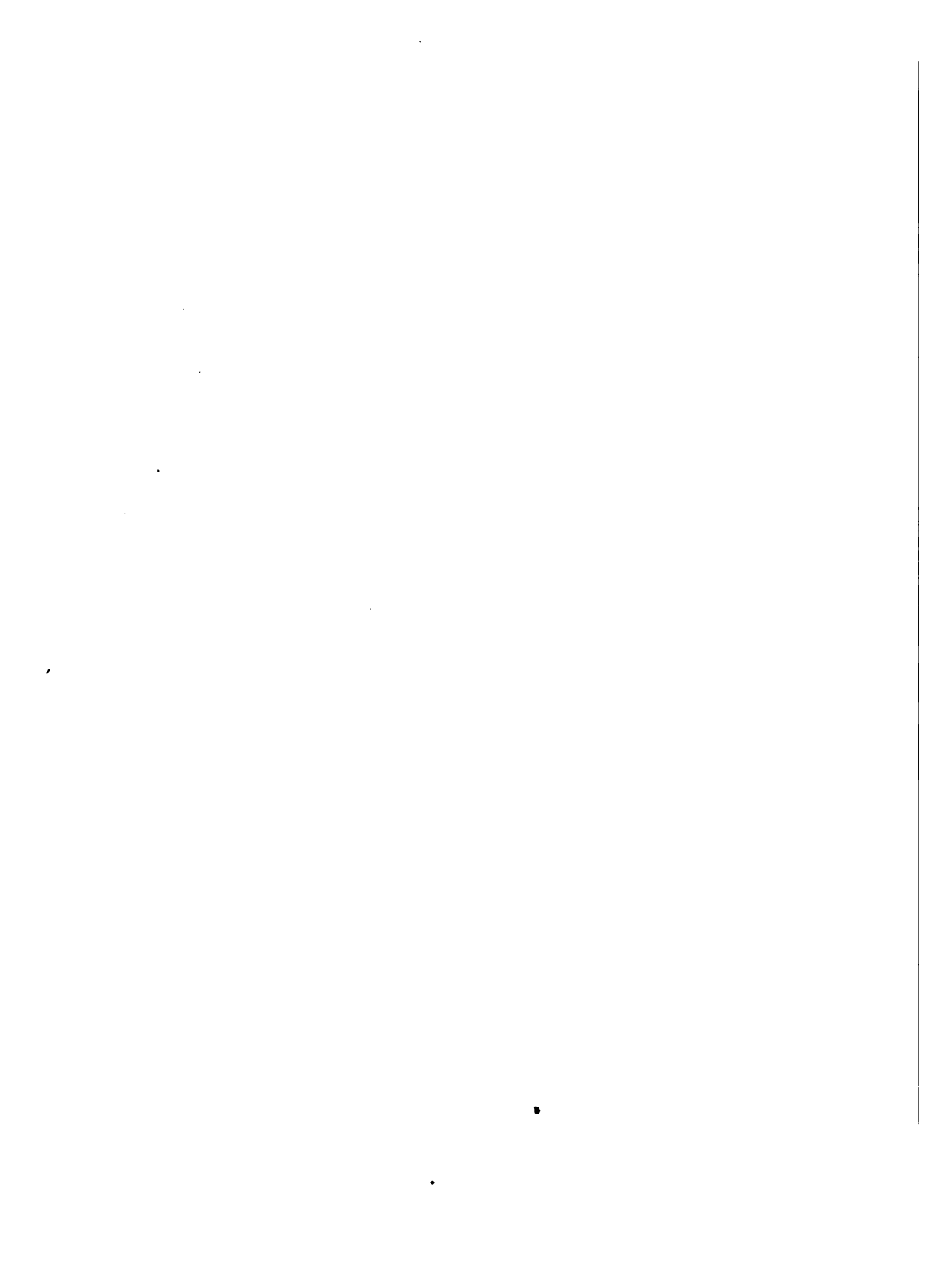

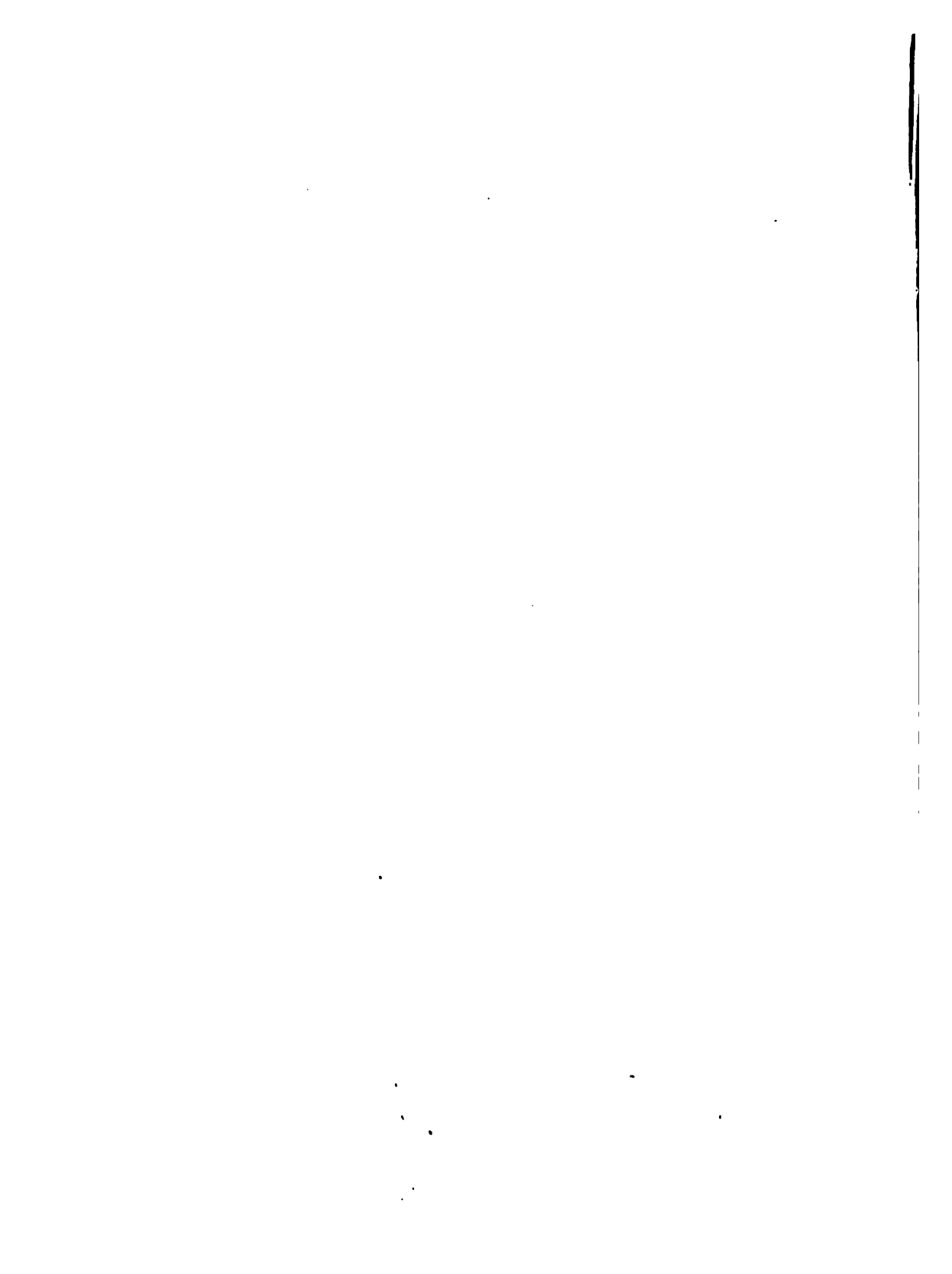

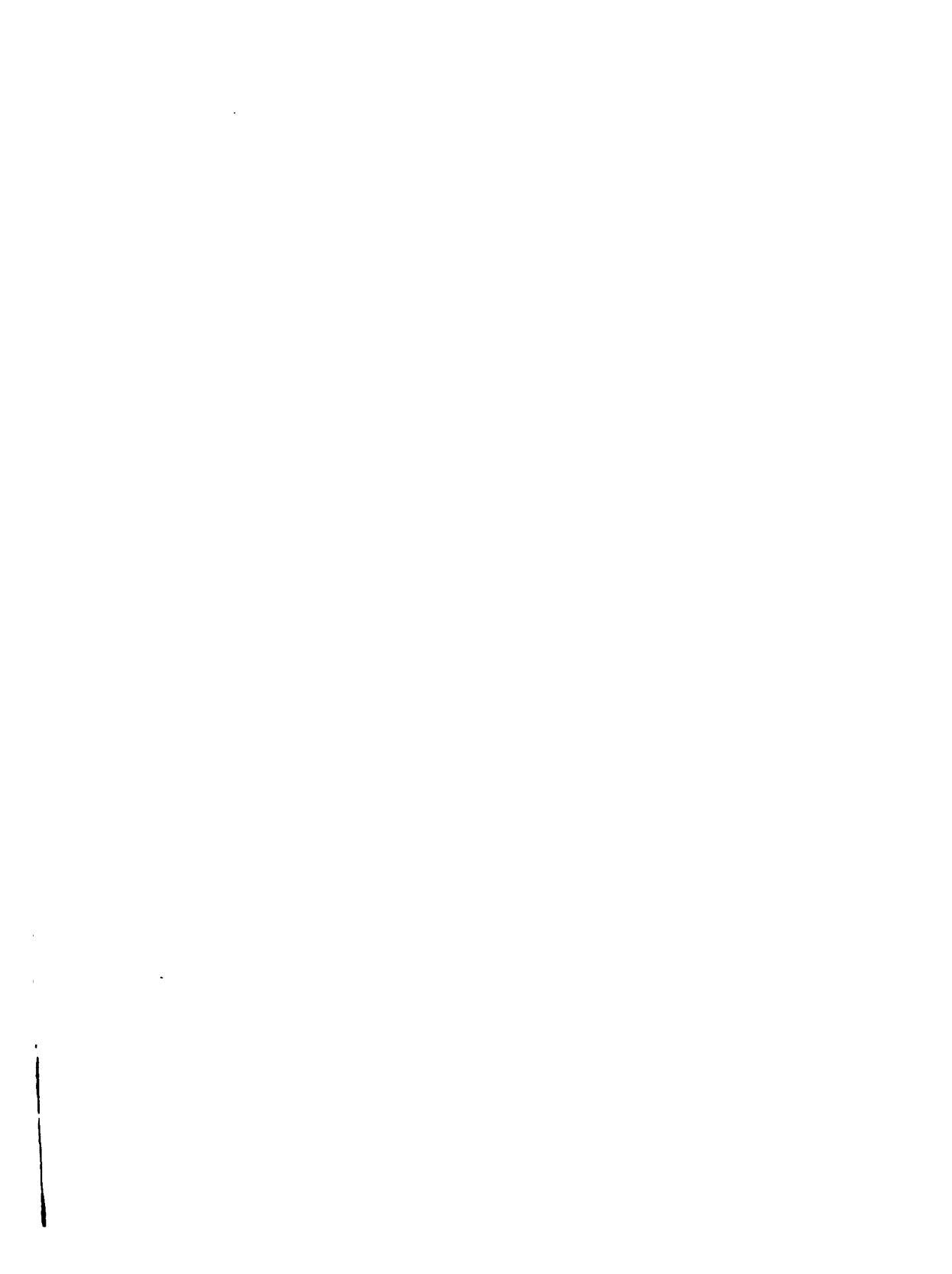



3 2044 038 446 894

